

Model

CY-RC50KN CY-RC50KW

Operating Instructions

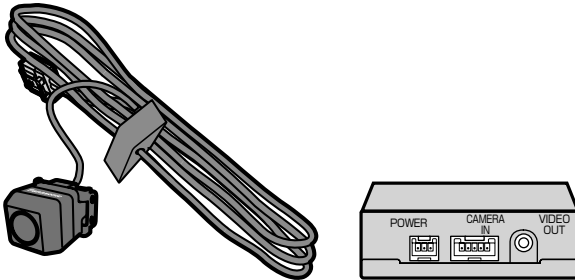

- Please read these instructions carefully before using this product and keep this manual for future reference.

Safety information

- ❑ Read the operating instructions for the unit and all other components of your car navigation system carefully before using the system. They contain instructions about how to use the system in a safe and effective manner. Panasonic assumes no responsibility for any problems resulting from failure to observe the instructions given in this manual.

- ❑ This manual uses pictographs to show you how to use the product safely and to alert you to potential dangers resulting from improper connections and operations. The meanings of the pictographs are explained below. It is important that you fully understand the meanings of the pictographs in order to use this manual and the system properly.



Warning

This pictograph alerts you to the presence of important operating instructions. Failure to heed the instructions may result in severe injury or death.



Caution

This pictograph alerts you to the presence of important operating instructions. Failure to heed the instructions may result in injury or material damage.

Warning

Observe the following warnings when using this unit.

- ❑ **Always reverse slowly, checking for safety with your own eyes.**

The camera image is perceived differently from the actual distance. The field of view which can be displayed is also limited. Reverse slowly, checking safety by eye, rather than relying on the screen. Reversing without checking safety can cause collisions with people and objects.

- ❑ **Always use a fuse of the specified capacity. Ask a specialist engineer to replace the fuse.**
If the fuse used exceeds the specified capacity, it can cause fire, smoke, ignition and other breakdowns. Consult your dealer or service centre to request fuse replacement or repair.

- ❑ **Do not continue using the system when it has broken down or malfunctioned.**

If there is a breakdown (no image, no sound, etc.) or malfunctions (a foreign object inside, water on the components, smoke comes out, abnormal noise or odor, etc.), immediately stop using it, then consult your dealer or service centre. Continued use in that state could cause fire, electric shock or accident.

Caution

Observe the following cautions when using this unit.

- ❑ **Do not use this system for any purpose other than mounting on a road vehicle.**

Non-vehicular use (such as use outdoors or on a pleasure boat) could cause smoking generation, ignition, electric shock, injury and breakdown.

- ❑ **Do not use an automatic car-washing machine to wash the vehicle.**

Exposure to water from a high pressure hose or impact from a brush may cause the system to fall resulting in accident or injury. Water entering inside the camera can result in a fire, electric shock or breakdown.

Observe the following cautions when installing.

- ❑ **Do not damage cords.**

Do not damage, pull, bend, twist or modify cords, place heavy objects on them, or place them near hot equipment or in contact with hot parts of the vehicle. Breaking or shorting cords could cause fire, electric shock, or accidents.

- Route cords so that they cannot be pinched by the body of the vehicle, screws or moving parts (seat rails etc.).
- Do not press cords with the point of a screwdriver or similar implement.

- ❑ **Do not damage the rear view camera cord.**
Water and moisture can move along the cord from the damaged area and enter the camera, causing fire, electric shock and breakdown.

- ❑ **Route the rear view camera cord inside the vehicle, so that water cannot penetrate them.**

If water enters the vehicle during rain or car washing, it could cause fire or electric shock.

- ❑ **Order wiring, mounting and dismounting work from a specialist engineer.**

Wiring, mounting and dismounting work requires specialist skills and experience. For safety, ask your dealer to perform such work. In the case that this system is installed in a vehicle with a drive computer or a navigation system, improper removal of the battery may result in erasure of system's memory.

- ❑ **Only use the accessories provided and the parts specified.**

Use of non-specified parts can cause internal damage to the equipment, and insecure mounting could allow it to fall off, causing accident, breakdown and fire.

- ❑ **Mount the equipment securely, so that it cannot come off and fall.**

Wipe the mounting area clean of dirt, wax etc., then fasten the camera securely in place. Re-affixing adhesive parts or use of general-purpose double-sided tape could cause weak bonding that would allow the equipment to drop off while the vehicle is in motion, causing accident or injury. Check the state of bonding or mounting (loose screws etc.) occasionally.

Notes on use

Carefully read the instruction manuals for the connected devices (Car Monitor etc.).

Before reversing, always check behind you by eye.

- This product uses mirrored display (which mimics the orientation of the rear-view and side mirrors), and is for checking the view behind the vehicle.
- It is intended to augment the driver's field of vision behind the vehicle. It is not able to view all hazards and obstacles.
- It uses a wide-angle lens, which makes close areas appear wider and further areas narrower. This may cause perceived distances to differ from actual distances.

This product can be connected to a monitor etc. with RCA-type video inputs. When the shift lever is in reverse (R), the linkage function (camera interrupt display) and scaled display correspond to the connected display device, so we are unable to guarantee normal operation.

Check the mounting of the system components regularly

- Check that there are no loose screws, and that the camera bracket is not detached.
- Check that the rubber water seals where the cord enters the vehicle are parallel to the rubber gasket where they are in contact.

Do not display a direct view of the sun for long periods

- A burned image could remain on the screen.

Do not use a cellular telephone or wireless equipment close to the system

- Screen noise and malfunctions could result.
You are advised to use cellular telephone or wireless equipment away from this system.

Disclaimers

- Any repairs to breakdowns or damage caused by fire, earthquake, third-party action, other accident, actions of the user, whether by accident or design, incorrect operation or usage under other abnormal conditions will, as a rule, require payment of repair fees.
- Not guaranteed when equipped in a commercial-use vehicle (buses, trucks, taxis, goods vehicles etc.).

Specifications

Output image	Wide-angle mirror image (for checking the rear view)
Video format	NTSC composite
Power supply	DC 12 V, negative ground
Power consumption	1.6 W (approx. 135 mA)
Image sensor	Colour CCD, solid-state, 6.35 mm
Effective pixels	Approx. 250 000 pixels
Lens	Wide angle, focal length $f=1.94$ mm, F 1:2.8
Angular field of view	Horizontal: 134°, Vertical: 103°
S/N ratio	46 dB or more (at recommended light level)
Horizontal resolution	330 TV lines (at centre)
Brightness range	Approx. 1.5 lx – 100 000 lx
Image output	1 Vp-p (75 Ω)
Dimensions (W x H x D)	
• Rear view camera	23 mm x 21 mm x 20 mm (cord length 4 m, not including projections on the rear)
• Rear view camera control unit	76 mm x 27 mm x 40 mm
Weight	
• Rear view camera	Approx. 90 g (including cord)
• Rear view camera control unit	Approx. 110 g

Note:

- Specifications and the design are subject to modification without notice due to improvements in technology.
- Some figures and illustrations on this manual may be different from your product.

Sales and Support Information For UK and Ireland customers only.

Customer Care Centre

- For customers within the UK:
0844 844 3852
- For customers within the Republic of Ireland: 01 289 8333
- Visit our website for product information
- E-mail: customer.care@panasonic.co.uk

Direct Sales at Panasonic UK

- Order accessories and consumable items for your product with ease and confidence by phoning our Customer Care Centre Monday - Thursday 9:00am - 5:30pm, Friday 9:30am - 5:30pm. (Excluding public holidays).
- Or go on line through our Internet Accessory ordering application at www.panasonic.co.uk.
- Most major credit and debit cards accepted.
- All enquiries, transactions and distribution facilities are provided directly by Panasonic UK Ltd.
- It couldn't be simpler!
- Also available through our Internet is direct shopping for a wide range of finished products, so take a browse on our website for further details.

Matsushita Electric Industrial Co., Ltd.

Web Site: <http://panasonic.net>

YEFM285998 F0207-1047 Printed in Japan

Download from [Www.Somanuals.com](http://www.Somanuals.com). All Manuals Search And Download.

Warning

Observe the following warnings when installing.

Use on a DC 12 V ⊖ grounded vehicle.

This system can only be used on a DC 12 V ⊖ grounded vehicle. It cannot be used in DC 24 V and other battery system (large trucks, diesel vehicles for use in cold regions, etc.). Use on such vehicles would cause fire and breakdown.

Disconnect the battery ⊖ terminal during performing any wiring or installation work.

Wiring or installation work with the battery ⊖ terminal connected could cause electric shock and injury from shorting.

This system should be installed in a way so that operation of vehicle protective devices such as an air bag is not hindered.

Should this system be installed in a vehicle with a protective device such as an air bag or an anti-theft system, check with the car manufacturer about operational cautions prior to attempting installation and perform the installation in a safe and proper manner. Improper removal of the battery may result in a malfunction of a device or possibly death.

Never use the security parts of the vehicle for mounting or grounding the system.

Use of the bolts or nuts of security parts (steering, brake systems, fuel tank etc.) can cause brake failure, fire, or other accidents.

Check positions of pipes, tanks, electric wirings in the vehicle when mounting.

Never interfere with or touch pipes, tanks, or electric wirings when opening holes in the vehicle body for installation. Apply rust prevention and waterproofing treatments to the processed area, as rust or water leakage may result in a fire, an electric shock, or other accident.

Route cords so that they do not get in the way of occupants driving or getting into or out of the vehicle.

Route cords so that they do not tangle with the steering wheel, shift lever, brake pedals, feet etc., and bundle and fasten them appropriately. Poorly arranged cords can cause accident and injury.

Wire and mount the system as instructed.

Fire or accident could result if wiring and mounting do not properly follow the operating instructions.

Do not attempt to disassemble, repair or modify the system.

Never attempt to disassemble, repair or modify the system, or to remove cord insulation to take power supply from other devices. Fire, electric shock or accident could result.

After mounting and wiring the system, check that all vehicle systems function normally.

If any vehicle equipment (brakes, lights, horn, hazard and indicator lights etc.) does not work normally, fire, electric shock or accident could result.

Keep screws and other small components away from small children.

There is a risk that they could swallow small components. Seek immediate medical attention if that happens.

Information on Disposal for Users of Waste Electrical & Electronic Equipment (private households)



This symbol on the products and/or accompanying documents means that used electrical and electronic products should not be mixed with general household waste.

For proper treatment, recovery and recycling, please take these products to designated collection points, where they will be accepted on a free of charge basis. Alternatively, in some countries you may be able to return your products to your local retailer upon the purchase of an equivalent new product.

Disposing of this product correctly will help to save valuable resources and prevent any potential negative effects on human health and the environment which could otherwise arise from inappropriate waste handling. Please contact your local authority for further details of your nearest designated collection point.

Penalties may be applicable for incorrect disposal of this waste, in accordance with national legislation.

For business users in the European Union

If you wish to discard electrical and electronic equipment, please contact your dealer or supplier for further information.

Information on Disposal in other Countries outside the European Union

This symbol is only valid in the European Union.

If you wish to discard this product, please contact your local authorities or dealer and ask for the correct method of disposal.

Troubleshooting

If you suspect something wrong

Check and take steps as described below.

If the described suggestions do not solve the problem, it is recommended to take the unit to your nearest authorized Panasonic Service Centre. The product should be serviced only by qualified personnel. Please refer checking and repair to professionals.

Panasonic shall not be liable for any accidents arising out of neglect of checking the unit or your own repair after your checking.

Never take measures especially those other than indicated by *italic* letters in “Possible solution” described below because those are too dangerous for users to handle themselves.

Warning

- Do not use the unit in an irregular condition, for example, without sound, or with smoke or a foul smell, which can cause ignition or electric shock. Immediately stop using the unit and consult your dealer.
- Never try to repair the unit by yourself because it is dangerous to do so.

Problem	Possible cause ⇒ Possible solution
No image from the camera.	<ul style="list-style-type: none">• Incorrect settings or connection. ⇒ Check settings and cord connections.• The fuse for the system, or for equipment connected to it, has blown. ⇒ Consult a Panasonic Service Centre.
Image is unclear.	<ul style="list-style-type: none">• Is there dust or dirt on the camera? ⇒ Wipe the lens clean.
White lines (vertical lines of light) on the screen.	<ul style="list-style-type: none">• If the camera is viewing the sun directly, or a strong light (reflection from a fender, a headlight beam etc.) shines into it, bright vertical lines can appear above and below the light source. (Smearing) ⇒ This is not a breakdown.
Noise on the screen.	<ul style="list-style-type: none">• When the area viewed by the camera is lit by fluorescent light or a similar light source, noise can appear on the screen. (Flickering) ⇒ This is not a breakdown.
Screen display is hard to see.	<ul style="list-style-type: none">• The screen display may become hard to see when it shows a dark area, or an image that is bright in a small area, or when the camera is hot. ⇒ This is not a breakdown.

Product servicing

If the suggestions in the charts do not solve the problem, we recommend that you take it to your nearest authorized Panasonic Service Centre. The product should be serviced only by a qualified technician.

Replacing the Fuse

Use fuses of the same specified rating (**1 A**). Using different substitutes or fuses with higher rating, or connecting the product directly without a fuse, could cause fire or damage to this unit.

If the replacement of the fuse fails, consult your nearest authorized Panasonic Service Centre for service.

Maintenance

Caution on cleaning

- Do not wipe with volatile chemicals, such as alcohol, benzene, thinners and gasoline. These can cause deformation, deterioration and breakage.
- Do not wipe with cleaners that contain abrasive particles, as they leave scratches.
- If the lens is dirty, wipe it gently with a soft, moist cloth. Wiping strongly with a dry cloth will damage the lens.

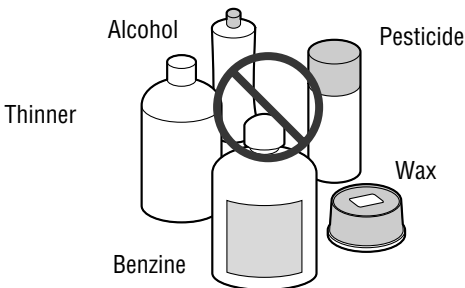

Check the contents

Consult your dealer if any item is missing.

• Figures in () are quantities.

**Rear view camera
(with Rubber water seal)**

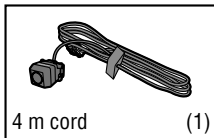

**Rear view camera
control unit**

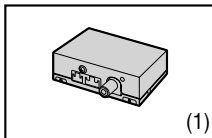

Camera bracket

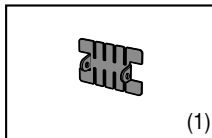

Bolts with washer



Hexagon wrench



Power cord

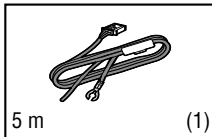

RCA cord

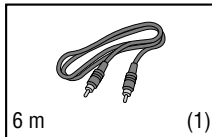

Clip connector

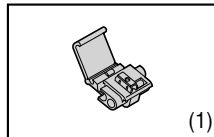

Cord clamp



Cord rail

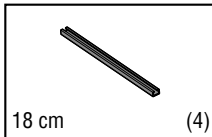

Tie band

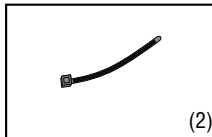

Velcro tape

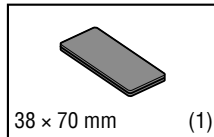

Double-sided tape

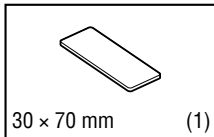

■ Accessories

**Operating instructions
(this manual)**

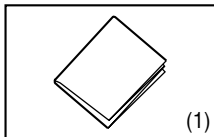

**PAN EUROPEAN
GUARANTEE
(Warranty Card)**

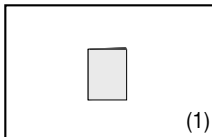

(CY-RC50KN only)

Cord routing (example)

- Route the camera cord so that it does not allow rainwater etc. to penetrate.
- Allow enough slack in the cord so that it is not pulled when the door is opened and closed.

Hatchback or Van type

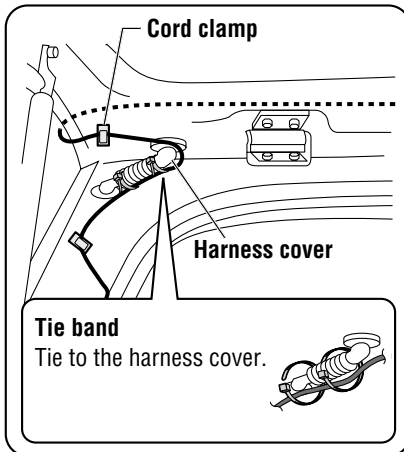

○ Route the cord above the back door (outside).

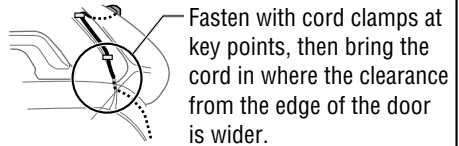

✗ Do not route the cord under the back door (inside).

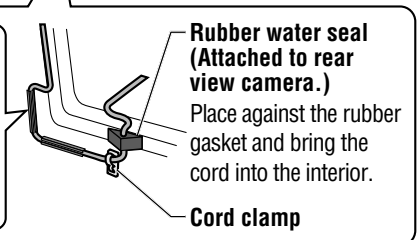
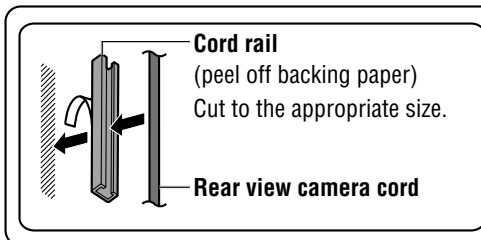
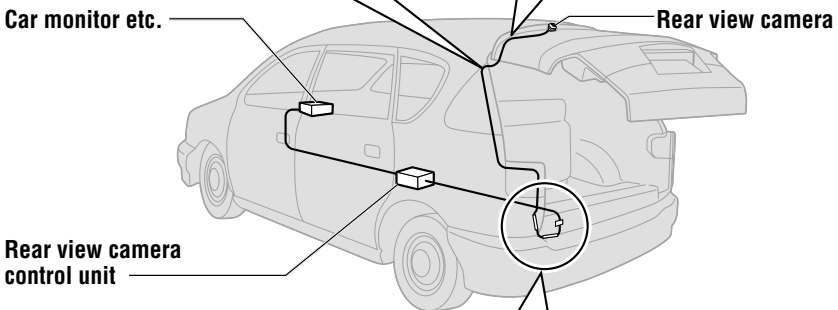
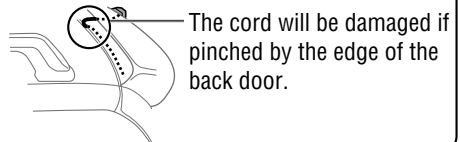

Saloon type

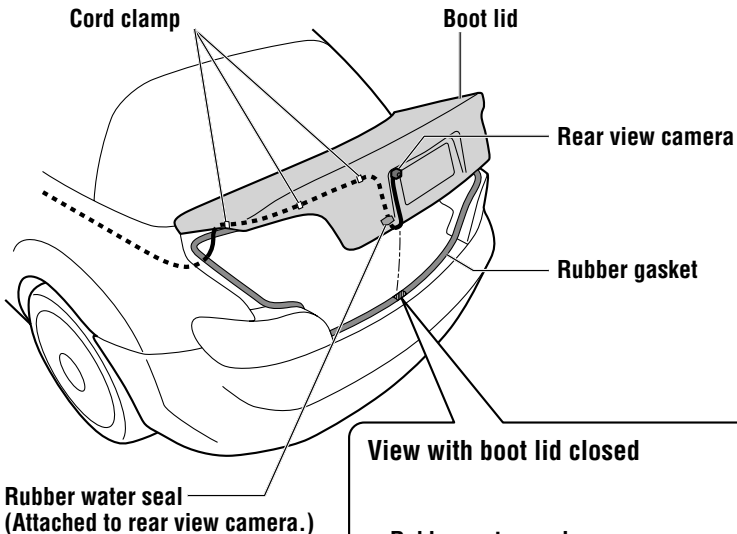

Rubber water seal
(Attached to rear view camera.)

View with boot lid closed

Rubber water seal
(Attached to rear view camera.)

Rubber gasket

Attach the rubber water seal so that it is parallel with the rubber gasket when the boot is closed.

Note:

- Open and close the back door or boot lid slowly to check that the camera cord is not pinched or abraded by the door/lid. Moisture or water can enter through the damaged area of the cord and penetrate to the interior of the camera, causing breakdowns.
- Route the camera cord as far as possible from the antenna cord.
(It could cause noise in TV and radio signals.)
- If AM radio broadcasts are affected by noise, move the camera cord further from the vehicle wiring harness.

Mounting procedure

Rear view camera

Before mounting

Wipe away all oil and dirt etc. from the mounting surface.

Make connections and placement tentatively at first, to check positions. Repeated affixing weakens the adhesive.

- The screw holes to use, and the possible angle adjustment, vary according to the mounting position. Adjust the angle and check that the required field of view is visible. (It is not possible to re-affix components.)
- Mount the camera so that it does not contact the vehicle body or rear wipers.

■ For secure mounting

- Do not work outdoors in rainy weather.
- When the air temperature is low, use the vehicle's interior heater or defogger, or a dryer, to warm the bonding area.
- Use a dryer etc. to thoroughly remove all moisture. Dirt and moisture on the bonding surface reduce bond strength and could cause the camera to fall off.
- After mounting the camera, do not expose it to rain or other water, pull it or subject it to strong forces for 24 hours.

Note:

- The camera cannot be affixed to painted or glass surfaces which have been treated with fluoroplastics (treatments which shed water droplets, mud etc.), or to re-painted surfaces.

Rear view camera control unit

Before mounting

Wipe away all oil and dirt etc. from the mounting surface.

Mounting on carpet etc.

Rear view camera control unit

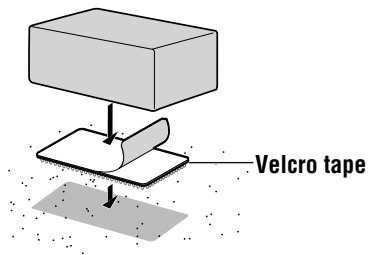

Mounting on hard surfaces (floor etc.)

Rear view camera control unit

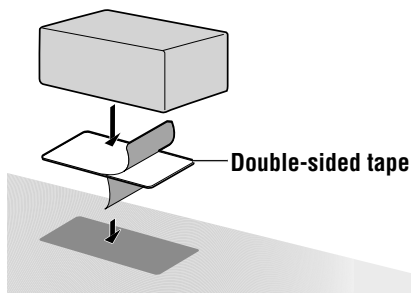

Note:

Do not mount the control unit in the following locations, which could cause breakdowns.

- Places exposed to water
- Places which could be stepped on
- Dusty places
- Close to heater ducts or heat-emitting objects
- Places exposed to direct sunlight
- Under the carpet, or any other position that gets hot

Wiring procedure

Make connections and set and operate acco

When connected to a Panasonic Car Monitor etc., the image from the camera is automatically displayed in the screen when the shift lever is moved to reverse (R).

- For some combinations of vehicle type and device, additional cords (option) may be required, or connection may not be possible.
Consult your dealer or service centre.
- For connection with products from other companies, consult the manufacturer of each device.

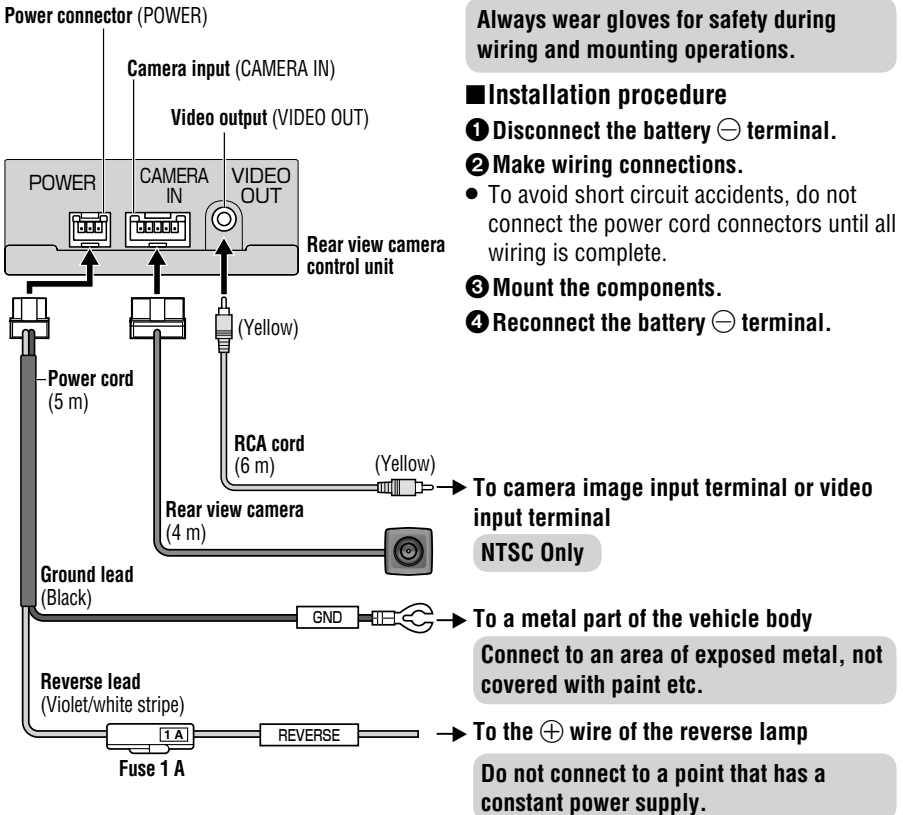

Note:

- Insert connectors securely. Also, take care to avoid pulling on the cords.
- Do not extend the RCA cord or rear view camera cord, as video noise and breakdowns could result.
- Only use clip connectors in the specified places.

ording to the installation instructions for the connected devices.

Connection to a Car Monitor (example)

Connect to the \oplus wire of the reverse lamp (lamp with a transparent lens, which lights for reversing) which lights when the vehicle shift lever is moved to reverse (R).

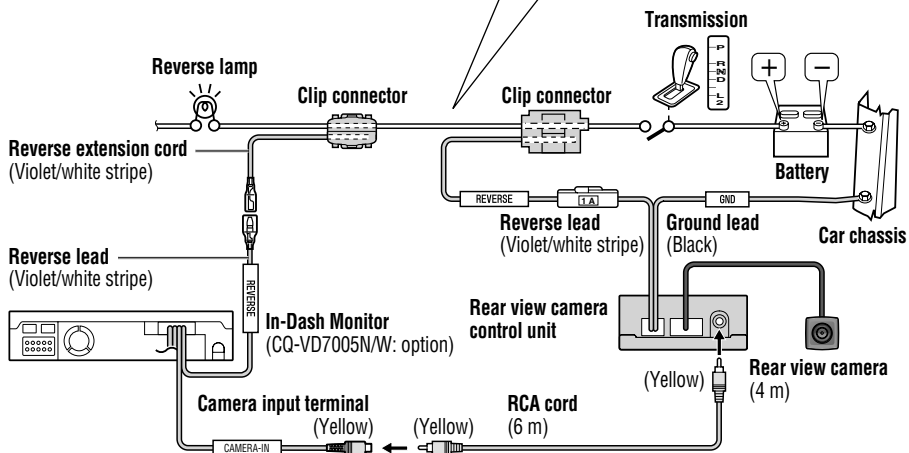

Connection to a Car Monitor from another company (example)

Connect to the \oplus wire of the reverse lamp (lamp with a transparent lens, which lights for reversing) which lights when the vehicle shift lever is moved to reverse (R).

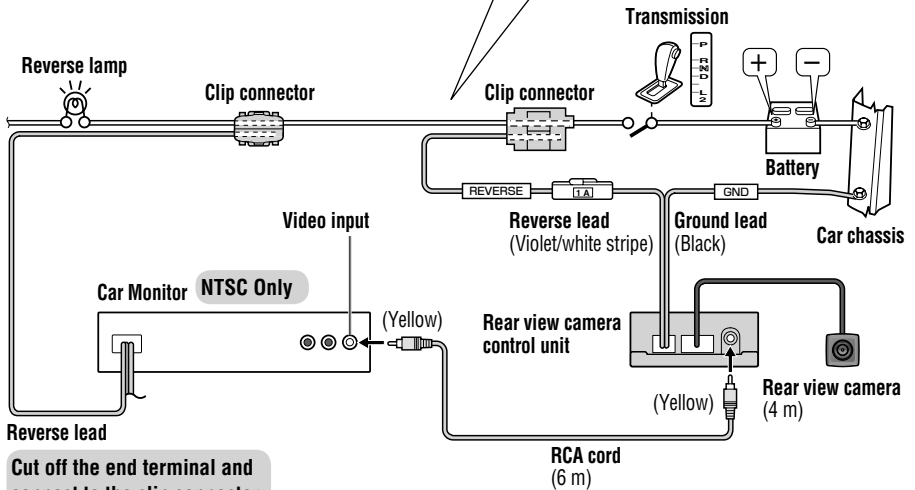

How to disconnect locked cords

- Pulling strongly will break the cord.
- Check that the lock is released before disconnecting.

Power cord

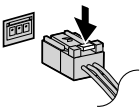

Rear view camera cord

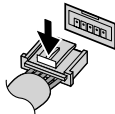

How to attach a clip connector

- 1 Insert the cord into the clip connector.

Vehicle-side wiring cord
Reverse lead of this unit

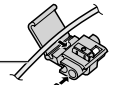

- 2 Press the element into place.



- 3 Close the cover.



1 Attach the camera bracket to a glass or painted surface on the vehicle body.

① Form the camera bracket to fit the form of the mounting surface. (Do not remove the backing paper)

② Peel the backing paper and press the camera bracket firmly onto the surface.



- Do not touch the bonding surface with your hands.
- Do not re-attach the adhesive.

2 Mount the camera body onto the camera bracket.

Bolt with washer

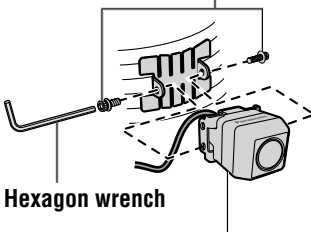

Rear view camera
Side with logo
uppermost

Side view

The screw holes to use, and the possible angle adjustment, vary according to the mounting position.

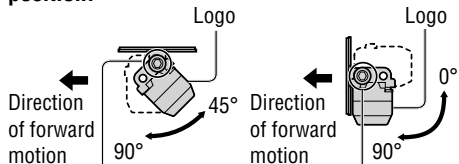

Mount on the screw holes on the side opposite the direction of forward motion.

Mount on the screw holes below the camera.

3 Adjust the camera angle so that the fender or the rear edge of the vehicle appears at the bottom of the monitor.

Use the Hexagon wrench to loosen the bolts, then adjust the camera angle. (After adjusting, tighten the bolts securely.)

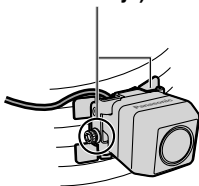

Fender or the rear edge of the vehicle

Camera field of view

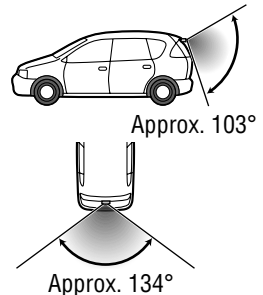

Free Manuals Download Website

<http://myh66.com>

<http://usermanuals.us>

<http://www.somanuals.com>

<http://www.4manuals.cc>

<http://www.manual-lib.com>

<http://www.404manual.com>

<http://www.luxmanual.com>

<http://aubethermostatmanual.com>

Golf course search by state

<http://golfingnear.com>

Email search by domain

<http://emailbydomain.com>

Auto manuals search

<http://auto.somanuals.com>

TV manuals search

<http://tv.somanuals.com>