

Pioneer

BDP-LX55
BDP-440
BDP-140

Blu-ray 3D™ PLAYER



For customers in Europe:

Discover the benefits of registering your product online at

<http://www.pioneer.co.uk> (or <http://www.pioneer.eu>)

Download an electronic version of this manual from our website.

Operating Instructions

Thank you for buying this Pioneer product.

Please read through these operating instructions so you will know how to operate your model properly. After you have finished reading the instructions, put them away in a safe place for future reference.

IMPORTANT



The lightning flash with arrowhead symbol, within an equilateral triangle, is intended to alert the user to the presence of uninsulated "dangerous voltage" within the product's enclosure that may be of sufficient magnitude to constitute a risk of electric shock to persons.

CAUTION

**RISK OF ELECTRIC SHOCK
DO NOT OPEN**

CAUTION:
TO PREVENT THE RISK OF ELECTRIC SHOCK, DO NOT REMOVE COVER (OR BACK). NO USER-SERVICEABLE PARTS INSIDE. REFER SERVICING TO QUALIFIED SERVICE PERSONNEL.



The exclamation point within an equilateral triangle is intended to alert the user to the presence of important operating and maintenance (servicing) instructions in the literature accompanying the appliance.

D3-4-2-1-1_A1_En

CAUTION

This product is a class 1 laser product classified under the Safety of laser products, IEC 60825-1:2007.

CLASS 1 LASER PRODUCT

D58-5-2-2a_A1_En

WARNING

This equipment is not waterproof. To prevent a fire or shock hazard, do not place any container filled with liquid near this equipment (such as a vase or flower pot) or expose it to dripping, splashing, rain or moisture.

D3-4-2-1-3_A1_En

WARNING

Before plugging in for the first time, read the following section carefully.

The voltage of the available power supply differs according to country or region. Be sure that the power supply voltage of the area where this unit will be used meets the required voltage (e.g., 230 V or 120 V) written on the rear panel.

D3-4-2-1-4*_A1_En

VENTILATION CAUTION

When installing this unit, make sure to leave space around the unit for ventilation to improve heat radiation (at least 10 cm at top, 10 cm at rear, and 10 cm at each side).

WARNING

Slots and openings in the cabinet are provided for ventilation to ensure reliable operation of the product, and to protect it from overheating. To prevent fire hazard, the openings should never be blocked or covered with items (such as newspapers, table-cloths, curtains) or by operating the equipment on thick carpet or a bed.

D3-4-2-1-7b*_A1_En

Operating Environment

Operating environment temperature and humidity: +5 °C to +35 °C (+41 °F to +95 °F); less than 85 %RH (cooling vents not blocked)

Do not install this unit in a poorly ventilated area, or in locations exposed to high humidity or direct sunlight (or strong artificial light)

D3-4-2-1-7c*_A1_En

If the AC plug of this unit does not match the AC outlet you want to use, the plug must be removed and appropriate one fitted. Replacement and mounting of an AC plug on the power supply cord of this unit should be performed only by qualified service personnel. If connected to an AC outlet, the cut-off plug can cause severe electrical shock. Make sure it is properly disposed of after removal.

The equipment should be disconnected by removing the mains plug from the wall socket when left unused for a long period of time (for example, when on vacation).

D3-4-2-2-1a_A1_En

CAUTION

The **⏻** **STANDBY/ON** switch on this unit will not completely shut off all power from the AC outlet. Since the power cord serves as the main disconnect device for the unit, you will need to unplug it from the AC outlet to shut down all power. Therefore, make sure the unit has been installed so that the power cord can be easily unplugged from the AC outlet in case of an accident. To avoid fire hazard, the power cord should also be unplugged from the AC outlet when left unused for a long period of time (for example, when on vacation).

D3-4-2-2-2a*_A1_En

This product is for general household purposes. Any failure due to use for other than household purposes (such as long-term use for business purposes in a restaurant or use in a car or ship) and which requires repair will be charged for even during the warranty period.

K041_A1_En

POWER-CORD CAUTION

Handle the power cord by the plug. Do not pull out the plug by tugging the cord and never touch the power cord when your hands are wet as this could cause a short circuit or electric shock. Do not place the unit, a piece of furniture, etc., on the power cord, or pinch the cord. Never make a knot in the cord or tie it with other cords. The power cords should be routed such that they are not likely to be stepped on. A damaged power cord can cause a fire or give you an electrical shock. Check the power cord once in a while. When you find it damaged, ask your nearest PIONEER authorized service center or your dealer for a replacement.

S002*_A1_En

WARNING

To prevent a fire hazard, do not place any naked flame sources (such as a lighted candle) on the equipment.

D3-4-2-1-7a_A1_En

For Taiwan exclusively

Taiwanese two pin flat-bladed plug

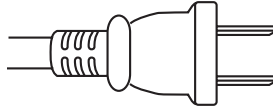

K056_A1_En

Information for users on collection and disposal of old equipment and used batteries

(Symbol for equipment)



These symbols on the products, packaging, and/or accompanying documents mean that used electrical and electronic products and batteries should not be mixed with general household waste.

For proper treatment, recovery and recycling of old products and used batteries, please take them to applicable collection points in accordance with your national legislation.

(Symbol examples for batteries)



By disposing of these products and batteries correctly, you will help to save valuable resources and prevent any potential negative effects on human health and the environment which could otherwise arise from inappropriate waste handling.

For more information about collection and recycling of old products and batteries, please contact your local municipality, your waste disposal service or the point of sale where you purchased the items.



Pb

These symbols are only valid in the European Union.

For countries outside the European Union:

If you wish to discard these items, please contact your local authorities or dealer and ask for the correct method of disposal.

K058a_A1_En

Cautions on 3D Viewing

- If you should experience any fatigue or discomfort while viewing 3D images, stop viewing them.
- Children, particularly those under 6, may be more prone to sensitivity, so guardians should watch for any signs of fatigue or discomfort.
- When viewing 3D images, rest periodically.

Extended viewing of 3D images without rest periods could cause fatigue or discomfort.

Contents

01 Before you start

What's in the box.....	5
Putting the batteries in the remote control.....	5
Software Update.....	6
About operation of this player from a mobile device (iPod, iPhone, iPad etc.).....	6
Types of discs/files that can be played.....	7
Playable discs.....	7
Playable files.....	10
Part Names and Functions.....	11
Remote Control.....	11
Front Panel.....	13
Rear Panel.....	14

02 Connecting up

Connecting using an HDMI cable.....	15
About HDMI.....	15
About Control Function with HDMI.....	16
Connecting a TV.....	18
Connecting an AV receiver or amplifier.....	18
Connecting video and audio cables.....	20
Connecting a TV using a video/audio cable.....	20
Connecting an AV receiver or amplifier using an optical digital audio cable.....	20
Connecting components to the USB port.....	20
About USB memory devices.....	20
Connecting the USB memory device.....	21
Connecting to the network through LAN interface.....	21
Connecting to a wireless LAN.....	22
Connecting the power cord.....	22

03 Getting Started

Making settings using the Setup Navigator menu.....	23
Operating the TV with the player's remote control.....	24
TV Preset code list.....	24

04 Playback

Playing discs or files.....	26
Forward and reverse scanning.....	27
Playing specific chapters or tracks.....	27
Skipping content.....	27
Playing in slow motion.....	27
Step forward and step reverse.....	27
Playing a specific section within a title or track repeatedly (A-B Repeat).....	27
Playing repeatedly (Repeat Play).....	27
Playing in the desired order (Programmed Play).....	28
Making bookmarks.....	28
Zoom.....	28
Displaying thumbnail images.....	28
Switching the camera angles.....	28
Switching the subtitles.....	29
Displaying the disc information.....	29
Switching the audio and secondary audio.....	29
Switching the secondary video.....	30
Enjoying BONUSVIEW or BD-LIVE.....	30
Playback functions.....	31

Using the FUNCTION menu.....	32
Playing from a specific time (Time Search).....	32
Playing a specific title, chapter or track (Search).....	32
Playing specified range of discs, titles or chapter (track/file) in random order.....	33
Continuing playback from a specified position (Continued Viewing Playback).....	33

05 Playback from Home Media Gallery

About Home Media Gallery.....	34
About network playback.....	34
DLNA Search.....	36
Disc/USB playback.....	36
Playing back image files.....	36
Playing in the desired order (Playlist).....	36
Adding tracks/files.....	36
Playing the Playlist.....	37
Deleting tracks/files from the Playlist.....	37

06 Playing the web contents

Available web contents.....	38
Playing the items.....	38

07 Advanced settings

Changing the settings.....	39
Operating the Initial Setup screen.....	39
Software updating.....	46
Restoring all the settings to the factory default settings.....	47
Language Code Table and Country/ Area Code Table.....	48

08 Additional information

Software license Notice.....	49
Cautions on use.....	54
Moving the player.....	54
Place of installation.....	54
Turn the power off when not using the player.....	54
Condensation.....	54
Cleaning the player.....	54
Caution for when the unit is installed in a rack with a glass door.....	54
Cleaning the pickup lens.....	54
Handling discs.....	54
Troubleshooting.....	55
Playback.....	55
Control function.....	58
Network.....	58
Others.....	59
Glossary.....	60
Specifications.....	62

Chapter 1

Before you start

What's in the box

- Remote control x 1
- Video/audio cable (yellow/white/red plugs) x 1
- AAA/R03 dry cell batteries x 2
- Warranty card (European and Russian models only)
- Power cord
- Operating instructions (this document)

Putting the batteries in the remote control

1 Open the rear cover.

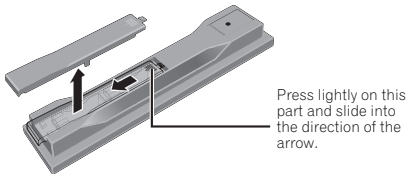

2 Insert the batteries (AAA/R03 x 2).

Insert as indicated by the ⊕/⊖ marks into the battery compartment.

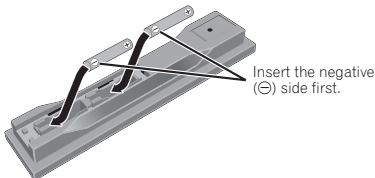

3 Close the rear cover.

Close securely (a click should be heard).

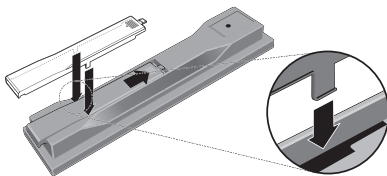

The batteries included with the player have been provided to allow you to check product operation and may not last long. We recommend using alkaline batteries that have a longer life.

⚠ WARNING

- Do not use or store batteries in direct sunlight or other excessively hot place, such as inside a car or near a heater. This can cause batteries to leak, overheat, explode or catch fire. It can also reduce the life or performance of batteries.

⚠ Caution

- Do not use any batteries other than the ones specified. Also, do not use a new battery together with an old one.
- When loading the batteries into the remote control, set them in the proper direction, as indicated by the polarity marks (⊕ and ⊖).
- Do not heat batteries, disassemble them, or throw them into flames or water.
- Batteries may have different voltages, even if they look similar. Do not use different kinds of batteries together.
- To prevent leakage of battery fluid, remove the batteries if you do not plan to use the remote control for a long period of time (1 month or more). If the fluid should leak, wipe it carefully off the inside of the case, then insert new batteries. If a battery should leak and the fluid should get on your skin, flush it off with large quantities of water.
- When disposing of used batteries, please comply with governmental regulations or environmental public institution's rules that apply in your country/area.

Software Update

Product information on this player is provided on the Pioneer website. Check this website for update and service information on your Blu-ray disc player.

IN Europe:

<http://www.pioneer.eu/>

IN U.K.:

<http://www.pioneer.eu/>

<http://www.pioneer.co.uk/>

IN Russia:

<http://www.pioneer.eu/>

<http://www.pioneer-rus.ru/>

IN Hong Kong:

<http://www.pioneerhongkong.com.hk/>

IN Singapore:

<http://www.pioneer.com.sg/firmwaredownload>

IN Australia

<http://www.pioneer.com.au/>

About operation of this player from a mobile device (iPod, iPhone, iPad etc.)

The player can be controlled from a mobile device by installing the special application onto the mobile device.

For details, see the product information on the Pioneer website.

This special application may be changed or discontinued without notice.

Types of discs/files that can be played

Playable discs

Discs with the logo marks below indicated on the disc label, package or jacket can be played.

⚠ Caution

- Only the discs that have been finalized can be played.

Disc type	Logo	Application format							
		BDMV	BDAV	DVD-Video	DVD-Audio	DVD VR	CD-DA DTS-CD	DATA-DISC ¹	
BD ²	BD-ROM	✓	✓	X	X	X	X	X	
	BD-R	✓	✓	X	X	X	X	X	
	BD-RE	✓	✓	X	X	X	X	X	
DVD									
	DVD-ROM	✓	X	✓	✓ ³	X	X	✓	
									
	DVD-R ^{2,4,5}	✓ ⁶	✓ ⁷	✓	X	✓	X	✓	
									
	DVD-RW ^{4,8}	✓ ⁶	✓ ⁷	✓	X	✓	X	✓	
	DVD+R ^{2,4}	✓	X	✓	X	X	X	✓	
	DVD+RW ⁴	✓	X	✓	X	X	X	✓	
	CD								
		CD-DA (Audio CD) ⁹	X	X	X	X	X	✓	X
									
CD-R ⁴		X	X	X	X	X	✓	✓	
CD-RW ⁴		X	X	X	X	X	✓	✓	
CD-ROM	X	X	X	X	X	✓	✓		

1. Discs on which video, image or audio files are recorded. This player does not support multisession discs or multiborder recording.
2. Including dual-layered discs.
3. BDP-LX55 and BDP-440 only.
4. Finalize them before playing them on this player.
5. DVD-R for Authoring discs (3.95 and 4.7 GB) cannot be played.
6. Including the AVCHD format.
7. Including the AVCRC format.
8. Version 1.0 DVD-RW discs cannot be played.
9. Including Video CDs.

- “Blu-ray Disc”, “Blu-ray” and “Blu-ray Disc” logo are trademarks of Blu-ray Disc Association.
-  is a trademark of DVD Format/Logo Licensing Corporation.
- Corporation and product names mentioned herein are trademarks or registered trademarks of the respective corporations.

❖ Discs that cannot be played

- HD DVDs
- DVD-RAM discs

It is possible that some discs other than the ones listed above may not be playable either.



Note

- Some discs cannot be played, even if one of the logo marks on the previous page is indicated.
- To play 8 cm discs, set the disc in the 8 cm disc depression in the center of the disc tray. No adapter is necessary. 8 cm BD-ROMs cannot be played.

❖ About audio formats

The following audio formats are supported on this player:

- Dolby TrueHD
- Dolby Digital Plus
- Dolby Digital
- DTS-HD Master Audio
- DTS-HD High Resolution Audio
- DTS Digital Surround
- MPEG audio (AAC)
- Linear PCM

To enjoy the surround sound of Dolby TrueHD, Dolby Digital Plus, DTS-HD Master Audio and DTS-HD High Resolution Audio, it is recommended to connect the player to an AV receiver or amplifier compatible with these audio formats using an HDMI cable. After loading a BD containing sound in one of these audio formats, select the audio format on the menu screen.

Manufactured under license from Dolby Laboratories. Dolby and the double-D symbol are trademarks of Dolby Laboratories.

Manufactured under license under U.S. Patent Nos: 5,956,674; 5,974,380; 6,226,616; 6,487,535; 7,392,195; 7,272,567; 7,333,929; 7,212,872 & other U.S. and worldwide patents issued & pending. DTS-HD, the Symbol, & DTS-HD and the Symbol together are registered trademarks & DTS-HD Master Audio | Essential is a trademark of DTS, Inc. Product includes software. © DTS, Inc. All Rights Reserved.

❖ Playing BDs

- BDs (BDMV) compatible with the formats below can be played.
 - Blu-ray Disc Read-Only (ROM) Format Version 2
 - Blu-ray Disc Recordable (R) Format Version 2
 - Blu-ray Disc Rewritable (RE) Format Version 3

This player supports BD-ROM Profile 5.



“Blu-ray 3D” and “Blu-ray 3D” logo are trademarks of Blu-ray Disc Association.

BONUSVIEW functions such as playback of secondary video (Picture-in-Picture) and secondary audio can be used. The data used with the BONUSVIEW functions (the secondary video (Picture-in-Picture) and secondary audio data) may be stored in the storage. For details on secondary video and secondary audio playback, refer to the disc’s instructions.

BONUSVIEW™

“BONUSVIEW” is trademark of Blu-ray Disc Association.

BD-LIVE functions such as downloading movie trailers or additional audio and subtitle languages and playing on-line games can be enjoyed over the Internet. The data downloaded with the BD-LIVE function (trailers, etc.) is stored in the storage. Refer to the disc’s instructions for details about BD-LIVE functions.



“BD-LIVE” logo is trademark of Blu-ray Disc Association.

With BD-ROMs, it is possible to use BD-J (Java) applications to create highly interactive titles, for example including games.



Oracle and Java are registered trademarks of Oracle and/or its affiliates. Other names may be trademarks of their respective owners.

- BDs (BD-RE) compatible with the formats below can be played.
 - Blu-ray Disc Recordable (R) Format Version 1
 - Blu-ray Disc Rewritable (RE) Format Version 2

❖ Playing DVDs



This label indicates playback compatibility with DVD-RW discs recorded in VR format (Video Recording format). However, for discs recorded with a record-only-once encrypted program, playback can only be achieved using a CPRM compatible device.

The AVCHD is a high definition (HD) digital video camera recorder format recording high-definition onto certain media by using highly efficient codec technologies.



"AVCHD" and the "AVCHD" logo are trademarks of Panasonic Corporation and Sony Corporation.

❖ About region numbers

Blu-ray Disc Player and BD-ROM or DVD-Video discs are assigned region numbers according to the region in which they are sold.

This player's region numbers are:

- BD-ROM:
 - Europe, Australia and New Zealand models: B
 - Russia models: C
 - Others: A
- DVD-Video:
 - Europe models: 2
 - Australia and New Zealand models: 4
 - Russia models: 5
 - Others: 3

Discs not including these numbers cannot be played. Discs playable on this player are as shown below.

- BDs:
 - Europe, Australia and New Zealand models: B (including B) and ALL
 - Russia models: C (including C) and ALL
 - Others: A (including A) and ALL
- DVDs:
 - U.K. models: 2 (including 2) and ALL
 - Australia and New Zealand models: 4 (including 4) and ALL
 - Russia models: 5 (including 5) and ALL
 - Others: 3 (including 3) and ALL

❖ Playing CDs

Regarding copy protected CDs: This player is designed to conform to the specifications of the Audio CD format. This player does not support the playback or function of discs that do not conform to these specifications.

❖ DualDisc playback

A DualDisc is a two-sided disc, one side of which contains DVD content — video, audio, etc. — while the other side contains non-DVD content such as digital audio material.

The DVD side of a DualDisc can be played on this player.

The non-DVD, audio side of the disc is not compatible with this player.

It is possible that when loading or ejecting a DualDisc, the opposite side to that being played will be scratched. Scratched discs may not be playable.

For more detailed information on the DualDisc specification, please refer to the disc manufacturer or disc retailer.

❖ Playing discs created on computers or BD/DVD recorders

- It may not be possible to play discs recorded using a computer due to the application settings or computer's environment settings. Record discs in a format playable on this player. For details, contact the dealer.
- It may not be possible to play discs recorded using a computer or a BD/DVD recorder, if burn quality is not good due to characteristics of the disc, scratches, dirt on the disc, dirt on the recorder's lens, etc.

❖ About video, audio, and image files and folders

Audio and image files can be played on this player when the folders on the disc or USB memory device are created as described below.

Example of folder structure:

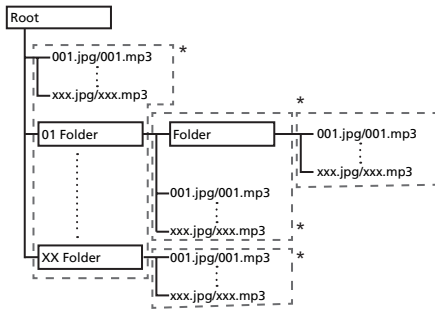

* The number of folders and files within a single folder (including the root directory) is limited to a maximum of 256. Also, keep the number of folder layers to a maximum of 5.

Note

- The file and folder names displayed on this player may differ from those displayed on a computer.

Playable files

Video, image and audio files recorded on DVDs and CDs can be played.

Caution

- In DVD, only the one recorded by the ISO 9660 file system can be played.
- Some files may not be playable.
- For some files, it may not be possible to use certain functions during playback.
- It may not be possible to play some files, even if they have the extension of a file playable on this player.
- Files protected by DRM (Digital Rights Management) cannot be played (not including DivX VOD files).

❖ Supported video file formats

• DivX Plus HD

DivX Certified[®] to play DivX[®] and DivX Plus[™] HD (H.264/MKV) video up to 1080p HD including premium content.

ABOUT DIVX VIDEO: DivX[®] is a digital video format created by DivX, Inc. This is an official DivX Certified[®] device that plays DivX video. Visit divx.com for more information and software tools to convert your files into DivX video.

ABOUT DIVX VIDEO-ON-DEMAND: This DivX

Certified[®] device must be registered in order to play purchased DivX Video-on-Demand (VOD) movies. To obtain your registration code, locate the DivX VOD section in your device setup menu. Go to vod.divx.com for more information on how to complete your registration.



DivX[®], DivX Certified[®], DivX Plus[™] HD and associated logos are trademarks of DivX, Inc. and are used under license.

Note

- This DivX[®] Certified device must be registered in order to play DivX Video-on-Demand (VOD) content. First generate the DivX VOD registration code for your device and submit it during the registration process. Important: DivX VOD content is protected by a DivX DRM (Digital Rights Management) system that restricts playback to registered DivX Certified devices. If you try to play DivX VOD content not authorized for your device, the message **Authorization Error** will be displayed and your content will not be played. Learn more at www.divx.com/vod.

– This player's DivX VOD registration code can be checked at **HOME MENU → Initial Setup → Playback → DivX(R) VOD DRM → Registration Code** (page 42).

– The number of views is restricted for some DivX VOD files. When such files are played on this player, the remaining number of views is displayed. Files for which the remaining number of views has reached 0 cannot be played (**This DivX rental has expired** is displayed). Files for which the number of views is not restricted can be played as many times as you like (the remaining number of views is not displayed).

• MKV

MKV files can be played.

- MKV is a file format allowing multiple audio and video files to be held in a single file.
- The files that can be played are as follows:
Resolution: Up to 1 280 x 720
Extension: “.mkv” or “.MKV”

• Windows Media™ Video (WMV)

Windows Media™ Video (WMV) files can be played.

- The files that can be played are as follows:
Resolution: Up to 1 280 x 720
Extension: “.wmv” or “.WMV”
- Files encoded using the Windows Media™ Encoder 9 series are supported.
- Windows Media is either a registered trademark or trademark of Microsoft Corporation in the United States and/or other countries.
- This product includes technology owned by Microsoft Corporation and cannot be used or distributed without a license from Microsoft Licensing, Inc.

❖ Supported image file formats

• JPEG

• Progressive JPEG

File format: JFIF Ver. 1.02/Exif Ver. 2.2
Resolution: Up to 4 096 x 4 096 pixels

❖ Supported audio file formats

• Windows Media™ Audio 9 (WMA9)

Bit rate: Up to 192 kbps
Sampling frequencies: 22.05 kHz, 32 kHz, 44.1 kHz and 48 kHz

• MPEG-1 Audio Layer 3 (MP3)

Bit rate: Up to 320 kbps
Sampling frequencies: 8 kHz, 11.025 kHz, 12 kHz, 16 kHz, 22.05 kHz, 24 kHz, 32 kHz, 44.1 kHz and 48 kHz

• Free Lossless Audio Codec (FLAC) (Only for BDP-LX55)

Sampling frequencies: 96 kHz to 192 kHz
Quantization bitrate: 16 bit, 24 bit
Channel: 2ch

❖ Playable file extensions

• Video files

.divx, .mkv, .wmv and .avi

• Image files

.jpg and .jpeg

• Audio files

.wma and .mp3
.flac (BDP-LX55 only)

Part Names and Functions

Remote Control

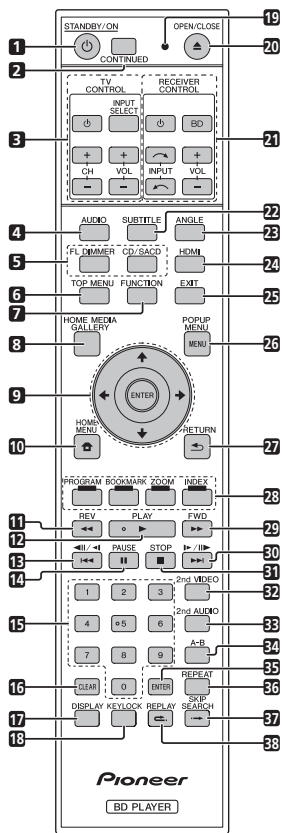

- 1 **⏻ STANDBY/ON** – Press to turn the power on and off.
- 2 **⏮ CONTINUED** – Use to continue playback from a specified position. (page 33)
- 3 **TV CONTROL** – (page 24)
- 4 **AUDIO** – (page 29)

5 FL DIMMER







BDP-LX55, BDP-440 – Each time this is pressed, the brightness of the front panel display changes and/or the lighting status of the indicators on the front panel switches as shown in the table below.

Front panel display	Indicators		
	Blu-ray (BDP-LX55 only)	PQLS	FL OFF
Bright	Lights	Lights	Off
Middle	Lights	Lights	Off
Dark	Lights	Lights	Off
Off	Off	Off	Lights

BDP-140 – Each time this is pressed, the brightness of the front panel display switches (in 4 levels).

CD/SACD

For hybrid discs, press to switch between the CD and SACD layers.

- 6 TOP MENU** – Press to display the top menu of the BD-ROM or DVD-Video.
- 7 FUNCTION** – (page 32)
- 8 HOME MEDIA GALLERY** – (page 34)
- 9**  – Use to select items, change settings and move the cursor.
ENTER – Press to execute the selected item or enter a setting that has been changed, etc.
- 10**  **HOME MENU** – (page 39)
- 11**  **REV** – (page 27)
- 12**  **PLAY** – (page 26)
- 13**  – (page 27)
- 14**  **PAUSE** – (page 26)
- 15 Number buttons** – Use these to select and play the title/chapter/track you want to view or listen to and to select items from menus.
- 16 CLEAR** – Press to clear the numeric number, etc.
- 17 DISPLAY** – (page 29)
- 18 KEYLOCK** – (page 12)
- 19 Remote control LED** – Lights when a command is sent from the remote control. Flashes while the TV band code is being set.
- 20**  **OPEN/CLOSE** – Press to open and close the disc tray.
- 21 RECEIVER CONTROL**
- 22 SUBTITLE** – (page 29)
- 23 ANGLE** – (page 28)

24 HDMI

BDP-LX55 – Use to switch **HDMI Mode** alternately (pages 16 and 41).

BDP-440/BDP-140 – Use to switch the resolution of the video signals output from the **HDMI OUT** terminal (page 41).

25 EXIT – (page 38)

26 POP UP MENU/MENU – Press to display the BD-ROM or DVD-Video menus.

27  **RETURN** – Press to return to the previous screen.

28 Color buttons – Use these to navigate BD-ROM menus.

PROGRAM – (page 28)

BOOK MARK – (page 28)

ZOOM – (page 28)

INDEX – (page 28)

29  **FWD** – (page 27)

30  – (page 27)

31  **STOP** – (page 26)

32 2nd VIDEO – (page 30)

33 2nd AUDIO – (page 29)

34 A-B – (page 27)

35 ENTER – Press to execute the selected item or enter a setting that has been changed, etc.

36 REPEAT – (page 27)

37 SKIP SEARCH – Press to skip 30 seconds ahead when  **SKIP SEARCH** is pressed during playback.

38 REPLAY – Press to jump back 10 seconds when  **REPLAY** is pressed during playback.

❖ Keylock function

You can set the keylock to prevent accidental operations. This function allows TVs compatible with control function with HDMI to also perform a Key Lock on the player.

Press and hold **KEYLOCK** for more than 2 seconds.

- Each time you perform this operation, the function is activated or deactivated.
- If you try to operate the player while the keylock function is set, **LOCK** lights on the front panel display.

 Note

- This remote control unit is equipped with two **ENTER** buttons (9 and 35 listed above).
- To operate an AV receiver equipped with a remote control mode setting using the **RECEIVER CONTROL** buttons, set the AV receiver's remote control mode to "1". For details, see the AV receiver's operating instructions.

BDP-LX55

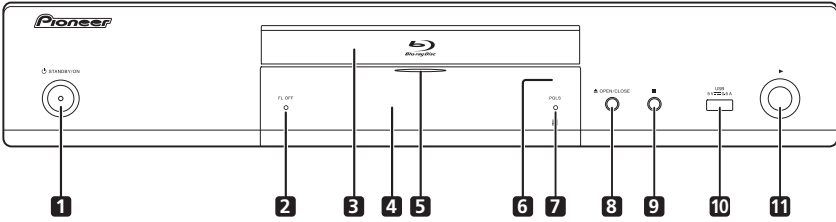

BDP-440

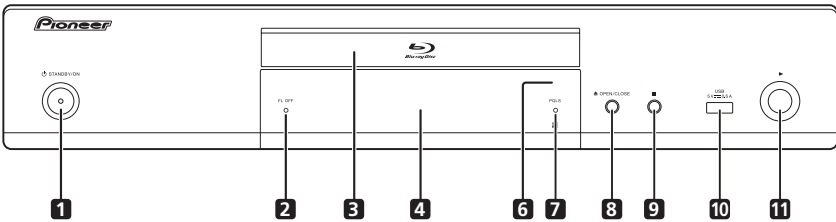

BDP-140

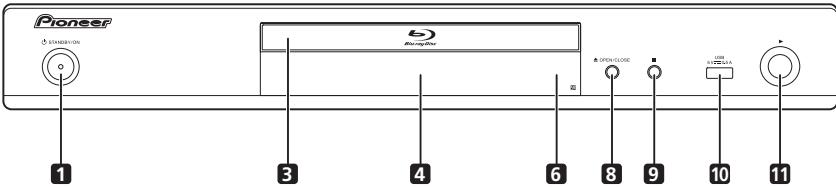

- | | |
|--|---|
| <p>1 STANDBY/ON – Press to turn the power on and off.</p> <p>2 FL OFF indicator (BDP-LX55 and BDP-440 only) – (page 12)</p> <p>3 Disc tray</p> <p>4 Front panel display</p> <p>5 Blu-ray indicator (BDP-LX55 only) – (page 12)</p> <p>6 Remote control sensor – Point the remote control to this, then operate it within approximately 7 m. The player may have trouble capturing remote control signals if there is a fluorescent light nearby. If this happens, move the player away from the fluorescent light.</p> | <p>7 PQLS indicator (BDP-LX55 and BDP-440 only) – (page 17)</p> <p>8 OPEN/CLOSE – Press to open and close the disc tray.</p> <p>9 – Press to stop playback.</p> <p>10 USB port – (page 20)</p> <p>11 – Press to start playback.</p> |
|--|---|

BDP-LX55

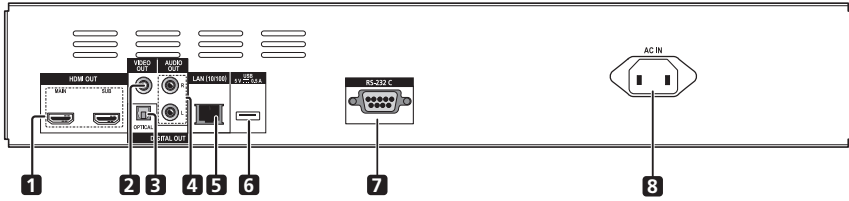

BDP-440

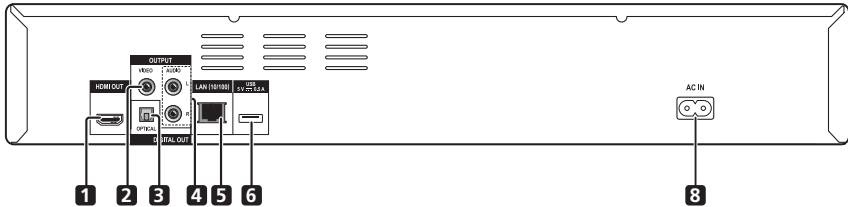

BDP-140

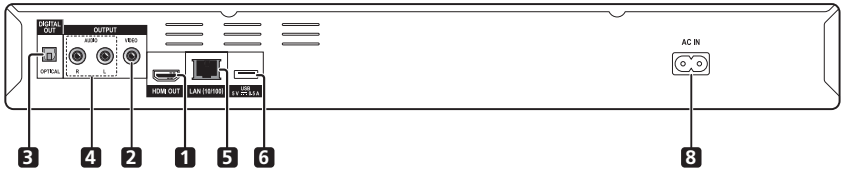

- | | | | |
|---|--|---|---|
| 1 | HDMI OUT terminal(s) – (below and page 15) | 5 | LAN (10/100) terminal – (page 21) |
| 2 | VIDEO OUTPUT terminals – (page 20) | 6 | USB port – (page 20) |
| 3 | DIGITAL OUT (OPTICAL) terminal – (page 20) | 7 | RS-232C terminal (BDP-LX55 only) – This terminal is not used. |
| 4 | AUDIO OUTPUT terminals – (page 20) | 8 | AC IN – (page 22) |

❖ About the HDMI terminals on the BDP-LX55

MAIN – Connect with an HDMI-compatible TV or/and AV receiver or amplifier. This is the terminal that is used mainly.

SUB – Connect with an HDMI compatible AV receiver or amplifier. This terminal is only for outputting audio signals.

Note

- No video signal can be output through the **SUB** terminal. Make sure to connect your TV to the **MAIN** terminal.

Chapter 2

Connecting up

Be sure to turn off the power and unplug the power cord from the power outlet whenever making or changing connections.

After connecting, make the settings at the **Setup Navigator** or **Initial Setup** menu according to the type of cable connected (page 23).

Also refer to the operating instructions for the device being connected.

Note

- The illustrations used here are mainly of the BDP-LX55.

Connecting using an HDMI cable

The audio and video signals can be transferred to HDMI-compatible devices as digital signals with no loss of sound or video quality.

Note

- For the BDP-LX55, make the **HDMI Mode** setting at the **Initial Setup** menu according to the connection of the devices to the player (pages 16 and 41).
- Make the settings at the **Setup Navigator** menu according to the connected HDMI-compatible device (page 23).
- 1080p video signals may not be output, depending on the HDMI cable being used.

About HDMI

This player incorporates the High-Definition Multimedia Interface (HDMI[®]) technology.

HDMI

HDMI, the HDMI Logo and High-Definition Multimedia Interface are trademarks or registered trademarks of HDMI Licensing, LLC in the United States and other countries.

The player supports Deep Color.

The conventional players can transmit a video signal with 8 bit color depth in the YCbCr 4:4:4 or RGB format; the players supporting Deep Color can transmit a video signal with a color bit depth of greater than 8 bits per color component. Subtle color gradations can be reproduced when this player is connected to a TV that supports Deep Color.

This product is compatible with "x.v.Color" that have the capability to realize a wide-gamut color space based on the xvYCC specifications.

Playing video signals conforming to "xvYCC" standards on this player when this player is connected to an "x.v.Color"-compatible TV, etc., expands color reproduction capabilities, allowing natural colors to be reproduced more faithfully than ever.

"x.v.Color" is a promotion name given to the products that have the capability to realize a wide-gamut color space based on the international standard specifications defined as xvYCC.

x.v.Color

"x.v.Color" and x.v.Color are trademarks of Sony Corporation.

❖ Playable audio signals through the HDMI OUT terminal

- Dolby TrueHD
- Dolby Digital Plus
- Dolby Digital
- DTS-HD Master Audio
- DTS-HD High Resolution Audio
- DTS Digital Surround
- MPEG-2 AAC
- Linear PCM

Linear PCM audio signals meeting the following conditions can be output:

- Sampling frequency: 32 kHz to 192 kHz
- Number of channels: Up to 8 (up to 6 for a 192 kHz sampling frequency)

❖ When connected to a DVI device

- **It is not possible to connect DVI devices (computer displays, for example) that are not compatible with HDCP.** HDCP is a specification to protect audiovisual content across the DVI/HDMI interface.
- No audio signals are output. Connect using an audio cable, etc.
- This player is designed for connection with HDMI-compatible devices. When connected to a DVI device, it may not operate properly depending on the DVI device.

About Control Function with HDMI

The functions work when a control function with HDMI-compatible Pioneer Flat Screen TV or AV system (AV receiver or amplifier, etc.) is connected to the player using an HDMI cable.

Also refer to the operating instructions for the Flat Screen TV and AV system (AV receiver or amplifier, etc.).

❖ To use the control function with HDMI

- The control function with HDMI operates when control function with HDMI is set to On for all devices connected with HDMI cables.
- Once the connections and the settings of all the devices are finished, be sure to check that the player's picture is output to the Flat Screen TV. (Also check after changing the connected devices and reconnecting HDMI cables.) The control function with HDMI may not operate properly if the player's picture is not properly output to the Flat Screen TV.
- Use High Speed HDMI® Cables when using the control function with HDMI. The control function with HDMI may not operate properly if other HDMI cables are used.
- For some models, the control function with HDMI may be referred to as "KURO LINK" or "HDMI Control".
- The control function with HDMI does not work with devices of other brands, even if this player is connected with an HDMI cable.

❖ What the control function with HDMI can do

- **Outputting the optimum picture quality to a Flat Screen TV compatible with the control function with HDMI.**

When the control function with HDMI is enabled, video signals with the optimum picture quality for control function with HDMI are output from the player's HDMI terminal.

- **Operating the player with the Flat Screen TV's remote control.**

Such player operations as starting and stopping playback and displaying the menus can be performed from the Flat Screen TV.

- **The player's playback picture is displayed on the Flat Screen TV's screen. (Auto-select function)**

The input switches automatically on the Flat Screen TV and AV system (AV receiver or amplifier, etc.) when playback is started on the player or the HOME MENU is displayed. When the input is switched, the playback picture, the HOME MENU appears on the Flat Screen TV.

- **The power of the Flat Screen TV and the player turns on and off automatically. (Simultaneous power function)**

When playback on the player is started or the HOME MENU is displayed, if the Flat Screen TV's power was off, its power turns on automatically. When the Flat Screen TV's power is turned off, the player's power automatically turns off.

❖ Setting the HDMI Mode (Only for BDP-LX55)

The BDP-LX55 has two **HDMI OUT (MAIN, SUB)** terminals. See page 14 for the details on these terminals.

The **HDMI Mode** needs to be selected before playback to use the control function appropriately.

To make the setting, press **HOME MENU** to display the Home Menu, select **Initial Setup** → **Audio Output** → **HDMI Mode**.

See the table below and set up the **HDMI Mode** according to your connection style.

HDMI Mode	HDMI OUT MAIN			HDMI OUT SUB		
	Video	Audio	Control	Video	Audio	Control
Single	✓	✓	✓	✗	✗	✗
Separate	✓	✗	✗	✗	✓	✓
Pure Audio	✗	✗	✗	✗	✓	✓



Caution

- No video signal is output through the **SUB** terminal. This terminal is only for audio signals.

❖ Sound Retriever Link

About Sound Retriever Link

Sound Retriever Link is a sound quality correction control technology that automatically adjusts the compressed sound quality for the connected AV receiver using HDMI control function.

Sound Retriever Link function allows you to enjoy higher quality audio by setting the connected AV receiver's Sound Retriever function automatically.

Sound Retriever Link function on this player works exclusively with the following situations.

- PC Audio Stream that is played by USB devices or via network.
- The Pioneer AV receiver compatible with Sound Retriever Link function is connected to this player through an HDMI cable and the player's setting is set as shown below (page 41).

Control: On

- Also refer to the instructions of the AV receiver.
- See Pioneer website about AV receivers compatible with Sound Retriever Link function.

Caution

- Connect the player directly to the Pioneer AV receiver compatible with Sound Retriever Link function. Interrupting a direct connection with an amplifier or AV converter (such as an HDMI switch) can cause malfunction.

❖ **Stream Smoother (only for the BDP-LX55)**

Stream Smoother is a function that automatically improves picture quality when playing network video contents by using a built-in high picture quality circuit to reduce mosquito noise, block noise, etc.

Note

- On the BDP-LX55, this function is activated even when no AV receiver is connected.

❖ **Stream Smoother Link (Only for BDP-440 and BDP-140)**

About Stream Smoother Link

Stream Smoother Link is a function that improves picture quality of network video contents using the control function with HDMI. Stream Smoother Link function allows you to enjoy a high quality picture with less noise by setting the connected AV receiver's Stream Smoother function automatically.

Stream Smoother Link function on this player works exclusively with the following situations.

- Playback of PC contents stored on discs and USB devices.
- The Pioneer AV receiver with Stream Smoother Link function is connected to this player through an HDMI cable, and the player's setting is set as shown below (page 41).

Control: On

- Also refer to the instructions for the AV receiver.
- See Pioneer website about AV receivers compatible with Stream Smoother Link function.

Caution

- Connect the player directly to the Pioneer AV receiver compatible with Stream smoother Link function. Interrupting a direct connection with an amplifier or AV converter (such as HDMI switch) can cause malfunction.

❖ **About the PQLS function (Only for BDP-LX55 and BDP-440)**

PQLS (Precision Quartz Lock System) is a digital audio transfer control technology using the HDMI control function. The player's output signals are controlled from the AV receiver to achieve high sound quality playback using the receiver's quartz oscillator. This eliminates the influence of the jitter generated during signal transfer which can adversely affect the sound quality.

- This player supports the functions below.
 - The "PQLS 2ch Audio" function that is only activated when playing music CDs (CD-DAs)
 - The "PQLS Multi Surround" function that is activated when playing all discs (BDs, DVDs, etc.) with linear PCM audio output
 - The "PQLS Bitstream" function that is activated when playing with bitstream audio output
- The various PQLS functions are activated when a Pioneer AV receiver supporting the PQLS functions is connected directly to the **HDMI OUT** terminal with an HDMI cable and the player's settings are set as shown below (page 41).

Control: On

- Also refer to the AV receiver's operating instructions.
- See the Pioneer website for AV receivers supporting the PQLS function.

Caution

- The PQLS function may stop working when the video output resolution is switched. The PQLS function will start working again once playback is stopped then restarted.
- When the PQLS 2ch function is activated, the output from the player's **VIDEO OUTPUT** jacks may not have the proper colors. If this happens, connect the TV and AV receiver's HDMI terminals to view the picture.
- Turn on the power of the AV receiver connected to the **HDMI OUT** terminal, then start playback of the disc.

Note

- PQLS indicator on the player's front panel display lights when the PQLS function is activated (page 13).

Connecting a TV

See *Connecting an AV receiver or amplifier* on the right column to connect an AV receiver or amplifier using an HDMI cable.

⚠ Caution

- Hold the plug when connecting and disconnecting the cable.
- Placing a load on the plug could result in faulty contact and no video signals being output.

❖ BDP-LX55

Connect a TV to the **HDMI OUT (MAIN)** terminal.

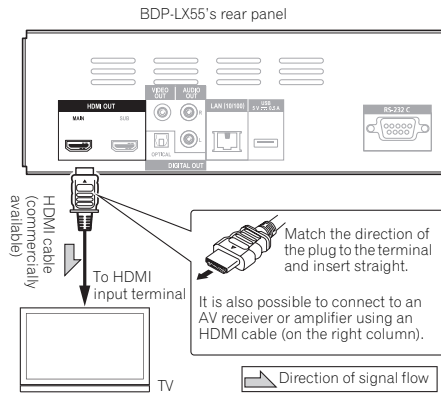

It is also possible to connect a TV via AV receiver or amplifier to **HDMI OUT (MAIN)** terminal. See *Connecting an AV receiver or amplifier* on the right column.

⚠ Caution

- Make sure to connect a TV to **HDMI OUT (MAIN)** terminal, video signals cannot be output from **HDMI OUT (SUB)** terminal.
- Make sure to set **HDMI Mode** to **Single** (page 41).

❖ BDP-440/BDP-140

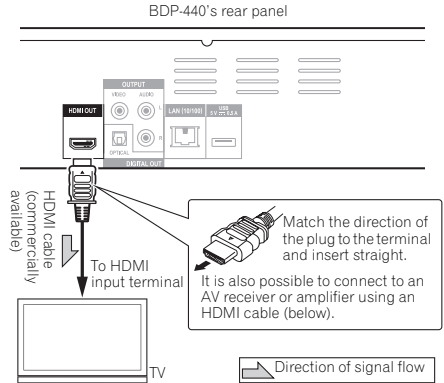

Connecting an AV receiver or amplifier

Connect to an AV receiver or amplifier in order to enjoy the surround sound of Dolby TrueHD, Dolby Digital Plus, Dolby Digital, DTS-HD Master Audio, DTS-HD High Resolution Audio or DTS Digital Surround. For instructions on connecting the TV and speakers to the AV receiver or amplifier, refer to the operating instructions for AV receiver or amplifier.

⚠ Caution

- Hold the plug when connecting and disconnecting the cable.
- Placing a load on the plug could result in faulty contact and no video signals being output.

❖ BDP-LX55

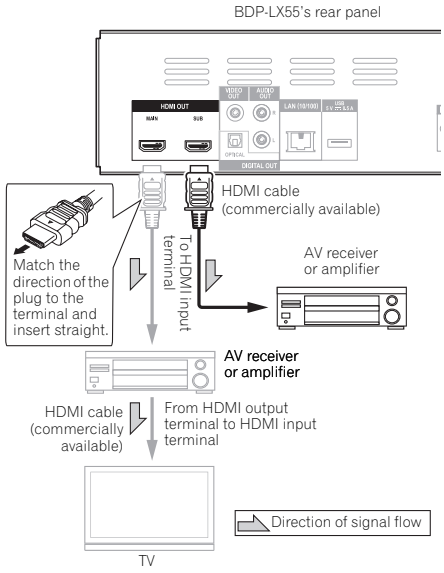

Achieving better video and sound quality

When connecting one TV (or projector) and AV amplifier to the player, connect in such a way that the video and audio signals are transferred separately in order to achieve higher quality video and sound.

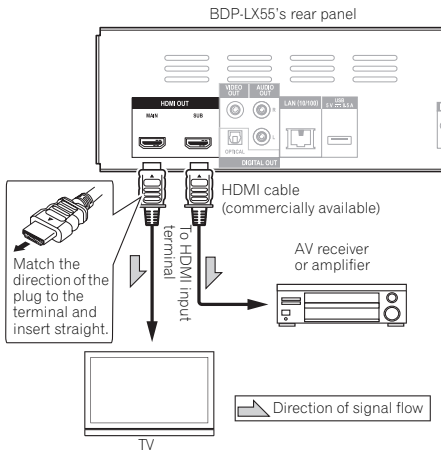

! Caution

- Make sure to connect a TV to **HDMI OUT (MAIN)** terminal, video signals cannot be output from **HDMI OUT (SUB)** terminal.
- Make sure to set **HDMI Mode** to **Separate** (page 41).
- If the AV amplifier connected to the **HDMI OUT (SUB)** terminal is also connected to a TV, the TV's input may switch automatically. If this happens, turn off the control function with HDMI on the TV.

❖ BDP-440/BDP-140

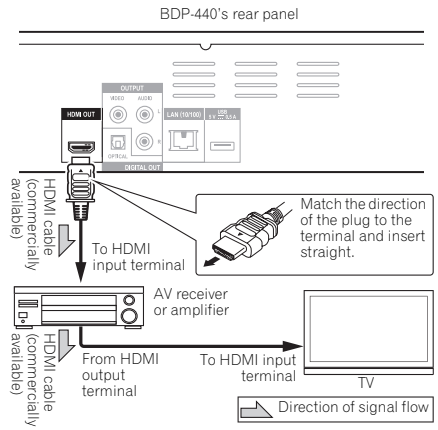

02 Connecting video and audio cables

Note

- Make the settings in the **Setup Navigator** menu according to the type of cable connected (page 23).
- To output video signals from this player, connect using a video cable (not including when connected using an HDMI cable).

Connecting a TV using a video/audio cable

Caution

- **Connect the player's video output directly to your TV.**
This player supports the analog copy protection technology. Therefore, the picture may not be displayed properly if this player is connected to a TV via a DVD recorder/video deck or when playing the player's output material that is recorded by a DVD recorder/video deck. Furthermore, the picture may not be displayed properly due to the copy protection when the player is connected to a TV with a built-in video deck. For details, contact the manufacturer of your TV.

BDP-LX55's rear panel

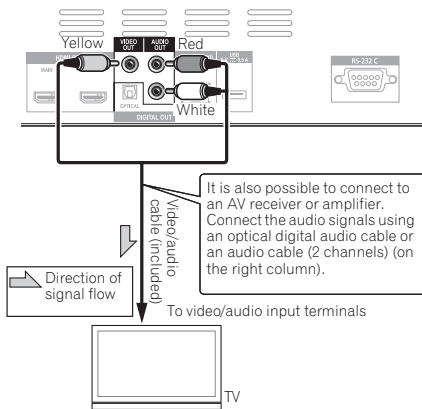

Note

- Video signals are output with a resolution of 480/576i or 480/576P when this player is connected using a video cable.
- Depending on the output video resolution setting, the picture may not be output.

Connecting an AV receiver or amplifier using an optical digital audio cable

BDP-LX55's rear panel

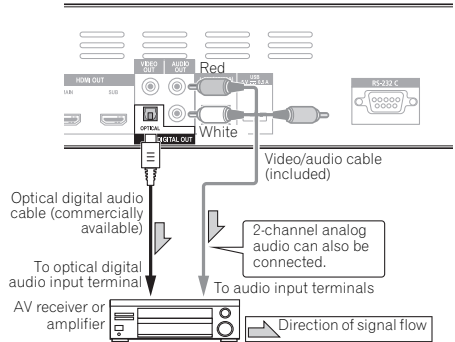

Note

- To switch the video from the AV receiver or amplifier, also connect the video output terminals.

Connecting components to the USB port

The data downloaded with the BD-LIVE function and the data used with the BONUSVIEW function when playing BD-ROMs can be stored on a device connected to the **USB** port (USB memory).

About USB memory devices

The USB memory devices that can be connected to the player are as shown below.

- USB 2.0-compatible memory devices
- FAT16 or FAT32 file system, minimum 1 GB capacity (2 GB or more recommended)

Note

- Devices formatted with a file system other than the above cannot be used. Such devices may however be usable if they are formatted from the player.
- USB memory devices may not be recognized if they contain multiple partitions.
- Some USB memory devices may not operate with this player.
- Operation of USB memory devices is not guaranteed.

Connecting the USB memory device

⚠ Caution

- Be sure to turn the player's power off before connecting or disconnecting USB memory devices.
- Use empty USB memory devices (on which nothing is stored).
- If the USB memory device is write-protected, be sure to disable the write-protection.
- Placing excessive loads on the plug may result in poor contact, making it impossible to write data on the USB memory device.
- When a USB memory device is connected and the player's power is turned on, do not unplug the power cord.
- USB external hard disks cannot be connected to the player.

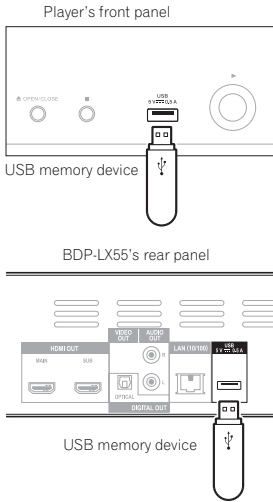

📝 Note

- Devices may not work if connected to the **USB** port via a memory card reader or USB hub.

Connecting to the network through LAN interface

By connecting this player to the network via the LAN terminal, you can play audio files stored on the components on the network, including your computer, using HOME MEDIA GALLERY inputs.

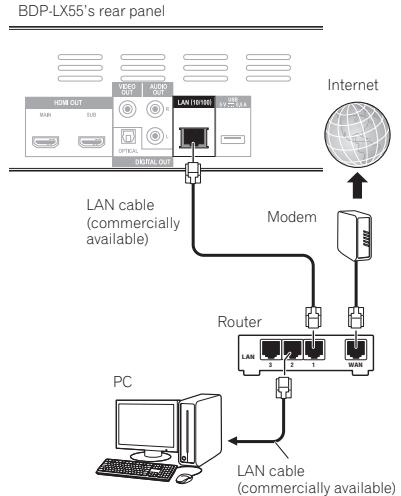

Connect the LAN terminal on this receiver to the LAN terminal on your router (with or without the built-in DHCP server function) with a straight LAN cable (CAT 5 or higher).

Turn on the DHCP server function of your router. In case your router does not have the built-in DHCP server function, it is necessary to set up the network manually. For details, see *Setting the IP address* on page 44 .

❖ LAN terminal specifications

LAN terminal: Ethernet jack (10BASE-T/100BASE-TX)

📝 Note

- Refer to the operation manual of the equipment you have as the connected equipment and connection method may differ depending on your Internet environment.
- When using a broadband Internet connection, a contract with an Internet service provider is required. For more details, contact your nearest Internet service provider.

02 Connecting to a wireless LAN

Wireless connection to the network is possible through a wireless LAN connection. Use the separately sold AS-WL300 for connection.

- Refer to the operating instructions of AS-WL300 for the setting details.

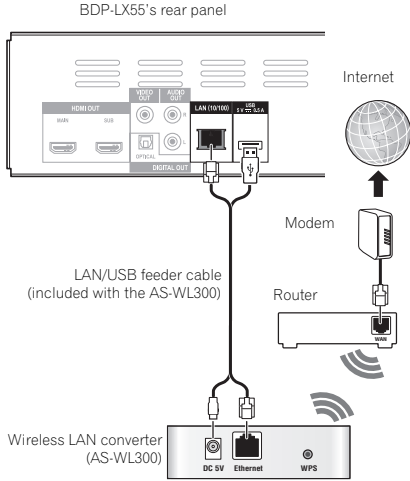

Connecting the power cord

Connect the power cord after all the connections between devices have been completed.

BDP-LX55's rear panel

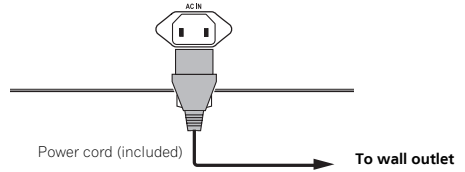

Chapter 3

Getting Started

Making settings using the Setup Navigator menu

Be sure to perform these settings when using the player in the following situations.

- When you use the player for the first time.
- After **Initial Setup** format.
- After updating the player's software.

⚠ Caution

- Before turning on the power, check that the connections between the player and other devices are correct. Also, turn on the power of the devices connected to the player before turning on the player's power.
- When using a Pioneer Flat Screen TV or front projector compatible with the Control function, set Control to On on the connected device before turning on the player's power.

📝 Note

- When a Pioneer Flat Screen TV or front projector compatible with the Control function is connected to the player using an HDMI cable, the player is automatically set to the optimum picture quality for the connected device.

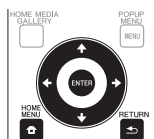

1 Turn on the TV's power and switch the input.

See the TV's operating instructions for the details of operating the TV.

2 Turn on the player's power.

Press **⏻ STANDBY/ON**.

Check that the **Setup Navigator** menu is displayed.

❖ If the Setup Navigator menu is not displayed

▶ Press **🏠 HOME MENU** to display the Home Menu, select **Initial Setup** → **Setup Navigator** → **Start**, then press **ENTER**.

3 Start Setup Navigator.

Press **ENTER**.

- **Setup Navigator** starts.

4 Select the OSD language.

Use **↑/↓** to select, then press **ENTER**.

When a Pioneer Flat Screen TV that is compatible with Control function is connected to this player's **HDMI OUT** terminal, language settings are imported from the Pioneer Flat Screen TV's language settings before **Setup Navigator** begins.

5 Select the appropriate output resolution for the connected TV.

Use **↑/↓** to select, then press **ENTER**.

6 Select the appropriate aspect for the connected TV.

Use **↑/↓** to select, then press **ENTER**.

7 Close the Setup Navigator menu.

Press **ENTER**.

- **Setup Navigator** finishes and the setting is stored.
- Press **↶ RETURN** to go back to the previous screen.

Operating the TV with the player's remote control

When the manufacturer code for your brand of TV is set on the player's remote control, the TV can be operated using the player's remote control.

! Caution

- For some models it may not be possible to operate the TV with the player's remote control, even for TVs of brands listed on the manufacturer code list.
- The setting may be restored to the default after the batteries are replaced. If this happens, reset it.

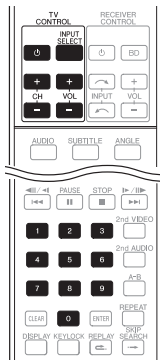

1 Input the 2-digit manufacturer code.

Press the number buttons (0 to 9) to input the code while pressing **TV CONTROL** ϕ .

📝 Note

- The factory default setting is 00 (PIONEER).
- If you make a mistake when inputting the code, release **TV CONTROL** ϕ then start over from the beginning.
- When there are multiple codes for a manufacturer, try inputting them in the indicated order until the TV can be operated.

2 Check that the TV can be operated.

Operate the TV using **TV CONTROL**.

ϕ – Press to turn the TV's power on and off.

INPUT SELECT – Press to switch the TV's input.

CH +/- – Press to select the TV channel.

VOL +/- – Press to adjust the volume.

TV Preset code list

Manufacturer Code(s)

PIONEER 00, 31, 32, 07, 36, 42, 51, 22	GPM 41
ACURA 44	GRAETZ 31, 42
ADMIRAL 31	GRANADA 07, 35, 42, 43, 48
AIWA 60	GRADIENTE 30, 57
AKAI 32, 35, 42	GRANDIN 18
AKURA 41	GRUNDIG 31, 53
ALBA 07, 39, 41, 44	HANSEATIC 07, 42
AMSTRAD 42, 44, 47	HCM 18, 44
ANITECH 44	HINARI 07, 41, 44
ASA 45	HISAWA 18
ASUKA 41	HITACHI 31, 33, 34, 36, 42, 43, 54, 06, 10, 24, 25, 18
AUDIOGRAPH 07, 36	HUANYU 56
BASIC LINE 41, 44	HYPSON 07, 18, 46
BAUR 31, 07, 42	ICE 46, 47
BEKO 38	IMPERIAL 38, 42
BEON 07	INDIANA 07
BLAUPUNKT 31	INGELN 31
BLUE SKY 41	INTERFUNK 31, 32, 07, 42
BLUE STAR 18	INTERVISION 46, 49
BPL 18	ISUKAI 41
BRANDT 36	ITC 42
BTC 41	ITT 31, 32, 42
BUSH 07, 41, 42, 44, 47, 56	JEC 05
CASCADE 44	JVC 13, 23
CATHAY 07	KAISUI 18, 41, 44
CENTURION 07	KAPSCH 31
CGB 42	KENDO 42
CIMLINE 44	KENNEDY 32, 42
CLARIVOX 07	KORPEL 07
CLATRONIC 38	KOYODA 44
CONDOR 38	LEYCO 07, 40, 46, 48
CONTEC 44	LIESEN&TTER 07
CROSLEY 32	LOEWE 07
CROWN 38, 44	LUXOR 32, 42, 43
CRYSTAL 42	M-ELECTRONIC 31, 44, 45, 54, 56, 07, 36, 51
CYBERTRON 41	MAGNADYNE 32, 49
DAEWOO 07, 44, 56	MAGNAFON 49
DAINICHI 41	MAGNAVOX 07, 10, 03, 12, 29
DANSAI 07	MANESTH 39, 46
DAYTON 44	MARANTZ 07
DECCA 07, 48	MARK 07
DIXI 07, 44	MATSUI 07, 39, 40, 42, 44, 47, 48
DUMONT 53	MCMICHAEL 34
ELIN 07	MEDIATOR 07
ELITE 41	MEMOREX 44
ELTA 44	METZ 31
EMERSON 42	MINERVA 31, 53
ERRES 07	MITSUBISHI 09, 10, 02, 21, 31
FERGUSON 07, 36, 51	MULTITECH 44, 49
FINLANDIA 35, 43, 54	NEC 59
FINLUX 32, 07, 45, 48, 53, 54	NECKERMANN 31, 07
FIRSTLINE 40, 44	NEI 07, 42
FISHER 32, 35, 38, 45	NIKKAI 05, 07, 41, 46, 48
FORMENTI 32, 07, 42	NOBLIKO 49
FRONTTECH 31, 42, 46	NOKIA 32, 42, 52
FRONTTECH/PROTECH 32	NORDMENDE 32, 36, 51, 52
FUJITSU 48	OCEANIC 31, 32, 42
FUNAI 40, 46, 58	ORION 32, 07, 39, 40
GBC 32, 42	OSAKI 41, 46, 48
GE 00, 01, 08, 07, 10, 11, 17, 02, 28, 18	OSO 41
GEC 07, 34, 48	OSUME 48
GELOSO 32, 44	OTTO VERSAND 31, 32, 07, 42
GENERAL 29	PALLADIUM 38
GENEXXA 31, 41	PANAMA 46
GOLDSTAR 10, 23, 21, 02, 07, 50	PANASONIC 31, 07, 08, 42, 22
GOODMANS 07, 39, 47, 48, 56	PATHO CINEMA 42
GORENJE 38	PAUSA 44

PHILCO 32, 42
PHILIPS 31, 07, 34, 56, 68
PHOENIX 32
PHONOLA 07
PROFEX 42, 44
PROTECH 07, 42, 44, 46, 49
QUELLE 31, 32, 07, 42, 45, 53
R-LINE 07
RADIOLA 07
RADIOHACK 10, 23, 21, 02
RBM 53
RCA 01, 10, 15, 16, 17, 18, 61, 62, 09
REDIFFUSION 32, 42
REX 31, 46
ROADSTAR 41, 44, 46
SABA 31, 36, 42, 51
SAISHO 39, 44, 46
SALORA 31, 32, 42, 43
SAMBERS 49
SAMSUNG 07, 38, 44, 46, 69, 70
SANYO 35, 45, 48, 21, 14, 91
SBR 07, 34
SCHAUB LORENZ 42
SCHNEIDER 07, 41, 47
SEG 42, 46
SEI 32, 40, 49
SELECO 31, 42
SHARP 02, 19, 27, 67, 90
SIAREM 32, 49
SIEMENS 31
SINUDYNE 32, 39, 40, 49
SKANTIC 43
SOLAVOX 31
SONOKO 07, 44
SONOLOR 31, 35
SONTEC 07
SONY 04
SOUNDWAVE 07
STANDARD 41, 44
STERN 31
SUSUMU 41
SYSLINE 07
TANDY 31, 41, 48
TASHIKO 34
TATUNG 07, 48
TEC 42
TELEAVIA 36
TELEFUNKEN 36, 37, 52
TELETECH 44
TENSAI 40, 41
THOMSON 36, 51, 52, 63
THORN 31, 07, 42, 45, 48
TOMASHI 18
TOSHIBA 05, 02, 26, 21, 53
TOWADA 42
ULTRAVOX 32, 42, 49
UNIDEN 92
UNIVERSUM 31, 07, 38, 42, 45, 46, 54
VESTEL 07
VICTOR 13
VOXSON 31
WALTHAM 43
WATSON 07
WATT RADIO 32, 42, 49
WHITE WESTINGHOUSE 07
YOKO 07, 42, 46
ZENITH 03, 20

Chapter 4 Playback

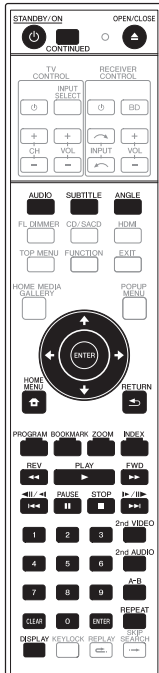

- When a BD with usage restrictions set by a BD recorder is loaded, the PIN code input screen appears. In this case, input your PIN code.

3 Press ► **PLAY** to play the disc.

- To pause, press **II PAUSE** during playback.
- To stop, press **■ STOP** during playback.

Note

- Some discs start playing automatically when the disc tray is closed.
- DVD-Video discs have parental lock features. Input the password registered in the player's settings to unlock the parental lock. For details, see page 46.

❖ **If the disc menu is displayed**

For some discs, the disc menu is displayed automatically when playback starts. The contents of the disc menu and the way to operate depend on the disc.

❖ **Resuming playback from where it was stopped (resume playback function)**

- When **■ STOP** is pressed during playback, the point at which the disc stopped is stored in the memory. When **► PLAY** is pressed after that, playback resumes from that point.
- To cancel the resume playback function, press **■ STOP** while playback is stopped.

Note

- The resume playback function is canceled automatically in the following cases:
 - When the disc tray is opened.
 - When the file list window is switched.
 - When the power is turned off. (For BDs and DVDs this does not cancel the resume playback function.)
- When you want to continue playback from a position you specify to be played next time, see *Continuing playback from a specified position (Continued Viewing Playback)* on page 33.
- The resume playback function cannot be used for some discs.

Playing discs or files

This section describes the player's main operations.

For the types of discs and files that can be played, see page 7. Video, image and audio files recorded on discs are played with the Home Media Gallery (page 34).

1 Press **⏻ STANDBY/ON** to turn on the power.

Turn the TV's power on and switch its input beforehand.

2 Press **⏏ OPEN/CLOSE** to open the disc tray and load the disc.

Note

- Load the disc with the printed side facing up.
- Several dozen seconds are required to read the disc. Once reading is completed, the type of disc is displayed on the player's front panel display.



Forward and reverse scanning

- ▶ **During playback, press ◀◀REV or ▶▶FWD.**
 - The scanning speed switches each time the button is pressed. The speed steps depend on the disc or file (the speed is displayed on the TV screen).

❖ To resume normal playback

- ▶ Press ▶ **PLAY**.

Playing specific chapters or tracks

- ▶ **Input the number of the title, chapter or track you want to play.**

- Use the number buttons (0 to 9) to input the number, then press **ENTER**.
- Press **CLEAR** to clear the values you have input.

Skipping content

- ▶ **During playback, press I◀◀ or ▶▶I.**
 - When ▶▶I is pressed, the playback skips ahead to the beginning of the next chapter/track/file.
 - When I◀◀ is pressed while a video or audio file is playing, the playback skips back to the beginning of the currently playing chapter/track/file. Press twice to skip back to the beginning of the previous chapter/track/file.
 - When I◀◀ is pressed while an image file is playing, playback returns to the previous file.

Playing in slow motion

- ▶ **While playback is paused, press and hold ◀||/◀I or I||/I▶.**
 - The speed switches each time the button is pressed (the speed is displayed on the TV screen).

❖ To resume normal playback

- ▶ Press ▶ **PLAY**.

Step forward and step reverse

- ▶ **While playback is paused, press ◀||/◀I or I||/I▶.**
 - The picture moves a step forward or reverse each time the button is pressed.

❖ To resume normal playback

- ▶ Press ▶ **PLAY**.

Playing a specific section within a title or track repeatedly (A-B Repeat)

Use this procedure to play a specific section within a title or track repeatedly.

1 During playback, press A-B to select the starting point.

- A- is displayed on the TV screen.

2 During playback, press A-B to select the ending point.

- A-B Repeat playback starts.

❖ To cancel A-B Repeat play

- Press **A-B** during the A-B Repeat play.



Note

- A-B Repeat play is canceled in the following cases:
 - When you search outside of the repeat range.
 - When you start other Repeat Play or Random Play.

Playing repeatedly (Repeat Play)

Use this procedure to play the currently playing disc, title, chapter, track or file repeatedly.

- ▶ **During playback, press REPEAT.**

- Each time you press **REPEAT** the type of repeat modes changes as shown below.

BD

Current chapter → Current title

DVD

Current chapter → Current title → All titles

CD/Video file/Audio file/Image file

Current track/file → All titles

❖ To cancel Repeat Play

- Press **REPEAT** several times during Repeat Play.



Note

- Repeat Play is canceled in the following cases:
 - When you search outside the repeat range.
 - When you start other Repeat Play or Random Play.

Playing in the desired order (Programmed Play)

- 1 **During playback, press PROGRAM.**
 - The program screen is displayed.

- 2 **Select the program number.**
Use **↑/↓** to select, then press **ENTER**.

- 3 **Select the title you want to play.**
Use **↑/↓** to select, then press **→**.

- 4 **Select the chapter you want to play.**
Use **↑/↓** to select, then press **ENTER**.

- 5 **Press ► PLAY.**
 - Playback starts.

❖ Editing the program

- 1 **Select the program number you want to edit, then press ENTER.**
- 2 **Select title/chapter, then press ENTER.**

❖ Deleting the program

- ▶ **Select the program number you want to delete, then press CLEAR.**
 - To delete all the programs, press **↩ RETURN**.

Note

- When you use audio CDs for Programmed Play, enter the track number in step 3.
- This function does not work with BDs.

Making bookmarks

You can make bookmarks on the video currently playing and play back the scene later.

- ▶ **During playback, press BOOKMARK.**
 - The bookmark is made.
 - Maximum number of bookmarks are 12.

❖ Playing the bookmarked scene

- 1 **Press and hold BOOKMARK for a few seconds.**
 - The list of bookmarks is displayed.
- 2 **Select the bookmark you want to play.**
Use **←/→** to select, then press **ENTER**.

❖ Deleting the bookmark

- ▶ **Select the bookmark you want to delete, then press CLEAR.**
 - Bookmarks may not be allowed to make for some discs.
 - Bookmarks are canceled in the following cases:
 - When the player's power turned off.
 - When the disc tray is opened.

Zoom

- ▶ **During playback, press ZOOM.**
 - Each time you press **ZOOM**, the zoom level changes as shown below.
Zoom 2x → Zoom 3x → Zoom 4x → Zoom 1/2x → Zoom 1/3x → Zoom 1/4x → Normal (not displayed)

Note

- This function does not work with some discs.

Displaying thumbnail images

Displaying the thumbnails of the image files on the disc.

- ▶ **During playback, press INDEX.**
 - Display the thumbnail of image files. The maximum number is 12 at once.
 - If you select one of the image and press **ENTER**, slideshow will start from the image you selected.

Switching the camera angles

For BD-ROM and DVD-Video discs on which multiple angles are recorded, the angles can be switched during playback.

- ▶ **During playback, press ANGLE.**
 - The current angle and total number of recorded angles are displayed on the TV screen. To switch the angles, press **ANGLE** again.
 - The angles can also be switched by selecting **Angle** from the **FUNCTION** menu.
 - If the angles are not switched when **ANGLE** is pressed, switch them from the disc menu screen.

Switching the subtitles

For discs or files on which multiple subtitles are recorded, the subtitles can be switched during playback.

Caution

- The subtitles cannot be switched for discs recorded by a DVD or BD recorder. Also refer to the operating instructions for the device used for recording.
- ▶ **During playback, press SUBTITLE.**
 - The current subtitle and total number of recorded subtitles are displayed on the TV screen. To switch the subtitle, press **SUBTITLE** again.
 - The subtitles can also be switched by selecting **Subtitle** from the **FUNCTION** menu.
 - If the subtitles are not switched when **SUBTITLE** is pressed, switch them from the disc menu screen.

❖ Turning the subtitles off

- ▶ **Press SUBTITLE several times or select Subtitle from the FUNCTION menu to switch the setting to Off.**

❖ About displaying external subtitle files while playing DivX media files

In addition to the subtitles recorded in DivX media files, this player also supports the display of external subtitle files. If a file has the same name as that of a DivX media file aside from the file extension and the extension is one of the extensions listed below, the file is treated as an external subtitle file. Note that DivX media files and external subtitle files must be located in the same folder. Only one external subtitle file can be displayed on this player. Use a computer, etc., to delete any external subtitle files you do not want to display from the disc.

.srt, .sub, .txt, .smi, .ssa, .ass

If the language code is specified for the external subtitle file, the subtitles are displayed with the font corresponding to that language code. If no language code is specified, the subtitles are displayed with the font corresponding to the language code set at Subtitle Language (page 42). The same font is used for all the languages in each of the groups below.

Group 1	Afrikaans(af/af), Basque(eu/eus), Catalan(ca/cat), Danish(da/dan), Dutch(nl/nld), English(en/eng), Faroese(fo/fao), Finnish(fi/fin), French(fr/fra), Galician(gl/glg), German(de/deu), Guarani(gn/grn), Icelandic(is/isl), Irish(ga/gle), Italian(it/ita), Latin(la/lat), Norwegian(no/nor), Portuguese(pt/por), Rhaeto-Romance(rm/roh), Scots-Gaelic(gd/gla), Spanish(es/spa), Swahili(sw/swa), Swedish(sv/swe), Zulu(zu/zul)
Group 2	Albanian(sq/sqi), Croatian(hr/hrv), Czech(cs/ces), Hungarian(hu/hun), Polish(pl/pol), Romanian(ro/ron), Slovak(sk/slk), Slovenian(sl/slv)

Group 3	Belarusian(be/bel), Bulgarian(bg/bul), Macedonian(mk/mkd), Moldavian(mo/mol), Russian(ru/rus), Serbian(sr/srp), Ukrainian(uk/ukr)
Group 4	Greek(el/ell)
Group 5	Estonian(et/est), Kurdish(ku/kur), Turkish(tr/tr)

Note

- Depending on the file, the external subtitles may not be displayed properly.

Displaying the disc information

▶ Press DISPLAY.

The disc information appears on the TV screen. To switch off the information display, press **DISPLAY** again.

The information display differs between during playback and when playback is stopped.

Switching the audio and secondary audio

For discs or files on which multiple audio streams/channels are recorded, audio streams/channels can be switched during playback. Also use this procedure to switch the secondary audio for BD-ROMs on which secondary audio is recorded.

▶ During playback, press AUDIO/2nd AUDIO.

- The current audio and total number of recorded audio streams are displayed on the TV screen. To switch the audio, press **AUDIO/2nd AUDIO** again.
- The audio/secondary audio can also be switched by selecting **Audio** or **Secondary Audio** from the **FUNCTION** menu.
- If the audio/secondary audio is not switched when **AUDIO/2nd AUDIO** is pressed, switch it from the disc menu screen.

❖ Turning the Secondary Audio off

- ▶ **Press 2nd AUDIO several times or select Secondary Audio from the FUNCTION menu to switch the setting to Off.**

Switching the secondary video

Use the procedure below to switch the secondary video (Picture-in-Picture) recorded on the BD-ROM.

► During playback, press 2nd VIDEO.

- The current secondary video and total number of recorded secondary video streams are displayed on the TV screen.

To switch the secondary video, press **2nd VIDEO** again.



Primary audio/video

Secondary audio/video

- The secondary video can also be switched by selecting **Secondary Video** from the **FUNCTION** menu.
- If the secondary video is not switched when **2nd VIDEO** is pressed, switch it from the disc menu screen.

❖ Turning the Secondary Video off

- Press **2nd VIDEO** several times or select **Secondary Video** from the **FUNCTION** menu to switch the setting to **Off**.

Enjoying BONUSVIEW or BD-LIVE

This player is compatible with BD-Video BONUSVIEW and BD-LIVE.

When using BD-Video discs compatible with BONUSVIEW, you can enjoy such functions as secondary video (picture in picture) (above) and secondary audio (page 29). With BD-Video discs supporting BD-LIVE, special video images and other data can be downloaded from the Internet.

Data recorded on BD video and downloaded from BD-LIVE is stored on the USB memory device (external memory). To enjoy these functions, connect a USB memory device (minimum 1 GB capacity, 2 GB or greater recommended) supporting USB 2.0 High Speed (480 Mbit/s) to the USB port.

- When you insert or remove a USB memory device, be sure to turn the player's power off.
- To recall data stored in the USB memory device, first insert the disc media that was being used at the time the data was downloaded (if a different disc is loaded, the data stored on the USB memory device cannot be played).

- If a USB memory device containing other data (previously recorded) is used, the video and audio may not play back properly.
- Do not disconnect the USB memory device while playback is in progress.
- Some time may be required for the data to load (read/write).

⚠ Caution

- It may not be possible to use the BONUSVIEW and BD-LIVE functions if there is insufficient space on the USB memory device. In this case, refer to *Erasing data that has been added to BDs and application data* on page 45 for erasing the Virtual Package data and the BD-LIVE data in the USB memory device.

📝 Note

- Operation of USB memory devices is not guaranteed.
- Playback of BD-LIVE function data differs depending on the disc used. For details, consult the user instructions supplied with the disc.
- To enjoy the BD-LIVE function, a network connection and settings are required (pages 21 and 44).
- BD-LIVE is a function that provides for connection to the Internet. Discs supporting the BD-LIVE function may send ID codes identifying this player and the disc to the contents provider via the Internet.

Playback functions

The functions that can be used differ according to the type of disc and file. In some cases, some of the functions cannot be used. Check the usable functions on the table below.

Function ¹	Disc/file type										
	BD-ROM	BD-R /-RE	DVD-Video	DVD-Audio ²	DVD-R /-RW (VR format)	AVCREC	AVCHD	Video file	Image file	Audio file	Audio CD
Forward and reverse scanning ³	✓ ⁴	✓ ⁴	✓ ⁴	✓ ⁴	✓ ⁴	✓ ⁴	✓ ⁴	✓ ⁴	✗	✓ ⁵	✓ ⁵
Playing specific titles, chapters or tracks	✓	✓	✓	✓	✓	✓	✓	✗	✗	✗	✓
Skipping content	✓	✓	✓	✓	✓	✓	✓	✓	✓	✓	✓
Slow motion play ^{3,6}	✓	✓	✓	✗	✓	✓	✓	✓ ⁷	✗	✗	✗
Step forward and step reverse ³	✓	✓	✓	✗	✓	✓	✓	✓ ⁸	✗	✗	✗
A-B Repeat play ³	✓	✓	✓	✓	✓	✓	✓	✓	✗	✓	✓
Repeat Play	✓	✓	✓	✓	✓	✓	✓	✓	✓	✓	✓
Zoom	✓	✓	✓	✗	✓	✓	✓	✓	✓	✗	✗
Angle ⁹	✓	✗	✓	✓	✗	✗	✗	✗	✗	✗	✗
Subtitle ¹⁰	✓	✓	✓	✗	✓	✓	✓	✓	✗	✗	✗
Audio ¹¹	✓	✓	✓	✓	✓	✓	✓	✓	✗	✗	✗
Secondary audio ¹²	✓ ¹³	✗	✗	✗	✗	✗	✗	✗	✗	✗	✗
Secondary video ¹⁴	✓ ¹⁵	✗	✗	✗	✗	✗	✗	✗	✗	✗	✗
Disc information	✓	✓	✓	✓	✓	✓	✓	✓	✓	✓	✓

1. Some functions may not work for some discs or files, even if indicated [✓] on the table.

2. Except BDP-140.

3. For some discs, normal playback resumes automatically when the chapter switches.

4. No sound is produced during forward and reverse scanning.

5. Sound is produced during forward and reverse scanning.

6. • No sound is output during slow motion playback.
• It is not possible to switch the speed during reverse slow motion playback.

7. Reverse slow motion playback is not possible.

8. Reverse step playback is not possible.

9. Angle mark is displayed for scenes at which multiple angles are recorded if **Angle Mark** is set to **On** (page 42).

10. • The types of recorded subtitles depend on the disc and file.

• In some cases, the subtitle may switch or the switching screen provided on the disc may be displayed immediately, without the current subtitle or the total number of subtitles recorded on the disc being displayed.

11. The types of recorded audio streams depend on the disc and file.

12. • The types of recorded secondary audio streams depend on the disc and file.

• In some cases, the secondary audio may switch or the switching screen provided on the disc may be displayed immediately, without the current secondary audio or the total number of secondary audio streams recorded on the disc being displayed.

• Secondary audio mark is displayed for scenes at which secondary audio is recorded if **Secondary Audio Mark** is set to **On** (page 42).

13. Some discs do not include secondary audio.

14. • In some cases, the secondary video may switch or the switching screen provided on the disc may be displayed immediately, without the current secondary video or the total number of secondary video streams recorded on the disc being displayed.

• Secondary video mark is displayed for scenes at which secondary video is recorded if **PIP Mark** is set to **On** (page 42).

15. Some discs do not include secondary video.

Using the FUNCTION menu

Various functions can be called out according to the player's operating status.

1 Display the FUNCTION menu.

Press **FUNCTION** during playback.

2 Select and set the item.

Use **↑/↓** to select, then press **ENTER**.



Note

- Items that cannot be changed are displayed in gray. The items that can be selected depend on the player's status.

❖ To change the setting of the selected item

Use **↑/↓** to change.

❖ To close the FUNCTION menu

Press **FUNCTION**.

❖ FUNCTION menu item list

Item	Description
Video Adjust (BDP-LX55)	Display the picture quality adjustment screen (page 44).
Title	Display the title information for the currently playing disc and total number of titles on the disc. Also select the title you want to play. (See the following description.)
Chapter (track/file)	Display the information for the currently playing chapter (track/file) and total number of chapters in the disc. Also select the chapter (track/file) you want to play. (See the following description.)
Time	Display the elapsed or remaining time. Also enter the time from which you want to start playback. (See the following description.)
Play Mode	Switch the play mode (page 33).
Audio	Switch the audio.
Angle	Switch the BD-ROM/DVD-Video disc's camera angle.
Subtitle	Switch the subtitle language.
Code Page	Switch the subtitle code page.
Second Video	Switch the BD-ROM's secondary video (Picture-in-Picture) (page 30).
Second Audio	Switch the BD-ROM's secondary audio (page 29).
Bitrate	Display the bitrate of the audio/video/secondary video/secondary audio.
Still off	Switch off the BD-ROM's still picture.
Ins Search	Skip forward 30 seconds.

Item	Description
Ins Replay	Skip backward 10 seconds.
Slide Show	Switch the playback speed while playing the picture slide show.
Transition	Change the style of the slide show while playing the picture slide show.

* The items shown on the **FUNCTION** menu depend on the type of the disc.



Note

- Selectable items depend on the type of disc.

Playing from a specific time (Time Search)

1 Select Time.

Use **↑/↓** to select, then press **ENTER**.

2 Input the time.

Use the number buttons (0 to 9) to input the time.

- To play from 45 minutes, input **0, 0, 4, 5, 0** and **0**, then press **ENTER**.
- To play from 1 hour 20 minutes, input **0, 1, 2, 0, 0** and **0**, then press **ENTER**.
- Press **CLEAR** to clear the values you have input.

3 Starting playback from the specified time.

Press **ENTER**.

Playing a specific title, chapter or track (Search)

1 Select Title or Chapter (track/file).

Use **↑/↓** to select, then press **ENTER**.

2 Input the Title or Chapter (track/file) number.

Use the number buttons (0 to 9) or **↑/↓** to input the number.

- To search for title 32, input **3** and **2**, then press **ENTER**.
- Press **CLEAR** to clear the values you have input.

3 Starting playback from the specified title, chapter or track.

Press **ENTER**.

Playing specified range of discs, titles or chapter (track/file) in random order

You can select from 2 types of random playback.

1 Select Play Mode.

Use **↑/↓** to select, then press **ENTER**.

2 Select the playing mode.

Use **↑/↓** to select, then press **ENTER**.

❖ Random play

The specified range of discs, titles or chapter (track/file) is played in random order. The same item may be played consecutively.

❖ Shuffle play

The specified range of discs, titles or chapter (track/file) is played in random order. Each item is played once.

Continuing playback from a specified position (Continued Viewing Playback)

This function allows you to continue playback from a position you specify to be played next time, even after turning the power off.

❖ Setting

▶ During playback, press **CONTINUED** at the position from which you want to start continued viewing playback.

The elapsed playing time at the specified position is displayed on the TV screen.

❖ Playing

1 Press **▶ PLAY** to play the title for which you have set continued viewing playback.

The **FUNCTION** menu screen appears automatically to show the point (time) when you pressed **CONTINUED**.

- The Function control screen can also be displayed by pressing **FUNCTION** during playback.

2 Press **ENTER**, then select the specified continued viewing playback time.

Playback starts from the specified position.



Note

- The continued viewing playback setting is canceled when **▲ OPEN/CLOSE** is pressed.
- Continued viewing playback may not work properly with some discs.

Playback from Home Media Gallery

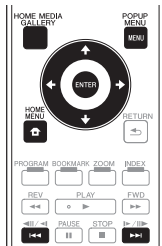

About Home Media Gallery



This player's Home Media Gallery function allows you to display a list of input sources and start playback. This chapter describes setup and playback procedures required to enjoy these features. When you play the files stored on your computer or the components on the network, it is advisory that you also refer to the operation manual supplied with your network component.

The input sources that can be played from Home Media Gallery are as shown below.

- BD-R/RE (BD-RE format) discs
- DVD-R/RW (VR format) discs
- Audio CDs (CD-DA, SACD and DTS CDs)
- DVD/CDs on which only data files of video, image or audio files, etc. are recorded.
- USB memory device
- Files on the network servers (on the PCs or components connected to the player via LAN interface.)



Note

- The Home Media Gallery allows you to play files on media servers connected on an identical Local Area Network (LAN) as the receiver.

- The following files are allowed to be played from Home Media Gallery:
 - PCs running Microsoft Windows Vista or XP with Windows Media Player 11 installed
 - PCs running Microsoft Windows 7 with Windows Media Player 12 installed
 - DLNA-compatible digital media servers (on PCs or other components)
 - Files stored in a PC or DMS (Digital Media Server) as described above can be played by Digital Media Player (DMP).
The player supports the use of such DMP.
- To play back audio files stored on components on the network, you must turn on the DHCP server function of your router. In case your router does not have the built-in DHCP server function, it is necessary to set up the network manually. Otherwise, you cannot play back files stored on components on the network. See page 44.

About network playback

The network playback function of this unit uses the following technologies:

❖ Windows Media Player

See Windows Media Player 11/Windows Media Player 12 above for more on this.

❖ Windows Media DRM

Microsoft Windows Media Digital Rights Management (WMDRM) is a platform to protect and securely deliver content for playback on computers, portable devices and network devices. Home Media Gallery functions as a WMDRM 10 for networked devices. WMDRM protected content can only be played on media servers supporting WMDRM.

Content owners use WMDRM technology to protect their intellectual property, including copyrights. This device uses WMDRM software to access WMDRM protected content. If the WMDRM software fails to protect the content, content owners may ask Microsoft to revoke the software's ability to use WMDRM to play or copy protected content. Revocation does not affect unprotected content. When you download licenses for protected content, you agree that Microsoft may include a revocation list with the licenses. Content owners may require you to upgrade WMDRM to access their content. If you decline an upgrade, you will not be able to access content that requires the upgrade. This product is protected by certain intellectual property rights of Microsoft. Use or distribution of such technology outside of this product is prohibited without a license from Microsoft.



DLNA CERTIFIED® Audio Player

The Digital Living Network Alliance (DLNA) is a cross-industry organization of consumer electronics, computing industry and mobile device companies. Digital Living provides consumers with easy sharing of digital media through a wired or wireless network in the home.

The DLNA certification logo makes it easy to find products that comply with the DLNA Interoperability Guidelines. This unit complies with DLNA Interoperability Guidelines v1.5. When a PC running DLNA server software or a DLNA compatible device is connected to this player, some setting changes of software or other devices may be required. Please refer to the operating instructions for the software or device for more information.

DLNA®, the DLNA Logo and DLNA CERTIFIED® are trademarks, service marks, or certification marks of the Digital Living Network Alliance.

❖ Content playable over a network

- Even when encoded in a compatible format, some files may not play correctly.
- Some functions may not be supported depending on the server type or version used.
- Supported file formats vary by server. As such, files not supported by your server are not displayed on this unit. For more information check with the manufacturer of your server.

❖ Disclaimer for Third Party Content

Access to content provided by third parties requires a high speed Internet connection and may also require account registration and a paid subscription.

Third party content services may be changed, suspended, interrupted, or discontinued at any time without notice, and Pioneer disclaims any liability in connection with such occurrences.

Pioneer does not represent or warrant that content services will continue to be provided or available for a particular period of time, and any such warranty, express or implied, is disclaimed.

❖ About playback behavior over a network

- Playback may stall when the PC is switched off or any media files stored on it are deleted while playing content.
- If there are problems within the network environment (heavy network traffic, etc.) content may not be displayed or played properly (playback may be interrupted or stalled). For best performance, a 10BASE-T/100BASE-TX connection between the player and the PC is recommended.
- If several clients are playing simultaneously, as the case may be, playback is interrupted or stalled.
- Depending on the security software installed on a connected PC and the setting of such software, network connection may be blocked.

Pioneer is not responsible for any malfunction of the player and/or the Home Media Gallery features due to communication errors/malfunctions associated with your network connection and/or your PC, or other connected equipment. Please contact your PC manufacturer or Internet service provider.

Windows Media is either a registered trademark or trademark of Microsoft Corporation in the United States and/or other countries.

This product includes technology owned by Microsoft Corporation and cannot be used or distributed without a license from Microsoft Licensing, Inc.

Microsoft®, Windows®7, Windows®Vista, Windows®XP, Windows®2000, Windows®Millennium Edition, Windows®98, and WindowsNT® are either registered trademarks or trademarks of Microsoft Corporation in the United States and/or other countries.

DLNA Search

Playing back the files stored on the components connected to the player via network.

1 Press HOME MEDIA GALLERY to display the Home Media Gallery.

The Home Media Gallery can also be displayed by selecting Home Media Gallery from Home Menu, then pressing **ENTER**.

2 Select DLNA Search.

Use **↑/↓** to select, then press **ENTER**.

3 Select the server which contains the file you want to play.

4 Select the file you want to play.

Use **↑/↓** to select, then press **ENTER**.



Note

- This player does not support DTCP-IP. Recorded files and contents that are protected by digital copyright protection cannot be played via LAN interface.

Disc/USB playback

1 Press HOME MEDIA GALLERY to display the Home Media Gallery.

The Home Media Gallery can also be displayed by selecting Home Media Gallery from Home Menu, then pressing **ENTER**.

2 Select Disc or USB.

Use **↑/↓** to select, then press **ENTER**.

3 Select Photo/Music/Video/AVCHD.

Use **↑/↓** to select, then press **ENTER**.

- This step is not for the discs that have been recorded with BDAV/VR/AVCREC format.
- To play files in AVCHD format on a USB memory device, create a folder named "AVCHD" on the USB memory device, then copy the "BDMV" folder containing which the files to be played into the "AVCHD" folder.

4 Select the title/track or file you want to play.

Use **↑/↓** to select, then press **ENTER**.

Playback starts from the selected title/track or file.

- If the file you want to play is in the folder, select the folder that contains the file first.

Playing back image files

❖ About Slideshow

A display of the files on the disc or in the folder switches automatically.



Note

- When playing an audio CD (CD-DA/SACD/DTS-CD), the Now Playing screen is displayed.
- Some BD-R/-RE discs have playback protection. To cancel the protection, input the password set for the disc.
- It may take a few seconds before playback starts. This is normal.
- It may not be possible to play some files properly.
- The number of views may be restricted.

Playing in the desired order (Playlist)

The discs that can add tracks and files to the **Playlist** are as shown below.

- DVDs/CDs/USB memory devices on which audio files are recorded

Adding tracks/files

Use this procedure to add tracks and files, and create the **Playlist**.

1 Press HOME MEDIA GALLERY to display the Home Media Gallery.

The Home Media Gallery can also be displayed by selecting Home Media Gallery from Home Menu, then pressing **ENTER**.

2 Select Disc or USB.

Load the disc beforehand.

Use **↑/↓** to select, then press **ENTER**.

3 Select the track/file to be added.

Use **→** to select.

4 Press POP UP MENU to display the POP UP MENU menu.

5 Select Add to Playlist to add to Playlist.

Use **↑/↓** to select, then press **ENTER**.

The track or file selected in step 3 is added to the **Playlist**.

- To add more tracks or files, repeat steps 3 to 5.

Playing the Playlist

1 Press HOME MEDIA GALLERY to display the Home Media Gallery.

The Home Media Gallery can also be displayed by selecting Home Media Gallery from Home Menu, then pressing **ENTER**.

2 Select Playlist.

Use **↑/↓** to select, then press **ENTER**.

3 Select the track/file to be played.

Use **↑/↓** to select, then press **ENTER**.

Playback starts from the selected track/file and continues until the end of the list is reached. Use **◀◀/▶▶** to play the previous or next track/file. The Now Playing screen is displayed.

Deleting tracks/files from the Playlist

1 Select the track/file to be deleted, then press POP UP MENU to display the POP UP MENU menu.

2 Use **↑/↓** to select Delete from Playlist, then press **ENTER**.

Playing the web contents

You can enjoy some streaming contents on the Internet with the player.

Available web contents

- YouTube (MPEG4 AVC H.264)
- Picasa



Note

About YouTube

- YouTube videos of the following sizes can be played.
 - Standard quality (400 x 226 pixels, 200 kbps)
 - Medium quality (480 x 360 pixels, 512 kbps)
 - High quality (854 x 480 pixels, 900 kbps)
 - HD (720p) (1280 x 720 pixels, 2 Mbps)
 - HD (1080p) (1920 x 1080 pixels, 4 Mbps)
- This player supports the YouTube Leanback service. The Youtube Leanback service is only available in English for now. Refer to YouTube Help at <http://www.google.com/support/youtube/> for further information.
- YouTube videos for mobile phones cannot be played.
- Some YouTube videos cannot be played.

About Picasa

- Picasa is available only in English. Refer to instructions at <http://picasa.google.com/support/> for details.
 - Register your user name and password on the PC before you use Picasa Web Albums.
 - When you access Picasa from this player for the first time, select the New User icon and enter your registered user name and password.
- Depending on the Internet connection environment, it may not be possible to play web contents properly.
- To access to web contents, this player requires a broadband Internet connection. A contract with an Internet provider is required for a broadband Internet connection.

- Access to content provided by third parties requires a high speed Internet connection and may also require account registration and a paid subscription. Third party content services may be changed, suspended, interrupted, or discontinued at any time without notice, and Pioneer disclaims any liability in connection with such occurrences. Pioneer does not represent or warrant that content services will continue to be provided or available for a particular period of time, and any such warranty, express or implied, is disclaimed.

Playing the items

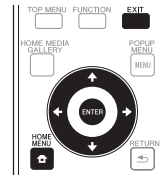

Caution

You must connect the player to the Internet beforehand. See *Connecting to the network through LAN interface* on page 21 for the details.

1 Display the selection screen.

The selection screen can be selected by pressing **HOME MENU** then selecting Web Contents → Desired web content.

2 Select the type of web contents.

Use **↑/↓** to select, then press **ENTER**.

3 Press **↑/↓** to select the item you want to play, then press **ENTER**.

To stop playback, press **EXIT**. Playback of the video stops and the Home Menu screen reappears.

Chapter 7

Advanced settings

Changing the settings

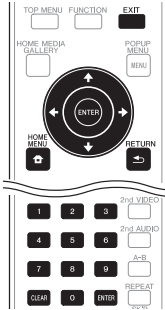

Operating the Initial Setup screen

1 When playback is stopped, display the Home Menu screen.

Press **HOME MENU**.

2 Select and set Initial Setup.

Use **↑/↓** to select, then press **ENTER**.

3 Select the item and change the setting.

Use **↑/↓/←/→** to select, then press **ENTER**.

❖ Closing the Initial Setup screen

Press **HOME MENU** or **RETURN**.



Note

- The items that can be selected depend on the player's status.
- In Options, the factory default settings are indicated in bold.

Setting	Options	Explanation
Display Setting TV Screen	16:9 Full	Select this when connecting to a wide (16:9) TV.
	16:9 Normal	Select this when connected to a wide (16:9) TV. 4:3 pictures are displayed with vertical black bars along the sides.
	4:3 Pan&Scan	Select this when connecting to a 4:3 screen TV and playing a 16:9 video. The video will be played with the left and right sides of the image cut off to display on the 4:3 screen. (This function works if the disc is labeled for 4:3PS.)
	4:3 Letterbox	Select this when connecting to a 4:3 screen TV and playing a 16:9 video. The video will be played with black bands at the top and bottom.
Video Adjust	The quality of the playback picture can be adjusted according to the TV you are using (page 44).	
Stream Smoother (BDP-LX55)	Auto	Select this to automatically correct compressed video files on the network, a disc or a USB memory device and play them with a more natural picture quality.
	Off	
Sharpness (Except BDP-LX55)	High	Choose the level of sharpness.
	Middle	
Video Mode (Except BDP-LX55)	Standard	Choose the video output mode.
	Vivid	
	Cinema	
	Custom	
Noise Reduction (Except BDP-LX55)	0	Choose the level of noise reduction.
	1	
	2	
	3	

Setting	Options	Explanation
Audio Output Digital Output	Bitstream	Select this to output digital audio signals directly.
	PCM	Select this to output digital audio signals converted to PCM audio signals.
	Re-encode	Select this to output digital audio signals converted to DTS Digital Surround.
	Off	Select this to output audio signals other than digital audio signals.
DTS Downmix (BDP-LX55)	Stereo	DTS-HD Master Audio signals, DTS-HD High Resolution Audio signals or DTS Digital Surround audio signals converted to linear PCM audio signals are converted into 2-channel (stereo) signals for output.
	Lt/Rt	DTS-HD Master Audio signals, DTS-HD High Resolution Audio signals or DTS Digital Surround audio signals converted to linear PCM audio signals are converted into 2-channel signals compatible with Dolby Surround for output (when the connected AV receiver or amplifier, etc., is compatible with Dolby Pro Logic, the AV receiver or amplifier outputs the linear PCM audio signals as surround audio signals).
Downsampling	48k	Select this when playing a disc recorded with a sampling frequency of 48 kHz.
	96k	Select this when playing a disc recorded with a sampling frequency of 96 kHz.
	192k	Select this when playing a disc recorded with a sampling frequency of 192 kHz.
DRC (Dynamic Range Control) * Only Dolby digital and analog audio signals are supported.	Off	Select this to output audio signals without using the DRC function.
	On	Select this to adjust the range between the loudest and softest sounds (dynamic range) for playback at average volume. Use this when it is hard to hear dialog or when watching movies at midnight.
	Auto	Select to switch the DRC setting On/Off automatically according to the input audio signal from the disc.

Setting	Options	Explanation	
HDMI	HDMI Mode (BDP-LX55)	Single Select this when an HDMI cable is connected to HDMI OUT (MAIN) terminal only.	
		Separate Select this when HDMI cables are connected to both HDMI OUT terminals.	
		Pure Audio Select this to enjoy music only with a better sound quality when devices are connected to both HDMI output terminals. With this setting, music is output from the HDMI OUT (SUB) terminal only, and video signals are only output from the HDMI OUT (MAIN) terminal when DISPLAY is pressed.	
<i>Also refer to Setting the HDMI Mode (Only for BDP-LX55) on page 16.</i>			
Color Space	RGB	Select this to output the video signals as RGB signals. Choose this if the colors seem too faint and the black seems too bright.	
	YCbCr	Select this to output the video signals as YCbCr 4:4:4 signals.	
	YCbCr 422	Select this to output the video signals as YCbCr 4:2:2 signals.	
	Full RGB	Select this to output the video signals as RGB signals. Choose this if the colors seem too dense and all the dark colors are displayed in a uniform black.	
Resolution	Auto	Select this to choose the resolution of the video signals output from the HDMI OUT terminal automatically.	
	480i/576i (Except BDP-LX55)	Output the video signals from the HDMI OUT terminal with the selected resolution.	
	480P/576P	The resolution can be changed by pressing HDMI , but Auto cannot be selected.	
	720P		
	1080i		
	1080P		
HDMI Audio Out	Bitstream	Select this to output HDMI audio signals directly.	
	PCM	Select this to output HDMI audio signals converted to 2-channel audio signals.	
	Re-encode	Select this to choose the type of audio signals automatically.	
	Off	Select this when you do not want to output the audio signal from the HDMI output terminal.	
Control	On	Select this to control the player with the remote control of the connected AV device using an HDMI cable. Also refer to page 16.	
	Off	Select this when you do not want to control the player with the remote control of the connected AV device using an HDMI cable.	
To use Sound Retriever Link, Stream Smoother Link and PQLS (pages 16 and 17), Control must be set to On .			
HDMI Deep color	30bits	Select this when outputting the video signals with 30-bit color.	
	36bits	Select this when outputting the video signals with 36-bit color.	
	Off	Select this when outputting the video signals with normal 24-bit color.	
HDMI 1080P 24Hz	On	Select this when Resolution is set to Auto or 1080P and outputting 1080p/24 video signals to a TV compatible with 1080p/24.	
	Off	Select this when Resolution is set to 1080P and outputting 1080p/60 video signals to a TV compatible with 1080p/60.	
HDMI 3D	Auto	With 3D discs, the disc is played with 3D images.	
	Off	Even with 3D discs, the disc is played with 2D images.	
3D notice	Yes	This sets whether or not to display the 3D notice when playing 3D images.	
	No		
Network	IP setting	Select this to set the IP address of the player and DNS server (page 44).	
	Proxy Server	Only set the proxy server if so instructed by your Internet service provider (page 44).	
	Information	Displays the values of the MAC address, IP address, subnet mask, default gateway, DNS server (primary) and DNS server (secondary).	
	Connection test	Select this to test the network connection (page 45).	
	Internet Connection	Enable	Select this when connecting to the Internet.
		Disable	Select this when not connecting to the Internet.
	BD-Live connection	Permitted	All discs are allowed to connect to BD-LIVE.
		Partial Permitted	Only discs whose safety has been confirmed are allowed to connect to BD-LIVE.
		Prohibited	No disc is allowed to connect to BD-LIVE.
	DLNA	Enable	Select this when connecting to DLNA server.
Disable		Select this when not connecting to DLNA server.	

	Setting	Options	Explanation
Language	OSD	available languages	Choose a language for the on-screen displays from the listed languages.
	Audio	available languages	Choose a language from the listed languages to set the default audio language for BD-ROM and DVD-Video playback. * For some discs, it may not be possible to change to the selected language.
			If a language not recorded on the BD/DVD is set, one of the recorded languages is automatically selected for playback.
	Subtitle	available languages	Choose a language from the listed languages to set the default subtitle language for BD-ROM and DVD-Video playback. * For some discs, it may not be possible to change to the selected language.
			If a language not recorded on the BD/DVD is set, one of the recorded languages is automatically selected for playback.
	Menu	available languages	Choose a language from the listed languages to set the default language for BD-ROM and DVD-Video menus. * For some discs, it may not be possible to change to the selected language.
		If a language not recorded on the BD/DVD is set, one of the recorded languages is automatically selected for playback.	
Playback	Angle Mark	On	Select this to display the angle mark on the TV screen (page 28). This is the factory default setting for the BDP-440/BDP-140.
		Off	Select this if you do not want to display the angle mark on the TV screen. This is the factory default setting for the BDP-LX55.
	PIP Mark	On	Select this to display the PIP mark on the TV screen. This is the factory default setting for the BDP-440/BDP-140.
		Off	Select this if you do not want to display the PIP mark on the TV screen. This is the factory default setting for the BDP-LX55.
	Secondary Audio Mark	On	Select this to display the secondary audio mark on the TV screen (page 29). This is the factory default setting for the BDP-440/BDP-140.
		Off	Select this if you do not want to display the secondary audio mark on the TV screen. This is the factory default setting for the BDP-LX55.
	DivX(R) VOD DRM	Registration Code	Displays the player's registration code required to play DivX VOD files (page 10).
	DVD Playback	DVD AUDIO	Select this to play only the audio part on the DVD-Audio disc.
		DVD VIDEO	Select this to play only the video part on the DVD-Audio disc.
	Internet Setting	Permitted	Web contents can be watched without entering the password.
Partial Permitted		The password must be entered to watch web contents.	
Prohibited		No web contents can be watched.	
Disc Auto Playback	On	Discs are played automatically after they are loaded.	
	Off	Loaded discs do not start playing automatically.	
Last Memory	On	Select this to save the point at which you last stopped playback, even after the disc tray is opened or you switch to the standby mode.	
	Off	Select this when you want to use only Continue Viewing Play (page 33).	
PBC (Play Back Control)	On	Select this to play Video-CDs (version 2.0) compatible with PBC using the disc menu.	
	Off	Select this to play Video-CDs (version 2.0) compatible with PBC without using the disc menu.	
Setup Navigator		Start making the settings using the Setup Navigator menu. For details, see page 23.	
Security	Change Password		Register (change) the password for parental lock settings or for unlocking to play DVD-Videos with the parental lock feature (page 45).
	Parental Control		Change the player's parental lock level (page 46).
	Country Code		Change the Country/Area code (page 46).

Setting	Options	Explanation
Options Screen Saver	Off	The screen saver is not activated.
	1 min	The screen saver will be activated if no operation has been performed for more than one minute/two minutes/three minutes. Operating the remote control can deactivate the screen saver.
	2 min	
	3 min	
Auto Power Off	Off	Select this if you do not want the power to turn off automatically.
	10 min	The power will be automatically turned off if no operation has been performed for more than 10 minutes/20 minutes/30 minutes.
	20 min	
	30 min	
Quick Start	On	Select to shorten the required time to boot up.
	Off	Select to perform normal bootup.
Update	Disc	Select the method of software updating. (page 46)
	USB Storage	
	Network	
Load Default	Restore the settings to the factory default.	
System Information	Check the system version number.	
Disc Auto Update	On	Display the software update screen when the disc with the player's update file is loaded.
	Off	The software update screen must be displayed manually. (page 46)
BUDA	BUDA Information	Display and set up the BUDA data on the connected USB memory device.
	BUDA Setup	

❖ Adjusting the video

1 Select and set Display Setting → Video Adjust → Next Screen.

Use **↑/↓** to select, then press **ENTER**.

2 Select the item and change the setting.

Use **↑/↓** to select the item, then use **←/→** to change the setting. Once the setting is completed, press

↶ RETURN to close the settings screen.

List of BDP-LX55 setting items

Item	Description
Prog.Motion	Adjust according to the type of image (moving or still image). This is effective mainly when outputting video materials as progressive images.
Pure Cinema	This setting optimizes the operation of the progressive scanning circuit for playing film materials.
Black level	Adjusts the level of the black portions.
White level	Adjusts the level of the white portions.
Hue	Adjusts the balance between green and red.
Chroma Level	Adjusts the density of the colors.
Detail	Adjusts the picture's contours.
YNR	Reduces noise in the luminance (Y) signal.
CNR	Reduces noise in the chroma (C) signal.
MNR	Reduces the mosquito noise (distortion along the contours of the picture generated upon MPEG compression).
BNR	Reduces the block noise (block-shaped distortion generated upon MPEG compression).

List of BDP-440/BDP-140 setting items

Item	Description
Brightness	Select this to adjust the TV screen's brightness.
Contrast	Select this to adjust the TV screen's contrast.
Hue	Select this to adjust the color (green and red) balance of the TV screen.
Saturation	Select this to adjust the TV screen's saturation.



Note

- For the BDP-LX55, the **Video Adjust** settings do not affect Blu-ray 3D pictures or the pictures of the **VIDEO OUTPUT** terminals.

❖ Setting the IP address

1 Select and set Network → IP setting → Next Screen.

Use **↑/↓** to select, then press **ENTER**.

2 Set IP address.

Use **↑/↓/←/→** to set the IP address of the player or DNS server, then press **ENTER**.

• Auto Set IP Address

On – The player's IP address is obtained automatically. Select this when using a broadband router or broadband modem that has a DHCP (Dynamic Host Configuration Protocol) server function. This player's IP address will automatically be allocated from the DHCP server.

Off – The player's IP address must be set manually. Use the number buttons (0 to 9) to input the IP address, subnet mask and default gateway.



Note

- For information on the DHCP server function, refer to the operating instructions for the network device.
- You may need to contact your Internet service provider or network administrator when inputting the IP address manually.

❖ Setting the proxy server

Only set the proxy server if so instructed by your Internet service provider.

1 Select and set Network → Proxy Server → Next Screen.

Use **↑/↓** to select, then press **ENTER**.

2 Select and set Use or Not use at Proxy Server.

Use **←/→** to change, then press **↓**.

- Use** – Select this when using a proxy server.
- Not use** – Select this when not using a proxy server.

If you have selected **Use**, proceed to step 3.

3 Select and set Server Select Method.

Use **←/→** to change, then press **↓**.

- IP Address** – Input the IP address.
- Server Name** – Input the server name.

4 Input IP Address or Server Name.

Use the number buttons (0 to 9) to input the number if you select IP address in step 3. Use **←/→** to move the cursor.

When Server Name is selected in step 3, use the number buttons (0 to 9) to launch the software keyboard. Now use **↑/↓/←/→** to select characters and items, then press **ENTER** to input.

5 Input Port Number.

Press **↓**, then use the number buttons (0 to 9) to input the number.

6 Press **ENTER** to set.

❖ Displaying the network settings

► Select and set Network → Information → Next Screen.

Use **↑/↓** to select, then press **ENTER**.

The MAC address, IP address, subnet mask, default gateway and DNS server (primary and secondary) settings are displayed.

When **Auto Set IP Address** is set to **On**, the values obtained automatically are displayed.



Note

- "0.0.0.0" is displayed when each IP address has not been set.

❖ Testing the network connection

► Select and set Network → Connection Test → Start.

Use **↑/↓** to select, then press **ENTER**.

"Network is OK." is displayed once the test is completed. If any other message is displayed, check the connections and/or settings (pages 21 and 41).

❖ Changing to other language at language setting

1 Select and set Language.

Use **↑/↓** to select, then press **ENTER**.

2 Select and set OSD, Audio, Subtitle or Menu

Use **↑/↓** to select, then press **ENTER**.

3 Select and set the desired language.

Use **↑/↓** to select, then press **ENTER**.



Note

- If a language not recorded on the BD/DVD is set, one of the recorded languages is automatically selected and played.

❖ Erasing data that has been added to BDs and application data

Use this procedure to erase data that has been added to BDs (data downloaded with the BD-LIVE function and data used with the BONUSVIEW function) and application data.



Caution

- Some time is required to erase the data.
- Do not unplug the power cord while data is being erased.

1 Select and set BUDA → BUDA Setup.

Use **↑/↓** to select, then press **ENTER**.

2 Select and set Fmt buda.

Press **ENTER**.

❖ Registering or Changing the password

Use this procedure to register or change the code number required for the Parental Lock settings.

About default password of this unit

The default password is "0000".

- This unit might ask you to enter a password when you change the password.
- If you reset this unit, your password is simultaneously changed to the default setting.

1 Select and set Security → Change Password → Next Screen.

Use **↑/↓** to select, then press **ENTER**.

2 Input the password.

Use the number buttons (0 to 9) to input the number, then press **ENTER** to set.

Use **←/→** to move the cursor.

3 Re-input the password.

Use the number buttons (0 to 9) to input the number, then press **ENTER** to set.

Use **←/→** to move the cursor.

- To change the password, input the previously registered password, then input the new password.



Note

- We recommend making a note of the password.
- If you have forgotten the password, reset the player to the factory default setting, then register the password again (page 47).

❖ Changing the Parental Lock level for viewing DVDs/BD-ROMs

Some DVD-Video discs containing scenes of violence, for example, have Parental Lock levels (check the indications on the disc's jacket or elsewhere). To restrict viewing these discs, set the player's level to the level lower than the discs.

1 Select and set Security → Parental Control → Next Screen.

Use **↑/↓** to select, then press **ENTER**.

2 Input the password.

Use the number buttons (0 to 9) to input the number, then press **ENTER** to set.

Use **←/→** to move the cursor.

3 Change the level.

Use **←/→** to change, then press **ENTER** to set.



Note

- The level can be set to **Off** or between **Level1** and **Level8**. When set to **Off**, viewing is not restricted.

❖ Changing the Country/Area code

1 Select and set Security → Country Code → Next Screen.

Use **↑/↓** to select, then press **ENTER**.

2 Input the password.

Use the number buttons (0 to 9) to input the number, then press **ENTER** to set.

Use **←/→** to move the cursor.

3 Change the country/area code.

Use **←/→** to change, then press **ENTER** to set. Refer to page 48.

Software updating

The player's software can be updated using one of the methods shown below.

- Connecting to the Internet.
- Using a disc.
- Using a USB memory device.

Product information on this player is provided on the Pioneer website. Check the website shown on page 6 for update and service information on your Blu-ray disc player.



Caution

- Do not unplug the power cord or remove the USB memory device/disc during software updating. Otherwise, the updating will be aborted and malfunction may occur with the player.
- There are two processes for software updating, downloading and updating. Both processes may take a certain period of time.
- Other operations are defeated during software updating. Furthermore, updating process cannot be canceled.
- On the BDP-LX55/BDP-440, when the front panel display is off, turn it on with **FL DIMMER**. When updating the player's software with the front panel display off, do not unplug the power cord until the unit turns off.

❖ Updating connecting to the Internet



Note

- Depending on the Internet connection conditions, downloading may take a long time.
- Steps **1** to **5** are the operations performed by the user (they are intended to download the software from the Internet).
- Steps **6** to **8** are the operations performed (automatically) by the player (they are intended to update the software).

1 Connect to the Internet.

2 When playback is stopped, display the Home Menu screen.

Press **HOME MENU**.

3 Select and set Initial Setup.

Use **↑/↓** to select, then press **ENTER**.

4 Select and set Options → Update → Network → Start.

Use **↑/↓** to select, then press **ENTER**.

5 Select and set Start.

Press **ENTER**.

6 Downloading of the software start.

The software download status is displayed on the screen.

- Depending on the Internet connection conditions, software downloading may take a certain period of time.

7 Updating starts.

- Software updating may take a certain period of time.

8 Updating completes.

This unit automatically restarts.

❖ Updating using a USB memory device/disc



Note

- When an update file is provided on the Pioneer website, use your computer to download it onto a USB memory device or disc. Carefully read the instructions on downloading update files provided on the Pioneer website.
- Store the update file in the root directory of the USB memory device or disc. Do not store it within a folder.
- Do not put any files other than the update file on the USB memory device or disc.
- To update using a disc, use a CD-R or CD-RW disc.
- The player supports USB memory devices formatted in FAT32/16. When formatting a USB memory device on your computer, do so with the settings below.
 - File system: FAT32
 - Allocation unit size: Default allocation size
- Only store the most recent update file on the USB memory device or disc.
- Do not use a USB extension cable to connect a USB memory device to the player. Using a USB extension cable may prevent the player from performing correctly.
- Steps **1** to **5** are the operations performed by the user.
- Steps **6** to **7** are the operations performed (automatically) by the player (they are intended to update the software).

1 Plug in the USB memory device or load the disc on which the update file is stored.

2 When playback is stopped, display the Home Menu screen.

Press  **HOME MENU**.

3 Select and set Initial Setup.

Use **↑/↓** to select, then press **ENTER**.

4 Select and set Options → Update → Disc or USB Storage → Start.

Use **↑/↓** to select, then press **ENTER**.

5 Select and set Yes.

Use **↑/↓/←/→** to select **Yes**, then press **ENTER**.

6 Updating starts.

- Software updating may take a certain period of time.

7 Updating completes.

Restoring all the settings to the factory default settings

1 Check that the player's power is turned on.

2 When playback is stopped, display the Home Menu screen.

Press  **HOME MENU**.

3 Select and set Initial Setup.

Use **↑/↓** to select, then press **ENTER**.

4 Select and set Options → Load Default → Next Screen.

Use **↑/↓** to select, then press **ENTER**.

5 Select and set OK.

Use **←/→** to select, then press **ENTER**.



Note

- After restoring all the settings to the factory default settings, use **Setup Navigator** to reset the player (page 23).
- When all the settings are restored to the factory defaults, all the data for the secondary video (Picture-in-Picture), secondary audio, bookmarks, etc., is erased.

Language Code Table and Country/Area Code Table

❖ Language Code Table

Language name, language code, input code

Abkhazian, ab/abk , 0102	French, fr/fr , 0618	Malagasy, mg/mlg , 1307	Slovenian, sl/slv , 1912
Afar, aa/aa , 0101	Galician, gl/glg , 0712	Malay, ms/msa , 1319	Somali, so/som , 1915
Afrikaans, af/af , 0106	Georgian, ka/kat , 1101	Malayalam, ml/mal , 1312	Sotho, Southern, st/sot , 1920
Albanian, sq/sqi , 1917	German, de/deu , 0405	Maltese, mt/mlt , 1320	Spanish, es/spa , 0519
Amharic, am/amh , 0113	Greek, el/ell , 0512	Maori, mi/mri , 1309	Sundanese, su/sun , 1921
Arabic, ar/ara , 0118	Guarani, gn/gmn , 0714	Marathi, mr/mar , 1318	Swahili, sw/swa , 1923
Armenian, hy/hye , 0825	Gujarati, gu/guj , 0721	Mongolian, mn/mon , 1314	Swati, ss/ssw , 1919
Assamese, as/asm , 0119	Hausa, ha/hau , 0801	Moldavian, mo/mol , 1315	Swedish, sv/swe , 1922
Aymara, ay/aym , 0125	Hebrew, iw/heb , 0923	Nauru, na/nau , 1401	Tagedag, tl/tgl , 2012
Azerbaijani, az/aze , 0216	Hindi, hi/hin , 0809	Nepali, ne/nep , 1405	Tajik, tg/tgk , 2007
Bashkir, ba/bak , 0201	Hungarian, hu/hun , 0821	Norwegian, no/nor , 1415	Tamil, ta/tam , 2001
Basque, eu/eus , 0521	Icelandic, is/isl , 0919	Occitan, oc/oci , 1503	Tatar, tt/tat , 2020
Belarusian, be/bel , 0205	Indonesian, in/ind , 0914	Oriya, or/ori , 1518	Telugu, te/tel , 2005
Bengali, bn/ben , 0214	Interlingua, ia/ina , 0901	Oromo, om/orm , 1513	Thai, th/tha , 2008
Bihari, bh/bih , 0208	Interlingue, ie/ile , 0905	Panjabi, pa/pan , 1601	Tibetan, bo/bod , 0215
Bislama, bi/bis , 0209	Iniupiaq, ik/ikp , 0911	Persian, fa/fas , 0601	Tigrinya, ti/tir , 2009
Breton, br/bre , 0218	Irish, ga/gle , 0701	Polish, pl/plk , 1612	Tonga (Tonga Islands), to/ton , 2015
Bulgarian, bg/bul , 0207	Italian, it/ita , 0920	Portuguese, pt/por , 1620	Tsonga, ts/tso , 2019
Burmese, my/mya , 1325	Japanese, ja/jpn , 1001	Pushto, ps/pus , 1619	Tswana, tn/tsn , 2014
Catalan, ca/cat , 0301	Javanese, iw/jav , 1023	Quechua, qu/que , 1721	Turkmen, tk/tuk , 2011
Central Khmer, km/khm , 1113	Kalaallisut, kl/kal , 1112	Romanian, ro/ron , 1815	Turkish, tr/tur , 2018
Chinese, zh/zho , 2608	Kannada, kn/kan , 1114	Romansch, rm/roh , 1813	Twi, tw/twi , 2023
Coriscan, co/cos , 0315	Kashmiri, ks/kas , 1119	Rundi, rn/run , 1814	Ukrainian, uk/ukr , 2111
Croatian, hr/hrv , 0818	Kazakh, kk/kaz , 1111	Russian, ru/rus , 1821	Urdu, ur/urd , 2118
Czech, cs/ces , 0319	Kinyarwanda, rw/kin , 1823	Samoan, sm/smo , 1913	Uzbek, uz/uzb , 2126
Danish, da/dan , 0401	Kirghiz, ky/kir , 1125	Sango, sg/sag , 1907	Vietnamese, vi/vie , 2209
Dutch, nl/nld , 1412	Korean, ko/kor , 1115	Sanskrit, pl/plk , 1901	Volapük, vo/vol , 2215
Dzongkha, dz/dzo , 0426	Kurdish, ku/ku , 1121	Scottish Gaelic, gd/gla , 0704	Welsh, cy/cym , 0325
Lao, lo/iao , 0514	Lao, lo/iao , 0514	Serbian, sr/srp , 1918	Western Frisian, fy/fry , 0625
Esperanto, eo/epo , 0515	Latin, la/lat , 1201	Serbo-Croatian, sh/-- , 1908	Wolof, wo/wol , 2315
Estonian, et/est , 0520	Latvian, lv/lav , 1222	Shona, sn/sna , 1914	Xhosa, xh/xho , 2408
Finnish, fi/fin , 0609	Lingala, ln/lin , 1214	Sindhi, sd/snd , 1904	Yiddish, ji/yid , 1009
Fijian, fj/fij , 0610	Lithuanian, lt/lit , 1220	Sinhalese, si/sin , 1909	Yoruba, yo/yor , 2515
Faroese, fo/fao , 0615	Macedonian, mk/mkd , 1311	Slovak, sk/slk , 1911	Zulu, zu/zul , 2621

❖ Country/Area Code Table

Country/Area name, Country/Area code, input code

Anguilla, ai , 0109	Estonia, ee , 0505	Luxembourg, lu , 1221	Slovakia, sk , 1911
Antigua and Barbuda, ag , 0107	Finland, fi , 0609	Macedonia, the Former Yugoslav Republic of, mk , 1311	Slovenia, si , 1909
Argentina, ar , 0118	France, fr , 0618	Malaysia, my , 1325	Spain, es , 0519
Armenia, am , 0113	Georgia, ge , 0705	Malta, mt , 1320	Suriname, sr , 1918
Australia, au , 0121	Germany, de , 0405	Mexico, mx , 1324	Sweden, se , 1905
Austria, at , 0120	Greece, gr , 0718	Moldova, Republic of, md , 1304	Switzerland, ch , 0308
Azerbaijan, az , 0126	Greenland, gl , 0712	Monaco, mc , 1303	Taiwan, Province of China, tw , 2023
Bahamas, bs , 0219	Grenada, gd , 0704	Montserrat, ms , 1319	Tajikistan, tj , 2010
Barbados, bb , 0202	Guayana, gy , 0725	Netherlands, nl , 1412	Thailand, th , 2008
Belarus, by , 0225	Haiti, ht , 0820	New Zealand, nz , 1426	Trinidad and Tobago, tt , 2020
Belgium, be , 0205	Hong Kong, hk , 0811	Norway, no , 1415	Tunisia, tn , 2014
Belize, bz , 0226	Hungary, hu , 0821	Pakistan, pk , 1611	Turkey, tr , 2018
Bermuda, bm , 0213	Iceland, is , 0919	Peru, pe , 1605	Turkmenistan, tm , 2013
Brazil, br , 0218	India, in , 0914	Philippines, ph , 1608	Turks and Caicos Islands, tc , 2003
Bulgaria, bg , 0207	Indonesia, id , 0904	Poland, pl , 1612	Ukraine, ua , 2101
Canada, ca , 0301	Ireland, ie , 0905	Portugal, pt , 1620	United Kingdom, gb , 0702
Cayman Islands, ky , 1125	Israel, il , 0912	Puerto Rico, pr , 1618	United States, us , 2119
Chile, cl , 0312	Italy, it , 0920	Romania, ro , 1815	Uruguay, uy , 2125
China, cn , 0314	Jamaica, jm , 1013	Russian Federation, ru , 1821	Uzbekistan, uz , 2126
Colombia, co , 0315	Japan, jp , 1016	Saint Kitts and Nevis, kn , 1114	Venezuela, ve , 2205
Croatia, hr , 0818	Kazakhstan, kz , 1126	Saint Lucia, lc , 1203	Virgin Islands, British, vg , 2207
Cyprus, cy , 0325	Korea, Republic of, kr , 1118	Saint Vincent and the Grenadines, vc , 2203	
Czech Republic, cz , 0326	Kyrgyzstan, kg , 1107	San Marino, sm , 1913	
Denmark, dk , 0411	Latvia, lv , 1222	Singapore, sg , 1907	
Dominica, dm , 0413	Liechtenstein, li , 1209		
Dominican Republic, do , 0415	Lithuania, lt , 1220		

Chapter 8

Additional information

Software license Notice

The licenses for the open source software used on this player are shown below. For accuracy purposes, here we have included the original texts (in English).

❖ curl

COPYRIGHT AND PERMISSION NOTICE

Copyright © 1996 - 2007, Daniel Stenberg, <daniel@haxx.se>. All rights reserved.
Permission to use, copy, modify, and distribute this software for any purpose with or without fee is hereby granted, provided that the above copyright notice and this permission notice appear in all copies.
THE SOFTWARE IS PROVIDED "AS IS", WITHOUT WARRANTY OF ANY KIND, EXPRESS OR IMPLIED, INCLUDING BUT NOT LIMITED TO THE WARRANTIES OF MERCHANTABILITY, FITNESS FOR A PARTICULAR PURPOSE AND NONINFRINGEMENT OF THIRD PARTY RIGHTS. IN NO EVENT SHALL THE AUTHORS OR COPYRIGHT HOLDERS BE LIABLE FOR ANY CLAIM, DAMAGES OR OTHER LIABILITY, WHETHER IN AN ACTION OF CONTRACT, TORT OR OTHERWISE, ARISING FROM, OUT OF OR IN CONNECTION WITH THE SOFTWARE OR THE USE OR OTHER DEALINGS IN THE SOFTWARE.

Except as contained in this notice, the name of a copyright holder shall not be used in advertising or otherwise to promote the sale, use or other dealings in this Software without prior written authorization of the copyright holder.

Except as contained in this notice, the name of a copyright holder shall not be used in advertising or otherwise to promote the sale, use or other dealings in this Software without prior written authorization of the copyright holder.

❖ expat

Copyright (c) 1998, 1999, 2000 Thai Open Source Software Center Ltd
Permission is hereby granted, free of charge, to any person obtaining a copy of this software and associated documentation files (the "Software"), to deal in the Software without restriction, including without limitation the rights to use, copy, modify, merge, publish, distribute, sublicense, and/or sell copies of the Software, and to permit persons to whom the Software is furnished to do so, subject to the following conditions:

The above copyright notice and this permission notice shall be included in all copies or substantial portions of the Software.

THE SOFTWARE IS PROVIDED "AS IS", WITHOUT WARRANTY OF ANY KIND, EXPRESS OR IMPLIED, INCLUDING BUT NOT LIMITED TO THE WARRANTIES OF MERCHANTABILITY, FITNESS FOR A PARTICULAR PURPOSE AND NONINFRINGEMENT. IN NO EVENT SHALL THE AUTHORS OR COPYRIGHT HOLDERS BE LIABLE FOR ANY CLAIM, DAMAGES OR OTHER LIABILITY, WHETHER IN AN ACTION OF CONTRACT, TORT OR OTHERWISE, ARISING FROM, OUT OF OR IN CONNECTION WITH THE SOFTWARE OR THE USE OR OTHER DEALINGS IN THE SOFTWARE.

❖ freetype

This software is based in part on freetype see <http://www.freetype.org> for information.

❖ International Components for Unicode

ICU License - ICU 1.8.1 and later
COPYRIGHT AND PERMISSION NOTICE
Copyright (c) 1995-2010 International Business Machines Corporation and others
All rights reserved.

Permission is hereby granted, free of charge, to any person obtaining a copy of this software and associated documentation files (the "Software"), to deal in the Software without restriction, including without limitation the rights to use, copy, modify, merge, publish, distribute, and/or sell copies of the Software, and to permit persons to whom the Software is furnished to do so, provided that the above copyright notice(s) and this permission notice appear in all copies of the Software and that both the above copyright notice(s) and this permission notice appear in supporting documentation.

THE SOFTWARE IS PROVIDED "AS IS", WITHOUT WARRANTY OF ANY KIND, EXPRESS OR IMPLIED, INCLUDING BUT NOT LIMITED TO THE WARRANTIES OF MERCHANTABILITY, FITNESS FOR A PARTICULAR PURPOSE AND NONINFRINGEMENT OF THIRD PARTY RIGHTS. IN NO EVENT SHALL THE COPYRIGHT HOLDER OR HOLDERS INCLUDED IN THIS NOTICE BE LIABLE FOR ANY CLAIM, OR ANY SPECIAL INDIRECT OR CONSEQUENTIAL DAMAGES, OR ANY DAMAGES WHATSOEVER RESULTING FROM LOSS OF USE, DATA OR PROFITS, WHETHER IN AN ACTION OF CONTRACT, NEGLIGENCE, OR OTHER TORTIOUS ACTION, ARISING OUT OF OR IN CONNECTION WITH THE USE OR PERFORMANCE OF THIS SOFTWARE.

Except as contained in this notice, the name of a copyright holder shall not be used in advertising or otherwise to promote the sale, use or other dealings in this Software without prior written authorization of the copyright holder.

❖ jpeg

This software is based in part on the work of the independent JPEG Group.

❖ openssl

The OpenSSL toolkit stays under a dual license, i.e. both the conditions of the OpenSSL License and the original SSLeay license apply to the toolkit.

See below for the actual license texts. Actually both licenses are BSD style Open Source licenses. In case of any license issues related to OpenSSL please contact openssl-core@openssl.org.

OpenSSL License

Copyright (c) 1998-2008 The OpenSSL Project. All rights reserved.

Redistribution and use in source and binary forms, with or without modification, are permitted provided that the following conditions are met:

1. Redistributions of source code must retain the above copyright notice, this list of conditions and the following disclaimer.
2. Redistributions in binary form must reproduce the above copyright notice, this list of conditions and/or other materials provided with the distribution.
3. All advertising materials mentioning features or use of this software must display the following acknowledgment:
"This product includes software developed by the OpenSSL Project for use in the OpenSSL Toolkit. (<http://www.openssl.org/>)"
4. The names "OpenSSL Toolkit" and "OpenSSL Project" must not be used to endorse or promote products derived from this software without prior written permission. For written permission, please contact openssl-core@openssl.org.
5. Products derived from this software may not be called "OpenSSL" nor may "OpenSSL" appear in their names without prior written permission of the OpenSSL Project.
6. Redistributions of any form whatsoever must retain the following acknowledgment:
"This product includes software developed by the OpenSSL Project for use in the OpenSSL Toolkit (<http://www.openssl.org/>)"

THIS SOFTWARE IS PROVIDED BY THE OPENSSL PROJECT "AS IS" AND ANY EXPRESSED OR IMPLIED WARRANTIES, INCLUDING BUT NOT LIMITED TO, THE IMPLIED WARRANTIES OF MERCHANTABILITY AND FITNESS FOR A PARTICULAR PURPOSE ARE DISCLAIMED. IN NO EVENT SHALL THE OPENSSL PROJECT OR ITS CONTRIBUTORS BE LIABLE FOR ANY DIRECT, INDIRECT, INCIDENTAL, SPECIAL, EXEMPLARY, OR CONSEQUENTIAL DAMAGES (INCLUDING, BUT NOT LIMITED TO, PROCUREMENT OF SUBSTITUTE GOODS OR SERVICES; LOSS OF USE, DATA, OR PROFITS; OR BUSINESS INTERRUPTION) HOWEVER CAUSED AND ON ANY THEORY OF LIABILITY, WHETHER IN CONTRACT, STRICT LIABILITY, OR TORT (INCLUDING NEGLIGENCE OR OTHERWISE) ARISING IN ANY WAY OUT OF THE USE OF THIS SOFTWARE, EVEN IF ADVISED OF THE POSSIBILITY OF SUCH DAMAGE.

This product includes cryptographic software written by Eric Young (ey@cryptsoft.com). This product includes software written by Tim Hudson (tjh@cryptsoft.com).

Original SSLeay License

Copyright (c) 1995-1998 Eric Young (ey@cryptsoft.com)
All rights reserved.
This package is an SSL implementation written by Eric Young (ey@cryptsoft.com).

The implementation was written so as to conform with Netscapes SSL.

This library is free for commercial and non-commercial use as long as the following conditions are adhered to. The following conditions apply to all code found in this distribution, be it RGA, RSA, Inash, DES, etc., code: not just the SSL code. The SSL documentation included with this distribution is covered by the same copyright terms except that the holder is Tim Hudson (tjh@cryptsoft.com). Copyright remains Eric Young's, and as such any Copyright notices in the code are not to be removed. If this package is used in a product, Eric Young should be given attribution as the author of the parts of the library used. This can be in the form of a textual message at program start or in documentation (online or textual) provided with the package.

Redistribution and use in source and binary forms, with or without modification, are permitted provided that the following conditions are met:

1. Redistributions of source code must retain the copyright notice, this list of conditions and the following disclaimer.
2. Redistributions in binary form must reproduce the above copyright notice, this list of conditions and/or other materials provided with the distribution.
3. All advertising materials mentioning features or use of this software must display the following acknowledgment:
"This product includes cryptographic software written by Eric Young (ey@cryptsoft.com)" The word "cryptographic" can be left out if the routines from the library being used are not cryptographic related -).
4. If you include any Windows specific code (or a derivative thereof) from the apps directory (application code) you must include an acknowledgment:
"This product includes software written by Tim Hudson (tjh@cryptsoft.com)"

THIS SOFTWARE IS PROVIDED BY ERIC YOUNG "AS IS" AND ANY EXPRESS OR IMPLIED WARRANTIES, INCLUDING, BUT NOT LIMITED TO, THE IMPLIED WARRANTIES OF MERCHANTABILITY AND FITNESS FOR A PARTICULAR PURPOSE ARE DISCLAIMED. IN NO EVENT SHALL THE AUTHOR OR CONTRIBUTORS BE LIABLE FOR ANY DIRECT, INDIRECT, INCIDENTAL, SPECIAL, EXEMPLARY, OR CONSEQUENTIAL DAMAGES (INCLUDING, BUT NOT LIMITED TO, PROCUREMENT OF SUBSTITUTE GOODS OR SERVICES; LOSS OF USE, DATA, OR PROFITS; OR BUSINESS INTERRUPTION) HOWEVER CAUSED AND ON ANY THEORY OF LIABILITY, WHETHER IN CONTRACT, STRICT LIABILITY, OR TORT (INCLUDING NEGLIGENCE OR OTHERWISE) ARISING IN ANY WAY OUT OF THE USE OF THIS SOFTWARE, EVEN IF ADVISED OF THE POSSIBILITY OF SUCH DAMAGE.

The license and distribution terms for any publicly available version or derivative of this code cannot be changed, i.e. this code cannot simply be copied and put under another distribution licence (including the GNU Public Licence.)

❖ zlib

This software is based in part on zlib see <http://www.zlib.net> for information.

❖ GNU General Public License and GNU Lesser General Public License

This product includes the following software licensed for use under the terms of GNU General Public License v2, GNU Lesser General Public License v2.1, - linux kernel 2.6, Copyright (C) 1991 Linus Torvalds. Licensed under GPL v2.0
- BusyBox v1.17.1 multi-call binary, Copyright (C) 1998-2009 Erik Andersen, Rob Landley, Denys Vlasenko and others. Licensed under GPLv2.0
- SquashFS Copyright: (C) 2002-2009 Phillip Lougher Licensed under GPLv2.0
- Das U-Boot Copyright: (C) 2000-2005 Wolfgang Denk, DENX Software Engineering, wd@denx.de. Licensed under GPLv2.0
- IIRC 0.8.5 Copyright (C) 1996 Ralph Metzler <rjm@thp.uni-koeln.de> Copyright (C) 1998-2008 Christoph Bartelmus <lirc@bartelmus.de> Licensed under GPLv2.0
- glibc 2.9 Copyright (C) 1992-2006, 2007 Free Software Foundation, Inc. Licensed under LGPL v2.1.

You can get corresponding open source code from the following URL:
<http://www.oss-pioneer.com/homeave/blu-ray>

Please refer to the following URL for further information of GNU General Public License Version 2.
<http://www.gnu.org/licenses/gpl-2.0.html>

Please refer to the following URL for further information of GNU Library General Public License Version 2.1.
<http://www.gnu.org/licenses/old/licenses/lgpl-2.1.html>

GNU GENERAL PUBLIC LICENSE

Version 2, June 1991

Copyright (C) 1989, 1991 Free Software Foundation, Inc.,
 51 Franklin Street, Fifth Floor, Boston, MA 02110-1301 USA
 Everyone is permitted to copy and distribute verbatim
 copies of this license document, but changing it is not
 allowed.

Preamble

The licenses for most software are designed to take away
 your freedom to share and change it. By contrast, the GNU
 General Public License is intended to guarantee your
 freedom to share and change free software—to make sure
 the software is free for all its users. This General Public
 License applies to most of the Free Software Foundation's
 software and to any other program whose authors commit
 to using it. (Some other Free Software Foundation software
 is covered by the GNU Lesser General Public License
 instead.) You can apply it to your programs, too.

When we speak of free software, we are referring to
 freedom, not price. Our General Public Licenses are
 designed to make sure that you have the freedom to
 distribute copies of free software (and charge for this
 service if you wish), that you receive source code or can
 get it if you want it, that you can change the software or
 use pieces of it in new free programs; and that you know
 you can do these things.

To protect your rights, we need to make restrictions that
 forbid anyone to deny you these rights or to ask you to
 surrender the rights. These restrictions translate to certain
 responsibilities for you if you distribute copies of the
 software, or if you modify it.

For example, if you distribute copies of such a program,
 whether gratis or for a fee, you must give the recipients
 all the rights that you have. You must make sure that they,
 too, receive or can get the source code. And you must show
 them these terms so they know their rights.

We protect your rights with two steps: (1) copyright the
 software, and (2) offer you this license which gives you
 legal permission to copy, distribute and/or modify the
 software. Also, for each author's protection and ours, we
 want to make certain that everyone understands that there
 is no warranty for this free software. If the software is
 modified by someone else and passed on, we want its
 recipients to know that what they have is not the original,
 so that any problems introduced by others will not reflect
 on the original authors' reputations.

Finally, any free program is threatened constantly by
 software patents. We wish to avoid the danger that
 redistributors of a free program will individually obtain
 patent licenses, in effect making the program proprietary.
 To prevent this, we have made it clear that any patent
 must be licensed for everyone's free use or not licensed
 at all. The precise terms and conditions for copying,
 distribution and modification follow.

GNU GENERAL PUBLIC LICENSE

TERMS AND CONDITIONS FOR COPYING, DISTRIBUTION AND MODIFICATION

0. This License applies to any program or other work
 which contains a notice placed by the copyright holder
 saying it may be distributed under the terms of this
 General Public License. The "Program", below, refers to
 any such program or work, and a "work based on the
 Program" means either the Program or any derivative
 work under copyright law; that is to say, a work
 containing the Program or a portion of it, either
 verbatim or with modifications and/or translated into
 another language. (This definition of "work" includes
 translation into another language, since the program
 itself is limited in the term "modification".) Each
 licensee is addressed as "you".
 Activities other than copying, distribution and
 modification are not covered by this License; they are
 outside its scope. The act of running the Program is not
 restricted, and the output from the Program is covered
 only if its contents constitute a work based on the
 Program (independent of having been made by running
 the Program). Whether that is true depends on what the
 Program does.

1. You may copy and distribute verbatim copies of the
 Program's source code as you receive it, in any
 medium, provided that you conspicuously and
 appropriately publish on each copy an appropriate
 copyright notice and disclaimer of warranty; keep intact
 all the notices that refer to this License and to the
 absence of any warranty; and give any other recipients
 of the Program a copy of this License along with the
 Program.

You may charge a fee for the physical act of transferring
 a copy, and you may at your option offer warranty
 protection in exchange for a fee.

2. You may modify your copy or copies of the Program or
 any portion of it, thus forming a work based on the
 Program, and copy and distribute such modifications or
 work under the terms of Section 1 above, provided that
 you also meet all of these conditions:

- a) You must cause the modified files to carry prominent
 notices stating that you changed the files and the
 date of any change.
- b) You must cause any work that you distribute or
 publish, that in whole or in part contains or is derived
 from the Program or any part thereof, to be licensed
 as a whole at no charge to all third parties under the
 terms of this License.
- c) If the modified program normally reads commands
 interactively when run, you must cause it, when
 started running for such interactive use in the most
 ordinary way, to print or display an announcement
 including an appropriate copyright notice and a
 notice that there is no warranty (or else, saying that
 you provide a warranty) and that users may
 redistribute the program under these conditions, and
 telling the user how to view a copy of this License.
 (Exception: if the Program itself is interactive but
 does not normally print such an announcement, your
 work based on the Program is not required to print an
 announcement.)

These requirements apply to the modified work as a whole.
 If identifiable sections of that work are not derived from
 the Program, and can be reasonably considered independent
 and separate works in themselves, then this License, and
 its terms, do not apply to those sections when you
 distribute them as separate works. But when you
 distribute them as part of a whole which is a work based
 on the Program, the distribution of the whole must be on
 the terms of this License, whose permissions for other
 licensees extend to the entire whole, and thus to each
 and every part regardless of who wrote it.

Thus, it is not the intent of this section to claim rights or
 contest others' rights to work written entirely by you; rather,
 the intent is to exercise the right to control the distribution
 of derivative or collective works based on the Program.
 In addition, mere aggregation of another work not based
 on the Program with the Program (or with a work based on
 the Program) on a volume of a storage or distribution medium
 does not bring the other work under the scope of this
 License.

3. You may copy and distribute the Program (or a work
 based on it), under Section 2) in object code or
 executable form under the terms of Sections 1 and 2
 above provided that you also do one of the following:
 - a) Accompany it with the complete corresponding
 machine-readable source code, which must be
 distributed under the terms of Sections 1 and 2 above
 on a medium customarily used for software
 interchange; or,
 - b) Accompany it with a written offer, valid for at least
 three years, to give any third party, for a charge no
 more than your cost of physically performing source
 code distribution, a complete machine-readable copy of
 the corresponding source code, to be distributed
 under the terms of Sections 1 and 2 above on a
 medium customarily used for software interchange; or,
 - c) Accompany it with the information you received as to
 the offer to distribute corresponding source code.
 (This alternative is allowed only for noncommercial
 distribution and only if you received the program in
 object code or executable form with such an offer, in
 accord with Subsection b above.)

The source code for a work means the preferred form of
 the work for making modifications to it. For an executable
 work, complete source code means all the source code for
 all modules it contains, plus any associated interface
 definition files, plus the scripts used to control compilation
 and installation of the executable. However, as a special
 exception, the source code distributed need not include
 anything that is normally distributed (in either source or
 binary form) with the major components (compiler, kernel,
 and so on) of the operating system on which the executable
 runs, unless that component itself accompanies the
 executable.

If distribution of executable or object code is made by
 offering access to copy from a designated place, then
 offering equivalent access to copy the source code from the
 same place counts as distribution of the source code, even
 though third parties are not compelled to copy the source
 along with the object code.

4. You may not copy, modify, sublicense, or distribute the
 Program except as expressly provided under this
 License. Any attempt otherwise to copy, modify,
 sublicense or distribute the Program is void, and will
 automatically terminate your rights under this License.
 However, parties who have received copies, or rights,
 from you under this License will not have their licenses
 terminated so long as such parties remain in full
 compliance.

5. You are not required to accept this License, since you
 have not signed it. However, nothing else grants you
 permission to modify or distribute the Program or its
 derivative works. These actions are prohibited by law if
 you do not accept this License. Therefore, by modifying
 or distributing the Program (or any work based on the
 Program), you indicate your acceptance of this License
 to do so, and all its terms and conditions for copying,
 distributing or modifying the Program or works based
 on it.

6. Each time you redistribute the Program (or any work
 based on the Program), the recipient automatically
 receives a license from the original copyright holder to
 copy, distribute or modify the Program subject to these terms
 and conditions. You may not impose any further
 restrictions on the recipients' exercise of the rights
 granted herein. You are not responsible for enforcing
 compliance by third parties to this License.

7. If, as a consequence of a court judgment or allegation
 of patent infringement or for any other reason (not
 limited to patent issues), conditions are imposed on you
 (whether by court order, agreement or otherwise) that
 contradict the conditions of this License, they do not
 excuse you from the conditions of this License. If you
 cannot distribute so as to satisfy simultaneously your
 obligations under this License and any other pertinent
 obligations, then as a consequence you may not
 distribute the Program at all. For example, if a patent
 license would not permit royalty-free redistribution of
 the Program by all those who receive copies directly or
 indirectly through you, then the only way you could
 satisfy both it and this License would be to refrain
 entirely from distribution of the Program.
 If any portion of this section is held invalid or
 unenforceable under any particular circumstance, the
 balance of the section is intended to apply and the
 section as a whole is intended to apply in other
 circumstances.

It is not the purpose of this section to induce you to
 infringe any patents or other property right claims or to
 contest validity of any such claims; this section has the
 sole purpose of protecting the integrity of the free
 software distribution system, which is implemented by
 public license practices. Many people have made
 generous contributions to the wide range of software
 distributed through that system in reliance on
 consistent application of the terms of this system; it is up to
 the author/donor to decide if he or she is willing to
 distribute software through any other system and a
 license cannot impose that choice.

This section is intended to make thoroughly clear what
 is believed to be a consequence of the rest of this
 License.

8. If the distribution and/or use of the Program is
 restricted in certain countries either by patents or by
 copyrighted interfaces, the original copyright holder
 who places the Program under this License may add an
 explicit geographical distribution limitation excluding
 those countries, so that distribution is permitted only in
 or among countries not thus excluded. In such case,
 this License incorporates the limitation as if written in
 the body of this License.

9. The Free Software Foundation may publish revised and/
 or new versions of the General Public License from time
 to time. Such new versions will be similar in spirit to
 the present version, but may differ in detail to address
 new problems or concerns.

Each version is given a distinguishing version number.
 If the Program specifies a version number of this
 License which applies to it and "any later version", you
 have the option of following the terms and conditions
 either of that version or of any later version published
 by the Free Software Foundation. If the Program does
 not specify a version number of this License, you may
 choose any version ever published by the Free Software
 Foundation.

10. If you wish to incorporate parts of the Program into
 other free programs whose distribution conditions are
 different, write to the author to ask for permission.
 For software which is copyrighted by the Free Software
 Foundation, write to the Free Software Foundation; we
 sometimes make exceptions for this. Our decision will
 be guided by the two goals of preserving the free status
 of all derivatives of our free software and of promoting
 the sharing and reuse of software generally.

NO WARRANTY

11. BECAUSE THE PROGRAM IS LICENSED FREE OF
 CHARGE, THERE IS NO WARRANTY FOR THE
 PROGRAM, TO THE EXTENT PERMITTED BY
 APPLICABLE LAW. EXCEPT WHERE AND IN
 CASES WHERE THE COPYRIGHT HOLDER HAS
 STATED IN WRITING THE COPYRIGHT HOLDERS AND/
 OR OTHER PARTIES PROVIDE THE PROGRAM "AS IS"
 WITHOUT WARRANTY OF ANY KIND, EITHER
 EXPRESSED OR IMPLIED, INCLUDING, BUT NOT
 LIMITED TO, THE IMPLIED WARRANTIES OF
 MERCHANTABILITY AND FITNESS FOR A

PARTICULAR PURPOSE. THE ENTIRE RISK AS TO THE QUALITY AND PERFORMANCE OF THE PROGRAM IS WITH YOU. SHOULD THE PROGRAM PROVE DEFECTIVE, YOU ASSUME THE COST OF ALL NECESSARY SERVICING, REPAIR OR CORRECTION.

12. IN NO EVENT UNLESS REQUIRED BY APPLICABLE LAW OR AGREED TO IN WRITING WILL ANY COPYRIGHT HOLDER, OR ANY OTHER PARTY WHO MAY MODIFY AND/OR REDISTRIBUTE THE PROGRAM AS PERMITTED ABOVE, BE LIABLE TO YOU FOR DAMAGES, INCLUDING ANY GENERAL, SPECIAL, INCIDENTAL OR CONSEQUENTIAL DAMAGES ARISING OUT OF THE USE OR INABILITY TO USE THE PROGRAM (INCLUDING BUT NOT LIMITED TO LOSS OF DATA OR DATA BEING RENDERED INACCURATE OR LOSSES SUSTAINED BY YOU OR THIRD PARTIES OR A FAILURE OF THE PROGRAM TO OPERATE WITH ANY OTHER PROGRAMS), EVEN IF SUCH HOLDER OR OTHER PARTY HAS BEEN ADVISED OF THE POSSIBILITY OF SUCH DAMAGES.

END OF TERMS AND CONDITIONS

How to Apply These Terms to Your New Programs
If you develop a new program, and you want it to be of the greatest possible use to the public, the best way to achieve this is to make it free software which everyone can redistribute and change under these terms.

To do so, attach the following notices to the program. It is safest to attach them to the start of each source file to most effectively convey the exclusion of warranty; and each file should have at least the "copyright" line and a pointer to where the full notice is found.

<one line to give the program's name and a brief idea of what it does.>

Copyright (C) <year> <name of author>
This program is free software; you can redistribute it and/or modify it under the terms of the GNU General Public License as published by the Free Software Foundation; either version 2 of the License, or (at your option) any later version.

This program is distributed in the hope that it will be useful, but WITHOUT ANY WARRANTY; without even the implied warranty of MERCHANTABILITY or FITNESS FOR A PARTICULAR PURPOSE. See the GNU General Public License for more details.

You should have received a copy of the GNU General Public License along with this program; if not, write to the Free Software Foundation, Inc., 51 Franklin Street, Fifth Floor, Boston, MA 02110-1301 USA.

Also add information on how to contact you by electronic and paper mail.

If the program is interactive, make it output a short notice like this when it starts in an interactive mode:

```
Gnomovision version 69, Copyright (C) year name of author
Gnomovision comes with ABSOLUTELY NO WARRANTY; for details type `show w'.
This is free software, and you are welcome to redistribute it under certain conditions; type `show c' for details.
```

The hypothetical commands 'show w' and 'show c' should show the appropriate parts of the General Public License. Of course, the commands you use may be called something other than 'show w' and 'show c'; they could even be mouse-clicks or menu items—whatever suits your program.

You should also get your employer (if you work as a programmer) or your school, if any, to sign a "copyright disclaimer" for the program, if necessary. Here is a sample; alter the names:

```
Yoodyne, Inc., hereby disclaims all copyright interest in
the program
'Gnomovision' (which makes passes at compilers)
written by Hans Hacker.
<signature of Ty Coon, 1 April 1989
Ty Coon, President of Vice
```

This General Public License does not permit incorporating your program into proprietary programs. If your program is a subroutine library, you may consider it more useful to permit linking proprietary applications with the library. This is what you want to do, use the GNU Lesser General Public License instead of this License.

GNU LESSER GENERAL PUBLIC LICENSE

Version 2.1, February 1999
Copyright (C) 1991, 1999 Free Software Foundation, Inc.
51 Franklin Street, Fifth Floor, Boston, MA 02110-1301 USA
Everyone is permitted to copy and distribute verbatim copies of this license document, but changing it is not allowed.

[This is the first released version of the Lesser GPL. It also counts as the successor of the GNU Library Public License, version 2, hence the version number 2.1.]

Preamble
The licenses for most software are designed to take away your freedom to share and change it. By contrast, the GNU General Public Licenses are intended to guarantee your

freedom to share and change free software—to make sure the software is free for all its users.

This license, the Lesser General Public License, applies to some specially designated software packages—typically libraries—of the Free Software Foundation and other authors who decide to use it. You can use it too, but we suggest you first think carefully about whether this license or the ordinary General Public License is the better strategy to use in any particular case, based on the explanations below.

When we speak of free software, we are referring to freedom of use, not price. Our General Public Licenses are designed to make sure that you have the freedom to distribute copies of free software (and charge for this service if you wish); that you receive source code or can get it if you want it; that you can change the software and use pieces of it in new free programs; and that you are informed that you can do these things.

To protect your rights, we need to make restrictions that forbid distributors to deny you these rights or to ask you to surrender these rights. These restrictions translate to certain responsibilities for you if you distribute copies of the library or if you modify it.

For example, if you distribute copies of the library, whether gratis or for a fee, you must give the recipients all the rights that we gave you. You must make sure that they, too, receive or can get the source code. If you link other code with the library, you must provide complete object files to the recipients, so that they can relink them with the library after making changes to the library and recompiling it. And you must show them these terms so they know their rights.

We protect your rights with a two-step method: (1) we copyright the library, and (2) we offer you this license, which gives you legal permission to copy, distribute and/or modify the library.

To protect each distributor, we want to make it very clear that there is no warranty for the free library. Also, if the library is modified by someone else and passed on, the recipients must know that what they have is not the original version, so that the original author's reputation will not be affected by problems that might be introduced by others.

Finally, software patents pose a constant threat to the existence of any free program. We wish to make sure that a company cannot effectively restrict the users of a free program by obtaining a restrictive license from a patent holder. Therefore, we insist that any patent license obtained for a version of the library must be consistent with the full freedom of use specified in this license.

Most GNU software, including some libraries, is covered by the ordinary GNU General Public License. This license, the GNU Lesser General Public License, applies to certain designated libraries, and is quite different from the ordinary General Public License. We use this license for certain libraries in order to permit linking those libraries into non-free programs.

When a program is linked with a library, whether statically or using a shared library, the combination of the two is legally speaking a combined work, a derivative of the original library. The ordinary General Public License therefore permits such linking only if the entire combination fits its criteria of freedom. The Lesser General Public License permits more lax criteria for linking other code with the library.

We call this license the "Lesser" General Public License because it does less to protect the user's freedom than the ordinary General Public License. It also provides other free software developers less of an advantage over competing non-free programs. These disadvantages are the reason we use the ordinary General Public License for many libraries. However, the Lesser license provides advantages in certain special circumstances.

For example, on rare occasions, there may be a special need to encourage the widest possible use of a certain library, so that it becomes a de-facto standard. To achieve this, non-free programs must be allowed to use the library. A more frequent case is that a free library does the same job as widely used non-free libraries. In this case, there is little to be gained by limiting the free library to free software only, so we use the Lesser General Public License.

In other cases, permission to use a particular library in non-free programs enables a greater number of people to use a large body of free software. For example, permission to use the GNU C Library in non-free programs enables many more people to use the whole GNU operating system, as well as its variant, the GNU/Linux operating system. Although the Lesser General Public License is Less protective of the users' freedom, it does ensure that the user of a program that is linked with the Library has the freedom and the wherewithal to run that program using a non-free version of the Library.

The precise terms and conditions for copying, distribution and modification follow. Pay close attention to the difference between a "work based on the library" and a "work that uses the library". The former contains code

derived from the library, whereas the latter must be combined with the library in order to run.

GNU LESSER GENERAL PUBLIC LICENSE TERMS AND CONDITIONS FOR COPYING, DISTRIBUTION AND MODIFICATION

0. This License Agreement applies to any software library or other program which contains a notice placed by the copyright holder or other authorized party saying it may be distributed under the terms of this Lesser General Public License (also called "this License"). Each licensee is addressed as "you".

A "library" means a collection of software functions and/or data prepared so as to be conveniently linked with application programs (which use some of those functions and data) to form executables.

The "Library", below, refers to any such software library or work which has been distributed under these terms. A "work based on the Library" means either the Library or any derivative work under copyright law: that is to say, a work containing the Library or a portion of it, either verbatim or with modifications and/or translated straightforwardly into another language. (Hereinafter, translation is included without limitation in the term "modification".)

"Source code" for a work means the preferred form of the work for making modifications to it. For a library, complete source code means all the source code for all modules it contains, plus any associated interface definition files, plus the scripts used to control compilation and installation of the library. Activities other than copying, distribution and modification are not covered by this License; they are outside its scope. The act of running a program using the Library is not restricted, and output from such a program is covered only if its contents constitute a work based on the Library (independent of the use of the Library in a tool for writing it). Whether that is true depends on what the Library does and what the program that uses the Library does.

1. You may copy and distribute verbatim copies of the Library's complete source code as you receive it, in any medium, provided that you conspicuously and appropriately publish on each copy an appropriate copyright notice and disclaimer of warranty; keep intact all the notices that refer to this License and to the absence of any warranty; and distribute a copy of this License along with the Library.

You may charge a fee for the physical act of transferring a copy, and you may at your option offer warranty protection in exchange for a fee.

2. You may modify your copy or copies of the Library or any portion of it, thus forming a work based on the Library, and copy and distribute such modifications or work under the terms of Section 1 above, provided that you also meet all of these conditions:

- The modified work must itself be a software library.
- You must cause the files modified to carry prominent notices stating that you changed the files and the date of any change.
- You must cause the whole of the work to be licensed at no charge to all third parties under the terms of this License.

d) If a facility in the modified Library refers to a function or a table of data to be supplied by an application program that uses the facility, other than as an argument passed when the facility is invoked, then you must make a good faith effort to ensure that, in the event an application does not supply such function or table, the facility still operates, and performs whatever part of its purpose remains meaningful.

(For example, a function in a library to compute square roots has a purpose that is entirely well-defined independent of the application. Therefore, Subsection 2d requires that any application-supplied function or table used by this function must be optional: if the application does not supply it, the square root function must still compute square roots.)

These requirements apply to the modified work as a whole. If identifiable sections of that work are not derived from the Library, and can be reasonably considered independent and separate works in themselves, then this License, and its terms, do not apply to those sections when you distribute them as separate works. But when you distribute the same sections as part of a whole which is a work based on the Library, the distribution of the whole must be on the terms of this License, whose permissions for other licensees extend to the entire whole, and thus to each and every part regardless of how it is used.

Thus, it is not the intent of this section to claim rights or contest your rights to work written entirely by you; rather, the intent is to exercise the right to control the distribution of derivative or collective works based on the Library.

In addition, mere aggregation of another work not based on the Library with the Library (or with a work based on the Library) on a volume of a storage or distribution medium does not bring the other work under the scope of this License.

3. You may not apply the terms of the ordinary GNU General Public License instead of this License to a given copy of the Library. To do this, you must alter all the notices that refer to this License, so that they refer to the ordinary GNU General Public License, version 2, instead of to this License. (If a newer version than version 2 of the ordinary GNU General Public License has appeared, then you can specify that version instead if you wish.) Do not make any other change in these notices. Once this change is made in a given copy, it is irreversible for that copy, so the ordinary GNU General Public License applies to all subsequent copies and derivative works made from that copy. This option is useful when you wish to copy part of the code of the Library into a program that is not a Library.
4. You may copy and distribute the Library (or a portion or derivative of it, under Section 2) in object code or executable form under the terms of Sections 1 and 2 above provided that you accompany it with the complete corresponding machine-readable source code, which must be distributed under the terms of Sections 1 and 2 above on a medium customarily used for software interchange.

If distribution of object code is made by offering access to copy from a designated place, then offering equivalent access to copy the source code from the same place satisfies the requirement to distribute the source code, even though third parties are not compelled to copy the source along with the object code.

5. A program that contains no derivative of any portion of the Library, but is designed to work with the Library by being compiled or linked with it, is called a "work that uses the Library". Such a work, in distribution, is not a derivative work of the Library, and therefore falls outside the scope of this License.

However, linking a "work that uses the Library" with the Library creates an executable that is a derivative of the Library (because it contains portions of the Library), rather than a "work that uses the Library". The executable is therefore covered by this License. Section 6 states terms for distribution of such executables. When a "work that uses the Library" uses material from a header file that is part of the Library, the object code for the work may be a derivative work of the Library even though the source code is not. Whether this is true is especially significant if the work can be linked without the Library, or if the work is itself a Library. The threshold for this to be true is not precisely defined by law.

If such an object file uses only numerical parameters, data structure layouts and accessors, and small macros and small inline functions (ten lines or less in length), then the use of the object file is unrestricted, regardless of whether it is legally a derivative work. (Executables containing this object code plus portions of the Library will still fall under Section 6.)

Otherwise, if the work is a derivative of the Library, you may distribute the object code for the work under the terms of Section 6. Any executables containing that work also fall under Section 6, whether or not they are linked directly with the Library itself.

6. As an exception to the Sections above, you may also combine or link a "work that uses the Library" with the Library to produce a work containing portions of the Library, and distribute that work under terms of your choice, provided that the terms permit modification of the work for the customer's own use and reverse engineering for debugging such modifications. You must give prominent notice with each copy of the work that the Library is used in it and that the Library and its use are covered by this License. You must supply a copy of this License. If the work during execution displays copyright notices, you must include the copyright notice for the Library among them, as well as a reference directing the user to the copy of this License. Also, you must do one of the things:
 - a) Accompany the work with the complete corresponding machine-readable source code for the Library including whatever changes were used in the work (which must be distributed under Sections 1 and 2 above); and, if the work is an executable linked with the Library, with the complete machine-readable "work that uses the Library", as object code and/or source code, so that the user can modify the Library and then relink to produce a modified executable containing the modified Library. (It is understood that the user who changes the contents of definitions files in the Library will not necessarily be able to recompile the application to use the modified definitions.)

- b) Use a suitable shared library mechanism for linking with the Library. A suitable mechanism is one that (1) uses at run time a copy of the library already present on the user's computer system, rather than copying library functions into the executable, and (2) will operate properly with a modified version of the library, if the user installs one, as long as the modified version is interface-compatible with the version that the work was made with.

- c) Accompany the work with a written offer, valid for at least three years, to give the same user the materials specified in Subsection 6a, above, for a charge no more than the cost of performing this distribution.
- d) If distribution of the work is made by offering access to copy from a designated place, offer equivalent access to copy the above specified materials from the same place.
- e) Verify that the user has already received a copy of these materials or that you have already sent this user a copy.

For an executable, the required form of the "work that uses the Library" must include any data and utility programs needed for reproducing the executable from it. However, as a special exception, the materials to be distributed need not include anything that is normally distributed (in either source or binary form) with the major components (compiler, kernel, and so on) of the operating system on which the executable runs, unless that component itself accompanies the executable.

It may happen that this requirement contradicts the license restrictions of other proprietary libraries that do not normally accompany the operating system. Such a contradiction means you cannot use both them and the Library together in an executable that you distribute.

7. You may place library facilities that are a work based on the Library side-by-side in a single library together with other library facilities not covered by this License, and distribute such a combined library, provided that the separate restrictions of the work based on the Library and of the other library facilities is otherwise permitted, and provided that you do these two things:

- a) Accompany the combined library with a copy of the same work based on the Library, uncombined with any other library facilities. This must be distributed under the terms of the Sections above.
- b) Give prominent notice with the combined library of the fact that part of it is a work based on the Library, and explaining where to find the accompanying uncombined form of the same work.

8. You may not copy, modify, sublicense, link with, or distribute the Library except as expressly provided under this License. Any attempt otherwise to copy, modify, sublicense, link with, or distribute the Library is void, and will automatically terminate your rights under this License. However, parties who have received copies, or rights, from you under this License will not have their licenses terminated so long as such parties remain in full compliance.

9. You are not required to accept this License, since you have not signed it. However, nothing else grants you permission to modify or distribute the Library or its derivative works. These actions are prohibited by law if you do not accept this License. Therefore, by modifying or distributing the Library (or any work based on the Library), you indicate your acceptance of this License to do so, and all its terms and conditions for copying, distributing or modifying the Library or works based on it.

10. Each time you redistribute the Library (or any work based on the Library), the recipient automatically receives a license from the original licensor to copy, distribute, link with or modify the Library subject to these terms and conditions. You may not impose any further restrictions on the recipients' exercise of the rights granted herein. You are not responsible for enforcing compliance by third parties with this License.

11. If, as a consequence of a court judgment or allegation of patent infringement or for any other reason (not limited to patent issues), conditions are imposed on you (whether by court order, agreement or otherwise) that contradict the conditions of this License, they do not excuse you from the requirements of this License. If you cannot distribute so as to satisfy simultaneously your obligations under this License and any other pertinent obligations, then as a consequence you may not distribute the Library at all. For example, if a patent license would not permit royalty-free redistribution of the Library by all those who receive copies directly or indirectly through you, then the only way you could satisfy both it and this License would be to refrain entirely from distribution of the Library. If any portion of this section is held invalid or unenforceable under any particular circumstance, the balance of the section is intended to apply, and the section as a whole is intended to apply in other circumstances.

It is not the purpose of this section to induce you to infringe any patents or other property right claims or to contest validity of any such claims; this section has the sole purpose of protecting the integrity of the free software distribution system which is implemented by public license practices. Many people have made generous contributions to the wide range of software distributed through that system in reliance on consistent application of that system; it is up to the author/donor to decide if he or she is willing to distribute software through any other system and a licensee cannot impose that choice.

This section is intended to make thoroughly clear what is believed to be a consequence of the rest of this License.

12. If the distribution and/or use of the Library is restricted in certain countries either by patents or by copyright interfaces, the original copyright holder who places the Library under this License may add an explicit geographical distribution limitation excluding those countries, so that distribution is permitted only in or among countries not thus excluded. In such case, this License incorporates the limitation as if written in the body of this License.

13. The Free Software Foundation may publish revised and/or new versions of the Lesser General Public License from time to time. Such new versions will be similar in spirit to the present version, but may differ in detail to address new problems or concerns.

Each version is given a distinguishing version number. If the Library specifies a version number of this License which applies to it and "any later version", you have the option of following the terms and conditions either of that version or of any later version published by the Free Software Foundation. If the Library does not specify a license version number, you may choose any version ever published by the Free Software Foundation.

14. If you wish to incorporate parts of the Library into other free programs whose distribution conditions are incompatible with these, write to the author to ask for permission. For software which is copyrighted by the Free Software Foundation, write to the Free Software Foundation; we sometimes make exceptions for this. Our decision will be guided by the two goals of preserving the free status of all derivatives of our free software and of promoting the sharing and reuse of software generally.

15. BECAUSE THE LIBRARY IS LICENSED FREE OF CHARGE, THERE IS NO WARRANTY FOR THE LIBRARY, TO THE EXTENT PERMITTED BY APPLICABLE LAW. EXCEPT WHEN OTHERWISE STATED IN WRITING THE COPYRIGHT HOLDERS AND/OR OTHER PARTIES PROVIDE THE LIBRARY "AS IS" WITHOUT WARRANTY OF ANY KIND, EITHER EXPRESSED OR IMPLIED, INCLUDING, BUT NOT LIMITED TO, THE IMPLIED WARRANTIES OF MERCHANTABILITY AND FITNESS FOR A PARTICULAR PURPOSE. THE ENTIRE RISK AS TO THE QUALITY AND PERFORMANCE OF THE LIBRARY IS WITH YOU. SHOULD THE LIBRARY PROVE DEFECTIVE, YOU ASSUME THE COST OF ALL NECESSARY SERVICING, REPAIR OR CORRECTION.

16. IN NO EVENT UNLESS REQUIRED BY APPLICABLE LAW OR AGREED TO IN WRITING WILL ANY COPYRIGHT HOLDER, OR ANY OTHER PARTY WHO MAY MODIFY AND/OR REDISTRIBUTE THE LIBRARY AS PERMITTED ABOVE, BE LIABLE TO YOU FOR DAMAGES, INCLUDING ANY GENERAL, SPECIAL, INCIDENTAL OR CONSEQUENTIAL DAMAGES ARISING OUT OF THE USE OR INABILITY TO USE THE LIBRARY (INCLUDING BUT NOT LIMITED TO LOSS OF DATA OR DATA BEING RENDERED INACCURATE OR LOSSES SUSTAINED BY YOU OR THIRD PARTIES OR A FAILURE OF THE LIBRARY TO OPERATE WITH ANY OTHER SOFTWARE), EVEN IF SUCH HOLDER OR OTHER PARTY HAS BEEN ADVISED OF THE POSSIBILITY OF SUCH DAMAGES.

END OF TERMS AND CONDITIONS

How to Apply These Terms to Your New Libraries

If you develop a new library, and you want it to be of the greatest possible use to the public, we recommend making it free software that anyone can distribute and change. You can do so by permitting redistribution under these terms (or, alternatively, under the terms of the ordinary General Public License).

To apply these terms, attach the following notices to the library. It is safest to attach them to the start of each source file to most effectively convey the exclusion of warranty; and each file should have at least the "copyright" line and a pointer to where the full notice is found.

<one line to give the library's name and a brief idea of what it does.>

Copyright (C) <year> <name of author>
This library is free software; you can redistribute it and/or modify it under the terms of the GNU Lesser General Public

License as published by the Free Software Foundation; either version 2.1 of the License, or (at your option) any later version.

This library is distributed in the hope that it will be useful, but WITHOUT ANY WARRANTY; without even the implied warranty of MERCHANTABILITY or FITNESS FOR A PARTICULAR PURPOSE. See the GNU Lesser General Public License for more details.

You should have received a copy of the GNU Lesser General Public License along with this library; if not, write to the Free Software Foundation, Inc., 51 Franklin Street, Fifth Floor, Boston, MA 02110-1301 USA

Also add information on how to contact you by electronic and paper mail.

You should also get your employer (if you work as a programmer) or your school, if any, to sign a "copyright disclaimer" for the library, if necessary. Here is a sample; alter the names:

Yoodyne, Inc., hereby disclaims all copyright interest in the library "Frob" (a library for tweaking knobs) written by James Random Hacker.

<signature of Ty Coon>, 1 April 1990
Ty Coon, President of Vice

That's all there is to it!

Cautions on use

Moving the player

If you need to move this unit, first remove the disc if there's one loaded, and close the disc tray. Next, press **⏻** **STANDBY/ON** to switch the power to standby, checking that the **POWER OFF** indication on the front panel display goes off. Wait at least 10 seconds. Lastly, disconnect the power cord.

Never lift or move the unit during playback — discs rotate at a high speed and may be damaged.

Place of installation

Select a stable place near the TV and AV system to which the unit is connected.

Do not place the player on top of a TV or color monitor. Keep it away from cassette decks or other components easily affected by magnetism.

Avoid the following types of places:

- Places exposed to direct sunlight
- Humid or poorly ventilated places
- Extremely hot or cold places
- Places subject to vibration
- Dusty places
- Places exposed to soot, steam or heat (in kitchens, etc.)

❖ Do not place objects on top

Do not place objects on top of the player.

❖ Do not obstruct the ventilation holes

Do not use the player on a shaggy rug, bed, or sofa, and do not cover the player with a cloth, etc. Doing so will prevent heat dissipation and could lead to damage.

❖ Keep away from heat

Do not place the player on top of an amplifier or other device generating heat. When installing in a rack, to avoid the heat generated by the amplifier and other devices, place it on a shelf below the amplifier whenever possible.

Turn the power off when not using the player

Depending on the conditions of the TV broadcast signals, striped patterns may appear on the screen when the TV is turned on while the player's power is turned on. This is not a malfunction with the player or TV. If this happens, turn the player's power off. In the same way, noise may be heard in the sound of a radio.

Condensation

If the player is moved suddenly from a cold place into a warm room (in winter, for example) or if the temperature in the room in which the player is installed rises suddenly due to a heater, etc., water droplets (condensation) may form inside (on operating parts and the lens). When condensation is present, the player will not operate properly and playback is not possible. Let the player stand at room temperature for 1 or 2 hours with the power turned on (the time depends on the extent of condensation). The water droplets will dissipate and playback will become possible.

Condensation can also occur in the summer if the player is exposed to the direct wind from an air-conditioner. If this happens, move the player to a different place.

Cleaning the player

Normally, wipe the player with a soft cloth. For tough dirt, apply some neutral detergent diluted in 5 to 6 parts water to a soft cloth, wring out thoroughly, wipe off the dirt, then wipe again with a dry cloth.

Note that getting alcohol, thinner, benzene or insecticide on the player could cause the print and coating to peel off. Also, avoid leaving rubber or vinyl products in contact with the player for long periods of time, as this could damage the cabinet.

When using chemical-impregnated wipes, etc., read the wipe's cautions carefully.

Unplug the power cord from the power outlet when cleaning the player.

Caution for when the unit is installed in a rack with a glass door

Do not press the **▲ OPEN/CLOSE** on the remote control to open the disc tray while the glass door is closed. The door will hamper the movement of the disc tray, and the unit could be damaged.

Cleaning the pickup lens

The player's lens should not become dirty in normal use, but if for some reason it should malfunction due to dust or dirt, consult your nearest Pioneer authorized service center. Although lens cleaners for players are commercially available, we advise against using them since some may damage the lens.

Handling discs

Do not use damaged (cracked or warped) discs.

Do not scratch the disc's signal surface or let it get dirty.

Do not load more than one disc into the player at a time.

Do not glue paper or put stickers onto the disc, or use a pencil, ball-point pen or other sharp-tipped writing instrument. These could all damage the disc.



❖ Storing discs

Always store discs in their cases, and place the cases vertically, avoiding places exposed to high temperatures or humidity, direct sunlight or extremely low temperatures.

Be sure to read the cautions included with the disc.

❖ Cleaning discs

It may not be possible to play the disc if there are fingerprints or dust on it. In this case, using a cleaning cloth, etc., to wipe the disc gently from the center toward the outer edge. Do not use a dirty cleaning cloth.



Do not use benzene, thinner or other volatile chemicals. Also do not use record spray or antistatic agents.

For tough dirt, apply some water to a soft cloth, wring out thoroughly, wipe off the dirt, then wipe off the moisture with a dry cloth.

❖ Specially shaped discs

Specially shaped discs (heart-shaped, hexagonal, etc.) cannot be used on this player. Never use such discs, as they will damage the player.



❖ Condensation on discs

If the disc is moved suddenly from a cold place into a warm room (in winter, for example), water droplets (condensation) may form on the disc surface. Discs will not play properly if there is condensation on them. Carefully wipe off the water droplets from the disc surface before using the disc.

Troubleshooting

Incorrect operation is often mistaken for trouble or malfunction. If you think that there is something wrong with this component, check the points below. Sometimes the trouble may lie in another component. Inspect the other components and electrical appliances being used. If the trouble cannot be rectified even after checking the points below, ask your nearest Pioneer authorized service center or your dealer to carry out repair work.

Playback

Problem	Check	Remedy
<ul style="list-style-type: none"> • Disc does not play. • Disc tray opens automatically. 	Is the disc one that is playable on this player?	Check whether the disc is one that can be played on this player (page 7).
	Is the file one that is playable on this player?	<ul style="list-style-type: none"> • Check whether the file is one that can be played on this player (page 10). • Check whether or not the file is damaged.
	Is the disc scratched?	It may not be possible to play scratched discs.
	Is the disc dirty?	Clean the disc (above).
	Is there a piece of paper or sticker attached to the disc?	The disc may be warped and unplayable.
	Is the disc properly set in the disc tray?	<ul style="list-style-type: none"> • Set the disc with the printed side facing up. • Set the disc properly in the depression in the disc tray.
	Is the region number correct?	See page 9 for the region numbers of discs that can be played on this player.

Problem	Check	Remedy
No picture is displayed or the picture is not displayed properly.	Is the video cable properly connected?	<ul style="list-style-type: none"> • Connect the cable properly according to the connected devices (page 15). • Disconnect the cable (video/audio cable or HDMI cable), then reinsert it firmly and all the way in. • For BDP-LX55, a TV or any other device which outputs video signals must be connected to the HDMI OUT (MAIN) terminal (page 18).
	Is the video cable damaged?	If the cable is damaged, replace it with a new one.
	Is the input setting on the connected TV or AV receiver or amplifier right?	Read the operating instructions for the connected components and switch to the proper input.
	Is the output video resolution properly set?	<ul style="list-style-type: none"> • On the BDP-LX55, switch the resolution at Resolution (page 41). • On the BDP-440/BDP-140, press HDMI to switch the video resolution output from the HDMI OUT terminal (page 12).
	<ul style="list-style-type: none"> • Is the player connected with an HDMI cable other than a High Speed HDMI® cable (with a Standard HDMI® cable)? • Are you using an HDMI cable with a built-in equalizer? 	1080p or Deep Color video signals may not be output properly, depending on the HDMI cable being used or the player's settings. If you wish to output the video signals with 1080p or Deep Color, connect the TV using a High Speed HDMI® cable without a built-in equalizer, then reset the player using the Setup Navigator (page 23).
	Is a DVI device connected?	The picture may not be displayed properly if a DVI device is connected.
Is Color Space properly set?	Change the Color Space setting (page 41).	
For the BDP-LX55: Is the HDMI Mode set appropriately?	Set the HDMI Mode to something other than Pure Audio (page 41).	
Picture freezes and the front panel and remote control buttons stop working.		<ul style="list-style-type: none"> • Press ■ STOP to stop playback, then restart playback. • If the playback cannot be stopped, press ⏻ STANDBY/ON on the player's front panel to turn off the power, then turn the power back on. • If the power cannot be turned off, unplug the power cord, wait several seconds, then plug the power cord back into the outlet.
No picture is displayed or picture is not output in high definition when playing BDs.		With some discs, it may not be possible to output the video signals from the VIDEO output terminal. In this case, connect using an HDMI cable (page 15).
	<ul style="list-style-type: none"> • Picture is disturbed during playback. • Picture is dark. 	<ul style="list-style-type: none"> • This player supports Rovi analog copy protection technology. With some TVs (such as with built-in video deck), the picture will not be displayed properly when the copy protected DVD title is played. This is not a malfunction. • If the player and TV are connected via a DVD recorder/video deck, etc., the picture will not be displayed properly due to analog copy protection. Connect the player and TV directly.
<ul style="list-style-type: none"> • Picture is stretched. • Picture is cropped. • Aspect ratio cannot be switched. 	Is the TV's aspect ratio properly set?	Read the operating instructions for the TV and set the TV's aspect ratio properly.
	Is TV Screen properly set?	Set TV Screen properly (page 39).
		When video signals with a resolution of 1080/50i, 1080/50p, 720/50p, 1080/24p, 1080/60i, 1080/60p or 720/60p are being output from the HDMI OUT terminal, they may be output with an aspect ratio of 16:9 even if TV Screen is set to 4:3 Pan&Scan (page 39).
Picture is interrupted.		The picture may be interrupted when the resolution of the recorded video signal switches. On the BDP-LX55, switch the resolution at Resolution (page 41). On the BDP-440/BDP-140, press HDMI to select a setting other than Auto (page 41).
The subtitles cannot be switched.		The subtitles cannot be switched for discs recorded on a DVD or BD recorder.

Problem	Check	Remedy
<ul style="list-style-type: none"> No sound is output. Sound is not output properly. 	Is the disc played back in slow motion?	No sound is output during slow motion play and forward and reverse scanning.
	Is the disc played back in fast forward or fast reverse?	
	Are the audio cables properly connected?	<ul style="list-style-type: none"> Connect the cable properly according to the connected devices (page 15). Insert the cable firmly and all the way in.
	Is the audio cable damaged?	If the cable is damaged, replace it with a new one.
	Is Audio Output properly set?	Set Audio Output properly, according to the connected device (page 40).
	Are the connected components (AV receiver or amplifier, etc.) properly set?	Read the operating instructions for the connected components and check the volume, input, speaker settings, etc.
	Are you trying to listen to the sound of the HDMI OUT terminal while watching the picture from the VIDEO output terminals?	Audio signals are not output from the HDMI OUT terminal when video signals are being output from the VIDEO output terminals. When watching the picture of the VIDEO output terminals, connect an optical digital audio cable or regular audio cables to listen to the sound (page 20). Once connections are completed, use Setup Navigator to make the player's settings (page 23).
Is HDMI Audio Out properly set?	Set HDMI Audio Out to Re-encode or PCM . (page 41).	
Is a DVI device connected?	The sound will not be output from the HDMI OUT terminal if a DVI device is connected. Connect the device to a DIGITAL OUT terminal or the AUDIO OUT terminals (page 20).	
	For some BDs, audio signals are only output from DIGITAL OUT terminal or the HDMI OUT terminal.	
	For the BDP-LX55: Is the HDMI Mode set appropriately?	Set the HDMI Mode properly, according to the connected device (page 41).
Multi-channel sound is not output.	Is the audio output of the connected AV receiver or amplifier, etc., properly set?	Read the operating instructions for the connected AV receiver or amplifier and check the audio output settings of the AV receiver or amplifier.
	Is multi-channel sound selected?	Use the menu screen or AUDIO to switch the disc's sound to multi-channel.
Noise can be heard when outputting DTS Digital Audio signals from the DIGITAL OUT terminal.	Is the connected AV receiver or amplifier compatible with DTS Digital Surround?	If an AV receiver or amplifier that is not compatible with DTS Digital Surround is connected to the DIGITAL OUT terminal, set Digital Output to PCM (page 40).
192 kHz or 96 kHz digital audio signals cannot be output from the DIGITAL OUT terminal.		It is not possible to output 192 kHz or 96 kHz digital audio signals from this player's DIGITAL OUT terminal. The signals are automatically converted to 48 kHz or less for output.
Secondary audio or interactive audio is not output.	Is HDMI Audio Out properly set?	When listening to the sound from an HDMI OUT terminal, set HDMI Audio Out to PCM (page 41).
	Are Digital Output properly set?	When listening to the sound from an DIGITAL OUT terminal, set Digital Output to Re-encode or PCM (page 40).
Sound is fast or slow. (Only for BDP-LX55 and BDP-440)	When an HDMI cable is connected, are audio signals being output from devices connected with cables other than HDMI cables?	When a Pioneer AV receiver or amplifier compatible with the PQLS function is connected directly to the player's HDMI OUT terminal using an HDMI cable, the PQLS function is activated when playing an audio CD (CD-DA). Because of this, the sound output from components other than the ones connected by an HDMI cable may be fast or slow. If this happens, set Control to Off (page 41).
After a disc is inserted, Loading stays displayed and playback does not start.	Are there too many files recorded on the disc?	When a disc on which files are recorded is inserted, depending on the number of files recorded on the disc, loading may take several dozen minutes.
■ is displayed in file names, etc.		The characters that cannot be displayed on this player are displayed in ■.
A message indicating low memory appears while playing a BD-ROM disc.		<ul style="list-style-type: none"> Connect a USB memory device (page 21). Erase the data stored on the connected USB memory device from BUDA Setup (page 45).

Control function

Problem	Check	Remedy
Control function does not work.	Is the HDMI cable properly connected?	To use the Control function, connect the Flat Screen TV and AV system (AV receiver or amplifier, etc.) to the HDMI OUT terminal (page 15).
	Is the HDMI cable you are using a High Speed HDMI® Cable?	Use a High Speed HDMI® Cable. The Control function may not work properly if an HDMI cable other than a High Speed HDMI® Cable is used.
	Is this player connected to the TV using an HDMI cable to watch the picture?	If video signals are being output from a terminal other than the HDMI OUT terminal, the Control function does not work. Connect to the TV using an HDMI cable (page 15).
	For the BDP-LX55: Is the HDMI Mode set appropriately?	When both of the HDMI OUT terminals (MAIN and SUB) are used, the Control function only works for the HDMI OUT (SUB) terminal (page 16).
	Is Control set to On on the player?	Set Control to On on the player (page 41).
	Does the connected device support the Control function?	<ul style="list-style-type: none"> • The Control function will not work with devices of other brands that do not support the Control function, even when connected using an HDMI cable. • The Control function will not work if devices that do not support the Control function are connected between the Control-compatible device and the player. • See page 16. • Even when connected to a Pioneer product compatible with the Control function, some of the functions may not work. Also refer to the operating instructions for the connected device.
	Is Control set to On on the connected device?	Set Control to On on the connected device. The Control function operates when Control is set to On for all devices connected to the HDMI OUT terminal. Once connections and settings of all the devices are finished, be sure to check that the player's picture is output to the Flat Screen TV. (Also, check after changing the connected devices and connecting and/or disconnecting HDMI cables.) If the player's picture is not being output to the Flat Screen TV, the Control function may not work properly. For details, refer to the operating instructions of the connected device.
Are multiple players connected?	The Control function may not work if three or more players, including this player, are connected by an HDMI cable.	

Network

Problem	Check	Remedy
<ul style="list-style-type: none"> • BD-LIVE function (connection to the Internet) cannot be used. • "No valid id file found!" is displayed when I try to update the software. 		Perform Connection Test (page 45). If "Networks is OK." is displayed, check the proxy server settings (page 44). Also, there may be a problem with the Internet connection. Contact your Internet service provider.
	Software updating is slow.	Depending on the Internet connection and other conditions, some time may be required to update the software.

Problem	Check	Remedy
A message other than "Networks is OK." is displayed when Connection Test is performed.	Is "Network is FAILED." displayed?	<ul style="list-style-type: none"> • Check that this player and the Ethernet hub (or router with a hub functionality) are properly connected. • If the IP address is obtained using the DHCP server function, check the setting is correct at the Information (page 41). For details on the DHCP server function, see the operating instructions for the Ethernet hub (or router with a hub functionality). • Set the IP address manually. • Check the operation and settings of the DHCP server function of the Ethernet hub (or router with hub functionality). For details on the DHCP server function, see the operating instructions for the Ethernet hub (or router with a hub functionality). • If this player has been set manually, reset the IP address of this player or other components.
	Is the Ethernet hub (or router with a hub functionality) operating properly?	<ul style="list-style-type: none"> • Check the settings and operation the Ethernet hub (or router with a hub functionality). For details, see the operating instructions for the Ethernet hub. • Reboot the Ethernet hub (or router with a hub functionality).

Others

Problem	Check	Remedy
The player's power turns off automatically.	Is Auto Power Off set to 10 min/20 min/30 min ?	If Auto Power Off is set to 10 min/20 min/30 min , the player's power turns off automatically if no operation is performed for over 30 minutes (page 43).
The player's power turns on automatically.	Is Control set to On ?	The player's power may turn on together with the power of the TV connected to the HDMI OUT terminal. If you do not want the player's power to turn on when the TV's power is turned on, set Control to Off (page 41).
The player cannot be operated with the remote control.	Are you operating the remote control from a point too far away from the player? Are the batteries dead?	Operate from within 7 m of the remote control sensor. Replace the batteries (page 5).
Input of the connected TV and AV system switches automatically.	Is Control set to On ?	The input of the TV and AV system (AV receiver or amplifier, etc.) connected to the HDMI OUT terminal may automatically switch to the player when playback starts on the player or the menu screen (Home Media Gallery, etc.) is displayed. If you do not want the inputs of the connected TV and AV system (AV receiver or amplifier, etc.) to switch automatically, set Control to Off (page 41).
Settings I have made have been cleared.	<ul style="list-style-type: none"> • Have you disconnected the power cord while the player's power was on? • Has there been a power failure? 	Always press ⏻ STANDBY/ON on the player's front panel or ⏻ STANDBY/ON on the remote control and check that POWER OFF has turned off from the player's front panel display before disconnecting the power cord. Be particularly careful when the power cord is connected to the AC outlet on another device because the player turns off in conjunction with the device.

Problem	Check	Remedy
USB (external storage) device does not work with this player properly.	Is the USB device properly connected?	<ul style="list-style-type: none"> • Turn the player's power off, then turn the power back on. • Turn the player's power off, then reconnect the external storage device (page 21).
	Is the USB device connected via an extension cable?	Do not use an extension cable. The player may not work properly with it.
	Is the external storage device connected to the USB port via a memory card reader or USB hub?	External storage device may not work if connected to the USB port via a memory card reader or USB hub.
	Does the external storage device contain multiple partitions?	External storage devices may not be recognized if they contain multiple partitions. Some external storage devices may not operate.
	Is the external storage device write-protected?	Turn the player's power off, then disable the write-protection.
	Is the external storage device's file system FAT16 or FAT32?	Only external storage devices with a FAT16 or FAT32 file system can be used. Turn the player's power off, then turn the power back on.

Glossary

❖ Angle (Multi angle)

Up to 9 camera angles can be recorded simultaneously on BD-ROM or DVD-Video discs, letting you view the same scene from different angles.

❖ AVCHD (Advanced Video Codec High Definition)

See page 9.

❖ AVCREC

See page 9.

❖ BDAV

Of the BD format, the Audio Visual Format Specifications for HD digital broadcast recording is referred to as BDAV on this player and in these operating instructions.

❖ BD-J

See page 9.

❖ BD-LIVE

See page 8.

❖ BDMV

Of the BD format, the Audio Visual Format Specifications designed for pre-packaged high definition (HD) movie contents is referred to as BDMV on this player and in these operating instructions.

❖ BONUSVIEW

See page 8.

❖ Deep Color

See page 15.

❖ Default Gateway

A default gateway is a communication device such as a router which passes data between networks. It is used to direct data to networks on which the destination gateway is not explicitly specified.

❖ DHCP (Dynamic Host Configuration Protocol)

This protocol provides configuration parameters (IP address, etc.) for computers and other devices connected to the network.

❖ DivX

See page 10.

❖ DNS (Domain Name System)

This is a system for associating Internet host names with IP addresses.

❖ Dolby Digital

Dolby Digital is an audio format to record the sound in up to 5.1 channels with a fraction of the amount of data as compared to linear PCM audio signals.

❖ Dolby Digital Plus

Dolby Digital Plus is an audio format for high-definition media. Built on Dolby Digital, it combines the efficiency and flexibility to provide high quality multi-channel audio. With BD-ROMs, up to 7.1 channels of digital sound can be recorded.

❖ Dolby TrueHD

Dolby TrueHD is an audio format using lossless coding. With BD-ROMs, up to 8 channels can be recorded at 96 kHz/24 bits, or up to 6 channels at 192 kHz/24 bits.

❖ DRM

A technology for protecting copyrighted digital data. Digitized videos, images and audio retain the same quality even when they are copied or transferred repeatedly. DRM is a technology for restricting the distribution or playback of such digital data without the authorization of the copyright holder.

❖ **DTS Digital Surround**

DTS Digital Surround is an audio format to record 48 kHz/24 bits audio signals in 5.1 channels.

❖ **DTS-HD High Resolution Audio**

DTS-HD High Resolution Audio is an audio format using lossy coding. It can record 7.1 channels at 96 kHz/24 bits.

❖ **DTS-HD Master Audio**

DTS-HD Master Audio is an audio format using lossless coding. With BD-ROMs, 7.1 channels can be recorded at 96 kHz/24 bits, or 5.1 channels at 192 kHz/24 bits.

❖ **Ethernet**

A standard for local area networks (LANs) used to connect multiple computers, etc. in the same location. This player supports 100BASE-TX.

❖ **Frames and fields**

A frame is the unit for one of the still pictures which compose motion pictures. One frame consists of a picture of odd lines and a picture of even lines called fields in video signal with interlaced scan method (576i, 1080i, etc.).

❖ **HDMI (High-Definition Multimedia Interface)**

See page 15.

❖ **Interactive audio**

The audio signals recorded in the titles of BD-ROMs. They include for example the clicking sound made when the menu screen is operated.

❖ **Interlaced scan**

With this method, one picture is displayed by scanning it twice. The odd lines are displayed in the first pass, the even lines are displayed in the second, to form a single picture (frame). Interlaced scan is indicated in this player and operating instructions by an "i" after the resolution value (for example, 576i).

❖ **IP address**

An address that identifies a computer or other device connected to the Internet or local area network. It is represented a number in four sections.

❖ **Linear PCM**

This is referred as the audio signals that are not compressed.

❖ **MAC (Media Access Control) address**

A hardware identification number assigned specifically to the network device (LAN card, etc.).

❖ **MPEG (Moving Picture Experts Group)**

The name of a family of standards used to encode video and audio signals in a digital compressed format. The video encoding standards include MPEG-1 Video, MPEG-2 Video, MPEG-4 Visual, MPEG-4 AVC, etc. The audio encoding standards include MPEG-1 Audio, MPEG-2 Audio, MPEG-2 AAC, etc.

❖ **Parental Lock**

See page 46.

❖ **Picture-in-Picture (P-in-P)**

This is a function for superimposing a sub video on the main video. Some BD-ROMs include secondary video, which can be superimposed on the primary video.

❖ **Port number**

This is a sub-address provided below the IP address for simultaneously connecting to multiple parties during Internet communications.

❖ **Progressive scan**

With this method, one picture is consisted of a single picture, without dividing it in two pictures. Progressive scan provides clear pictures with no flicker, in particular for still pictures that contain much text, graphics, or horizontal lines. Progressive scan is indicated in this player and operating instructions by a "p" after the resolution value (for example, 576p).

❖ **Proxy server**

This is a relay server for ensuring fast access and safe communications when connecting to the Internet from an internal network.

❖ **Region number**

See page 9.

❖ **Secondary audio**

Some BD-ROMs include sub audio streams mixed with the main audio stream. These sub audio streams are called "secondary audio". On some discs this secondary audio is recorded as the audio for the secondary video.

❖ **Secondary video**

Some BD-ROMs include sub videos superimposed on the main videos using the Picture-in-Picture function. These sub videos are called "secondary video".

❖ **Subnet mask**

This is used to identify which part of the IP address corresponds to the subnet (a separately managed network). The subnet mask is expressed as '255.255.255.0'.

❖ **USB (Universal Serial Bus)**

USB is the industry standard for connecting peripherals to PCs.

❖ **VC-1**

A video codec developed by Microsoft and standardized by the Society of Motion Picture and Television Engineers (SMPTE). Some BDs include videos encoded in this codec.

❖ **x.v.Color**

See page 15.

Specifications

Model	BDP-LX55 BDP-440 BDP-140		
Type	Blu-ray 3D™ PLAYER		
Rated voltage	AC 100 V to 240 V AC 110 V to 240 V (Duty-free model in Japan only)		
Rated frequency	50 Hz/60 Hz		
Power consumption	BDP-LX55: 25 W BDP-440, BDP-140: 23 W		
Power consumption (standby)	BDP-LX55: 0.5 W BDP-440, BDP-140: 0.3 W		
Weight	BDP-LX55: 3.5 kg BDP-440: 2.6 kg BDP-140: 2.1 kg		
External dimensions (including projecting parts)	BDP-LX55: 435 mm (W) x 93 mm (H) x 252 mm (D) BDP-440: 435 mm (W) x 90 mm (H) x 252 mm (D) BDP-140: 435 mm (W) x 58 mm (H) x 249 mm (D)		
Tolerable operating temperature	+5 °C to +35 °C		
Tolerable operating humidity	5 % to 85 % (no condensation)		
Output terminals	HDMI	BDP-LX55: 2 set, 19-pin: 5 V, 250 mA BDP-440, BDP-140: 1 set, 19-pin: 5 V, 250 mA	
	Video outputs	1 set, RCA jack: 1.0 Vp-p (75 Ω)	
	Audio outputs	2-channel (left/right)	1 set, RCA jacks
		Audio output level	200 mVrms (1 kHz, -20 dB)
		Frequency response	4 Hz to 88 kHz (192 kHz sampling)
	Digital audio outputs	Optical	1 set, Optical digital jack
LAN	1 set, Ethernet jack (10BASE-T/100BASE-TX)		
USB	2 set, Type A		



Note

- The specifications and design of this product are subject to change without notice.

Please refer to our website for information regarding software updates and service to this product.

Contact information:

U.K.

Pioneer GB LTD.
Hollybush Hill, Stoke Poges Slough, Buckinghamshire SL2 4QP UNITED KINGDOM
0330 123 1240 or 0870 600 1539
<http://www.pioneer.co.uk/uk/content/support/support/upgrade.html>
<http://www.pioneer.eu/support>

Australia, New Zealand and other Oceania area

<http://www.pioneer.com.au>

Hong Kong

Pioneer (HK) Limited - Customer Service Center
Unit 2, 17/F, Vanta Industrial Centre, 21-33 Tai Lin Pai Road, Kwai Chung, Hong Kong
(852) 3583 3288
<https://www.pioneerhongkong.com.hk>

Singapore

Pioneer Electronics AsiaCentre Pte Ltd
253 Alexandra Road (Komoco Building)#04-01, Lobby 2 Singapore 159936
(65) 6472-7555
<http://www.pioneer.com.sg/firmwaredownload>

Malaysia

Pioneer Technology (Malaysia) Sdn Bhd
16th Floor, Menara Uni. Asia, 1008, Jalan Sultan Ismail 50250, Kuala Lumpur, Malaysia
(03) 2697-2920
<http://www.pioneer.com.sg/firmwaredownload>

Thailand

Pioneer Electronics (Thailand) CO.,LTD
91/1 Floor 1&7 Chaiyo Building, Rama 9 Road, Huaykwang District Bangkok 10320, Thailand
(662) 6439-444
<http://www.pioneer.com.sg/firmwaredownload>

Taiwan

Pioneer High Fidelity Taiwan Co. Ltd
13th Floor, No.44, Chung Shan North Road, Sec.2 Taipei, Taiwan
(886 2) 2521-3166
<http://www.pioneer-twn.com.tw>

Indonesia

PT. Adab Alam Electronic
Jl. K.H. Zainul Arifin No. 13A Jakarta-Pusat Indonesia
(21) 6331-924
<http://www.pioneer.com.sg/firmwaredownload>

© 2011 PIONEER CORPORATION.
All rights reserved.

PIONEER CORPORATION

1-1, Shin-ogura, Saiwai-ku, Kawasaki-shi, Kanagawa 212-0031, Japan

PIONEER ELECTRONICS (USA) INC.

P.O. BOX 1540, Long Beach, California 90801-1540, U.S.A. TEL: (800) 421-1404

PIONEER ELECTRONICS OF CANADA, INC.

340 Ferrier Street, Unit 2, Markham, Ontario L3R 2Z5, Canada TEL: 1-877-283-5901, 905-479-4411

PIONEER EUROPE NV

Haven 1087, Keetberglaan 1, B-9120 Melsele, Belgium TEL: 03/570.05.11

PIONEER ELECTRONICS ASIACENTRE PTE. LTD.

253 Alexandra Road, #04-01, Singapore 159936 TEL: 65-6472-7555

PIONEER ELECTRONICS AUSTRALIA PTY. LTD.

5 Arco Lane, Heatherton, Victoria, 3202, Australia, TEL: (03) 9586-6300

PIONEER ELECTRONICS DE MEXICO S.A. DE C.V.

Blvd.Manuel Avila Camacho 138 10 piso Col.Lomas de Chapultepec, Mexico, D.F.11000 TEL: 55-9178-4270

K002_B3_En



72-DPLX55-EN0B1

Free Manuals Download Website

<http://myh66.com>

<http://usermanuals.us>

<http://www.somanuals.com>

<http://www.4manuals.cc>

<http://www.manual-lib.com>

<http://www.404manual.com>

<http://www.luxmanual.com>

<http://aubethermostatmanual.com>

Golf course search by state

<http://golfingnear.com>

Email search by domain

<http://emailbydomain.com>

Auto manuals search

<http://auto.somanuals.com>

TV manuals search

<http://tv.somanuals.com>