

DMP-BD65



Model No. **DMP-BD65**  
**DMP-BD45**

**Basic Operating Instructions**  
Blu-ray Disc Player

*English*

**Mode d'emploi de base**  
Lecteur de Blu-ray Disc

*Français*

**Istruzioni per l'uso di base**  
Lettore Blu-ray Disc

*Italiano*

**Instrucciones básicas de funcionamiento**  
Reproductor de Blu-ray Disc

*Español*

**Beknopte gebruiksaanwijzing**  
Blu-ray Disc speler

*Nederlands*

**Grundläggande bruksanvisning**  
Blu-ray-skiva spelare

*Svenska*

**Vejledning i den grundlæggende betjening**  
Blu-Ray-diskafspiller

*Dansk*

**Základní Návod k použití**  
Přehrávač disků Blu-ray

*Česky*

**Kezelési utasítás kezdőknek**  
Blu-ray lemez lejátszó

*Magyar*

**Skrócona instrukcja obsługi**  
Odtwarzacz płyt Blu-ray

*Polski*

**Perusasetukset Käyttöohjeet**  
Blu-ray-levysoitin

*Suomi*



Please also refer to Operating Instructions (PDF format) recorded on the CD-ROM containing the Operating Instructions (supplied).



Operating Instructions (PDF format) cannot be played back on the player itself.

You can learn about advanced operation methods and check the Troubleshooting. (⇒ 3)

#### CAUTION!

THIS PRODUCT UTILIZES A LASER.  
USE OF CONTROLS OR ADJUSTMENTS OR PERFORMANCE OF PROCEDURES OTHER THAN THOSE SPECIFIED HEREIN MAY RESULT IN HAZARDOUS RADIATION EXPOSURE.  
DO NOT OPEN COVERS AND DO NOT REPAIR YOURSELF.  
REFER SERVICING TO QUALIFIED PERSONNEL.

#### WARNING:

- TO REDUCE THE RISK OF FIRE, ELECTRIC SHOCK OR PRODUCT DAMAGE,
- DO NOT EXPOSE THIS APPARATUS TO RAIN, MOISTURE, DRIPPING OR SPLASHING AND THAT NO OBJECTS FILLED WITH LIQUIDS, SUCH AS VASES, SHALL BE PLACED ON THE APPARATUS.
  - USE ONLY THE RECOMMENDED ACCESSORIES.
  - DO NOT REMOVE THE COVER (OR BACK); THERE ARE NO USER SERVICEABLE PARTS INSIDE. REFER SERVICING TO QUALIFIED SERVICE PERSONNEL.

#### CAUTION!

- DO NOT INSTALL OR PLACE THIS UNIT IN A BOOKCASE, BUILT-IN CABINET OR IN ANOTHER CONFINED SPACE. ENSURE THE UNIT IS WELL VENTILATED. TO PREVENT RISK OF ELECTRIC SHOCK OR FIRE HAZARD DUE TO OVERHEATING, ENSURE THAT CURTAINS AND ANY OTHER MATERIALS DO NOT OBSTRUCT THE VENTILATION VENTS.
- DO NOT OBSTRUCT THE UNIT'S VENTILATION OPENINGS WITH NEWSPAPERS, TABLECLOTHS, CURTAINS, AND SIMILAR ITEMS.
- DO NOT PLACE SOURCES OF NAKED FLAMES, SUCH AS LIGHTED CANDLES, ON THE UNIT.
- DISPOSE OF BATTERIES IN AN ENVIRONMENTALLY FRIENDLY MANNER.

#### CAUTION

Danger of explosion if battery is incorrectly replaced. Replace only with the same or equivalent type recommended by the manufacturer. Dispose of used batteries according to the manufacturer's instructions.

This product may receive radio interference caused by mobile telephones during use. If such interference is apparent, please increase separation between the product and the mobile telephone.

The socket outlet shall be installed near the equipment and easily accessible.  
The mains plug of the power supply cord shall remain readily operable.

To completely disconnect this apparatus from the AC Mains, disconnect the power supply cord plug from AC receptacle.

THIS UNIT IS INTENDED FOR USE IN MODERATE CLIMATES.

## Dear customer

Thank you for purchasing this product.  
For optimum performance and safety, please read these instructions carefully.  
Before connecting, operating or adjusting this product, please read the instructions completely.  
Please keep this manual for future reference.

## Safety precautions

### ■ Placement

Set the unit up on an even surface away from direct sunlight, high temperatures, high humidity, and excessive vibration. These conditions can damage the cabinet and other components, thereby shortening the unit's service life. Do not place heavy items on the unit.

### ■ Voltage

Do not use high voltage power sources. This can overload the unit and cause a fire. Do not use a DC power source. Check the source carefully when setting the unit up on a ship or other place where DC is used.

### ■ AC mains lead protection

Ensure the AC mains lead is connected correctly and not damaged. Poor connection and lead damage can cause fire or electric shock. Do not pull, bend, or place heavy items on the lead.

Grasp the plug firmly when unplugging the lead. Pulling the AC mains lead can cause electric shock. Do not handle the plug with wet hands. This can cause electric shock.

### ■ Foreign matter

Do not let metal objects fall inside the unit. This can cause electric shock or malfunction.

Do not let liquids get into the unit. This can cause electric shock or malfunction. If this occurs, immediately disconnect the unit from the power supply and contact your dealer.

Do not spray insecticides onto or into the unit. They contain flammable gases which can ignite if sprayed into the unit.

### ■ Service

Do not attempt to repair this unit by yourself. If sound is interrupted, indicators fail to light, smoke appears, or any other problem that is not covered in these instructions occurs, disconnect the AC mains lead and contact your dealer or an authorized service centre. Electric shock or damage to the unit can occur if the unit is repaired, disassembled or reconstructed by unqualified persons.

Extend operating life by disconnecting the unit from the power source if it is not to be used for a long time.

#### To dispose or transfer this unit

The unit may keep the user settings information in the unit. If you discard this unit either by disposal or transfer, then follow the procedure to return all the settings to the factory presets to delete the user settings.

- The operation history may be recorded in the memory of this unit.

# Table of contents

## Getting started

Safety precautions . . . . .	2
Reading the Operating Instructions (PDF format) . . . . .	3
Accessory . . . . .	3
Playable discs/Cards/USB devices . . . . .	4
<b>Connection and setting</b>	
STEP 1 : Connecting to a TV . . . . .	6
STEP 2 : Connecting to an amplifier/receiver . . . . .	6

STEP 3 : Connecting to a broadband network BD65 . . . . .	7
STEP 4 : Setting . . . . .	7

## Playback

Inserting or removing a media . . . . .	8
Playing video contents . . . . .	8
Linked operations with the TV (VIERA Link "HDAVI Control™") . . . . .	9
Specifications . . . . .	10

# Reading the Operating Instructions (PDF format)

## ■ For Windows

- 1 Turn the PC on and insert the CD-ROM containing the Operating Instructions (supplied).
- 2 Select the desired language and then click [Operating Instructions] to install.
- 3 Double click the "BD65\_45EG Operating Instructions" shortcut icon on the desktop.

### When the Operating Instructions (PDF format) will not open

You will need Adobe Acrobat Reader 4.0 or later or Adobe Reader 6.0 or later to browse or print the Operating Instructions (PDF format).  
Download and install a version of Adobe Reader that you can use with your OS from the following Web Site.  
<http://get.adobe.com/reader/otherversions>

### If using the following OS

- Windows 2000 SP4
- Windows XP SP2/SP3
- Windows Vista
- Windows 7

Insert the CD-ROM containing the Operating Instructions (supplied), click [Adobe(R) Reader(R)] and then follow the messages on the screen to install.

### To uninstall the Operating Instructions (PDF format)

Delete the PDF file from the "Program Files\Panasonic\DMP" folder.

- When the contents in the Program Files folder cannot be displayed, click the [Show the contents of this folder] to display them.

## ■ For Macintosh

- 1 Turn the PC on and insert the CD-ROM containing the Operating Instructions (supplied).
- 2 Open the "Manual" folder in "VFF0537" and then copy the PDF file with the desired language inside the folder.
- 3 Double click the PDF file to open it.

# Accessory

Check the supplied accessories before using this unit.

## 1 Remote control

- BD65 (N2QAKB000077)
- BD45 (N2QAKB000079)

## 2 Batteries for remote control

- 1 AC mains lead
- 1 CD-ROM



- Product numbers correct as of December 2009. These may be subject to change.
- Do not use AC mains lead with other equipment.

## Using the remote control

Insert so the poles (+ and -) match those in the remote control.

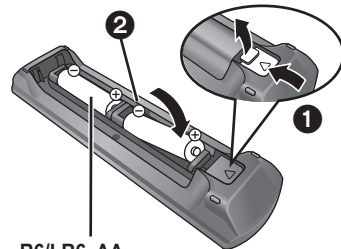

R6/LR6, AA

(Alkaline or manganese batteries)











Point it at remote control signal sensor on this unit.



Mishandling of batteries can cause electrolyte leakage which can damage items the fluid contacts and may cause a fire.

- Do not mix old and new batteries or different types at the same time.
  - Do not heat or expose to flame.
  - Do not leave the battery(ies) in an automobile exposed to direct sunlight for a long period of time with doors and windows closed.
  - Do not take apart or short circuit.
  - Do not attempt to recharge alkaline or manganese batteries.
  - Do not use batteries if the covering has been peeled off.
- Remove batteries if the remote control is not going to be used for a long period of time. Store in a cool, dark place.

# Playable discs/Cards/USB devices

Type	Logo examples	Type detail	Playable contents
BD		BD-Video	Video
		BD-RE	Video JPEG
		BD-R	Video DivX®
DVD		DVD-Video	Video
		DVD-RAM	Video AVCHD JPEG
		DVD-R	Video AVCHD DivX MP3 JPEG
		DVD-R DL	
		DVD-RW	Video AVCHD
	—	+R/+RW/+R DL	
CD		Music CD	Music [CD-DA]
	—	CD-R CD-RW	DivX Music [CD-DA] MP3 JPEG
SD		<b>SD Memory Card (from 8 MB to 2 GB)</b> (Including miniSD Card and microSD Card) <b>SDHC Memory Card (from 4 GB to 32 GB)</b> (Includes microSDHC Card) <b>SDXC Memory Card (48 GB, 64 GB)</b> (Includes microSDXC Card)	MPEG2 AVCHD JPEG
USB	—	<b>USB device</b> (up to 128 GB)	DivX MP3 JPEG

## ■ Discs that cannot be played in this unit

Any other disc that is not specifically supported or previously described.

- 2.6 GB and 5.2 GB DVD-RAM
- DVD-RAM that cannot be removed from their cartridges
- Super Audio CD
- Photo CD
- DVD-Audio
- Video CD and Super Video CD
- WMA discs
- HD DVD

## ■ Region management information

### BD-Video

This unit plays BD-Video marked with labels containing the region code "B".

Example:



### DVD-Video

This unit plays DVD-Video marked with labels containing the region number "2" or "ALL".

Example:



## ■ Finalize

DVD-R/RW/R DL, +R/+RW/+R DL and CD-R/RW recorded by a recorder, etc. needs to be finalized by the recorder to play on this unit. Please refer to the recorder's instructions.

## ■ BD-Video

- Please enjoy BD-Live functions, such as the network connection. The various functions differ depending on the disc.
- This unit supports high bit rate audio (Dolby Digital Plus, Dolby TrueHD, DTS-HD High Resolution Audio and DTS-HD Master Audio) adopted in BD-Video.

## ■ Music CD

Operation and sound quality of CDs that do not conform to CD-DA specifications (copy control CDs, etc.) cannot be guaranteed.



- It may not be possible to play the above media in some cases due to the type of media, the condition of the recording, the recording method and how the files were created.
- The producers of the disc can control how discs are played. So you may not always be able to control play as described in these operating instructions. Read the disc's instructions carefully.

## ■ SD card

- MiniSD Cards, microSD Cards, microSDHC Cards and microSDXC Cards can be used, but must be used with an adaptor card. These are usually supplied with such cards, or otherwise customer provided.
- Keep the Memory Card out of reach of children to prevent swallowing.
- To protect the card's contents, move the record prevention tab (on the SD card) to "LOCK".
- This unit is compatible with SD Memory Cards that meet SD Card Specifications FAT12 and FAT16 formats, as well as SDHC Memory Cards in FAT32 format (Does not support long file name.) and SDXC Memory Cards in exFAT.
- If the SD card is used with incompatible computers or devices, recorded contents may be erased due to the card being formatted etc.
- Useable memory may be slightly less than the card capacity.



## ■ USB device

- This unit supports connecting a USB memory, digital camera and video camera produced by Panasonic, etc. It is not warranted that all USB devices will work with this unit.
- This unit does not support USB device charging.
- FAT12, FAT16 and FAT32 file systems are supported.
- This unit supports USB 2.0 High Speed.

## ■ BD-RE, BD-R

Discs recorded in DR mode using Panasonic Blu-ray Disc recorders may not playback the audio etc., correctly.

## STEP 1 : Connecting to a TV

- Do not place the unit on amplifiers/receiver or equipment that may become hot. The heat can damage the unit.
- Before making any connections we suggest you temporarily disconnect all the units from AC power.
- Do not connect video signals through a video recorder. Due to copy guard protection the picture may not be displayed properly.
- Please use High Speed HDMI Cables that have the HDMI logo (as shown on the cover). It is recommended that you use Panasonic's HDMI cable. When outputting 1080p signal, please use HDMI cables 5.0 meters or less.

Recommended part number:

RP-CDHS15 (1.5 m), RP-CDHS30 (3.0 m),

RP-CDHS50 (5.0 m), etc.

### ■ Via an HDMI AV OUT terminal

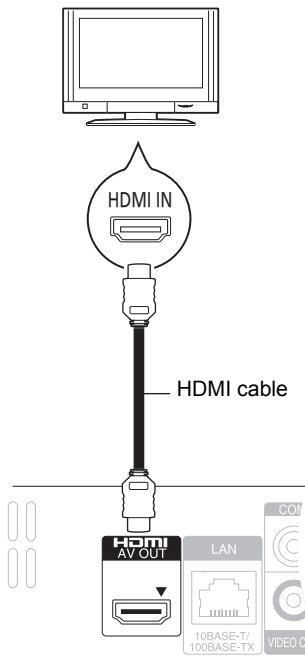

- The HDMI connection supports VIERA Link "HDAVI Control" (⇒ 9) when used with a compatible Panasonic TV.
- Set "HDMI Video Mode" [BD65] and "HDMI Audio Output" to "On" ([FUNCTION MENU]⇒"To Others"⇒"Setup"⇒"TV / Device Connection"⇒"HDMI Connection").

## STEP 2 : Connecting to an amplifier/receiver

### ■ Via an HDMI AV OUT terminal

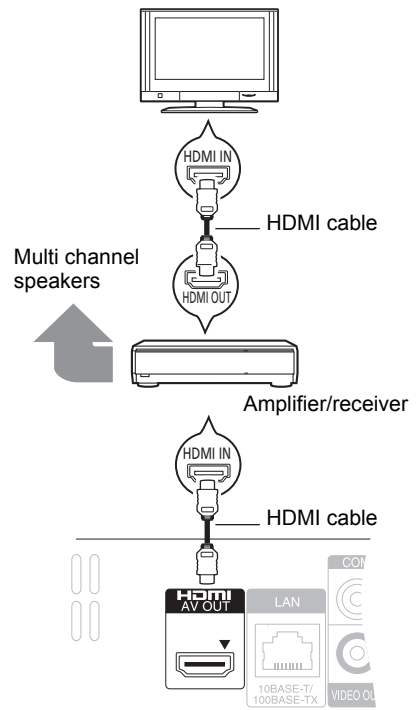

- The HDMI connection supports VIERA Link "HDAVI Control" (⇒ 9) when used with a compatible Panasonic TV.
- Set "HDMI Video Mode" [BD65] and "HDMI Audio Output" to "On" ([FUNCTION MENU]⇒"To Others"⇒"Setup"⇒"TV / Device Connection"⇒"HDMI Connection").
- Set "Digital Audio Output" depending on the used terminal and connected amplifier/receiver. ([FUNCTION MENU]⇒"To Others"⇒"Setup"⇒"Sound")

## STEP 3 : Connecting to a broadband network BD65

The following services can be used when this unit is connected to broadband.

- Firmware can be updated
- You can enjoy the BD-Live
- You can enjoy the VIERA CAST

For details about connection method, refer to the instructions supplied with the connected equipment.

- The unit is not compatible with public wireless LAN services (Hotspot etc.) provided in airports, stations, cafes etc.

### ■ Using LAN (ethernet) cable

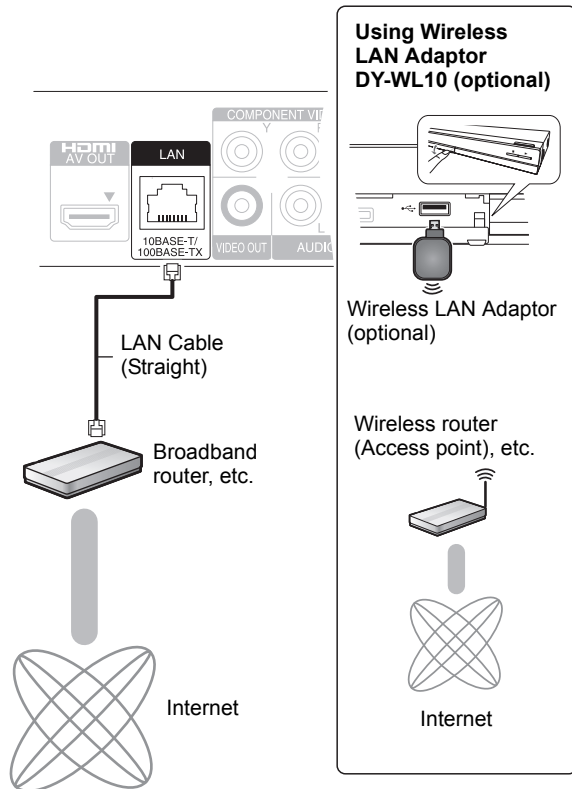

- Use shielded LAN cables when connecting to peripheral devices.
- Inserting any cable other than a LAN cable in the LAN terminal can damage the unit.
- Only the Wireless LAN Adaptor DY-WL10 (optional) can be used.
- When connection conditions are poor, use the USB extension cable supplied with the Wireless LAN Adaptor DY-WL10 (optional).
- Read the operating instructions for the Wireless LAN Adaptor DY-WL10 (optional) thoroughly when using it.
- For up to date compatibility information on your Wireless router (Access Point) refer to <http://panasonic.jp/support/global/cs/>

## STEP 4 : Setting

### Easy Setting

After connecting your new player for the first time and pressing the [⏻], a screen for the basic settings will appear.

#### Preparation

Turn on the television and select the appropriate video input on the television.

#### 1 Press [⏻].

Setup screen appears.

If this unit is connected to a Panasonic TV (VIERA) supporting HDAVI Control 2 or later via an HDMI cable, then the setting information on the TV is acquired by this TV.

#### Standby/on switch (⏻/⏻)

Press to switch the unit from on to standby mode or vice versa. In standby mode, the unit is still consuming a small amount of power.

#### 2 Follow the on-screen instructions and make the settings with [▲, ▼] and press [OK].

"On-Screen Language", "TV Aspect" and "Quick Start" are set. ([FUNCTION MENU] → "To Others" → "Setup" → "Display", "TV / Device Connection" or "General")

BD65 After completing "Easy Setting", you can perform "Network Easy Setting".



- You can perform this setup anytime by selecting "Easy Setting" in the Setup menu. ([FUNCTION MENU] → "To Others" → "Setup" → "General")

### Network Easy Setting BD65

After completing "Easy Setting", you will be asked to perform "Network Easy Setting".

Select "Wired" or "Wireless" and press [OK].

#### ■ "Wired" connection

Follow the on-screen instructions to make your connection settings.

#### ■ "Wireless" connection

If you select "Wireless" and "Wireless LAN Adaptor is not connected." is displayed, check that the Wireless LAN Adaptor is fully inserted. Alternatively, disconnect and reconnect it. If there is still no change in the display, consult your dealer for advice.

Select "WPS (PUSH button)" or "Search for access point" and then follow the on-screen instructions and make the settings.

# Inserting or removing a media

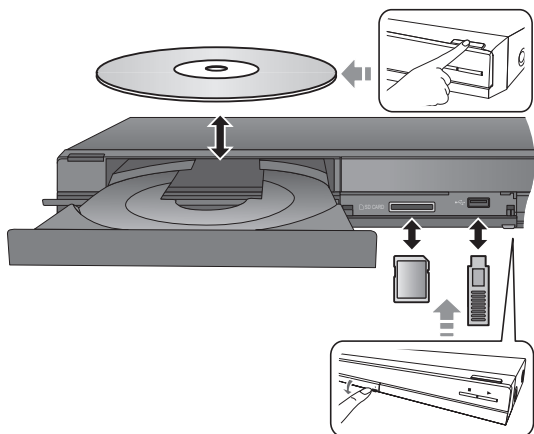

- When inserting a media, ensure that it is facing the right way up.
- When indicator on this unit's display blinks, do not turn off the unit or remove the media. Such action may result in loss of the media's contents.
- When removing the SD card, press on the centre of the card and pull it straight out.
- If you connect a Panasonic product with a USB connection cable, setup screen may be displayed on connected equipment. For details, refer to the instructions for the connected equipment.

## ■ To switch drives

Press [DRIVE SELECT] to select "BD/DVD/CD", "SD card" or "USB device".

- If a media is inserted while the unit is stopped, the drive switches automatically depending on the inserted media.

# Playing video contents

**BD DVD CD SD USB**

## Preparation

Turn on the television and select the appropriate video input on the television.

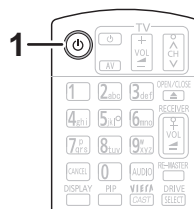

**1 Press [⏻] to turn on the unit.**

**2 Insert the media.**

Play starts.

- If the menu is displayed, press [▲, ▼, ◀, ▶] to select the item and press [OK].
- If play does not start, press [▶] (PLAY).

## ■ To show menus

You can display Top Menu, DIRECT NAVIGATOR or Pop-up Menu.

Press [TOP MENU/DIRECT NAVIGATOR] or [POP-UP MENU].

- Press [▲, ▼, ◀, ▶] to select the item and press [OK].
- Pop-up menu also appears by pressing [OPTION] and selecting "Pop-up Menu".



- Signal from PAL discs is output as PAL. Signal from NTSC discs is output as "NTSC" or "PAL60". You can select "NTSC" or "PAL60" in "NTSC Contents Output" for NTSC discs.  
([FUNCTION MENU]⇒"To Others"⇒"Setup"⇒"Picture")
- DISCS CONTINUE TO ROTATE WHILE MENUS ARE DISPLAYED. Press [■] when you have finished playback to protect the unit's motor, your television screen and so on.
- Depending on media and contents, the display may change or may not appear.
- DivX: Successive play is not possible.
- It is not possible to playback AVCHD and MPEG2 video which have been dragged and dropped, copied and pasted to the media.



## Other operations during play

These functions may not work depending on the media and contents.

### Stop

Press [■].

The stopped position is memorized.

#### Resume play function

Press [▶] (PLAY) to restart from this position.

- The position is cleared if the tray is opened or you press [■] several times to display "STOP" on unit's display.
- On BD-Video discs including BD-J, the resume play function does not work.

### Pause

Press [⏸].

- Press [⏸] again or [▶] (PLAY) to restart play.

### Search/Slow-motion

#### Search

While playing, press [◀◀] or [▶▶].

- Music and MP3: The speed is fixed to a single step.

#### Slow-motion

While paused, press [◀◀] or [▶▶].

- BD-Video and AVCHD: Forward direction [▶▶] only.

The speed increases up to 5 steps.

- Press [▶] (PLAY) to revert to normal playback speed.

### Skip

While playing or paused, press [◀◀] or [▶▶].

Skip to the title, chapter or track you want to play.

- Each press increases the number of skips.

### Frame-by-frame

While paused, press [◀] (◀◀) or [▶] (▶▶).

- Press and hold to change in succession forward or backward.
- Press [▶] (PLAY) to revert to normal playback speed.
- BD-Video and AVCHD: Forward direction [▶] (▶▶) only.

### Changing audio

Press [AUDIO].

You can change the audio channel number or soundtrack language ([DISPLAY]⇒"Disc"⇒"Soundtrack"), etc.

# Linked operations with the TV

(VIERA Link "HDAVI Control™")

## What is VIERA Link "HDAVI Control"?

VIERA Link "HDAVI Control" is a convenient function that offers linked operations of this unit, and a Panasonic TV (VIERA) or other device under "HDAVI Control".

You can use this function by connecting the equipment with an HDMI cable. See the operating instructions for connected equipment for operational details.

## Preparation

- ① Set "VIERA Link" to "On" ([FUNCTION MENU]⇒"To Others"⇒"Setup"⇒"TV / Device Connection"⇒"HDMI Connection"⇒"VIERA Link"⇒"On"). (The default setting is "On".)
- ② Set the "HDAVI Control" operations on the connected equipment (e.g., TV).
- ③ Turn on all "HDAVI Control" compatible equipment and select this unit's input channel on the connected TV so that the "HDAVI Control" function works properly. **Also when the connection or settings are changed, repeat this procedure.**

## Automatic input switching Power on link

When the following operations are performed, the television will automatically switch the input channel and display the corresponding action. When the television is off, the television will automatically turn on.

- When play starts on the unit
- When an action that uses the display screen is performed (e.g., DIRECT NAVIGATOR screen)
- BD-Video, DVD-Video:  
When playback stops, the TV will automatically return to TV tuner mode.

## Power off link

All connected equipment compatible with "HDAVI Control", including this unit, automatically turns off when you switch the television off.

## Playing music continuously even after turning off power to the television

When the unit is connected to a Panasonic TV (VIERA) that supports HDAVI Control 2 or later and an amplifier/receiver supports VIERA Link.

- ① While playing music  
Press [OPTION].
- ② Press [▲, ▼] to select "TV Power" and press [OK].

## Easy control only with VIERA remote control

### Only TV supports "HDAVI Control 2" or later

By using the TV remote control, you can play discs using the "Control Panel" and display the Top Menu or Pop-up Menu, etc.

- 1 Press [OPTION].
- 2 Select an item, then press [OK].

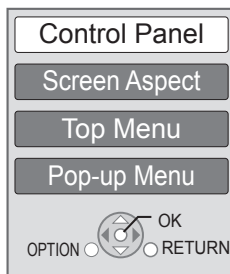

- The OPTION menu may not appear while the Top Menu for BD-Video or DVD-Video is displayed.



- The buttons that you can use for this unit vary depending on the TV. For details, refer to the operating instructions of the TV.
- The operation of this unit may be interrupted when you press incompatible buttons on the TV remote control.
- This unit supports "HDAVI Control 5" function. "HDAVI Control 5" is the newest standard (current as of December, 2009) for Panasonic's HDAVI Control compatible equipment. This standard is compatible with Panasonic's conventional HDAVI equipment.
- VIERA Link "HDAVI Control", based on the control functions provided by HDMI which is an industry standard known as HDMI CEC (Consumer Electronics Control), is a unique function that we have developed and added. As such, its operation with other manufacturers' equipment that supports HDMI CEC cannot be guaranteed.
- Please refer to individual manuals for other manufacturers' equipment supporting VIERA Link function.

## Specifications

**Signal system:** PAL/NTSC  
**Operating temperature range:** +5 °C to +35 °C  
**Operating humidity range:** 10 % to 80 % RH (no condensation)

**Video output:** 1.0 Vp-p (75 Ω)/Pin jack: 1 system  
**[BD65] : Component video output (Y: green, Pb: blue, Pr: red):**  
 Y : 1.0 Vp-p (75 Ω)/P<sub>B</sub>, P<sub>R</sub> : 0.7 Vp-p (75 Ω)/  
 Pin jack: 1 system

**Audio output:** 2 Vrms (1 kHz, 0 dB)/Pin jack  
 Number of connectors : 2 channel: 1 system

**Digital audio output:** Optical digital output (Optical terminal)

**HDMI AV output:** HDMI (V.1.4, Content Type)  
 This unit supports "HDAVI Control 5" function.

**SD card slot:** Connector: 1 system

**USB slot:** USB2.0: 1 system

**[BD65] : Ethernet:** 10BASE-T/100BASE-TX: 1 system

### LASER Specification

#### Class 1 LASER Product:

Wave length: 790 nm (CDs)/655 nm (DVDs)/405 nm (BDs)  
 Laser power: No hazardous radiation is emitted with the safety protection

### NORSK

Bølgelengde: 790 nm (CD)/655 nm (DVD)/405 nm (BD)  
 Laserstyrke: Ingen farlig stråling sendes ut

### Power supply:

AC 220 to 240 V, 50 Hz

### Power consumption:

**[BD65] :** Approx. 20 W

**[BD45] :** Approx. 19 W

**Power consumption in standby mode:** **Approx. 0.2 W**

**Power consumption in quick start standby mode:** **Approx. 7 W**

**Dimensions (W×D×H) : Including the projecting parts**  
 430 mm×207 mm×49 mm

**Mass:** Approx. 1.9 kg

Specifications are subject to change without notice.

### Information for Users on Collection and Disposal of Old Equipment and used Batteries



These symbols on the products, packaging, and/or accompanying documents mean that used electrical and electronic products and batteries should not be mixed with general household waste.

For proper treatment, recovery and recycling of old products and used batteries, please take them to applicable collection points, in accordance with your national legislation and the Directives 2002/96/EC and 2006/66/EC. By disposing of these products and batteries correctly, you will help to save valuable resources and prevent any potential negative effects on human health and the environment which could otherwise arise from inappropriate waste handling.

For more information about collection and recycling of old products and batteries, please contact your local municipality, your waste disposal service or the point of sale where you purchased the items. Penalties may be applicable for incorrect disposal of this waste, in accordance with national legislation.



#### For business users in the European Union

If you wish to discard electrical and electronic equipment, please contact your dealer or supplier for further information.

#### [Information on Disposal in other Countries outside the European Union]

These symbols are only valid in the European Union. If you wish to discard these items, please contact your local authorities or dealer and ask for the correct method of disposal.



#### Note for the battery symbol (bottom two symbol examples):

This symbol might be used in combination with a chemical symbol. In this case it complies with the requirement set by the Directive for the chemical involved.

Cd

Java and all Java-based trademarks and logos are trademarks or registered trademarks of Sun Microsystems, Inc. in the United States and other countries.
Manufactured under license from Dolby Laboratories. Dolby and the double-D symbol are trademarks of Dolby Laboratories.
Manufactured under license under U.S. Patent #'s: 5,451,942; 5,956,674; 5,974,380; 5,978,762; 6,226,616; 6,487,535; 7,392,195; 7,272,567; 7,333,929; 7,212,872 & other U.S. and worldwide patents issued & pending. DTS and the Symbol are registered trademarks, & DTS-HD, DTS-HD Master Audio   Essential and the DTS logos are trademarks of DTS, Inc. Product includes software. © DTS, Inc. All Rights Reserved.
This product incorporates copyright protection technology that is protected by U.S. patents and other intellectual property rights. Use of this copyright protection technology must be authorized by Macrovision, and is intended for home and other limited viewing uses only unless otherwise authorized by Macrovision. Reverse engineering or disassembly is prohibited.
HDMI, the HDMI Logo, and High-Definition Multimedia Interface are trademarks or registered trademarks of HDMI Licensing LLC in the United States and other countries.
This product is licensed under the AVC patent portfolio license and VC-1 patent portfolio license for the personal and non-commercial use of a consumer to (i) encode video in compliance with the AVC Standard and VC-1 Standard ("AVC/VC-1 Video") and/or (ii) decode AVC/VC-1 Video that was encoded by a consumer engaged in a personal and non-commercial activity and/or was obtained from a video provider licensed to provide AVC/VC-1 Video. No license is granted or shall be implied for any other use. Additional information may be obtained from MPEG LA, LLC. See <a href="http://www.mpegla.com">http://www.mpegla.com</a> .
HDAVI Control™ is a trademark of Panasonic Corporation.
x.v.Colour™ is a trademark.
VIERA CAST™ is a trademark of Panasonic Corporation.
"AVCHD" and the "AVCHD" logo are trademarks of Panasonic Corporation and Sony Corporation.
SDXC Logo is a trademark of SD-3C, LLC.
DivX® is a registered trademark of DivX, Inc., and is used under license.
"Blu-ray Disc" is trademark.
"BD-LIVE" logo is trademark of Blu-ray Disc Association.
"BONUSVIEW" is trademark of Blu-ray Disc Association.
YouTube and Picasa are trademarks of Google, Inc.
Microsoft®, Windows® and Windows Vista® are either registered trademarks or trademarks of the Microsoft Corporation in the United States and/or other countries.
Macintosh and Mac OS are either registered trademarks or trademarks of Apple Inc. in the United States and/or other countries.
Other names of systems and products mentioned in these instructions are usually the registered trademarks or trademarks of the manufacturers who developed the system or product concerned.

This product incorporates the following software:

- (1) the software developed independently by or for Panasonic Corporation,
- (2) the software owned by third party and licensed to Panasonic Corporation,
- (3) the software licensed under the GNU General Public License, Version 2 (GPL v2),
- (4) the software licensed under the GNU LESSER General Public License, Version 2.1 (LGPL v2.1) and/or,
- (5) open sourced software other than the software licensed under the GPL v2 and/or LGPL v2.1

For the software categorized as (3) and (4), please refer to the terms and conditions of GPL v2 and LGPL v2.1, as the case may be at

<http://www.gnu.org/licenses/old-licenses/gpl-2.0.html> and  
<http://www.gnu.org/licenses/old-licenses/lgpl-2.1.html>.

In addition, the software categorized as (3) and (4) are copyrighted by several individuals. Please refer to the copyright notice of those individuals at  
<http://www.am-linux.jp/dl/JPRCBW98>

The GPL/LGPL software is distributed in the hope that it will be useful, but WITHOUT ANY WARRANTY, without even the implied warranty of MERCHANTABILITY or FITNESS FOR A PARTICULAR PURPOSE.

At least three (3) years from delivery of products, Panasonic will give to any third party who contact us at the contact information provided below, for a charge no more than our cost of physically performing source code distribution, a complete machine-readable copy of the corresponding source code covered under GPL v2/LGPL v2.1.

Contact Information  
 cdrequest@am-linux.jp

Source code is also freely available to you and any other member of the public via our website below.  
<http://www.am-linux.jp/dl/JPRCBW98>

## Free Manuals Download Website

<http://myh66.com>

<http://usermanuals.us>

<http://www.somanuals.com>

<http://www.4manuals.cc>

<http://www.manual-lib.com>

<http://www.404manual.com>

<http://www.luxmanual.com>

<http://aubethermostatmanual.com>

Golf course search by state

<http://golfingnear.com>

Email search by domain

<http://emailbydomain.com>

Auto manuals search

<http://auto.somanuals.com>

TV manuals search

<http://tv.somanuals.com>