

Operating Instructions

Multi Laser
Disc Player

L
LASER DISC

COMPACT
disc
DIGITAL AUDIO

LD Auto Reverse
Multi Laser Disc Player

LX-1000U



Panasonic

Before attempting to connect, operate or adjust this product, please read these instructions completely.

Thank you for purchasing the Multi Laser Disc Player, LX-1000.

For optimum performance and safety please read these instructions carefully.

Table of Contents

Discs That Can Be Played Back	4
Controls And Components	5
Using The Remote Control	11
Handling The Disc	12
Playback	13
Audio Channel Selection	16
On Screen Display Instructions	18
Searching For Desired Scenes	21
Searching For Desired Sound	25
Playback Functions	28
Program Playback	35
Repeat Playback	39
Edit Playback	42
Connections	44
Cautions For Use	47
Cautions For Using Discs	48
Before Requesting Service	49
Possible Functions For The Different Discs	50
Specifications	51

Accessories

Infra-red Remote Control (With three "AA" size batteries)
Power Cord
S-Video Cable
Video Cable
Audio Cable

Note:

This unit can be used only where the power supply is AC 120 V, 50/60 Hz. It cannot be used elsewhere.

The model number and serial number of this product can be found on either the back or the bottom of the unit. Please note them in the space provided below and retain this booklet as a permanent record of your purchase to aid identification in the event of theft.

MODEL NUMBER _____
SERIAL NUMBER _____

CAUTION:

• This digital apparatus does not exceed the Class B limits for radio noise emissions from digital apparatus set out in the Radio Interference Regulations of the Canadian Department of Communications.

• THIS PRODUCT UTILIZES A LASER. USE OF CONTROLS OR ADJUSTMENTS OR PERFORMANCE OF PROCEDURES OTHER THAN THOSE SPECIFIED HEREIN MAY RESULT IN HAZARDOUS RADIATION EXPOSURE. DO NOT OPEN COVERS AND DO NOT REPAIR YOURSELF. REFER SERVICING TO QUALIFIED PERSONNEL.

WARNING:

TO REDUCE THE RISK OF FIRE OR SHOCK HAZARD, DO NOT EXPOSE THIS EQUIPMENT TO RAIN OR MOISTURE.



CAUTION: TO REDUCE THE RISK OF ELECTRIC SHOCK, DO NOT REMOVE COVER (OR BACK) NO USER-SERVICEABLE PARTS INSIDE REFER SERVICING TO QUALIFIED SERVICE PERSONNEL.

CAUTION: MULTI LASER DISC PLAYERS USE INVISIBLE LASER BEAM WHICH COULD CAUSE HAZARDOUS RADIATION EXPOSURE IF DIRECTED. BE SURE TO OPERATE THE PLAYER CORRECTLY AS INSTRUCTED.



This symbol warns the user that uninsulated voltage within the unit may have sufficient magnitude to cause electric shock. Therefore, it is dangerous to make any kind of contact with any inside part of this unit.



This symbol alerts the user that important literature concerning the operation and maintenance of this unit has been included. Therefore, it should be read carefully in order to avoid any problems.

■ TO REDUCE THE RISK OF FIRE OR SHOCK HAZARD AND ANNOYING INTERFERENCE, USE THE RECOMMENDED ACCESSORIES ONLY.

is Safety Information

Discs That Can Be Played Back

This Multi Laser Disc Player makes it possible to play back the following six kinds of laser discs without any adaptor.

CD (Compact Disc) Single
[Single side only]

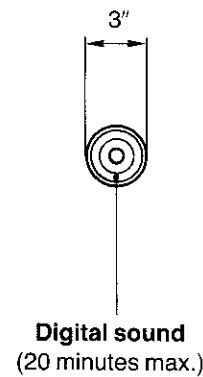

Digital sound
(20 minutes max.)

CD
[Single side only]

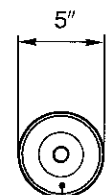

Digital sound
(74 minutes max.)

CD-V (Compact Disc-Video)
[Single side only]

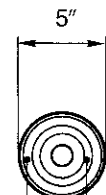

Digital sound
(20 minutes max.)
+
Picture
(5 minutes max.)

LD (Laser Videodisc) Single
[Single side only]

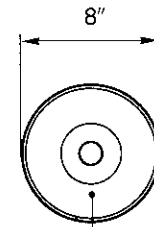

Digital/Analog sound
+
Picture
(CAV: 14 minutes max.)
(CLV: 20 minutes max.)

LD
[Both sides]

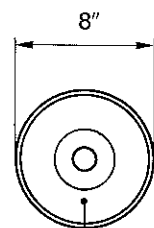

Digital/analog sound
+
Picture

(CAV: 14 minutes max. for single side)
(CLV: 20 minutes max. for single side)

LD
[Both sides or single side only]

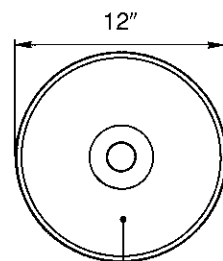

Digital/analog sound
+
Picture

(CAV: 30 minutes max. for single side)
(CLV: 60 minutes max. for single side)

- Only discs bearing one of trademarks shown on the right can be used with this unit.
- CED and VHD system video discs cannot be used with this unit.
- This unit uses the NTSC color TV system. Discs marked with other color TV systems (PAL, SECAM) cannot be played back.
- This unit does not correspond to the CD Graphics and CD-ROM specifications.
- Never use any discs whose back is coated with aluminum.

Note:

Your attention is drawn to the fact that recording, broadcasting, showing, playing to public and rental of pre-recorded discs and tapes or other published or broadcast material may infringe copyright laws.



Controls And Components

The explanations of function in this manual are mainly performed with the Remote Control. Therefore, the page numbers indicated below refer to operations performed with the Remote Control.

Front

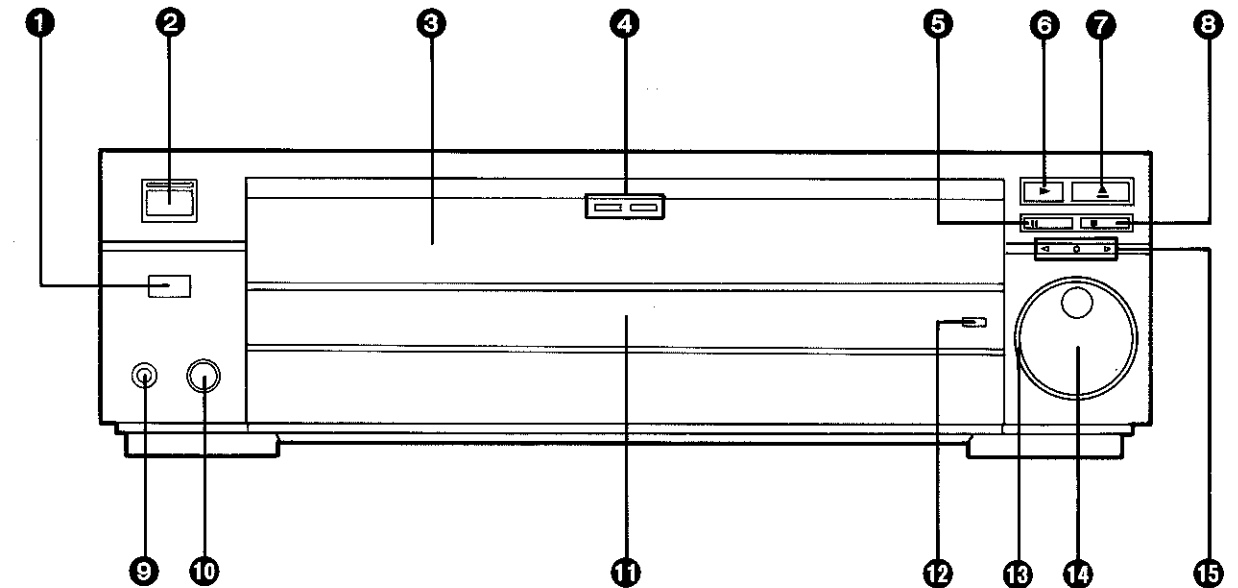

Control Section

No.	Description	Page	No.	Description	Page
1	Remote Control Receiver	11	10	Headphones Volume Control • To adjust sound level.	—
2	Power On/Off Button with Power Indicator	13	11	Multi-Function Display	6
3	Disk Tray	12	12	Button to Open Control Panel	8
4	Side Indicator	14	13	Shuttle Ring	28
5	Pause Button	13	14	Jog Dial	30
6	Play Button	13	15	Jog/Shuttle Indicator Lamp	28
7	Open/Close (Play) Button	13			
8	Stop Button	13			
9	Headphone Jack • Connecting headphone to this jack allows bilingual and stereo sound reproduction.	—			

WARNING

It is not recommended to listen with headphones for a long time with the volume turned extremely high.

Controls And Components (continued)

Multi Function Display

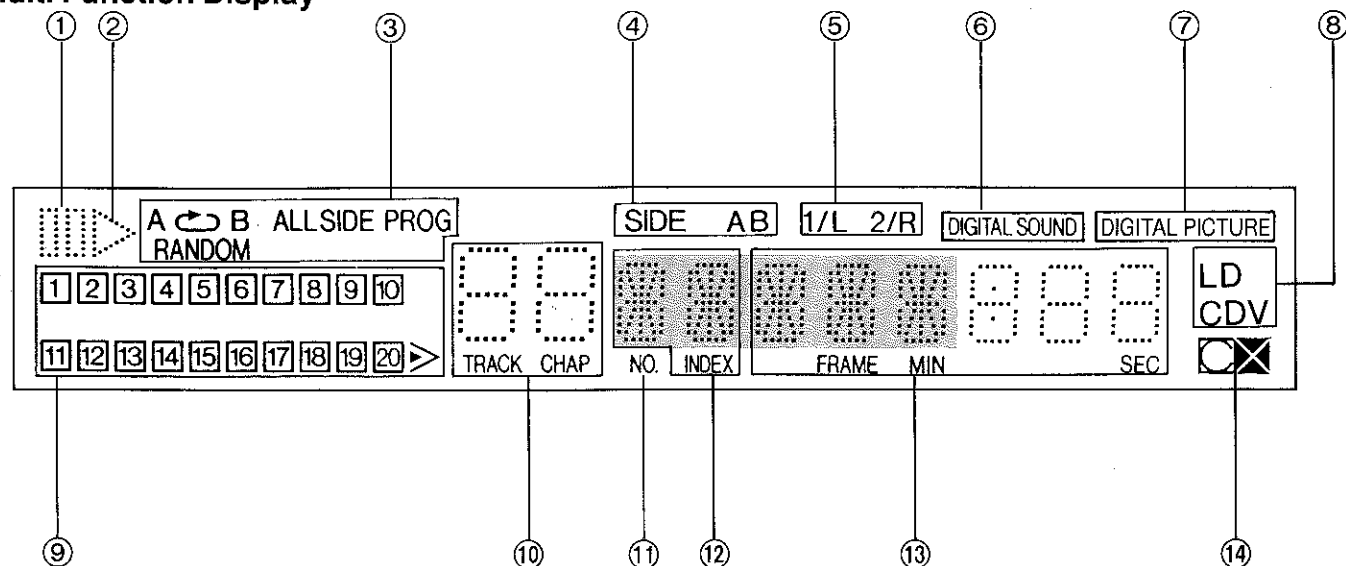

- ① Pause Indicator
- ② Play Indicator for All Playback Modes
- ③ Playback Mode Indicator
- ④ Disc Side Indicator (Only for LD)
- ⑤ Audio Output Mode Indicators
- ⑥ Digital Sound Indicator (while it is being output)
- ⑦ Digital Picture Indicator
- ⑧ Disc Type Indicator
- ⑨ Chapter/Track Number Indicator
- ⑩ Chapter/Track Number Indication
- ⑪ Program Number Indication
- ⑫ Index Number Indication
- ⑬ Frame Number/Time Number Indication
- ⑭ CX System ON Indicator

The shaded part of the display also indicates the messages explained on the bottom half of the right page.

- **LD Disc:** The number of the chapter being played back is displayed.
- **CDV or CD Disc:** The number of programs recorded on the disc is displayed and the number of tracks will go out one by one as their playback is completed.
- The ">" Mark will be displayed if there are more than 20 chapters or tracks on the disc. During playback of the 21st or subsequent tracks, the ">" Mark will be displayed.

Note:

There are some LDs which include chapter number "0"; however, this number cannot be displayed.

Playback Mode Display

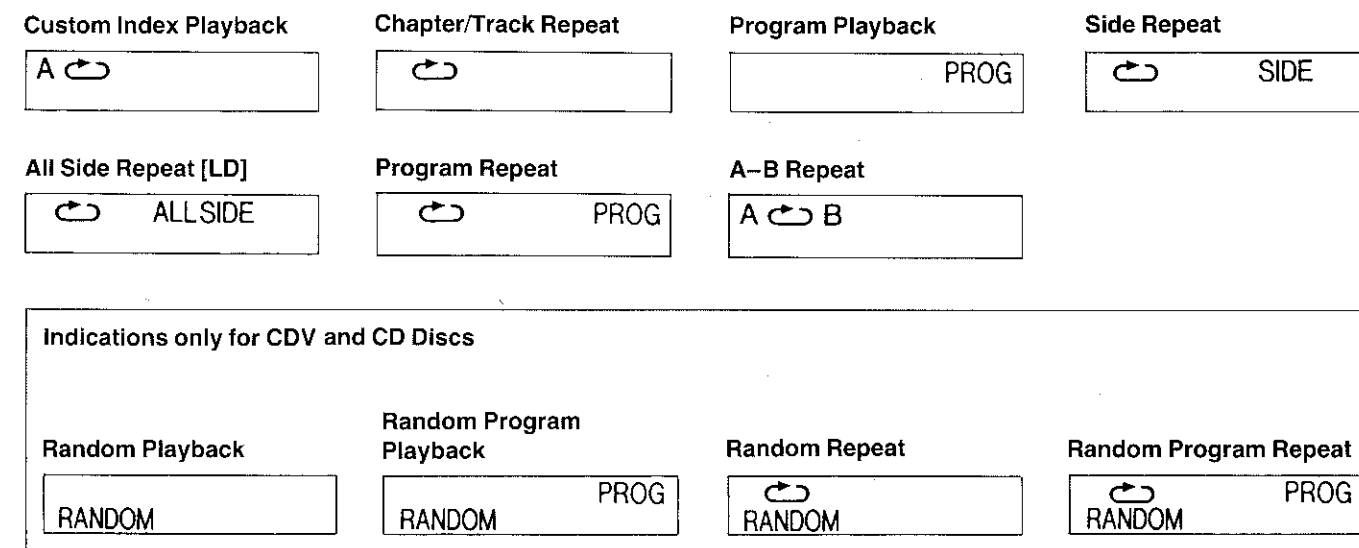

Message Display

"OPEN"

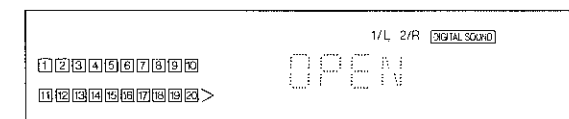

- The Disc Tray is being opened.

"CLOSE"

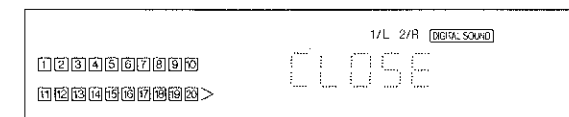

- The Disc Tray is being closed.

"OFF"

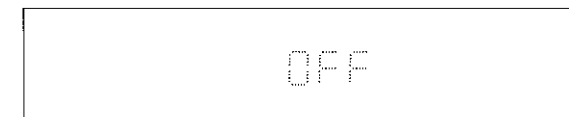

- It will be displayed when the power is turned off.

Indication for LD Discs Only:

"PLAY"

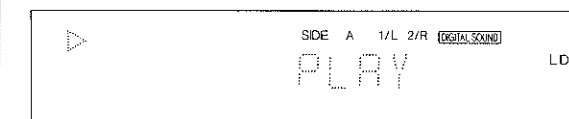

- Playback will start.

"A --> B"

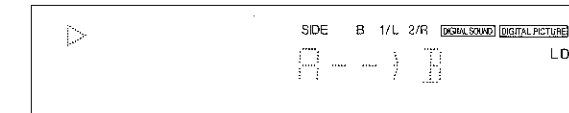

- While the playback is changed over from side A to side B. (The arrow moves from left to right.)

"B --> A"

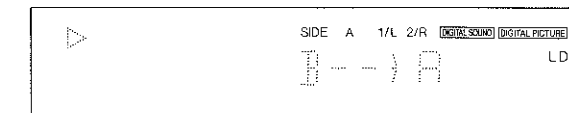

- While the playback is changed over from side B to side A. (The arrow moves from left to right.)

Controls And Components (continued)

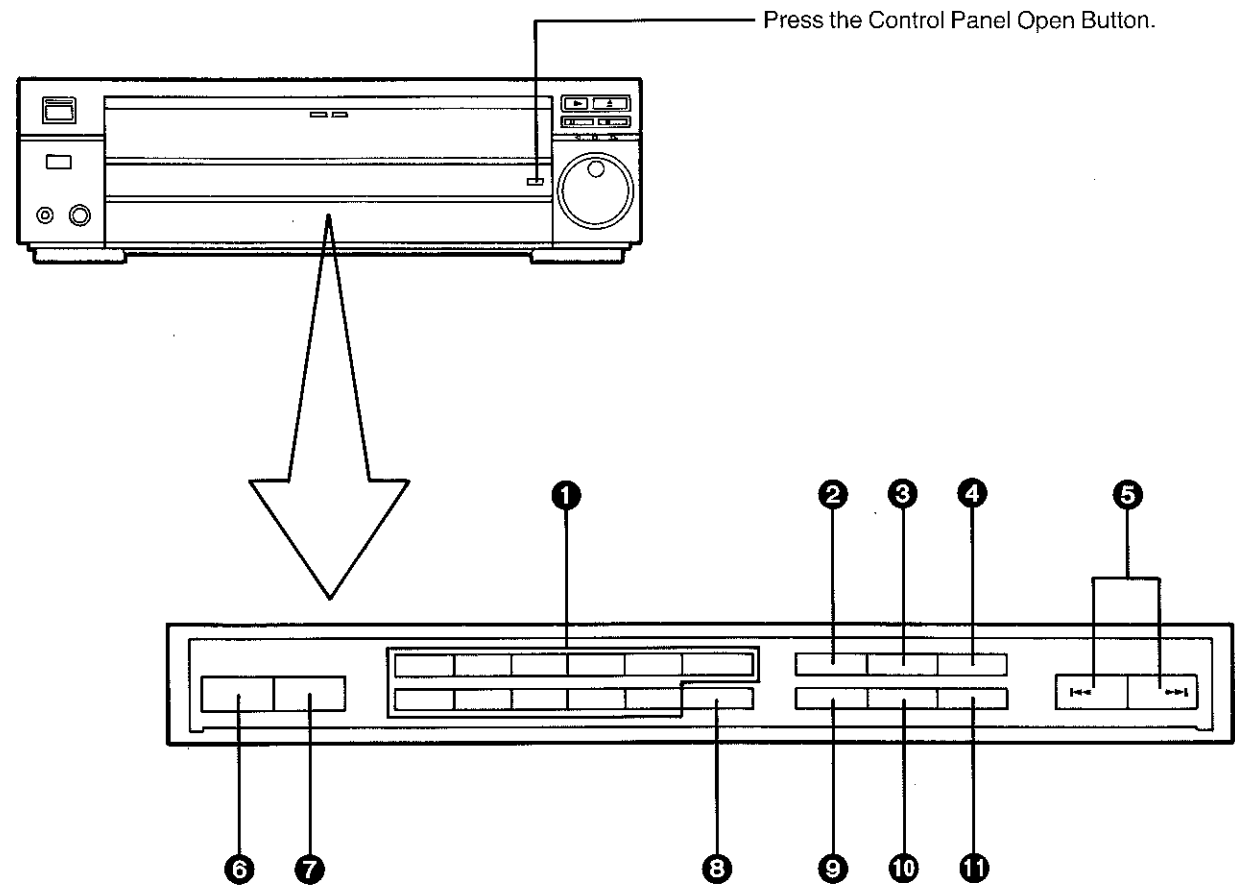

Control Section

No.	Description	Page	No.	Description	Page
1	Numeric Buttons	22	7	Side B Button	14
2	Program Button	35	8	Mode Button	22
3	Recall Button	37	9	Clear Button	23
4	Random Button	34	10	Edit Button	42
5	Skip Button	21, 25	11	Repeat Button	39
6	Side A Button	14			

Rear

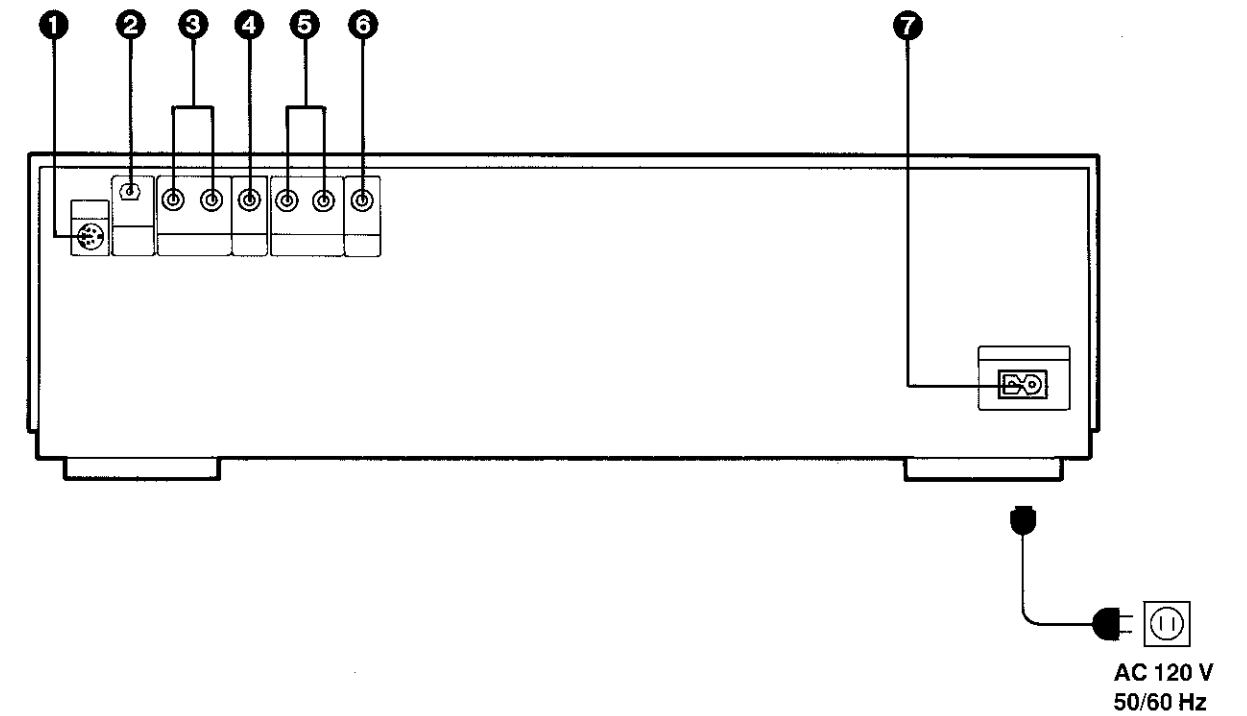

No.	Description	Page	No.	Description	Page
1	S-Video Output Jack	44	5	Audio Output 1 Jack	44
2	Optical Link Output Connector	44	6	Video Output 1 Jack	44
3	Audio Output 2 Jack	44	7	AC Power Socket	—
4	Video Output 2 Jack	44			

Controls And Components (continued)

Remote Control

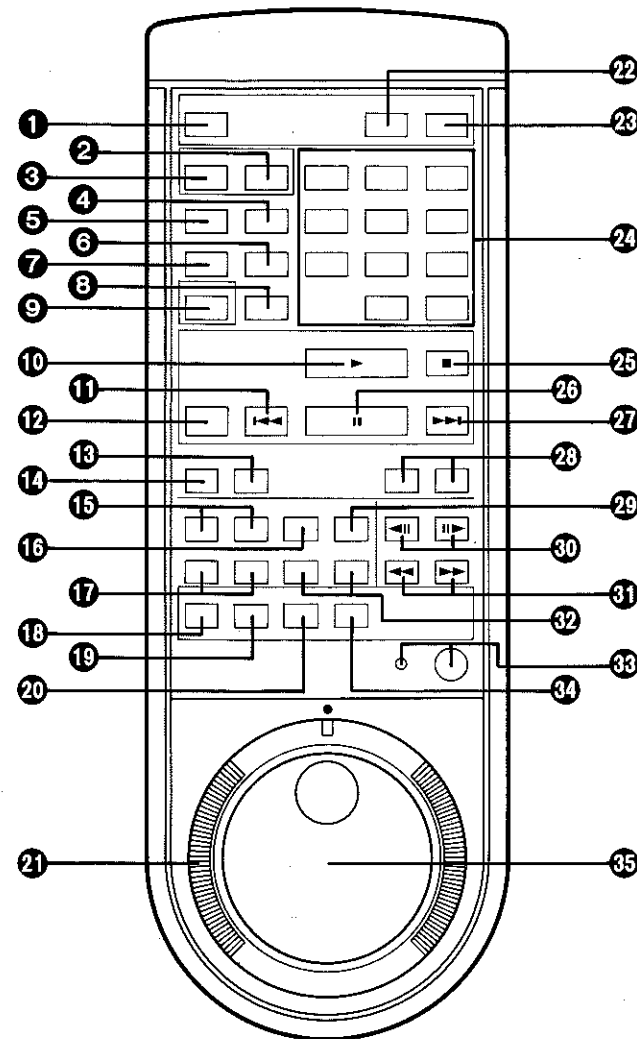

No.	Description	Page
1	Power On/Off Button	13
2	Side B Button	14
3	Side A Button	14
4	Edit Button	42
5	Repeat Button	39
6	Recall Button	37
7	A-B Repeat (Custom Index) Button	15
8	Program Button	35

9	Clear Button	22
10	Play Button	13
11	Skip (Backward) Button	21, 25
12	CDV A/V Button	27
13	Time Mode Button	19
14	Random Button	34
15	Strobe Buttons	34
16	Still & Sound Button	33
17	Speed Selector Buttons	32
18	D/A • CX Button	17
19	Audio Selector Button	16
20	Audio Level Button	19
21	Shuttle Ring	28
22	Mode Button	22
23	Open/Close (Play) Button	13
24	Numeric Buttons	22
25	Stop Button	13
26	Pause Button	13
27	Skip (Forward) Button	21, 25
28	Index Skip Buttons	27
29	Art Button	33
30	Still/Step Advance (Reverse) Buttons	31
31	Scan Buttons	21, 25
32	Multi Speed Buttons	32
33	Jog/Shuttle Mode Button with Indicator Light	28
34	Display (On-Screen Indication) Button	19
35	Jog Dial	30

Using The Remote Control

Battery installation

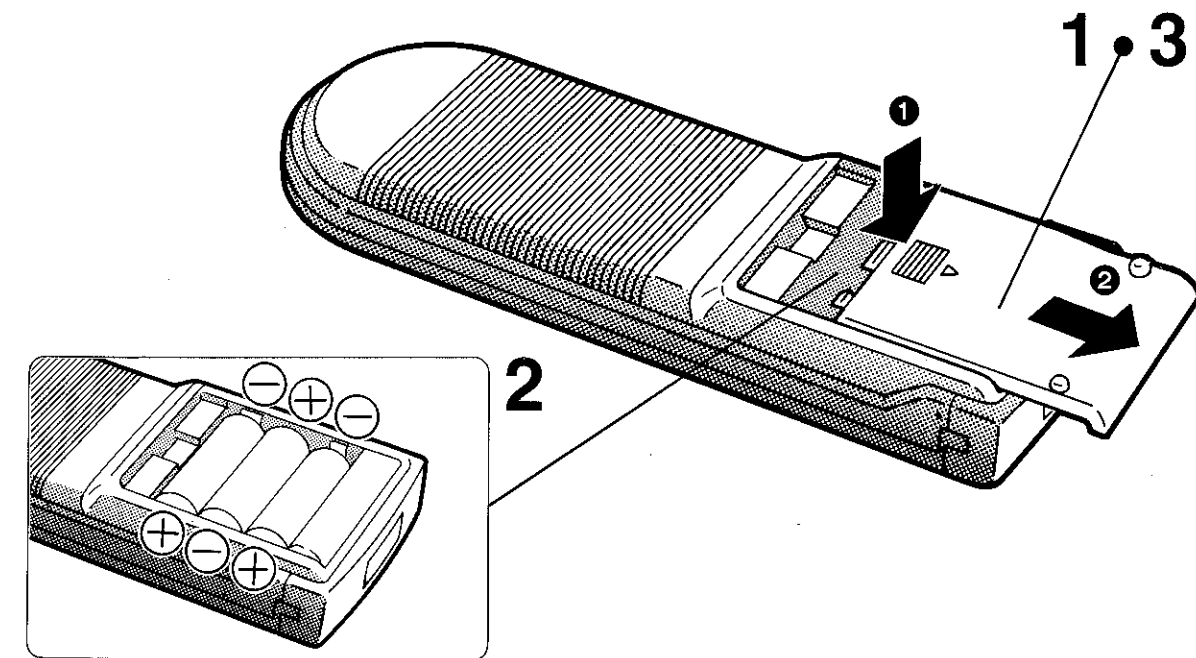

1 Remove the battery cover.

2 Place the batteries according to their polarities as indicated inside the battery compartment.

3 Close the cover.

Use of batteries

- Load the new batteries with their polarities (+ and -) aligned correctly.
- Do not apply heat to batteries, or internal short-circuit may occur.
- If you do not intend to use the Remote Control for a long period of time, remove the batteries and place in a cool and dry area.

- Remove old or weak batteries promptly and dispose of them properly.
- Do not use an old and a new batteries together. (Also never use an alkaline battery with a manganese battery.)

Operation notes

How to Operate the Remote Control

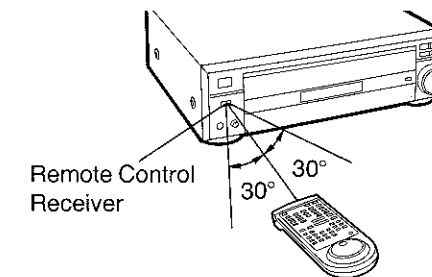

- The infra-red beam should be transmitted directly at the Remote Control Receiver on the front of the unit.
- Direct sunlight may interfere with the beam.
- The lightsensing angle of the Remote Control Receiver in the unit is about 30° from each side to the center.
- The unit should be used within a range of about 7 meters (23 FT) from the front of the unit.

Handling The Disc

Holding the Disc

Hold the disc without touching its surface.

LD (12")/LD, LD Single (8") Discs

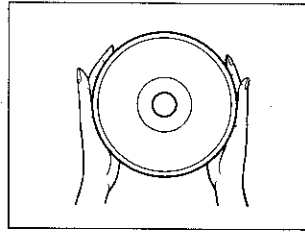

When holding with both hands:
Hold the disc by the edge.

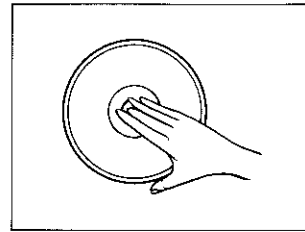

When holding with one hand:

CDV, CD (5")/CD Single (3") Discs

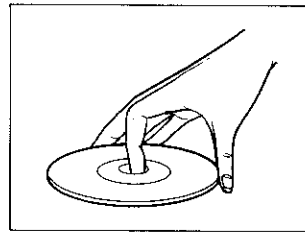

Hold the disc with the index finger in the center hole and the other fingers around the edge.

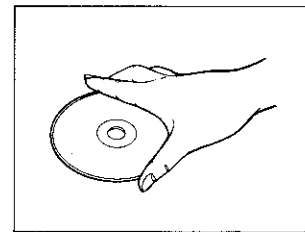

Placing the Disc on the Disc Tray

Place the disc in the proper recession according to its size and make sure it lies completely flat.

LD Disc with Recording on Both Sides:

Place the disc on the tray with side A facing upward. (Side B can be played back without turning the disc over.)

LD Disc with Recording on One Side Only and CDV or CD Disc:

Place the disc on the tray with its label facing upward.

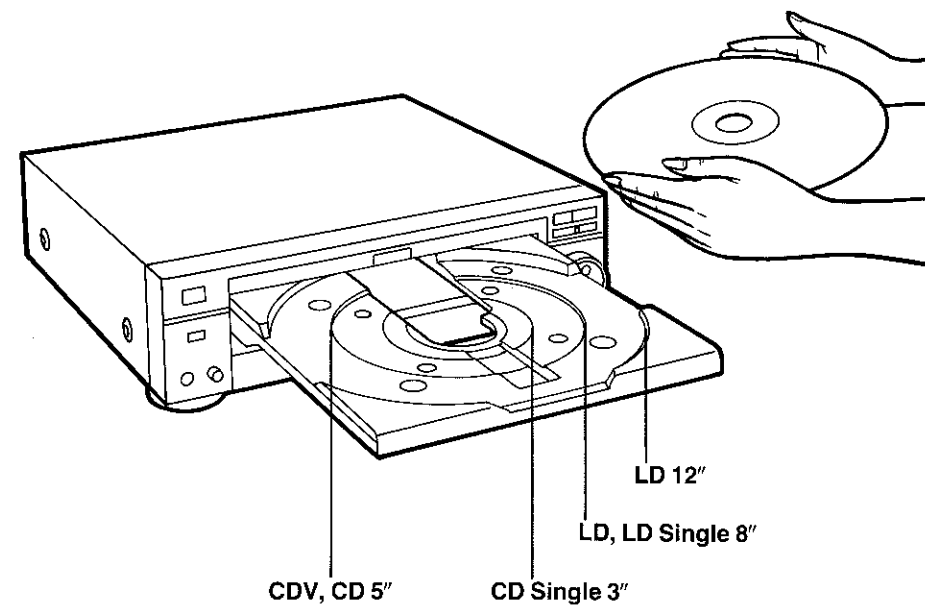

Note:

Place a disc on the disc tray in the proper recession according to its size. Do not place two discs or more at the same time, and make sure the disc lies completely flat.

Playback

Functions and operations discussed in this operating instructions booklet are to be mainly used with the remote control.

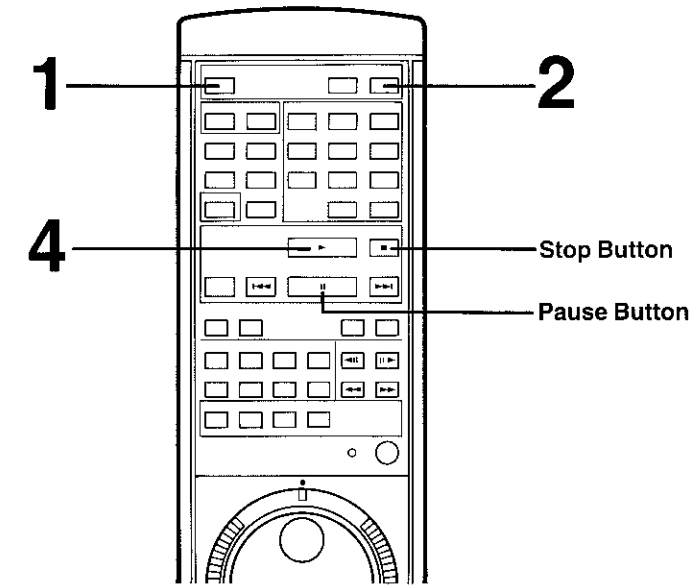
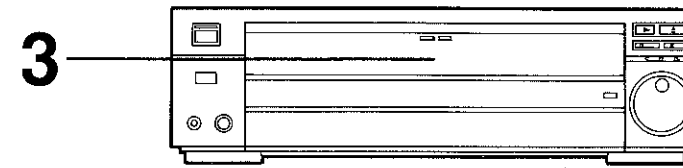

1 Turn the power on.

2 Open the Disc Tray.

3 Inert the disc.

4 Press the Play Button.
•The playback will also start if the Open/Close Button on the Remote Control is pressed.

To stop playback:
Press the Stop Button.

Last Memory Function [LD]

When the Stop Button is pressed, the Last Memory Function memorizes the point where the playback was stopped. When the Play Button is then pressed with the unit in the stop mode, playback will resume approximately at the point where it was stopped.

To interrupt the playback temporarily:

Press the Pause Button.

•To continue the playback from the same position, press the Pause Button again.

Note:

- Do not tilt, lift or cause any shock to the Multi Laser Disc Player while a disc is being played back. This could damage the disc.
- Do not try to open the Disc Tray with your hands.
- Do not insert any object other than the specified discs.
- To prevent damage to its mechanism and accumulation of dust, do not leave the Disc Tray in its opened position.

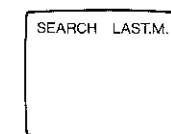
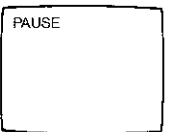
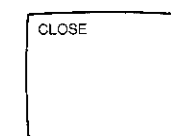
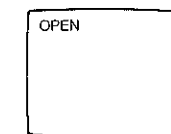

However, if any operation other than playback is performed after pressing the Stop Button, the Last Memory Function will be cancelled.

- The Last Memory Function does not work in the Program Playback mode and the Repeat Playback mode.

Playback (continued)

Side A is the side whose label is facing upward when an LD is inserted, and side B is the opposite side. The explanations in this manual are based on discs on which the label of side A is facing upward.

Reversing the disc side to be played back [LD]

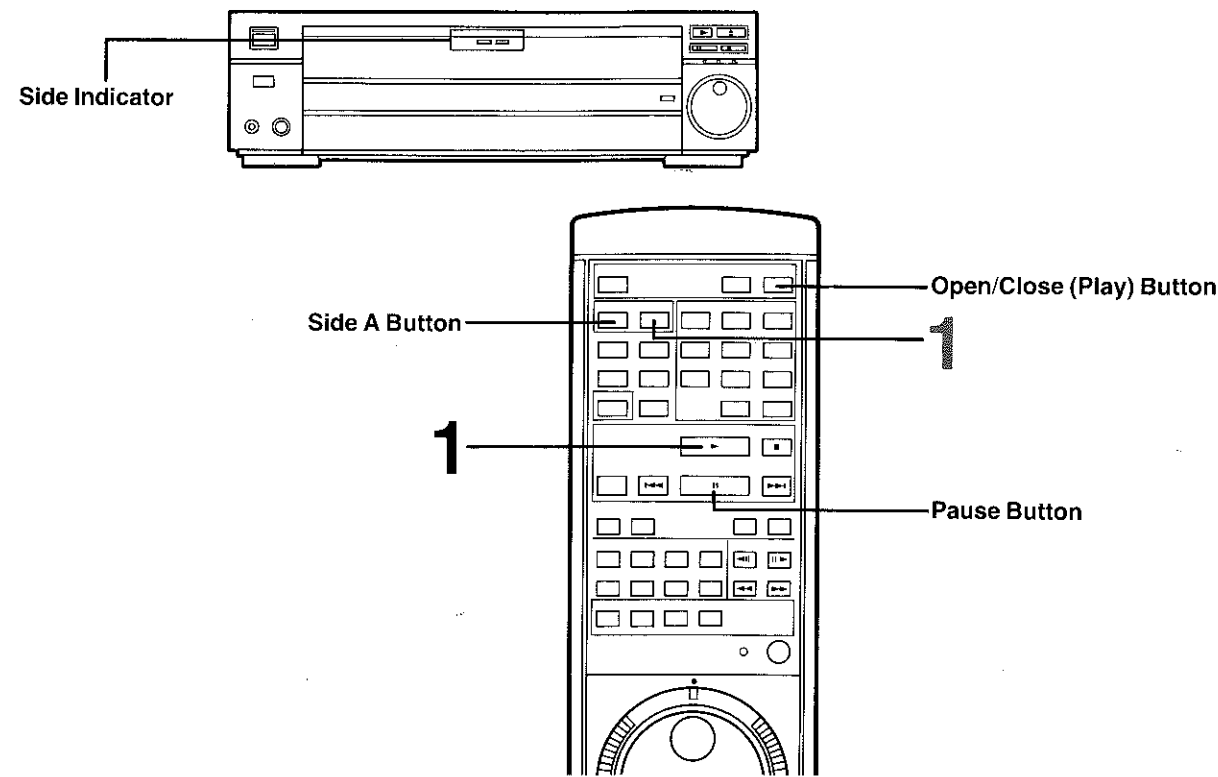

To watch side A

1 Press the Play Button.

- The playback of Side A starts.
- The "Side A" displayed will indicated.
- Once side A has played to the end, playback of side B will start automatically. (The "Side B" indicator will be displayed.)

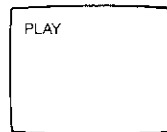

Note:

When playback is changed over to the opposite side while the unit is in the pause mode, the pause mode will be released automatically, and pause can also be used to temporarily stop playback after the desired side for playback has been selected.

To switch over from side A to side B

Press the Side B Button.

- When playback of side B is finished or is stopped halfway, playback will be reset for side A and then stop.

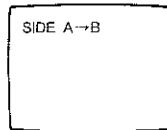

To watch side B

1 Press the Side B Button.

- The playback of Side B starts.
- The "Side B" displayed will indicated.
- When playback of side B is finished or is stopped halfway, playback will be reset to side A and then stop.

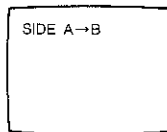

To switch the playback to side A halfway during playback of side B Press the Side A Button.

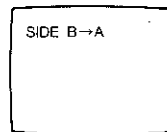

Note:

Since LD Single discs are recorded only on one side (side A), the un-recorded side B cannot be selected.

To directly select side B for playback when the Disc Tray is open

Press the Open/Close (Play) Button so that the "PLAY" Indication in the Multi-Function Display lights up, and then press the Side B Button.

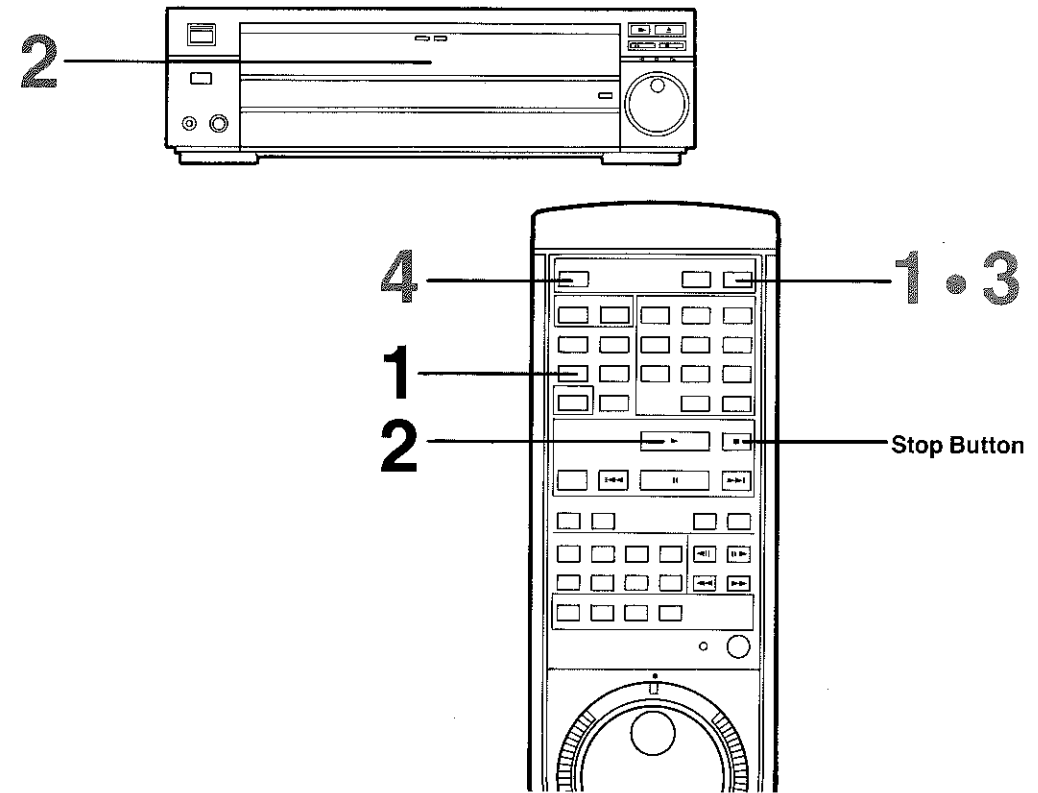

Custom Index Playback [LD] [CDV] [CD]

1 During playback, press the A-B Repeat Button at the point from where you want to watch (listen [CD]).

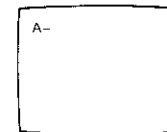

2 Press the Play Button.

- The playback will restart from the point where the A-B Repeat Button was pressed in step 1.

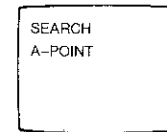

Note:

- This function will be cancelled when any button other than Play, Still, Forward and Backward is pressed.
- This function does not work when the disc portion to be repeated covers parts of both the audio and video sections of a CDV disc.
- This function does not work during Random Playback and Program Playback.

To stop the playback, press the Stop Button.

Removal of Disc from Multi Disc Player

1 Open the Disc Tray.

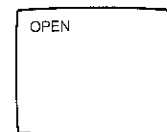

2 Remove the disc.

3 Close the Disc Tray.

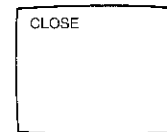

4 Turn off the power.

Auto Power Off Function

If the unit remains in the stop mode for approx. 30 minutes, it automatically turns itself off.

When the unit is not to be used for a long period, be sure to disconnect the AC Power Cable from the AC outlet.

Even if the unit is turned off with the Power On/Off Button on the unit itself or on the Remote Control, approximately 7 W of power is consumed.

Audio Channel Selection

With the Audio Selector Button, the desired audio Playback can be selected.

Audio Selector Button [LD], [CDV] or [CD]

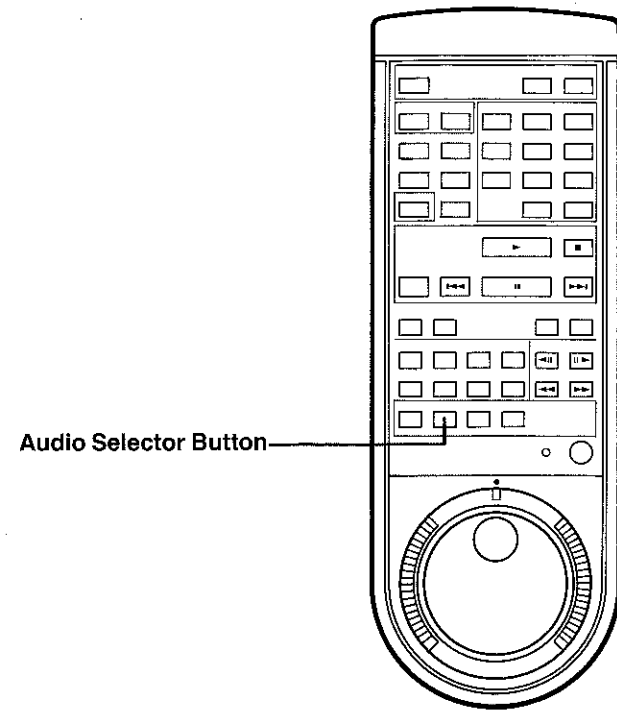

Discs with recorded stereo sound

To select the desired audio channel, Press the Audio Selector Button.

Audio Indication	Playback Sound
1/L 2/R	Stereo Sound.
1/L	Audio of left channel out through both speakers.
2/R	Audio of right channel out through both speakers.

•On-screen displays are as follows:

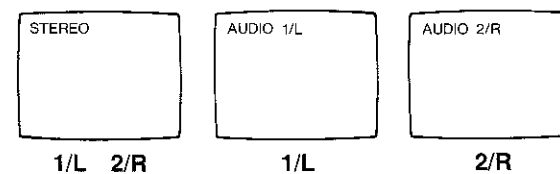

Disc with recorded bilingual audio information

Switching the sound with the Audio Selector Button

Sound Indication	Playback Sound
1/L 2/R	Main audio signal is heard from left speaker, and sub audio signal from the right speaker.
1/L	Main audio out to both speakers.
2/R	Sub audio out to both speakers.

•On-screen displays are as follows:

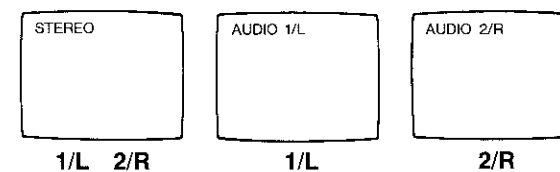

With the D/A • CX Button the desired digital sound can be selected as well as the CX noise reduction.

D/A • CX Button [LD]

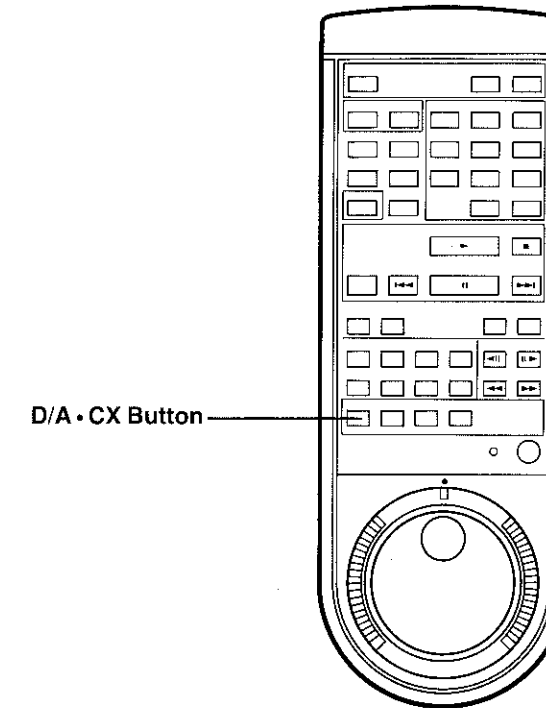

Discs with digital sound



For discs displaying these trademarks.

When playback starts, the indication "DIGITAL SOUND" will be indicated on the Multi-Function Display. The audio signal output from the Audio Output Jacks on the rear of the multi Laser Disc Player can be switched between digital and analog by pressing the D/A • CX Button on the Remote Control. When the power is turned on, the digital sound will automatically be selected.

•On-screen displays are as follows:

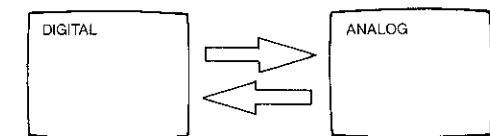



Note:

- When an optical cable (optional) is used for the connection, the analog sound is not output from the Optical Link Output Connector.
- Since the recording levels of the digital and the analog sound are different, the volume of some discs with digital sound may change when switching between digital sound and analog sound.

Discs with CX Mark



For discs displaying this trademark.

Discs which are encoded with CX allow reproduction of dynamic sound with minimal noise thanks to its Noise Reduction System. When this disc is played back,  will be displayed on the Multi-Function Display. The code which automatically turns on/off the CX system may not be recorded on all discs, and if a disc without this code is played back,  will not be displayed. In this case, press the D/A • CX Button on the Remote Control to make the  indication light up.

•On-screen displays are as follows:

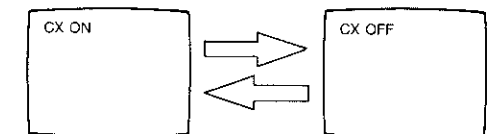

Note:

If a disc without the CX mark is played back, and the CX mode is used, the audio response will change.

 is a trademark of CBS. The Multi Laser Disc Player conforms with the extended specifications for the CX system.

On Screen Display Instructions

Examples of Displays

There are many Displays besides those shown below. They are explained in the instructions on the following pages.

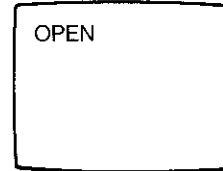

Opening Disc Tray.

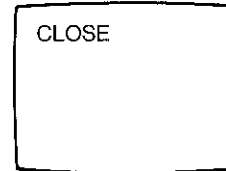

Closing Disc Tray.

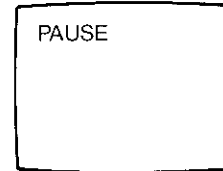

The Multi Laser Disc Player is in the pause mode.

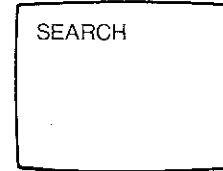

The Search Function or the Skip Function is being operated. Operating search or Skip function.



Reading the content of the disc.
 • This Display will be indicated when a CDV or CD disc is inserted.

- The screen will be blue in the pause mode of an LD disc and in the sound playback mode of a CDV (Audio part) or CD disc.
- If the TV is on during playback of a CDV or CD disc, it is possible to confirm the number of the track being played back, the elapsed playback time, and the operating condition of the Multi Laser Disc Player on the TV screen.

If the Multi Laser Disc Player is Put in the Stop Mode

Depending on the type of inserted disc, the on-screen indication will be as follows:

For CDV and CD discs, the total number of recorded tracks and the recording duration are displayed.

- The time displayed on the screen may differ somewhat from that listed in the explanations included with the disc.

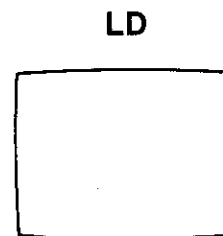

No indication

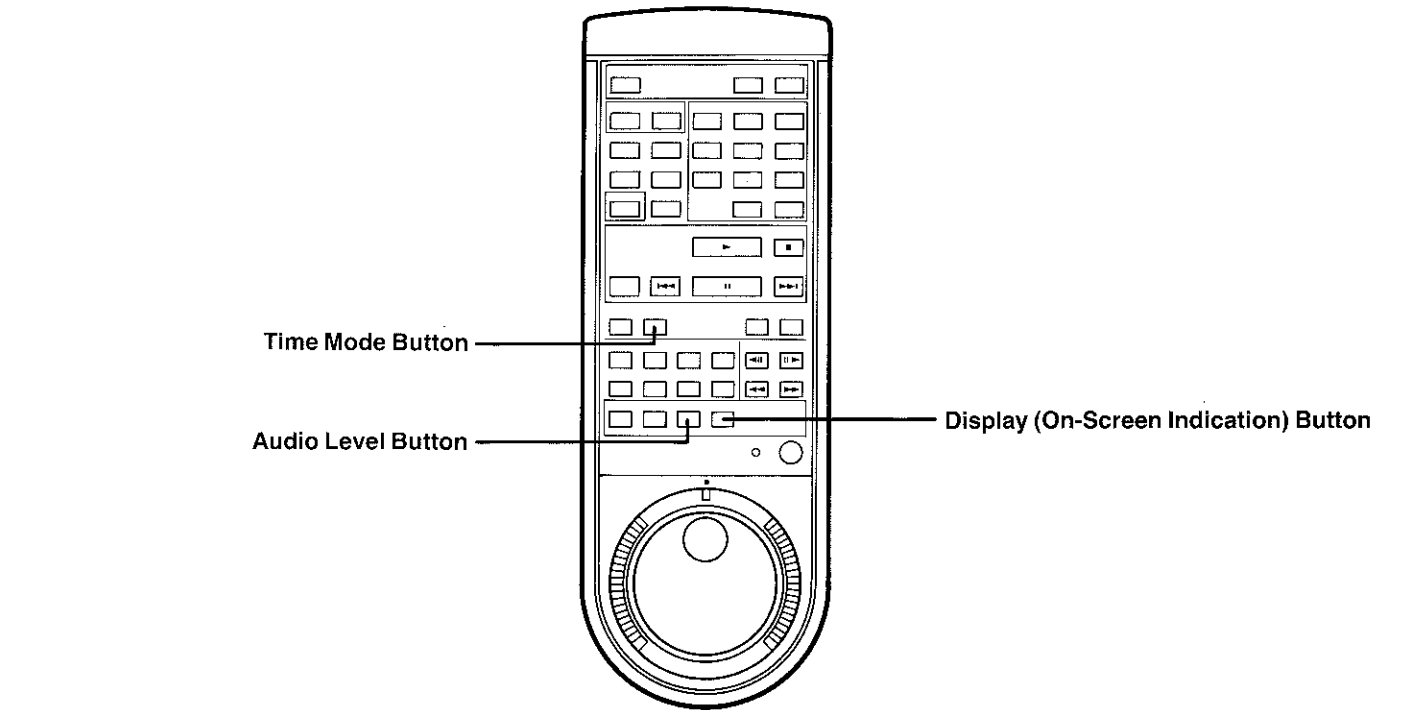
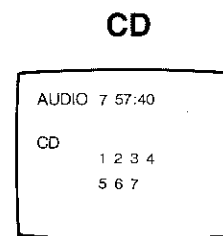
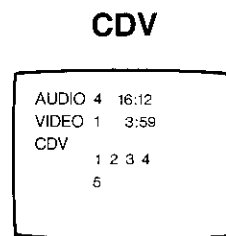

To confirm during disc playback [LD] [CDV] [CD]

Press the Display (On-Screen Indication) Button, and the following indications will appear on the screen.

LD [CAV]

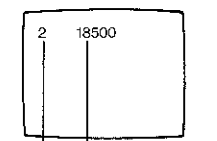

Chapter Number
Frame Number

LD [CLV]

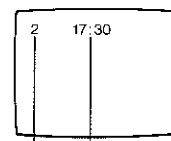

Chapter Number
Time Number

CDV, CD

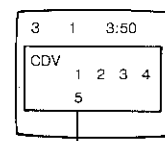

The number of the tune which is being played back will flash. (When a CD is played back, the indication "CD" will be displayed.)
 • During playback of the video part of a CDV disc, there will be no indication.

One more press

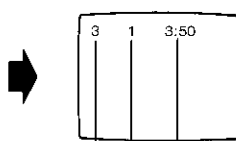

Elapsed Time of Track
Index Number
Track Number

- When playing back a CLV on which the seconds have not been recorded, only the minutes will be displayed. (Example: "17: ")
- When playing back a disc on which the chapter has not been recorded, the chapter number will not be displayed.

On Screen Display Instructions (continued)

To review the time display [CDV] [CD]

By pressing the Time Mode Button the display will indicate the following:

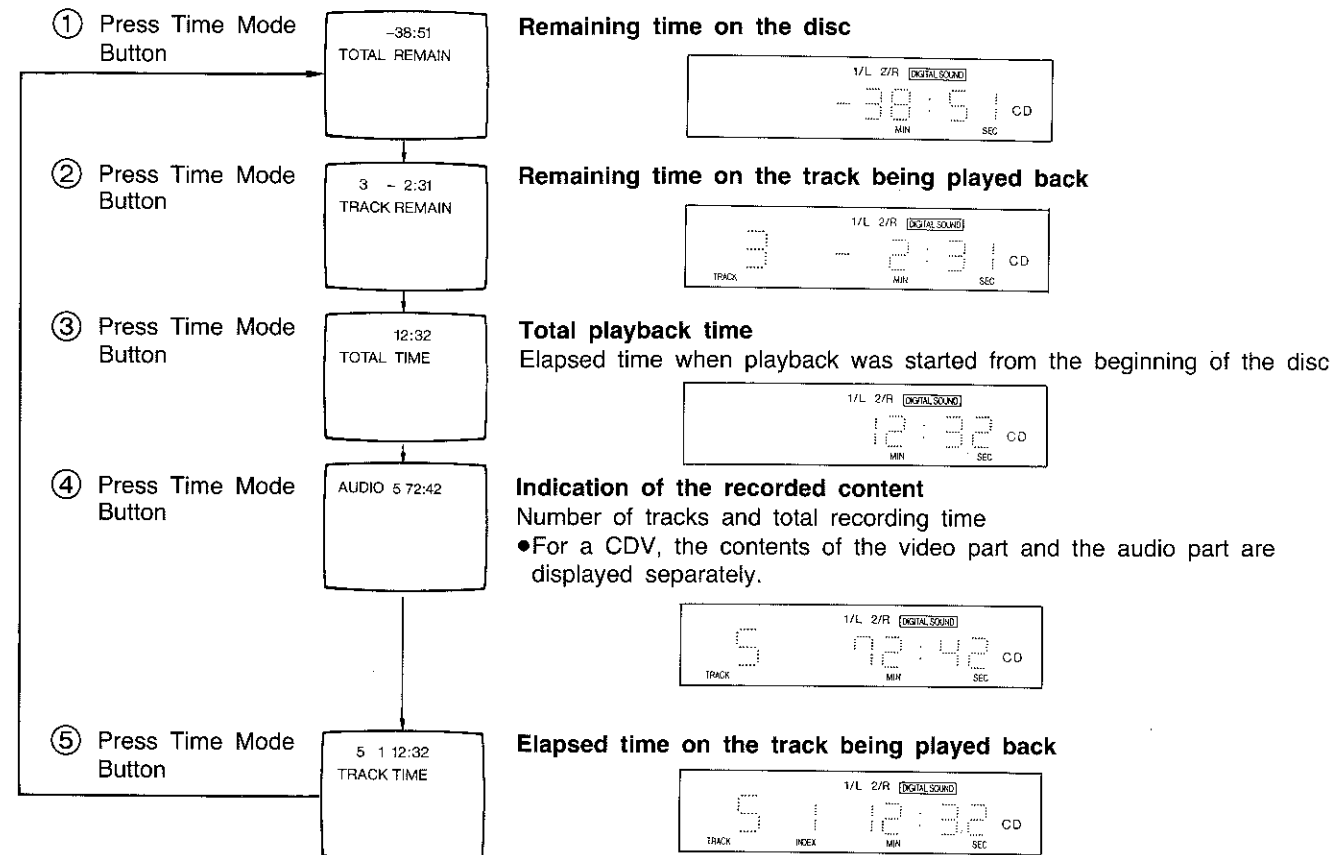

•Press the Display Button to clear the screen.

Note:

- In the random playback mode, the on-screen display will follow this sequence ②→④→⑤.
- The time displayed by the Multi Laser Disc Player may differ somewhat from that listed in the table of contents included with the disc. This is because those table of contents list only the actual playing time of each track, while the Multi Laser Disc Player also counts and displays the time of the intervals between tracks.

To display the audio volume level [CDV] [CD]

Press the Audio Level Button to display the audio volume on-screen level.

Press this button again to cancel this display.

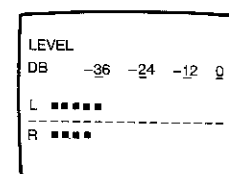

- The volume meter is equipped with peak hold function that keeps instantaneous maximum volume levels.
- The volume level displays the actual signal level recorded on CDV and CD discs.
- The low-frequency signals will not be displayed accurately.

Note:

- The numerical volume level indicator display may differ between recordings or other playback sources.
- The volume level is not displayed during playback of the video selection in CDV disc.

Searching For Desired Scenes

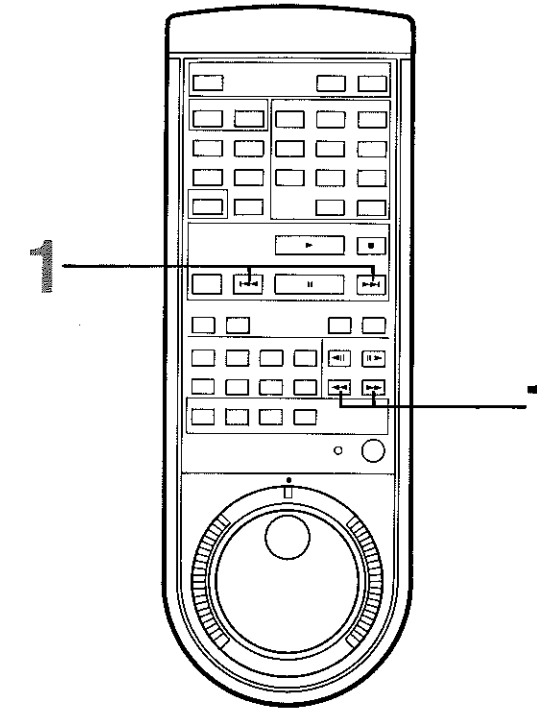

Forward (Reverse) Playback [LD] [CDV (Video Part)]

- 1 Keep the Scan (Forward or Backward) Button pressed while the Multi Laser Disc Player is in the normal playback mode.
•For approximately the first 2 seconds, the picture will be played back at low speed, then at a faster speed.

•As soon as the button is released, normal playback resumes.

Chapter Skip [LD]

- 1 Press the Skip Button during playback.
•It is also possible to directly access the desired chapter by repeatedly pressing the Skip Button as many times as the number of chapters are present.

Note:

This function does not work with discs with out chapter numbers recorded.
When pressing the Skip Button more than the number of chapters remaining, playback will start a little before the end of the last chapter in the disc.

Chapter Skip Function

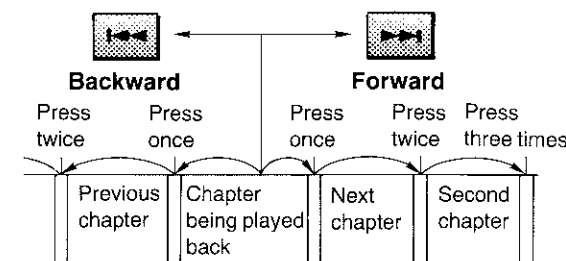

Playback direction

- Pay attention to the number of times you press the Skip Button because the present chapter is included in the count of chapters skipped in the backward direction.

Searching For Desired Scenes (continued)

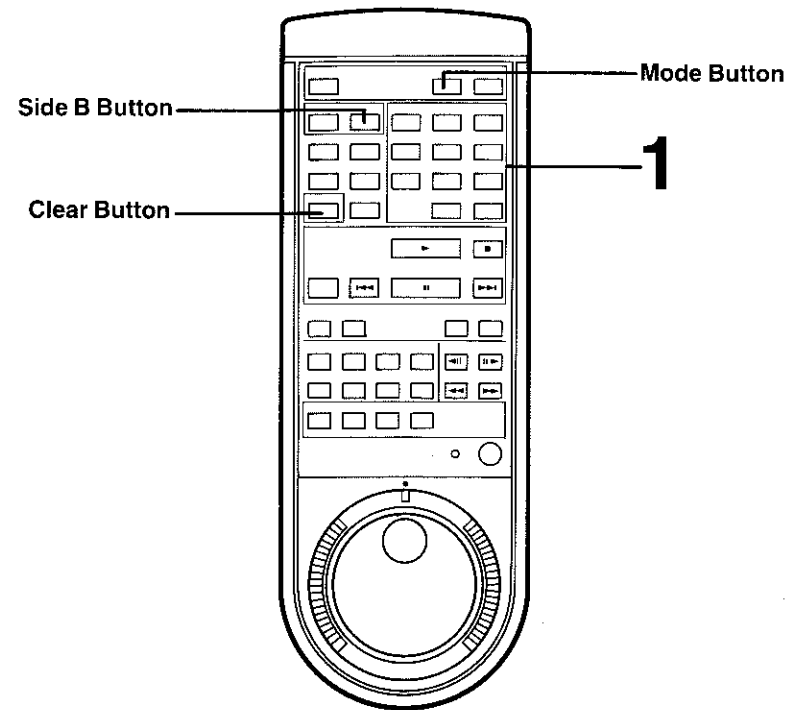

Chapter Search System [LD]

Example: To access the beginning of chapter number 3:

- 1 Press the Numeric Button "3".**
 - The program in chapter 3 will be played back.
 - If the on-screen display is not as shown on the right, press the Mode Button to "CHAPTER" appear, and enter the desired chapter number.
 - If you want to access another chapter during playback, but you pressed a wrong number, simply enter the correct chapter number.

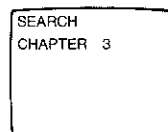

To access a chapter with a 2-digit number:
Use the "+10" Button for the first digit (tens), and the corresponding Numeric Button for the second digit.

Example: To access the chapter 14:
"+10" → "4"
To access the chapter 20:
"+10" → "+10" → "0"

- Note:**
- This function does not work with discs with out chapter numbers recorded.
 - If a higher chapter number is selected than the total number of chapters recorded on the disc, playback will start a little before the end of the last chapter.
 - If no chapter number is entered after making the display "CHAPTER" appear, the indication can be cancelled by pressing the Clear Button.

To access a chapter on side B:
Press the corresponding Numeric Button after pressing the Side B Button.

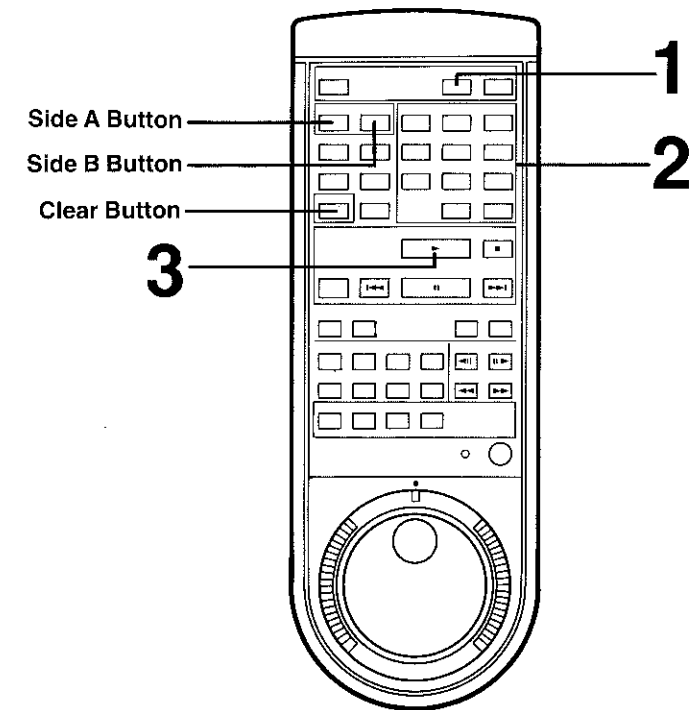

Frame Search System [LD (Only CAV)]

Example: To play back from frame number 15000:

- 1 Press the Mode Button during playback.**
 - Press until the display "FRAME" appears on the TV screen.
 - This operation is not necessary for discs on which no chapters are recorded.
- 2 Press the Numeric Buttons "1" → "5" → "0" → "0" → "0".**
 - If you pressed a wrong number, press the Clear Button to clear the number and then press the correct Numeric Buttons.

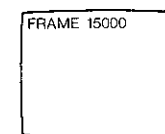
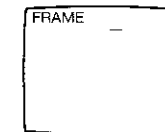

- 3 Press the Play Button.**
 - Playback will start from the specified frame.
 - When using Frame Search from the still playback mode, a still picture will be played back when the specified frame is reached.

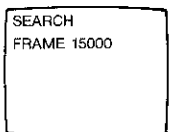

- Note:**
- When you play back an LD disc recorded on both sides, and want to select a frame number on the side opposite to that being played back, press the Side A (or Side B) Button, and after playback has started, specify the desired frame number.
 - If a frame number higher than highest recorded frame number is specified, playback will start a little before the end of the disc.

Searching For Desired Scenes (continued)

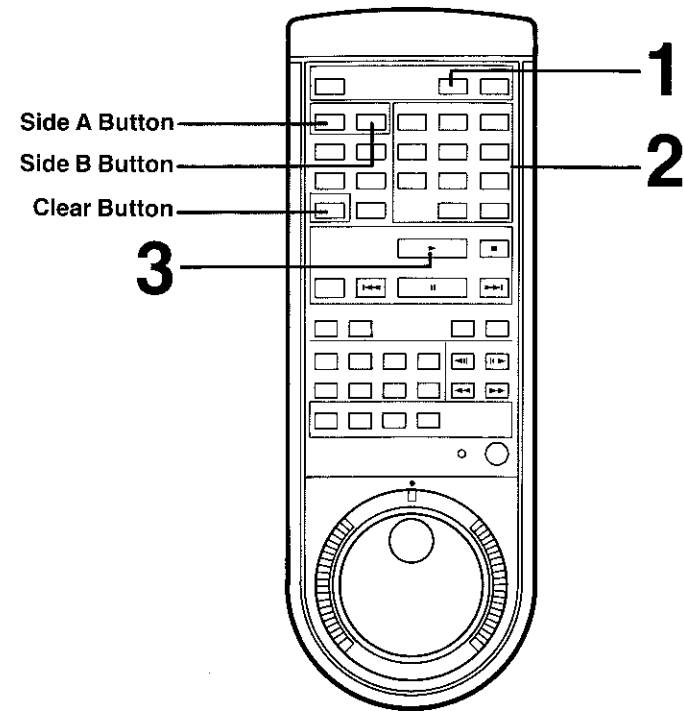

Searching For Desired Sound

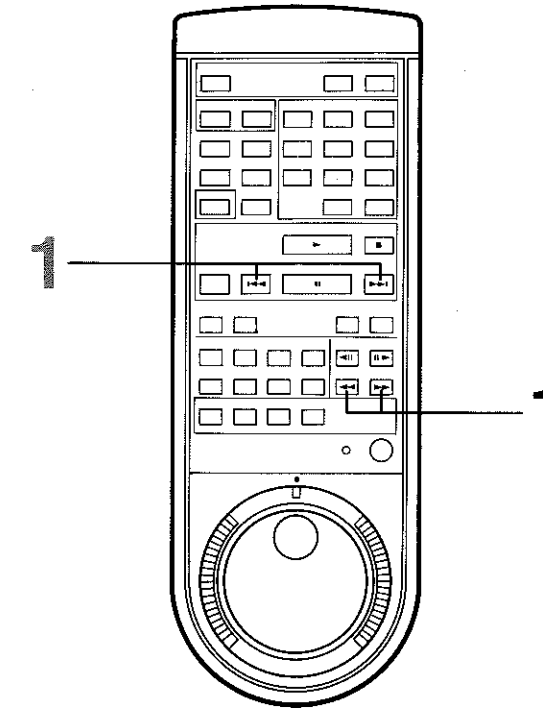

Time Search Function [LD (Only CLV)]

Example: To play back starting 15 minutes from the beginning of the disc:

- 1 Press the Mode Button during playback.**
 - Press until the indication "TIME" appears on the TV screen.
 - This operation is not necessary for discs on which no chapters are recorded.

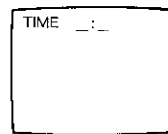

- 2 Press the Numeric Buttons "1" → "5" → "0" → "0".**
 - If you pressed a wrong number, press the Clear Button to clear the number and then press the correct Numeric Buttons again.



- 3 Press the Play Button.**

- Playback will start from the specified time number.
- When using Time Search from the still playback mode, a still picture will be played back when the specified time is reached.

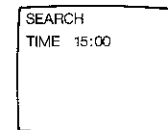

Note:

- In case of discs on which the time is only recorded in minutes, playback starts from the beginning of the specified minute even if the seconds were specified.
- When you play back an LD disc recorded on both sides and you want to access a playback located on the opposite side, press the Side A (or Side B) Button, and after playback has started, enter the desired time number.
- When a time number higher than the total playback time is entered, playback will start a little before the end of the disc.

Forward (Backward) Playback [CDV] [CD]

- 1 Keep the Scan (Forward or Backward) Button pressed during playback.**

- The volume of the playback sound is low.
- For approximately the first 2 seconds, the sound is played back at low speed, then at higher speed.

- As soon as the button is released, normal playback is resumed.

Note:

- No sound can be heard in the video part of a CDV disc.
- On CDV discs, Forward (Backward) playback is not possible across the video part and audio part.

Track Skip [CDV] [CD]

- 1 Press the Skip Button during playback.**

- The Track Skip function can also be operated with the Skip Button on the Multi Laser Disc Player.
- It is also possible to directly access a track by pressing and holding the Skip Button until the desired track has been located.

Track Skip Function

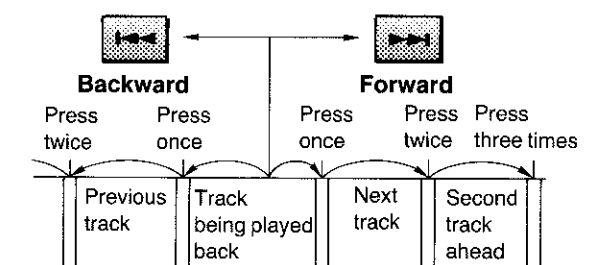

Playback direction

- Pay attention to the number of times you press the Skip Button because the present track is included in the count of tracks skipped in the backward direction.

Searching For Desired Sound (continued)

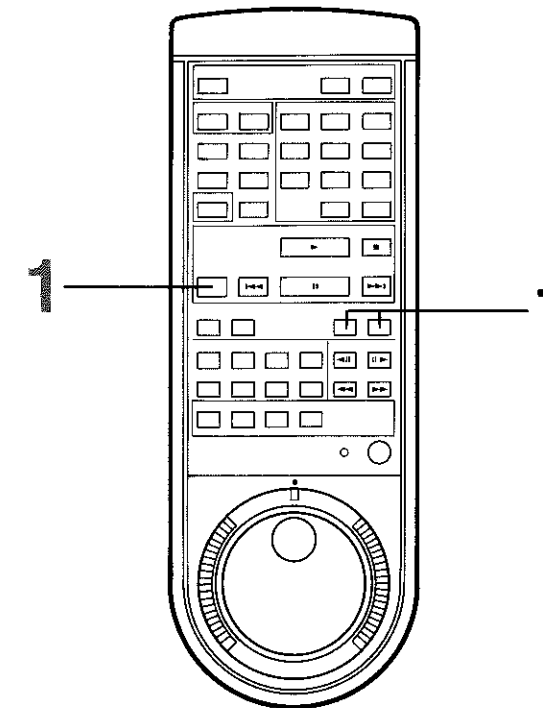
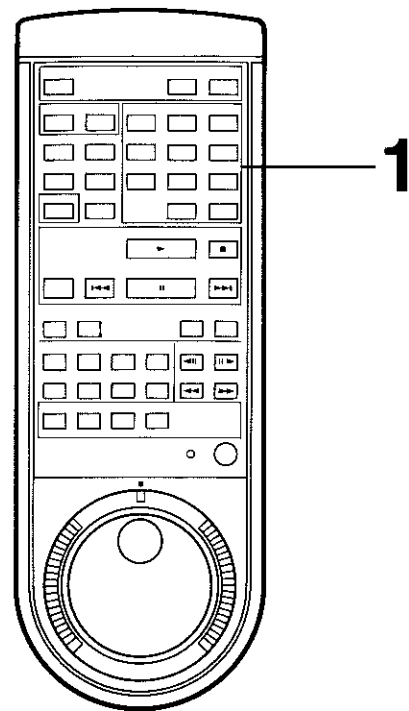

Track Search System [CDV] [CD]

Example: To access track number "3"

1 Press the Numeric Button "3".

- Track Number 3 will be played back.
- If you want to access another track during playback, but you pressed a wrong number, simply enter correct number.

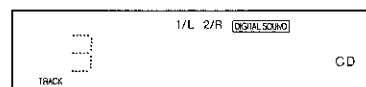
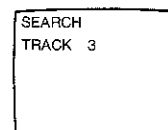

Note:

If a higher track number is specified than the total number of tracks on the disc, the indication "ERROR" flashes on the TV screen and the indication "E" flashes on the Multi-Function Display. In this case, the track search cannot be performed.

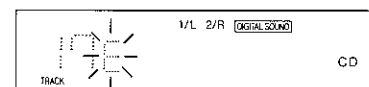
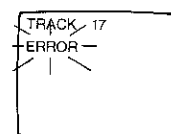

To access a track with a 2-digit number:

Use the "+10" Button for the first digit (tens), and the corresponding Numeric Button for the second digit.

Example: To access track number "14":

"+10" → "4"

To access track number "20":

"+10" → "+10" → "0"

Index Skip [CDV] [CD]

1 Press the Index Button during playback.

- It is possible to directly access a desired index by repeatedly pressing the Index Button as many times as the number of indexes to be skipped.
- This function can only be used with CDV or CD's recorded with indexes.

Note:

If index skipping is attempted to a larger number than the total number of recorded indexes, playback will start from the last recorded index.

Function Principle of Index Skip

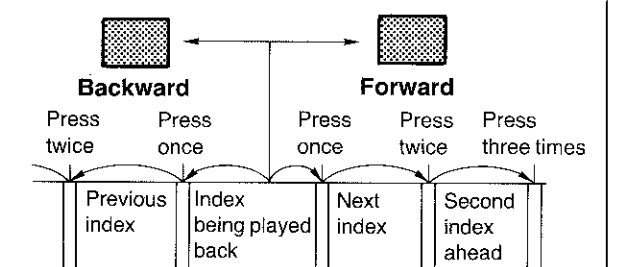

Playback direction

- Pay attention to the number of time you press the Index Button because the present index is included in the count for skipped in the backward direction.

Switching between the Recorded Video Section and the Audio Section [CDV]

A CDV disc can contain a maximum of 5 minutes of picture+digital sound (video section) and a maximum of 20 minutes of digital sound (audio section).

1 Press the CDV A/V Button during playback.

- If this button is pressed during playback of the video section, playback will change over to the beginning of the audio section.
- If this button is pressed during playback of the audio section, playback will change over to the beginning of the video section.

Playback Functions

Quick changeover from any playback function to another such as Slow, Cue or Review can be performed simply by turning the Shuttle Ring to the right or left.

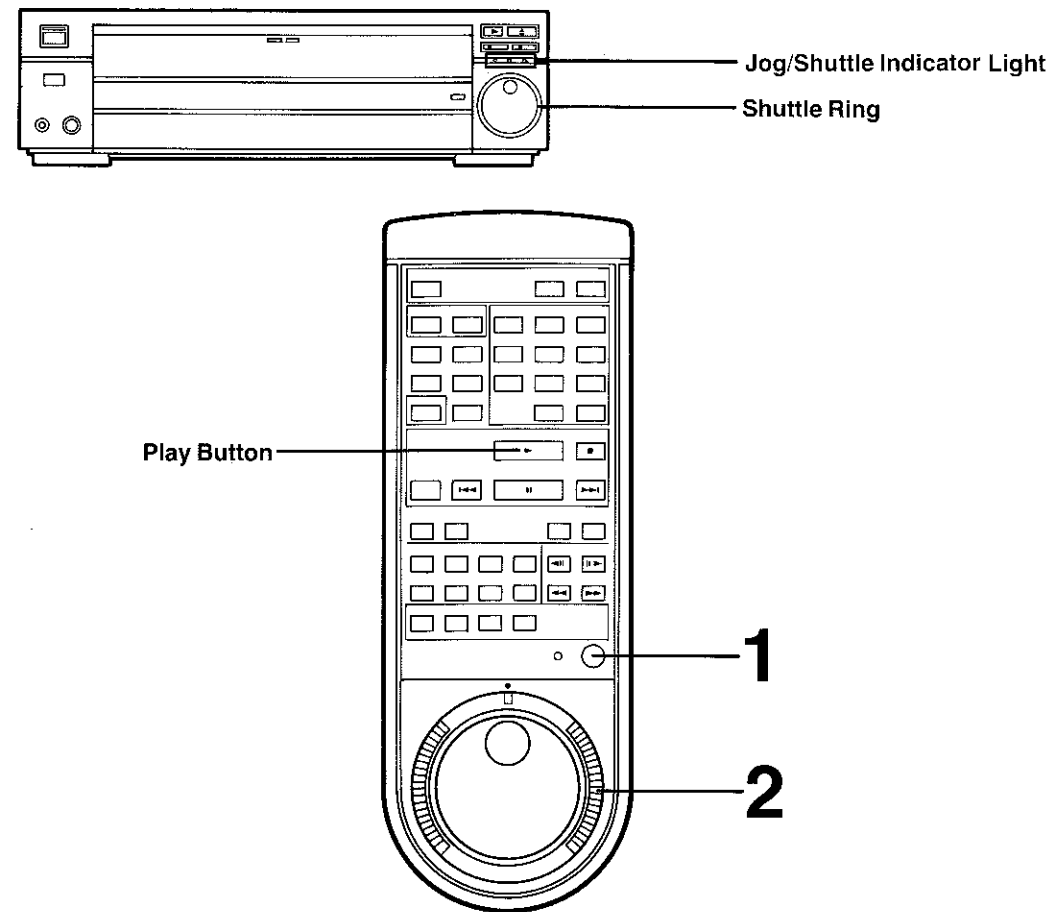

Picture Search with the Shuttle Ring [LD] [CDV] [CD]

1 Press the Jog/Shuttle Mode Button.

- The Jog/Shuttle Indicator lights up.
- This operation is not necessary when directly operating the Shuttle Ring on the Multi Laser Disc Player.

2 Turn the Shuttle Ring.

- By turning the Shuttle Ring, the playback speed and direction can be selected and changed immediately. (Refer to next page for additional instructions.)

When the Shuttle ring is released, it will automatically return to its center position.

Note:

This Shuttle Ring used for cue and review can not be used with LD discs recorded without chapters.

- When the Shuttle Ring is turned counterclockwise, the "◀" Indication will light up, and when the Shuttle Ring is turned clockwise, the "▶" Indication will light up.
- If the Remote Control is not aimed at the Infrared Receiver Window on the Laser Disc Player while turning the Shuttle Ring on the Remote Control, the playback will continue at the last selected playback speed.
- The Jog/Shuttle Lamp on the Remote Control is automatically turned off when the Shuttle Ring is not operated for more than a minute. In this case, the Jog/Shuttle Mode Button must be pressed again to be able to use the Shuttle Ring.

[LD] [CDV (Video Part)]

The playback speeds at the Shuttle Ring positions are different when the Jog/Shuttle Mode Button is turned during playback and when it is turned in the pause or still playback mode.

When the Jog/Shuttle Mode Button is turned during playback

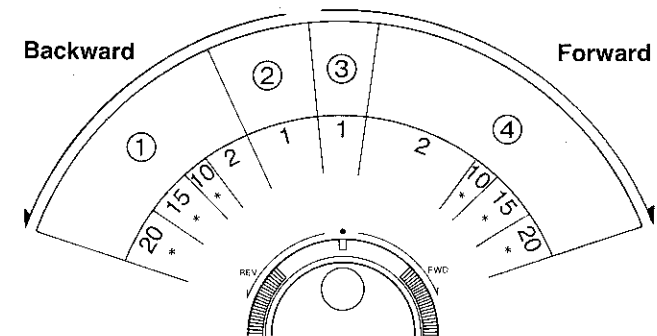

- 1 Review Playback
- 2 Reverse Playback
- 3 Normal Playback
- 4 Cue Playback

- The above numbers indicate multiples of normal playback speed.
- The sound is played back only when the Shuttle Ring is in its center position and in the playback mode.
- The figures marked with asterisks (*) indicate approximate multiples (fractions) of normal speed in case of LD (CAV). These figures do not apply to LD (CLV) and CDV (Video Part).

When the Jog/Shuttle Mode Button is pressed in the pause mode or in the still playback mode

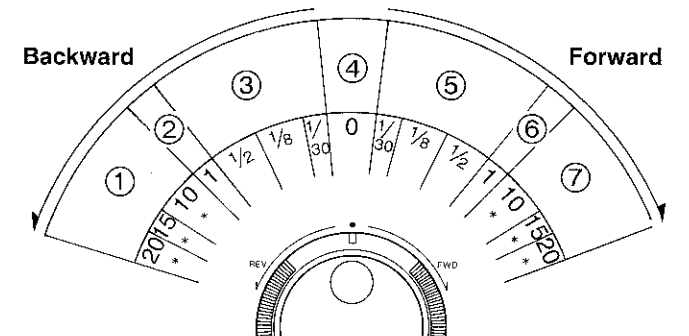

- 1 Review Playback
- 2 Reverse Playback
- 3 Reverse Slow Playback
- 4 Still Playback
- 5 Slow Playback
- 6 Normal Playback
- 7 Cue Playback

- The above numbers indicate multiples of normal playback speed.
- The sound is not played back only when the Shuttle Ring is in its center position and in the playback mode.
- The figures marked with asterisks (*) indicate approximate multiples (fractions) of normal speed in case of LD (CAV). These figures do not apply to LD (CLV) and CDV (Video Part).

[CD] [CDV (Audio Part)]

- When the Jog/Shuttle Mode Button is turned during normal playback, the Multi Laser Disc Player returns to the playback mode when the Jog/Shuttle Mode Button is released.
- When the Multi Laser Disc Player is in the pause mode and the Jog/Shuttle Mode Button is turned and then released, the player will return to the pause mode.

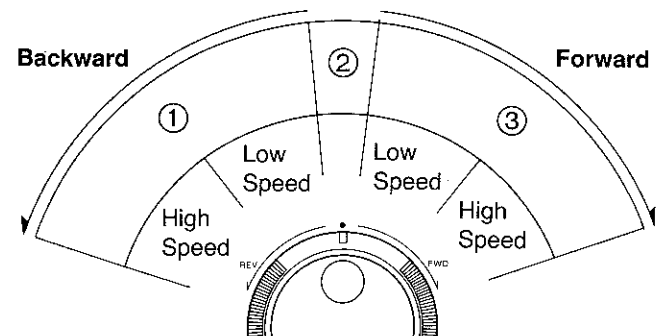

- 1 Review Playback
- 2 Playback or Pause
- 3 Cue Playback

Playback Functions (continued)

The picture can be advanced frame by frame in forward or reverse direction to locate exactly the desired frame.

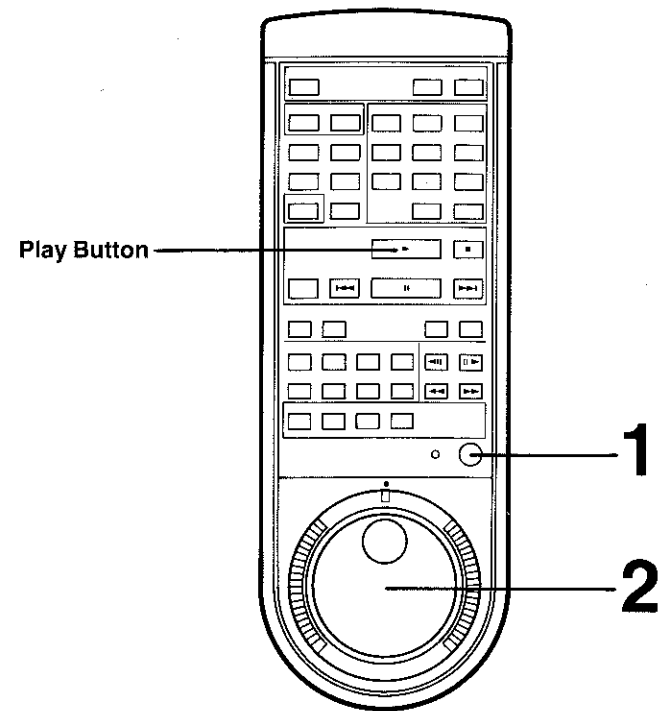
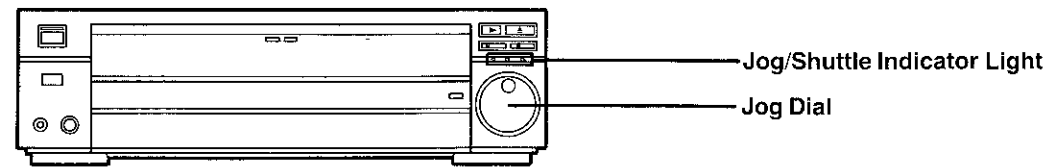

Picture Search with the Jog Dial [LD] [CDV] [CD]

1 Press the Jog/Shuttle Mode Button.

- The Jog/Shuttle Indicator lights up.
- This operation is not necessary when directly operating the Jog Dial on the Multi Laser Disc Player.
- When the Jog/Shuttle Mode Button is turned during playback, the playback will continue as before.

2 Turn the Jog Dial.

- Even during playback, turning the Jog dial one click changes the unit over to the still playback mode (in the audio part of a CDV and in case of a CD, it change to the pause mode for Disc program search).
- The Jog/Shuttle Indicator Lamps "•" on the Laser Disc Player light up.
- Turning the Jog Dial clockwise advances the picture in the forward direction, and turning counterclockwise advances the picture in the reverse direction.
- Turning the Jog Dial slowly advances the picture a single frame at a time.
If the Jog Dial is turned at more than 4 rotations per second, the playback speed will be the same as in normal playback (in forward or reverse direction).

To return to normal playback, press the Play Button.

Indications on the TV screen

Unlike LD (CAV) discs, LD (CLV) and the video part of CDV discs, do not have an individual number (frame number) assigned to each frame.

On the Multi Laser Disc Player, each second is divided into 30 frames, so that still and still advance playback can be performed even in the video part of CDV and LD (CLV) discs. When turning the Jog Dial, the figure between "00" and "29" will be displayed behind the Minute and Second Indications on the TV screen.

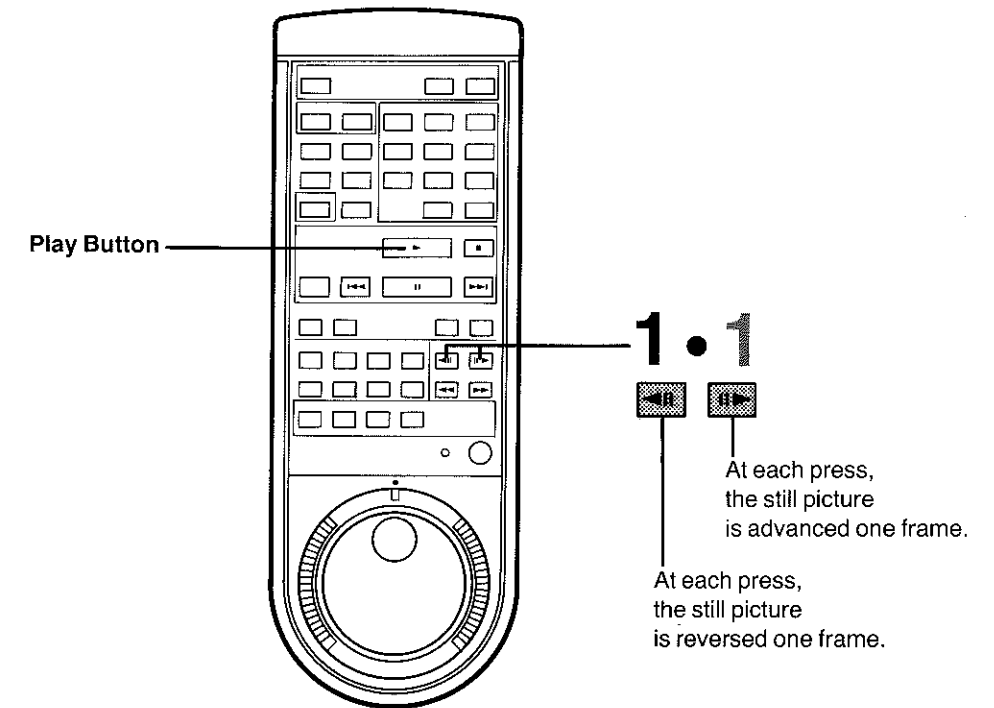

Still Playback [LD] [CDV (Video Part)]

1 Press the Still/Step Advance Button or the Still/Step Reverse Button while the Multi Laser Disc Player is in the normal playback mode.

- Either button can be pressed to reproduce a still picture.

To return to normal playback, press the Play Button.

Disc with the Automatic Picture Stop Function

When playing back a disc on which a special "Picture Stop Code" signal is recorded, the unit will automatically switch over to still playback as soon as the frame marked with the stop code is reached. To return to normal playback, Press the Play Button.

Still Advance (Reverse) Playback [LD] [CDV (Video Part)]

1 Press the Still/Step Advance Button or the Still/Step Reverse Button while the Multi Laser Disc Player is in the still playback mode.

- Each time you press either of these buttons, the still-picture will be advanced (or reversed) by one single frame.
- When either of these buttons is kept depressed for more than 2 seconds, the still-picture will be advanced (or reversed) one single frame per second. ("1/30" will be displayed on the screen.)

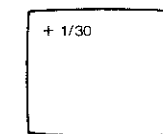

Advance

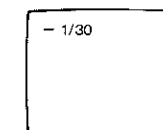

Reverse

To return to normal playback, press the Play Button.

Playback Functions (continued)

MULTI SPEED PLAYBACK [LD] [CDV (Video Part)]

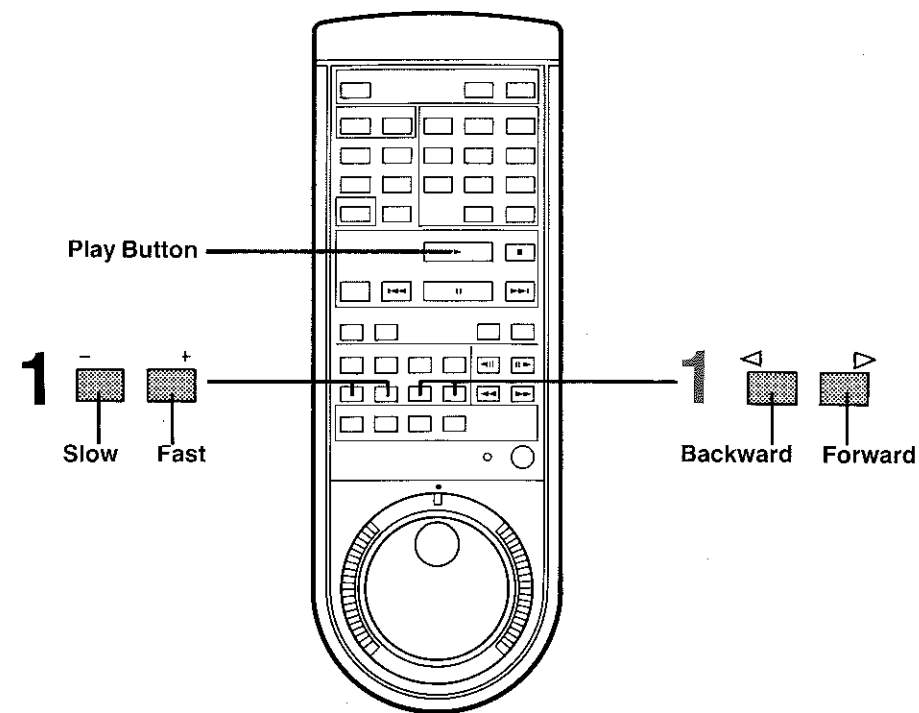

To Change the playback speed

1 Press either of the two Speed Selector Buttons (- Speed or Speed +) while the Multi Laser Disc Player is in the playback mode.

- Every press of either of these two buttons changes the playback speed as shown in the diagram.

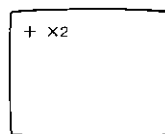

On-Screen Display Playback Speed	Description
×3	3 times normal playback speed
×2	2 times normal playback speed
×1	Normal playback speed
1/2	1/2 slow motion playback
1/4	1/4th slow motion playback
1/8	1/8th slow motion playback
1/16	1/16th slow motion playback
1/30	One single frame is played back for a second.
1/60	One single frame is played back for two seconds.
1/90	One single frame is played back for three seconds.

Note:

The above table is based on the playback of LD (CAV) discs. For LD (CLV) and the video part of CDV discs, the times for one frame are slightly different.

To change the playback direction

1 Press either of the Multi Speed Buttons (◀ Multi Speed or Multi Speed ▶).

- It is possible to change the playback speed in ten stages in both directions (forward and reverse) by using the Speed Selector Buttons and the Multi Speed Buttons.

- The audio is only heard in the normal playback mode in forward direction.

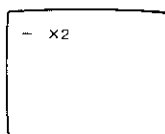
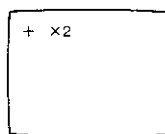

To return to normal playback, press the Play Button.

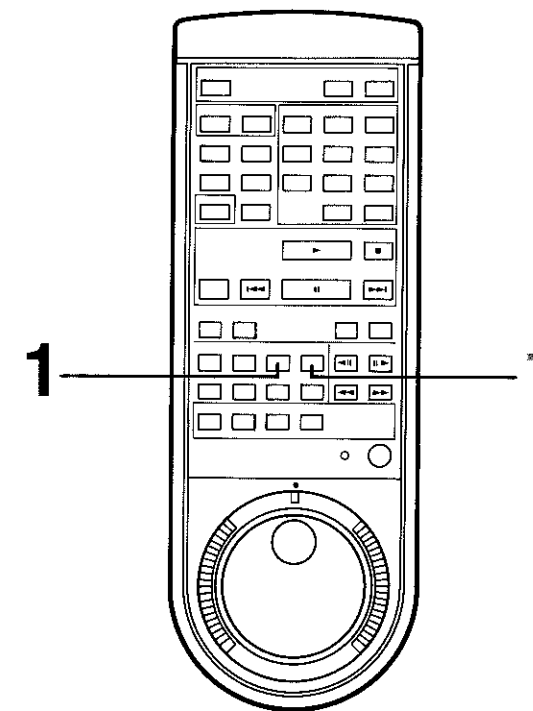

Still & Sound Playback [LD] [CDV (Video Part)]

1 Press the Still & Sound Button during playback at the point where you want to still the picture only.

- The audio can be heard without interruption, while the unit is in the still playback mode.
- Still picture playback is only possible on the currently played back side of an LD or within the video part of a CDV.

To return to normal playback mode, press the Still & Sound Button again or press the Play Button.

Art Playback [LD] [CDV (Video Part)]

The picture is processed digitally and a special effects can be obtained.

1 Press the Art Button during playback.
• The playback continues, but the picture will be superimposed with a special effect.

To change the degree of the special digital effect, press the Art Button.

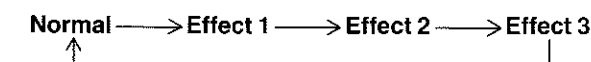

Playback Functions (continued)

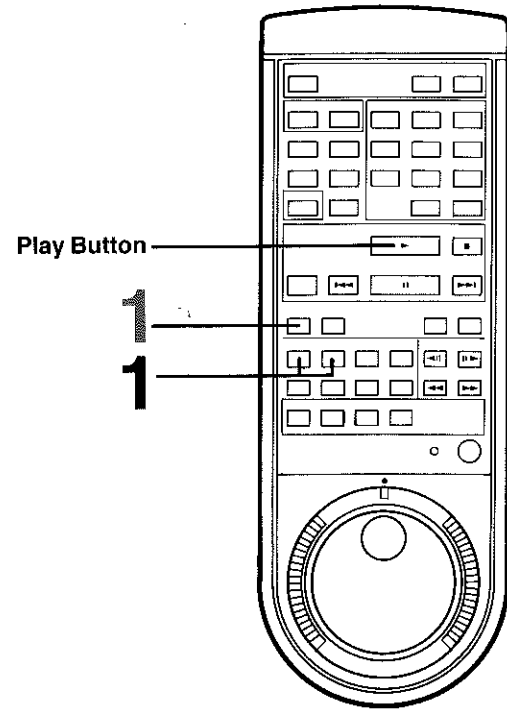

Strobe Playback [LD] [CDV (Video Part)]

- Press the Strobe Button during playback.
 - Each time you press the Strobe + (plus) or - (minus) Button, the strobe intervals will change as shown in the table right.

To return to normal playback, press the Play Button.

Strobe Playback Table

On-Screen Indication	Interval of Still Picture
×1	Normal playback
1/2	15 frames per second
1/4	Approx. 8 frames per second
1/8	Approx. 4 frames per second
1/16	Approx. 2 frames per second
1/30	1 frame per second
1/60	1 frame per 2 seconds
1/90	1 frame per 3 seconds

Random Playback [CDV] [CD]

- Press the Random Button while the Multi Laser Disc Player is in the normal playback mode or the stop mode.
 - The Multi Laser Disc Player automatically performs random playback. After all tracks or programs have been played back, it will go to the stop mode.

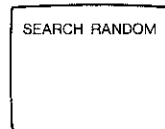

To return to normal playback, press the Random Button again.

Program Playback

Playback is performed in the user-specified order, regardless of the order in which the chapters or tracks are recorded on the disc. The programming is done by chapters or tracks.

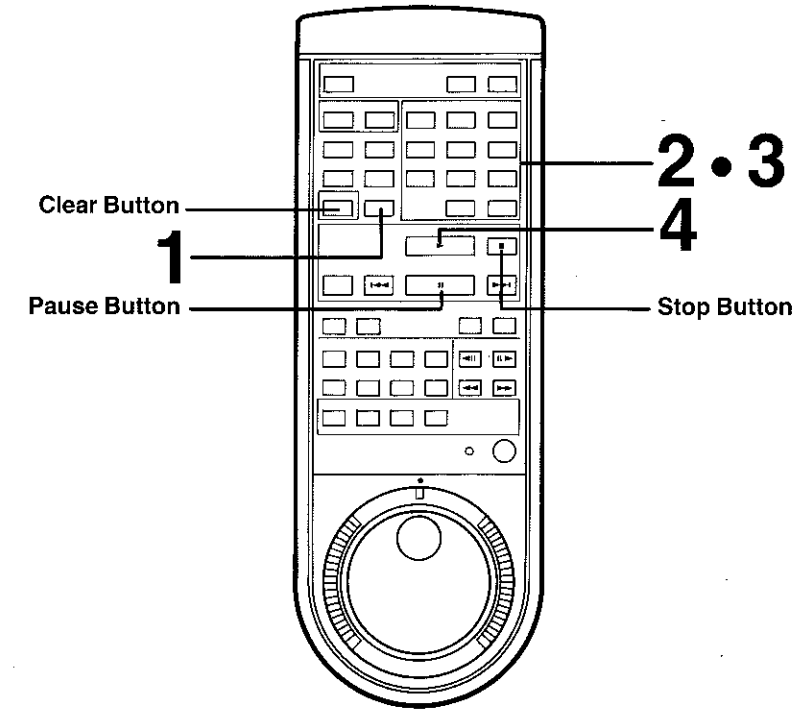

Normal program playback [LD] [CDV] [CD]

Example: To play back an LD in the order of chapter "3" → "1" → "4".

- Press the Program Button during playback or in the stop mode.

The TV screen will change over to the program mode. Program Number "1" will be displayed in the Multi-Function Display.

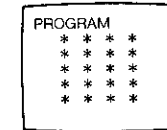
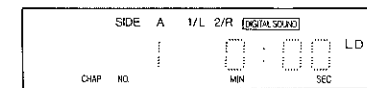

- Press the Numeric Button "3". Chapter Number "3" will be displayed on-screen.

- If you pressed a wrong number, press the Clear Button and then enter the correct Numeric Button.

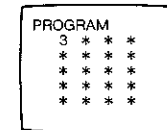
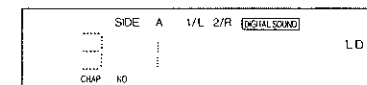

- Press the Numeric Buttons "1" and then "4".

- Up to 20 chapters can be programmed in sequence.

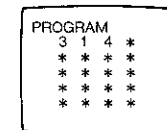

- Press the Play Button.
 - Program Playback starts.

- After all programmed chapters or tracks have been played back, the unit will go in the stop mode, and the TV screen will change over to the program mode again.

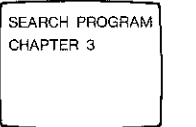

To stop the Program Playback halfway, press the Stop Button.

To start the Program Playback again, press the Play Button in the stop mode.

To return to the normal playback mode, press the Program Button during the Program Playback.

Note:

- When programming more than 20 chapters or tracks, the indication "- F" in the Multi-Function Display and the indication "FULL" on the TV screen will flash, no further chapters or tracks will be accepted.
- In case of LD discs, chapters that are not recorded on the disc can also be programmed. However, they will be skipped when the disc is played back.
- Program Playback is not possible with LD discs on which no chapter numbers are recorded.
- To pause at the beginning of the programmed sequence of chapters or tracks before the playback starts, press the Pause Button immediately after pressing the Play Button.

Program Playback (continued)

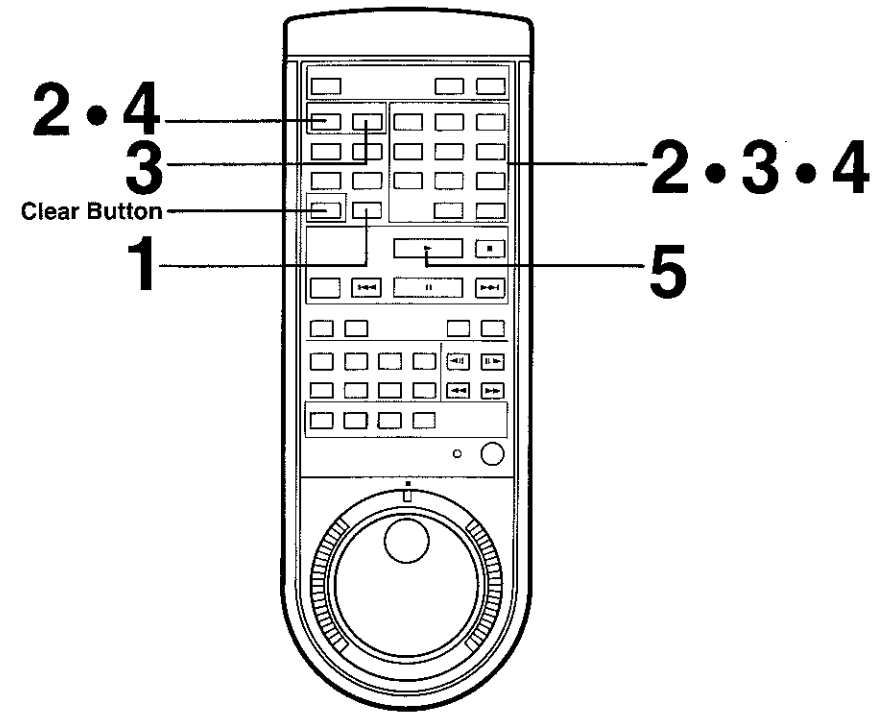

To Perform Program Playback on both sides [LD]

Example: To playback in the order of
Chapter 3 of Side A →
Chapter "1" of Side B →
Chapter "4" of Side A

1 Press the Program Button during playback or in the stop mode.
The TV screen changes over to the program mode. Program Number "1" will be displayed in the Multi-Function Display.



2 Press the Side A Button and then the Numeric Button "3".
Chapter Number 3 of Side A will be displayed on-screen.
•If you pressed a wrong number, press the Clear Button and then press the correct Chapter and Side Button.

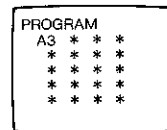

3 Press the Side B Button and then the Numeric Button "1".
•Be sure to press the Side Button first before entering the chapter number.



4 Press the Side A Button and then the Numeric Button "4".

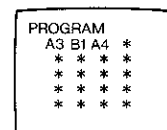

5 Press the Play Button.
•Program Playback starts.
•After all chapters have been played back, the unit will be in the stop mode, and the TV screen changes over to the program mode again.

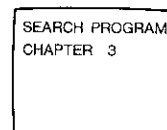

Note:
•If the unrecorded side is specified, for an LD disc that is recorded on only one side, Program Playback cannot be performed.
•In the Multi-Function Display, the chapter number(s) programmed for Side A light up during playback of Side A, and the chapter number(s) programmed for Side B light up during playback of Side B.

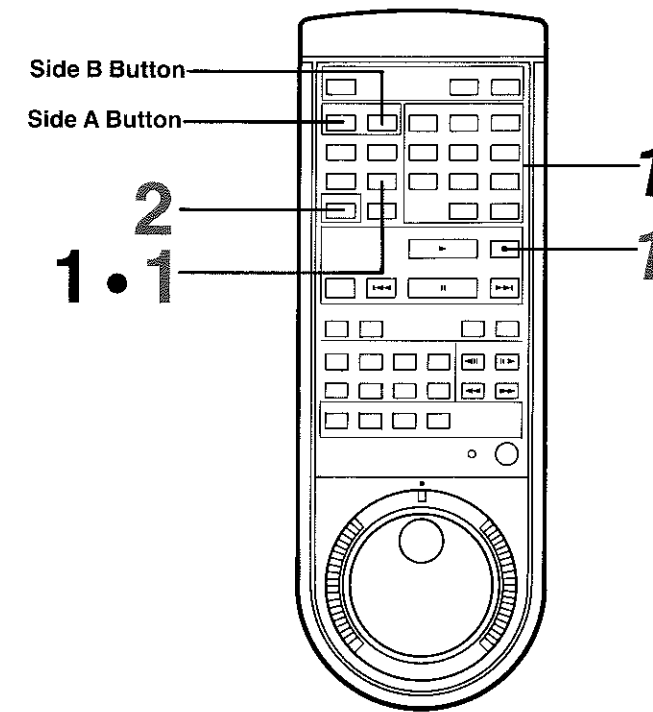

To confirm the chapters or tracks selected for Program Playback

1 Press the Recall Button.

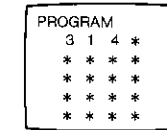

To cancel the chapters or tracks selected for Program Playback (It is possible to cancel them individually.)

1 Press the Recall Button, until the number of the chapter or track to be deleted flashes.

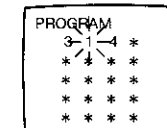

2 Press the Clear Button.
•The selected chapter or tracks is cancelled.

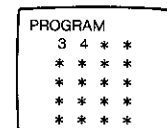

Note:
The chapter or track now being played back cannot be cancelled.

To add chapters or tracks for Program Playback (It is possible to add new chapter or tracks to be played back.)

1 Press the Numeric Button.
•If the Program Playback covers both sides of an LD, press the Side A or Side B Button before pressing the Numeric Button.

To cancel Program Playback

1 Press the Stop Button with the unit already in the stop mode.
•Program Playback can also be cancelled by turning off the unit or opening the Disc Tray.

To cancel Program Playback during playback:
Press the Stop Button twice.

Program Playback (continued)

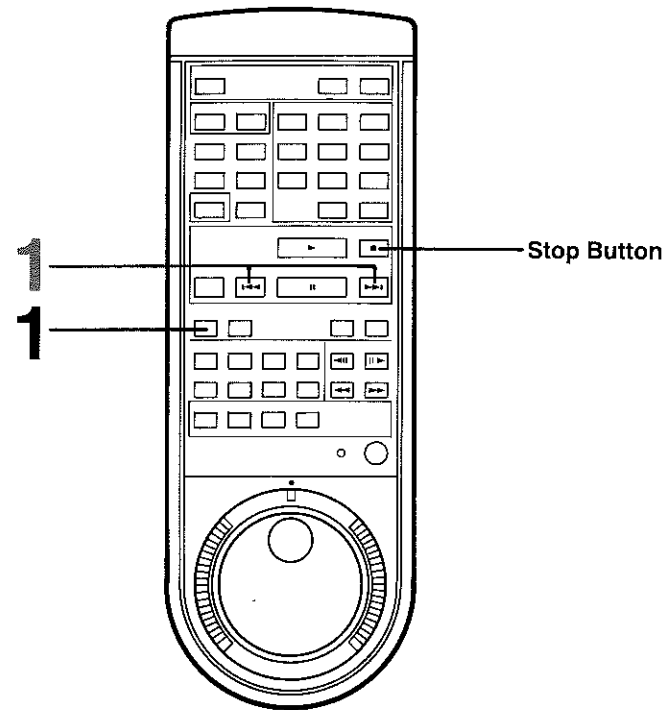

Random Program Playback [CDV] [CD]

To perform automatic playback in random sequence of the tracks selected for Program Playback:

- After selecting the desired tracks for Program Playback, press the Random Button.

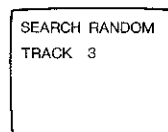

- After all tracks selected for Program Playback have been played back in random order, the unit will go into the stop mode.

To stop Random Program Playback, press the Stop Button.

Program Skip [LD] [CDV] [CD]

To skip during an undesired chapter or track during Program Playback:

- Press the Skip Button.

- Note:**
Program Skip cannot be performed while the indication "A --->B" or "B --->A" is displayed in the Multi-Function Display.

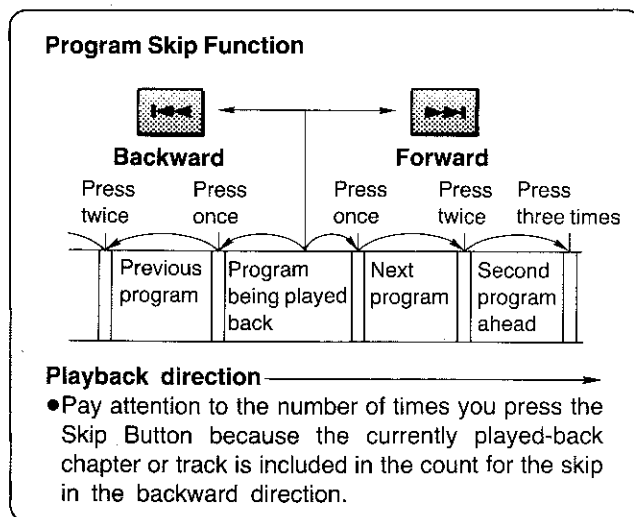

Repeat Playback

Seven Repeat Playback functions are possible.

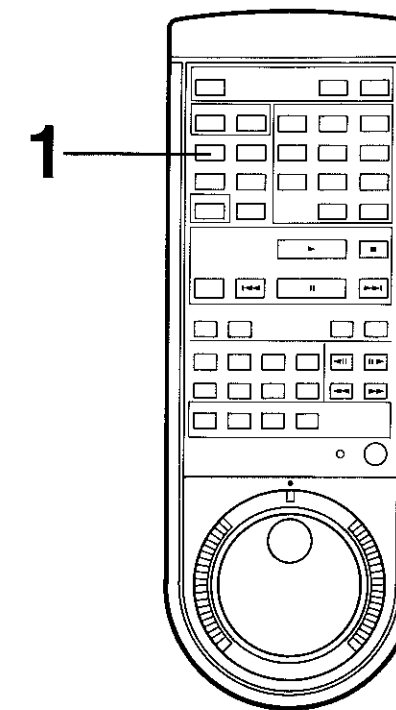

Chapter/Track Repeat, Side Repeat, All-Side Repeat

To repeatedly view the chapter being played back:
Chapter Repeat [LD]

To repeatedly listen to the track being played back:
Track Repeat [CDV] [CD]

To repeat the whole side being played back:
Side Repeat [LD] [CDV] [CD]

To repeat both sides of the disc:
All-Side Repeat [LD]

- This function can only be used when an LD disc recorded on both sides is played back.

- Press the Repeat Button during playback to select the desired repeat playback mode.

- Every time the Repeat Button is pressed the repeat playback mode display changes in the order indicated by the arrows in the illustration on the right.

Note:

When playing back an LD disc on which no chapter numbers are recorded, pressing the Repeat Button once will cause Side Repeat playback to be performed. Chapter Repeat will not be possible.

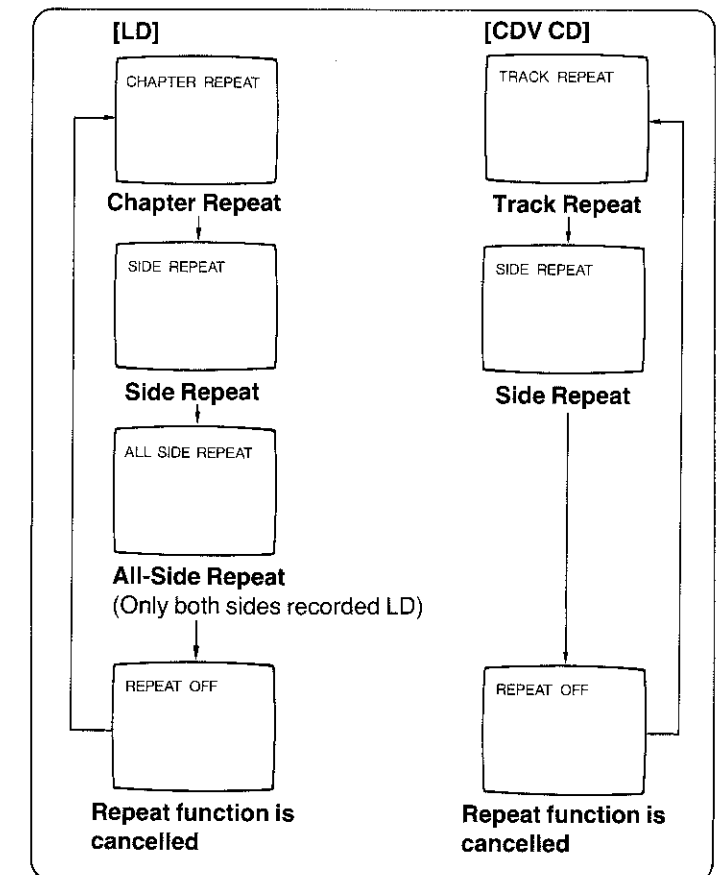

Repeat Playback (continued)

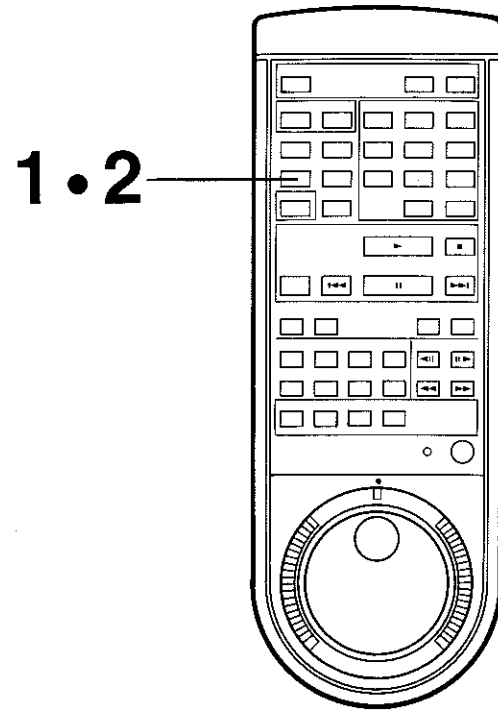

A-B Repeat [LD] [CDV] [CD]

To repeat the playback between two specified points:

- 1 During playback, press the A-B Repeat Button at the point from where you want to perform Repeat Playback.

- The repeat start point (A) is memorized.

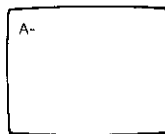

- 2 Press the A-B Repeat Button again at the point to which you want to perform Repeat Playback.

- The repeat end point (B) is memorized and the Repeat Playback between A and B starts.

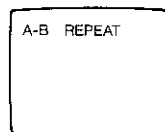

To cancel the A-B Repeat Playback

Press the A-B Repeat Button so that the display "A-B OFF" appears.

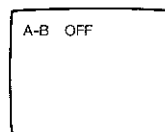

Note:

- On an LD disc, A-B Repeat Playback across both sides is not possible.
- On a CDV disc, A-B Repeat Playback across both video and audio parts is not possible.
- The Repeat Playback for long-play LD (CLV) discs is operated by the time number recorded on the disc. Therefore, on a disc on which time number is recorded in minutes only, the selected start and stop points of the A-B Repeat Playback may not exactly match the points where the A-B Repeat Button was pressed. However, this is not a malfunction.

Example:

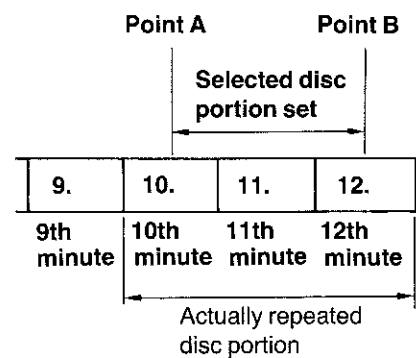

- The A-B Repeat Playback is not possible during all "Random Playback" and "Program Playback".
- When the A-B Repeat Button is pressed two times during one of the Repeat Playback functions explained on page 39, that function will be cancelled and the unit go into the A-B Repeat Mode.

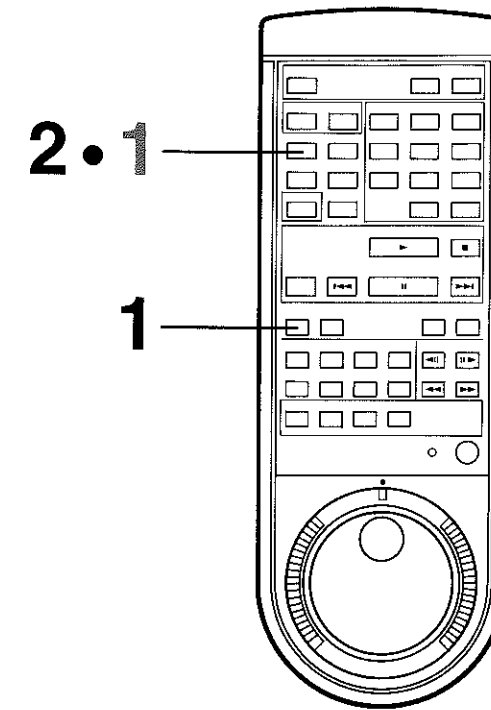

Random Repeat, Random Program Repeat [CDV] [CD]

To automatically perform Repeat Playback in random sequence (Random Repeat):

- 1 Press the Random Button.

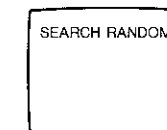

- 2 Press the Repeat Button.

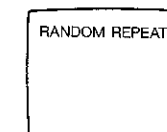

To cancel the Random Repeat function, press the Random button again.



To automatically repeat the playback in random sequence of the tracks selected for Program Playback (Random Program Repeat):

After selecting the desired tracks for Program Playback as described on page 35 and pressing the Random Button, press the Repeat Button.

To cancel the Random Program Repeat function, press the Program Button again.

Program Repeat [LD] [CDV] [CD]

To automatically repeat Program Playback:

- 1 Press the Repeat Button during Program Playback.

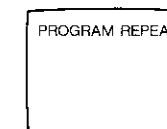

- Regarding the operation for Program Playback, refer to page 35 and subsequent pages.

To cancel the Program Repeat function, press the Program Button.

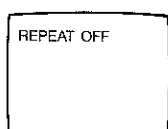

Edit Playback

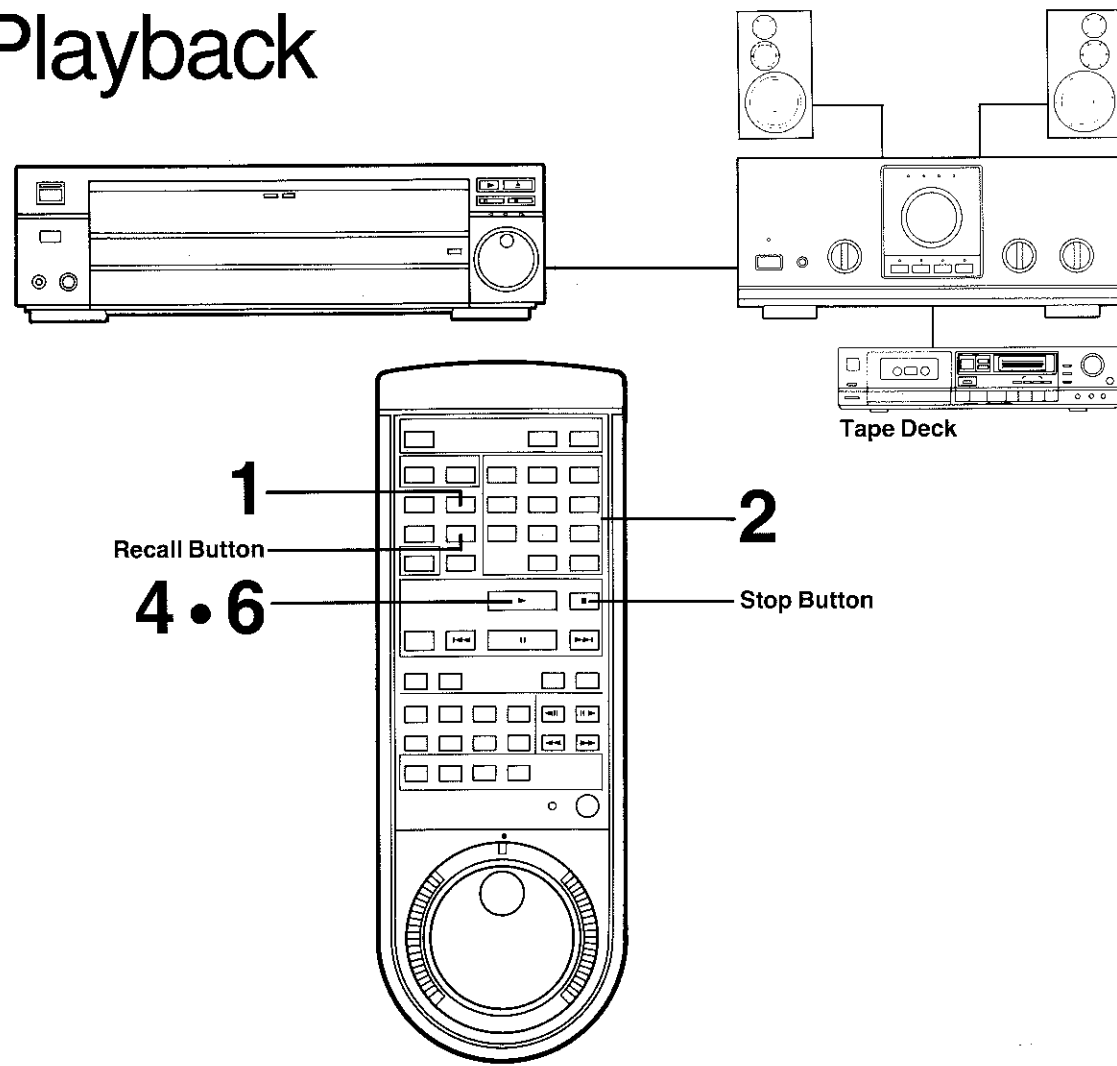

To confirm the edited tracks, press the Recall Button.

To stop editing midway, press the Stop Button.

Note:

During editing, only the Time Mode Button, Audio Level Button, Display Button, Recall Button, Stop Button and the Open/Close (Play) Button can be operated.

Editing Calculation

As the order of programs which are recorded on a disc, the program numbers that were edited up to the possible limit on the former half of the specified tape (23 minutes in case of a 46-minute tape) will be registered on Side A. Next, the next track of the last track number on Side A will be registered on Side B in the same way.

Note:

- Depending on the length of the tape, it may not be possible to edit all the tracks recorded on a disc.
- When the specified tape length is shorter than the first chapter or track, the editing calculation cannot register chapter or track.
In this case, insert a new cassette tape of sufficient length, and input the tape time again.

To perform editing according to the programmed order

After performing the procedures for Program Playback (p. 35), execute the operations described on the previous page.

As the order of programmed tracks, the track numbers that were edited up to the possible limit on the former half of the specified tape (23 minutes in case of a 46-minute tape) will be registered on Side A. Next, the next programmed track number on Side A will be registered on Side B in the same way.

Note:

Depending on the length of the tape, it may not be possible to edit all the programmed tracks.

Editing Function [CD]

Preparations

1. Prepare the audio equipment. For the connections, refer to page 44.
2. Insert a cassette tape into the tape deck.
3. Insert the disc in the Multi Laser Disc Player.

(Example) To dub onto a 46-minute audio cassette tape:

1 Press the Edit Button.

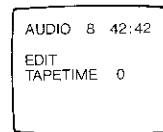

2 Press the Numeric Buttons [+10]→[+10]→[+10]→[+10]→[6] to input the maximum available tape time.

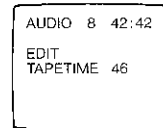

- It is possible to specify up to max. 99 minutes.
- If you press the wrong number, press the Numeric Buttons again from the start after pressing the Edit Button again.
- It is possible to edit up to 20 programs.

After the maximum tape time has been input, the Multi Laser Disc Player automatically calculates and divides the tracks to be edited onto side A and side B of the tape.

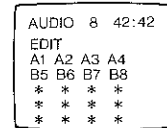

3 Put the tape deck in the recording mode.

4 Press the Play Button.
• Editing is started on side A of the cassette tape.

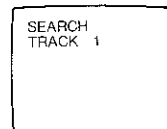

- When the editing is finished on side A, Multi Laser Disc Player is put in the pause mode at the start of the track to be recorded onto side B of the tape.

5 After preparing the tape deck and cassette for recording onto side B, put the tape deck in the recording mode.

6 Press the Play Button.
• The editing starts on side B of the cassette tape.

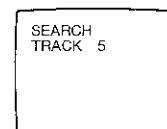

Connections

TV Set with video input jack and audio equipment

•Carefully read the operating instructions of other equipment to be connected, to the Multi Laser Disc Player.

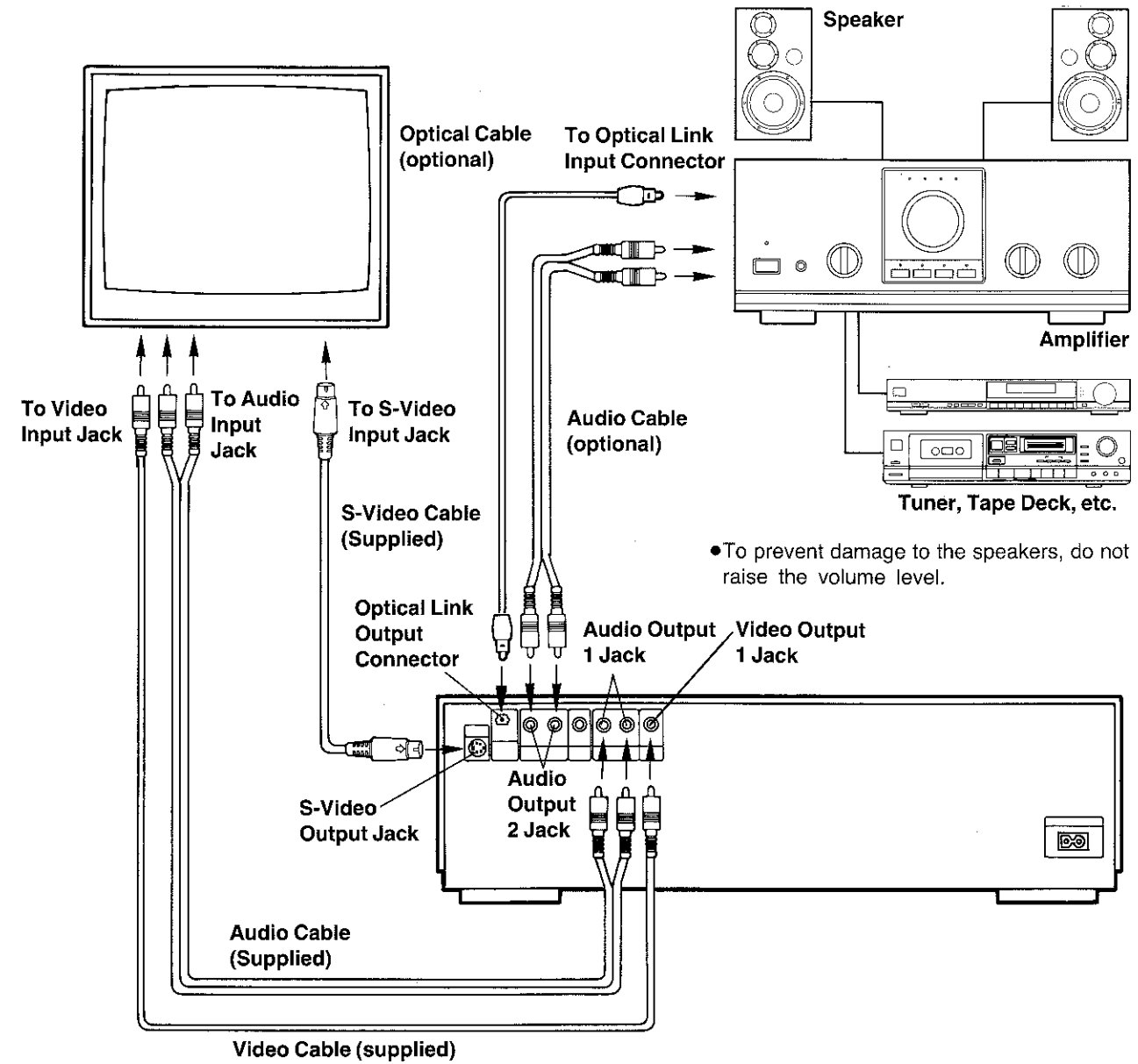

Example of an Audio-Video System

If you have other AV equipment such as a VCR and BS Tuner, it is convenient to connect them via an optional Audio-Video Selector.

- The Audio Video Selector allows easy switching of picture and sound between the different units for playback and recording.
- For details, refer to the operating instructions of the Audio-Video Selector.

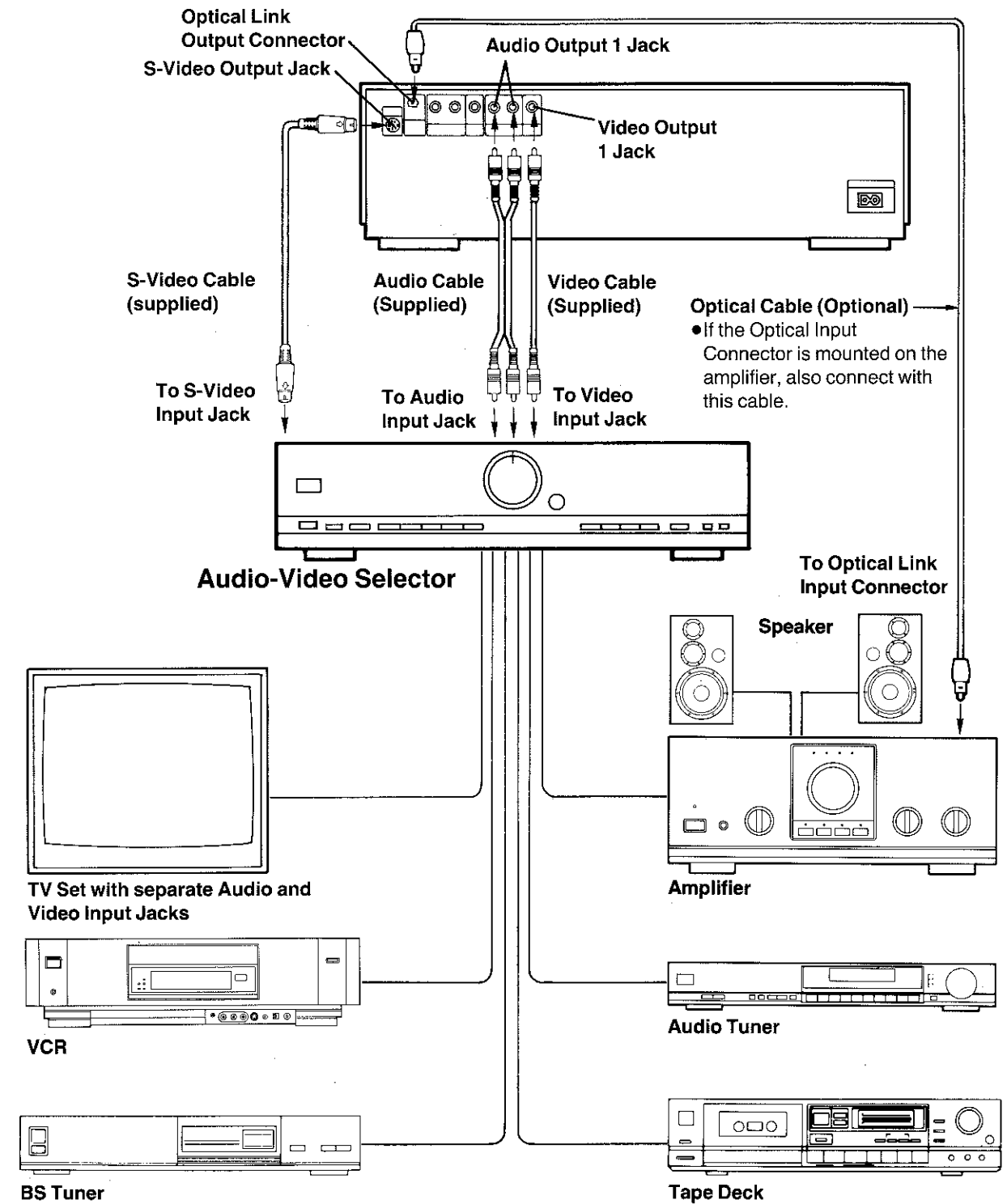

Connections (continued)

S-Video Output Jack

The conventional video output jacks output a combination of the luminance signal (Y) and color signal (C). The new S (Separate)-Video Jack allows separate transmission of these two signals to a TV set in order to obtain better picture quality.

It is recommended to use the supplied S-Video Cable to connect this Laser Disc Player with a TV set that is also equipped with S-Video Jack.

Optical Link Output Connector

This connector is only used for the digital sound.

It is not possible to select the audio track with the Audio Selector Button.

In the Optical Transmission System, the electric signals are converted into optical signals for transmission. The special advantages of this system are that the signals remain virtually unaffected by electrical noise and external influences. This Multi-Laser Disc Player is equipped with an Optical Link Output Connector that makes it possible to transmit the digital sound and with excellent quality to the amplifier via optical cable. It is recommended to use the optional Optical Cable for connecting the Multi-Laser Disc Player to the Optical Link Input Connector on the amplifier.

Remarks on the optional Optical Cable

- Be sure to use an optical cable with a length of no more than 3 m.
- Be sure to insert the plug completely and with the shape of the plug properly matched to that of the socket.
- Make sure that there are no sharp bends in the cable.
- For storage, keep the diameter of the loops bigger than 15 cm.
- Take care that the plugs of the optical cable do not get damaged or dusty.
- If the plugs have become dusty, wipe them with a soft cloth before connecting.

① Remove the dust cap.



② Connect the cable.



Keep the dust cap and be sure to reattach it if the optical cable is disconnected.

Cautions For Use

Be sure to follow the items mentioned below for the safe and correct operation of this unit.

Avoid Sudden Changes in Temperature

If the Multi-Laser Disc Player is suddenly moved from a cold place to a warm place, moisture may form on the disc and inside the unit.

Condensation may form in the Multi-Laser Disc Player if:

- The unit is in a room where the heater has just been turned on.
- The unit is in a room with steam or high humidity.
- The unit is brought from cold surroundings into a well-heated room.
- The unit is suddenly brought from cool surroundings, such as an air-conditioned room or car, to a place which is hot and humid.

Note:

- Do not operate the Multi-Laser Disc Player for at least 1 hour if any of the above conditions occur. This unit does not incorporate a dew sensor.
- If dew has formed on the surface of a disc, carefully wipe it with a soft cloth.

If the Multi-Laser Disc Player Is Placed Near the TV Set:

The picture and sound may be adversely affected during the playback on this unit. If this symptom occurs, place the unit farther away from the TV set.

Never place anything except the specified discs on the Disc Tray.

Humidity and Dust

Avoid places where there is high humidity or much dust, which may cause damage to internal parts.

Do Not Obstruct the Ventilation Holes

The ventilation holes prevent abnormal increase in temperature. Do not block or cover these holes.

Keep away from High Temperature

Keep the Multi-Laser Disc Player away from extreme direct heat such as direct sunlight, heating radiators, or closed automobiles.

Keep Magnets away

Never bring a magnet or magnetized object near the Multi-Laser Disc Player because it will adversely affect the performance of the unit.

No Fingers or Other Objects Inside

Touching internal parts of this Multi-Laser Disc Player is dangerous, and may cause serious damage to the unit. Do not attempt to disassemble the unit. There are no user serviceable parts inside.

Keep Water away

Keep the Multi-Laser Disc Player away from flower vases, tubs, sinks, etc. CAUTION: If liquids are spilled into the unit, serious damage could occur. If you spill any liquid into the unit, consult qualified service personnel.

Lightning

To avoid damage by lightning, disconnect the AC plug from the Multi-Laser Disc Player.

Cleaning the Multi-Laser Disc Player

Wipe the unit with a clean, dry cloth. Never use cleaning fluid, or other chemicals. And do not use compressed air to remove dust.

Stacking

Place the Multi-Laser Disc Player in a horizontal position, and do not place anything heavy on it.

Do not expose the Multi-Laser Disc Player when carrying it.

When the unit is not used for a long period of time.

Be sure to remove the disc and turn the unit off. Be sure to unplug the AC cord.

Cautions For Using Discs

Do not use damaged or warped discs

- The disc rotates at high speed in the player. Do not use a damaged disc. It could cause a defect and malfunction of the unit.
- If the disc is scraping against the Disc Tray after it starts playing (strange noise or vibration occurs), press the Stop Button or the Open/Close Button immediately to stop the disc rotation.
- Do not use the stabilizer for CDs.

The discs rotate at very high speed. Therefore, trying to play back defective discs such as cracked or warped discs, as well as discs that are not correctly placed in the proper recess on the Disc Tray, is very dangerous.

- Never use any discs that are cracked, chipped, warped or repaired with glue or adhesive tape.

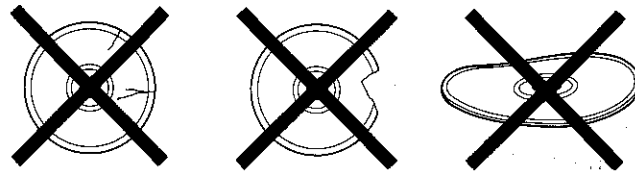

Cracked

Chipped

Warped

Cautions for storage

- Always remove the disc after use from the Multi Laser Disc player and store it in the case vertically. Inclining or stacking the discs may cause them to bend.

- Do not store discs in places exposed to direct sunlight, high temperatures and high humidity.
- Do not attach any labels to the discs. Be careful not to damage the discs.

Cleaning

- Wipe off the dust, dirt and fingerprints on the disc with a soft, dry, lint-free cloth.
- If the surface is extremely dirty, use a soft, clean cloth moistened with water. Then wipe dry with a soft dry cloth.
- When wiping the disc, always move the cloth directly outward from the center of the disc. (Circular scratches are more likely to cause errors than straight scratches from center to outer circumference of the disc.)

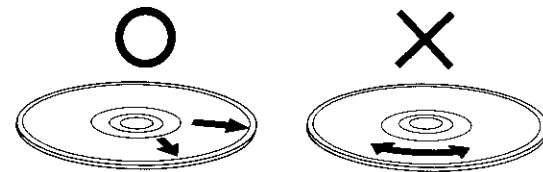

- Do not use benzine, thinner or record sprays.
- Do not use static electricity prevention liquids or sprays.

- Place only a single disc in the proper recess on the Disc Tray according to its size and make sure it lies completely flat. Never place two or more discs on the tray and never attempt playback with a disc improperly install in its disc tray.

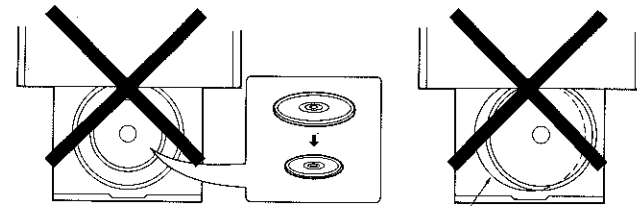

Two discs are inserted at the same time.

The disc improperly install in its disc tray.

- If unusual vibration or noise occur during playback of a disc, press the Stop Button or the Open/Close Button. Check whether the disc is properly placed and not damaged, before trying to play it back again.

Before Requesting Service

Before requesting service, check the following points again:

SYMPTOM	CAUSE	REMEDY
Power does not turn on.	The AC Power Cable is unplugged.	Plug in the AC Power Cable.
The Disc Tray does not come out.	The power is not turned on.	Turn on the power.
Playback does not start. Playback stops soon after starting playback.	Condensation has formed in the Player.	Wait until condensation has dissolved.
	Disc is not inserted correctly.	Insert the disc correctly.
	Unrecorded side of the disc is being played back.	Play back the correct side of the disc.
	Disc is extremely dirty.	Wipe the disc with a soft, clean cloth.
No playback picture appears. Playback picture is not clear.	The Player is not connected correctly.	Connect the Player correctly.
	TV set is not set to the video playback channel.	Set the TV set to the video playback channel.
	The video playback channel on the TV set is not properly tuned.	Carefully read the operating instructions of the TV and adjust with the tuning controls on the TV.
	Condensation has formed.	Wait until condensation has dissolved.
	Disc is flawed or dirty.	Wipe the disc with a soft, clean cloth.
	Speakers are placed too close to the TV set.	Place speakers farther away from the TV set.
	Still Playback, Still Advance (Reverse) Playback and Multi Speed Playback cannot be performed.	A Long Play disc (CLV) is being played back.
No sound is reproduced.	Multi Speed Playback is being performed.	Sound is reproduced only during playback in forward direction.
	No sound is heard. The sound can hardly be heard.	Condensation has formed.
	The Player is not correctly connected to the stereo set.	Connect the Player correctly.
	Incorrect operation of the stereo set (amplifier).	Operate the stereo set correctly.
	Remote Control does not work.	Remote Control Transmitter is not being pointed at the Infra-red Receiver Window on the Player.
	Distance is too large (more than 7 m from the Player).	Operate within a distance of 7 m.
	An obstacle is between the Remote Control Transmitter and the Player.	Remove the obstacle.
	Batteries are exhausted.	Replace with new batteries.
	Battery polarities (+, -) are reversed.	Insert the batteries correctly.
Search functions are extremely slow.	Disc is flawed or dirty.	Wipe the disc with a soft, clean cloth.

Possible Functions For The Different Discs

Possible Functions	Disc Type					Page
	LD		CDV		CD	
	Standard Disc (CAV)	Long Play Disc (CLV)	Video+ Audio Section	Audio Section		
Normal Playback	•	•	•	•	•	13
Restart Playback from stopped position	•	•	—	—	—	13
Reverse Playback	*1	*1	—	—	—	14
Repeat Playback from a Certain Position	•	•	•	•	•	15
Forward or Backward to a Desired Position	•	•	•	—	—	21
Skipping to Desired Position	*2	*2	—	—	—	21
Direct Access to Desired Position	*2	*2	—	—	—	22
Direct Access to Desired Frame	•	—	—	—	—	23
Direct Access by Playback Time to Desired Scene	—	•	—	—	—	24
Forward or Backward to Desired Tune	—	—	•	•	•	25
Skipping to Desired Tune	—	—	—	•	•	25
Direct Access to Desired Tune	—	—	•	•	•	26
Skipping indexes within a track	—	—	•	•	•	27
Changing the playback speed and direction with the Shuttle Ring	•	•	•	•	•	28
Changing the playback speed and direction with the Jog Dial	•	•	•	•	•	30
Still Playback	•	•	•	—	—	31
Still Advance and Still Reverse Playback	•	•	•	—	—	31
Change of Playback Speed and Direction	•	•	•	—	—	32
Stopping the action to watch a still picture while the sound reproduction continues normally	•	•	•	—	—	33
Watching the picture with special effects	•	•	•	—	—	33
Watching the picture with strobe effect while the sound reproduction continues normally	•	•	•	—	—	34
Automatic Playback in Random Sequence	—	—	•	•	•	34
Playback in Programmed Order	*2	*2	•	•	•	35
Automatic Playback of Programmed Tracks at Random	—	—	•	•	•	38
Repeat Playback of the Chapter/Track Being Played Back	*2	*2	•	•	•	39
Repeat Playback of the Whole Side Being Played Back	•	•	•	•	•	39
Repeat Playback of Both Sides of the Disc	*1	*1	—	—	—	39
Repeat Playback Between to Specified Points	•	•	•	•	•	40
Automatic Repeat at Random	—	—	•	•	•	41
Repeat Playback in Programmed Order	*2	*2	•	•	•	41
Repeat Playback of Programmed Tracks at Random	—	—	•	•	•	41
Editing onto cassette tapes	—	—	—	—	•	42

*1 Possible only for LD's recorded on both sides.

*2 Possible only for discs with recorded chapter numbers.

Specifications

Is Safety Information

Power Source:	AC 120 V, 50/60 Hz
Power Consumption:	48 W
Television System:	NTSC
Format:	Laser Vision Video Disc System, Compact Disc with Video and Compact Disc, Digital Audio System
Weight:	25.3 lbs (11.5 kg)
Dimensions:	16.9 (W)×5.1 (H)×16.9 (D) inches [430 (W)×129 (H)×429 (D) mm]
Operating Temperature:	+5~+35°C
Operating Humidity:	5~90%
Usable Discs:	(1) Laser Vision Disc 12" (30 cm) Long Play Disc (CLV) 1800~600 rpm 2-hour playback (max.) for both sides 12" (30 cm) Standard Disc (CAV) 1800 rpm 1-hour playback (max.) for both sides 8" (20 cm) Long Play Disc (CLV) 40-minute playback (max.) for both sides/20-minute playback (max.) for single side 8" (20 cm) Standard Disc (CAV) 28-minute playback (max.) for both sides/14-minute playback (max.) for single side (2) Compact Disc 5" (12 cm) Disc 500~200 rpm 74-minute playback (max.) for single side 3" (8 cm) Disc 500~300 rpm 20-minute playback (max.) for single side (3) Compact Disc with Video Video Section 2700~1800 rpm 5-minute playback (max.) for single side Audio Section 500~300 rpm 20-minute playback (max.) for single side
Video Signal Output Level:	1 Vp-p (at 75 ohm, synchronizing load)
S-Video Output Level: (Y/C Separate Signal Output)	Y Output/1 Vp-p (When loading 75 ohm, synchronizing load) C Output/0.286 Vp-p (When loading 75 ohm, synchronizing load)
Audio Signal Output Level:	(1) Digital Audio Output Level 200 m Vrms (1 kHz, -20 dB) (2) Analog Audio Output Level 200m Vrms (1 kHz, Modulated 40%)
Digital Audio Signal Output Characteristic:	(1) Frequency Response; 4 Hz~20 kHz (EIAJ) (2) S/N Ratio; 110 dB (EIAJ) (3) Dynamic Range; 98 dB (EIAJ) (4) Channel Separation; 110 dB (1 kHz) (EIAJ) (5) Wow and Flutter; Below measurable limit (6) Total Harmonic Distortion; 0.0027% (1 kHz) (EIAJ) (7) Harmonic Distortion (HD); 0.0018% (1 kHz)
Headphone Output Level:	32 ohm (30 mW), Impedance; more than 8 ohm

**Panasonic Company, Division of
Matsushita Electric Corporation of America**
One Panasonic Way
Secaucus, New Jersey 07094

**Panasonic Sales Company, Division of
Matsushita Electric of Puerto Rico, Inc.**
San Gabriel Industrial Park
65th Infantry Ave. Km. 9.5
Carolina, P.R. 00630

Printed in Japan
VQT3837



F0790Y0-1000®

**Panasonic Company, Division of
Matsushita Electric Corporation of America**
One Panasonic Way
Secaucus, New Jersey 07094

**Panasonic Sales Company, Division of
Matsushita Electric of Puerto Rico, Inc.**
San Gabriel Industrial Park
65th Infantry Ave. Km. 9.5
Carolina, P.R. 00630

Printed in Japan
VQT3837



F0790Y0-1000®

Free Manuals Download Website

<http://myh66.com>

<http://usermanuals.us>

<http://www.somanuals.com>

<http://www.4manuals.cc>

<http://www.manual-lib.com>

<http://www.404manual.com>

<http://www.luxmanual.com>

<http://aubethermostatmanual.com>

Golf course search by state

<http://golfingnear.com>

Email search by domain

<http://emailbydomain.com>

Auto manuals search

<http://auto.somanuals.com>

TV manuals search

<http://tv.somanuals.com>