

Panasonic



Digital Video Cassette Recorder

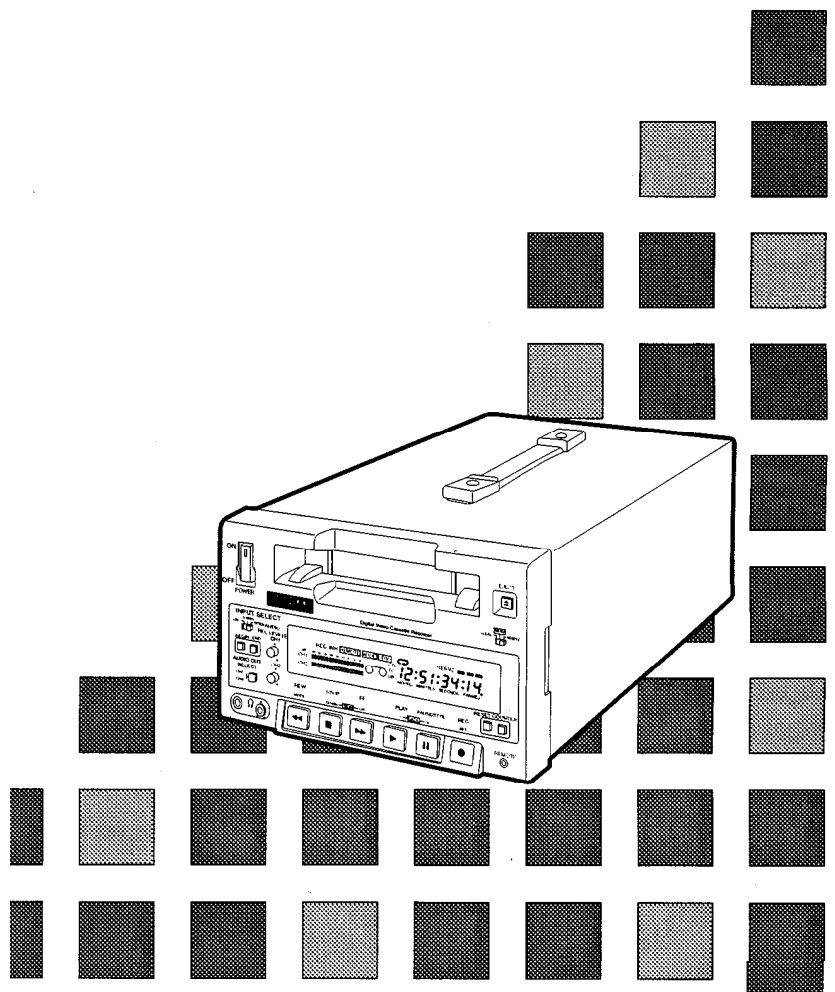

AJ-D230H P

Operating Instructions



IMPORTANT

"Unauthorized recording of copyrighted television programs, video tapes and other materials may infringe the right of copyright owners and be contrary to copyright laws."

	CAUTION RISK OF ELECTRIC SHOCK DO NOT OPEN	
CAUTION: TO REDUCE THE RISK OF ELECTRIC SHOCK, DO NOT REMOVE COVER (OR BACK). NO USER SERVICEABLE PARTS INSIDE. REFER TO SERVICING TO QUALIFIED SERVICE PERSONNEL.		



The lightning flash with arrowhead symbol, within an equilateral triangle, is intended to alert the user to the presence of uninsulated "dangerous voltage" within the product's enclosure that may be of sufficient magnitude to constitute a risk of electric shock to persons.



The exclamation point within an equilateral triangle is intended to alert the user to the presence of important operating and maintenance (service) instructions in the literature accompanying the appliance.

CAUTION:

Do not install or place this unit in a bookcase, built in cabinet or in another confined space in order to keep well ventilated condition. Ensure that curtains and any other materials do not obstruct the ventilation condition to prevent risk of electric shock or fire hazard due to overheating.

WARNING:

TO REDUCE THE RISK OF FIRE OR SHOCK HAZARD, DO NOT EXPOSE THIS EQUIPMENT TO RAIN OR MOISTURE.

CAUTION:

TO REDUCE THE RISK OF FIRE OR SHOCK HAZARD AND ANNOYING INTERFERENCE, USE THE RECOMMENDED ACCESSORIES ONLY.

FCC Note:

This device complies with Part 15 of the FCC Rules. To assure continued compliance follow the attached installation instructions and do not make any unauthorized modifications.

This equipment has been tested and found to comply with the limits for a class A digital device, pursuant to Part 15 of the FCC Rules. These limits are designed to provide reasonable protection against harmful interference when the equipment is operated in a commercial environment. This equipment generates, uses, and can radiate radio frequency energy and, if not installed and used in accordance with the instruction manual, may cause harmful interference to radio communications. Operation of this equipment in a residential area is likely to cause harmful interference in which case the user will be required to correct the interference at his own expense.

 is the safety information.

- Do not insert fingers or any objects into the video cassette holder.
- Avoid operating or leaving the unit near strong magnetic fields. Be especially careful of large audio speakers.
- Avoid operating or storing the unit in an excessively hot, cold, or damp environment as this may result in damage both to the recorder and to the tape.
- Do not spray any cleaner or wax directly on the unit.
- If the unit is not going to be used for a length of time, protect it from dirt and dust.
- Do not leave a cassette in the recorder when not in use.
- Do not block the ventilation slots of the unit.
- Use this unit horizontally and do not place anything on the top panel.
- Cassette tape can be used only for one-side, one direction recording. Two-way or two-track recordings cannot be made.
- Cassette tape can be used for either Color or Black & White recording.
- Do not attempt to disassemble the recorder. There are no user serviceable parts inside.
- If any liquid spills inside the recorder, have the recorder examined for possible damage.
- Refer any needed servicing to authorized service personnel.

Table of Contents

Introduction	5
Features	5
Controls and Their Functions	6
• Front panel	6
• Connector section	9
Tapes	11
Operation	12
• Switching on the power and inserting the cassette	12
• Stop mode	13
• Recording	14
• Pause/still recording (back-space assemble recording)	15
• Playback	15
• Cue and Review	16
• Still-picture playback	16
• Frame advance	16
• Sound selection	16
• Repeat playback	17
Time Code and User's Bit	19
• Time code	19
• User's bit	19
• Setting the time code	20
• Setting the user's bit	20
• Time code and user's bit playback	21
Superimposed Display Screens	22
Set-up (Default Settings)	23
Set-up Menus	24
• BASIC menu	24
• OPERATION menu	25
• INTERFACE menu	26
• MEMORY MODE menu	27
• TAPE PROTECT menu	27
• TIME CODE menu	28
• VIDEO menu	29
• AUDIO menu	30

Table of Contents

RS-232C Interface	30
1. Hardware specifications	31
1) Interface specifications	31
2) Communication parameters	31
2. Software specifications	32
1) External interface specifications	32
2) Sending format (from personal computer to VTR)	32
3) Receiving format (from VTR to personal computer)	32
4) Command list	34
Error Messages	36
Video Head Cleaning	37
Condensation	37
Maintenance	37
Specifications	38

Introduction

The model AJ-D230H is a digital VTR which uses 1/4-inch wide tapes.

It features digital compression technology which significantly reduces the deterioration in the picture and sound quality during dubbing compared with conventional analog systems.

With its compact and lightweight design, the unit can be carried around with the greatest of ease, and it is also easy to install it in a rack.

An interactive format is used to perform the unit's settings while monitoring the menus on the screen of the TV monitor.

The model AJ-D230H is provided with an RS-232C connector as a standard feature to enable the unit to be operated by remote control from a computer.

Features

Compact size and light weight

The unit measures 8-7/16" wide, 5-1/4" high and 15-7/16" deep, and it weighs only 15.4 lbs.

Grips are incorporated to make the unit easy to carry.

2-channel digital audio with high sound quality

Computer control

The unit can be operated by remote control from a computer by connecting the RS-232C cable between the unit and the computer.

Up to 126 minutes of recording

Either news-gathering cassette tapes (max. 66 minutes) or general-purpose cassette tapes (max. 126 minutes) can be used. In both cases, the tape is one-fourth of an inch wide to achieve a compact design.

Compatibility with consumer-use equipment

Consumer-use cassette tapes which have been shot using a consumer-use digital camera can be played back on this unit using the cassette adaptor (AJ-CS750P: option).

Please note that the LP mode is not supported.

Time code

This unit incorporates a time code generator (TCG)/time code reader (TCR).

Repeat playback

Repeat playback can be performed continuously or only once for any section of the tape.

Menu-driven set-up

An interactive system is used to perform the unit's settings while monitoring the menus appearing on the screen of the TV monitor.

Remote control

Connection of the AG-A11 remote controller (option) enables the unit to be operated at a distance of about 5 meters.

Digital interface

By installing the digital interface board (option) and connecting the unit using the DVCPRO terminal (complying with the IEEE1394 standard), it is possible to dub tapes with hardly any resulting deterioration in the picture and sound quality at all.

Controls and Their Functions

Front Panel

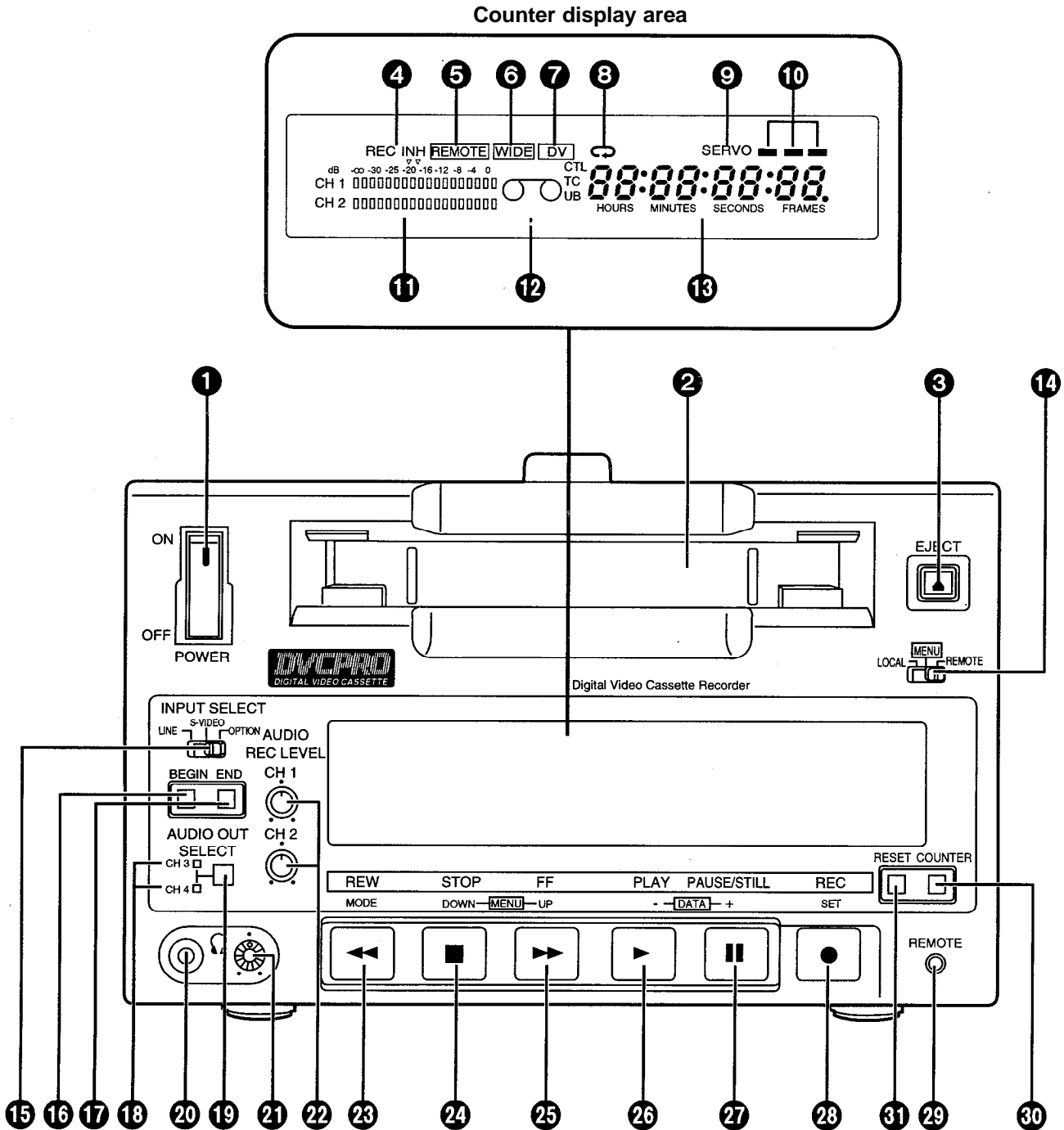

Controls and Their Functions

Front panel

❶ POWER switch

When the ON side is pressed, the power is turned on, and the counter display area lights.

❷ Cassette slot

A news gathering cassette, general-purpose cassette or consumer-use cassette with an adaptor is loaded through this slot. Consumer-use cassettes can be played back only.

❸ EJECT button

When this is pressed, the tape is unloaded, and several seconds later the cassette is automatically ejected.

When the counter display area shows the CTL display, the display is now reset.

❹ REC/REC INH lamp

REC: This lights during recording.

REC INH: This lights when the cassette has been set to the accidental erasure prevention status.

It also lights when REC INHIBIT has been set to ON on the setup menu.

In this status, recording is not possible.

❺ REMOTE lamp

This lights when the LOCAL/MENU/REMOTE switch has been set to the REMOTE position.

❻ WIDE lamp

This lights in the 16:9 wide screen mode.

❼ “Consumer-use cassette loaded” display lamp

This lights when a cassette recorded on a consumer-use DV unit has been loaded.

❽ REPEAT lamp

This lights during repeat playback.

❾ SERVO lamp

This lights when the drum servo and capstan servo are locked.

❿ Channel condition lamps

One of these lamps lights (green → blue → red) in accordance with the status of the error rates.

Green: This lights when the error rates for the video and audio playback signals are both satisfactory.

Blue: This lights when the error rate for either the video or audio playback signals has deteriorated. The playback picture is still normal even while this lamp is lighted.

Red: This lights when either the video or audio playback signals are corrected or interpolated.

⓫ Level meter

This displays the audio signal levels.

The input audio signal levels are displayed during recording and E-E selection; the output audio signal levels are displayed during playback.

⓬ “Cassette loaded” display lamp

This lights when a cassette has been loaded into the unit.

⓭ Counter display area

The TC and CTL counts, on-screen information and messages appear in this area.

⓮ LOCAL/MENU/REMOTE switch

This is operated when menu settings are to be performed or when the unit is to be controlled from a remote location.

LOCAL: For controlling the unit using the controls on the unit's operation panel.

MENU: For setting the on-screen menu.

REMOTE: For controlling the unit with an RS-232C or other external control unit.

⓯ INPUT SELECT switch

This is used to select the input signals.

LINE: For recording signals which have been supplied to the video signal input connector.

S-VIDEO: For recording signals which have been supplied to the S-VIDEO input connector.

OPTION: For supplying video and audio signals from an optional board and recording them.

⓰ BEGIN button

This sets the repeat playback start point, and it displays the currently entered start point.

⓱ END button

This sets the repeat playback end point, and it displays the currently entered end point.

⓲ CH3/CH4 lamp

This lights during DV format playback when the audio signals have been set in CH3 and CH4.

⓳ AUDIO OUT SELECT button

This selects the audio signals which are to be output.

Controls and Their Functions

20 Headphone jack

When stereo headphones are connected here, the recording or playback sound can be monitored through the headphones.

21 Volume control

This is for adjusting the headphones volume.

22 Volume recording level control

This is for adjusting the PCM audio signal CH1/CH2 recording level.

23 REW button

When this is pressed, the tape is rewound, and when "TAPE" is set for the "S/F/R EE SEL" set-up menu item, the playback picture can be monitored.

24 STOP button

When this is pressed, the tape stops traveling, and when "TAPE" is set for the "S/F/R EE SEL" set-up menu item, the still picture can be monitored. Even in the stop mode, the drum continues to rotate with the tape kept in close contact with the drum. After the unit has been kept in the stop mode for a specific period of time, it is automatically set to the standby off mode in order to protect the tape. It is set to the stop mode immediately after a cassette has been loaded into the unit.

25 FF button

When this is pressed, the tape is fast forwarded, and when "TAPE" is set for the "S/F/R EE SEL" set-up menu item, the playback picture can be monitored.

26 PLAY button

When this is pressed, playback commences. When it is pressed together with the REC button, recording commences.

27 PAUSE/STILL button

When this is pressed during recording, the tape travel is temporarily stopped (pause mode). When it is pressed again, recording is resumed. When this is pressed during playback, the still picture mode is established. When it is pressed again, playback is resumed.

28 REC button

When this is pressed together with the PLAY button, recording commences.

29 Remote control connector

When the remote controller (AG-A11) is connected to this connector, the unit can be operated from a distance by this controller instead of by its function buttons. In this case, the LOCAL/MENU/REMOTE switch must be set to the REMOTE position.

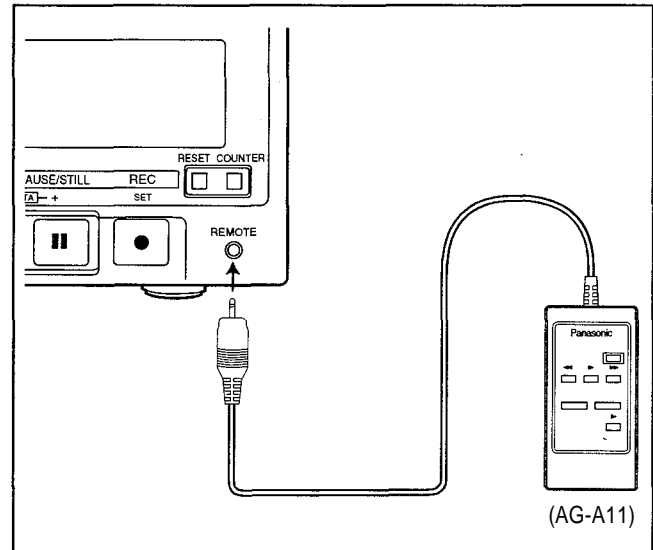

30 COUNTER button

This switches the display on the counter display area.

CTL: The tape timer (control signal) is displayed.

TC: The time code is displayed.

UB: The user's bit is displayed.

Remaining tape:

The amount of tape remaining is displayed.

31 RESET button

When this is pressed in the CTL mode, the counter display is reset to 00:00:00:00.

Controls and Their Functions

Connector section

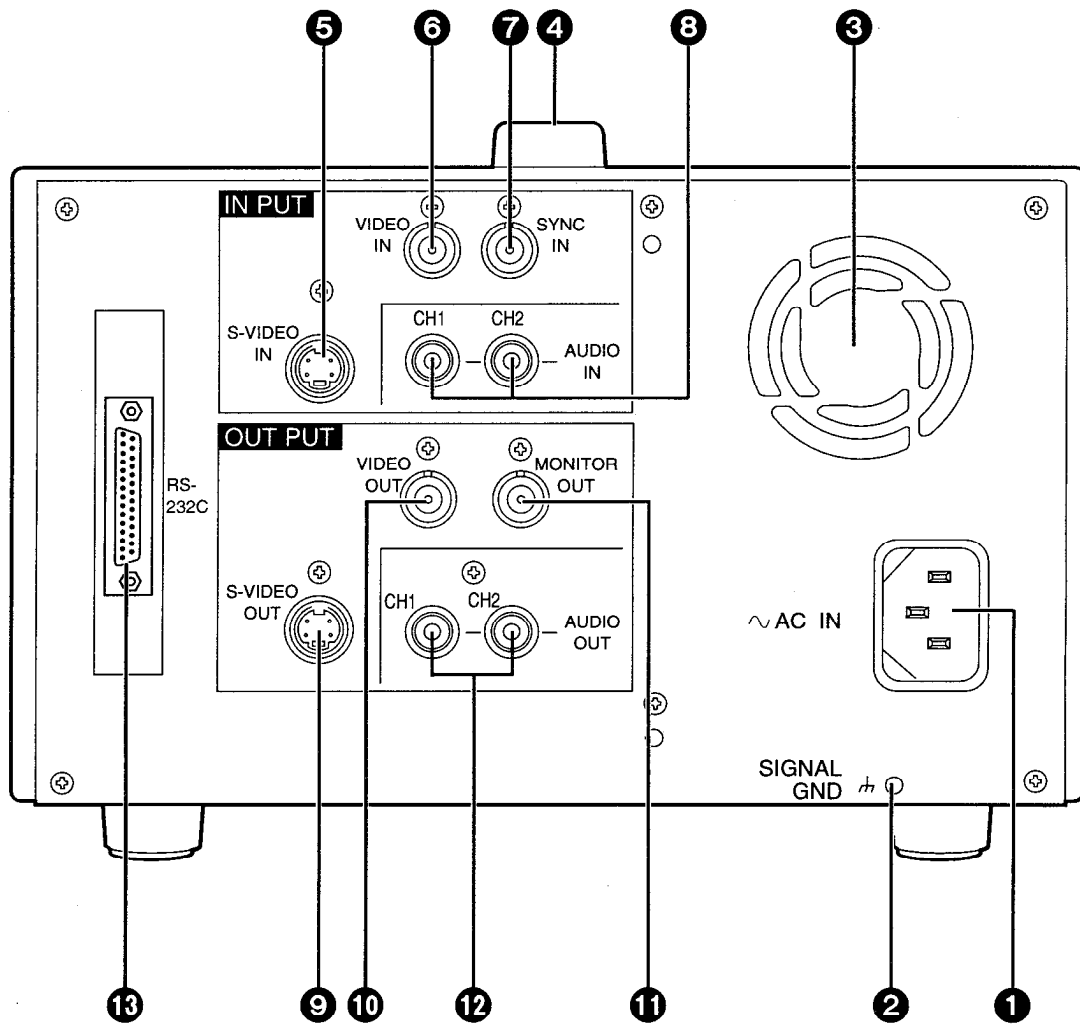

Controls and Their Functions

Connector section

1 AC IN connector

Use the power cord supplied to connect this connector to the power outlet.

2 SIGNAL GND terminal

This is connected to the signal ground terminal on the unit connected in order to reduce the noise. It is not a safety ground.

3 Fan motor

This is for cooling the unit.

4 Handle

5 S-VIDEO IN connector

This is the input connector for the S-VIDEO video signals.

6 VIDEO IN connector

This is the input connector for the analog video signals.

7 SYNC IN connector

This is connected to the composite sync signals of a reference sync signal generator if synchronization with an external reference sync signal is to be obtained during playback.

8 AUDIO IN connector

This is the input connector for the analog audio signals.

9 S-VIDEO OUT connector

This is the output connector for the S-VIDEO video signals.

10 VIDEO OUT connector

This is the output connector for the analog video signals.

11 MONITOR OUT connector

This is the output connector for the video monitor signals.
Superimposed video signals can be output from it.

12 AUDIO OUT connector

This is the output connector for the analog audio signals.

13 RS-232C connector

Connecting the optional RS-232C cable to this connector enables many kinds of computerized operations to be performed for the unit.

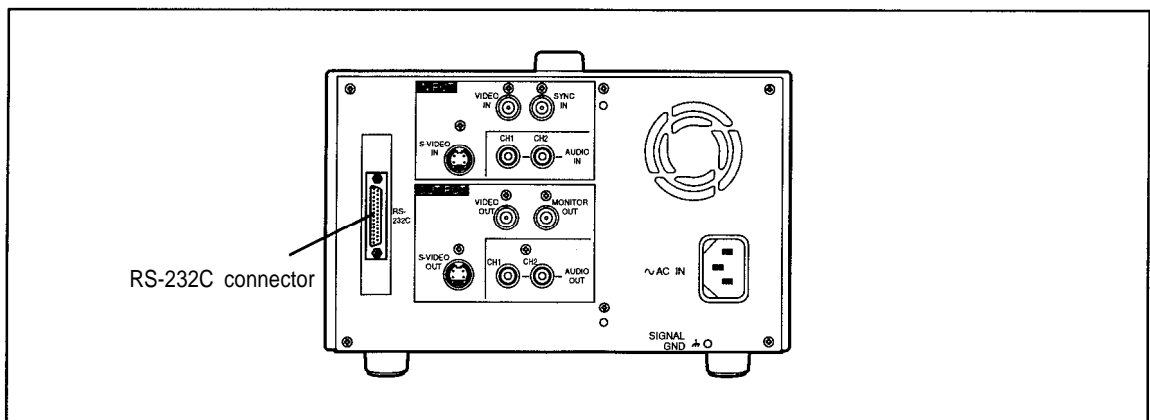

Tapes

Type	Description
Consumer-use cassette (S size cassette)	This is exclusively designed for use in consumer-use camera/recorder units. It can be used in the unit for playback only provided that the cassette adaptor (option) is obtained. Use of Panasonic consumer DV cassette tape is recommended. Note that inserting a cassette tape without using the cassette adaptor can damage the unit.
M size cassette	Recording/playback tape with a maximum length of 66 minutes (AJ-P12MP, AJ-P24MP, AJ-P33MP, AJ-P46MP, AJ-P66MP)
L size cassette	Recording/playback tape with a maximum length of 126 minutes (AJ-P34LP, AJ-P66LP, AJ-P94LP, AJ-P126LP)

Align the cassette tape with the center of the loading slot, and push it in gently. It will then be loaded automatically.

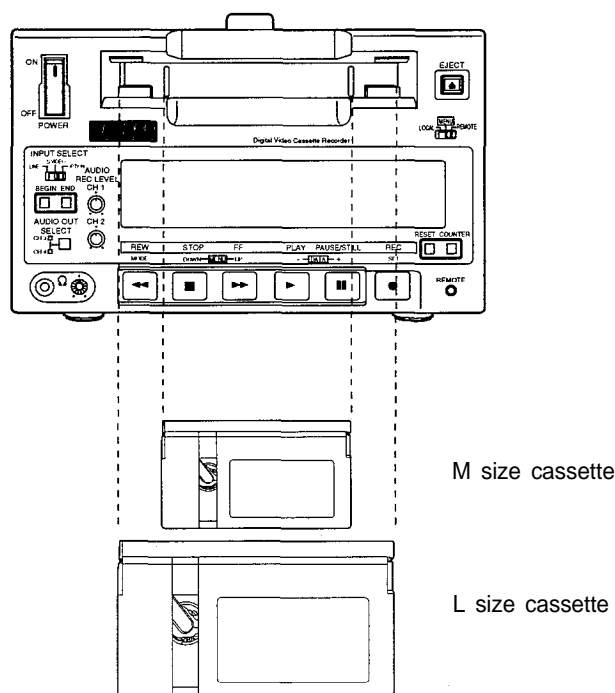

<Precautions for playing back consumer-use DV tapes>

- A consumer-use tape can be used for playback only.
- A consumer-use tape recorded in LP mode cannot be played back.
- Since a consumer-use tape cannot be used for recording, the unit's functions related to recording are prohibited.
- The maximum traveling speed of a consumer-use tape is 32x normal tape speed.
- The still-picture images on a consumer-use tape may be disturbed.
- From the perspective of protecting the tape, refrain from cue-up operation using a consumer-tape wherever possible.
- When a consumer-use tape is employed, the maximum duration of the still timer is set to 10 seconds, and the total time during which the unit is allowed to be left standing in the still mode is set to 1 minute.
- The time code read disabled display may appear when a search is performed on a consumer-use tape or the still-picture image of such a tape is displayed.

Operation

Switching on the power and inserting the cassette

Before attempting to operate the unit, make sure that it has been connected properly.

- 1 Switch on the power.**
- 2 Insert the cassette tape.**
Insert the cassette tape into its prescribed position without forcing it in any way.
- 3 Check that the STOP lamp has lighted.**
When the tape is inserted, the cylinder starts rotating automatically, the tape is loaded, and the unit is set to the stop mode.

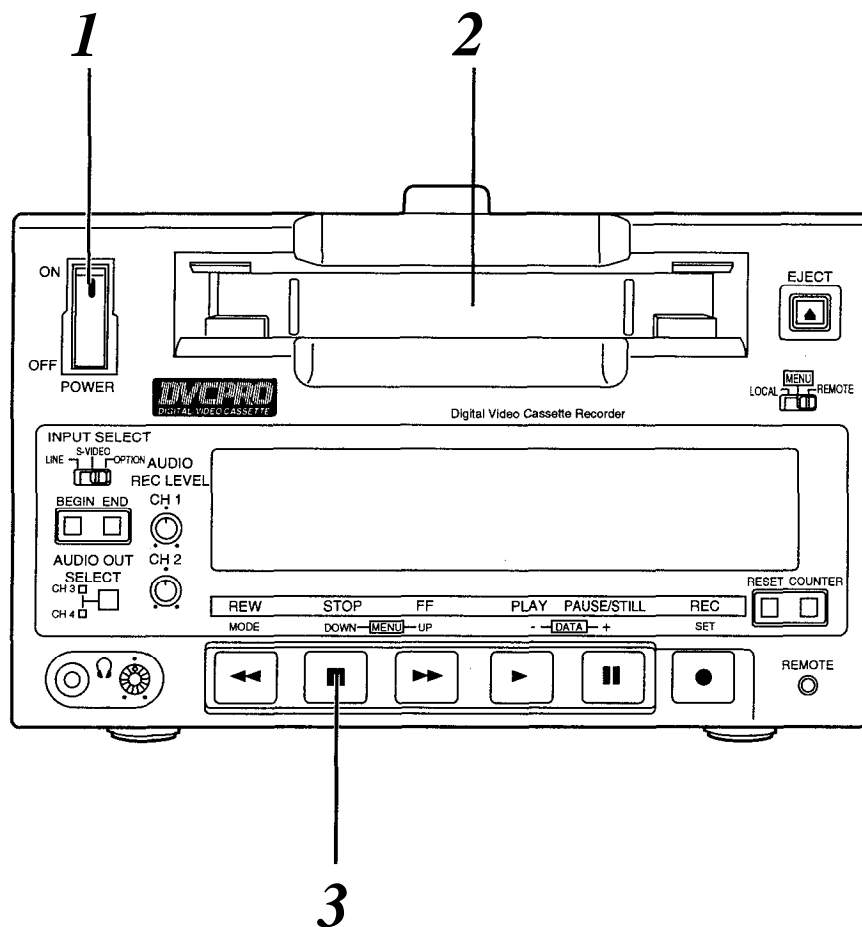

Stop mode

1 The unit is set to the stop mode when the STOP button is pressed. The STOP lamp lights and the tape stops traveling.

- In order to protect the tape, the unit is set to the tape protection mode after the period of time set in the "STILL TIMER" set-up menu item has elapsed. (See page 27) When the STOP, REW, FF or PLAY button is pressed, the unit is set to the corresponding mode.

<Precautions for setting the still timer>

- When the same part of the same tape is used repeatedly, the cumulative standby time in the same place increases. In order to protect the tape, set the standby time for the same place on the same tape to as short a duration as possible.

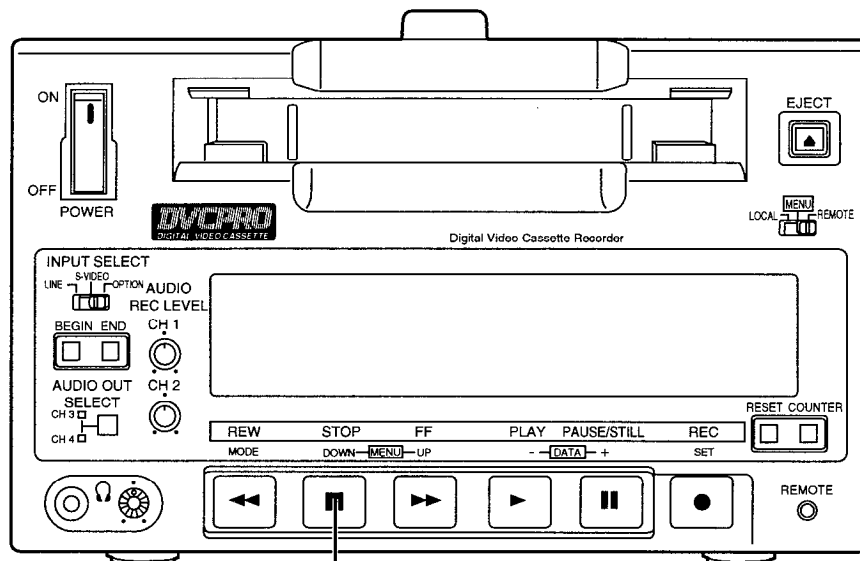

1

Recording

- 1** Set the accidental erasure prevention tab on the cassette tape to “recording,” and insert the tape.
- 2** Press the **STOP** button to set the unit to the stop mode.
- 3** Check that the **REC INH** lamp is off.
- 4** **Selecting the video and audio input signals and adjusting the audio signal level**
 - 4-1** **Selecting the video and audio input signals**
 - 1** Connect the signals which are to be recorded.
 - 2** Select the input signals using the **INPUT SELECT** switch on the front panel.
 - 4-2** **Adjusting the audio signal level**
 - 1** Adjust the audio input signal level.
The audio signals are recorded at the appropriate level when the level controls are set to the center click-stop position.
- 5** **Press the **PLAY** button while holding down the **REC** button.**
The **REC** and **PLAY** lamps light, and recording is commenced.
- 6** **To stop recording, press the **STOP** button.**
Recording is now ended, and the unit is set to the stop mode.

<Notes>

- A recording cannot be made properly on a tape on which the recording protection signal has been recorded as an input signal.
- During recording, check that the **SERVO** lamp is lighted. If the lamp is flashing or off, the images played back will be disturbed.

Pause/still recording (back-space assemble recording)

- 1 Press the PAUSE/STILL button while the cassette tape is playing.**
If the "AUTO BACK" set-up menu item has been set to ON, the tape will be rewound for 1 or 2 seconds starting at the position where the PAUSE/STILL button was pressed.
(See page 25)
- 2 Press the REC button to set the unit to the REC PAUSE mode.**
The monitor display now switches to the E-E screen.
- 3 Press the PAUSE/STILL button to start the recording.**
The tape runs to the position where the PAUSE/STILL button was pressed in step 1, and the recording is started.

<Note>
The E-E screen now appears.

Playback

- 1 Insert the cassette tape.**
- 2 Press the PLAY button.**
Normal playback is now commenced.
- 3 To stop playback, press the STOP button.**
The VTR is now set to the stop mode.

<Note>
During playback, check that the SERVO lamp is lighted. If the lamp is off or flashing, the images played back will appear disturbed.

Cue and Review

Keep pressing the FF or REW button during playback.

While the button is held down, the tape is cued or reviewed at approximately 10x normal tape speed.

Normal playback is restored when the button is released.

- The cue track sound is output during cue or review if the "SEARCH CUE" set-up menu item has been set to ON. (See page 30)

Still-picture playback

Press the PAUSE/STILL button during playback.
When it is pressed again, normal playback is restored.

- No sound is heard during still-picture playback.

Operation

Frame advance

The tape is advanced or reversed frame by frame when the FF or REW button is pressed during playback.

- No sound is heard during frame advance or reverse.

Sound selection

Use the AUDIO OUT SELECT button to select the desired sound.

By pressing the AUDIO OUT SELECT button, the mode for the audio output is selected in the sequence shown below.

Mode	AUDIO OUT connectors		Display tube	LED
	CH1 output	CH2 output		
A	CH1	CH2	CH1 CH2	CH3 <input type="checkbox"/> CH4 <input type="checkbox"/>
B	CH1		CH1	CH3 <input type="checkbox"/> CH4 <input type="checkbox"/>
C	CH2		CH2	CH3 <input type="checkbox"/> CH4 <input type="checkbox"/>
D	CH3	CH4	No display	CH3 <input checked="" type="checkbox"/> CH4 <input checked="" type="checkbox"/>
E	CH3		No display	CH3 <input checked="" type="checkbox"/> CH4 <input type="checkbox"/>
F	CH4		No display	CH3 <input type="checkbox"/> CH4 <input checked="" type="checkbox"/>
G	CH1+CH3	CH2+CH4	CH1 CH2	CH3 <input checked="" type="checkbox"/> CH4 <input checked="" type="checkbox"/>

The shading denotes that the selection is valid only during playback using the DV format in the 4-channel mode.

..... Off
 On

Sequence of mode selection

A → B → C → D → E → F → G

Repeat playback

Setting the BEGIN and END points

[Menu mode]

- 1** Set the VTR to the menu mode.
(Set the LOCAL/MENU/REMOTE switch to the MENU position.)
- 2** Select the “BEGIN/END PRESET” set-up menu item, and press the MODE (REW) button. (See page 27)
- 3** Select TC or CTL using the COUNTER button.
- 4** Select either BGN or END using either the BEGIN button or the END button.
- 5** Select the digit (flashing display) in which the change is to be made using the UP (FF) and DOWN (STOP) buttons.
The frame digit cannot be selected. “00” is displayed for the frame value at all times.
- 6** Press the DATA+ (PAUSE/STILL) button or DATA– (PLAY) button to change the value.
- 7** Upon completion of the settings, press the SET (REC) button.
The settings are now stored in the memory, and the display returns to the regular menu screen.
- 8** Set the LOCAL/MENU/REMOTE switch to the LOCAL or REMOTE position.

<Notes>

- When an item has no setting, “--:--:--:--” is displayed.
When repeat playback is initiated in this status, the start of the tape serves as the BEGIN point and the end of the tape serves as the END point.
- When the RESET button is pressed, the setting is reset to “00:00:00:00.”
- If the MODE (REW) button is pressed without pressing the SET button upon completion of the settings, the time code setting is canceled, and the display returns to the regular menu screen.
- When the BEGIN or END button is used to set the digit in which the change is to be made to BGN or END, and then the DATA+ or DATA– button is pressed, it is possible to select whether an item is to be set or left unset.

<Menu screen>

CTL	BGN	-00 : 00 : 00 : 00
	END	+ 00 : 00 : 00 : 00

Operation

Setting the BEGIN and END points [Front panel]

- 1** Set the VTR to the local mode.
(Set the LOCAL/MENU/REMOTE switch to the LOCAL position.)
- 2** Press the BEGIN or END button on the front panel to set the current position as the BEGIN or END point.

Displaying the BEGIN and END points

- 1** Set the VTR to the remote mode.
(Set the LOCAL/MENU/REMOTE switch to the REMOTE position.)
- 2** When the BEGIN or END button on the front panel is pressed, the BEGIN or END point is displayed while the button is held down.

Setting the repeat playback mode

- 1** Set the VTR to the menu mode.
(Set the LOCAL/MENU/REMOTE switch to the MENU position.)
- 2** Select the "MEMORY MODE" set-up menu item, and select the repeat playback mode. (See page 27)

Setting	Description of operation
OFF	Normal operation
MEM STOP	When the tape is fast forwarded or rewind, it stops near the BEGIN point.
REPEAT 1	When the tape is played to the END point, it is rewind to the BEGIN point where it stops.
CONTINUE	When the tape is played to the END point, it is rewind to the BEGIN point and played back, and this sequence of operation is repeated.

- 3** Set the LOCAL/MENU/REMOTE switch to the LOCAL or REMOTE position.

<Note>

- When the repeat play function is used over and over again for the same tape, the tape's images will deteriorate. Replace the tape with a new one after about a hundred repeat plays.
- Bear in mind that no operation will result when repeat play is to be performed using a consumer-use tape even if "CONTINUE" has been selected for set-up menu item No.300 (MEMORY MODE). (See page 27)

Time Code and User's Bit

Time code

The time code signal generated by the time code generator is recorded on the tape as a time code, it is read out by the time code (signal) reader, and used to display the absolute position of the tape in increments of hours, minutes, seconds and frames.

The time code is written in the sub-code area (data area) of the helical track. For this reason, it can be read out across a wide range of VTR playback speeds from the stop mode to slow playback and to high-speed playback.

The time code is indicated by the display or by the figures superimposed onto the screen.

TCR 00 : 07 : 04 : 24
↑ ↑ ↑ ↑
Hours Minutes Seconds Frames

User's bit

The user's bit is a 32-bit (8-digit) information frame contained in the time code signals which is made available to the user. It enables the operator number and other information to be recorded.

The figures 0 to 9 and the letters ABCDEF can be used for this bit.

Time Code and User's Bit

Setting the time code

- 1** Set the VTR to the menu mode.
(Set the LOCAL/MENU/REMOTE switch to the MENU position.)
- 2** Select the "TC PRESET" set-up menu item, and press the MODE (REW) button.
(See page 28)
- 3** Select the digit (flashing display) in which the change is to be made using the UP (FF) and DOWN (STOP) buttons.
- 4** Press the DATA+ (PAUSE/STILL) button or DATA- (PLAY) button to change the value.
- 5** Upon completion of the settings, press the SET (REC) button.
(The display returns to the regular menu screen.)
- 6** Press the SET (REC) button again.
(The settings are now stored in the memory, and the menu mode closes.)
- 7** Set the LOCAL/MENU/REMOTE switch to the LOCAL or REMOTE position.

<Notes>

- The current time code value is displayed as the default setting.
- When the RESET button is pressed, the setting is reset to "00:00:00:00."
- The time code cannot be set unless the "TC MODE" set-up menu item has been set to "P-REC" or "P-FREE." (See page 28)
- If the MODE (REW) button is pressed without pressing the SET button upon completion of the setting, the time code setting is canceled, and the display returns to the regular menu screen.

Setting the user's bit

- 1** Set the VTR to the menu mode.
(Set the LOCAL/MENU/REMOTE switch to the MENU position.)
- 2** Select the "UB PRESET" set-up menu item, and press the MODE (REW) button.
(See page 28)

The remaining steps in the setting procedure are the same as for the time code.

Time Code and User's Bit

Time code and user's bit playback

1 Set the VTR to the STOP mode.

2 Set to TC or UB using the COUNTER button.

TC : The time code is displayed.

UB : The user's bit is displayed.

- When the time code can no longer be read, interpolation is provided by the control signal if the COUNTER button is set to the CTL position.

3 Press the PLAY button.

Playback is commenced, and the time code appears on the display. When the "DISPLAY SEL" set-up menu item is set to "TIME" or "T, STA," the time code value is superimposed onto the video signals which are output from the MONITOR OUT connector.

(See page 24)

<Notes>

- The colon between the seconds and frames changes to a period while the drop frame time code is being read.
- If the time code signal is missing, interpolation is automatically provided by the CTL signal.

The display changes as shown below.

T * R 00:07:04:24



The colon (":") between the seconds and frames changes to a period (".") in the drop frame mode.

"*" appears when the time code signal is missing (superimposed display only).

Superimposed Display Screens

When the MONITOR OUT connector has been connected to the TV monitor, the abbreviations corresponding to the control signal, time code, etc. are displayed on the TV monitor.

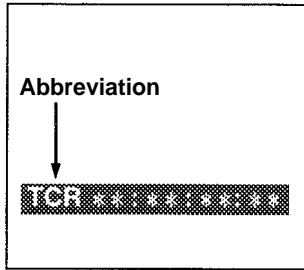

TV monitor

CTL (control signal)
TCR (time code playback value)
UBR (user's bit playback value)
REMAIN (remaining tape length)

Characters displayed

The background of the characters superimposed onto the display can be changed using the "CHARA TYPE" set-up menu item. (See page 24)

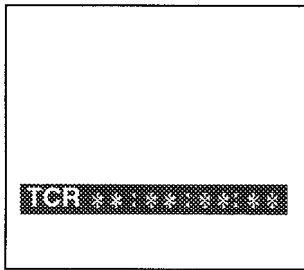

TV monitor

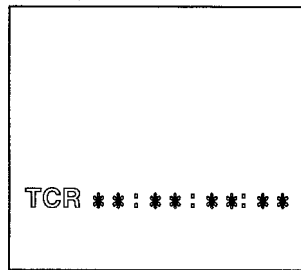

TV monitor

Display position

The position where the characters are superimposed onto the display can be changed using the "CHARA H-POS" and "CHARA V-POS" set-up menu items. (See page 24)

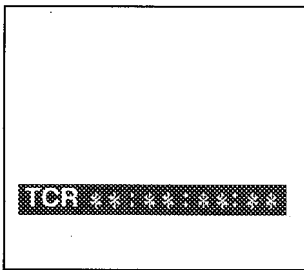

TV monitor

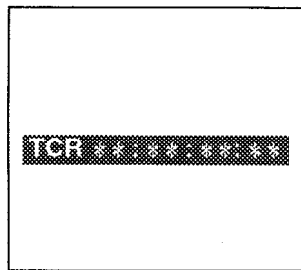

TV monitor

<Note>

The counter display is made to appear for as long as the MODE button is held down, enabling the settings to be checked. Even while the MODE button is held down, the DATA+ and DATA- buttons can be used to perform settings while the actual situation is checked.

Operating mode

When "T, STA" has been selected for the "DISPLAY SEL" set-up menu item, the VTR's operating mode is also displayed. (See page 24)

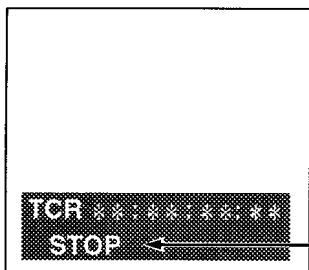

TV monitor

VTR operation mode

Set-up (Default Settings)

The VTR's major settings are performed by making selections using a menu system. The set-up menus appear on the TV monitor when it is connected to the MONITOR OUT connector.

Changing a setting

- 1 Set the VTR to the menu mode.**
(Set the LOCAL/MENU/REMOTE switch to the MENU position.)
- 2 Select the item to be set using the UP (FF) and DOWN (STOP) buttons. The cursor on the menu screen moves and selects the item.**
The cursor (*) is moved to the previous set-up menu item number using the DOWN button and the next set-up menu item number using the UP button.
- 3 Press the DATA+ (PAUSE/STILL) button or DATA- (PLAY) button to change the setting.**
- 4 Upon completion of the setting, press the SET (REC) button.**
The change is now stored in the memory.

To return from the new setting to the original setting, set the LOCAL/MENU/REMOTE switch to the LOCAL or REMOTE position instead of pressing the SET (REC) button.

- 5 Set the LOCAL/MENU/REMOTE switch to the LOCAL or REMOTE position.**

<Note>

To return the setup selections to the factory (default) settings, press the RESET button while the SETUP. menu is shown. The following message is then displayed.

**SETUP-MENU INIT. SET
OK? (PUSH REC KEY)**

- The default settings will be restored when the REC button is pressed.

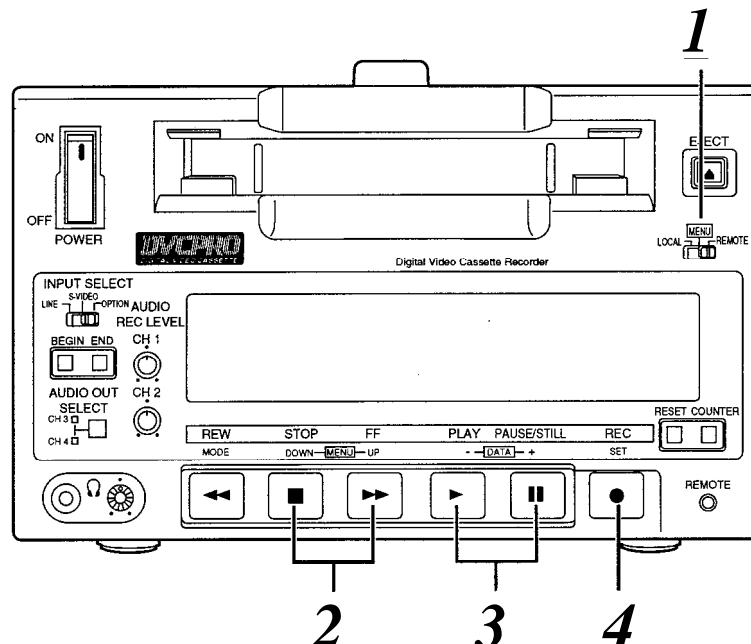

Set-up Menus

BASIC menu

Item		Setting		Description of settings
No.	Superimposed display	No.	Superimposed display	
000	DISPLAY SEL	<u>0000</u> 0001 0002	<u>OFF</u> TIME T, STA	This sets what is to be displayed for the superimpose signals output from the MONITOR OUT connector. 0: No display 1: Only the time is displayed. 2: The time and operation mode are displayed.
001	CHARA H-POS	0000 0001 : <u>0003</u> : 0007	0 1 : 3 : 7	This sets the horizontal position of the superimposed characters (8 settings to choose from).
002	CHARA V-POS	0000 0001 : 0003 : <u>0007</u>	0 1 : 3 : 7	This sets the vertical position of the superimposed characters (8 settings to choose from).
003	CHARA TYPE	<u>0000</u> 0001	<u>WHITE</u> W/OUT	This selects the type of characters for the superimposed display and menu display. 0: White characters appear on a black back ground. 1: White characters with black borders appear.
005	MENU INHIBIT	<u>0000</u> 0001	<u>OFF</u> ON	This selects whether or not the menu settings are to be fixed. 0: The settings are not fixed. 1: The settings are fixed (and cannot be changed).

The underlined number and item are the factory settings.

<Notes>

- While setting "CHARA H-POS", "CHARA V-POS", and "CHARA TYPE", the counter display can be viewed by holding down the MODE button, allowing you to check the settings. You can also use the DATA+ and DATA- buttons while holding down the MODE button to adjust the values while you are viewing them.
- To set ON or OFF for the "MENU INHIBIT" item, first press the DATA+ or DATA- button while holding down the MODE button, and then select the setting. Continuously after performing the settings, press the SET button (REC button) to exit the menu. The MENU INHIBIT setting takes effect starting with the next menu mode.

Set-up Menus

OPERATION menu

Item		Setting		Description of settings
No.	Superimposed display	No.	Superimposed display	
100	LOCAL ENABLE	<u>0000</u> <u>0001</u>	DISABLE <u>ST EJ</u>	This selects the switches on the front panel which can be operated in the remote control mode. 0: None of the switches can be operated. 1: Only the STOP and EJECT switches can be operated.
101	TAPE TIMER	<u>0000</u> 0001	<u>12H</u> 24H	This selects the CTL counter display. 0: ±12-hour display 1: 24-hour display
102	S/F/R EE SEL	<u>0000</u> 0001	<u>EE</u> TAPE	This selects the EE/VV output during stop, fast forwarding or rewinding. 0: EE is output. 1: VV is output.
103	WIDE MODE	<u>0000</u> 0001 0002	AUTO WIDE NORMAL	This selects the WIDE mode. 0: Automatic detection. 1: The screen mode is forcibly treated as WIDE. 2: The screen mode is forcibly treated as NORMAL.
104	TAPE IN MODE	<u>0000</u> 0001 0002 0003	<u>STOP</u> REW PAUSE PLAY	This selects the operation which follows when the cassette is inserted. 0: STOP 1: Rewind 2: Play pause 3: Play
105	TAPE END MODE	<u>0000</u> 0001 0002 0003	<u>STOP</u> REW REW→EJ EJECT	This selects the operation which follows when the tape has reached the end. 0: Stop 1: Rewind 2: This rewinds the tape and ejects it upon completion of rewinding. 3: Eject
106	SERVO REF	<u>0000</u> 0001	<u>AUTO</u> EXT	This selects the sync signals of the servo. 0: Synchronization with the input signals; if no input signals are present, synchronization with the internal signals. 1: During playback, synchronization with the SYNC IN signals; if these signals are not present, synchronization with the internal signals.
<p>(AUTO) VIDEO IN connector:</p> <ul style="list-style-type: none"> • Synchronized playback is performed using standard video signals. • With non-standard video signals, the switching is performed in such a way that playback is synchronized with the internal signals. <p>(EXT) SYNC IN connector:</p> <ul style="list-style-type: none"> • Use standard signals as the SYNC signals. Non-standard signals cannot be used. Use of the BB (black burst) signal is recommended. • When an out-of-sync state occurs due to SYNC signal switching or interruption Set to the STOP EE mode or eject the cassette and then re-load it. This makes it possible for the synchronization to be reset. 				
107	AUTO BACK	<u>0000</u> <u>0001</u>	OFF <u>ON</u>	This selects whether to automatically reverse (auto back) the tape to achieve back-space assemble recording. 0: No auto back 1: Auto back

The underlined number and item are the factory settings.

Set-up Menus

OPERATION menu

Item		Setting		Description of settings																			
No.	Superimposed display	No.	Superimposed display																				
108	FORMAT SEL	<u>0000</u> 0001 0002	<u>DVCPRO</u> DV DVCAM	This selects the format when an L cassette is used. 0: DVCPRO mode 1: DV mode 2: DVCAM mode																			
<p><Note> The cassette tape is played back in one of the modes listed below depending on the tape type and settings used.</p> <table border="1" style="margin-left: auto; margin-right: auto;"> <thead> <tr> <th rowspan="2">Type</th> <th colspan="3">FORMAT SEL setting</th> </tr> <tr> <th>DVCPRO</th> <th>DV</th> <th>DVCAM</th> </tr> </thead> <tbody> <tr> <td>S size cassette</td> <td>DV</td> <td>DV</td> <td>DVCAM</td> </tr> <tr> <td>M size cassette</td> <td>DVCPRO</td> <td>DVCPRO</td> <td>DVCPRO</td> </tr> <tr> <td>L size cassette</td> <td>DVCPRO</td> <td>DV</td> <td>DVCAM</td> </tr> </tbody> </table> <p>Use tapes specially designed for DVCPRO applications with this unit. However, if DV tapes or DVCAM tapes are to be used in the playback mode, it is recommended that playback be limited to as short a period of time as possible.</p>					Type	FORMAT SEL setting			DVCPRO	DV	DVCAM	S size cassette	DV	DV	DVCAM	M size cassette	DVCPRO	DVCPRO	DVCPRO	L size cassette	DVCPRO	DV	DVCAM
Type	FORMAT SEL setting																						
	DVCPRO	DV	DVCAM																				
S size cassette	DV	DV	DVCAM																				
M size cassette	DVCPRO	DVCPRO	DVCPRO																				
L size cassette	DVCPRO	DV	DVCAM																				
109	REC INHIBIT	<u>0000</u> 0001	<u>OFF</u> ON	This selects whether to inhibit recording on the VTR. 0: Recording is not inhibited. 1: Recording is inhibited.																			

The underlined number and item are the factory settings.

INTERFACE menu

Item		Setting		Description of settings
No.	Superimposed display	No.	Superimposed display	
200	BAUD RATE	0000 0001 0002 <u>0003</u> 0004	1200 2400 4800 <u>9600</u> 19200	This sets the RS-232C transfer rate (baud rate).
201	DATA LENGTH	<u>0000</u> 0001	<u>8BIT</u> 7BIT	This sets the RS-232C data length.
202	STOP BIT	<u>0000</u> 0001	<u>1BIT</u> 2BIT	This sets the RS-232C stop bit length.
203	PARITY	<u>0000</u> 0001 0002	<u>NONE</u> ODD EVEN	This sets whether the RS-232C parity bit is to be used and, if so, whether with even or odd parity. 0: The parity bit is not used. 1: The parity bit is used with odd parity. 2: The parity bit is used with even parity.
204	ACK RETURN	0000 <u>0001</u>	OFF <u>ON</u>	This sets the RS-232C return data. 0: The ACK code is not returned. 1: The ACK code is returned.

The underlined number and item are the factory settings.

<Note>

After the settings of items No.200 through No.203 have been changed, the new settings will not take effect until the power is switched on. This means that the power must be turned off and back on again after these settings are changed.

Set-up Menus

MEMORY MODE menu

Item		Setting		Description of settings
No.	Superimposed display	No.	Superimposed display	
300	MEMORY MODE	<u>0000</u> 0001 0002 0003	<u>OFF</u> MEM STOP REPEAT 1 CONTINUE	This sets the memory operation. 0: No memory operation. 1: The tape stops near the BEGIN point when it is fast forwarded or rewind. 2: When the tape reaches the end, it is rewind to the BEGIN point where it stops. 3: When the tape reaches the end, it is rewind to the BEGIN point where it is played, and this process is repeated.
301	BGN/END PRESET			This sets the BEGIN point and END point.

The underlined number and item are the factory settings.

TAPE PROTECT menu

Item		Setting		Description of settings
No.	Superimposed display	No.	Superimposed display	
400	STILL TIMER	0000 0001 0002 0003 0004 <u>0005</u>	0.5S 5S 10S 30S 1MIN <u>2MIN</u>	This selects the time taken until the unit is set to the tape protection mode when it has been left standing in the stop, play pause or still mode. (Units: S = seconds, MIN = minutes) • The setting for the time taken until the unit is set to the tape protection mode when it has been left standing in the REC PAUSE mode is fixed at 2 minutes.
401	SRC PROTECT	<u>0000</u> 0001	<u>STEP</u> HALF	This sets the tape protection operation which is performed when the unit has been left standing in the pause mode. 0: Step (step FWD in the still or pause mode; step REV in the REC pause mode) 1: Half loading (standby OFF)
402	DRUM STDBY	000 <u>0001</u>	OFF <u>ON</u>	This sets whether or not the drum is to be stopped in the STANDBY OFF mode. 0: The drum rotates at all times. 1: The drum is stopped in the STANDBY OFF mode.
403	STOP PROTECT	0000 <u>0001</u>	STEP <u>HALF</u>	This sets the tape protection operation to be performed when the unit is left standing in the STOP mode. 0: Step 1: Half loading

The underlined number and item are the factory settings.

<Note>

When using a consumer DV cassette tape, tape protection mode is set after 10 seconds, even if STILL TIMER is set to "30S", "1MIN" or "2MIN".

Set-up Menus

TIME CODE menu

Item		Setting		Description of settings
No.	Superimposed display	No.	Superimposed display	
500	VITC POS-1	0000 0001 : <u>0006</u> : 0010	10L 11L : <u>16L</u> : 20L	This sets the position where the VITC signal is to be inserted. (The same line as that selected for VITC POS-2 cannot be selected.)
501	VITC POS-2	0000 0001 : <u>0008</u> : 0010	10L 11L : <u>18L</u> : 20L	This sets the position where the VITC signal is to be inserted. (The same line as that selected for VITC POS-1 cannot be selected.)
502	VITC BLANK	0000 <u>0001</u>	BLANK <u>THRU</u>	This sets whether the VITC signal is to be output. 0: VITC signal is not output. 1: VITC signal is output.
503	TCG REGEN	<u>0000</u> 0001 0002	<u>TC UB</u> TC UB	This selects the signal to be regenerated when the TCG is in the REGEN mode. (item No. 507) 0: Both the time code and user 1: Only the time code is regenerated. 2: Only the user's bit is regenerated.
504	BINARY GP	<u>0000</u> 0001 0002 0003 0004 0005 0006 0007	<u>000</u> 001 010 011 100 101 110 111	This sets the status for using the user's bit of the time code generated by the TCG. 0: NOT SPECIFIED (character set is not used) 1: ISO CHARACTER (8bit character set complying with ISO646 and ISO2022 is used) 2: UNASSIGNED-1 (not defined) 3: UNASSIGNED-2 (not defined) 4: UNASSIGNED-3 (not defined) 5: PAGE/LINE (SMPTE262M page/line multiplexing system) 6: UNASSIGNED-4 (not defined) 7: UNASSIGNED-5 (not defined)
505	TCG CF FLAG	<u>0000</u> 0001	<u>OFF</u> ON	This selects whether the CF flag of the TCG is to be set ON. 0: CF flag is set OFF. 1: CF flag is set ON.
506	DF MODE	<u>0000</u> 0001	<u>DF</u> NDF	This selects the drop frame or non-drop frame mode for CTL and TCG. 0: CTL and TCG are used in the drop frame mode. 1: CTL and TCG are used in the non-drop frame mode.
507	TC MODE	0000 0001 <u>0002</u> 0003	P-REC P-FREE <u>I-REGEN</u> E-VITC	This sets the TCG mode. 0: Internal TC PRESET is used in the REC RUN mode. 1: Internal TC PRESET is used in the FREE RUN mode. 2: Internal TC is used in the REGEN mode. 3: VITC of input video signals is used in the REGEN mode.
508	TC PRESET			This sets the time code generator value.
509	UB PRESET			This sets the user

The underlined number and item are the factory settings.

Set-up Menus

VIDEO menu

Item		Setting		Description of settings
No.	Superimposed display	No.	Superimposed display	
600	VIDEO MODE	<u>0000</u> 0001	B/W <u>COLOR</u>	For setting video signal recording and playback. 0: For using monochrome signals. 1: For using color signals. ● To use monochrome signals for recording and playback, set this item to the B/W mode. To use normal color signals, set it to the COLOR mode. ● If color signals are recorded in the B/W mode, the playback images will appear with abnormal colors.
601	V-MUTE SEL	<u>0000</u> 0001	<u>N-MUTE</u> LOW-RF	This selects whether the video signals are to be muted during playback under low RF conditions or when the servo lock is disengaged. 0: Video signals are not muted. 1: Video signals are muted.
602	CC (F1) BLANK	<u>0000</u> 0001	<u>BLANK</u> THRU	This selects ON or OFF for the closed capture signal in the first field. 0: Signal is forcibly blanked. 1: Signal is not blanked.
603	CC (F2) BLANK	<u>0000</u> 0001	<u>BLANK</u> THRU	This selects ON or OFF for the closed capture signal in the second field. 0: Signal is forcibly blanked. 1: Signal is not blanked.
604	STD/NSTD SEL	<u>0000</u> 0001	<u>AUTO</u> NSTD	This selects the video signal processing. 0: Mode is set automatically according to the input. 1: Mode is forcibly set to nonstandard mode.
605	FREEZE SEL	<u>0000</u> 0001	<u>FIELD</u> <u>FRAME</u>	This selects which type of freeze mode is to be established for the still picture during PLAY PAUSE or frame advance. 0: Field freeze 1: Frame freeze

The underlined number and item are the factory settings.

Set-up Menus

AUDIO menu

Item		Setting		Description of settings
No.	Superimposed display	No.	Superimposed display	
700	SEARCH CUE	<u>0000</u> 0001	OFF <u>ON</u>	This selects whether the cue audio signals are to be output during search or during fast forwarding/rewinding (VV). 0: Signals are not output. 1: Signals are output.
701	DV PBATT	<u>0000</u> 0001	OFF <u>ON</u>	This selects the audio output level during DV format playback. 0: Normal playback level 1: Output level is controlled only during DV format playback.
702	PB MUTE	<u>0000</u> 0001	OFF <u>ON</u>	This selects whether the sound is to be muted during playback at the back-space assemble recording points. 0: Sound is not muted. 1: Sound is muted. However, it may not be possible to mute the sound at the edit OUT point.
703	AUDIO REC IN	<u>0000</u> 0001	CUT <u>FADE</u>	This selects the audio processing information at the back-space assemble recording points recorded on the tape. 0: Cut processing is selected 1: Fade processing is selected

The underlined number and item are the factory settings.

RS-232C Interface

The following functions can be controlled by using the RS-232C interface.

1. Basic operations

Eject
stop
play
rec/play
fast forward
rewind
pause

2. Status checks

The current VTR mode can be checked.

RS-232C Interface

1. Hardware specifications

1) Interface specifications

Connector: D-SUB, 25P, DCE specifications (straight cable supported)

Pin No.	Signal	Description
1	FG	Protective ground
2	SD (TXD)	Transmitted data
3	RD (RXD)	Received data
4	RS (RTS)	Request to send
5	CD (CTS)	Clear to send
6	DR (DSR)	Data set ready
7	SG	Signal ground
20	ER (DTR)	Data terminal ready

Example of wiring connections

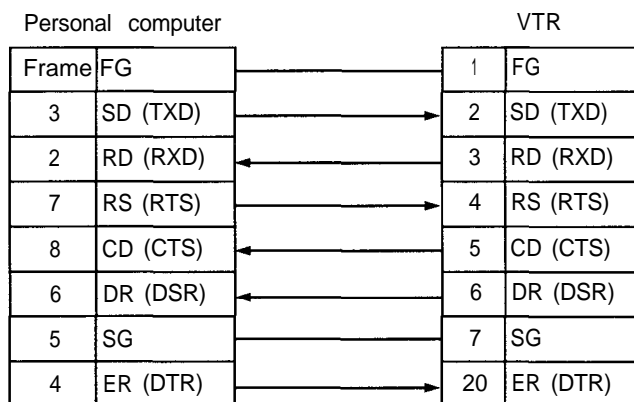

2) Communication parameters

The VTR's communication parameters are shown below. To change any of these parameters, make the changes using the menu.

Baud rate : 9600 bps

Bit length : 8 bits

Stop bit : 1 bit

Parity : None

RS-232C Interface

2. Software specifications

1) External interface specifications

Communication system	Asynchronous, full duplex
Baud rate	1200/2400/4800/9600/19200
Bit length	8 bit/7 bit
Stop bit	1 bit/2 bit
Parity	NONE/ODD/EVEN

The factory settings are 9600 bps, 8 bits, 1 stop bit, and none for the parity.

2) Sending format (from personal computer to VTR)

■ Data format

[STX] [discrimination] [:] [data] [ETX]
02H XX XX XX 3AH XX...XX 03H

20H<XX<7FH (XX = hexadecimal character code)

- discrimination : This is the command identifier (3 bytes).
- : : This code serves as the delimiter between a command and data.
- data : Data codes are added when necessary.

1. A send command must always start with STX (character code 02H).
The 'discrimination' which follows next is the command identifier. If necessary, data is added after the colon (" : ").
At the very end comes ETX (character code 03H).
2. When STX is re-sent before ETX is sent, the receive buffer inside the VTR is cleared (all data received up to that moment will be lost), and the data is processed again with the re-received STX placed at the head.

3) Receiving format (from VTR to personal computer)

The VTR responds to a send command with data in the following format.

1. First, the VTR returns the data which acknowledges whether the command from the computer was received properly.

- 1) The VTR returns the ACK data if communication was error-free.

[ACK]
06H

- 2) It returns data starting with NAK (negative acknowledge; character code 15H) if an error occurred in communication.

[NAK]
15H

RS-232C Interface

2. Next, after [ACK] is returned because communication was error-free, data is returned in the following format by the operation of the VTR.

1) The response data (return data) format when the command from the personal computer was received properly by the VTR is as follows.

[STX] [data] [ETX]
02H XX·XX 03H

Example: Send command Return data = Receive data
 [STX] QOP [ETX] → [ACK] [STX] OEJ [ETX]
 [STX] QCD [ETX] → [ACK] [STX] CD □□□□□□□□□□ [ETX]

2) If the data is incorrect or the trouble has occurred in the VTR, details indicating the reason why the data could not be received are returned using the following format.

[STX] E R 0 0 □ [ETX]
02H 45H 52H 30H 30H XX 03H

- Meaning of □
 - 1 (31H): Unknown command, or command execution error
 - 2 (32H): Bad data code parameter error
 - 3 (33H): Receiving buffer overflow error

[STX] E R 1 0 □ [ETX]
02H 45H 52H 31H 30H XX 03H

- Meaning of □
 - 2 (32H): Front loading error
 - 3 (33H): Loading error
 - 4 (34H): Drum/capstan system error
 - 5 (35H): Reel system error
 - 6 (36H): Tension system error
 - 7 (37H): Fan motor error
 - 8 (38H): Dew error

[STX] E R 1 F F [ETX]
02H 45H 52H 31H 46H 46H 03H
System (servo communications) error

RS-232C Interface

4) Command list

■ Key commands

Send command	Description of operation	Data transmitted by personal computer	Data received in response from VTR
OSP (STOP)	All the VTR's operations are stopped, and the VTR is set to the stop mode.	[STX] OSP [ETX]	[STX] OSP [ETX]
OEJ (EJECT)	Cassette is ejected.	[STX] OEJ [ETX]	[STX] OEJ [ETX]
OPL (PLAY)	Playback is commenced.	[STX] OPL [ETX]	[STX] OPL [ETX]
ORW (REWIND)	The tape is rewind.	[STX] ORW [ETX]	[STX] ORW [ETX]
OFF (FAST FORWARD)	The tape is fast forwarded.	[STX] OFF [ETX]	[STX] OFF [ETX]
OPA (PAUSE)	This is the pause or pause release command. When the VTR is in the playback mode, it is set to the still-picture playback (STILL); when it is in the recording mode, it is set to the pause (REC PAUSE) mode. The VTR's previous mode is restored when this command is sent again.	[STX] OPA [ETX]	[STX] OPA [ETX]
ORC (REC)	Recording is commenced.	[STX] ORC [ETX]	[STX] ORC [ETX]
ORP (REC PAUSE)	The recording pause (REC/PAUSE) mode is established when the VTR is in the still-picture playback (STILL), playback or recording mode. When this command is sent again, the recording mode is established.	[STX] ORP [ETX]	[STX] ORP [ETX]
OAF (ADVANCE FIELD)	When the VTR is in the still-picture playback (STILL), the tape is advanced frame by frame in the forward direction.	[STX] OAF [ETX]	[STX] OAF [ETX]
OAR (ADVANCE REVERSE FIELD)	When the VTR is in the still-picture playback (STILL), the tape is advanced frame by frame in the reverse direction.	[STX] OAR [ETX]	[STX] OAR [ETX]

■ Status command

Send command	Description of operation	Data transmitted by personal computer	Data received in response from VTR																		
QOP (OPERATION MODE)	This command inquires as to the operation mode of the VTR. The VTR returns one of the following codes in response to the QOP command.	[STX] QOP [ETX]	[STX] □□□ [ETX]																		
			<table border="1"> <thead> <tr> <th>VTR operation mode</th> <th>Code</th> </tr> </thead> <tbody> <tr> <td>STOP</td> <td>OSP</td> </tr> <tr> <td>EJECT</td> <td>OEJ</td> </tr> <tr> <td>FF</td> <td>OFF</td> </tr> <tr> <td>REW</td> <td>ORW</td> </tr> <tr> <td>PLAY</td> <td>OPL</td> </tr> <tr> <td>STILL</td> <td>OPP</td> </tr> <tr> <td>RECORD</td> <td>ORC</td> </tr> <tr> <td>REC PAUSE</td> <td>ORP</td> </tr> </tbody> </table>	VTR operation mode	Code	STOP	OSP	EJECT	OEJ	FF	OFF	REW	ORW	PLAY	OPL	STILL	OPP	RECORD	ORC	REC PAUSE	ORP
VTR operation mode	Code																				
STOP	OSP																				
EJECT	OEJ																				
FF	OFF																				
REW	ORW																				
PLAY	OPL																				
STILL	OPP																				
RECORD	ORC																				
REC PAUSE	ORP																				

RS-232C Interface

■ Counter sense command

Send command	Description of operation	Data transmitted by personal computer	Data received in response from VTR
QCD (COUNTER SENSE)	This command inquires as to the current value of the counter. The CTL counter value or TCR value is returned. The counter keys on the front panel or the menu is used to select the CTL counter and TCR values.	[STX] QCD [ETX]	[STX] CDFS □□□□ □□□□ [ETX] □□□□□□□□ Counter value Counter value For a CTL counter value □ □ □□ □□ □□ Sign Hours Minutes Seconds Frames ↓ -: -sign (2DH) +: Blank (20H) For a TCR value □□ □□ □□ □□ Hours Minutes Seconds Frames

■ Standby OFF commands

Send command	Description of operation	Data transmitted by personal computer	Data received in response from VTR
OBF (STANDBY OFF)	This command sets the VTR to the standby OFF mode. It is received when the VTR is in the stop mode.	[STX] OBF [ETX]	[STX] OBF [ETX]
OBN (STANDBY ON)	This command sets the VTR to the standby ON mode. This operation is recognized when the VTR is in the standby OFF mode.	[STX] OBN [ETX]	[STX] OBN [ETX]

■ Deck ID command

Send command	Description of operation	Data transmitted by personal computer	Data received in response from VTR
QID (DECK IN SENSE)	This command inquires as to the TV system accommodated by the VTR.	[STX] QID [ETX]	[STX] □□□□□□□□ □ [ETX] □□□□□□□□ AJ-D230 : NTSC system AJ-D230E : PAL system

ERROR MESSAGES

When trouble has occurred in the VTR, one of the following messages appears on the tape counter.

- The VTR stops operating when any of the error numbers except E-00 and E-01 is displayed.

Error No.	Description of error
— d —	Condensation has formed.
E — 00	This appears when the servo has been disengaged for 3 seconds during normal playback.
E — 01	This appears when dropouts have been detected for two or more seconds during normal playback.
E — 11	The reel base which operates in accordance with the size of the tape has been locked for more than 2.5 seconds.
E — 21	The cassette has not moved down even when 4 seconds have elapsed since it was inserted. Alternatively, the cassette is not ejected even when 4 seconds have elapsed since the EJECT button was pressed.
E — 31	The loading operation was not completed within 4 seconds.
E — 32	The unloading operation was not completed within 4 seconds.
E — 41	The FG (rotational speed) signal has not been output from the cylinder motor.
E — 42	The PG (phase) signal has not been output from the cylinder motor.
E — 43	The rotational speed of the cylinder motor is abnormally high.
E — 44	The rotational speed of the cylinder motor is abnormally low.
E — 51	The FG (rotational speed) signal has not been output from the capstan motor.
E — 52	The rotational speed of the capstan motor is abnormally high.
E — 53	The rotational speed of the capstan motor is abnormally low.
E — 61	The supply reel motor has locked up.
E — 62	The take-up reel motor has locked up.
E — 63	The rotational speed of the supply reel motor is abnormally high.
E — 64	The rotational speed of the take-up reel motor is abnormally high.
E — 65	A tension error has been detected.
E — 66	The start or end processing operation has not been completed even though 7 or more seconds have passed.
E — 67	Communication error between SERVO and AVSYS. There is an error in the data.
E — 68	Communication error between SERVO and AVSYS. The data has been fixed at high or low.
E — 69	An error occurred in communication between SERVO and AVSYS when the power was turned on.
E — 70	The fan motor stopped operating.
E — 80	Trouble has occurred in the supply voltage.

Video Head Cleaning

This VTR comes with an auto head cleaning function which automatically reduces the amount of dirt on the heads. However, to ensure the highest reliability, we recommend that you clean the video heads every day.

Use the cleaning fluid designated by Panasonic.

Checking the hour meter

- 1 Set the VTR to the remote mode.**
(Set the LOCAL/MENU/REMOTE switch to the REMOTE position.)
- 2 When the RESET button on the front panel is pressed, the cumulative numbers of hours during which the drum and capstan have been used are indicated alternately on the counter display for as long as the button is held down.**

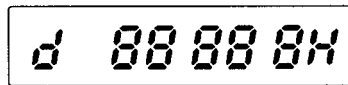

Cumulative drum rotation time

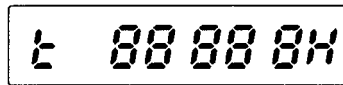

Cumulative capstan rotation time

Condensation

The principle according to which condensation forms is the same as that which causes droplets of water (condensation) to form on the window panes of a heated room when it is cold outside. Condensation forms on the VTR or its tape when it is moved to a location with a considerably different temperature and humidity. More specifically, it forms when the VTR or tape is:

- Brought into a very steamy and humid location or into a room where the heating was just turned on.
- Brought suddenly from an air-conditioned room to a very hot and humid location.

In such cases, do not turn the power on straight away but leave the unit standing for about 10 minutes. When condensation has formed in the unit, an error message lights up in the counter display section, and the cassette tape is automatically ejected.

Keep the power on and wait until the error message is cleared.

Maintenance

Before performing any maintenance work, set the power switch to the OFF position and disconnect the power cable from the AC outlet making sure that you take hold of the molded part of the power plug.

Use a soft cloth to clean the cabinet. In order to get rid of stubborn dirt, dilute some neutral kitchen detergent with water, dip a cloth into the solution, wring it out well, and wipe away the dirt. Then wipe off any moisture which remains using a dry cloth.

Do not use paint thinners or benzine for cleaning purposes.

SPECIFICATIONS

GENERAL

Power supply:	120 V AC, 50Hz-60Hz
Power consumption:	49W

Ambient operating temperature:	41°F to 104°F (5°C to 40°C)
Ambient operating humidity:	35% to 80%
Weight:	15.4 lbs. (7.0 kg)
Dimensions (W × H × D):	8-7/16" × 5-1/4" × 15-7/16" (214 × 132 × 391 mm)
Recording format:	DVCPRO
Recording tracks:	Digital video
Time code:	Recorded in sub-code area
Digital audio:	2 channels
Cue track:	1 track
Control (CTL):	1 track
Tape speed:	33.820 mm/sec.
Recording time:	126 minutes (using AJ-P126LP tape) 66 minutes (using AJ-P66MP tape)
Tape used:	1/4" thin magnetic layer metal tape
FF/REW time:	Within 3.5 min. (using AJ-P126LP tape)

VIDEO

(Digital video)	Sampling frequency:	13.5 MHz for Y; 3.375 MHz for Pb/Pr
	Quantizing:	8 bits
	Error correction:	Reed-Solomon product code
(Line IN/line OUT)	Video band:	30 Hz to 4.5 MHz (−1±1 dB) for Y
	Y/C delay:	Less than 20ns
	K factor:	Less than 3%
(Input connectors)	Line input:	BNC × 1; 1.0 VP-P, 75 Ω
	SYNC input:	BNC × 1; 1.0 VP-P, 75 Ω
	S-VIDEO:	4P × 1; Y: 1.0 VP-P, 75 Ω C: 0.286 VP-P, 75 Ω (burst level)
(Output connectors)	Line output:	BNC × 1; 1.0 VP-P, 75 Ω
	Monitor output:	BNC × 1; 1.0 VP-P, 75 Ω
	S-VIDEO:	4P × 1; Y: 1.0 VP-P, 75 Ω C: 0.286 VP-P, 75 Ω (burst level)

AUDIO

(Digital audio)	Sampling frequency:	48 kHz
	Quantizing:	16 bits
	Frequency response:	20 Hz to 20 kHz (+1.0 dB −2.0 dB)
	Dynamic range:	More than 85 dB (1 kHz, emphasis OFF, "A" weighted)
	Distortion:	Less than 0.1% (1 kHz, emphasis OFF, reference level)
	Crosstalk:	Less than −80 dB (1 kHz, between 2 channels)
(Input connectors)	Line input (CH1/CH2):	PHONO × 2; −8 dBV, 47 kΩ
(Output connectors)	Line output (CH1/CH2):	PHONO × 2; −8 dBV, 1 kΩ
	Headphones output:	M3 stereo, variable level (max. −32 dBV or more), 8Ω

OTHER INPUT/OUTPUT CONNECTORS

RS-232C:	D-SUB, 25P, RS-232C interface
Wired remote control:	M2 jack (simple remote control)

Display Tube

Counter:	8 digits (CTL/TC/UB selectable, remaining tape)
Audio level meter:	18 steps
Other:	REC/REC INH, REMOTE, WIDE, "Consumer-use cassette loaded" display, REPEAT, SERVO, Channel condition, "Cassette loaded" display

Panasonic

Broadcast & Television Systems Company

Division of Matsushita Electric Corporation of America

Executive Office

One Panasonic Way (4B-7) Secaucus, NJ 07094

Service Centers

Eastern: One Panasonic Way, Panazip (2A-4), Secaucus, NJ 07094

(201)-348-7677 Fax (201)-348-7511

Southern: 1225 Northbrook Parkway, Suite #170, Suwanee, GA 30174

(770)-338-6855 Fax (770)-338-6656

Western: 4001 West Alameda Ave., Suite 100, Burbank, CA 91505

(818)-562-1579 Fax (818)-562-6663

Parts Information & Ordering

9:00 am – 5:00 pm (EST) (800)-334-4881/24 hr.Fax (800)-334-4880

Technical Support

Emergency 24 hr Parts & Support (800)-222-0741

Training Information

Digital System Products (201)-392-6076

Service Literature

(201)-392-6281

Panasonic Canada Inc.

5770 Ambler Drive, Mississauga, Ontario L4W 2T3 (905)-624-5010

Panasonic de Mexico S.A. de C.V.

Av angel Urraza Num. 1209 Col. de Valle 03100 Mexico, D.F. (52) 1 951 2127

Free Manuals Download Website

<http://myh66.com>

<http://usermanuals.us>

<http://www.somanuals.com>

<http://www.4manuals.cc>

<http://www.manual-lib.com>

<http://www.404manual.com>

<http://www.luxmanual.com>

<http://aubethermostatmanual.com>

Golf course search by state

<http://golfingnear.com>

Email search by domain

<http://emailbydomain.com>

Auto manuals search

<http://auto.somanuals.com>

TV manuals search

<http://tv.somanuals.com>