

Panasonic®

English

MP3 CD Player/Receiver

Model: **CQ-CM130U**



Operating Instructions



MP3



- Please read these instructions (including “Limited Warranty” and “Customer Services Directory”) carefully before using this product and keep this manual for future reference.

Safety Information

- Read the operating instructions for the unit and all other components of your car audio system carefully before using the system. They contain instructions about how to use the system in a safe and effective manner. Panasonic assumes no responsibility for any problems resulting from failure to observe the instructions given in this manual.



Warning

This pictograph intends to alert you to the presence of important operating instructions and installation instructions. Failure to heed the instructions may result in severe injury or death.



Caution

This pictograph intends to alert you to the presence of important operating instructions and installation instructions. Failure to heed the instructions may result in injury or material damage.

Warning

Observe the following warnings when using this unit.

- ❑ **The driver should neither watch the display nor operate the system while driving.**
Watching the display or operating the system will distract the driver from looking ahead of the vehicle and can cause accidents. Always stop the vehicle in a safe location and use the parking brake before watching the display or operating the system.
- ❑ **Use the proper power supply.**
This product is designed for operation with a negative grounded 12 V DC battery system. Never operate this product with other battery systems, especially a 24 V DC battery system.
- ❑ **Protect the Deck Mechanism.**
Do not insert any foreign objects into the slot of this unit.
- ❑ **Do not disassemble or modify the unit.**
Do not disassemble, modify the unit or attempt to repair the product yourself. If the product needs to be repaired, consult your dealer or an authorized Panasonic Servicenter.
- ❑ **Do not use the unit when it is out of order.**
If the unit is out of order (no power, no sound) or in an abnormal state (has foreign objects in it, is exposed to water, is smoking, or smells), turn it off immediately and consult your dealer.
- ❑ **Refer fuse replacement to qualified service personnel.**
When the fuse blows out, eliminate the cause and have it replaced with the fuse prescribed for this unit by a qualified service engineer. Incorrect replacement of the fuse may lead to smoke, fire, and damage to the product.

Observe the following warnings when installing.

- ❑ **Disconnect the lead from the negative (-) battery terminal before installation.**
Wiring and installation with the negative (-) battery terminal connected may cause electrical shock and injury due to a short circuit. Some cars equipped with the electrical safety system have specific procedures of battery terminal disconnection.
FAILURE TO FOLLOW THE PROCEDURE MAY LEAD TO THE UNINTENDED ACTIVATION OF THE ELECTRICAL SAFETY SYSTEM RESULTING IN DAMAGE TO THE VEHICLE AND PERSONAL INJURY OR DEATH.
- ❑ **Never use safety-related components for installation, grounding, and other such functions.**
Do not use safety-related vehicle components (fuel tank, brake, suspension, steering wheel, pedals, airbag, etc.) for wiring or fixing the product or its accessories.
- ❑ **Installing the product on the air bag cover or in a location where it interferes with airbag operation is prohibited.**
- ❑ **Check for piping, gasoline tank, electric wiring, and other items before installing the product.**
If you need to open a hole in the vehicle chassis to attach or wire the product, first check where the wire harness, gasoline tank, and electric wiring are located. Then open the hole from outside if possible.
- ❑ **Never install the product in a location where it interferes with your field of vision.**
- ❑ **Never have the power cord branched to supply other equipment with power.**
- ❑ **After installation and wiring, you should check the normal operation of other electrical equipment.**
The continuation of their using in abnormal conditions may cause fire, electrical shock or a traffic accident.
- ❑ **In the case of installation to an airbag equipped car, confirm warnings and cautions of the vehicle manufacturer before installation.**
- ❑ **Make sure the leads do not interfere with driving or getting in and out of the vehicle.**
- ❑ **Insulate all exposed wires to prevent short circuiting.**

Caution

Observe the following cautions when using this unit.

- Keep the sound volume at an appropriate level.**
Keep the volume level low enough to be aware of road and traffic conditions while driving.
- This unit is designed for use exclusively in automobiles.**
- Do not operate the unit for a prolonged period with the engine turned off.**
Operating the audio system for a long period of time with the engine turned off will drain the battery.
- Do not expose the unit to direct sunlight or excessive heat.**
Otherwise these will raise the interior temperature of the unit, and it may lead to smoke, fire, or other damage to the unit.
- Do not use the product where it is exposed to water, moisture, or dust.**
Exposure of the unit to water, moisture, or dust may lead to smoke, fire, or other damage to the unit. Make especially sure that the unit does not get wet in car washes or on rainy days.
- To prevent the microphone from howling, keep proper distance between the microphone and the speaker.**
- Decrease the volume immediately whenever the howling is generated.**
Failure to heed this may damage your hearing and speakers.

Observe the following cautions when installing.

- Refer wiring and installation to qualified service personnel.**
Installation of this unit requires special skills and experience. For maximum safety, have it installed by your dealer. Panasonic is not liable for any problems resulting from your own installation of the unit.
- Follow the instructions to install and wire the product.**
Not following the instructions to properly install and wire the product could cause an accident or fire.

Caution

**THIS PRODUCT UTILIZES A CLASS I LASER.
USE OF CONTROLS OR ADJUSTMENTS OR PERFORMANCE OF
PROCEDURES OTHER THAN THOSE SPECIFIED HEREIN MAY
RESULT IN HAZARDOUS RADIATION EXPOSURE.
DO NOT OPEN COVERS AND DO NOT REPAIR BY YOURSELF.
REFER SERVICING TO QUALIFIED PERSONNEL.**

Take care not to damage the leads.

When wiring, take care not to damage the leads. Prevent them from getting caught in the vehicle chassis, screws, and moving parts such as seat rails. Do not scratch, pull, bend or twist the leads. Do not run them near heat sources or place heavy objects on them. If leads must be run over sharp metal edges, protect the leads by winding them with vinyl tape or similar protection.

Use the designated parts and tools for installation.

Use the supplied or designated parts and appropriate tools to install the product. The use of parts other than those supplied or designated may result in internal damage to the unit. Faulty installation may lead to an accident, a malfunction or fire.

Do not block the air vent or the cooling plate of the unit.

Blocking these parts will cause the interior of the unit to over-heat and will result in fire or other damage.

Do not install the product where it is exposed to strong vibrations or is unstable.

Avoid slanted or strongly curved surfaces for installation. If the installation is not stable, the unit may fall down while driving and this can lead to an accident or injury.

Installation Angle

The product should be installed in a horizontal position with the front end up at a convenient angle, but not more than 30°.

The user should bear in mind that in some areas there may be restrictions on how and where this unit must be installed.

Consult your dealer for further details.

Wear gloves for safety. Make sure that wiring is completed before installation.

To prevent damage to the unit, do not connect the power connector until the whole wiring is completed.

Do not connect more than one speaker to one set of speaker leads. (except for connecting to a tweeter)

The microphone input on this unit is only for specially designated microphone unit.

The following applies only in the U.S.A.

Part 15 of the FCC Rules

FCC Warning:

Any unauthorized changes or modifications to this equipment would void the user's authority to operate this device.

Before Reading These Instructions

Panasonic welcomes you to our constantly growing family of electronic products owners.

We endeavor to give you the advantages of precise electronic and mechanical engineering, manufactured with carefully selected components, and assembled by people who are proud of the reputation their work has built for our company. We know this product will bring you many hours of enjoyment, and after you discover the quality, value and reliability we have built into it, you too will be proud to be a member of our family.

U.S.A.

Obtain Product Information and Operating Assistance; locate your nearest Dealer or Servicenter; purchase Parts and Accessories; or make Customer Service and Literature requests by visiting our Web Site at:

<http://www.panasonic.com/support>

or, contact us via the web at:

<http://www.panasonic.com/contactinfo>

You may also contact us directly at:

1-800-211-PANA (7262),

Monday-Friday 9 am-9 pm; Saturday-Sunday 10 am-7 pm,

EST.

For hearing or speech impaired TTY users, TTY : 1-877-833-8855

Accessory Purchases:

Purchase Parts, Accessories and Instruction Books online for all Panasonic Products by visiting our Web Site at:

<http://www.pasc.panasonic.com>

or, send your request by E-mail to:

npcparts@panasonic.com

You may also contact us directly at:

1-800-332-5368 (Phone) 1-800-237-9080 (Fax Only)

(Monday-Friday 9 am to 8 pm, EST.)

Panasonic Services Company

20421 84th Avenue South, Kent, WA 98032

(We accept Visa, MasterCard, Discover Card, American Express, and Personal Checks)

For hearing or speech impaired TTY users, TTY : 1-866-605-1277

Service in Puerto Rico

Panasonic Puerto Rico, Inc.

Panasonic Sales Company

Factory Servicenter:

Ave. 65 de Infantería, Km. 9.5, San Gabriel Industrial Park,

Carolina, Puerto Rico 00985

Phone (787) 750-4300, Fax (787) 768-2910

U.S.A.

PANASONIC CONSUMER ELECTRONICS COMPANY,
DIVISION OF PANASONIC CORPORATION OF NORTH AMERICA
One Panasonic Way, Secaucus, New Jersey 07094

PANASONIC SALES COMPANY,
DIVISION OF PANASONIC PUERTO RICO, INC.
Ave. 65 de infantería, Km. 9.5, San Gabriel Industrial Park
Carolina, Puerto Rico 00985

PANASONIC AUTO PRODUCTS LIMITED WARRANTY

LIMITED WARRANTY COVERAGE

If your product does not work properly because of defects in materials and workmanship.

Panasonic Consumer Electronics Company or Panasonic Sales Company (collectively referred to as "the warrantor") will, for the length of the period indicated in the chart below, which starts with the date of original purchase ("warranty period"), at its option either (a) repair your product with new or refurbished parts, or (b) replace it with a new or refurbished product. The decision to repair or replace will be made by the warrantor.

Categories	Parts	Labor
Audio Components (except items listed below)	One (1) Year	One (1) Year
MXE Series Audio Components (except items listed below)	Two (2) Years	Two (2) Years
Speakers Defective Car Audio Speakers under warranty must be exchanged at the place of purchase. Contact your Dealer for details.	One (1) Year	Not Applicable
Accessories (in exchange for defective items)	Ninety (90) Days	Not Applicable

During the "Labor" warranty period, there will be no charge for labor. During the "Parts" warranty period, there will be no charge for parts. You must carry-in or mail-in your product prepaid during the warranty period. If non-rechargeable batteries are included, they are not warranted. This warranty only applies to products purchased and serviced in the United States or Puerto Rico. This warranty is extended only to the original purchaser of a new product which was not sold "as is". A purchase receipt or other proof of the original purchase date is required for warranty service.

CARRY-IN OR MAIL-IN SERVICE

For Carry-In or Mail-In Service in the United States, call 1-800-211-PANA (7262) or visit
Panasonic Web Site: <http://www.panasonic.com>
For assistance in Puerto Rico, call Panasonic Sales Company (787)-750-4300 or fax (787)-768-2910.

LIMITED WARRANTY LIMITS AND EXCLUSIONS

This warranty ONLY COVERS failures due to defects in materials and workmanship, and DOES NOT COVER normal wear and tear or cosmetic damage. The warranty ALSO DOES NOT COVER damages which occurred during shipment, failures which are caused by products not supplied by the warrantor, failures which result from accident, misuse, abuse, neglect, bug infestation, mishandling, misapplication, alteration, faulty installation, set-up adjustment, maladjustment of consumer control, improper maintenance, improper antenna, inadequate signal reception or pickup, power line surge, improper voltage supply, lightning, modification, commercial use (such as use in hotels, offices, restaurants, or other business uses) or rental use of the product, or service by anyone other than the technician from Factory Servicenter or other authorized service centers, or damage that is attributable to acts of God.

THERE ARE NO EXPRESS WARRANTIES EXCEPT AS LISTED UNDER "LIMITED WARRANTY COVERAGE". THE WARRANTOR IS NOT LIABLE FOR INCIDENTAL OR CONSEQUENTIAL DAMAGES RESULTING FROM THE USE OF THIS PRODUCT, OR ARISING OUT OF ANY BREACH OF THIS WARRANTY. (As examples, this excludes damages for lost time, cost of having someone remove or re-install an installed unit if applicable, travel to and from the sevicer, and loss of media, data or other memory contents. The items listed are not exclusive, but are for illustration only.) **ALL EXPRESS AND IMPLIED WARRANTIES, INCLUDING THE WARRANTY OF MERCHANTABILITY, ARE LIMITED TO THE PERIOD OF THE LIMITED WARRANTY.**

Some states do not allow the exclusion or limitation of incidental or consequential damages, or limitations on how long an implied warranty lasts, so the exclusions may not apply to you.

This warranty gives you specific legal rights and you may also have other rights which vary from state to state. If a problem with this product develops during or after the warranty period, you may contact your dealer or Servicenter. If the problem is not handled to your satisfaction, then write to warrantor's Consumer Affairs Department at the addresses of the warrantor.

PARTS AND SERVICE WHICH ARE NOT COVERED BY THIS LIMITED WARRANTY ARE YOUR RESPONSIBILITY.

Customer's Record

Model
No. _____
Serial
No. _____
Dealer's
No. _____
Code
No. _____
Dealer's
Address _____
Date of
Purchase _____

Specifications

General

Power supply	:DC 12 V (11 V – 16 V DC), test voltage 14.4 V, negative ground
Current consumption	:Less than 2.2 A (CD mode; 0.5 W x 4 channels)
Maximum power output	:50 W x 4 channels (at 1 kHz), volume control maximum
Tone adjustment range	:Bass: ± 12 dB at 100 Hz, Treble: ± 12 dB at 10 kHz
Speaker impedance	:4 – 8 Ω
Pre-amp output voltage	:2.5 V (CD mode, 1 kHz, 0 dB)
Pre-amp output impedance	:200 Ω
Dimensions (W x H x D)	:178 x 50 x 155 mm (7" x 1 15/16" x 6 2/16")
Weight	:1.3 kg (2 lbs. 14 oz)

Disc Player

Sampling frequency	:8 times oversampling
DA converter	:1 bit DAC System
Pick-up type	:Astigma 3-beam
Light source	:Semiconductor laser
Wave length	:790 nm
Frequency response	:20 Hz – 20 kHz (± 1 dB)
Signal to noise ratio	:96 dB
Total harmonic distortion	:0.01 % (1 kHz)
Wow and flutter	:Below measurable limits
Channel separation	:75 dB

FM Stereo Radio

Frequency range	:87.9 MHz – 107.9 MHz
Usable sensitivity	:11.0 dBf. (75 Ω)
50 dB quieting sensitivity	:15.2 dBf. (75 Ω)
Frequency response	:30 Hz – 15 kHz (± 3 dB)
Alternate channel selectivity	:75 dB
Stereo separation	:35 dB (1 kHz)
Image rejection ratio	:55 dB
IF rejection ratio	:100 dB
Signal/noise ratio	:62 dB

AM Radio

Frequency range	:530 kHz – 1 710 kHz
Usable sensitivity	:28 dB/ μ V (S/N 20 dB)

Above specifications comply with EIA standards.

Power Output:
18 W RMS x 4 Channels at 4 Ω and $\leq 1\%$
THD+N
Signal to Noise Ratio:
85 dBA (reference: 1 W into 4 Ω)







Notes:



- Specifications and design are subject to modification without notice due to improvements.
- Some figures and illustrations in this manual may be different from your product.

Accessories

Instruction kit

	Operating Instructions (YFM264C047CB)	Q'ty: 1
	Installation Instructions (YFM294C119CA)	Q'ty: 1
	Product Registration Card	Q'ty: 1
	Customer Care Plan	Q'ty: 1

Installation kit (ZZBISC1101U-J)

	Lock Cancel Plate	Q'ty: 2
	Mounting Bolt	Q'ty: 1
	Rubber Bushing	Q'ty: 1



Mounting Collar
(FX0214C384ZB)

Q'ty: 1



Trim Plate
(YFC054C081YA)

Q'ty: 1



Power Connector
(YGAJ021012)

Q'ty: 1

Notes:

- The number in parentheses underneath each accessory part name is the part number for maintenance and service.
- Accessories and their part numbers are subject to modification without prior notice due to improvements.
- Mounting Collar and Trim Plate are mounted on the main unit at shipment.

© 2007 Matsushita Electric Industrial Co., Ltd. All Rights Reserved.

Panasonic Consumer Electronics Company, Division of Panasonic Corporation of North America
One Panasonic Way, Secaucus, New Jersey 07094
<http://www.panasonic.com>

Panasonic Sales Company, Division of Panasonic Puerto Rico, Inc. ("PSC")
Ave. 65 de Infanteria, Km. 9.5 San Gabriel Industrial Park, Carolina, Puerto Rico 00985
<http://www.panasonic.com>

Preparation

First Time Power On

- 1 Set your car's ignition switch to the ACC or ON position.

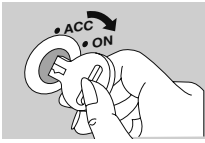

- 2 Press [SRC] (PWR: Power).

Clock Setting

The 12-hour system is used for the clock.

- 1 Press [DISP] (CLOCK).

(clock display)

- 2 Hold down [DISP] (CLOCK) for more than 2 seconds.

Hour blinks.

- 3 Adjust the hour.

Hour entered.

[>]: sets the hour ahead.

[<]: sets the hour back.

- 4 Press [DISP] (CLOCK).

Minute blinks.

- 5 Adjust the minute.

Minute entered.

[>]: sets the minute ahead.

[<]: sets the minute back.

- 6 Press [DISP] (CLOCK).

Completed

Notes:

- "ADJUST" is displayed before adjusting the clock.
- Hold down [<] or [>] to change numbers rapidly.

Clock Display at Power Off

Press [DISP] to change the display.

Display off



Clock display

Maintenance

Cleaning the Unit

Your product is designed and manufactured to ensure the minimum of maintenance. Use a soft cloth for routine exterior cleaning. Never use benzine, thinner, or other solvents.

Fuse

If the replaced fuse fails, contact your nearest authorized Panasonic Servicer.

Warning

- Use fuses of the same specified rating (**15 A**). Using substitutes or fuses with higher ratings, or connecting the unit directly without a fuse could cause fire or damage to the unit. **If the replaced fuse fails, contact your nearest authorized Panasonic Servicer.**

Microphone unit

When using a microphone

- 1 Please keep the microphone sound volume at an appropriate level.
- 2 Hold down the speaking button on the microphone to make an announcement. The sound of the announcer is output from speakers.
Note:
 - The sound of current mode (Radio/Disc player) will become mute during making microphone announcement.
 - The microphone sound output is not feasible during following status: "Disc pause", "No disc" and mute function set to ON. This indicates there is nothing wrong with the main unit. Please avoid using microphone during above circumstances.
- 3 Release the speaking button on the microphone to end an announcement.

Notes on Discs

If you use commercial CDs, they must have either of these labels shown at right. Some copy-protected music CDs are not playable.



How to hold the disc

- Do not touch the underside of the disc.
- Do not scratch on the disc.
- Do not bend the disc.
- When not in use, keep the disc in a case.

Do not leave discs in the following places:

- In direct sunlight
- Near car heaters
- Dirty, dusty and damp areas
- On seats and dashboards

Disc cleaning

Use a dry, soft cloth to wipe from the center outward.



Do not write on the disc label with a ballpoint pen or other hard-point pens.



Labels created by a printer, Protective films or sheets



Irregularly shaped discs



Disc with adhered stickers or tape



Discs with cracks, scratches or parts missing

- You may have trouble playing back some CD-R/RW discs recorded using CD recorders (CD-R/RW drives), either due to their recording characteristics or dirt, fingerprints, scratches, etc. on the disc surface.
- CD-R/RW discs are less resistant to high temperatures and high humidity than ordinary music CDs. Leaving them inside a car for extended periods may damage them and make playback impossible.
- Some CD-R/RWs cannot be played back successfully due to incompatibility among writing software, a CD recorder (CD-R/RW drive) and the discs.
- This player cannot play the CD-R/RW discs if the session is not closed.
- This player cannot play the CD-R/RW discs which contain other than CD-DA data or MP3.
- Be sure to observe the instructions of the CD-R/RW disc for handling it.
- The file extension ".mp3" should be assigned to each file depending on the file format.
- This unit does not have the play list function.
- Although Multi-session recording is supported, the use of Disc-at-Once is recommended.

Supported file systems

ISO 9660 Level 1/Level 2, Apple Extension to ISO 9660, Joliet, Romeo

Note: Apple HFS, UDF 1.50, MIX mode CD, CD Extra is not supported.

Compression formats

(**Recommendation:** "Points to remember when making MP3 files" on the right.)

Recording MP3 files on a CD-media

- **You are recommended to minimize the chances of making a disc that contains both CD-DA files and MP3 files.**
- **If CD-DA files are on the same disc as MP3 or files, the songs may not play in the intended order, or some songs may not play at all.**
- Do not record files other than MP3 files and unnecessary folder on a disc.
- The name of MP3 file should be added by rules as shown in the following descriptions and also comply with the rules of each file system.
- You may encounter trouble in playing MP3 files or displaying the information of MP3 files recorded with certain writing software or CD recorders.
- **MPEG 1 audio layer 3**
Bit rate: 32 k-320 kbps
VBR: Yes
Sampling frequency: 32, 44.1, 48 kHz
- **MPEG 2 audio layer 3**
Bit rate: 8 k-160 kbps
VBR: Yes
Sampling frequency: 16, 22.05, 24 kHz

Notes on MP3

Note: MP3 encoding and writing software is not supplied with this unit.

Points to remember when making MP3 files

- High bit rate and high sampling frequency are recommended for high quality sounds.
- Selecting VBR (Variable Bit Rate) is not recommended because playing time is not displayed properly and sound may be skipped.
- The playback sound quality differs depending on the encoding circumstances. For details, refer to the user manual of your own encoding software and writing software.
- It is recommended to set the bit rate to "128 kbps or more" and "fixed".

Caution

Never assign the ".mp3", file name extension to a file that is not in the MP3 format. This may not only produce noise from the speaker damage, but also damage your hearing.

Display Information

Displayed items

- | | |
|---|--|
| • CD-TEXT
Disc title
Track title | • MP3 (ID3 tag)
Album name
Title name/Artist name |
| • MP3
Folder name
File name | |

Displayable characters

- Displayable length of file name/folder name: within 32 characters. (Unicoded file and folder names are reduced by half in the number of displayable characters.)
- Name files and folders in accordance with the standard of each file system. Refer to the instructions of writing software for details.
- ASCII character set and special characters in each language can be displayed.

Notes:

- With some software in which MP3 format files have been encoded, the character information may not be displayed properly.
- Undisplayable characters and symbols will be converted into an asterisk (*).

Folder selection order/file playback order

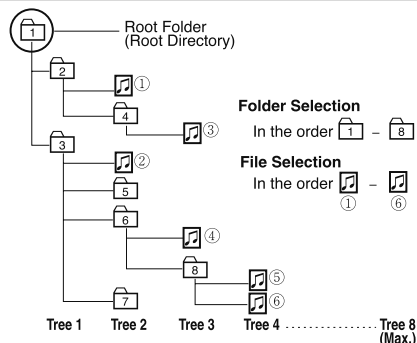

Maximum number of files/folders

- Maximum number of files: 999
- Maximum number of files in one folder: 255
- Maximum depth of trees: 8
- Maximum number of folders: 255 (Root folder is included.)

Notes:

- This unit counts the number of folders irrespective of the presence or absence of an MP3 file.
- If the selected folder does not contain any MP3 files, the nearest MP3 files in the order of playback will be played.
- Playback order may be different from other MP3 players even if the same disc is used.
- "ROOT" appears when displaying the root folder name.

Copyright

It is prohibited by copyright laws to copy, distribute and deliver copyrighted materials such as music without the approval of copyright holder except enjoying yourself personally.

No warranty

Above description complies with our investigations as of September 2007. It has no warranty for reproducibility and displayability of MP3.

MPEG Layer-3 audio coding technology licensed from Fraunhofer IIS and Thomson.

General

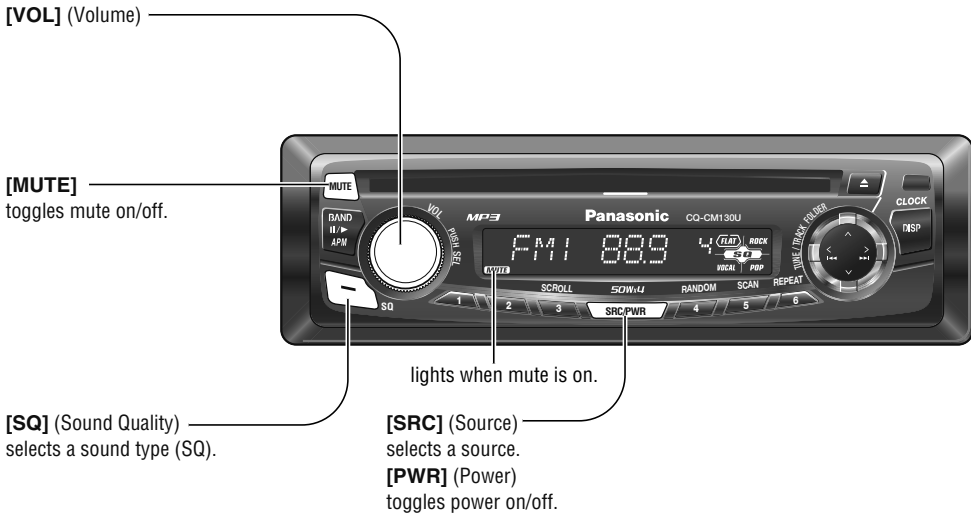

General Operations

Power On/Off

Set your car's ignition switch to the ACC or ON position.

Power on: Press **[SRC]** (**PWR**).

Power off: Hold down **[SRC]** (**PWR**) for more than 1 second.

Source Selection

Press **[SRC]** to change the source.



Volume Adjustment

(Setting Range: 0 to 40, Default: 18)
Turn **[VOL]**.



Mute

ON: Press **[MUTE]**. (**[MUTE]** lights.)

OFF: Press **[MUTE]** again.

SQ (Sound Quality)

SQ is a function that can call up various sound types at the touch of button in accordance with your listening music type.

Press **[SQ]** to select the sound type as follows:

	(FLAT) flat frequency response: does not emphasize any part. (Default)
	(ROCK) speedy and heavy sound: exaggerates bass and treble.
	(POP) wide-ranged and deep sound: slightly emphasizes bass and treble.
	(VOCAL) clear sound: emphasizes middle tone and slightly emphasizes treble.

Note: Settings of SQ, bass and treble are influenced one another. If such an influence causes distortion to the audio signal, readjust bass/treble or volume.

Radio (AM/FM)

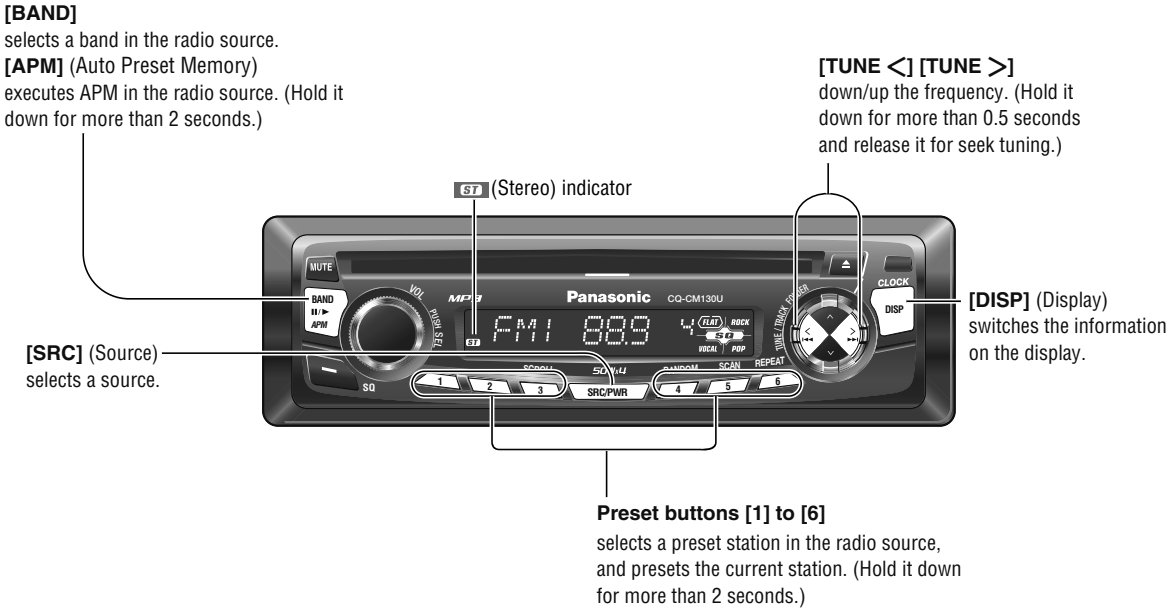

- 1 Press **[SRC]** to select the radio source.
- 2 Press **[BAND]** to select a band.

- 3 Select a station.

Frequency adjustment

[TUNE<]: Lower

[TUNE>]: Higher

Note: Hold down either of them for more than 0.5 seconds and release it for seek tuning.

Preset station selection

Press the corresponding preset button from **[1]** to **[6]** to tune in a preset station.

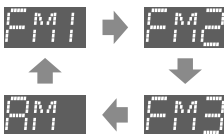

lights while receiving an FM stereo signal.

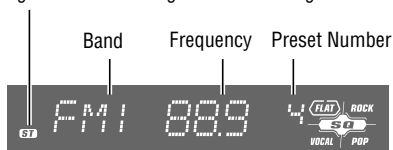

Display change

Press **[DISP]** to change the display.

Radio mode display (Default)

FM 88.9 4



FM 12:35

Clock display

Up to 6 stations can be preset in AM, FM1, FM2, and FM3 respectively.

Preset stations can be simply called up by pressing **[1]** to **[6]**.

Auto Preset Memory (APM)

With this operation, stations with good receiving conditions can be automatically stored in the preset memory.

- 1 Select a band.
- 2 Hold down **[BAND]** (**APM**) for more than 2 seconds.

The preset stations under best receiving conditions are received for 5 seconds each after presetting the stations (SCAN). To stop scanning, press one of the buttons from **[1]** to **[6]**.

Note: New stations overwrite existing saved stations.

Manual station preset

- 1 Tune into a station.
- 2 Hold down one of the preset buttons from **[1]** to **[6]** for more than 2 seconds.



(blinks once)

Note: New stations overwrite existing saved stations.

Audio Settings

[VOL]

selects a value in the audio menu.
(PUSH SEL) (Push to Select)
 selects items in the audio menu.



[DISP] (Display)
 exits from the audio menu.

- 1 Press **[VOL]** (**PUSH SEL**) to display the audio menu display.

Note: If no operation takes place for more than 5 seconds in the audio menu (2 seconds in Main volume adjustment), the display returns to the regular mode.

- 2 Press **[VOL]** (**PUSH SEL**) to select a mode to be adjusted.

- 3 Turn **[VOL]** clockwise or counterclockwise to adjust.

VOL 18 Volume
 (Setting Range: 0 to 40, Default: 18)

BASS Bass
 (Setting Range: -12 dB to +12 dB by 2 dB, Default: 0 dB)

TREBLE Treble
 (Setting Range: -12 dB to +12 dB by 2 dB, Default: 0 dB)

BALANCE Balance
 (Setting Range: 15 levels each, Default CNT (center))

FADER Fader
 (Setting Range: 15 levels each, Default CNT (center))



Note: The FADER adjustment is not applicable to this unit. (Please do not control FADER function)

Memorandum

A series of horizontal dashed lines for writing the memorandum content.

Player (Disc Player)

Disc slot

takes a disc in with the printed side facing up.

Notes:

- The power will be turned on automatically when a disc is loaded.
- A disc which has both CD-DA data and MP3 data on it may not be reproduced normally.

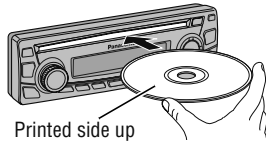

Printed side up

[II / ►] (Pause/Play)

toggles pause/play in the player source.

DISC indicator

[3] (SCROLL)

scrolls the information on display.

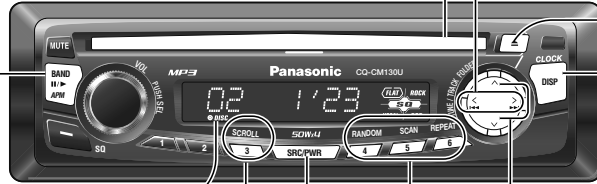

[SRC] (Source)
selects a source.

[V] [∧]

skip to the previous/next folder in MP3 mode.

[4] (RANDOM)/[5] (SCAN)/[6] (REPEAT)
toggles on/off each play mode.

[◀◀] [▶▶]

skip to the previous/next track/file in the player mode. Hold down either of them for fast reverse/fast forward.

[▲] (Eject)
ejects the disc.

[DISP] (Display)
switches the information on the display.

⚠ Caution

- Do not insert a disc when the **DISC** indicator lights.
- Refer to the section of "Notes on Discs" and "Notes on MP3."
- This unit does not support 8 cm (3") discs.
- If you insert an 8 cm (3") disc and cannot eject it, turn the ignition key to the ACC OFF position once and turn the key to the ACC ON position again, then press **[▲]** (Eject).
- Do not insert foreign objects into the disc slot.

Operation Flow

- 1 Press **[SRC]** to select the Disc Player source.
- 2 Select a desired portion.

Track/file selection

Press **[◀◀] / [▶▶]**.

Note: To perform fast forward/reverse, hold down either of them.

Disc Player (CD-DA disc):

Previous/next track

Disc Player (MP3 disc):

Previous/next file

Folder selection (MP3)

Disc Player (MP3 disc):

Press **[V] / [∧]**.

Skip to the previous/next folder.

Pause

Press **[BAND] (II / ►)**.

Press again to cancel.

CD-DA mode display

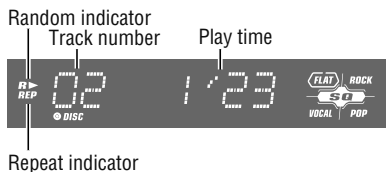

MP3 mode display

lights when folder random/repeat/scan is on.

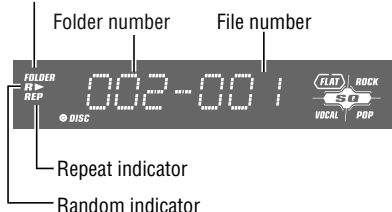

Display change

Press **[DISP]** to change the display.

Disc Player (CD-DA disc):

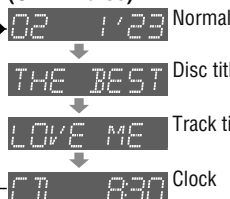

Disc Player (MP3 disc):

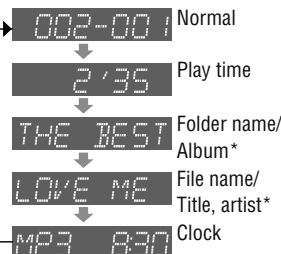

*ID3 Tag On/Off

Hold down **[3]** for more than 2 seconds.



album title and song title/artist name are displayed.



(Default)
folder name/file name are displayed.

Notes:

- For scrolling text, press **[3]** (**SCROLL**).
- "NO TEXT" is displayed when there is no information on the disc.

Random play

All the available tracks/files are played in a random sequence.

Press **[4]** (**RANDOM**).

Press again to cancel.

Folder random play (MP3)

All the available files in current folder are played in a random sequence.

Hold down **[4]** (**RANDOM**) for more than 2 seconds.

Hold down again to cancel.

Repeat play

The current track/file is repeated.

Press **[6]** (**REPEAT**).

Press again to cancel.

Folder repeat play (MP3)

The current folder is repeated.

Hold down **[6]** (**REPEAT**) for more than 2 seconds.

Hold down again to cancel.

Scan play

The first 10 seconds of each tracks/files is played in sequence.

Press **[5]** (**SCAN**).

Press again to cancel.

Folder scan play (MP3)

From the next folder, the first 10 seconds of the first file in each album is played in sequence.

Hold down **[5]** (**SCAN**) for more than 2 seconds.

Hold down again to cancel.

Troubleshooting

If You Suspect Something Wrong

Check and take steps as described below.

If the described suggestions do not solve the problem, it is recommended to take the unit to your nearest authorized Panasonic Servicenter. The product should be serviced only by qualified personnel. Please refer the checking and the repair to professionals. Panasonic shall not be liable for any accidents arising out of neglect of checking the unit or your own repair after your checking.

Never take measures especially for those other than indicated by *italic* letters in "Check point" described below because those are too dangerous for users to handle themselves.

Trouble	Check point
Common	
No power	<ul style="list-style-type: none"> ● Start the engine. (Or turn the ignition switch to the ACC position.) ● Verify the wiring. (battery lead, power lead, ground lead, etc.) ● Fuse blown (Contact the nearest Panasonic Servicenter.) ● Ask a professional for fuse replacement. ● Be sure to use the same rated fuse.
No sound	<ul style="list-style-type: none"> ● Disable the mute function. ● Verify the wiring. ● Wait until the dew disappears before turning on the unit.
Noise	<ul style="list-style-type: none"> ● Make sure that grounding is established properly.
No sound from left, right, front, or rear speaker	<ul style="list-style-type: none"> ● Adjust the balance and fader. ● Verify the wiring.
Left and right sounds are reversed	<ul style="list-style-type: none"> ● Connect the speaker lead correctly.
Radio	
Frequent noise	<ul style="list-style-type: none"> ● Tune in to another station of high-intensity waves. ● Make sure that the antenna mounted point is grounded properly.
Preset data deleted	<ul style="list-style-type: none"> ● The preset memory is cleared to return to the original factory setting when the power connector or battery is disconnected.
Disc Player	
No sound, or disc is automatically ejected	<ul style="list-style-type: none"> ● Load the disc correctly. ● Clean the disc.

Warning





- Do not use the unit in an irregular condition, for example, without sound, or with smoke or a foul smell, which can cause ignition or electric shock. Immediately stop using the unit and consult your dealer.
- Never try to repair the unit by yourself because it is dangerous to do so.

Trouble	Check point
Sound skip, poor sound quality	<ul style="list-style-type: none"> ● Clean the disc.
Sound skip due to vibration	<ul style="list-style-type: none"> ● The maximum permissible tilt angle is 30°. ● Secure the unit.
Disc unejectable	<ul style="list-style-type: none"> ● Press [▲]. If the disc is still not ejected, contact the nearest Panasonic Servicenter.

Microphone

Microphone volume is too low, or noise level is too high.	<ul style="list-style-type: none"> ● Get close the distance between the announcer and the microphone.
Microphone sound is too loud, or distortion level is too high.	<ul style="list-style-type: none"> ● Decrease the microphone volume.
Howling is generated.	<ul style="list-style-type: none"> ● Keep proper distance between the microphone and the speaker.
No microphone sound.	<ul style="list-style-type: none"> ● Disable the mute function. ● Increase the microphone volume. ● Verify the connection/wiring of the microphone unit.

Error Display Messages

	(The disc is ejected automatically.) The disc is dirty, or is upside down. The disc has scratches.
	<ul style="list-style-type: none"> ● Check the disc.
	No operation by some cause. <ul style="list-style-type: none"> ● If normal operation is not restored, consult your dealer or the nearest Servicenter to ask for repairs.
	Cannot read the file <ul style="list-style-type: none"> ● Check the file.

Free Manuals Download Website

<http://myh66.com>

<http://usermanuals.us>

<http://www.somanuals.com>

<http://www.4manuals.cc>

<http://www.manual-lib.com>

<http://www.404manual.com>

<http://www.luxmanual.com>

<http://aubethermostatmanual.com>

Golf course search by state

<http://golfingnear.com>

Email search by domain

<http://emailbydomain.com>

Auto manuals search

<http://auto.somanuals.com>

TV manuals search

<http://tv.somanuals.com>