

Panasonic

In-dash 7"Widescreen Color LCD Monitor/DVD Receiver
인대쉬 7" 와이드스크린 컬러 LCD 모니터/DVD 리시버
7-дюймовый автомобильный широкоэкранный цветной ЖК-монитор/DVD-ресивер

Model: **CQ-VD5005W**



MP3

- Please read these instructions carefully before using this product and keep this manual for future reference.
- 본 제품의 바른 사용을 위해, 이 사용설명서를 잘 읽어 주십시오.
잘 보관하시어 필요하실 때마다 읽어주시기 바랍니다.
- Перед началом эксплуатации просим прочитать настоящую инструкцию внимательно и хранить ее на пользование на будущее.

Safety Information

■ Read the operating instructions for the unit and all other components of your car audio system carefully before using the system. They contain instructions about how to use the system in a safe and effective manner. Panasonic assumes no responsibility for any problems resulting from failure to observe the instructions given in this manual.

■ This manual uses pictographs to show you how to use the product safely and to alert you to potential dangers resulting from improper connections and operations. The meanings of the pictographs are explained below. It is important that you fully understand the meanings of the pictographs in order to use this manual and the system properly.



Warning

This pictograph intends to alert you to the presence of important operating instructions and installation instructions. Failure to heed the instructions may result in severe injury or death.



Caution

This pictograph intends to alert you to the presence of important operating instructions and installation instructions. Failure to heed the instructions may result in injury or material damage.

Warning

Observe the following warnings when using this unit.

- ❑ **The driver should neither watch the display nor operate the system while driving.**
Watching the display or operating the system will distract the driver from looking ahead of the vehicle and can cause accidents. Always stop the vehicle in a safe location and use the parking brake before watching the display or operating the system.
- ❑ **Use the proper power supply.**
This product is designed for operation with a negative grounded 12 V DC battery system. Never operate this product with other battery systems, especially a 24 V DC battery system.
- ❑ **Protect the Deck Mechanism.**
Do not insert any foreign objects into the slot of this unit.
- ❑ **Do not disassemble or modify the unit.**
Do not disassemble, modify the unit or attempt to repair the product yourself. If the product needs to be repaired, consult your dealer or an authorized Panasonic Service Center.
- ❑ **Do not use the unit when it is out of order.**
If the unit is out of order (no power, no sound) or in an abnormal state (has foreign objects in it, is exposed to water, is smoking, or smells), turn it off immediately and consult your dealer.
- ❑ **Refer fuse replacement to qualified service personnel.**
When the fuse blows out, eliminate the cause and have it replaced with the fuse prescribed for this unit by a qualified service engineer. Incorrect replacement of the fuse may lead to smoke, fire, and damage to the product.

Observe the following warnings when installing.

- ❑ **Disconnect the lead from the negative (–) battery terminal before installation.**
Wiring and installation with the negative (–) battery terminal connected may cause electrical shock and injury due to a short circuit.
Some cars equipped with the electrical safety system have specific procedures of battery terminal disconnection.
FAILURE TO FOLLOW THE PROCEDURE MAY LEAD TO THE UNINTENDED ACTIVATION OF THE ELECTRICAL SAFETY SYSTEM RESULTING IN DAMAGE TO THE VEHICLE AND PERSONAL INJURY OR DEATH.
- ❑ **Never use safety-related components for installation, grounding, and other such functions.**
Do not use safety-related vehicle components (fuel tank, brake, suspension, steering wheel, pedals, airbag, etc.) for wiring or fixing the product or its accessories.
- ❑ **Installing the product on the air bag cover or in a location where it interferes with airbag operation is prohibited.**
- ❑ **Check for piping, gasoline tank, electric wiring, and other items before installing the product.**
If you need to open a hole in the vehicle chassis to attach or wire the product, first check where the wire harness, gasoline tank, and electric wiring are located. Then open the hole from outside if possible.
- ❑ **Never install the product in a location where it interferes with your field of vision.**
- ❑ **Never have the power cord branched to supply other equipment with power.**
- ❑ **After installation and wiring, you should check the normal operation of other electrical equipment.**
The continuation of their using in abnormal conditions may cause fire, electrical shock or a traffic accident.
- ❑ **In the case of installation to an airbag-equipping car, confirm warnings and cautions of the vehicle manufacturer before installation.**
- ❑ **Make sure the leads do not interfere with driving or getting in and out of the vehicle.**
- ❑ **Insulate all exposed wires to prevent short circuiting.**

Caution

Observe the following cautions when using this unit.

- ❑ **Keep the sound volume at an appropriate level.**
Keep the volume level low enough to be aware of road and traffic conditions while driving.
- ❑ **Do not insert or allow your hand or fingers to be caught in the unit.**
To prevent injury, do not get your hand or fingers caught in moving parts or in the disc slot. Especially watch out for infants.
- ❑ **This unit is designed for use exclusively in automobiles.**
- ❑ **Do not operate the unit for a prolonged period with the engine turned off.**
Operating the audio system for a long period of time with the engine turned off will drain the battery.
- ❑ **Do not expose the unit to direct sunlight or excessive heat.**
Otherwise these will raise the interior temperature of the unit, and it may lead to smoke, fire, or other damage to the unit.
- ❑ **Do not use the product where it will be exposed to water, moisture, or dust.**
Exposure of the unit to water, moisture, or dust may lead to smoke, fire, or other damage to the unit. Make especially sure that the unit does not get wet in car washes or on rainy days.
- ❑ **Set the volume level to low enough before the AUX connection is completed.**
Failure to observe this, the loud noise may come out and damage your speakers and your hearing. Direct connection of the speaker/headphone output of an external device without any attenuator may distort sound or damage the connected external device.

Observe the following cautions when installing.

- ❑ **Refer wiring and installation to qualified service personnel.**
Installation of this unit requires special skills and experience. For maximum safety, have it installed by your dealer. Panasonic is not liable for any problems resulting from your own installation of the unit.
- ❑ **Follow the instructions to install and wire the product.**
Not following the instructions to properly install and wire the product could cause an accident or fire.

- ❑ **Take care not to damage the leads.**

When wiring, take care not to damage the leads. Prevent them from getting caught in the vehicle chassis, screws, and moving parts such as seat rails. Do not scratch, pull, bend or twist the leads. Do not run them near heat sources or place heavy objects on them. If leads must be run over sharp metal edges, protect the leads by winding them with vinyl tape or similar protection.

- ❑ **Use the designated parts and tools for installation.**
Use the supplied or designated parts and appropriate tools to install the product. The use of parts other than those supplied or designated may result in internal damage to the unit. Faulty installation may lead to an accident, a malfunction or fire.

- ❑ **Do not block the air vent or the cooling plate of the unit.**

Blocking these parts will cause the interior of the unit to overheat and will result in fire or other damage.

- ❑ **Do not install the product where it is exposed to strong vibrations or is unstable.**

Avoid slanted or strongly curved surfaces for installation. If the installation is not stable, the unit may fall down while driving and this can lead to an accident or injury.

- ❑ **Installation Angle**

The product should be installed in a horizontal position with the front end up at a convenient angle, but not more than 30°.

The user should bear in mind that in some areas there may be restrictions on how and where this unit must be installed. Consult your dealer for further details.

- ❑ **Wear gloves for safety. Make sure that wiring is completed before installation.**

- ❑ **To prevent damage to the unit, do not connect the power connector until the whole wiring is completed.**

- ❑ **Do not connect more than one speaker to one set of speaker leads. (except for connecting to a tweeter)**

CAUTION:

- **PLEASE FOLLOW THE LAWS AND REGULATIONS OF YOUR STATE, PROVINCE OR COUNTRY FOR WIRING, INSTALLATION, AND USE OF THIS UNIT AND THE DEVICES TO BE CONNECTED.**

Safety Information (continued)

⚠ Caution

THIS PRODUCT IS A CLASS I LASER PRODUCT.
USE OF CONTROLS OR ADJUSTMENTS OR PERFORMANCE
OF PROCEDURES OTHER THAN THOSE SPECIFIED HEREIN
MAY RESULT IN HAZARDOUS RADIATION EXPOSURE.
DO NOT OPEN COVERS AND DO NOT REPAIR BY YOUR-
SELF. REFER SERVICING TO QUALIFIED PERSONNEL.



This system is designed so that you cannot see moving pictures while you are driving.

- Park your car in a safe place and pull the side brake (parking brake) lever before watching the monitor.
- A rear monitor (option) displays moving pictures while driving.

Note:

- Be sure to connect the side brake (parking brake) connection lead. (⇒ Installation Instructions)

Notes on Use

Liquid Crystal Panel

- Do not cause impact to the liquid crystal panel.
- Usage temperature range: 0 °C to 40 °C
When the temperature is very cold or very hot, the image may not appear clearly or may move slowly. Also, movement of the image may seem to be out of synchronization or the image quality may decline in such environments. Note that this is not a malfunction or problem.
- In order to protect the liquid crystal panel, keep it out of direct sunlight while the unit is not in use.
- Sudden changes in the temperature inside the car such as those which occur immediately after the car's air conditioner or heater has been turned on may cause the inside of the liquid crystal panel to cloud over due to water vapor or it may cause condensation (droplets of water) to form and, as a result, the panel may not work properly. Do not use the unit while these symptoms are in evidence but leave the unit standing for about an hour, and then resume or start use

Before Reading These Instructions

Differences Among 4 Models

This operating instruction manual is for 4 models CQ-VD5005W2/CQ-VD5005W3/CQ-VD5005W4 and CQ-VD5005W5.

The following table shows the playable region number for each model.

Model	Playable region number
CQ-VD5005W2	2 (ALL)
CQ-VD5005W3	3 (ALL)
CQ-VD5005W4	4 (ALL)
CQ-VD5005W5	5 (ALL)

Example:

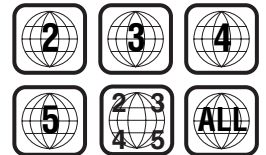

“Before Disc Playback”
(⇒ page 16)

Components



1. Main Unit
(LCD monitor/DVD player)

Qty.: 1



2. Operating Instructions
<YFM284C684ZA>

Qty.: 1



3. Installation Instructions
<YFM294C104ZA>

Qty.: 1

4. Installation Hardware (screws, cords, etc.)
(⇒ Installation Instructions)

Note:

- The number in parenthesis underneath each accessory part name is the part number for maintenance and service.
- Accessories and their parts numbers are subject to modification without prior notice due to improvements.

Features

Panasonic welcomes you to our constantly growing family of electronic products owners.

We endeavor to give you the advantages of precise electronic and mechanical engineering, manufactured with carefully selected components, and assembled by people who are proud of the reputation their work has built for our company. We know this product will bring you many hours of enjoyment, and after you discover the quality, value and reliability we have built into it, you too will be proud to be a member of our family.

■ Integration of the monitor, FM/AM radio, DVD Video/Video CD player and CD/MP3/DivX player

■ Built-in AV Input/Output Terminals

For more convenient connection and setup, all terminals are now provided on the unit itself.

Note:

- If a non-Panasonic product is connected to this unit, we do not guarantee the operations of the product.

■ SQ (Sound Quality)

You have 6 preset modes (Flat, Rock, Pop, Vocal, Jazz, Club). You can customize your setting for these (except Flat) and save them for instant recall.

SQ3 (3-Band Sound Quality)

Center frequency and level are adjustable in each of 3 bands. This lets you fine-tune sound quality for each genre to suit car-interior acoustics and your personal preferences. (⇒ page 35)

■ GUI (Graphic User Interface)

GUI displays various indications with colorful symbols to enhance visibility, enjoyment, and operability.

■ Disc type auto-detection

The signal auto-detection function of this unit allows users to be free from selection between PAL and NTSC before use of your discs. (For output signal, set TV Type). (⇒ page 36))

■ Touch Panel Operation

Simply touch the screen lightly to operate virtually all functions. Easy-to-use menus and icons let you “touch and choose” what you want, so you can start using your system from the very first day. That also means that while you drive, you can concentrate on the road.

■ DVD-R, DVD-RW Playback (⇒ page 16, 44 for details)

■ ID code

4-digit ID code for increased security.

Fill in the ID code memo (⇒ page 42).

Contents



English	2
한국어	48
Русский	94

<input type="checkbox"/> Safety Information	2
<input type="checkbox"/> Notes on Use	5
<input type="checkbox"/> Before Reading These Instructions	5
<input type="checkbox"/> Components	5
<input type="checkbox"/> Features	6
<input type="checkbox"/> Contents	7
<hr/>	
<input type="checkbox"/> Preparation	8
Settings, symbols used in this manual	
<input type="checkbox"/> Name of Controls and Functions	10
<input type="checkbox"/> Anti-Theft System	11
<input type="checkbox"/> Touch Panel Operation Overview	12
<hr/>	
<input type="checkbox"/> General	14
Power on/power off, display open/close, source selection, volume, mute, tilt angle, folding down the display temporarily	
<input type="checkbox"/> Before Disc Playback	16
<input type="checkbox"/> Disc Player	18
<input type="checkbox"/> Notes on MP3/DivX	22
<input type="checkbox"/> Radio	24
<input type="checkbox"/> TV Tuner Control	26
<input type="checkbox"/> AV1/AV2	28
<hr/>	
<input type="checkbox"/> Settings	30
Setup operation	
User, screen, audio, DVD, radio	
<hr/>	
<input type="checkbox"/> About DivX VOD Content	38
<input type="checkbox"/> Troubleshooting	39
<input type="checkbox"/> Maintenance	43
<input type="checkbox"/> Notes on Discs	44
<input type="checkbox"/> Language Code List	45
<input type="checkbox"/> Definition of Terms	46
<input type="checkbox"/> Specifications	47

Preparation

Settings

User (user settings) (⇒ page 32)

clock, ID code, input select, memory clear, other

Screen (screen settings) (⇒ page 34)

dimmer, picture, aspect

Audio (audio settings) (⇒ page 35)

SQ3, bass/treble, balance/fader

DVD (DVD settings) (⇒ page 36)

language, display, down mix, dynamic range compression, DivX registration

Radio (radio settings) (⇒ page 37)

FM set up

Note:

- Refer to “Settings” (⇒ page 30) for further information about operations, settings, and others of the menu screen.

You may need to set the following depending on the devices to be connected.

AV1/AV2 (Camcorder, VCR, etc.)

- Adjust **Input Select**. (⇒ page 33)

⚠ Warning

- When you connect external devices to AV1 IN/AV2 IN (AV1/AV2), be sure to connect the side brake connection lead (⇒ Installation Instructions).

Symbols used in this manual

Pictographs

You can perform some operations of this unit in one or more methods with the touch panel or remote control. This book explains such operations in tabular form as follows. Refer to the following for the pictographs located in the upper part of each table.



Compatible types of disc

The discs compatible with the targeted operation.



Operation on the Touch Panel

You can use the touch panel to perform the targeted operation. If the operation is not executable with the touch panel, “—” is displayed.



Operation on the Main Unit

You can use the Main Unit to perform the targeted operation. If the operation is not executable with the Main Unit, “—” is displayed.

Disc Marks

The following pictographs are used for the descriptions of disc operation. (→ page 17-21)

: DVD

: VCD (Video CD)

: CD

: CD-Rs/RWs containing MP3 files

: CD-Rs/RWs or DVD-Rs/RWs containing DivX files

Name of Controls and Functions

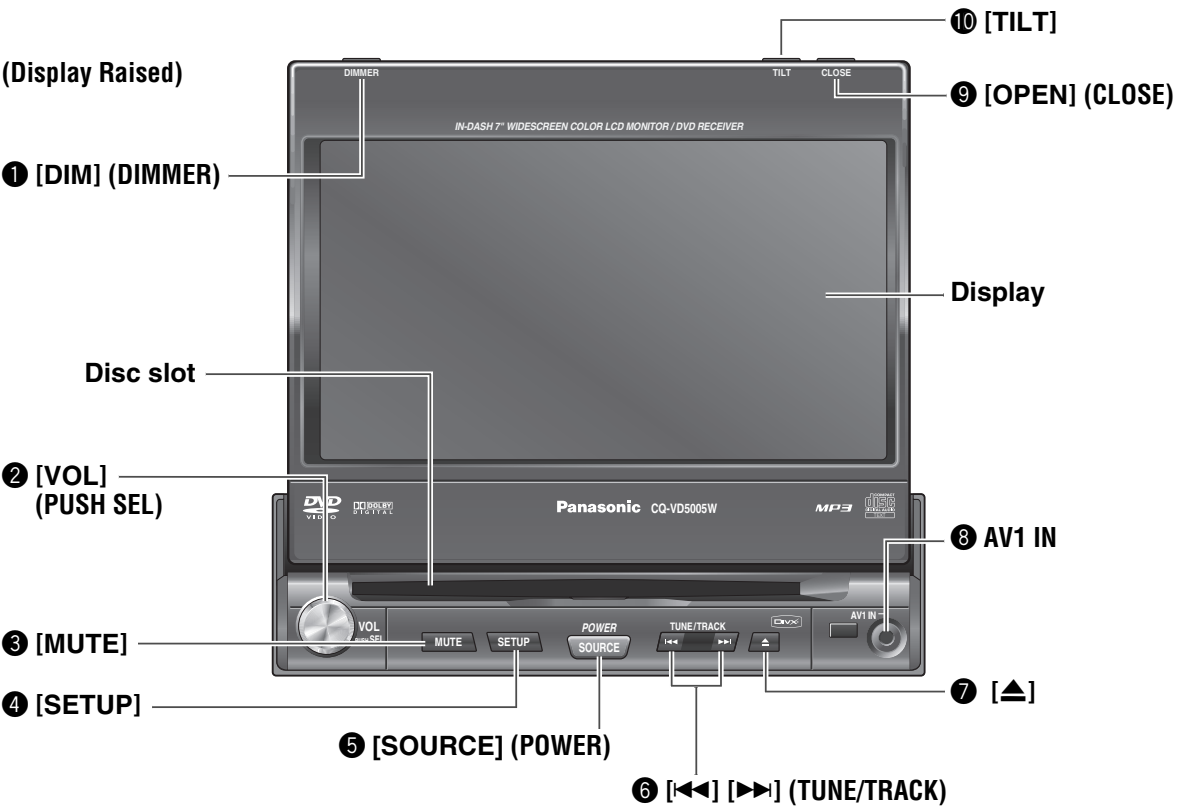

- | | |
|--|---|
| <p>1 [DIM] (DIMMER)</p> <ul style="list-style-type: none"> • The screen brightness is toggled between the set level and maximum luminance. <p>2 [VOL] (PUSH SEL)</p> <ul style="list-style-type: none"> • Adjusts the sound volume. • Adjusts audio settings. <p>3 [MUTE]</p> <ul style="list-style-type: none"> • Mutes the sound temporarily. <p>4 [SETUP]</p> <ul style="list-style-type: none"> • Shows the setup screen. <p>5 [SOURCE] (POWER)</p> <ul style="list-style-type: none"> • Switches on/off the power. • Changes the modes such as sound and picture. <p>6 [TUNE/TRACK]</p> <ul style="list-style-type: none"> • Selects or searches for a track, file, station. • Fast forward/fast reverse. • Slow playback ([▶▶]). | <p>7 [▲]</p> <ul style="list-style-type: none"> • Ejects/reloads a disc. <p>8 AV1 IN</p> <ul style="list-style-type: none"> • From line output of external audio/video device. (⇒ Installation Instructions) <p>9 [OPEN] (CLOSE)</p> <ul style="list-style-type: none"> • Opens/closes the monitor. <p>10 [TILT]</p> <ul style="list-style-type: none"> • Adjusts the monitor position. • Tilts the monitor forward temporarily. |
|--|---|

Note:

- A disc is in the slot when this is illuminated in blue.
- From line output of external audio/video device. (⇒ Installation Instructions)

Anti-Theft System

This unit is equipped with a removable face plate. Removing this face plate makes the unit totally inoperable.



Removable face plate

Remove the Face Plate

- 1 Switch off the power of the unit.
- 2 Hold the top and bottom of the center part of the face plate and pull it down toward you.
- 3 Pull the face plate toward you.
- 4 Place the face plate into the case and take it with you when you leave the car.

Install the Face Plate

- 1 Engage the right and left concave parts (A) on the lower rear side of the face plate with the convex parts (B) of the main unit.
- 2 Raise and press the face plate toward the main unit until a click is heard while engaging (A) with (B).

Face Plate Removal Alarm

This alarm sounds to warn you not to forget to remove the face plate before leaving your car.

This function is activated when **Security Alarm** is set to **On**. (→ page 33)

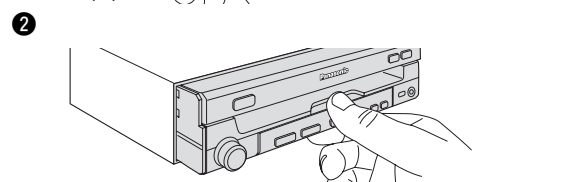
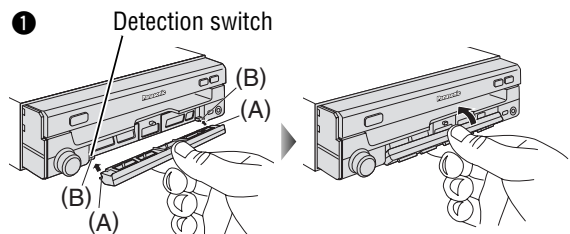
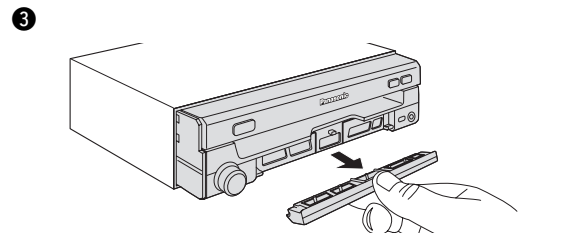
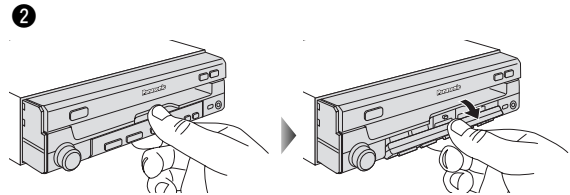

⚠ Caution

- Be sure to follow the procedure mentioned above to mount the face plate appropriately. Improper mounting such as forcible mounting without engaging the concave parts with the convex parts may cause trouble.
- Use caution not to damage the detection switch while mounting the face plate. Failure to observe this may cause trouble.
- Use caution not to apply excessive force to the removed face plate when the plate is carried or stored. Failure to observe this may cause trouble. It is recommended not to put the removed face plate into the pocket directly but to use the optional storage case (YEFA134269). (For the optional storage case, ask your dealer.)
- This face plate is not waterproof. Do not expose it to water or excessive moisture.
- Do not remove the face plate while driving your car.
- Do not place the face plate on the dashboard or nearby areas where the temperature rises high.

Touch Panel Operation Overview

Notes on the Touch Panel

Before operation

- Clean the surface of the touch panel. (⇒ page 43)

Operation

- Use only your fingers to operate the touch panel.
- Do not press the panel forcefully.
- Do not scratch the panel with fingernails or any hard objects.

- Do not use a pen or other sharp implements to operate the touch panel.
- Do not bump the front panel.
 - ⇒ Failure to observe the above may damage or break the glass on the surface of the touch panel.

The State of Operation Screen

Example: DVD mode

Note:

- The following picture is partly darkened for explanation.
- Displaying contents and their positions partly vary with each mode. Refer to the description of each mode for details.

Aspect Button (⇒ page 34)
(only for video source)

Current mode

Disc indicator (⇒ page 17)
(Lights when a disc is loaded)

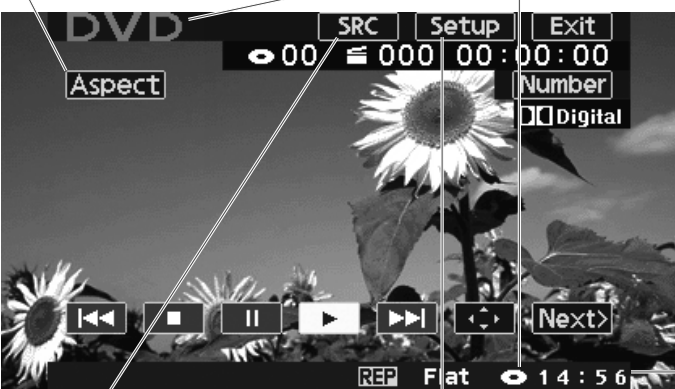

Prohibition

Input is not possible because the user has attempted to perform an operation which is not supported by the disc contents.

Clock time (⇒ page 32)

SRC Source Button
(Content varies with each source)

Setup Setup Button

Displays the Source Selection Screen.

Displays the Setup Screen.

Source Selection Screen

Setup Screen

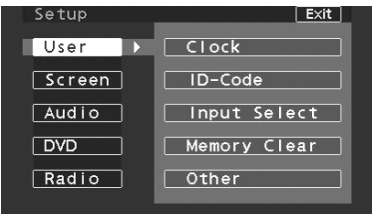
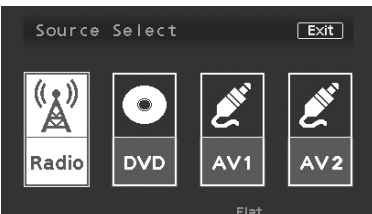

Source Selection Screen appears.
Touch desired source button.
Touch **Exit** to quit.

Setup Screen appears. Select desired setting.
Setup menu, (⇒ page 30)

Press **[SOURCE]** to change to desired source.

Press **[SETUP]** to let Setup Screen appear.

Note:

- The screen above appears when no external device is connected to AV1, AV2.

Switching the Display

Note:

- Refer to the instructions of each source.

Audio Source

□ CD

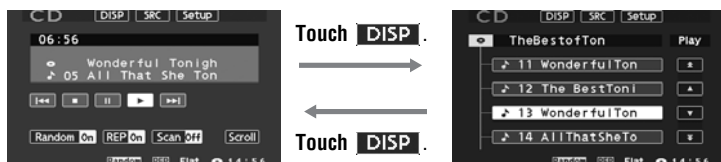

Operation Screen

List Screen

□ MP3

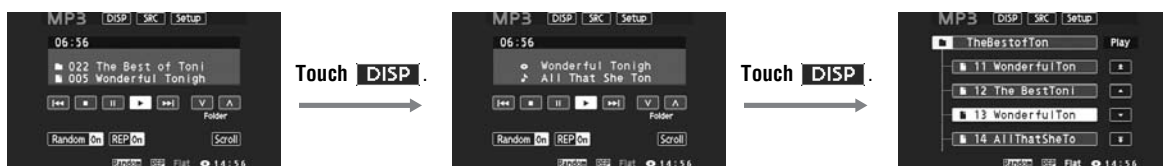

Operation Screen 1 (folder/file name)

Operation Screen 2 (ID3 tag)

List Screen

Touch **DISP**.

Video Source

Note:

- To switch Operation Screen on, touch the center of touch panel. (Touch **Exit** to cancel)
- If no operation takes place for more than 10 seconds when Operation Screen is ON, Operation Screen is turned off.

□ DVD



Operation Screen 1

Operation Screen 2

Operation Screen 3

□ DivX



Operation Screen 1

Operation Screen 2

List Screen

Touch **DISP**.

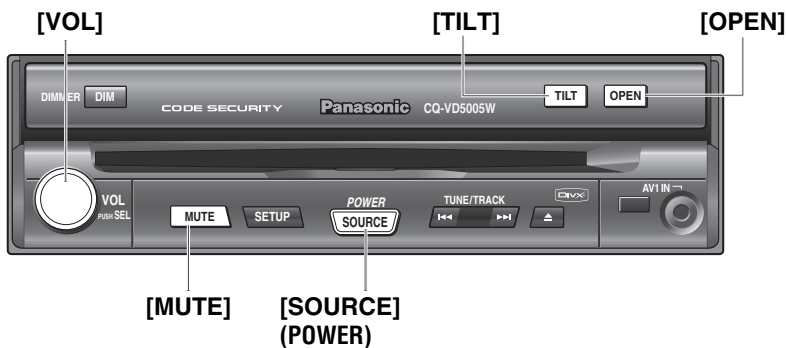





Preparation: Turn your car's ignition key to the ACC or ON position.

General Operations			
Operations			
Power ON :	-	[SOURCE]	
Power OFF :	-	[SOURCE]	
Display Open/Close	-	[OPEN]	<ul style="list-style-type: none"> ● Press once to open. Press again to close. <p>Note:</p> <ul style="list-style-type: none"> ● When the display is opened or closed, a loud beep sounds three times. ● If the unit stops halfway, press [OPEN] again to draw it all the way out. ● Opening/closing the display can be done when the power is off.
Source selection	(⇒ page 12)	[SOURCE]	<div style="border: 1px solid gray; padding: 5px; margin-bottom: 5px;"> <p style="text-align: center;">RADIO (AM/FM) (⇒ page 24)</p> <p style="text-align: center;">↓</p> </div> <div style="border: 1px solid gray; padding: 5px; margin-bottom: 5px;"> <p style="text-align: center;">DVD (DVD/VCD (Video CD)/CD/MP3/DivX) (⇒ page 18)</p> <p style="text-align: center;">↓</p> </div> <div style="border: 1px solid gray; padding: 5px;"> <p style="text-align: center;">AV1/AV2 (⇒ page 28)</p> </div> <p>Note:</p> <ul style="list-style-type: none"> ● If there is no external sources connected, AV1/AV2 mode can be set to skip. (⇒ page 33)
Volume	-	<p>① Up ② Down</p> <p>Setting range: 0 to 40, default: 13</p> <p>Note:</p> <ul style="list-style-type: none"> ● The volume level can be set independently for each source and each disc format. 	

..... Touch/Press and hold for more than 2 seconds

General Operations (continued)

Operations			
Mute	–	[MUTE]	Mutes the sound. To cancel, press again.
Tilt Angle	–	[TILT]	<ol style="list-style-type: none"> Press and hold for more than 2 seconds.
	 or 		<ol style="list-style-type: none"> Touch to adjust. <p>Setting range: 1 to 5 default: 5</p>
	<div style="border: 1px solid black; padding: 2px; display: inline-block;">AUTO</div>	–	the monitor is opened automatically when turning ON ACC.
<div style="border: 1px solid black; padding: 2px; display: inline-block;">MANUAL</div>	–	the monitor is not opened automatically. default: MANUAL	
<div style="border: 1px solid black; padding: 5px;"> <p>Warning</p> <ul style="list-style-type: none"> Do not touch the unit while the display is moving. Inserting hands, fingers or foreign objects into the unit can cause injuries and damage to the unit. </div>			
<p>Note:</p> <ul style="list-style-type: none"> Vertical angle (TILT) is saved in the memory, so when the display is drawn out next, it is automatically set at the angle and in the position adjusted before. After adjusting its angle, also adjust the brightness as well. (→ page 34) The car model and installation conditions may impose some restrictions on the adjustment of the monitor's angle. 			
Folding Down the Display Temporarily	–	[TILT]	To raise the display, press again.
<p>Note:</p> <ul style="list-style-type: none"> Even when the unit power is off, you can fold down the display temporarily. 			
<div style="border: 1px solid black; padding: 5px;"> <p>Caution</p> <ul style="list-style-type: none"> Avoid physical shock to the monitor. Do not place any object on the display, or subject it to undue force. Do not move the display forcibly. The monitor movable range may be limited by the type of car, the position where the display is mounted, etc. </div>			

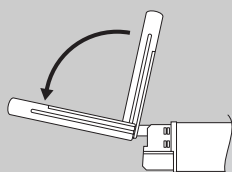
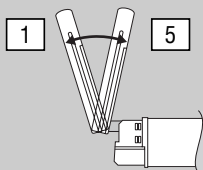

Before Disc Playback

Discs that can be Played Back

Disc Type

DISC	DVD	VCD (Video CD)	CD	CD-R/RW
Mark/logo		 (IEC62107)	 	
Disc Size	12 cm			
Video Format	NTSC / PAL			
Audio Format	LPCM, MPEG1, MPEG2, Dolby Digital	LPCM (CD-DA*1), MPEG1, MPEG2 (SVCD)	LPCM (CD-DA*1), MP3	
Region No.	2, 3, 4, 5, ALL*2			

*1 CD-DA : A general music CD format.

Note:

- Only discs with logos shown in the “Mark/logo” row of the table above are playable.
- About CD-Rs and CD-RWs, refer to “Notes on CD-Rs/RWs, DVD-Rs/RWs”. (⇒ page 44)
- Some copy-protected music CDs are not playable.
- Even if you play a dts DVD or a dts CD, analog sound cannot be reproduced.

Notes on DVD-Rs/RWs

- Do not mix DVD-Video formatted data and other formatted data on the same disc.
- **Discs in the video recording (VR) format are unplayable.**
- **Unfinalized discs are unplayable.**
- Use disc-at-once recording for DVD-R DL (double-layer).
- Some discs are unplayable depending on the disc itself, device, drive and software that are used for disc recording.

Discs not supported

The following discs are not played back on this product.

- DVD-Audio
- DVD-ROM
- DVD-RAM
- DVD+R
- DVD+RW
- VSD
- CVD
- CD-G
- CD-ROM (except MP3)
- CD-RW (except MP3/DivX and CD-DA)
- CD-R (except MP3/DivX and CD-DA)
- SACD
- Photo CD
- CDV
- Hybrid SACD (except CD-DA)
- CD-EXTRA (audio-only playback possible)
- DVDs with a region number other than “2”, “3”, “4”, “5” or “ALL”*2
- **Playing back a photo CD disc with this unit could damage the data that is recorded on the disc.**

About DivX

- DivX files recorded on CD-Rs/RWs and DVD-Rs/RWs are playable. Refer to “Notes on MP3/DivX” for further information. (⇒ page 22)

Symbols used on jackets

(Examples of such symbols include)

- : Number of subtitle languages
- : Number of audio tracks
- : Number of angles

The numbers indicate the number of languages, tracks, angles, etc., recorded on the disc.

Screen size (H:V aspect ratio)

- : 4:3 standard size
- : Letterbox (⇒ page 36)
- 16:9 wide size
- : Playback in letterbox format on a standard screen (4:3).
- : Playback in (pan and scan) (⇒ page 36) format on a standard screen (4:3).

Note:

- The size of the image that is displayed on the screen depends on the screen mode (⇒ page 34), and on the screen size for the content on the disc.

Region Management Information

This product is designed and manufactured to respond to the Region Management Information that is recorded on a DVD disc. If the Region number described on the DVD disc does not correspond to the Region number of this product, this product does not play the disc.

*2The Region number for this product is “2” (for CQ-VD5005W2), “3” (for CQ-VD5005W3), “4” (for CQ-VD5005W4), “5” (for CQ-VD5005W5) or “ALL”.

Example:



Disc Insert/Eject

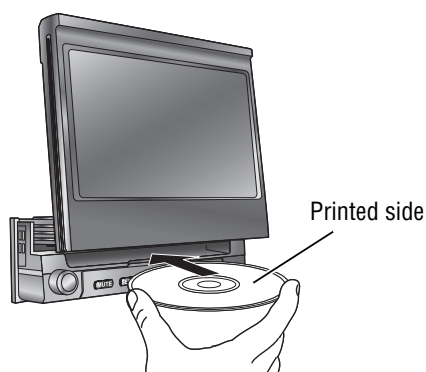

⚠ Caution

- When the disc is inserted or ejected, to prevent disc scratches never exert any downward force on the disc.

■ When a disc is in the player...



Do not insert a disc when the eject button  lights because a disc is already loaded.

Disc Insert

- The mode that supports the disc is selected, and playback starts.

- The audio format is automatically identified. (⇒ page 16)
- When the menu screen appears, see “Chapter/title Selection” on page 20.

When a disc is in the player, change to disc player mode (CD, MP3, DivX, DVD or VCD (Video CD)) and playback starts.

Note:



- Do not insert a disc when the eject button  lights because a disc is already loaded.
- The power will be turned on automatically when a disc is loaded.
- You can play a disc even if the monitor is closed.

- The sound may be interrupted for a few moments while the audio format is being identified.

⚠ Caution

- Do not use irregularly shaped discs.
- Do not insert foreign object into the disc slot.
- This unit does not support 8-cm disc. In case of load such a disc, eject and remove the disc from the slot immediately.

Disc Eject

Press  to stop playback and eject the disc. (Press  again to reload the disc.)

Note:

- If you leave a disc in the slot for more than 30 seconds after its ejection, the disc will be automatically reloaded after loud beep is energized three times.

- Due to limitations of certain discs, some DVD and VCD (Video CD) discs may not operate as described in this manual. Refer to the disc jacket for further details.
- This unit does not support DVD and VCD (Video CD) karaoke functions.

Disc Player

Source Selection

1 Touch "Source Button".

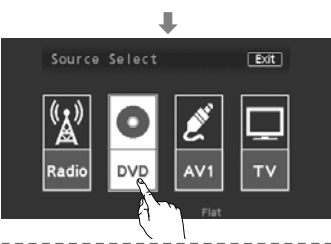

2 Touch **DVD** (DVD) on the Source Selection Screen.

Press **[SOURCE]** to change to the desired mode.

To switch Operation Screen ON, touch the center of touch panel. (Only for Video Mode)

Source Button



[SOURCE]

Repeat/random indicator

[<<<] [>>>]

Video Mode Display

DVD

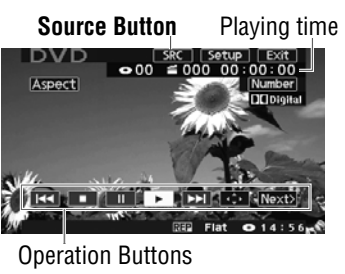

VCD (Video CD)

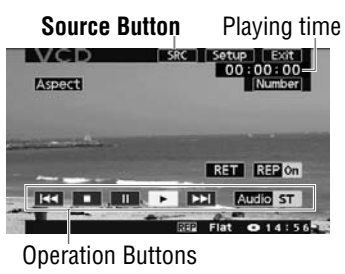

DivX

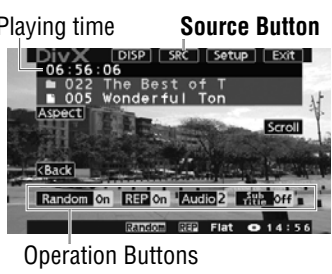

Audio Mode Display

MP3



Note:
• Touch **[DISP]** to change the display. (→ page 13)

List (Folder/File/Track) Selection



(Example: MP3 mode)

- : Folder
- : MP3/DivX file











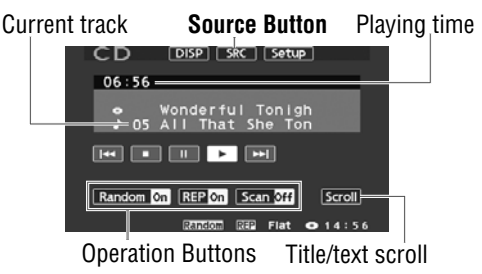













































- 1 Touch **TheBestofTon** (folder name) to select a folder.
 , : scrolls up/down the file list by 1 page.
 , : scrolls up/down the file list by 1 line.
- 2 Touch **11 WonderfulTon** (file name) to play.

Note:



- **[<<<]** and **[>>>]** of the main unit can scroll up and down the file list by 1 page, respectively, too.
- It is not possible to display the whole tree and file list in a folder.
- The displayed contents on the touch panel vary with circumstances.

CD





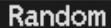







Basic Operations				
Operations	Compatible Discs	Operations		
				
Track/file Selection	  	 	 	Next track/file Beginning of the current track/file Previous track/file (Touch/press twice.)
		Note: ● When playing a DVD, there are cases where it is not possible to return to the start of a chapter that spans 2 titles.		
Fast Forward/ Fast Reverse	  	 	 	Fast forward Release to resume playback. Fast reverse Release to resume playback.
		The speeds of fast forward and fast reverse change incrementally in 4 steps every time the corresponding button is pressed.		
Folder Selection		 	–	Next folder Previous folder
			–	Scrolls the title/text once
Stop	  		–	To resume playback, touch  .
Pause	  		–	To resume playback, touch again or touch  .
Slow Playback	 	 	 	● Touch/press and hold in the pause mode. Playback is at about 1/3 normal speed. To resume normal playback, touch  .
Repeat Play	  		–	To cancel, touch again.
Repeat Play within the Current Folder			–	To cancel, touch and hold for more than 2 seconds again.
Scan Play			–	To cancel, touch again.
Random Play	 		–	To cancel, touch again.
Random Play within the Current Folder			–	To cancel, touch and hold again.

 Touch/Press and hold

* Touch panel symbols will change to indicate these current mode.  ,  ( = folder)

Disc Player (continued)

To switch Operation Screen ON, touch the center of touch panel.

Chapter/title Selection		Operations		
Operations	Compatible Discs			
Showing menu and selecting an item *1 Note on VCD: For VCD, touch RET instead of DVD Menu .	 *1  *1	DVD Menu or RET *1	-	1 Menu appears.
		    Enter *2	-	2 Select the desired item. 3 Determine the setting.
		Exit	-	Returns to the previous display.
Starting Playback from a specific chapter/title Touch the numerical key to enter a number directly 	 *1  *1	Number ↓ 0 to 9 ↓ Enter	-	1 Toggles “Chapter number input mode”, “Title number input mode” and “Number input mode”. 2 Input desired number. 3 Playback starts.
		Note: • For retrying selection during number entry, touch Clear .		

Note:

- If no operation is performed for 8 seconds after you have touched **Number**, the operation buttons disappear.
- If the title/chapter number is inputted and no operation is performed for 8 seconds, playback will start from the number of the title/chapter entered.

***2 On-Screen Direct Operation (Only for DVD)**
 Some DVDs allow you to operate the DVD menu by touching the screen.

Showing Source button and Setup button
 Press **OSD**. The Source button and Setup button appear.

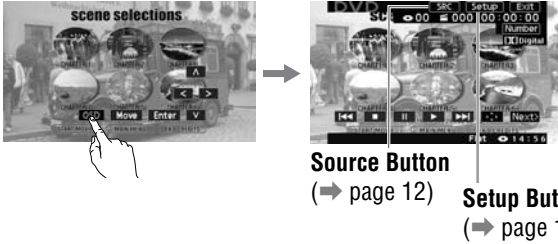

Moving operation buttons (Only for DVD)
 When the operation buttons interfere with operations, press **Move**. The buttons are transferred as shown below.

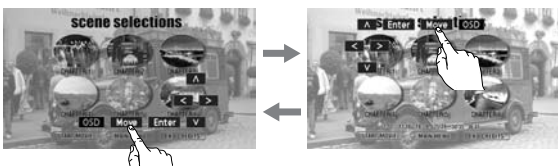

DVD mode display

Chapter/title selection
Fast forward/fast reverse



Useful Function

Operations	Compatible Discs	Operations		
Subtitle Language	 	Sub Title Off	—	<ul style="list-style-type: none"> ● Touch during playback. <p>It is possible to change the subtitle language during play if multiple languages are recorded on the disc.</p> <p>Note:</p> <ul style="list-style-type: none"> ● There may be a brief delay before the subtitles appear.
Audio Language	 	Audio B	—	<ul style="list-style-type: none"> ● Touch during playback. <p>It is possible to change the audio language during play if multiple audio languages are recorded on the disc.</p>
Angle		Angle 2	—	<ul style="list-style-type: none"> ● Touch during playback. <p>For DVDs which contain scenes which have been shot simultaneously from a number of different angles the same scene can be viewed from each of these different angles during play. (Angle Mark → page 36)</p>
Stereo & Monaural		Audio ST	—	<p>It is possible to switch the audio between stereo sound and monaural sound (L or R).</p> <div style="border: 1px solid black; padding: 5px;"> <pre> graph TD ST[ST] --> Lch[L-ch] Lch --> Rch[R-ch] ST --> Rch </pre> <p>ST : stereo sound</p> <p>L-ch : the left channel audio is output on both the left and right speakers.</p> <p>R-ch : the right channel audio is output on both the left and right speakers.</p> </div>

Note:

- If no operation is performed for 10 seconds or **Exit** is touched, the operation buttons disappear.
- It may not be possible to switch the language unless the unit is at the DVD menu (⇒ previous page) or is at the DVD settings. (⇒ page 36)
- The language on the DVD settings takes priority when the power is turned on or the disc is loaded.
- The number of languages and angles depend on the disc. Some discs have only one language/angle or have no language/angle.

Notes on MP3/DivX

What is MP3/DivX?

MP3*: MP3 (MPEG Audio Layer-3) is the compression format of digital audio. It is developed by MPEG (Motion Picture Experts Group). Using this compression format, you can record the contents of about 10 music CDs on a single CD (This figure refers to data recorded on a 650 MB CD-R or CD-RW at a fixed bit rate of 128 kbps and a sampling frequency of 44.1 kHz).

*MPEG Layer-3 audio coding technology licensed from Fraunhofer IIS and Thomson.

DivX: The video compression format developed by DivX, Inc. compresses video files without any considerable loss of video quality.

Note:

- MP3/DivX encoding and CD writing software programs are not supplied with this unit.

Points to remember when making MP3/DivX files

Common

- High bit rate and high sampling frequency are recommended for high quality sound.
- Selecting VBR (Variable Bit Rate) is not recommended because playing time is not displayed properly and sound may be skipped.
- The playback sound quality differs depending on the encoding circumstances. For details, refer to the instructions of your own encoding software and writing software.

MP3

- It is recommended to set the bit rate to "128 kbps or more" and "fixed".

DivX

- DivX files greater than 2GB or having no index may not play properly on this unit.
- This unit supports all resolutions up to maximum of 720 x 480 (NTSC)/720 x 576 (PAL).
- You can select up to 8 types of audios and subtitles on this unit.
- GMC (Global Motion Compensation) is not supported.

Caution

- **Never put ".mp3" to other than MP3-formatted data or ".DIVX", ".divx", ".AVI", and ".avi" to other than DivX-formatted data. This may not only produce noise from the speaker damage, but also damage your hearing.**

Display Information (on the Main Unit)

Displayed items

- | | |
|---|---|
| ● CD-TEXT
Disc title
Track title | ● MP3 (ID3 tag)
Album name
Title and artist name |
| ● MP3/DivX
Folder name
File name | |

Displayable characters

- Displayable length of file name/folder name: within 64 characters. (Unicoded file and folder names are reduced by half in the number of displayable characters.)
- Name files and folders in accordance with the standard of each file system. Refer to the instructions of writing software for details.
- ASCII character set can be displayed.
- Some Cyrillic characters in the Unicode can be displayed.

ASCII character set

A to Z, a to z, digits 0 to 9, and the following symbols:
(space) ! " # \$ % & ' () * + , - . / : ; < = > ? @ [\] ^ _ ` { | } ~

Note:

- With some software in which MP3/DivX format files have been encoded, the character information may not be displayed properly.
- Undisplayable characters and symbols will be converted into an asterisk (*).
- It is recommended that the length of the file name is less than 8 (excluding the file extension).

Recording MP3/DivX files on a CD/DVD-media

- It is recommended not to use a disc holding two or more different format types of files.
- If CD-DA files are on the same disc as MP3 or DivX files, the songs and the movies may not play in the intended order, or some songs or movies may not play at all.
- When storing MP3 data and DivX data on the same disc, use different folders for each data.
- Do not record files other than MP3/DivX files and unnecessary folder on a disc.
- The name of an MP3/DivX file should be added by rules as shown in the following descriptions and also comply with the rules of each file system.
- The file extension “.mp3” should be assigned to MP3 files.
- The file extension “.DIVX”, “.divx”, “.AVI” or “.avi” should be assigned to DivX files.
- You may encounter trouble in playing MP3/DivX files or displaying the information of MP3/DivX files recorded with certain writing software or CD/DVD recorders.
- This unit does not have a play list function.
- Although Multi-session recording is supported, the use of Disc-at-Once is recommended.

Supported file systems

ISO 9660 Level 1/Level 2, Apple Extension to ISO 9660, Joliet, Romeo

Note:

- Apple HFS, UDF 1.50, Mix CD and CD Extra are not supported.

Audio compression formats (Recommendation: “Points to remember when making MP3/DivX files” on the previous page)

Compression method	Bit rate	VBR	Sampling frequency
MPEG 1 audio layer 3 (MP3)	32 k – 320 kbps	Yes	32, 44.1, 48 kHz
MPEG 2 audio layer 3 (MP3)	8 k – 160 kbps	Yes	16, 22.05, 24 kHz
DivX data created using ver.3.11, 4.x, 5.x*	8 k – 320 kbps	Yes	8 k – 48 kHz

* DivX video system/MP2, MP3

Note:

- VBR is not recommended.

Folder selection order/file playback order

Maximum number of files/folders

- Maximum number of files: 999
- Maximum number of files in one folder: 999
- Maximum depth of trees: 8
- Maximum number of folders: 255 (Root folder is included.)

Note:

- You can shorten the duration between data read and playback by decreasing the quantity of files or folders, or the depth of the hierarchy.
- This unit counts the number of folders irrespective of the presence or absence of an MP3/DivX file.
- If the selected folder does not contain any MP3/DivX files, the nearest MP3/DivX files in the order of playback will be played.
- Playback order may be different from other MP3/DivX players even if the same disc is used.
- “ROOT” appears when displaying the root folder name.

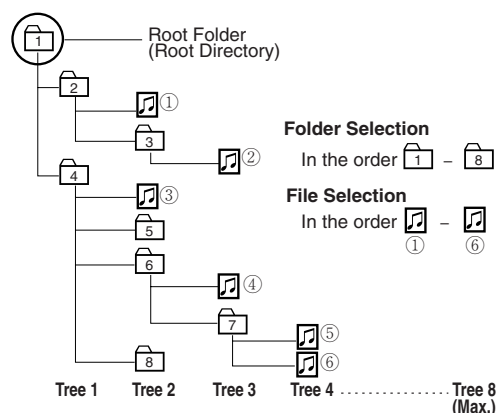

Copyright

It is prohibited by copyright laws to copy, distribute and deliver copyrighted materials such as music without the approval of copyright holder except enjoying yourself personally.

No warranty

The above description complies with our investigations as of December 2006. It has no warranty for reproducibility and displayability of MP3/DivX.

Radio

Source Selection

1 Touch "Source Button".

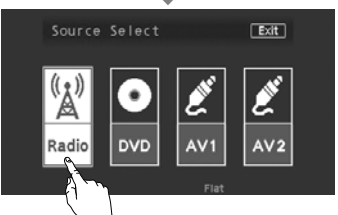

2 Touch **Radio** (RADIO) on the Source Selection Screen.

Press **[SOURCE]** to change to the desired mode.

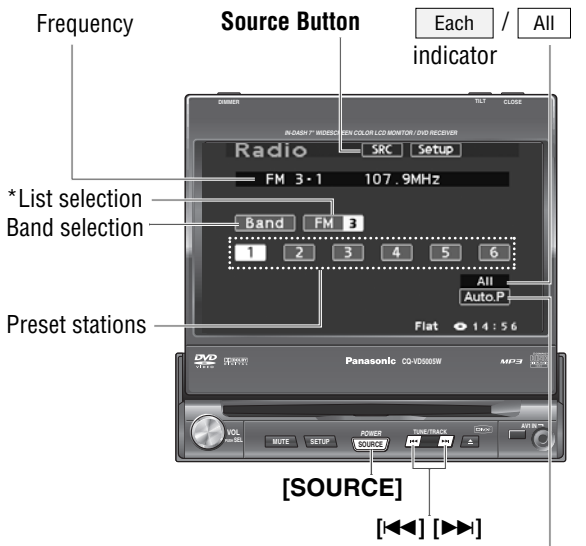



* Appears only when All is selected. (→ page 37)
 Setup ⇨ Radio ⇨ FM Setup ⇨ Auto Preset ⇨ Each / All

Tuning

Operations			
Band Selection	Band	-	
	Each	FM 1 → FM 2 → FM 3 → AM	
	All	FM → AM	
List Selection	<p>Preparation: Select <input checked="" type="checkbox"/> All. (→ page 37)</p> <p>Setup ⇨ Radio ⇨ FM Setup ⇨ Auto Preset ⇨ <input type="checkbox"/> Each / <input checked="" type="checkbox"/> All</p>		
	FM 1	-	
	FM 1 (list 1)	FM 2 (list 2) → FM 3 (list 3)	
	<p>There are 6 stations in each list. You can call up next 6 stations by switching from one list to another.</p>		
Station Selection	-	[▶▶] / [◀◀]	Up / Down
Seek Tuning	-	[▶▶] / [◀◀]	Up / Down
<p>Press and hold for more than 0.5 second then release. Seeking starts.</p>			

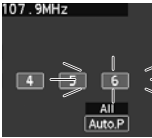
..... Press and hold

Preset Memory		
<h3>Manual Preset Memory</h3> <p>Up to 6 stations can be preset in each band.</p>	<p>Select a band and frequency.</p> <p>1 to 6</p>	 <p>blinks once</p> <ul style="list-style-type: none"> • Touch and hold for more than 2 seconds. • The frequency blinks once, and a receiving station is saved in the memory. New stations overwrite existing saved stations.
<h3>Auto Preset Memory</h3> <p>A <input type="text" value="Each"/></p> <p>Six stations are automatically preset in each band.</p>	<p>Preparation: Select <input type="text" value="Each"/>. (→ page 37) (default: <input type="text" value="Each"/>)</p> <p>Setup ⇨ Radio ⇨ FM Setup ⇨ Auto Preset ⇨ <input type="text" value="Each"/> / <input type="text" value="All"/></p> <p>Select a band.</p> <p>Auto.P</p>	<p>6 stations with first to 6th highest in signal strength of each band will be preset.</p> <ul style="list-style-type: none"> • Touch and hold for more than 2 seconds. • Once set, the preset stations are sequentially scanned for 5 seconds each. (scanning) <p>New stations overwrite existing saved stations.</p>
<p>B <input type="text" value="All"/></p> <p>In total 18 FM stations are automatically preset.</p>	<p>Preparation: Select <input type="text" value="All"/>. (→ page 37)</p> <p>Setup ⇨ Radio ⇨ FM Setup ⇨ Auto Preset ⇨ <input type="text" value="Each"/> / <input type="text" value="All"/></p> <p>Auto.P</p>	<p>18 stations with first to 18th highest in signal strength of all FMs will be preset at once.</p> <ul style="list-style-type: none"> • Touch and hold for more than 2 seconds. • Once set, the preset stations are sequentially scanned for 5 seconds each. (scanning) <p>New stations overwrite existing saved stations.</p>
<h3>Preset Station Calling</h3>	<p>Select a band or a list.</p> <p>1 to 6</p>	<ul style="list-style-type: none"> • Touch desired preset button.
<h3>Preset Swap</h3> <p>A station preset is interchangeable with another station preset.</p>	<p>Preparation: Select <input type="text" value="All"/>. (→ page 37)</p> <p>Setup ⇨ Radio ⇨ FM Setup ⇨ Auto Preset ⇨ <input type="text" value="Each"/> / <input type="text" value="All"/></p> <p>1 to 6</p>	<p>1 Select the list and the preset number that contains the station to be interchanged (see "Preset station calling" above).</p> <p>2 Select the list and hold down the preset number that contains the targeted channel for more than 2 seconds.</p> <p>The preset station selected in the step 1 is interchanged with the targeted preset channel selected in the step 2 (Preset Swap).</p>

 Touch and hold

TV Tuner Control

Preparation:

- Connect a TV tuner (CY-TUP133W/CY-TUN133W, option) to the unit.
- Select **TV** with use of "AV2 Input Selection". (→ page 33)

- It is required to install the TV antenna to receive TV broadcasts.
- For receiving TV broadcasts, stop your car where there is no obstacle to broadcast reception around.

Source Selection

1 Touch "Source Button".

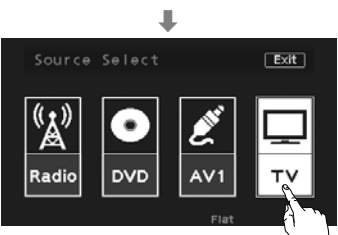

2 Touch **TV** (TV) on the Source Selection Screen. (Content varies with connected devices)

Press **[SOURCE]** to change to the TV mode.

To switch Operation Screen ON, touch the center of touch panel.

Note:

- CY-TUP133W/CY-TUN133W is an analog TV-specific tuner.
- If the analog broadcast system is replaced with the digital broadcast system in a country or area where CY-TUP133W/CY-TUN133W is used, TV broadcasts cannot be received.
- Inquire about the termination of analog broadcasting to

the authorities concerned in the country or area where CY-TUP133W/CY-TUN133W is used.



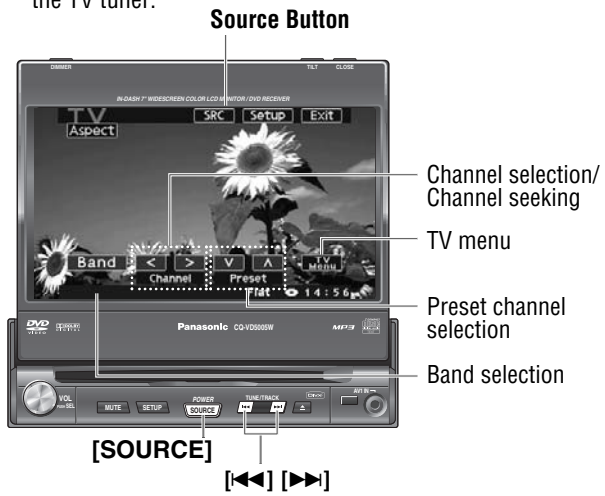











- For the operations of the TV tuner with its remote control, aim the remote control at the remote control sensor of this unit.
- The remote control of the TV tuner (CY-TUP133W/CY-TUN133W, option) cannot turn on or off the power of the TV tuner.



Tuning

Operations			
Band Selection	Band	-	
	TV 1 ↔ TV 2		
Channel Selection			Up
			Down
Channel Seeking			Up
			Down
Displaying TV Menu	TV Menu	-	Calls up the menu of the tuner. To cancel, touch again.
Selecting an Item on the TV Menu	 	-	Left/right Up/down

..... Touch/Press and hold

Preset Memory			
Operations			
Auto Preset Memory	12 channels with first to 12th highest in signal strength will be preset to each band. 	–	Select a band. <ul style="list-style-type: none"> ● Touch and hold for more than 2 seconds. ● “–” appears if the number of receivable channels is less than 12. New channels overwrite existing saved channels.
Writing Preset Memory Favorite preset channels can be written after you have set the preset channel once.	Select a band and a channel.  	–	<ul style="list-style-type: none"> ● Preset channel writing mode display appears.
	 	–	Select a channel that you want to exchange. Determine.
		–	<ul style="list-style-type: none"> ● Exit from the preset writing.
Preset Channel Calling	 	–	Down Up
Deleting Preset Memory Favorite preset channels can be deleted after you have set the preset channel once.	Select a band and a channel.  	–	<ul style="list-style-type: none"> ● Preset channel deleting mode display appears.
	 	–	Select a preset number that you want to delete. Determine.
		–	<ul style="list-style-type: none"> ● Exit from the preset channel deletion.

 Touch and hold for more than 2 seconds

AV1/AV2

Preparation:

- Connect an optional external device to the AV1/AV2.

Source Selection

You can view the images and listen to the sounds from the connected external devices in the AV1/AV2 mode respectively.

1 Touch "Source Button".

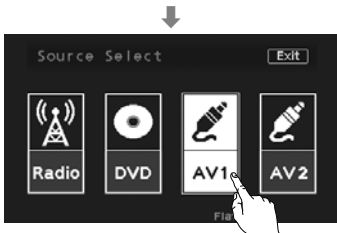

2 Touch **AV1 / AV2** (AV1/AV2) on the Source Selection Screen.

Press **[SOURCE]** to change to the desired mode.

To switch Operation Screen ON, touch the center of touch panel.

Note:

- You can set up the system so that the AV mode is not selected (source skip). ([Input Select] → page 33)
- If no operation is performed for 10 seconds or **Exit** is touched, the operation buttons disappear.
- Only the pin jack of the supplied Conversion Cable for AV 1 IN or a pin jack that has the same electrode arrangement can be connected to the AV 1 IN terminal. (See Fig. 1.)
- Use of the supplied Conversion Cable for AV 1 IN or an audio pin jack that has the same electrode arrangement also allows users to enjoy only music. In this case, the screen background becomes black.



<Fig. 1>

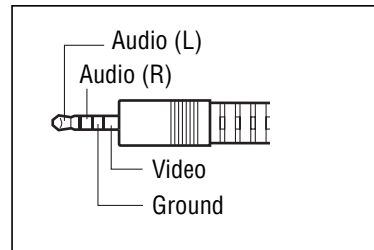

Settings

User

Clock
ID-Code
Input Select
Memory Clear
Other

User

Clock setting (→ page 32)
ID Code Setting (→ page 32)
AV1/AV2 Input Selection (→ page 33)
Memory clearance (→ page 33)
Other settings (→ page 33)

Screen

Dimmer
Picture
Aspect

Screen

Adjusting the brightness (→ page 34)
Display appearance (→ page 34)
Display aspect setting (→ page 34)

Audio

SQ3
Bass/Treble
Balance/Fader

Audio

SQ3 setting (→ page 35)
Bass/treble adjustment (→ page 35)
Balance/fader adjustment (→ page 35)

DVD

Language
Display
Down Mix
DR COMP
DivX Registration

DVD

Language Setting (→ page 36)
Appearance of DVD image (→ page 36)
Selection of type of down mix (→ page 37)
Selection of compression style (→ page 37)
DivX Registration (→ page 37)

Radio

FM Setup

Radio

Setting for FM stations (→ page 37)

□ Setup Operation

(Example: DVD mode)

1



Touch **Setup** in Operation Screen.

2

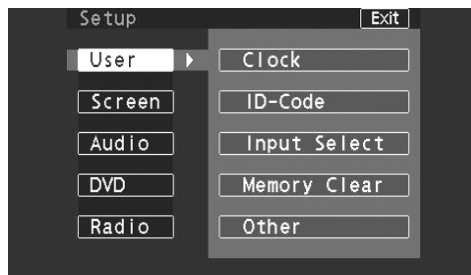

Touch desired setting.

3

(Example: setting screen of **Input Select** → page 33)



Back

Determines the setting and goes back to the previous menu out of the menu.

Exit

Determines the setting and gets out of the menu

Note:

- The display returns to the previous status if there is no operation for more than 60 seconds after changing to the setting menu.
- The item may not be temporarily selected depending on the current disc type or the state of this unit. In such a case, change the source to another one and try to set up the item again.

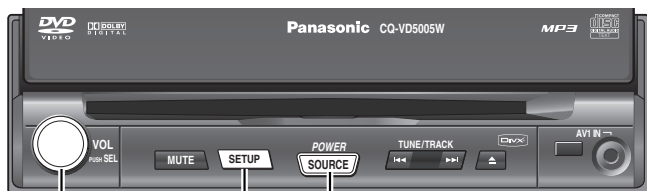

[VOL]
(PUSH SEL)

[SETUP]
(Shows the menu display/
Goes back to the previous menu)

[SOURCE]
(Exit from the menu)

[DIM] (DIMMER)

(The screen brightness is toggled between the set level and maximum luminance.)



Settings (continued)

User

Screen

Audio

DVD

Radio

Clock

Clock setting

Display

(Clock display)

On

: clock display ON (“- -: -” is displayed before adjusting the clock.)

Off

: clock display OFF

default: Off

Hour Adjust

(Hour adjustment)

<

: puts back hour

>

: puts forward hour

Minute Adjust

(Minute adjustment)

<

: puts back minute

>

: puts forward minute

Note:

- To start the clock, touch/press **Exit** / **[SOURCE]**.
- Set the Daylight Saving Time manually.

default: Hour Adjust: 0
Minute Adjust: 0

ID-Code

ID Code Setting

Prior to operating this unit, it is advisable to assign a 4-digit ID code for security. Once the ID code has been set, the unit cannot be operated if the main power supply is disconnected then re-connected. It is electronically locked so that a thief cannot use the stolen unit unless that person knows the code you have set.

The ID code operation must be performed only by the person to whom the unit belongs.

Generally, it is not necessary to enter the ID code each time when using the unit if it has not been disconnected from the main power supply (car battery).

0

to 9

4 digits numeric code

default: none

How to set your ID code (for the first time)

- ① Enter an 4 digit ID code.
- ② Enter the same 4 digit ID code again.

How to change your ID code

- ① Enter the preset (old) 4 digit ID code. If the wrong ID code is entered, a new ID code cannot be registered.
- ② Enter a new 4 digit ID code.
- ③ Enter the new 4 digit ID code again.

How to cancel the known ID code

- ① Enter the preset (old) 4 digit ID code. If the wrong ID code is entered, it is not possible to cancel the ID code function.
- ② Touch and hold **Off** until “Completed!” is displayed. The ID code cancelling procedure is completed. The unit now works without an ID code.

Note:

- Should your unit ever require service, cancel your ID code before sending for repair.
- The ID code setting cannot be eliminated even by the memory clear function.
- The inputted code is not displayed for your security.

⚠ Caution

- Record your registered ID code and keep it in a secure location. (Fill in the ID code memo (⇒ page 42).) If you forget it, you will be unable to use the unit. In case you forget the ID code, please consult your nearest Panasonic Service Center.

Input Select

AV1/AV2 input selection

AV1 (AV1 input selection)

AV1 : an external device is connected to AV1.

Skip : skips AV1.

default: **AV1**

AV2 (AV2 input selection)

AV2 : an external device is connected to AV2.

NAVI : car navigation system is connected to AV2.

TV : TV tuner is connected to AV2.

Skip : skips AV2.

default: **AV2**

Note:

- If a non-Panasonic navigation system is connected to this unit, we do not guarantee the operations of the navigation system.

Camera (Rear view camera set up)

Selection of the terminal that connects to the rear view camera.

Preparation: Connect the reverse lead. (→ Installation Instructions)

On : connected to the CAMERA IN

Off : unconnected

default: **Off**

Note:

- Make sure to select **Off** when no rear view camera is connected.
- The image from the rear view camera may be blurred in the night or a dark place.

Memory Clear

Memory clearance

The state of all of the current memories are returned to default settings.

Note:

- The ID code is not deleted by executing memory clear.

Yes : clears the memory to default settings

No : no memory clear.

The display returns to the previous one.

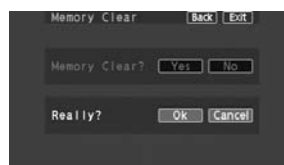

Really? appears when **Yes** is selected.

OK : proceed.

Cancel : no memory clear.

Caution

- Be aware that this setting restores the unit to default settings, so that all the memories and settings that you have set will be eliminated.

Other

Other settings

ACC Select (Setting ACC selection ON and OFF)

On : sets to ON if your car has ACC position.

Off : sets to OFF if your car has no ACC position.

default: **On**

Note:

- For an ACC-equipped car, select ON. The following functions are available.
 - The power is turned on automatically when inserting a disc or magazine.
 - **Off** selection disables turning on the power of the main unit through the remote control.

Caution

- Be sure to select off when your car has no ACC position in the ignition switch. Failure to do this could cause the battery to go dead.

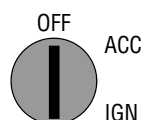

Security Alarm (Security Alarm)

On : activates the security alarm. (→ page 11)

Off : inactivates the security alarm.

default: **On**

Settings (continued)

User **Screen** (Display) Audio DVD Radio

33

Dimmer

Adjusting the brightness

1 2 3
 ← Darker Brighter →
 default: 1

Note:

- When [DIM] is pressed, the screen brightness is toggled between the set level that is adjusted by the procedure above and the maximum luminance.

Picture

Display appearance

Contrast (Adjust the image contrast)

- < : decreases the contrast between black and white.
- > : increases the contrast between black and white.

Bright (Adjust the image brightness)

- < : darkens.
- > : lightens.

Color (Adjust the image color depth)

- < : lightens the depth of color on the display.
- > : deepens the depth of color on the display.

Tint (Adjust the image tone or tint)

- < : emphasizes red in the color image.
- > : emphasizes green in the color image.

Note:

- When the video signal is PAL/SECAM format, adjustment cannot be performed.

Setting range: -15 to +15
 default: ±0

Aspect

Display aspect setting

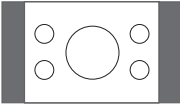
Normal

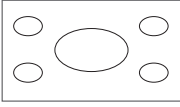
 • The conventional display image has a 4 to 3 ratio of horizontal to vertical.
 • In this case, a blank area remains on the right and left sides of the display.

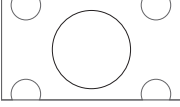
Full

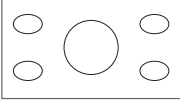
 • The screen is extended horizontally as a whole to the aspect ratio of 16 to 9.
 • The extension ratio is the same at any point of the screen.

Zoom

 • The screen is fully extended at the normal aspect ratio of 4 to 3.
 • The top and bottom of the screen are slightly cut.

Just

 • The screen is extended horizontally to the aspect ratio of 16 to 9.
 • The extension ratio increases toward the right and left ends of the screen.

default: Normal

Note:

- The aspect setting screen can be also activate **Aspect** when the button is displayed. (→ page 12)
- This adjustment is common to video mode.
- You cannot change the aspect in the menu screen and a screen in the CD, MP3 and radio mode. These are fixed to "Full".
- When the rear view camera is in operation with the transmission gear shift in the reverse position, the image is shown on the "Full" screen only.
- In some cases, the picture looks different from the original one due to your selection of aspect.

Caution

- This is to remind you that compression or extension of the screen using the aspect ratio (screen mode) changing function of this product for commercial purpose of profit making or viewing/listening by the public could infringe on the rights of the author protected by the copyright law.
- If you expand normal picture (4 to 3) by using "Just", "Zoom" or "Full" aspect to the full of the screen, you might not see the periphery of the picture, or you might see a distorted picture. Therefore, use the "Normal" mode to see the original picture as the author intended it.

User Screen **Audio** DVD Radio

SQ3

SQ3 setting

Six SQ presets are already provided at shipment in this unit.

- Flat** : flat frequency response
- Pop** : wide-ranged and deep sound
- Rock** : speedy and heavy sound
- Jazz** : jazz-specific deep sound
- Club** : club and disco-specific sound
- Vocal** : clear sound

default: **Flat**

You may set your own SQ or modify factory presets in each memories by following the instructions below:

Adjusting level of each preset

- ① Select the preset SQ that you prefer to adjust.
- ② Touch **<** or **>** to select a frequency in a frequency band (BASS/MID/TRE).
- ③ Touch **▲** or **▼** to adjust each frequency.

Adjustable range: -12 dB to +12 dB

Adjustable frequency:

BASS; 60 Hz, 80 Hz, 100 Hz, 200 Hz

MID; 500 Hz, 1 kHz, 2 kHz, 3 kHz

TRE; 10 kHz, 12 kHz, 15 kHz, 18 kHz

Note:

- The new level adjustment will overwrite the previous level adjustment.
- For resuming the factory settings, touch and hold **Default** for more than 2 seconds.

Bass/Treble

Bass/treble adjustment

Bass (Bass adjustment)

> : more

< : less

Treble (Treble adjustment)

> : more

< : less

Setting range: -12 dB to +12 dB
default: ±0 dB

Balance/Fader

Balance/fader adjustment

Balance (Sound level adjustment between right and left speakers)

> : right enhanced

< : left enhanced

Setting range: Right 15 to Left 15
default: **Center**

Fader (Sound level adjustment between front and rear speakers)

> : front enhanced

< : rear enhanced

Setting range: Front 15 to Rear 15
default: **Center**

Audio setting with [VOL] (PUSH SEL) on the main unit

Audio settings of **Bass**, **Treble**, **Balance** and **Fader** can be performed with **[VOL] (PUSH SEL)** on the main unit.

- ① Press **[VOL] (PUSH SEL)** to select a setting item.

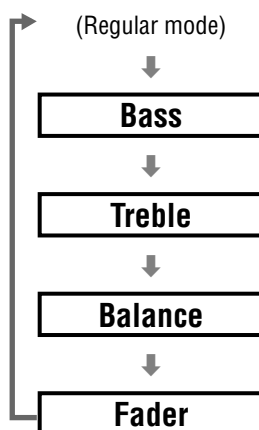

- ② Rotate **[VOL]** to make an adjustment.

Settings (continued)

User Screen Audio **DVD** Radio

Language

Language Setting

Menu (DVD menu language)

- ENG** : English
CHN : Chinese
FRA : French
Other : other language. Input the language code.
 (⇒ page 45)

default: **ENG**

Subtitle (Subtitle language)

Note:

- A disc supporting closed captioning and subtitles may overlap each other on the screen. In this case, turn the subtitle off.

- ENG** : English
CHN : Chinese
FRA : French
Other : other language. Input the language code.
 (⇒ page 45)

default: **ENG**

Audio (Audio language)

Note:

- These adjustments being executed, playback will start from the beginning of a disc.

- ENG** : English
CHN : Chinese
FRA : French
Other : other language. Input the language code.
 (⇒ page 45)

default: **ENG**

Display

Display aspect and DVD software mode

DVD Aspect (Display aspect setting)

- Narrow** : plays a video in 4:3 screen.
Wide : plays a video in wide screen (16:9).

default: **Wide**

Letter Box (DVD software mode)

- Pan & Scan** : plays wide-screen video in Pan & Scan mode (in which the left and right edges of the screen are cut off).
Letter Box : plays wide-screen video in letterbox mode (in which black bands appear at the top and bottom of the screen).

default: **Pan & Scan**

Note:

- Set the software setting according to the symbol used on jacket. (⇒ page 16)
- DVD software mode setting is ignored if **Pan & Scan** or **Letter Box** is already set in the software.
- Screen aspect of the display unit is changed according to the aspect ratio setting (⇒ page 34) and DVD software's aspect.

TV Type (VIDEO OUT terminal setting)

- PAL** : sets PAL in accordance with the equipment connected to VIDEO OUT.
NTSC : sets NTSC in accordance with the equipment connected to VIDEO OUT.

default: **PAL**

Angle Mark (Angle mark setting)

The angle mark is displayed to indicate the parts where multi-angle data is recorded.

- On** : activates angle mark.
Off : inactivates angle mark.

default: **On**

Down Mix

To use the down mix function, specify the type.

Lt/Rt : surround element decodable down mix
(Lt = Left total, Rt = Right total)

Lo/Ro : simple stereo down mix
(Lo = Left only, Ro = Right only)

Note:

- This function is available only when “Dolby Digital” source is playing.

default: **Lt/Rt**

DR COMP (Dynamic Range Compression)

Maintaining the ambience even while listening at a low volume level

Compression style selecting

STD : DR COMP ON

MIN : made with the greatest compression,
roughly equivalent to a TV broadcast.

Off : DR COMP OFF

default: **Off**

DivX Registration

Show the DivX Registration Code (⇒ page 38)



User Screen Audio DVD **Radio**

FM Setup

Setting for FM stations

Auto Preset (Auto preset setting)

Each : saves the preset stations in each band.

All : saves the preset stations in all FM lists
regardless of band.

default: **Each**

About DivX VOD Content



DivX Video-on-Demand (VOD) content is encrypted for copyright protection. In order to play DivX VOD content on this unit, you first need to register the unit.

Follow the on line instructions for purchasing DivX VOD content to enter the unit's registration code and register the unit. For more information about DivX VOD, visit www.divx.com/vod.

37

Display the unit's registration code

- ① Touch **Setup**.
- ② Touch **DVD**.
- ② Touch **DivX Registration**.

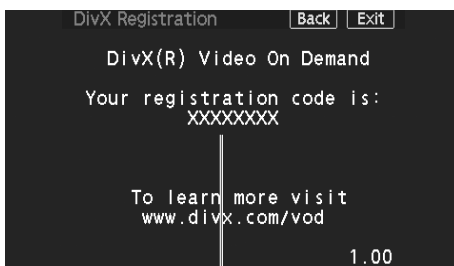

8 alphanumeric characters

Note:

- We recommend that you make a note of this code for future reference.
- After playing DivX VOD content for the first time, another registration code is then displayed in "DivX Registration". Do not use this registration code to purchase DivX VOD content. If you use this code to purchase DivX VOD content, and then play the content on this unit, you will no longer be able to play any content that you purchased using the previous code.
- If you purchase DivX VOD content using a registration code different from this unit's code, you will not be able to play this content. ("Authorization Error" is displayed.)

Regarding DivX content that can only be played a set number of times

Some DivX VOD content can only be played a set number of times. When you play this content, the remaining number of plays is displayed. You cannot play this content when the number of remaining plays is zero.

("Rental Expired" is displayed.)

When playing this content

- The number of remaining plays is reduced by one if
 - you press **[SOURCE]**.
 - you press **[◀◀] / [▶▶]** (◀◀ / ▶▶) etc. and arrive at another content or the start of the content being played.

Troubleshooting



□ If You Suspect Something Wrong

Check and take steps as described below.

If the described suggestions do not solve the problem, it is recommended to take the unit to your nearest authorized Panasonic Service Center. The product should be serviced only by qualified personnel. Please refer checking and repair to professionals. Panasonic shall not be liable for any accidents arising out of neglect of checking the unit or your own repair after your checking. **Never take measures especially those other than indicated by *italic* letters in "Possible Solution" described below because those are too dangerous for users to handle themselves.**

⚠ Warning

- Do not use the unit in an irregular condition, for example, without sound, or with smoke or a foul smell, which can cause ignition or electric shock. Immediately stop using the unit and consult your dealer.
- Never try to repair the unit by yourself because it is dangerous to do so.

■ Common

Problem	Possible cause → Possible solution
No power to the unit	<p>The power cord (battery, power and ground) is connected in the wrong way. → Check the wiring.</p> <p>Fuse blows out. → Eliminate the cause of fuse blowout and replace the fuse with new one. Consult your dealer.</p>
Sound is not generated.	<p>MUTE is set to ON. → Set MUTE to OFF.</p> <p>The wiring of speaker lines is not correct, or a break or poor contact arises. → Check the wiring in accordance with the wiring diagram. (Installation Instructions)</p>
Noise	<p>There is an electromagnetic-wave generator such as a cellular phone near the unit or its electrical lines. → Keep the electromagnetic-wave generator such as a cellular phone away from the unit and the wiring of the unit. In case noise cannot be eliminated due to the wiring harness of the car, consult your dealer.</p> <p>The contact of the ground lead is poor. → Make sure that the ground lead is connected to an unpainted part of the chassis securely.</p>
Noise is made in step with engine revolutions.	<p>Alternator noise comes from the car. → Change the wiring position of the ground lead. → Mount a noise filter.</p>
Some operations are not executable.	<p>Some operations are not executable in particular modes such as menu mode → Read the operating instructions carefully and cancel the mode. If the unit is still out of order, consult your dealer.</p>
No sound from speaker(s)	<p>There is a break, a short circuit, poor contact or wrong wiring regarding the speaker wiring. → Check the speaker wiring.</p>
The speaker channels are reversed between right and left.	<p>The speaker wiring is reversed between right and left. → Perform the speaker wiring in accordance with the wiring diagram.</p>
The power of the unit fails unintentionally.	<p>The safety device works. → Consult your dealer, or your nearest Panasonic Service Center.</p>

Troubleshooting (continued)

Common (continued)

Output disabled/distorted video/audio.

The conversion cable for AV 1 IN supplied with this unit is not used for the terminal of AV1 IN.

➔ **Use the conversion cable for AV 1 IN supplied with this unit for the connection.**

Display Settings

The picture is dark. The picture is whitish. Something is wrong with the picture. The picture is light in color.

The screen is not adjusted properly.

➔ **Make every adjustment of the screen.**

The display does not go back into the unit.

The monitor stops on the way to the home position.

➔ **Press [OPEN].**

Radio

Poor reception or noise

Antenna installation or wiring of antenna cable is faulty.

➔ **Check whether the antenna mounting position and its wiring are correct. In addition, check to see whether the antenna ground is securely connected to the chassis.**

No power is supplied to the antenna amplifier (when using a film antenna, etc.).

➔ **Check the wiring of the antenna power lead.**

The number of auto preset stations is less than 6.

The number of receivable stations is less than 6.

➔ **Move to an area where receivable stations number is maximum, and try pre-setting.**

Preset stations cannot be stored.

The contact of the battery lead is poor, or the battery lead is not always powered.

➔ **Make sure that the battery lead is connected securely, and preset stations again.**

CD

No playback or disc ejected

The disc is inserted upside down.

➔ **Insert a disc correctly.**

There is a flaw or foreign object on the disc.

➔ **Remove the foreign object, or use a flawless disc.**

Sound skipping or noise

There is a flaw or foreign object on the disc.

➔ **Remove the foreign object, or use a flawless disc.**

Sound skipping due to vibration

The unit is not sufficiently secured.

➔ **Secure the unit to the console box.**

The unit is tilted at over 30° in the front-to-end direction.

➔ **Make the angle 30° or less.**

Disc unejectable

Something such as a peeled label obstructs the disc coming out.

➔ **Press and hold the [▲] for more than 10 seconds (disc forced ejection). In case that the disc forced ejection does not work, consult your dealer.**

The microcontroller in the unit operates abnormally due to noise or other factors.

➔ **Unplug the power cord and plug it again. In case the unit is still out of order, consult your dealer.**

■ MP3/DivX

No playback or disc ejected

The disc has unplayable formatted data.
 ➔ **Refer to the description about MP3/DivX for playable formats.**

The CD-Rs/RWs/DVD-Rs/RWs that are playable on other devices are not playable on this unit.

The playability of some CD-Rs/RWs/DVD-Rs/RWs may depend on the combination of media, recording software and recorder to be used even if these CD-Rs/RWs/DVD-Rs/RWs are playable on other devices such as a PC.
 ➔ **Make CD-Rs/RWs/DVD-Rs/RWs in a different combination of media, recording software and recorder after referring to the description about MP3/DivX.**

Sound skipping or noise

There is a flaw or foreign objects on the disc.
 ➔ **Remove the foreign objects, or use a flawless disc. For MP3/DivX, refer to the description about MP3/DivX.**

Playing VBR (Variable Bit Rate) files may cause sound skipping.
 ➔ **Play Non-VBR files.**

The picture stops.

The picture may stop if the DivX files are greater than 2 GB.
 ➔ **Keep the file size under 2 GB.**

Note:

- Refer to “Notes on MP3/DivX”. (➔ page 22)

■ DVD

Cannot switch the audio language/subtitle language/angle.

- It is not possible to switch if the disc does not have multiple audio languages/subtitle languages/angles recorded on it. (Refer to the guide provided with your disc.)
- Some discs permit switching through a menu screen.
- Sometimes, switching angles is possible only with certain scenes.

The audio/subtitle language selected in the DVD settings is not used.

If audio or subtitles in that language are not recorded on the disc, the audio or subtitles do not switch to that language. (Some discs permit switching through a menu screen. Refer to the guide provided with your disc.)

A DVD-R or DVD-RW is not playable.

The disc is still unfinalized.
 ➔ **Finalize the disc.**
Refer to “Before Disc Playback” (➔ page 16) or “Notes on Discs” (➔ page 44) for other cases.

The disc is in the video recording (VR) format.
 ➔ **Play video formatted discs.**
Refer to “Before Disc Playback” (➔ page 16) or “Notes on Discs” (➔ page 44) for other cases.

Sound is not generated.



The audio format is output disabled for this unit such as dts.
 ➔ **Use output enabled discs.**
Refer to “Before Disc Playback” (➔ page 16) or “Notes on Discs” (➔ page 44) for other cases.

Troubleshooting (continued)

❑ Error Display Messages

■ CD/MP3/DivX/DVD/VCD (Video CD)

41

Display	Possible cause → Possible solution
Non Playable Disc	<p>Disc is dirty, or is upside down. → Check disc.</p> <p>Disc has scratches. → Check disc.</p>
Mechanism Error	<p>No operation by some cause. → Press [▲]. If failure persists, press the reset switch. If normal operation is not restored, call the store where you purchased the unit or the nearest Panasonic Service Center.</p>
File Error	<p>The type of the file that is selected is not supported. → Check disc.</p>
No Disc	<p>No disc is in the player. → Insert disc into the disc slot.</p>
Region Code Error	<p>The region code of the disc to be used is not compatible with this unit. → Press [▲] and check the disc.</p>
	<p>You are trying to play the DivX VOD content that was purchased with a different registration code. → Purchase the DivX VOD content with the registration code of this unit. (⇒ page 38)</p>
	<p>The DivX VOD content has no available play count. → Purchase again the content or play another content. (⇒ page 38)</p>

Note:

- There may be cases when the disc numbers affected by an error are displayed before “Non Playable Disc”.

❑ In case you forget the ID code...

In case you forget the ID code, please consult your nearest Panasonic Service Center.

ID code memo

Copy the memo at right, fill in the ID code, and keep it in a secure location.

Model No. CQ-VD5005W

ID CODE

❑ Product Servicing

If the suggestions in the charts do not solve the problem, we recommend that you take it to your nearest authorized Panasonic Service Center. The product should be serviced only by a qualified technician.

❑ Replacing the Fuse

Use fuses of the same specified rating (**15 A**). Using different substitutes or fuses with higher rating, or connecting the product directly without a fuse, could cause fire or damage to this unit.

If the replacement fuse fails, contact your nearest Panasonic Service Center for service.

❑ If the Unit Begins to Malfunction...

Reset switch

Remove the face plate (➔ page 11) and insert a hard, slender stick into the hole and push the switch.

Important

Push the switch only when the unit fails to operate with any buttons. (Stored settings and adjustments are not cleared.)

If the unit fails to return to normal condition, call the nearest Panasonic Service Center and ask for repairs.

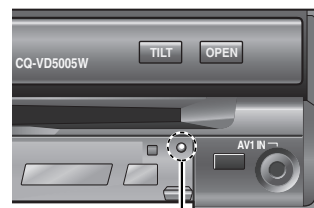

Reset switch

Note:

- If the ID-CODE has been already set, you will be asked to enter the ID-CODE right after the unit is restarted.

Maintenance

❑ Cleaning this Unit

Your product is designed and manufactured to ensure a minimum of maintenance. Use a dry soft cloth for routine exterior cleaning. Never use benzine, thinner or other solvents.



To remove stubborn stains

- 1 Moisten the soft cloth in dishwashing soap diluted with water and wring well.
- 2 Wipe lightly. Go over the same surface with a dry cloth.



Note:

- Since there is the possibility of water drops getting inside of the unit, do not directly apply cleanser to the surface.
- Do not scratch the screen with your nails or other hard objects. The resulting scratches or marks will obscure the images.

⚠ Caution

- If water drops or similar wet substances get inside the monitor, it may cause a malfunction.

Notes on Discs

How to hold the disc

- Do not touch the underside of the disc.
- Do not scratch the disc.
- Do not bend disc.
- When not in use, keep disc in the case.

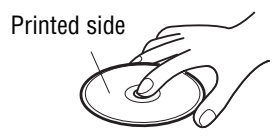

Do not use discs that fit any of the descriptions given below. Using these discs may damage the discs or cause the unit to malfunction.

• Special discs in a shape which is not round



• Partly or wholly transparent disc

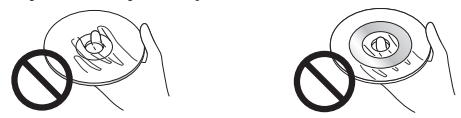

Wholly transparent disc* Partly transparent disc
 *Wholly semi-transparent disc may not be played back.

• Discs with adhered labels, etc. on them



Disc with adhered stickers or tape Labels created by a printer

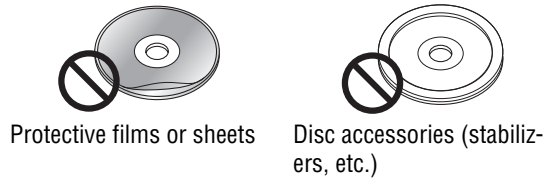

Protective films or sheets Disc accessories (stabilizers, etc.)

• Damaged or deformed discs



Shoddily made discs Discs with cracks, scratches or parts missing



Discs with burrs
 Please remove the burrs before use.

Disc insert

The surfaces of new discs tend to be slippery. Therefore, when using such a disc for the first time, it may not load satisfactorily even when it has been inserted into the unit. At a time like this, insert the disc into the unit as far as it will go until it is loaded properly.

- **When inserting a disc into or ejecting and removing it from the unit, insert it straight in or eject and remove it straight out in parallel with the unit. Otherwise, the disc may be scratched or marked in the process.**
- **When inserting a disc, do not put one disc on another. Failure to observe this may cause the discs to be jammed.**

Do not leave discs in the following places:

- Direct sunlight
- Near car heaters
- Dirty, dusty and damp areas
- On seats and dashboards

Disc cleaning

Use a dry, soft cloth to wipe from the center outward. Do not attach any seals or labels to your discs. Do not write on the disc label in a heavy pen or ballpoint pen.

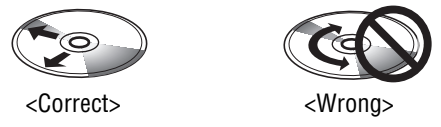

Notes on CD-Rs/RWs, DVD-Rs/RWs

- You may have trouble playing back some CD-R/RW, DVD-R/RW discs recorded on CD/DVD recorders (CD-R/RW, DVD-R/RW drives), either due to their recording characteristics or dirt, fingerprints, scratches, etc. on the disc surface.
- CD-R/RW, DVD-R/RW discs are less resistant to high temperatures and high humidity than ordinary music CDs. Leaving them inside a car for extended periods may damage and make playback impossible.
- The unit may not successfully playback a CD-R/RW, DVD-R/RW that was made by the combination of writing software, a CD/DVD recorder (CD-R/RW, DVD-R/RW drives) and a disc if they are incompatible with one another.
- This player does not play CD-R/RW, DVD-R/RW discs if the session is not closed.
- Be sure to observe the handling instructions of CD-R/RW, DVD-R/RW discs.
- This player does not play CD-R/RW, DVD-R/RW discs which contain other than CD-DA or MP3/DivX data.

Language Code List

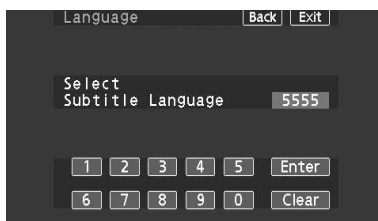

DVD language menu (→ page 36)

In “Other” cases... (→ page 36)

Input the four digit language code pressing the buttons **0** to **9** .
Touch **Enter** to determine.

Note:

- Setting is finished and the display returns to the main menu.
- For retrying selection during number entry, touch **Clear** .

Code	Language Name
6565	Afar
6566	Abkhazian
6570	Afrikaans
6577	Ameharic
6582	Arabic
6583	Assamese
6589	Aymara
6590	Azerbaijani
6665	Bashkir
6669	Byelorussian
6671	Bulgarian
6672	Bihari
6678	Bengali; Bangla
6679	Tibetan
6682	Breton
6765	Catalan
6779	Corsican
6783	Czech
6789	Welsh
6865	Danish
6869	German
6890	Bhutani
6976	Greek
6978	English
6979	Esperanto
6983	Spanish
6984	Estonian
6985	Basque
7065	Persian
7073	Finnish
7074	Fiji
7079	Faroese
7082	French
7089	Frisian
7165	Irish
7168	Scots Gaelic
7176	Galician
7178	Guarani
7185	Gujarati
7265	Hausa
7273	Hindi
7282	Croatian
7285	Hungarian

Code	Language Name
7289	Armenian
7365	Interlingua
7378	Indonesian
7383	Icelandic
7384	Italian
7387	Hebrew
7465	Japanese
7473	Yiddish
7487	Javanese
7565	Georgian
7575	Kazakh
7576	Greenlandic
7577	Cambodian
7578	Kannada
7579	Korean
7583	Kashmiri
7585	Kurdish
7589	Kirghiz
7665	Latin
7678	Lingala
7679	Laothian
7684	Lithuanian
7686	Latvian, Lettish
7771	Malagasy
7773	Maori
7775	Macedonian
7776	Malayalam
7778	Mongolian
7779	Moldavian
7782	Marathi
7783	Malay
7784	Maltese
7789	Burmese
7865	Nauru
7869	Nepali
7876	Dutch
7879	Norwegian
7982	Oriya
8065	Panjabi
8076	Polish
8083	Pashto, Pushto
8084	Portuguese
8185	Quechua

Code	Language Name
8277	Rhaeto-Romance
8279	Romanian
8285	Russian
8365	Sanskrit
8368	Sindhi
8372	Serbo-Croatian
8373	Singhalese
8375	Slovak
8376	Slovenian
8377	Samoan
8378	Shona
8379	Somali
8381	Albanian
8382	Serbian
8385	Sundanese
8386	Swedish
8387	Swahili
8465	Tamil
8469	Telugu
8471	Tajik
8472	Thai
8473	Tigrinya
8475	Turkmen
8476	Tagalog
8479	Tonga
8482	Turkish
8484	Tatar
8487	Twi
8575	Ukrainian
8582	Urdu
8590	Uzbek
8673	Vietnamese
8679	Volapük
8779	Wolof
8872	Xhosa
8979	Yoruba
9072	Chinese
9085	Zulu

Definition of Terms

Dolby Digital

This fully discrete format divides the music signals into 5.1 channels: Front Left (L), Front Right (R), Centre (C), Left Surround (LS), Right Surround (RS) and Subwoofer (SW: 0.1 channel) for recording and playback. The number of channels that are recorded depends on the software. (1 to 5.1 channels)

Manufactured under license from Dolby Laboratories.
 "Dolby" and the double-D symbol are trademarks of Dolby Laboratories.
 Confidential unpublished works. Copyright 1992–1997 Dolby Laboratories. All rights reserved.

Interactive DVD

An interactive DVD is DVD software which includes multiple angles, multiple plot endings, etc.

Letterbox screen

This refers to a screen on which the playback picture of wide-screen DVDs or VCD (Video CD)s appears with black bands running along the top and bottom.

LPCM (Linear PCM audio)

In this format, the audio signal is converted to digital data and recorded in two channels without compression. Because the capacity of a DVD disc is large, it can store more data with better accuracy than a CD.

Pan & Scan screen

This refers to a screen on which the playback picture of wide-screen DVDs or VCD (Video CD)s is cut off at the left and right sides.

Playback control (VCD (Video CD))

If the VCD (Video CD) has "With Playback Control" or others written on the disc surface or on the jacket, the scenes or information to be viewed (or listened to) can be selected interactively with the screen by looking at the menu shown on the screen.

In these instructions, playback using the menu screen is referred to as the "menu play" for video CDs. This player supports Video CDs with playback control.

DivX

DivX is a popular media technology created by DivX, Inc. DivX media files contain highly compressed video with high visual quality that maintains a relatively small file size. DivX files can also include advanced media features like menus, subtitles, and alternate audio tracks. Many DivX media files are available for download online, and you can create your own using your personal content and easy-to-use tools from DivX.com.

This product incorporates copyright protection technology that is protected by U.S. patents and other intellectual property rights. Use of this copyright protection technology must be authorized by Macrovision, and is intended for home and other limited viewing uses only unless otherwise authorized by Macrovision. Reverse engineering or disassembly is prohibited.

Official DivX® Certified product
 Plays all versions of DivX® video (including DivX® 6) with standard playback of DivX® media files
 DivX, DivX Certified, and associated logos are trademarks of DivX, Inc. and are used under license.

Specifications

General

- Power supply : 12 V DC (11 V – 16 V), test voltage 14.4 V, negative ground
- Current consumption : Less than 10 A (during disc playback)
- Power Output : 18 W x 4 ch (1 kHz, 1 %, 4 Ω)
- Maximum power output : 45 W x 4 ch
- Compatible speaker impedance : 4 Ω
- Video input signal : Composite video signal, 1.0 Vp-p (75 Ω)
- Audio input sensitivity : 2 Vrms
- Video output signal : Composite video signal, 1.0 Vp-p (75 Ω)
- Pre-Amp output voltage : 2 Vrms
- Pre-Amp output impedance: Less than 600 Ω
- Dimensions (W x H x D) : 178 x 50 x 165 mm
- Weight : 2.4 kg

Front AV input (AV1 IN)

- Input impedance : 47 kΩ
- Allowable external input : 2.0 V
- Connector : 3.5 mmø Stereo mini pin (Equipped with video input terminal)
- Video input signal : Composite video signal, 1.0 Vp-p (75 Ω)
- Audio input sensitivity : 2 Vrms

FM stereo radio

- Frequency range : 87.5 MHz – 108 MHz
- Usable sensitivity : 7 dB/μV
- Stereo separation : 30 dB (1 kHz)
- S/N ratio : 62 dB

Note:

- Specifications and the design are subject to modification without notice due to improvements in technology.
- Some figures and illustrations on this manual may be different from your product.

Playable region number

This operating instruction manual is for 4 models CQ-VD5005W2/CQ-VD5005W3/CQ-VD5005W4 and CQ-VD5005W5. The following table shows the playable region number for each model.

Model	Playable region number
CQ-VD5005W2	2 (ALL)
CQ-VD5005W3	3 (ALL)
CQ-VD5005W4	4 (ALL)
CQ-VD5005W5	5 (ALL)

AM radio

- Frequency range : 531 kHz – 1 602 kHz
- Usable sensitivity : 28 dB/μV
- Image rejection ratio : 50 dB

Audio section

- Output voltage/ Impedance : 2 Vrms/600 Ω
- Frequency characteristics : 20 Hz – 20 kHz (±1 dB)
- Dynamic range : 96 dB (during CD playback)
- S/N ratio : 95 dB (during CD playback)

Monitor

- Liquid crystal panel : 7-inch wide
- Screen dimensions (W x H x D) : 154 x 87 x 177 mm
- Number of pixels : 336 960 pixels (234 vertical x 480 horizontal x 3)
- Valid pixel ratio : Over 99.99%
- Display method : Transparent color filter format
- Drive method : TFT (Thin Film Transistor) active matrix format

■ 보증서

모델명	CQ-VD5005W		
고객란	고객 성명:	_____ 님	
	고객 주소 : 우편번호	_____	
		시	구(읍, 면) 동(리)
	전화 번호 : (_____)	_____ - _____	
구입 년월일	판매점 명, 주소, 전화 번호 :		
년 월 일			
보증 기간 (구입일부터)	전화 번호 : (_____) _____ - _____		
1 년간	제품의 시리얼 번호 :		

※ 구입일과 구입처(판매점)를 분명히 기재하여, 고객에게 전달하시기 바랍니다. 차후의 A/S수리와 관련하여 매우 중요하오니 반드시 보관하시기 바랍니다.

※ 당사에서는 제품의 시리얼 번호를 전산 처리하여 관리하고 있습니다. 보증서에 시리얼 번호를 기록 하여 두시기 바랍니다.

제조년월

Panasonic Car Audio 세풍전자공업주식회사
 한국총대리점 본사 : 서울특별시 영등포구 양평동5가 56-2
 전화 : (02)2633-0856(대표전화)
 고객상담실 : (02)2633-0878
 홈페이지 : www.sepung.co.kr

Matsushita Electric Industrial Co., Ltd.

Web Site : <http://panasonic.net>

YFM284C684CA PTW1206-2037

Printed in China

Panasonic

Installation Instructions

설치 설명서

Инструкция по монтажу

Model: **CQ-VD5005W**



- Please read these instructions carefully before using this product and keep this manual for future reference.
- 본 제품의 바른 사용을 위해, 이 사용설명서를 잘 읽어 주십시오.
잘 보관하시어 필요하실 때마다 읽어주시기 바랍니다.
- Перед началом эксплуатации просим прочитать настоящую инструкцию внимательно и хранить ее на пользование на будущее.

Safety Information

**CAUTION:**

- PLEASE FOLLOW THE LAWS AND REGULATIONS OF YOUR STATE, PROVINCE OR COUNTRY FOR INSTALLATION OF THE UNIT.
- TO REDUCE THE RISK OF FIRE OR ELECTRIC SHOCK OR PRODUCT DAMAGE, DO NOT EXPOSE THIS APPLIANCE TO RAIN, SPLASHING, DRIPPING OR MOISTURE.

Upgrade Options

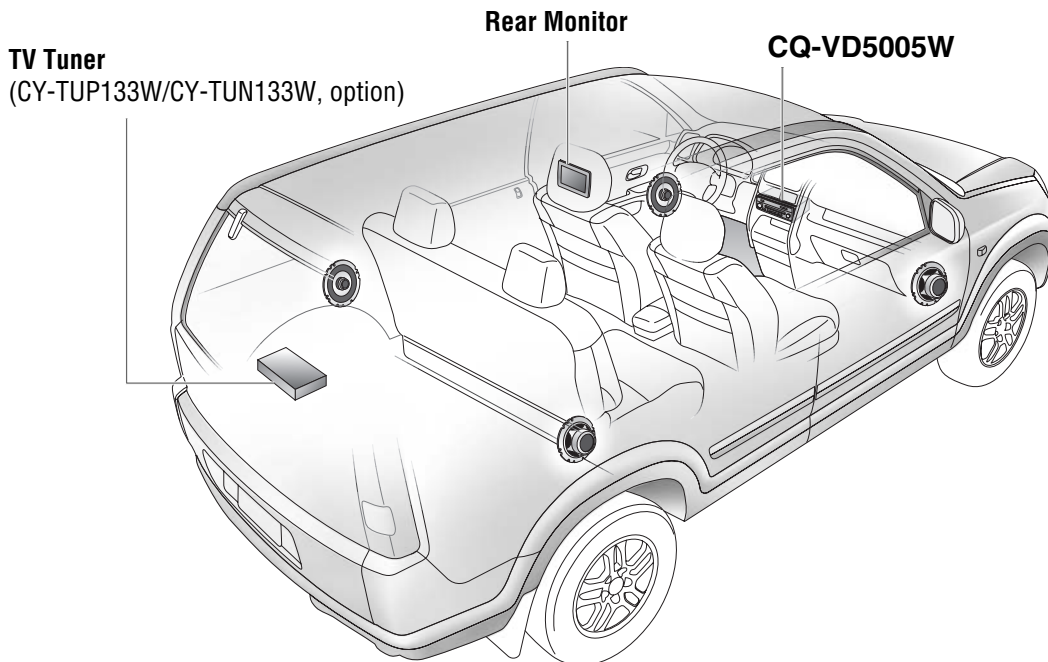

Contents

Safety Information.....	2
Upgrade Options.....	3
Contents.....	3
Installation.....	4
Electrical Connections.....	10

Installation

Preparation

3

⚠ Caution

- Please follow the laws and regulations of your province or country for installation of the unit.
- When bending the mounting tab of the mounting collar with a screwdriver, be careful not to injure your hands and fingers.
- We strongly recommend you to wear gloves for installation work to protect yourself from injuries.

- Before installation, check the radio operation with antenna and speakers.
- Disconnect the cable from the negative (-) battery terminal (see caution below).
- The unit should be installed in a horizontal position with the front end up at a convenient angle, but not more than 30°.

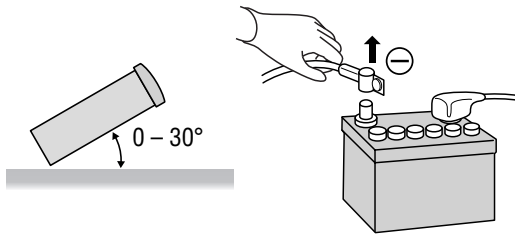

⚠ Caution

- Do not disconnect the battery terminals of a car with trip or navigational computer since all user settings stored in memory will be lost. Instead take extra care with installing the unit to prevent shorts.

Dashboard Installation

Installation Opening

The unit can be installed in any dashboard having an opening as shown below. The dashboard should be 4.5 mm – 6 mm thick in order to be able to support the unit.

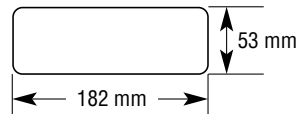









Installation Precautions

This product should be installed by a professional installer, if possible.



In case of difficulty, please consult your nearest authorized Panasonic Service Center.

1. This system is to be used only in a 12 V DC battery system (car) with negative ground.
2. Follow the electrical connections carefully (→ page 10 – 15). Failure to do so may result in damage to the unit.
3. Connect the power lead after all other connections are made.
4. Be sure to connect the battery lead (yellow) to the positive terminal (+) of the battery or fuse block (BAT) terminal.
5. Insulate all exposed wires to prevent short circuiting.
6. Secure all loose wires after installing the unit.
7. Please carefully read the operating and installation instructions of the respective equipment before connecting it to this unit.

□ Installation Hardware (For Installation)

No.	Item	Diagram	Qty.
①	Trim Plate		1
<YFC054C087CA>			
②	Mounting Collar		1
<YFX214C433CA>			
③	Mounting Spring		2
<YFX054C077CA>			
④	Mounting Bolt (5 mmø)		1
<YEJV01060>			
⑤	Round Head Screw (5 mmø x 6 mm)		2
⑥	Flat-Head Screw (5 mmø x 6 mm)		4
⑦	Round Head Screw (4 mmø x 3 mm)		4
<ZZBISVD7001B>			
⑧	Spacer		2
⑨	Double-Faced Adhesive Tape		1 set
<ZZBISVD7001E>			

□ Installation Hardware (For Wiring)

No.	Item	Diagram	Qty.
⑩	Power Connector		1
<YAJ024C122CA>			
⑪	Conversion Cable for AV1 IN		1
<YEAERA33000K>			

Note:

- The number in parenthesis underneath each accessory part name is the part number for maintenance and service.
- Accessories and their parts numbers are subject to modification without prior notice due to improvements.
- Use the supplied screws for installation exclusively. In case of losing any of them, please order the specific screw.

□ Transportation Bracket Removal

Be sure to remove the transportation brackets before use (installation).

Use round head screws (5 mmø x 6 mm) for installation. (→ page 8)

Be careful not to lose these screws.

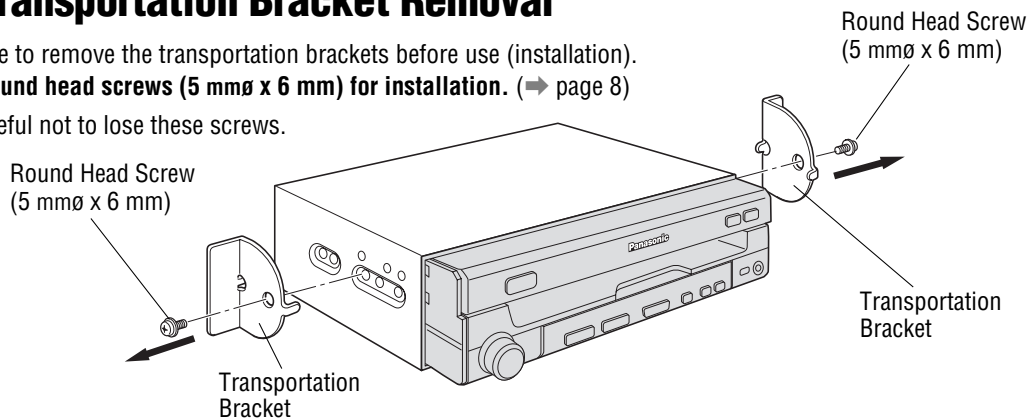

Installation (continued)

Mounting the Main Unit

5

□ Installation Procedures (When using Mounting Collar ②)

Note:

- The car model, installation conditions and combination of the units used may impose some restrictions on opening and closing the monitor as well as on the angle and position to which the monitor can be adjusted.

IMPORTANT

When this unit is installed in dashboard, ensure that there is sufficient air flow around the unit to prevent damage from overheating. Do not block any ventilation holes on the unit.

1

Insert the Mounting Collar ② into the dashboard, and bend the mounting tabs out with a screwdriver.

Fastening the Mounting Collar

How much to bend the tabs will vary depending on the car. Bend them with a screwdriver to fasten the Mounting Collar ② securely in the dashboard.

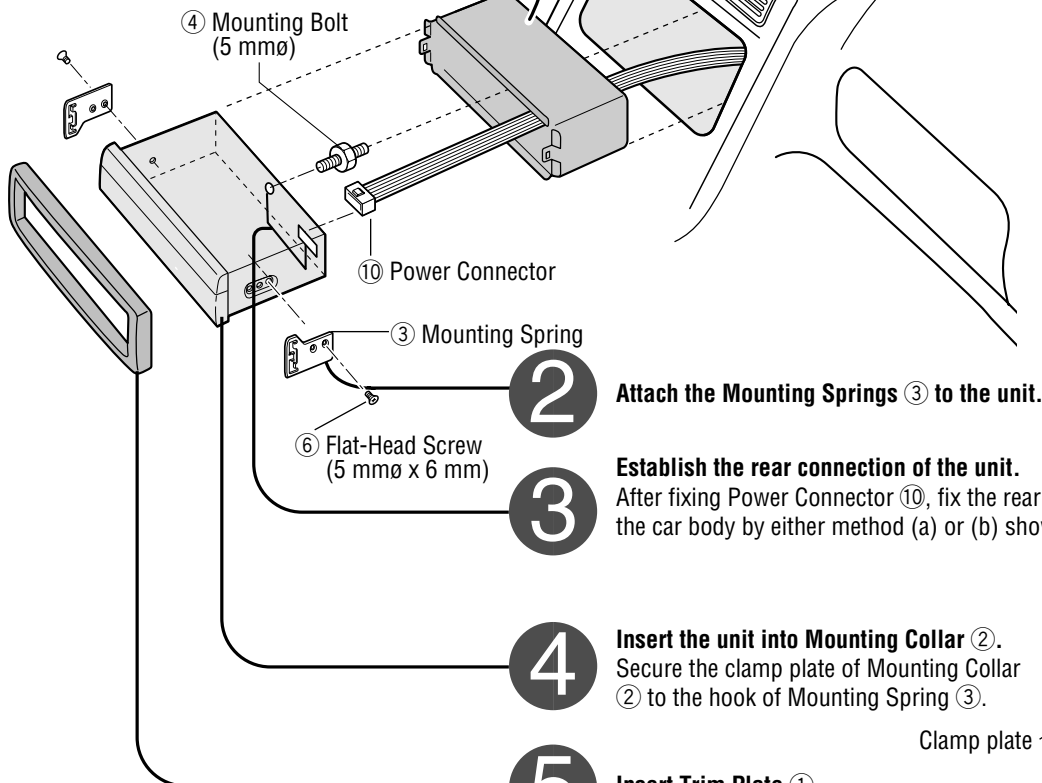
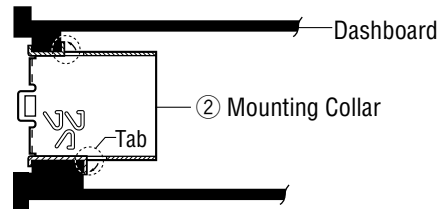

2

Attach the Mounting Springs ③ to the unit.

3

Establish the rear connection of the unit.

After fixing Power Connector ⑩, fix the rear of the unit to the car body by either method (a) or (b) shown at right.

4

Insert the unit into Mounting Collar ②. Secure the clamp plate of Mounting Collar ② to the hook of Mounting Spring ③.

Clamp plate

5

Insert Trim Plate ①.

6

After installation reconnect the negative (-) battery terminal.

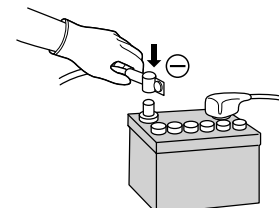

Method for Fixing the Mounting Spring

Two holes of the mounting spring allow you to select between two mounting types as shown below.

(A) Regular installation method

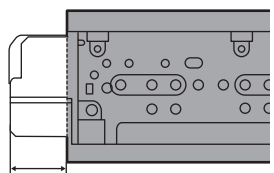

A few millimeters of console projecting

⑥ Flat-Head Screw

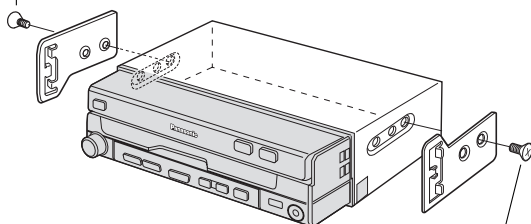

⑥ Flat-Head Screw

(B) Deeper installation method

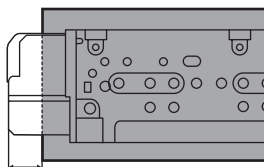

Less projecting

⑥ Flat-Head Screw

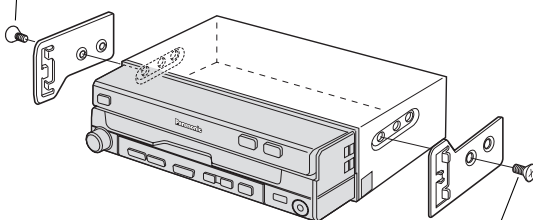

⑥ Flat-Head Screw

⚠ Caution

- Method (B) is not available in some types of cars.

Method for Fixing the Rear of the Unit

(a) Using the Rear Support Strap (option)

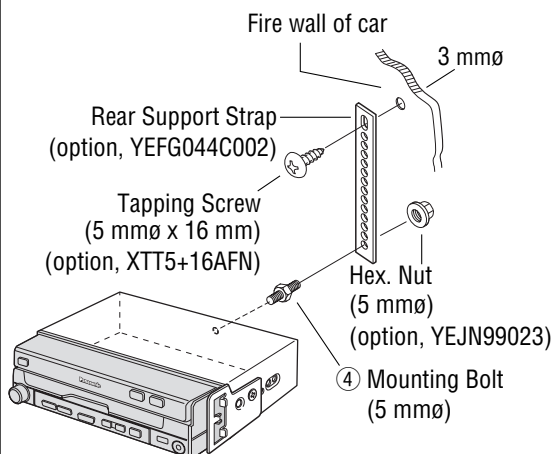

(b) Using the Rubber Cushion (option)

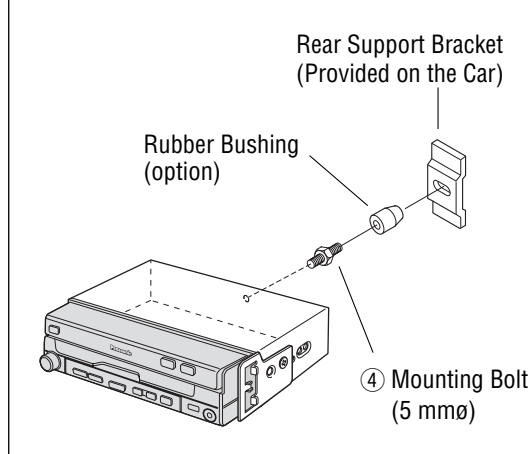



Installation (continued)

□ Installation Procedures (When not using Mounting Collar ②)

Use the brackets supplied with your car when mounting this unit. The bracket shape and mounting method vary with car manufacturers, car types and manufacturing year. Please consult your nearest dealer or installer.

7

Select mounting screws according to the hole positions and hole shape of the bracket.

	⑤ Round Head Screw (5 mmø x 6 mm) 2 pieces Recycle the Round Head Screws that fixed the transportation brackets for two more positions.
	⑦ Round Head Screw (4 mmø x 3 mm) 4 pieces
	⑥ Flat-Head Screw (5 mmø x 6 mm) 4 pieces

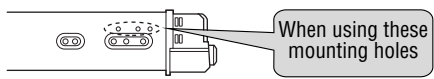

Use the supplied Spacer ⑧ if mounting hole of your car is shaped like below.

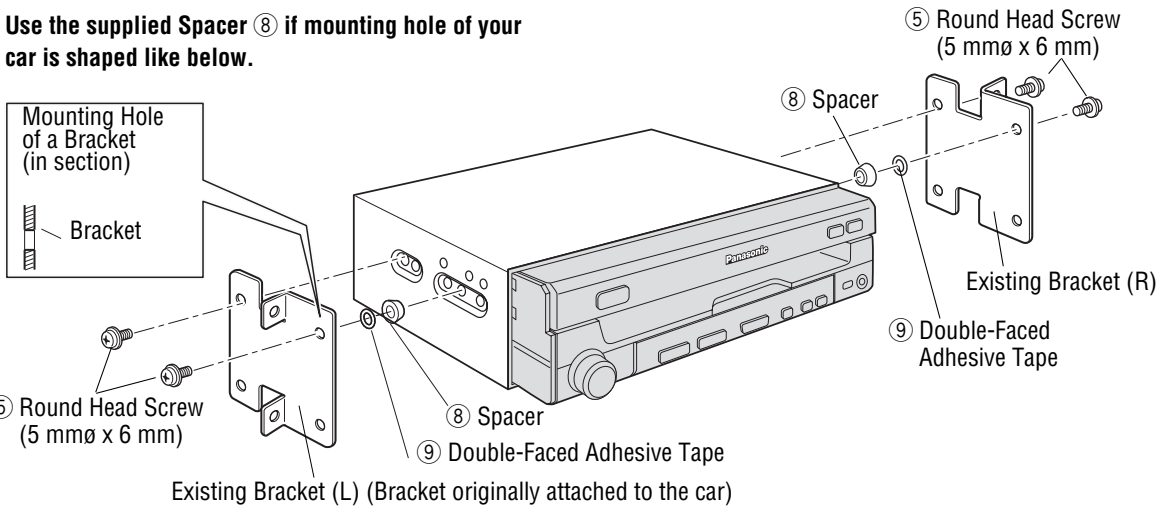

To Remove the Unit

- ① Push the right and left clamp plates outward, one at a time, and pull the unit toward yourself.
- ② After removing the right and left clamp plates, pull the unit with both hands till it comes out.

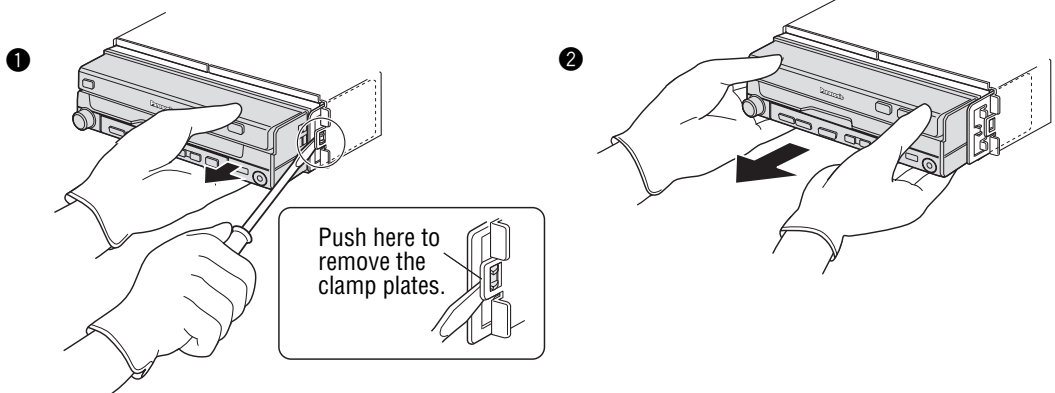

Connecting the Side Brake (Parking Brake) Connection Lead

⚠ Caution

- For safety, be sure to ask your nearest professional installer to do this connection.

Hand brake

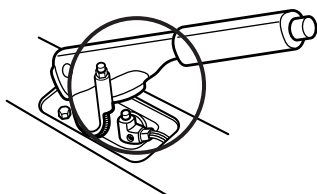

Foot brake

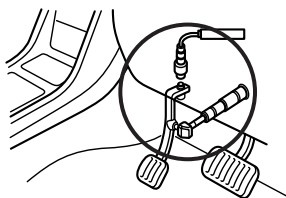

The side brake (parking brake) switch position varies with car model. For details on the exact location of the side brake (parking brake) switch in your car, contact your dealer.

Side brake (parking brake) switch

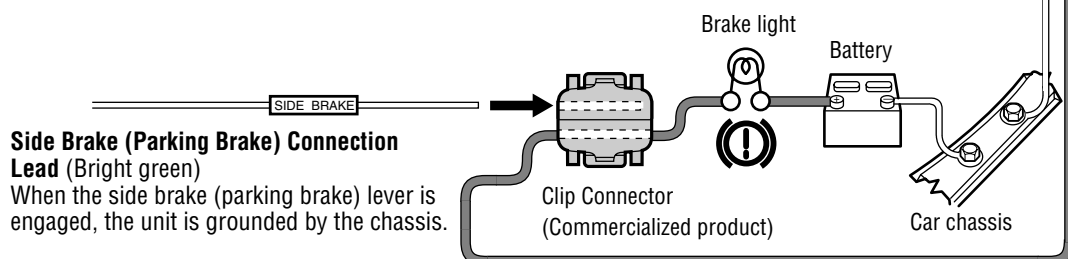

- 1 Attach a Clip Connector to the end of the side brake (parking brake) connection lead.

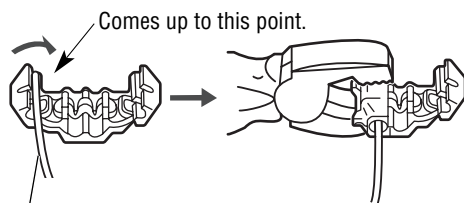

Side Brake (Parking Brake) Connection Lead (Bright green)

- 2 The Clip Connector is connected to the power source side lead of the side brake (parking brake) lever.

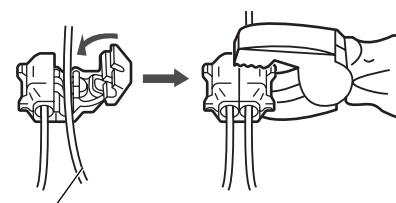

Power source side lead

Electrical Connections

⚠ Caution

- This unit is designed for use in a car having a 12 V negative ground battery system.
- Be sure to insulate any exposed wires from the car chassis. Bundle all cables and keep cable terminals free from any metal parts.
- Note that if your car has a driving computer or a navigation computer, disconnecting the cable from the battery may clear the memory.
- Run the cords avoiding the spots where the temperature can be extremely high.

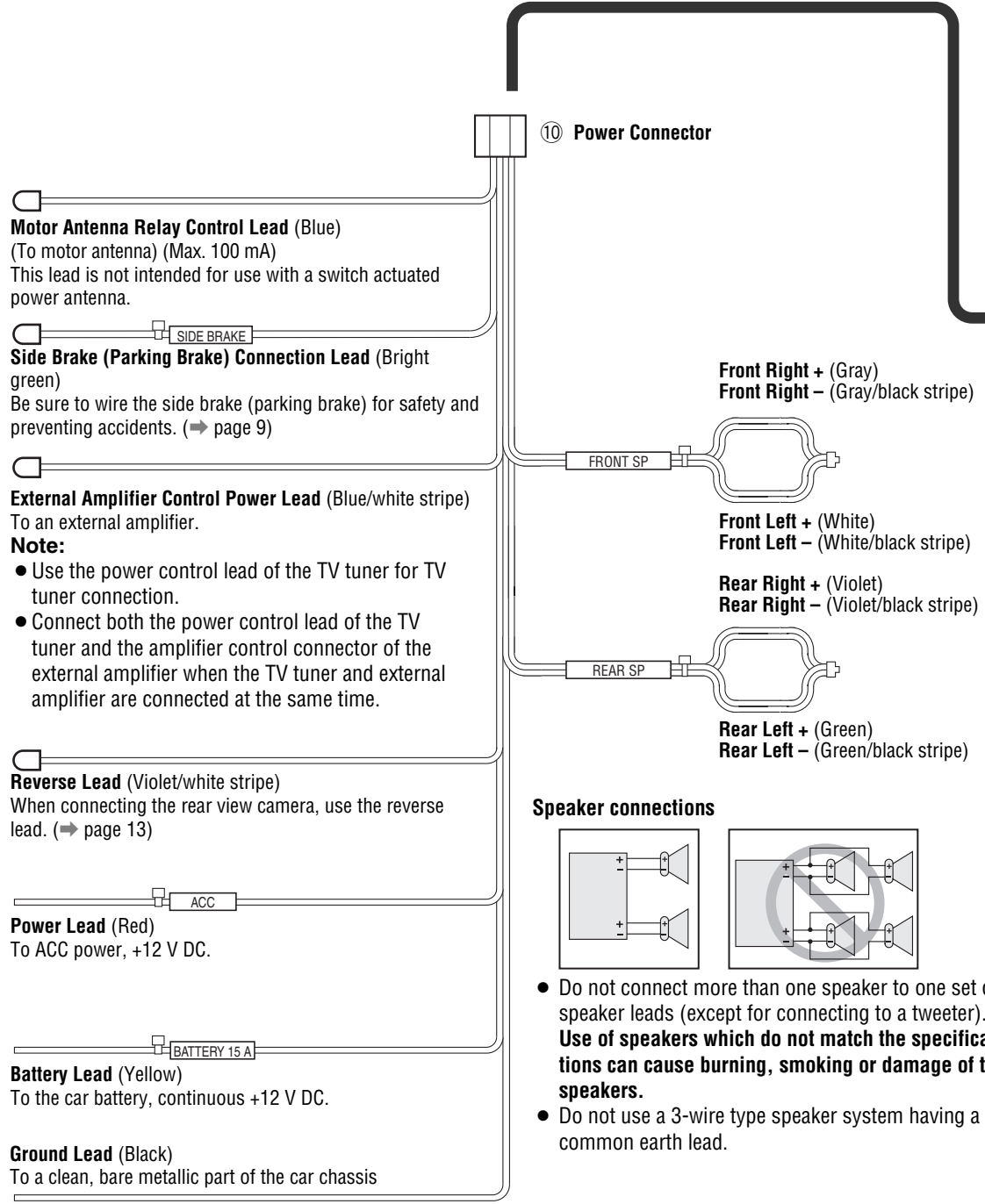

Note:

- To prevent from damage to the unit, be sure to follow the wiring diagrams below.
- Be sure to fully plug in the connectors. Secure them with clamps and tapes.
- All other installation methods require the use of dedicated metal fittings. Consult with a qualified servicing engineer or your dealer if other methods are required.
- Installation of this product may interfere with the grounding properly. In such a case, connect the ground lead of the external equipment to be connected to the mounting bolt ④ that secures this product.
- The pre-out connector is used exclusively to an external amplifier. Accordingly, do not connect the audio input terminal and the like of other external devices to this connector.

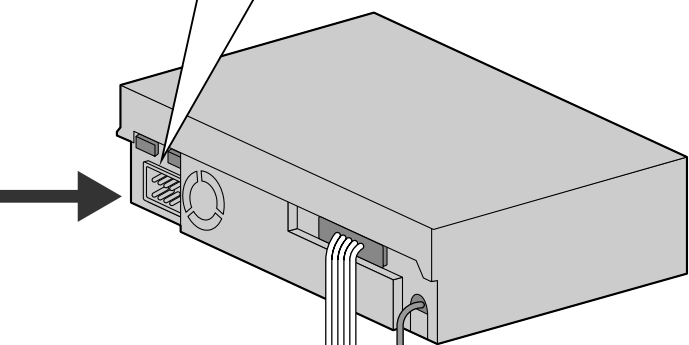
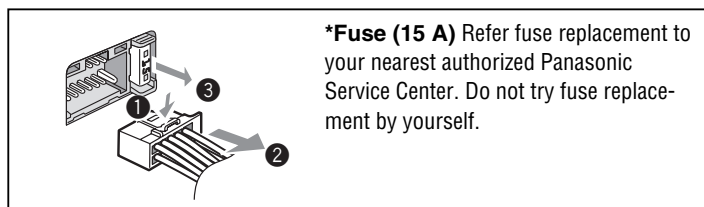

CQ-VD5005W (Rear)

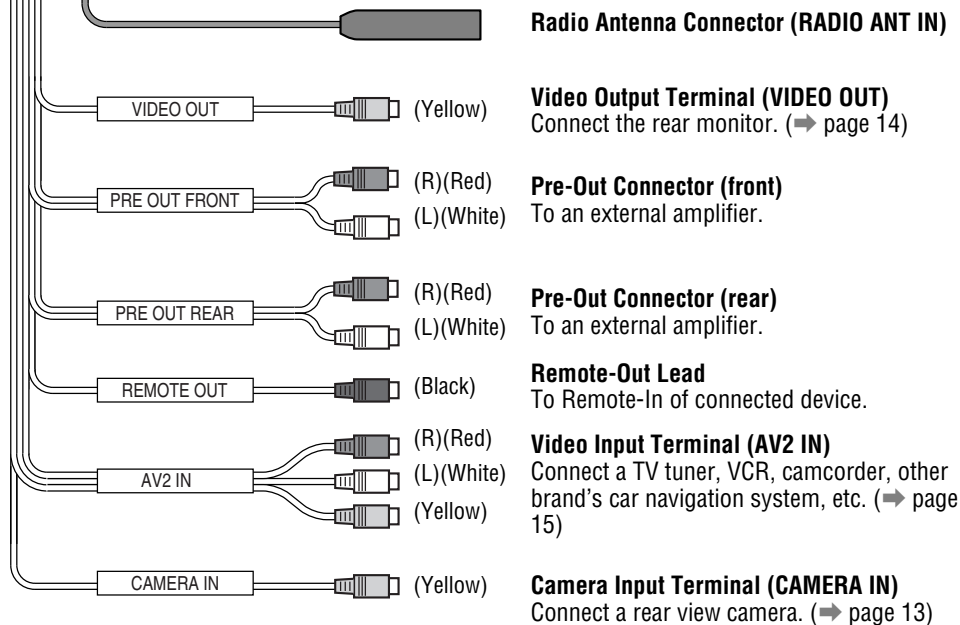

Electrical Connections (continued)



Connection with TV Tuner

Note:

- Refer to the operating instructions for the connected devices, in addition.

11

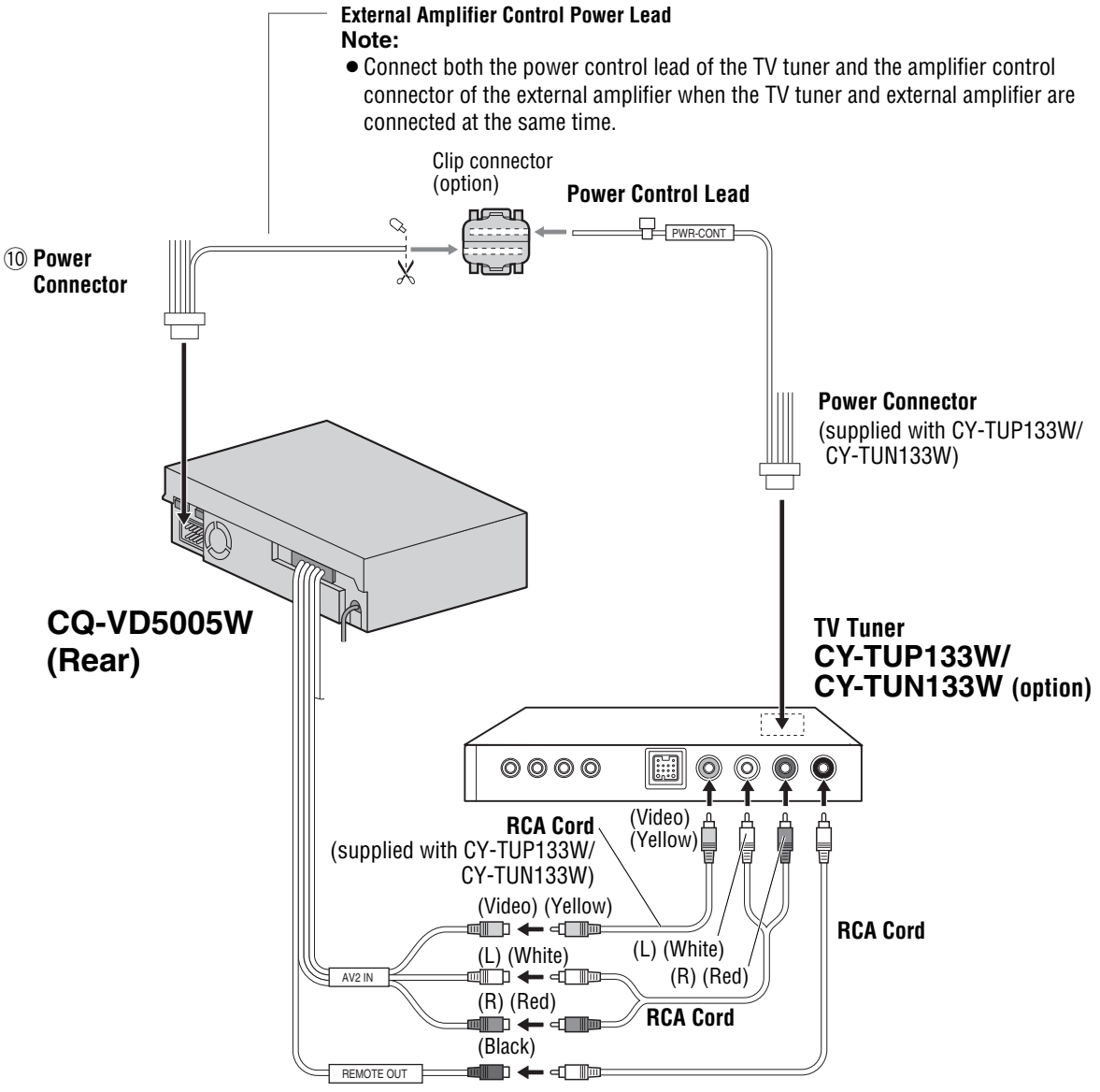

Connection with Rear View Camera

Note:

- Refer to the operating instructions for the connected devices, in addition.

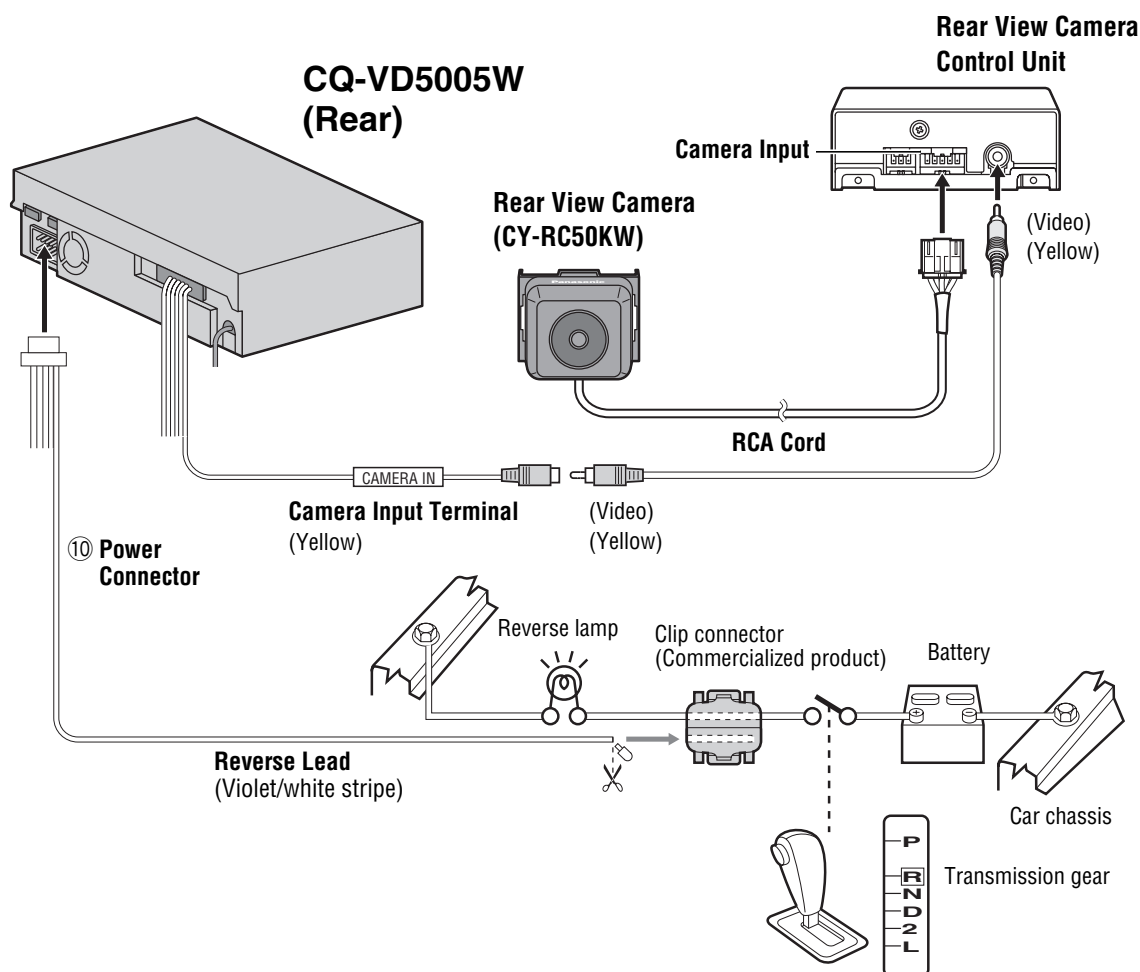

Connecting the Reverse Lead

If using an optional rear view camera, the reverse lead must be connected.

Connect the reverse lead (violet/white stripe) to the positive (+) lead of the reverse lamp (the lamp with a clear lens that lights when the transmission gear is shifted into the reverse position).

Note:

- Connect the reverse lead after cutting the terminal at the end.
- Use a Reverse Extension Cord (option) if needed.

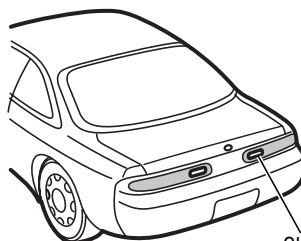

Check the reverse lamp.

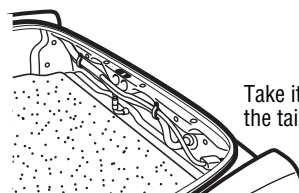

Take it out of the back of the tail lamp mount.

Electrical Connections (continued)

Connection with Rear Monitor

Note:

- Refer to the operating instructions for the connected devices, in addition.
- Please observe what shapes the connectors of the connecting devices are and where each of them is connected to in order to establish a proper connection.

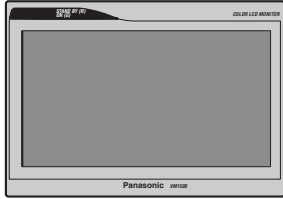

Rear Monitor

⚠ Caution

- For people sitting in the front seats, please enjoy only audio during driving.

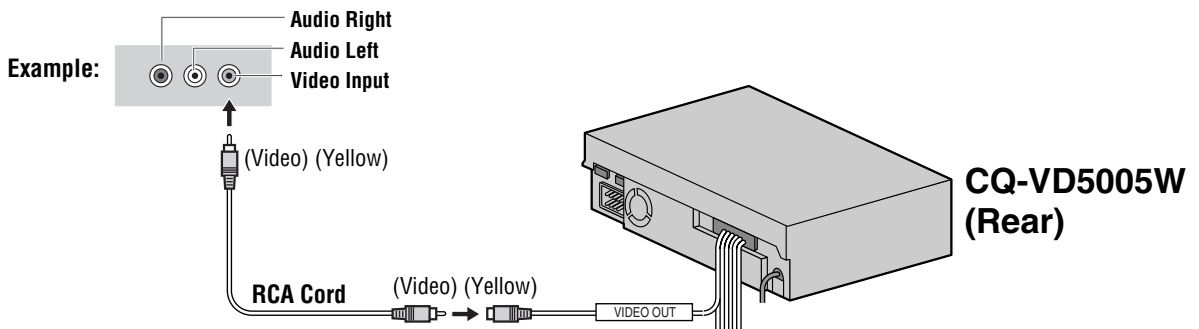

Connection with VCR or Camcorder

Note:

- Refer to the operating instructions for the connected devices, in addition.
- Please observe what shapes the connectors of the connecting devices are and where each of them is connected to in order to establish a proper connection.

AV1 IN

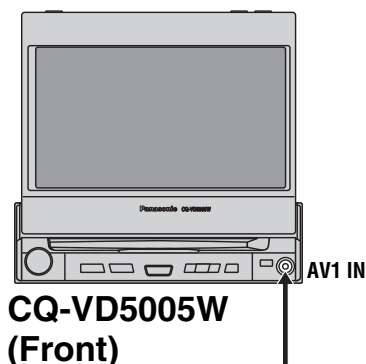

Note:

- Be sure to use the Conversion Cable for AV1 IN that is supplied with this product when an external device is connected to the AV1 IN terminal. Failure to observe this results in an audio or video output error.
- Only the pin jack of the supplied Conversion Cable for AV 1 IN or a pin jack that has the same electrode arrangement can be connected to the AV 1 IN terminal. (See Fig. 1.)
- Use of the supplied Conversion Cable for AV 1 IN or an audio pin jack that has the same electrode arrangement also allows users to enjoy only music. In this case, the screen background becomes black.

<Fig. 1>

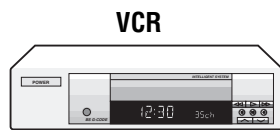
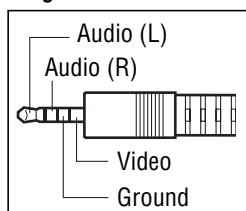

**Conversion Cable
for AV1 IN**

(Video) (Yellow)

(R) (Red)

(L) (White)

RCA Cord

(L)
(White)

(R)
(Red)

(Video)
(Yellow)

Example:

Video Output
Audio Left
Audio Right

AV2 IN

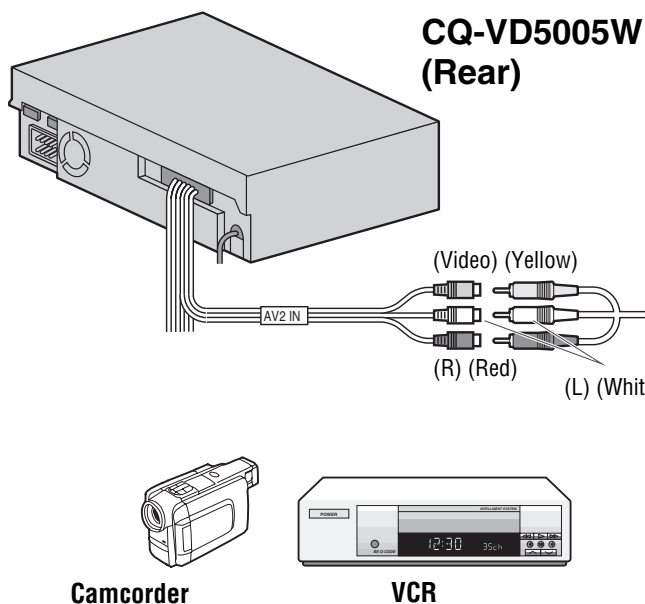

RCA Cord

(L)
(White)

(R)
(Red)

(Video)
(Yellow)

Example:

Video Output
Audio Left
Audio Right

Matsushita Electric Industrial Co., Ltd.
Web Site : <http://panasonic.net>

Free Manuals Download Website

<http://myh66.com>

<http://usermanuals.us>

<http://www.somanuals.com>

<http://www.4manuals.cc>

<http://www.manual-lib.com>

<http://www.404manual.com>

<http://www.luxmanual.com>

<http://aubethermostatmanual.com>

Golf course search by state

<http://golfingnear.com>

Email search by domain

<http://emailbydomain.com>

Auto manuals search

<http://auto.somanuals.com>

TV manuals search

<http://tv.somanuals.com>