

Color Television

Operating Instructions

Panasonic®

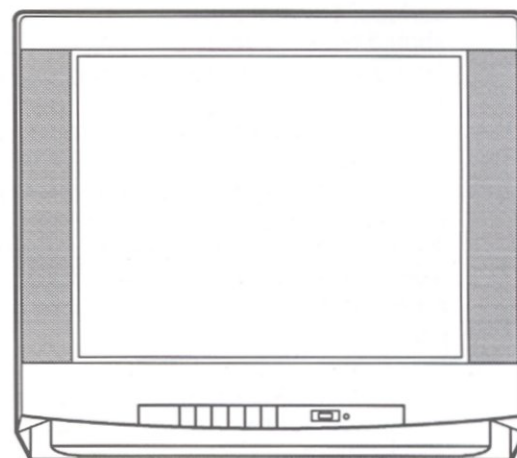

CT-20G21



CT-20G31

Read these instructions completely before operating this set.
Contents subject to change without notice or obligation.

Copyright 1996 by Matsushita Electric Corporation of America.
All rights reserved. Unauthorized copying and distribution is a violation of law.

Printed in Mexico
TQB2AA0007

Safety Instructions

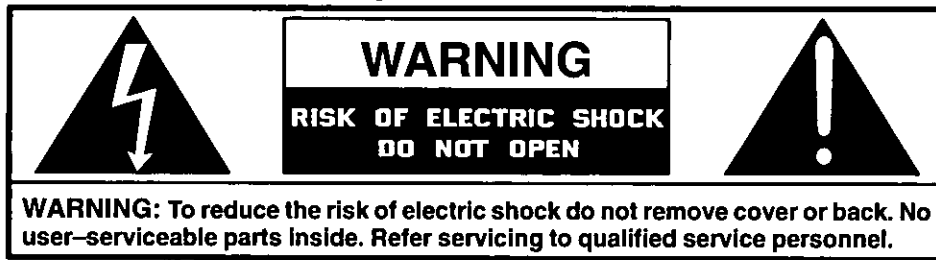

The lightning flash with arrow-head within a triangle is intended to tell the user that parts inside the product are a risk of electric shock to persons.



The exclamation point within a triangle is intended to tell the user that important operating and servicing instructions are in the papers with the appliance.

Note To CATV System Installer: This reminder is provided to call the CATV system installer's attention to Article 820-40 of the NEC that provides guidelines for proper grounding and, in particular, specifies that the cable ground shall be connected to the grounding system of the building, as close to the point of cable entry as practical.

Safety Instructions For Television Receivers

1. Read and apply the operating instructions provided with your television receiver.
2. Read all of the instructions given here and retain them for later use.
3. Unplug this television receiver from the wall outlet before cleaning. Do not use liquid or aerosol cleaners. Use a damp cloth for cleaning.
4. Do not use attachments not recommended by the television receiver manufacturer as they may cause hazards.
5. Do not use this television receiver near water. For example: Avoid placing it near a bathtub, washbowl, kitchen sink, or laundry tub, in a wet basement, or near a swimming pool, etc.
6. Do not place this television receiver on an unstable cart, stand, or table. The television receiver may fall, causing serious injury to a child or adult, and serious damage to the appliance. Use only with a cart or stand recommended by the manufacturer, or sold with the television receiver. Wall or shelf mounting should follow the manufacturer's instructions, and should use a mounting kit approved by the manufacturer.
- 6A. An appliance and cart combination should be moved with care. Quick stops, excessive force, and uneven surfaces may cause the appliance and cart combination to overturn.
7. Slots and openings in the cabinet and the back or bottom are provided for ventilation, and to insure reliable operation of the television receiver and to protect it from overheating. These openings must not be blocked or covered. The openings should never be blocked by placing the television receiver on a bed, sofa, rug or other similar surface. This television receiver should never be placed near or over a radiator or heat register. This television receiver should not be placed in a built-in installation such as a bookcase unless proper ventilation is provided.
8. Operate only from the type of power source indicated on the marking label. If you are not sure of the type of power supplied to your home consult your television dealer or local power company. For television receivers designed to operate from battery power, refer to the operating instructions.
9. This television receiver is equipped with a polarized alternating-current line plug (a plug having one blade wider than the other). This plug will fit into the power outlet only one way. This is a safety feature. If you are unable to insert the plug fully into the outlet, try reversing the plug. If the plug should still fail to fit, contact your electrician to replace your obsolete outlet. Do not defeat the safety purpose of the polarized plug.
10. Do not allow anything to rest on the power cord. Do not locate this television receiver where the cord will be abused by persons walking on it.
11. Follow all warnings and instructions marked on the television receiver.
12. Do not overload wall outlets and extension cords as this can result in fire or electric shock.
13. Never push objects of any kind into this television receiver through cabinet slots as they may touch dangerous voltage points or short out parts that could result in a fire or electric shock. Never spill liquid of any kind on the television receiver.

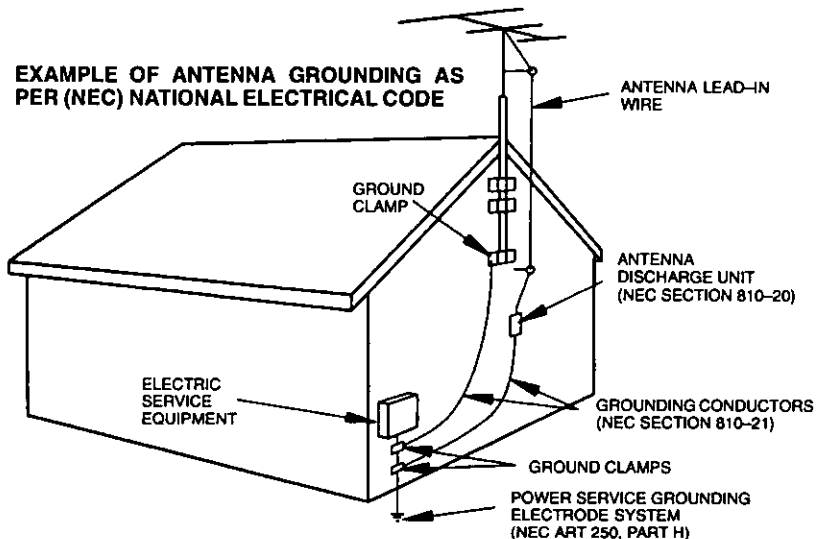

14. If an outside antenna is connected to the television equipment, be sure the antenna system is grounded so as to provide some protection against voltage surges and built up static charges. In the U.S. Section 810 of the National Electrical Code and in Canada Part 1 of the Canadian Electrical Code provides information with respect to proper grounding of the mast and supporting structure, grounding of the lead-in wire to an antenna discharge unit, size of grounding conductors, location of antenna-discharge unit, connection to grounding electrodes, and requirements for the grounding electrode. See Figure.
15. For added protection for this television receiver during a lightning storm, or when it is left unattended and unused for long periods of time, unplug it from the wall outlet and disconnect the antenna. This will prevent damage to the receiver due to lightning and power-line surges.
16. An outside antenna system should not be located in the vicinity of overhead power lines or other electric light or power circuits, or where it can fall into such power lines or circuits. When installing an outside antenna system extreme care should be taken to keep from touching such power lines or circuits as contact with them might be fatal.
17. Unplug this television receiver from the wall outlet, and refer servicing to qualified service personnel under the following conditions:
 - a. When the power cord or plug is damaged or frayed.
 - b. If liquid has been spilled into the television receiver.
 - c. If the television receiver has been exposed to rain or water.
 - d. If the television receiver does not operate normally by following the operating instructions. Adjust only those controls that are covered by the operating instructions as improper adjustment of other controls may result in damage and will often require extensive work by a qualified technician to restore the television receiver to normal operation.
 - e. If the television receiver has been dropped or the cabinet has been damaged.
 - f. When the television receiver exhibits a distinct change in performance – this indicates a need for service.
18. Do not attempt to service this television receiver yourself as opening or removing covers may expose you to dangerous voltage or other hazards. Refer all servicing to qualified service personnel.
19. When replacement parts are required, be sure the service technician has used replacement parts specified by the manufacturer that have the same characteristics as the original part. Unauthorized substitutions may result in fire, electric shock, or other hazards.
20. Upon completion of any service or repairs to this television receiver, ask the service technician to perform routine safety checks to determine that the television is in safe operating condition.
21. **WARNING: To prevent fire or shock hazard, do not expose this appliance to rain or moisture.**
22. **CAUTION: TO PREVENT ELECTRIC SHOCK DO NOT USE THIS (POLARIZED) PLUG WITH A RECEPTACLE OR OTHER OUTLET UNLESS THE BLADES CAN BE FULLY INSERTED TO PREVENT BLADE EXPOSURE.**

NOTE: This equipment is designed to operate in the U.S.A., Canada and other countries where the broadcasting system and AC house current is exactly the same as in the U.S.A. and Canada.

Important Information Regarding Use of Video Games, Computers, Teletext or Other Fixed Image Displays.

The extended use of fixed image program material can cause a permanent "shadow image" on the picture tube. This background image is viewable on normal programs in the form of a stationary fixed image. This type of irreversible picture tube deterioration can be limited by observing the following steps:

- A. Reduce the brightness/contrast setting to a minimum viewing level.
- B. Do not display the fixed image for extended periods of time.
- C. Turn the power off when not in actual use.

NOTE: The marking or retained image on the picture tube resulting from fixed image use is not an operating defect and as such is not covered by Warranty. This product is not designed to display fixed image patterns for extended periods of time.

Specifications

Power Source:	120V, 60Hz, AC
Channel Capability:	181 channels (See chart) VHF 2-13, UHF 14-69, Cable 125 channels
Video Input Jack:	1V p-p, 75 ohm, phono jack type
Audio Input Jacks:	High impedance – 10K ohm, 500mV rms
To Audio AMP Jacks:	0-4.0V rms 10K ohm
Stereo Sound	
Closed Caption Display	

Specifications are subject to change without notice or obligation.

Channel Capability Chart

BAND	USA/CAN
VHF	12
UHF	56
CABLE (Mid-Band)	15
CABLE (Super Band)	14
CABLE (Hyper Band)	28
CABLE (Ultra Band)	56
TOTAL CHANNELS	181

Introduction

Congratulations on Your New Purchase

Your new video component features an all solid state chassis which is designed to give you many years of enjoyment. It was thoroughly tested and adjusted at the factory for best performance.

In order for you to take full advantage of your new video component, please read and follow the installation and operating instructions supplied with this product.

Customer's Record

The model and serial number of this product may be found on its back cover. You should note the model and serial number in the space provided and retain this book as a permanent record of your purchase to aid in identification in the event of theft or loss.

Model Number: _____ Serial Number: _____

Table of Contents

<p>Safety Instructions 2</p> <p>Specifications 3</p> <p>Introduction 4</p> <p>Installation 5</p> <p style="padding-left: 20px;">Receiver Location 5</p> <p style="padding-left: 20px;">Optional External Equipment Connections 5</p> <p style="padding-left: 20px;">AC Power Supply Cord 5</p> <p style="padding-left: 20px;">Remote Control Battery Installation 5</p> <p style="padding-left: 20px;">Antenna/Cable Connections 6</p> <p>Optional Equipment Connection and Operation .. 7</p> <p style="padding-left: 20px;">Stereo Connection (To Audio AMP) 7</p> <p style="padding-left: 20px;">Video/Audio Connection 7</p> <p>Location of Controls (Remote and Receiver) 8</p> <p style="padding-left: 20px;">Quick Reference Control Operation 8</p> <p>Remote Quick Reference Functional Key Chart .. 9</p> <p>Control Operation 10</p> <p style="padding-left: 20px;">Power Button 10</p> <p style="padding-left: 20px;">VOL (Volume) Buttons 10</p> <p style="padding-left: 20px;">Mute Button 10</p> <p style="padding-left: 20px;">R-Tune (Rapid Tune) Button 10</p> <p style="padding-left: 20px;">CH (Channel) Buttons 10</p> <p style="padding-left: 20px;">Keyboard "0 through 9" Buttons 10</p> <p style="padding-left: 20px;">VCR Function Buttons 10</p> <p style="padding-left: 20px;">TV/Video Button 11</p> <p style="padding-left: 20px;">Recall Button 11</p> <p style="padding-left: 20px;">Cable Power Button 11</p>	<p style="padding-left: 20px;">Multi Button 11</p> <p>Main Menu Icons Selection 12</p> <p style="padding-left: 20px;">Trilingual Menu Selection (English/Spanish/French) 12</p> <p style="padding-left: 20px;">Picture Adjustments 13</p> <p style="padding-left: 40px;">Picture Norm 13</p> <p style="padding-left: 40px;">Color, Tint, Brightness, Picture and Sharpness .. 13</p> <p style="padding-left: 20px;">Audio 14</p> <p style="padding-left: 40px;">Audio Mode Selection (Stereo/SAP/Mono) 14</p> <p style="padding-left: 40px;">AI Sound 14</p> <p style="padding-left: 20px;">Lock 15</p> <p style="padding-left: 40px;">Lock and Unlock Game Guard 15</p> <p style="padding-left: 20px;">Channel Caption 16</p> <p style="padding-left: 20px;">Timer Features 17</p> <p style="padding-left: 40px;">Sleep Timer 17</p> <p style="padding-left: 40px;">Program Timer 17</p> <p style="padding-left: 20px;">Set-Up Features 18</p> <p style="padding-left: 40px;">Set Time 18</p> <p style="padding-left: 40px;">Ant (Antenna) 18</p> <p style="padding-left: 40px;">Auto Prog (Program) 19</p> <p style="padding-left: 40px;">Manual Prog (Program) 19</p> <p style="padding-left: 40px;">CC (Closed Caption) On Mute 20</p> <p style="padding-left: 40px;">CC (Closed Caption) Mode 20</p> <p style="padding-left: 40px;">Trilingual Menu System 21</p> <p>Care & Cleaning 21</p> <p style="padding-left: 20px;">Power Loss 21</p> <p>Programming The Universal Remote Control 22</p> <p style="padding-left: 20px;">VCR and Cable Converter Box Infrared Codes 23</p> <p>Troubleshooting Chart 24</p>
--	---

Installation

Receiver Location

This unit is intended to be used with an optional stand or entertainment center. Consult your dealer for available options. Locate for comfortable viewing. Avoid placing where sunlight or other bright light (including reflections) will fall on the screen.

Use of some types of fluorescent lighting may reduce remote control transmitter range.

Adequate ventilation is essential to prevent internal component failure. Keep away from areas of excessive heat or moisture.

To insure optimum color purity do not position magnetic equipment (motors, fans, other speakers, etc.) nearby.

Optional External Equipment Connections

The Video/Audio connections between components can be made with shielded video and audio cables. For best performance, video cables should utilize 75 ohm coaxial shielded wire. Cables are available from your dealer or electronic supply house.

Before you purchase any cables, be sure you know what type of output and input connectors your various components require. Also determine the length of cable you'll need.

AC Power Supply Cord

CAUTION. TO PREVENT ELECTRIC SHOCK, MATCH WIDE BLADE OF PLUG TO WIDE SLOT OF AC OUTLET AND FULLY INSERT. DO NOT USE THIS (POLARIZED) PLUG WITH A RECEPTACLE OR OTHER OUTLET UNLESS THE BLADE CAN BE FULLY INSERTED TO PREVENT BLADE EXPOSURE.

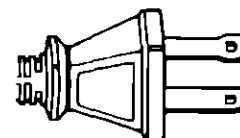

Polarized Plug

Remote Control Battery Installation

Batteries: Use two "AA" batteries.

- 1 Turn the Transmitter face down. To remove top cover, press down on marking and slide cover off in the direction indicated.
- 2 Install the batteries as shown in the battery compartment. (Polarity (+) or (-) must be correct.)
- 3 Replace the cover and slide in reverse until the lock snaps.
- 4 For heavy Remote Control use, replace old batteries with Alkaline batteries for longer life.

Precaution on Battery Use

Incorrect installation can cause battery leakage and corrosion that will damage the Remote Control Transmitter.

Observe the Following Precautions:

- 1 Batteries must be replaced as a pair.
- 2 Do not combine a used battery with a new one.
- 3 Do not mix battery types (Example "Zinc Carbon" with "Alkaline").
- 4 Do not attempt to charge, short-circuit, disassemble, heat or burn used batteries.
- 5 Battery replacement is necessary when Remote Control reacts sporadically or stops operating the Receiver.

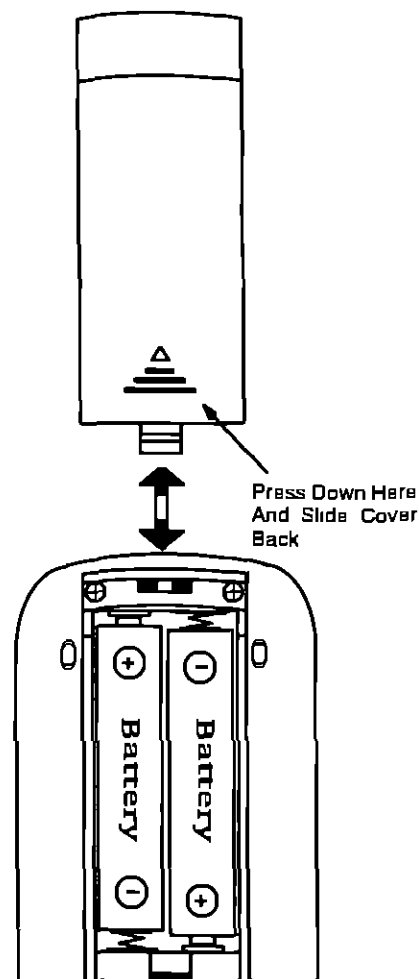

Antenna/Cable Connections

Antenna Connection – For proper reception of VHF/UHF channels an external antenna is required. For best reception an outdoor antenna is recommended. Antenna Mode must be set to TV (Refer to Antenna Mode section)

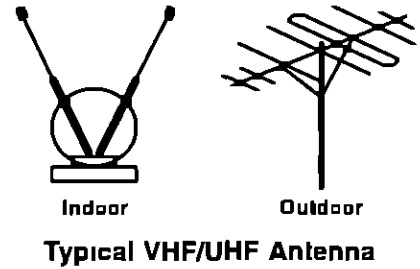

Incoming Cable From Home Antenna (75 Ohm)

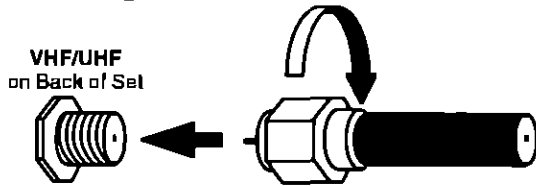

Incoming Cable From Home Antenna (300 Ohm)

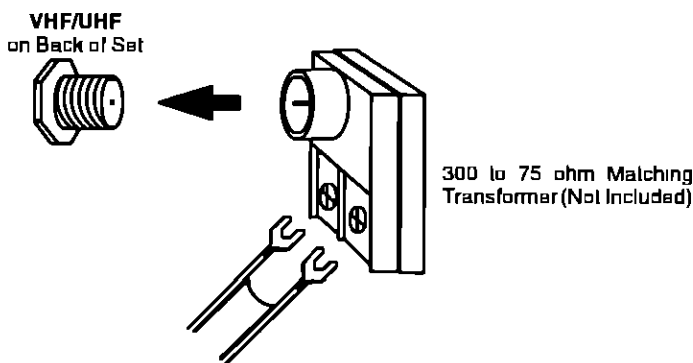

Cable Connection – For reception of cable channels (01–125) connect the cable supplied by your local cable company. Antenna Mode must be set to CABLE (Refer to Antenna Mode section)

Incoming 75 Ohm Cable (From Cable Company)

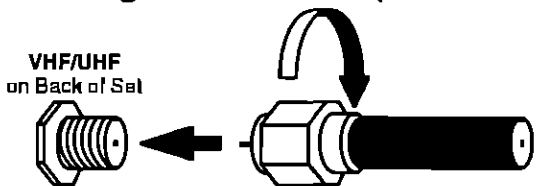

NOTE: Certain cable systems offset some channels to reduce interference or have Premium (scrambled) channels. A cable converter box is required for proper reception. Check with your local Cable company for its compatibility requirements.

Other Video Equipment

VCRs, Video Disc Players, Computers, TV games and Teletext equipment can also be connected to the antenna input connection.

Optional Equipment Connection and Operation

To Audio AMP Connection (Stereo)

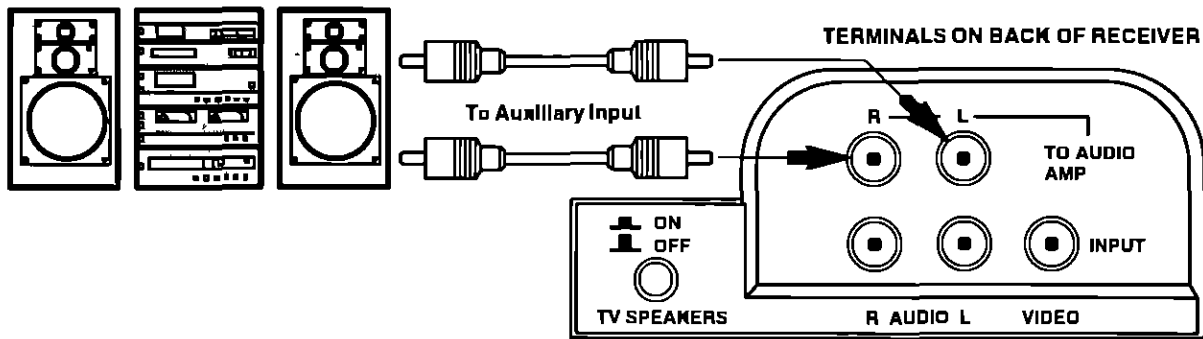



• To Audio AMP

Connect to an external audio amp auxiliary input for monitoring sound through a stereo system

NOTE: "TO AUDIO AMP" terminals cannot be used for external speakers

Adjustment – When an audio amp is connected to "TO AUDIO AMP" terminals as shown

- 1 Press the TV SPEAKERS button (located on back of Receiver) to turn INT SPEAKERS "ON" ()
- 2 Set volume of audio amp to near minimum
- 3 Adjust volume of TV to desired listening level
- 4 Adjust volume of audio amp to match the level of TV
- 5 Press the TV SPEAKERS button (located on back of Receiver) to turn INT SPEAKERS "OFF" ()
- 6 Volume and mute can now be controlled by the TV Remote Control

Video/Audio Connection

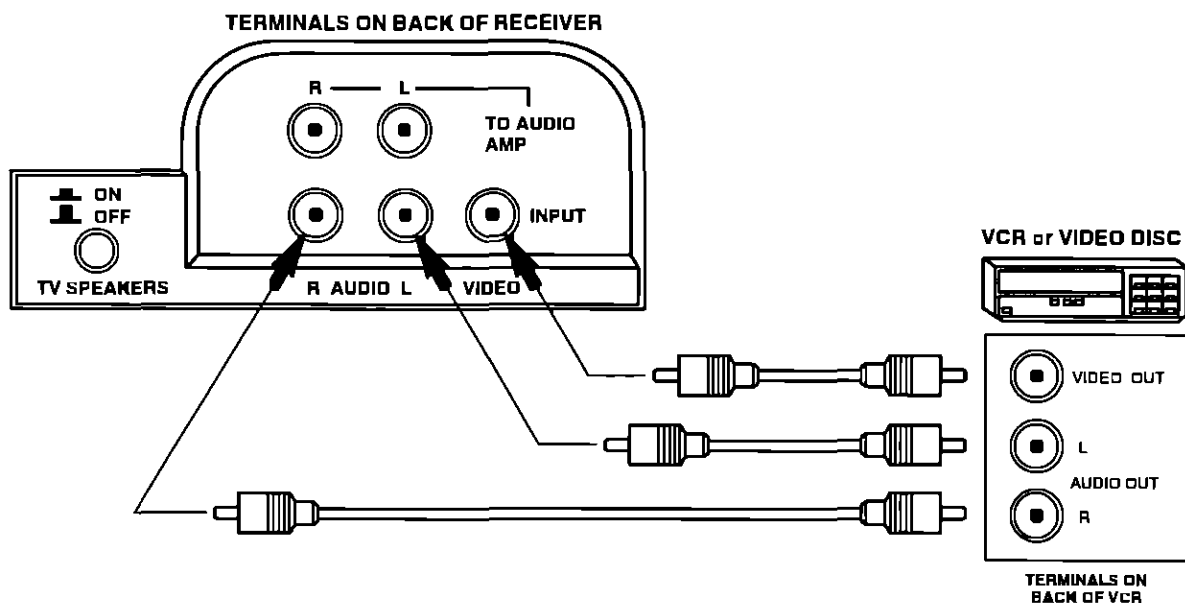

Operation

- 1 Connect optional equipment as shown to INPUT
- 2 Select the Video mode by pressing the TV/VIDEO button
- 3 Operate optional equipment (VCR-VDP) as instructed in Optional Equipment manual

Location of Controls (Remote and Receiver)

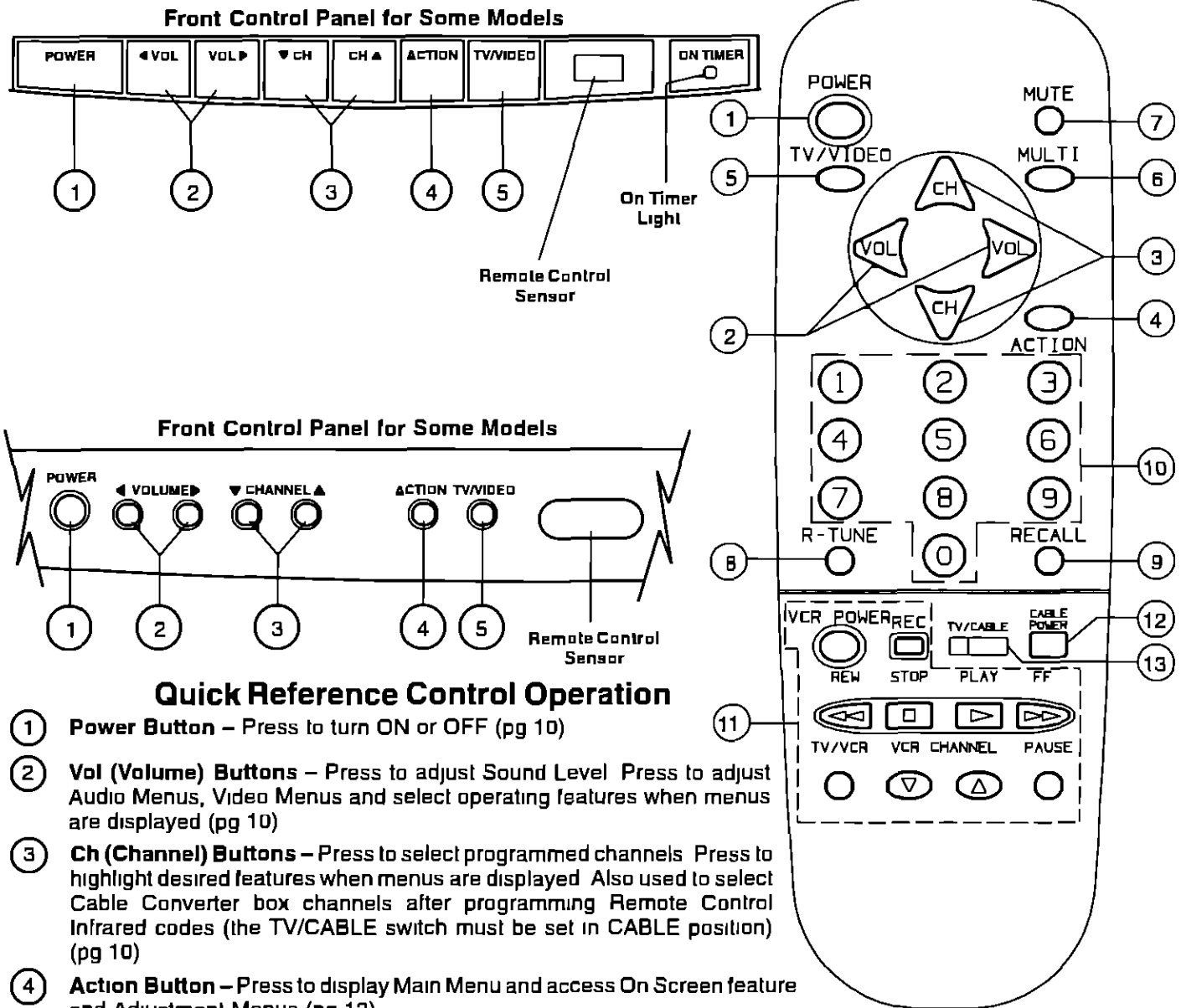













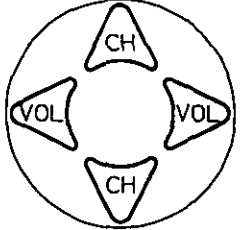







Quick Reference Control Operation

- ① **Power Button** – Press to turn ON or OFF (pg 10)
- ② **Vol (Volume) Buttons** – Press to adjust Sound Level Press to adjust Audio Menus, Video Menus and select operating features when menus are displayed (pg 10)
- ③ **Ch (Channel) Buttons** – Press to select programmed channels Press to highlight desired features when menus are displayed Also used to select Cable Converter box channels after programming Remote Control Infrared codes (the TV/CABLE switch must be set in CABLE position) (pg 10)
- ④ **Action Button** – Press to display Main Menu and access On Screen feature and Adjustment Menus (pg 12)
- ⑤ **TV/Video Button** – Press to select TV or Video Input (pg 11)
- ⑥ **Multi Button** – Programmable to operate up to six Remote Function buttons (pg 11)
- ⑦ **Mute Button** – Press to mute sound A second press returns sound (pg 10)
- ⑧ **R-Tune (Rapid Tune) Button** – Press to switch between two channels (pg 10)
- ⑨ **Recall Button** – Press to display Time, status of Sleep Timer, Channel, Video Mode, Channel Caption and Audio Mode (pg 11)
- ⑩ **Keyboard "0 through 9" Buttons** – Press desired channel number to access any channel(pg 10)
- ⑪ **VCR Function Buttons** – Programmable to operate many brands of VCRs The TV/CABLE switch must be set in TV position (pg 10)
- ⑫ **Cable Power Button** – Programmable to operate selected CATV converter boxes (pg 11)
- ⑬ **TV/Cable Switch** – This switch is used to select the proper mode when programming Remote Control Infrared codes or operating the TV or external equipment (VCR or Cable Converter box)

Remote Control

Quick Reference Functional Key Chart

KEY	OPERATES	FUNCTION
POWER 	TV	Turns TV On and Off
MUTE 	TV	Mutes TV Audio
TV/VIDEO 	TV	Selects the TV Input Mode
MULTI 	ALL COMPONENTS	Programmable Button that can operate up to six Remote Functions at once
ACTION 	TV	Activates TV Menus
	TV CABLE	Channel Up/Down, Menu Navigation Channel Up/Down
	TV CABLE	Volume Up/Down, Menu Navigation Search For Infrared Code When Programming Remote
① ② ③ ④ ⑤ ⑥ ⑦ ⑧ ⑨ ⑩	TV VCR CABLE	Selects Channel Selects code in Game Guard Menu Selects Channel in Channel Caption Menu Selects Channel in Timer Menu Selects Infrared code when programming remote Selects Infrared code when programming remote
R-TUNE 	TV	Selects Previously Tuned Channel
RECALL 	TV	Displays Channel, Time, and Audio Mode
TV/CABLE 	TV CABLE	TV Mode Selection for Remote Control Also VCR Mode Selection for Remote Control CATV Mode Selection for Remote Control
CABLE POWER 	CABLE	Turns Cable On and Off
VCR POWER 	VCR	Turns VCR On and Off
REC  REW STOP PLAY FF  TV/VCR VCR CHANNEL PAUSE 	VCR	Standard VCR Control Keys  Record  Rewind  Stop  Play  Fast Forward  Selects TV/VCR Mode  VCR Channel Up/Down  Pause

Control Operation

Power Button — Press the POWER button to turn ON Press again to turn OFF



VOL (Volume Buttons) — Press the VOLUME (VOL) LEFT or RIGHT button for desired listening level (when On Screen menus are not displayed)

Located On Remote Control

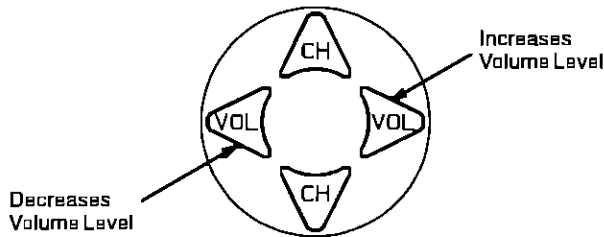

CH (Channel) Buttons

Option 1.

Press the CHANNEL (CH) UP or DOWN button to sequentially scan through programmed channels (when On Screen menus are not displayed)

NOTE: TV/CABLE switch (located on Remote) must be set in TV position (Left)

Located On Remote Control

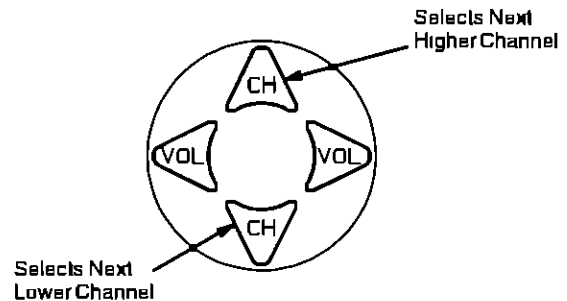

Mute Button — Press the MUTE button to quickly reduce sound level (Mute will appear on screen) Press again to restore sound



R-Tune (Rapid Tune) Button — Press the R-TUNE (RAPID TUNE) button to instantly switch between the last two channels selected (without any On Screen display being activated)

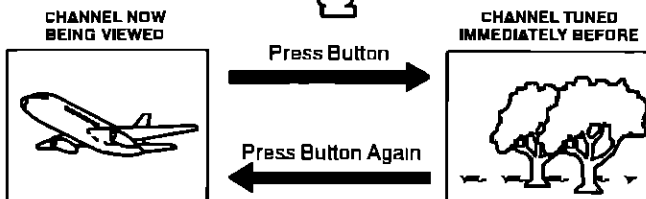

Keyboard "0 through 9" Buttons

Option 2.

Press two digits on the keyboard 0 through 9 buttons (Example press 0, then 5 for channel 05) For channels over 99, press three digits on keyboard

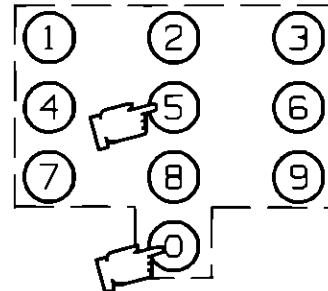

VCR Function Buttons — The VCR FUNCTION buttons have been designed to operate numerous brands of VCRs The infrared code must be obtained prior to use (Please refer to Programming the Universal Remote for programming instructions)

NOTE: The TV/CABLE switch (located on Remote) must be in the TV position (Left)

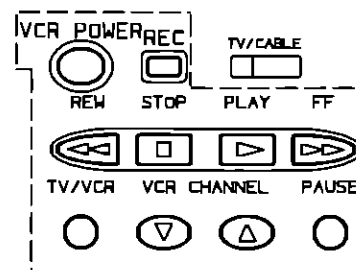

Helpful Hints:

- Helpful information will display On Screen momentarily when Receiver is first turned on and when the channel is changed
- When using keyboard entry for channels 10,11 and 12 in the CABLE mode there is a slight delay before channel change because of the capability of tuning cable channels 100 to 125

NOTE. If no sound is heard from the speakers, press the TV Speaker button located on back of Receiver

TV/Video Button – Press the TV/VIDEO button to select desired input

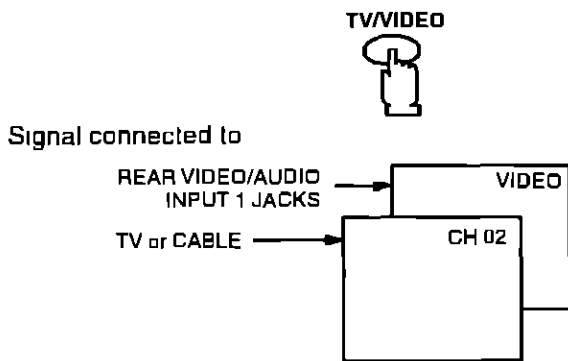

Recall Button – Press the RECALL button to review

- Audio Mode status
- CH number or Video Input selected
- Sleep Timer status
- Clock time
- Channel Caption (Station Identifier)

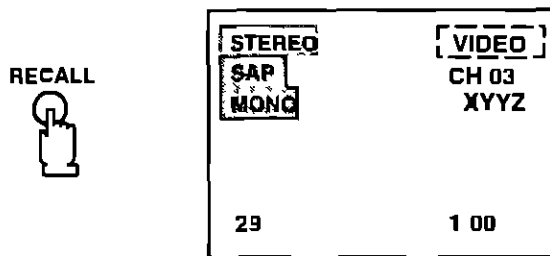

Cable Power Button – The CABLE POWER button on the Remote Control has been designed to operate selected brands of Cable Television Converter boxes. The proper cable television converter box infrared code must be obtained prior to use (Please refer to Programming the Universal Remote for programming instructions) The Remote Control TV/CABLE switch should be in the CABLE position

NOTE: The CHANNEL UP and DOWN buttons on the Remote may be used for selecting Cable Converter box channels

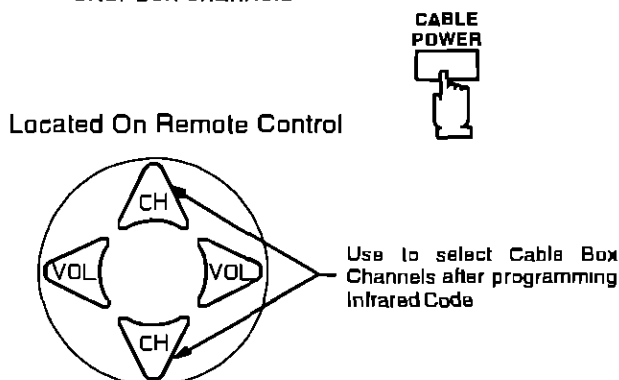

Multi Button

The MULTI button can be programmed to operate up to 6 Remote function buttons at the same time. For Example: TV Power/On, VCR Power/On (selected brands) can be operated at the same time with one press of the MULTI button

Procedure

- 1 First program the Remote for the selected VCR Infrared access code. Confirm that the Remote Control is compatible with the equipment
- 2 Face the Remote Control transmitter away from all equipment remote sensors
- 3 Press and hold down the Remote TV Power button, then press and hold down the MULTI button at the same time. Release buttons (All previous commands will be erased)

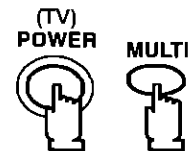

PRESS SIMULTANEOUSLY

- 4 Press a maximum of 6 Function buttons on the Remote. Each button you press is equal to one function. If six Remote button functions are entered, all will register in the MULTI button memory in the sequence entered. When less than six Remote button functions are entered, press the MULTI button to end the program mode (Waiting more than 30 seconds without pressing another button will also end the program mode)

The following is an example of Remote functions that can be programmed into the MULTI button

- TV Power – For turning TV ON and OFF
 - VCR Power – For turning VCR ON and OFF (selected brands after programming it's Infrared access code, if necessary)
- Both can be turned ON or OFF with one press of the MULTI button

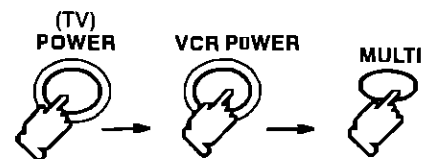

To delete entered functions – Repeat step 3. Now you can enter from one to six different Remote functions

NOTE:

You can also program the MULTI button to perform most individual Remote Control button functions. Buttons which continuously perform a function as long as pressed (Volume Up/Down, Channel Up/Down, etc) cannot be programmed. Only those buttons which perform a function when initially pressed (Power On/Off, Mute, Direct Channel Entry, etc) can be programmed

Main Menu Icons Selection

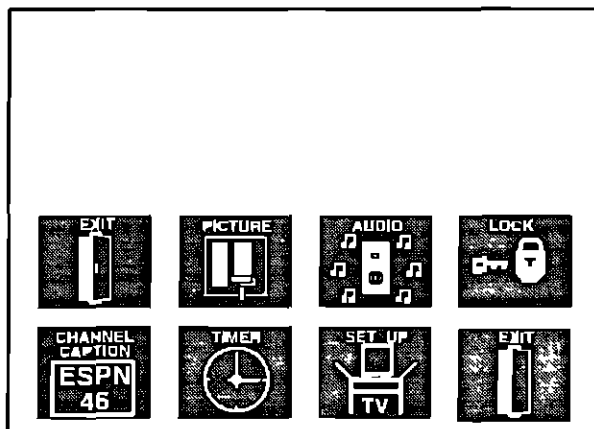

Located On Remote Control

Displays and Exits Menus

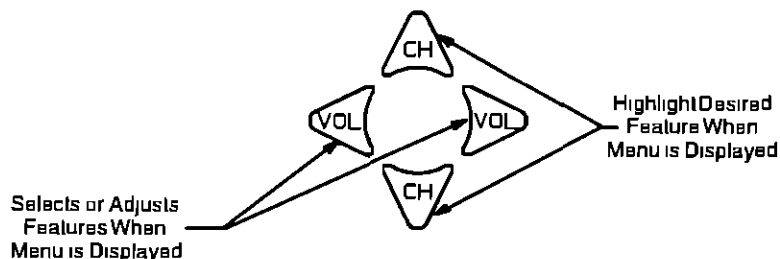

- 1 Press the ACTION button to display the Main Menu with Icons
- 2 Press the CH UP or DOWN and the VOL LEFT or RIGHT buttons to select the desired Icon when the Main Menu is displayed (selected Icon will be indicated in Red) Press the VOL buttons for left and right movement and the CH buttons for up or down movement
- 3 Press the ACTION button after selecting the desired Icon to access sub menus
- 4 To exit the Main Menu first select the EXIT Icon, then press the ACTION button

Trilingual Menu Selection

The Language Menu is factory set to ENGLISH. Follow these instructions to change the Language Menu to Spanish or French and back to English.

- 1 Press the ACTION button to display the Main Menu
- 2 Press the CH UP/DOWN and VOL LEFT/RIGHT buttons to highlight the SET-UP Icon
- 3 Press the ACTION button to display the SET-UP Menu

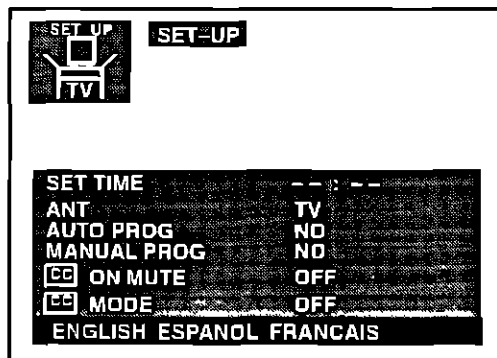

- 4 Press the CH UP or DOWN button to highlight "ENGLISH ESPANOL FRANCAIS "
- 5 Press the VOL LEFT or RIGHT button to select "ENGLISH", "ESPANOL" or "FRANCAIS"
- 6 Press the ACTION button twice to exit the SET-UP Menu

Picture Adjustments

- Picture Norm
- Color
- Tint
- Brightness
- Picture
- Sharpness

Located On Remote Control

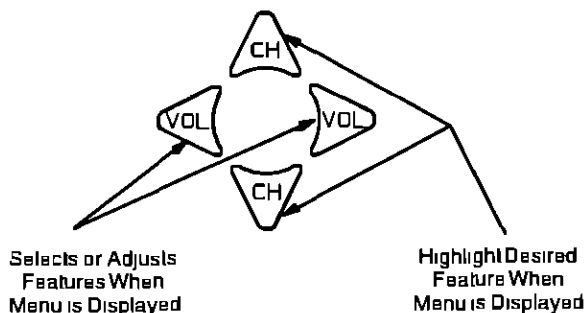

Displays and Exits Menus



Helpful Hints:

Picture Adjustments

COLOR – adjust for desired color intensity

TINT – adjust for natural flesh tones

BRIGHTNESS – adjust so dark areas of picture just become black for a crisp detail

PICTURE – adjust so the white areas of the picture are to your liking

SHARPNESS – adjust for best clarity of outline detail

Picture Norm – This feature is used to reset Color, Tint, Brightness, Picture and Sharpness adjustments back to a factory preset level

- 1 Press the ACTION button to display the Main Menu
- 2 Press the CH UP/DOWN and VOL LEFT/RIGHT buttons to highlight the Picture Icon
- 3 Press the ACTION button to display the Picture Adjustment Menu

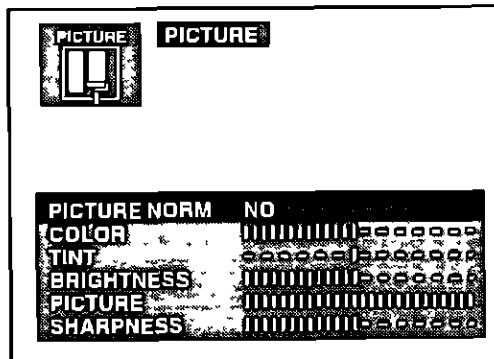

- 4 Press the CH UP or DOWN button to highlight "PICTURE NORM" (if necessary)
- 5 Press the VOL LEFT or RIGHT button to select "SET" to Normalize Color, Tint, Brightness, Picture and Sharpness
- 6 Press the ACTION button twice to exit the Picture Adjustment Menu

Color, Tint, Brightness, Picture & Sharpness Adjustments

- 1 Press the ACTION button to display the Main Menu
- 2 Press the CH UP/DOWN and VOL LEFT/RIGHT buttons to highlight the Picture Icon
- 3 Press the ACTION button to display the Picture Adjustment Menu

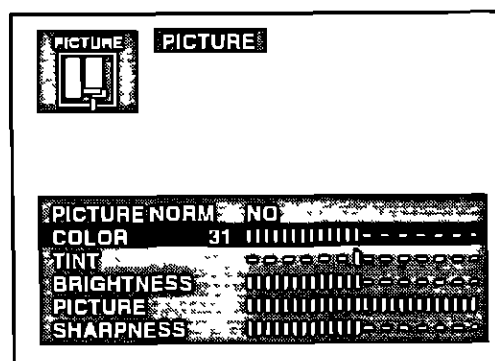

- 4 Press the CH UP or DOWN button to highlight the desired Picture Adjustment (Color, Tint, Brightness, Picture or Sharpness)
- 5 Press the VOL LEFT or RIGHT button to adjust your selection (The selected Picture Adjustment will be displayed)
- 6 Repeat steps 4 and 5 for the remaining Picture Adjustments
- 7 Press the ACTION button twice to exit the Picture Adjustment Menu

Audio

- Audio Mode
- AI Sound

Located On Remote Control

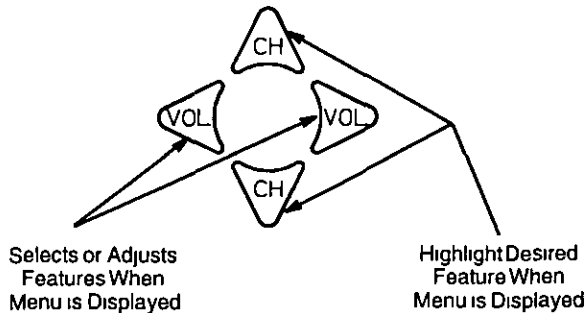

Displays and Exits Menus



Audio Mode (Stereo/SAP/Mono)

When Audio is broadcast in Stereo or SAP an ON Screen display will appear on initial "Turn On" and "Channel Change". The available choices will be indicated in red.

- 1 Press the ACTION button to display the Main Menu
- 2 Press the CH UP/DOWN and VOL LEFT/RIGHT buttons to highlight the Audio Icon
- 3 Press the ACTION button to select and display the Audio Adjustment Menu

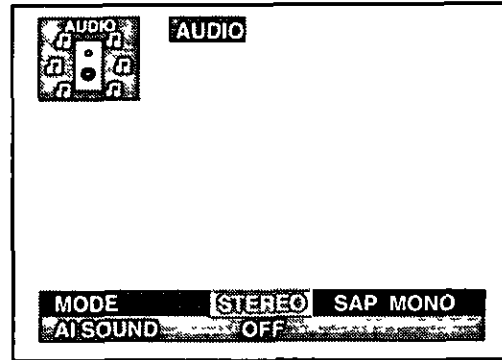

- 4 Press the CH UP or DOWN button to highlight MODE
- 5 Press the VOL LEFT or RIGHT button to highlight Stereo, SAP (Second Audio Programming) or Mono
- 6 Press the ACTION button twice to exit the Audio Adjustment Menu

AI Sound – This feature regulates the volume between programs and commercial audio to maintain a constant sound output level

- 1 Press the ACTION button to display the Main Menu
- 2 Press the CH UP/DOWN and VOL LEFT/RIGHT buttons to highlight the Audio Icon
- 3 Press the ACTION button to display the Audio Adjustment Menu

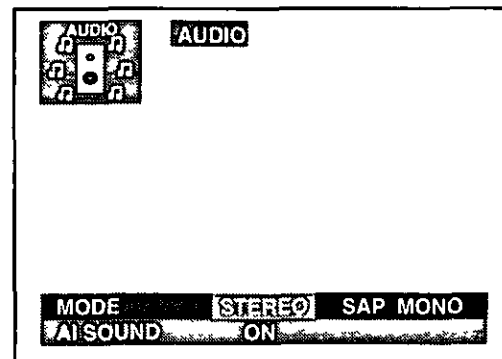

- 4 Press the CH UP or DOWN button to highlight AI SOUND
- 5 Press the VOL LEFT or RIGHT button to select AI SOUND "ON" or "OFF"
- 6 Press the ACTION button twice to exit the Audio Adjustment Menu

Helpful Hints:

STEREO – Two channel Audio reception
SAP – Second Audio Programming (typically used for bilingual audio)
MONO – Use when stereo signal is weak

Lock

Located On Remote Control

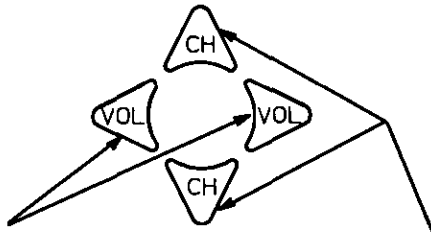

Selects or Adjusts Features When Menu is Displayed

Highlight Desired Feature When Menu is Displayed

Displays and Exits Menus



Lock Game Guard – Prevents video games and other video sources from being viewed. Channel 3, 4 and video inputs are locked out for 12, 24 or 48 hours.

NOTE: Be sure to understand this feature before attempting its use. **Use a code that you will easily remember or write down code on a piece of paper.**

- 1 Press the ACTION button to display the Main Menu
- 2 Press the CH UP/DOWN and VOL LEFT/RIGHT buttons to highlight the Lock Icon
- 3 Press the ACTION button to display the Lock (Game Guard) Menu

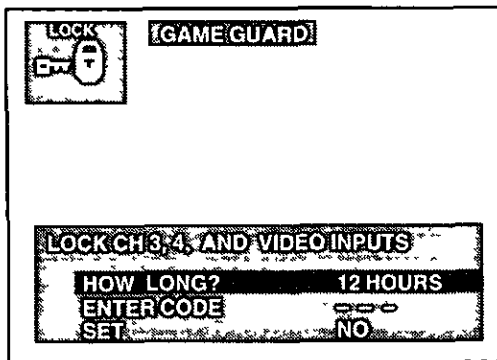

- 4 "HOW LONG" should already be highlighted. Press the VOL RIGHT button to select the desired amount of time (12, 24 or 48 hours) for Game Guard (Lock-out) to be activated.
- 5 Press the CH DOWN button to highlight "ENTER CODE". Then enter a 3 digit code with the Remote Control Keyboard. "SET" should be highlighted after entering the last digit.
IMPORTANT NOTE: Use a code you can easily remember or write down the code on a piece of paper.
- 6 Press the VOL LEFT or RIGHT button after entering three digit code. "Game Guard Locked" will display On Screen.

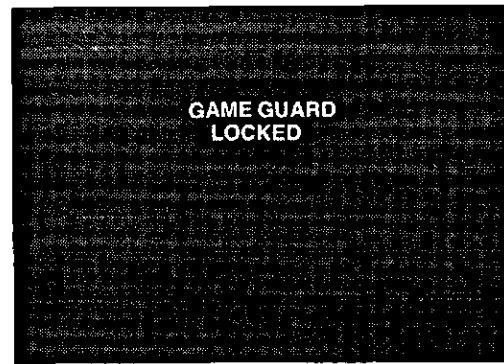

Game Guard Activated

Unlock Game Guard

To unlock the Game Guard feature, repeat steps 1 through 3. Enter the same 3 digit code previously used in step 5 with Remote Control Keyboard.

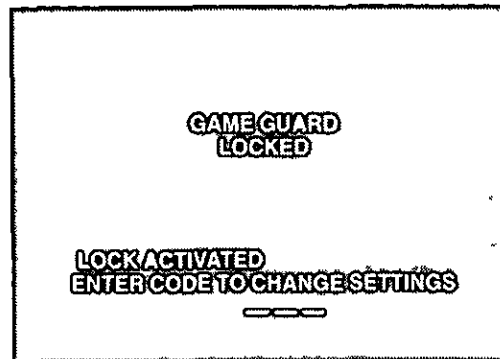

Enter Same 3 Digit Code Previously Used

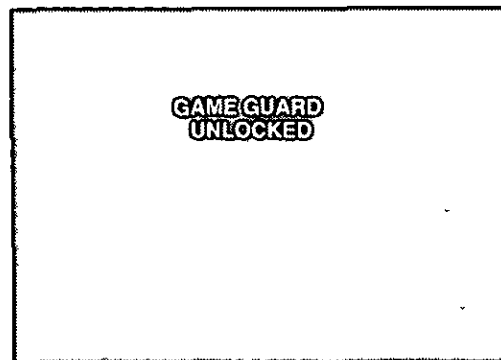

If 3 Digit Code Is The Same

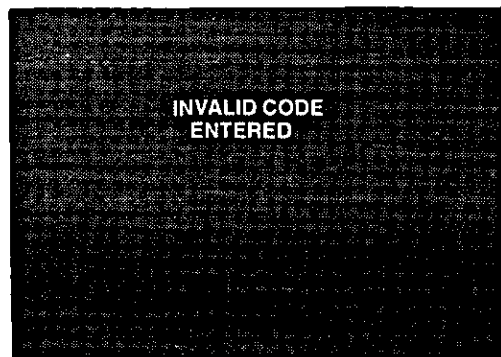

If 3 Digit Code Is Not The Same

Channel Caption

Channel Caption (Station Identifier)

This feature allows you to enter the call names of up to 30 stations into memory (using up to 4 characters for each station) The call name will then display along with the channel number when changing channels or pressing RECALL

Located On Remote Control

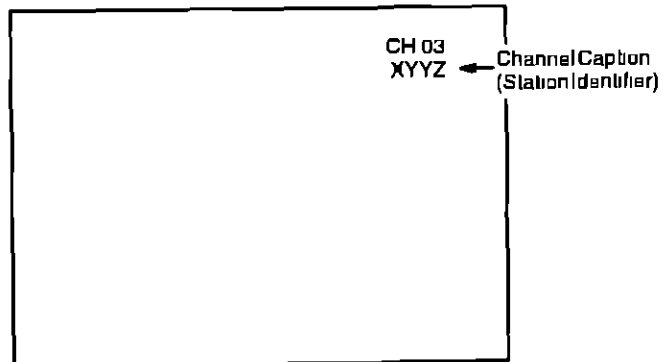
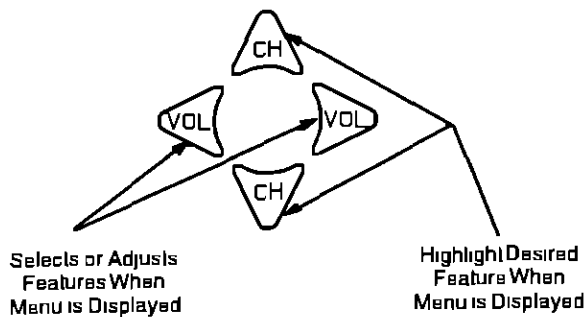

- 1 Press the ACTION button to display the Main Menu
- 2 Press the CH UP/DOWN and VOL LEFT/RIGHT buttons to highlight the Channel Caption Icon
- 3 Press the ACTION button to select and display the Channel Caption Menu

Displays and Exits Menus

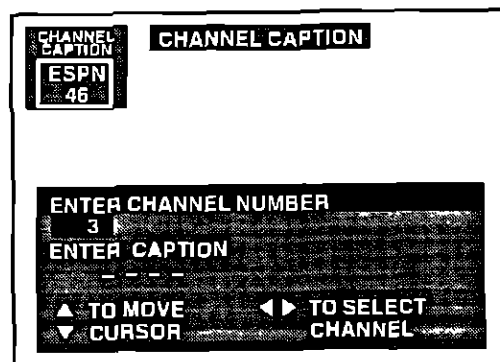

- 4 Press the VOL LEFT or RIGHT button, or use the Remote Control Keyboard (0-9), to enter the channel number you wish to assign a Station Identifier
- 5 Press the CH DOWN button to highlight "ENTER CAPTION"
- 6 Press the VOL LEFT or RIGHT button to select first character in Station Identifier Then press the CH DOWN button to move cursor to the second position and repeat until the complete Station Identifier is entered (up to 4 characters)
- 7 Press the CH UP or DOWN button to highlight "ENTER CHANNEL NUMBER" Then repeat steps 4 through 6 to continue adding Channel Station Identifier(s)
- 8 Press the ACTION button twice to exit the Channel Caption Menu

Helpful Hints:

When the Maximum amount of station identifiers are entered, "FULL" will be displayed in the caption position

NOTE: To delete a Channel Caption (Station Identifier) from memory all four character positions in the "ENTER CAPTION" area must display a dash (-)

Timer Features

- Sleep Timer
- Program Timer

Special Feature:

Automatic turn "OFF" after 90 minutes.

The TV has a special feature that will shut itself OFF after 90 minutes when turned ON by the program timer unless a function key is pressed during the 90 minutes

This feature is useful so that the TV will not remain ON unattended for an extended period of time

Programming the OFF timer will also cancel the automatic OFF feature

Sleep Timer — This feature is used for automatic turn off in 30, 60 or 90 minutes

NOTE: Display will flash 3, 2 and 1 to indicate the last three remaining minutes prior to turn off. The Recall display will also appear

- 1 Press the ACTION button to display the Main Menu
- 2 Press the CH UP/DOWN and VOL LEFT/RIGHT buttons to highlight the Timer Icon
- 3 Press the ACTION button to display the Timer Control Menu SLEEP TIMER position should already be highlighted. If not, press CH UP/DOWN to highlight SLEEP TIMER

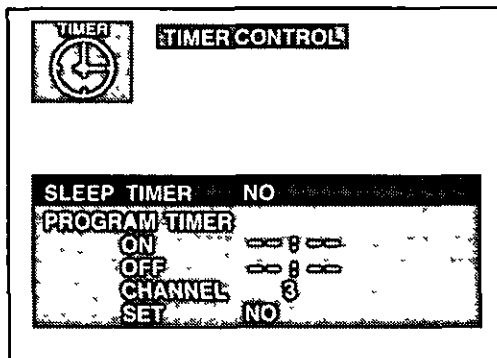

- 4 Press the VOL RIGHT button to select 30, 60 or 90 minutes (Sleep Timer will be activated)
- 5 Press the ACTION button twice to exit the Timer Control Menu

NOTE: To deactivate Sleep Timer repeat steps 1 through 4. In step 4 select "NO" instead of minutes

Helpful Hints:

Press the RECALL button to display the remaining minutes for Sleep Timer, the time will display in the bottom left corner

Program Timer — This feature is capable of turning the TV on, tuned to a desired channel and off at a predetermined time (one day or daily)

NOTE: The clock must be set for this feature to operate (Refer to the Set-Up Menu to set time)

- 1 Press the ACTION button to display the Main Menu
- 2 Press the CH UP/DOWN and VOL LEFT/RIGHT buttons to highlight the Timer Icon
- 3 Press the ACTION button to display the Timer Control Menu

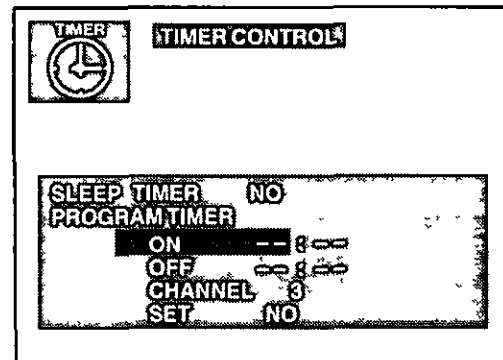

- 4 Press the CH DOWN button to highlight "ON" (time)
- 5 Press the VOL LEFT or RIGHT button repeatedly to set hours (set AM/PM accordingly)
- 6 Press the CH DOWN button to highlight the minutes position
- 7 Press the VOL LEFT or RIGHT button repeatedly to set minutes
- 8 Press the CH DOWN button to highlight "OFF" (time)
- 9 Repeat steps 5 through 7 for setting "OFF" (time)
- 10 Press the CH DOWN button to highlight "CHANNEL"
- 11 Press the VOL LEFT or RIGHT button or use the Remote Control Keyboard to enter the channel number desired when the set turns "ON"
- 12 Press the CH DOWN button to highlight "SET"
- 13 Press the VOL RIGHT button to select
 - NO – not activated
 - ONE DAY – activated
 - DAILY – activated

NOTE: The Timer light will come "ON" when Timer is activated (In some Models)

- 14 Press the ACTION button twice to exit the Timer Control Menu

NOTE: To deactivate Program Timer select "NO" in step 13

Helpful Hints:

- If the Program Timer "ON" functions while the set is operating, the set will automatically tune to the channel designated in the Timer Program

Set-Up Features

- Set Time
- Ant (Antenna)
- Auto Prog (Program)
- Manual Prog (Program)
- CC (Closed Caption) on Mute
- CC (Closed Caption) Mode
- English, Espanol (Spanish) or Francais (French)

Located On Remote Control

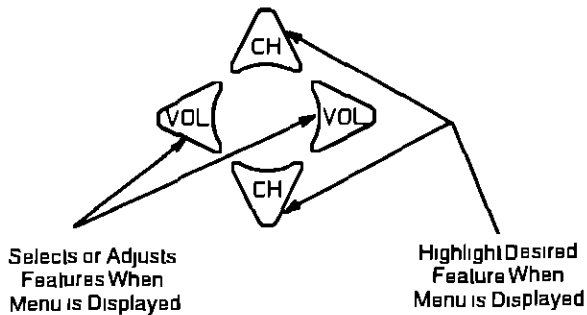

Displays and Exits Menus



Set Time — Clock (when set) will display on screen at initial "Turn On", after a channel change and when pressing the RECALL button. The time must be set first in order to operate the Program ON/OFF Timer.

- 1 Press the ACTION button to display the Main Menu
- 2 Press the CH UP/DOWN and VOL LEFT/RIGHT buttons to highlight the Set-Up Icon
- 3 Press the ACTION button to display the Set-Up Menu, "SET TIME" will be highlighted

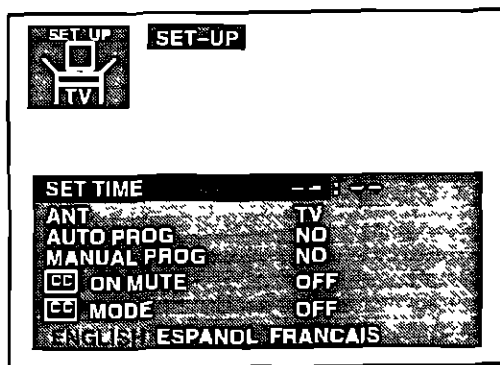

- 4 Press the VOL LEFT or RIGHT button to set hours (set AM/PM accordingly)
- 5 Press the CH DOWN button to select minutes position
- 6 Press the VOL LEFT or RIGHT button repeatedly to set minutes
- 7 Press the ACTION button twice to exit the Set-Up Menu

Ant (Antenna)

The proper input mode must be selected for the type of signal at the antenna input.

- TV mode is used when the Receiver is not connected to a cable TV system, for example when using a VHF/UHF antenna (channels 02 – 69)
- Cable mode is used when the Receiver is connected to a Cable TV system and you are not using a cable company converter box (channels 01 – 125)

- 1 Press the ACTION button to display the Main Menu
- 2 Press the CH UP/DOWN and VOL LEFT/RIGHT buttons to highlight the Set-Up Icon
- 3 Press the ACTION button to display the Set-Up Menu

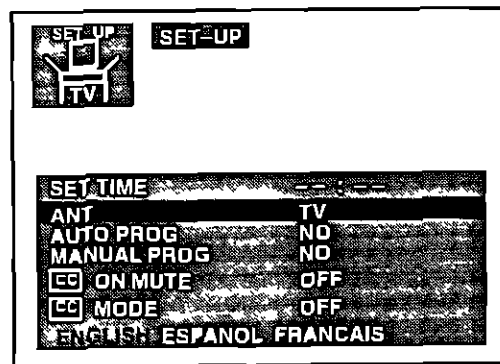

- 4 Press the CH DOWN button to highlight "ANT"
- 5 Press the VOL LEFT or RIGHT button to select TV or CABLE
- 6 Press the ACTION button twice to exit the Set-Up Menu

Set-up Features (cont.)

Located On Remote Control

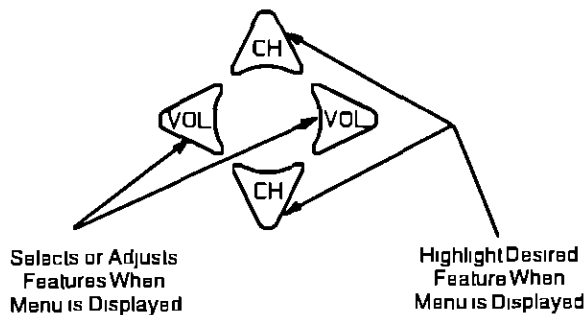

Displays and Exits Menus



Auto Prog (Program) – This feature allows you to place all channels with a video signal into Channel Scan Memory

- 1 Press the ACTION button to display the Main Menu
- 2 Press the CH UP/DOWN and VOL LEFT/RIGHT buttons to highlight the Set-Up Icon
- 3 Press the ACTION button to display the Set-Up Menu

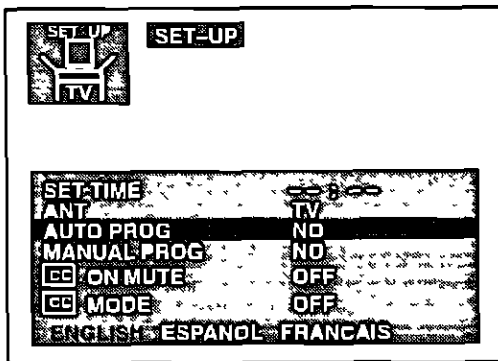

- 4 Press the CH DOWN button to highlight "AUTO PROG"
- 5 Press the VOL LEFT or RIGHT button to start Auto Programming. Channels will automatically advance until all channels have been scanned
- 6 Press the ACTION button twice after completion of Auto Programming to exit the Set-Up Menu

NOTE: Channel numbers with signal present will turn blue which indicates stored in Channel Scan Memory

Manual Prog (Program) – This feature allows you to select which channels are placed into Channel Scan Memory

- 1 Press the ACTION button to display the Main Menu
- 2 Press the CH UP/DOWN and VOL LEFT/RIGHT buttons to highlight the Set-Up Icon
- 3 Press the ACTION button to display the Set-Up Menu

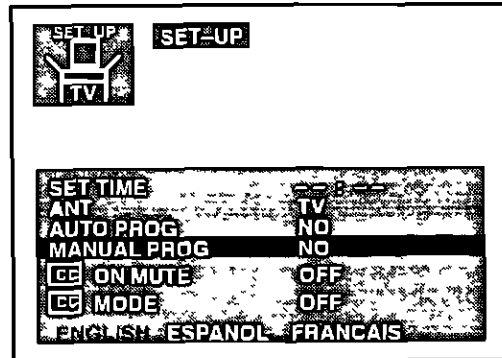

- 4 Press the CH DOWN button to highlight "MANUAL PROG"
- 5 Press the VOL LEFT or RIGHT button to display the Manual Programming Menu

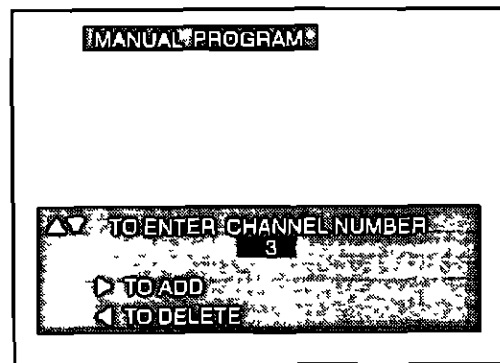

- 6 Use the CH UP or DOWN button or the Remote Keyboard "0 through 9" buttons to select channels
- 7 Press the VOL RIGHT button to add channel(s) to memory (Blue). Press the VOL LEFT button to delete channels from memory (Yellow)
- 8 Repeat steps 6 and 7 to continue adding or deleting channels
- 9 Press the ACTION button twice to exit the Manual Programming Menu

Set-up Features (cont.)

Located On Remote Control

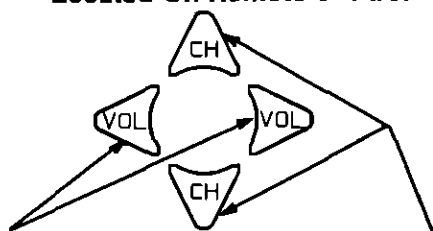

Selects or Adjusts Features When Menu is Displayed

Highlight Desired Feature When Menu is Displayed

Displays and Exits Menus



CC (Closed Caption) On Mute

Activates the On Screen Closed Captioning when the MUTE button on the Remote Control is pressed. To deactivate press the MUTE button again.

NOTE: This feature only functions when the Closed Caption Mode is in the "OFF" position. The program being viewed must be broadcast with Closed Caption (Refer to your local TV guide.)

- 1 Press the ACTION button to display the Main Menu
- 2 Press the CH DOWN and VOL RIGHT buttons to select the Set-Up Icon
- 3 Press the ACTION button to display the Set-Up Menu

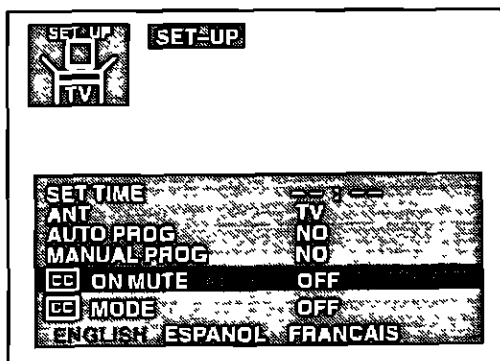

- 4 Press the CH DOWN button to highlight "CC ON MUTE"
- 5 Press the VOL RIGHT button to select OFF, C1 or C2 Mode

Recommended Set-Up:

- Place CC ON MUTE into the C1 Mode
- Press the CH DOWN button to select "CC MODE"
- Press the VOL RIGHT button to select "OFF"

Helpful Hints:

- Closed Caption information may be transmitted on either or both Caption Modes

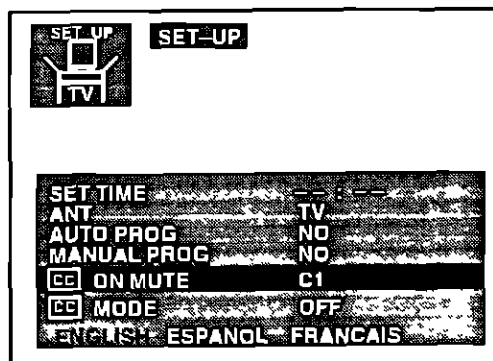

- 6 Press the ACTION button twice to exit the Set-Up Menu
- 7 Press the MUTE button when the program being viewed is broadcast with Closed Caption to activate. Press again to deactivate.

CC (Closed Caption) Mode

This Receiver has a built in decoder that provides a visual depiction of the audio portion of a television program in the form of written words across the screen (White or Colored letters on a black background). It allows the viewer to read the dialogue of a television program or other information.

- 1 Press the ACTION button to display the Main Menu
- 2 Press the CH UP/DOWN and VOL LEFT/RIGHT buttons to select the Set-Up Icon
- 3 Press the ACTION button to display the Set-Up Menu

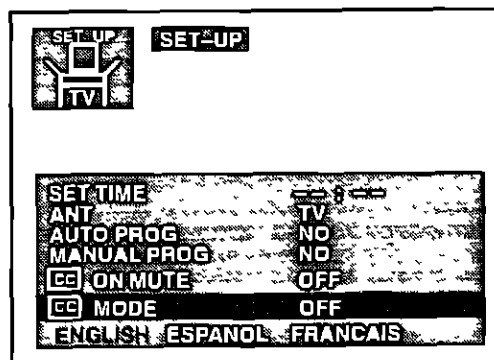

- 4 Press the CH DOWN button to highlight "CC MODE"
- 5 Press the VOL RIGHT button to select OFF, C1, or C2
 - OFF – Recommended mode when you do not wish to view Closed Caption
 - C1 – For video related information that can be displayed (up to 4 lines of script strategically placed on the television screen so that it does not obstruct relevant parts of the picture). Script can be in any language
 - C2 – Another mode used for video related information that can be displayed (up to 4 lines of script strategically placed on the television screen so that it does not obstruct relevant parts of the picture)
- 6 Press the ACTION button twice to exit the Set-Up Menu

Set-up Features (cont.)

Trilingual Menu System

Located On Remote Control

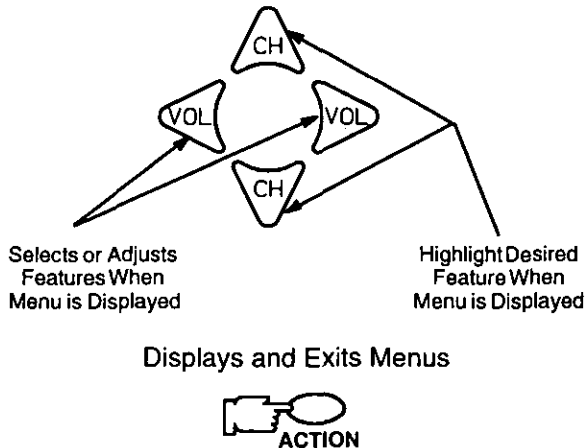

The Language Menu is factory set to ENGLISH. Follow these instructions to change the Language Menu to Spanish or French and back to English.

1. Press the ACTION button to display the Main Menu.
2. Press the CH UP/DOWN and VOL LEFT/RIGHT buttons to highlight the SET-UP Icon.
3. Press the ACTION button to display the Set-Up Menu.

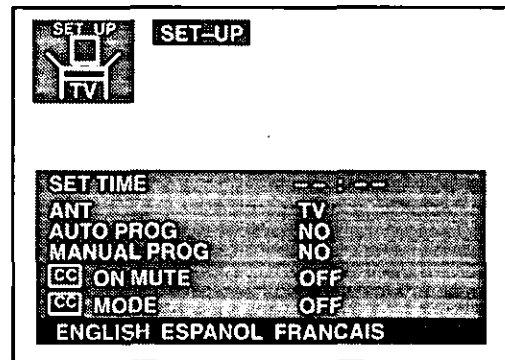

4. Press the CH UP or DOWN button to highlight "ENGLISH ESPANOL FRANCAIS."
5. Press the VOL LEFT or RIGHT button to select "ENGLISH", "ESPANOL" or "FRANCAIS".
6. Press the ACTION button twice to exit the Set-Up Menu.

Helpful Hints:

Language selection Menu does not affect Close Caption transmitted information.

Care and Cleaning

Picture Tube (Turn set off)

Use a mild soap solution or window cleaner and a clean cloth. DO NOT USE ABRASIVE CLEANERS. Avoid excessive moisture and wipe dry.

Plastic Cabinets

Wipe the cabinet with a soft cloth dampened with water or a mild detergent solution and wipe dry with a soft clean cloth. Avoid excessive moisture. Do not use benzene, thinners or other petroleum based cleaners.

Wood Cabinets

When dusting or polishing the cabinet, use a clean soft cloth and stroke straight with the grain. An occasional coat of furniture polish will help preserve the finish. Do not use benzene, thinners or other petroleum based cleaners. Do not place objects made of plastic or rubber directly on top of the cabinet. A chemical reaction could result causing permanent marring of the finish.

Remote Control Transmitter

Do not use benzene, thinners or other petroleum based cleaners to clean the Remote Control Transmitter. To clean, wipe with a soft cloth slightly moistened with a mild detergent and then wipe dry with a soft clean cloth.

Power Loss

Prolonged power interruption causes the following features to reset to their factory preset state.

FEATURE	FACTORY PRESET STATE	FEATURE	FACTORY PRESET STATE
POWER	OFF	CLOCK	NOT SET
VOLUME	APPROX.-1/3	SLEEP TIMER	NO/OFF
CHANNEL	CH 03	TIMER	NO/OFF
PROGRAM MEMORY	UNPROGRAMMED	ANTENNA MODE	CABLE
VIDEO MENUS	NORMALIZED	TV/VIDEO	TV
STEREO/SAP/MONO	STEREO	TRILINGUAL MENU	ENGLISH

Programming The Universal Remote Control

VCR

Preferred Procedure – Code Known Programming Universal Remote Using Infra-Red Access Codes for VCRs

- Determine brand of VCR.
- Identify code(s) associated with the brand in the infra-red code index for VCRs (located in this manual).

Procedure

1. Place the Remote TV/CABLE switch into the TV position (Left).



2. Press and hold VCR POWER button down on Universal Remote.



3. Enter two digit code using keyboard "0 through 9" buttons. Release VCR Power button. The Universal Remote is now programmed.

NOTE: Some brands have multiple codes. Repeat procedure using each code listed until VCR responds correctly.

Alternate Procedure – Code Unknown Programming Universal Remote Using the "Sequence Method" for VCRs

- Confirm VCR is plugged in and operating properly, then turn OFF.

Procedure

1. Place the Remote TV/CABLE switch into the TV position (Left).



2. Press and hold the VCR POWER button down on Universal Remote.



3. Press VOL RIGHT button repeatedly. Check for the VCR to turn ON after each press. When the VCR turns ON, release VCR Power button. The proper infra-red code has now been accessed.

NOTE:

1. It may take several attempts before the correct code is found.
2. The VOL LEFT button can be used to return to a code that was accidentally passed by.
3. Some Remote Controls may have unique operating functions for some buttons. For Example: The POWER button may only turn the VCR OFF as opposed to both ON and OFF. It will then be necessary to modify the procedure. Turn the VCR ON and repeatedly press the VOL RIGHT button until the VCR turns OFF.

NOTE: When operating equipment (VCR or Cable Converter box) with the Universal Remote Control, the TV/CABLE Switch should be set to the same position where the Access Code was first programmed for the equipment. Otherwise, leave the switch in the TV position.

Cable Converter Box

Preferred Procedure – Code Known Programming Universal Remote Using Infrared Access Codes for Cable Television Converter Boxes

- Determine brand of Cable Television Converter box.
- Identify code(s) associated with the brand in the infra-red code index for Cable Television Converter boxes (located in this manual).

Procedure

1. Place the Remote TV/CABLE switch into the CABLE position (Right).



2. Press and hold the CABLE POWER button down on Universal Remote.



3. Enter two digit code using keyboard "0 through 9" buttons. Release CABLE Power button. The Universal Remote is now programmed. **Use the Remote CHANNEL UP/DOWN buttons for selecting Cable Converter Box channels.**

NOTE: Some brands have multiple codes. Repeat procedure using each code listed until Cable Television Converter box responds correctly.

Alternate Procedure – Code Unknown Programming Universal Remote Using the "Sequence Method" for Cable Television Converter Boxes

- Confirm Cable Television Converter box is plugged in and operating properly, then turn OFF.

Procedure

1. Place the Remote TV/CABLE switch into the CABLE position (Right).



2. Press and hold the CABLE POWER button down on Universal Remote.



3. Press VOL RIGHT button repeatedly. Check for the Cable Television Converter box to turn ON after each press. When the Cable Television Converter box turns ON, release Cable Power button. The proper infrared code has now been accessed.

NOTE:

- It may take several attempts before the correct code is found.
- The VOL LEFT button can be used to return to a code that was accidentally passed by.
- Some Remote Controls may have unique operating functions for some buttons. For Example: The POWER button may only turn the Cable Television Converter box OFF as opposed to both ON and OFF. It will then be necessary to modify the procedure. Turn the Cable Television Converter box ON and repeatedly press the VOL RIGHT button until the Cable Television Converter box turns OFF.

VCR and Cable Converter Box Infrared Codes Index

The Universal infrared Remote Control is capable of operating many brands of VCRs and Cable Television Converter Boxes after entering the proper infrared code

NOTE: The Universal Remote Control memory is limited. Some models of VCRs or Cable Television Converter Boxes may not operate. The Universal Remote Control is not designed to control all features that are available in all models.

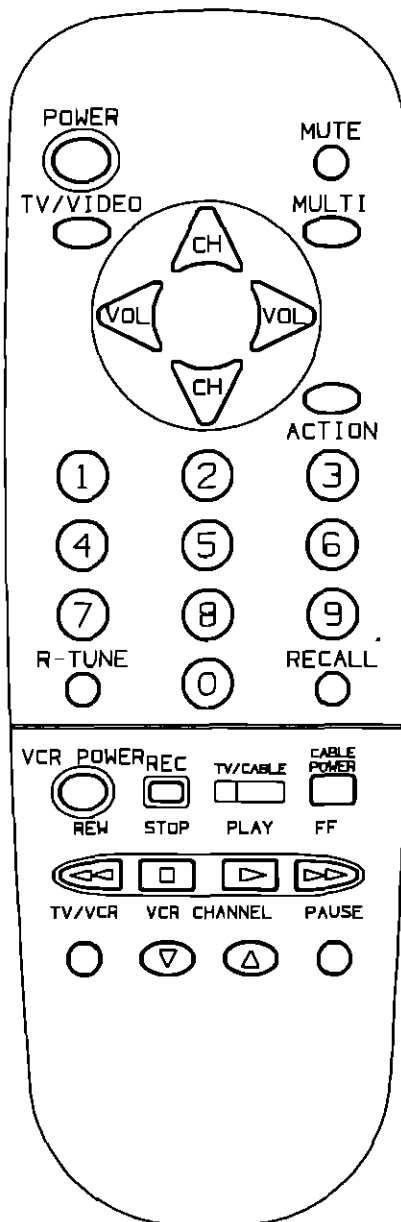

Infrared Code Index For VCRs















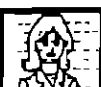



VCR Brand	Code(s)	VCR Brand	Code(s)
Audio Dynamics	14, 16	NEC	02, 14, 16, 30
Broksonic	10	Panasonic	00, 01
Canon	00, 01	Pentax	05
Capehart	01	Philco	00, 29
Cibzen	09	Philips	00, 29
Craig	12	Pioneer	05
Curtis Mathes	00, 08, 15	Quasar	00, 01
DBX	14, 16	RCA	05, 07, 08, 28, 35
Emerson	10, 20, 34, 35, 36, 37	Realistic	00, 02, 06, 12, 15
Fisher	12, 18, 19	Samsung	07, 32
Funai	15	Sanyo	02, 12
GE	00, 07, 08, 32	Scott	04, 13, 33, 36
Goldstar	09	Sears	02, 05, 18, 19
Hitachi	05, 35, 36	Sharp	06, 24
Instant Replay	00	Sony	17, 26, 33, 34
JC Penney	00, 02, 05, 14, 16, 30	Sylvania	00, 29
JVC	02, 14, 16, 30	Symphonic	15
Kenwood	02, 14, 16, 30	Tashiko	09
Magnavox	00, 29	Talung	30
Marantz	02, 14, 16, 29, 30	Teac	15, 30
Marta	09	Teknika	21
Memorex	00, 12	Toshiba	05, 13
MGA	04, 27	Vector Research	14, 16
Minolta	05	Video Concepts	14, 16
Mitsubishi	04, 27	Wards	06
Montgomery Ward	06	Yamaha	02, 14, 16, 30
Multitech	07, 15, 32	Zenith	11, 17

Infrared Code Index For Cable Television Converter Box

Brand of Cable-TV Box	Code(s)	Brand of Cable-TV Box	Code(s)
GI	04, 05, 15, 23, 24, 25, 30, 36	Pioneer	18, 20
Hamlin	12, 13, 34	RCA	27
Jerrold	04, 05, 15, 23, 24, 25, 30, 36	Regency	02
Macom	27	Scientific Atlantic	03, 22
Magnavox	19, 26, 28, 29, 32, 33, 40, 41	Sylvania	11
Oak	14, 16, 18	Texscan	10, 11
Oak Sigma	16	Tocom	17, 21
Panasonic	27, 39	Unika	31
Philips	19, 26, 28, 29, 32, 33, 40, 41	Viewstar	19, 26, 28, 29, 32, 33, 40, 41
		Zenith	01, 42

Troubleshooting Chart

Before you call for service, determine the symptoms and make a few simple checks shown below

Symptoms		Check
Picture	Sound	
 SNOWY PICTURE	 NOISY SOUND	- ANTENNA LOCATION AND/OR CONNECTION
 MULTIPLE IMAGE	 NORMAL SOUND	- ANTENNA DIRECTION AND/OR LOCATION - ANTENNA LEAD-IN WIRE
 INTERFERENCE	 NOISY SOUND	- ELECTRICAL APPLIANCES, LIGHTS, CARS AND TRUCKS - DIATHERMY AND OTHER MEDICAL EQUIPMENT
 NORMAL PICTURE	 NO SOUND	- VOLUME CONTROL SETTING - MUTE CONTROL (IF APPLICABLE) - TRY ANOTHER CHANNEL - TV SPEAKERS SWITCH (IF APPLICABLE) IN THE OFF POSITION
 NO VIDEO	 NOISY SOUND	- TV OR CABLE TUNING MODE SET TO PROPER SETTING - ANTENNA INPUT CORRECT (IF APPLICABLE)
 NO PICTURE	 NO SOUND	- CHECK THAT AC POWER LINE IS PLUGGED INTO AC OUTLET - BRIGHTNESS & AUDIO CONTROLS SET PROPERLY - TRY ANOTHER CHANNEL
 NO COLOR	 NORMAL SOUND	- COLOR CONTROL SETTINGS - TRY ANOTHER CHANNEL
 BLUE PICTURE	 NO SOUND	- RECEIVER IN VIDEO MODE WITH NO SIGNAL
 BLACK BOX IN PICTURE	 SOUND	- CC (CLOSED CAPTION) IN TEXT MODE - SELECT CAPTION OFF MODE TO ELIMINATE BLACK BOX

Should this unit turn ON momentarily and then turn OFF, or fail to operate, unplug the AC cord and contact your Authorized Servicer for repairs

Panasonic Sales Company,
Division of Matsushita Electric
of Puerto Rico Inc ("PSC")
Ave 65 de Infanteria, Km 9 5
San Gabriel Industrial Park
Carolina, Puerto Rico 00985
Tel (809) 750-4300
FAX (809) 768-2910

**Matsushita Consumer Electronics
Company, Division of Matsushita
Electric Corporation of America**
One Panasonic Way
Secaucus, New Jersey 07094

Matsushita Electric of Canada Limited
5770 Ambler Drive
Mississauga, Ontario L4W 2T3
Canada

Free Manuals Download Website

<http://myh66.com>

<http://usermanuals.us>

<http://www.somanuals.com>

<http://www.4manuals.cc>

<http://www.manual-lib.com>

<http://www.404manual.com>

<http://www.luxmanual.com>

<http://aubethermostatmanual.com>

Golf course search by state

<http://golfingnear.com>

Email search by domain

<http://emailbydomain.com>

Auto manuals search

<http://auto.somanuals.com>

TV manuals search

<http://tv.somanuals.com>