

Panasonic®

Color Video Monitor/Receiver

Operating Instructions



CT-2786YD
CT-2786VYD

Read these instructions completely before operating.
Contents subject to change without notice or obligation.

Copyright 1997 by Matsushita Electric Corporation
of America. All rights reserved. Unauthorized
copying and distribution is a violation of law.

Printed in Mexico
TQB2AA0157

IMPORTANT INFORMATION

Notice from the FCC:

This equipment was tested and found to comply within the limits for a Class B digital device, pursuant to Part 15 of the FCC rules. These limits are designed to provide reasonable protection against harmful interference in a residential installation.

This equipment generates, uses and can radiate radio frequency energy and, if not installed and used in accordance with the instructions, may cause harmful interference with radio communications. However, there is no guarantee that interference will not occur in particular installation. If this equipment does cause harmful interference to radio or television reception, which can be determined by tuning the equipment on and off, the user is encouraged to try to correct the interference by one or more of the following measures:

- Reposition or relocate the receiving antenna.
- Increase the separation between the equipment and receiver.
- Connect the equipment into an outlet on a circuit different from that to which the receiver is connected.

- Consult the dealer or an experienced radio/TV technician for assistance.

Important:

Changes or modifications not expressly approved by the party responsible for compliance could void the user's authority to operate the equipment.

Use only the shielded cable when connecting this TV to a computer device.

DOC Class B Compliance:

This digital apparatus does not exceed the Class B limits for radio noise emissions from digital apparatus as set out in the radio interference regulations of the Canadian Department of Communications.

FCC Caution:

To assure continued compliance, the user must use the provided shielded video cable with bonded ferrite cores. Also, any changes or modifications to this monitor would void the user's authority to operate this device.

Safety Instructions

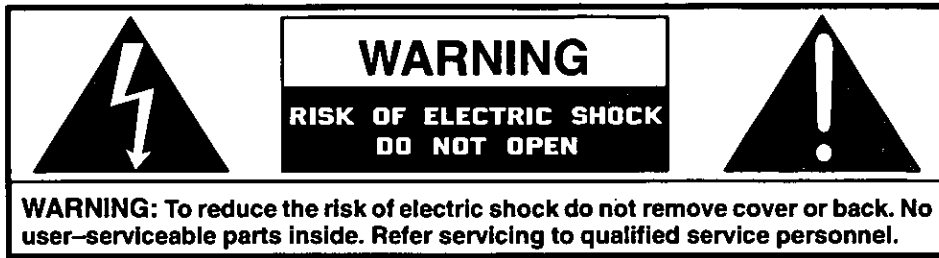

The lightning flash with arrow-head within a triangle is intended to tell the user that parts inside the product are a risk of electric shock to persons.



The exclamation point within a triangle is intended to tell the user that important operating and servicing instructions are in the papers with the appliance.

Note To CATV System Installer: This reminder is provided to call the CATV system installer's attention to Article 820-40 of the NEC that provides guidelines for proper grounding and, in particular, specifies that the cable ground shall be connected to the grounding system of the building, as close to the point of cable entry as practical.

Safety Instructions For Television Receivers

1. Read and apply the operating instructions provided with your television receiver.
2. Read all of the instructions given here and retain them for later use.
3. Unplug this television receiver from the wall outlet before cleaning. Do not use liquid or aerosol cleaners. Use a damp cloth for cleaning.
4. Do not use attachments not recommended by the television receiver manufacturer as they may cause hazards.
5. Do not use this television receiver near water. For example: Avoid placing it near a bathtub, washbowl, kitchen sink, or laundry tub, in a wet basement, or near a swimming pool, etc.
6. Do not place this television receiver on an unstable cart, stand, or table. The television receiver may fall, causing serious injury to a child or adult, and serious damage to the appliance. Use only with a cart or stand recommended by the manufacturer, or sold with the television receiver. Wall or shelf mounting should follow the manufacturer's instructions, and should use a mounting kit approved by the manufacturer.
- 6A. An appliance and cart combination should be moved with care. Quick stops, excessive force, and uneven surfaces may cause the appliance and cart combination to overturn.
7. Slots and openings in the cabinet and the back or bottom are provided for ventilation, and to insure reliable operation of the television receiver and to protect it from overheating. These openings must not be blocked or covered. The openings should never be blocked by placing the television receiver on a bed, sofa, rug or other similar surface. This television receiver should never be placed near or over a radiator or heat register. This television receiver should not be placed in a built-in installation such as a bookcase unless proper ventilation is provided.
8. Operate only from the type of power source indicated on the marking label. If you are not sure of the type of power supplied to your home consult your television dealer or local power company. For television receivers designed to operate from battery power, refer to the operating instructions.
9. This television receiver is equipped with a polarized alternating-current line plug (a plug having one blade wider than the other). This plug will fit into the power outlet only one way. This is a safety feature. If you are unable to insert the plug fully into the outlet, try reversing the plug. If the plug should still fail to fit, contact your electrician to replace your obsolete outlet. Do not defeat the safety purpose of the polarized plug.
10. Do not allow anything to rest on the power cord. Do not locate this television receiver where the cord will be abused by persons walking on it.
11. Follow all warnings and instructions marked on the television receiver.
12. Do not overload wall outlets and extension cords as this can result in fire or electric shock.
13. Never push objects of any kind into this television receiver through cabinet slots as they may touch dangerous voltage points or short out parts that could result in a fire or electric shock. Never spill liquid of any kind on the television receiver.

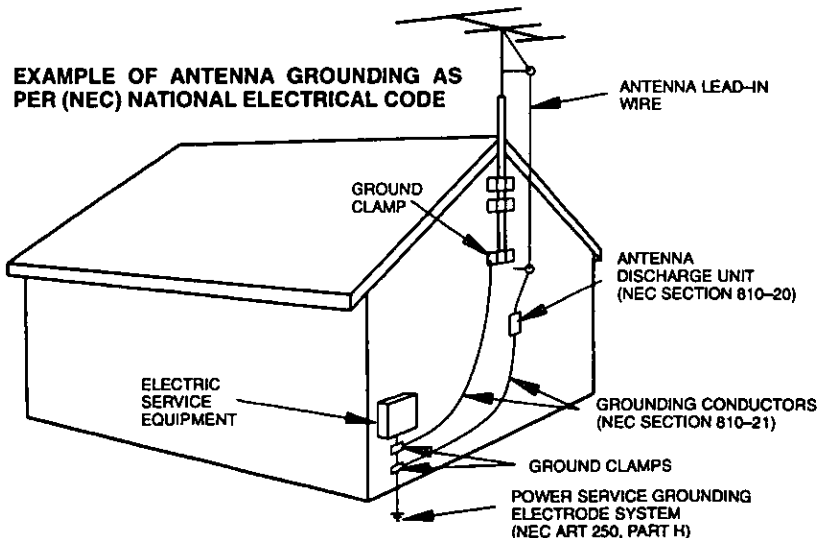

14. If an outside antenna is connected to the television equipment, be sure the antenna system is grounded so as to provide some protection against voltage surges and built up static charges. In the U.S. Section 810 of the National Electrical Code and in Canada Part 1 of the Canadian Electrical Code provides information with respect to proper grounding of the mast and supporting structure, grounding of the lead-in wire to an antenna discharge unit, size of grounding conductors, location of antenna-discharge unit, connection to grounding electrodes, and requirements for the grounding electrode. See Figure.
15. For added protection for this television receiver during a lightning storm, or when it is left unattended and unused for long periods of time, unplug it from the wall outlet and disconnect the antenna. This will prevent damage to the receiver due to lightning and power-line surges.
16. An outside antenna system should not be located in the vicinity of overhead power lines or other electric light or power circuits, or where it can fall into such power lines or circuits. When installing an outside antenna system extreme care should be taken to keep from touching such power lines or circuits as contact with them might be fatal.
17. Unplug this television receiver from the wall outlet, and refer servicing to qualified service personnel under the following conditions:
 - a. When the power cord or plug is damaged or frayed.
 - b. If liquid has been spilled into the television receiver.
 - c. If the television receiver has been exposed to rain or water.
 - d. If the television receiver does not operate normally by following the operating instructions. Adjust only those controls that are covered by the operating instructions as improper adjustment of other controls may result in damage and will often require extensive work by a qualified technician to restore the television receiver to normal operation.
 - e. If the television receiver has been dropped or the cabinet has been damaged.
 - f. When the television receiver exhibits a distinct change in performance – this indicates a need for service.
18. Do not attempt to service this television receiver yourself as opening or removing covers may expose you to dangerous voltage or other hazards. Refer all servicing to qualified service personnel.
19. When replacement parts are required, be sure the service technician has used replacement parts specified by the manufacturer that have the same characteristics as the original part. Unauthorized substitutions may result in fire, electric shock, or other hazards.
20. Upon completion of any service or repairs to this television receiver, ask the service technician to perform routine safety checks to determine that the television is in safe operating condition.
21. **WARNING: To prevent fire or shock hazard, do not expose this appliance to rain or moisture.**
22. **CAUTION: TO PREVENT ELECTRIC SHOCK DO NOT USE THIS (POLARIZED) PLUG WITH A RECEPTACLE OR OTHER OUTLET UNLESS THE BLADES CAN BE FULLY INSERTED TO PREVENT BLADE EXPOSURE.**

NOTE: This equipment is designed to operate in the U.S.A., Canada and other countries where the broadcasting system and AC house current is exactly the same as in the U.S.A. and Canada.

Important Information Regarding Use of Video Games, Computers, DSS or Other Fixed Image Displays.

The extended use of fixed image program material can cause a permanent “shadow image” on the picture tube. This background image is viewable on normal programs in the form of a stationary fixed image. This type of irreversible picture tube deterioration can be limited by observing the following steps:

- A. Reduce the brightness/contrast setting to a minimum viewing level.
- B. Do not display the fixed image for extended periods of time.
- C. Turn the power off when not in actual use.

NOTE: The marking or retained image on the picture tube resulting from fixed image use is not an operating defect and as such is not covered by Warranty. This product is not designed to display fixed image patterns for extended periods of time.

Specifications

- Power Source:** 120V, 60Hz, AC
- Video Input Jack:** 1V p-p 75 ohm, BNC connectors
- Audio Input Jacks:** 500mV rms, RCA connectors
- S-Video Input Jack:** S-Video (Y-C) connector
- Video Monitor Output Jack:** BNC connector (CT-2786VYD only)
- Audio Monitor Output Jacks:** RCA connector (CT-2786VYD only)
- Video Throughout Jack:** BNC connector
- Audio Throughout Jack:** RCA connector
- S-Video Throughout Jacks:** S-Video (Y-C) connectors
- Closed Caption Display**

**Channel Capability Chart
for CT-2786VY**

BAND	CHANNELS
VHF	12
UHF	56
CABLE (Mid-Band)	15
CABLE (Super Band)	14
CABLE (Hyper Band)	28
CABLE (Ultra Band)	56
TOTAL CHANNELS	181

Specifications are subject to change without notice or obligation.

Introduction

Congratulations on Your New Purchase

Your new video component features an all–solid–state chassis which is designed to give you many years of enjoyment. It was thoroughly tested and adjusted at the factory for best performance.

In order for you to take full advantage of your new video component, please read and follow the installation and operating instructions supplied with this product.

Customer's Record

The model and serial number of this product may be found on its back cover. You should note the model and serial number in the space provided and retain this book as a permanent record of your purchase to aid in identification in the event of theft or loss.

Model Number: _____ Serial Number: _____

Table of Contents

Important FCC Information	2	Picture Adjustments	14
Safety Instructions	3	Picture Norm	14
Specifications	4	Color, Tint, Brightness, Picture and Sharpness ..	14
Introduction	5	Audio Adjustments	15
Care and Cleaning	5	Audio Norm	15
Installation	6	Bass, Treble, and Balance	15
Monitor Location	6	Mode (Stereo/SAP/Mono)	15
Optional External Equipment Connections	6	Ai Sound	16
Power Supply Cord	6	Surround	16
Remote Control Battery Installation (CT–2786VY) ..	6	TV Speakers (CT–2786VY)	16
Antenna/Cable Connections	7	Channel Caption (CT–2786VY)	17
Other Video Equipment	7	Timer Features	17
Optional Equipment Connection and Operation ..	8	Sleep Timer	17
Video/Audio In & Out Connections	8	Program Timer	18
S–Video Connection	9	Set–Up Features	19
Monitor Out Connection	10	Set Time	19
To Audio AMP Connection	10	Antenna (Ant)	19
Location of Controls – Remote (CT–2786VYD) ...	11	Auto Prog	19
Location of Controls – Monitor	12	Manual Prog	20
Special Functions (CT–2786VYD only)	13	Auto Power On	20
R–Tune (Rapid Tune) Button	13	CC (Closed Caption) Mode	20
Recall Button	13	Instant On Feature	21
Mute Button	13	Control Panel Lock Feature	21
Main Menu Icons	13	Troubleshooting Chart	24
Menu Language Selection	14		

Care and Cleaning

Picture Tube (Turn set off)

Use a mild soap solution or window cleaner and a clean cloth. DO NOT USE ABRASIVE CLEANERS. Avoid excessive moisture and wipe dry.

Plastic Cabinets

Wipe the cabinet with a soft cloth dampened with water or a mild detergent solution and wipe dry with a soft clean cloth. Avoid excessive moisture. Do not use benzene, thinners or other petroleum–based cleaners.

Wood Cabinets

When dusting or polishing the cabinet, use a clean soft cloth and stroke straight with the grain. An occasional coat of furniture polish will help preserve the finish. Do not use benzene, thinners or other petroleum–based cleaners. Do not place objects made of plastic or rubber directly on top of the cabinet. A chemical reaction could result causing permanent marring of the finish.

Remote Control Transmitter

Do not use benzene, thinners or other petroleum–based cleaners to clean the Remote Control Transmitter. To clean, wipe with a soft cloth slightly moistened with a mild detergent and then wipe dry with a soft clean cloth.

Installation

Monitor Location

Locate for comfortable viewing. Avoid placing where sunlight or other bright light (including reflections) will fall on the screen.

Use of some types of fluorescent lighting may reduce remote control transmitter range.

Adequate ventilation is essential to prevent internal component failure. Keep away from areas of excessive heat or moisture.

To insure optimum color purity do not position magnetic equipment (motors, fans, other speakers, etc.) nearby.

Optional External Equipment Connections

The Video/Audio connections between components can be made with shielded video and audio cables. For best performance, video cables should utilize 75 ohm coaxial shielded wire. Cables are available from your dealer or electronic supply house.

Before you purchase any cables, be sure you know what type of output and input connectors your various components require. Also determine the length of cable you'll need.

Power Supply Cord

MAKE SURE PLUG IS INSERTED FULLY INTO RECEPTACLE.

This product is equipped with a three-wire grounding type plug – a plug with two blades and a third pin which is round. This plug will only fit into a grounding type outlet.

This is a safety feature. If you are unable to insert the plug into the outlet, contact your electrician to replace your obsolete outlet. **DO NOT DEFEAT THE SAFETY PURPOSE OF THE GROUNDING TYPE PLUG.**



3 Wire Ground Plug

Remote Control Battery Installation (CT-2786VYD only)

Batteries: Use two "AA" batteries.

1. Remove the battery compartment cover on back of the remote.
2. Install the batteries in the battery compartment. (Polarity (+) or (-) must be correct.)
3. Reattach the battery cover.

To Remove Cover Push In And Up On Catch With A Narrow Object

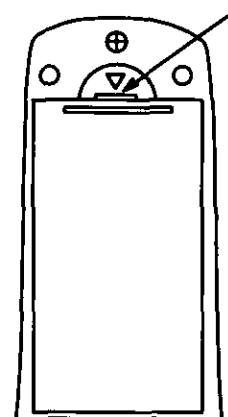

Helpful Hints:

For frequent Remote Control users, replace old batteries with Alkaline batteries for longer life.

Precaution on Battery Use

Incorrect installation can cause battery leakage and corrosion that will damage the Remote Control Transmitter.

Observe the Following Precautions:

1. Batteries must be replaced as a pair.
2. Do not combine a used battery with a new one.
3. Do not mix battery types (Example: "Zinc Carbon" with "Alkaline").
4. Do not attempt to charge, short-circuit, disassemble, heat or burn used batteries.
5. Battery replacement is necessary when Remote Control reacts sporadically or stops operating the TV.

Installation (cont.)

Antenna/Cable Connections (CT-2786VYD only)

Antenna Connection – For proper reception of VHF/UHF channels, an external antenna is required. For best reception an outdoor antenna is recommended. **Antenna Mode must be set to TV.** (Refer to Antenna Mode section.)

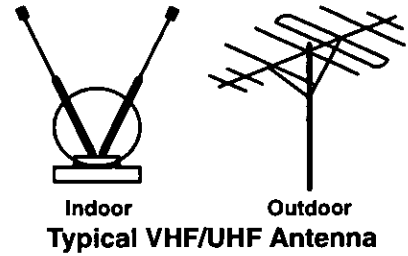

Incoming Cable from Home Antenna

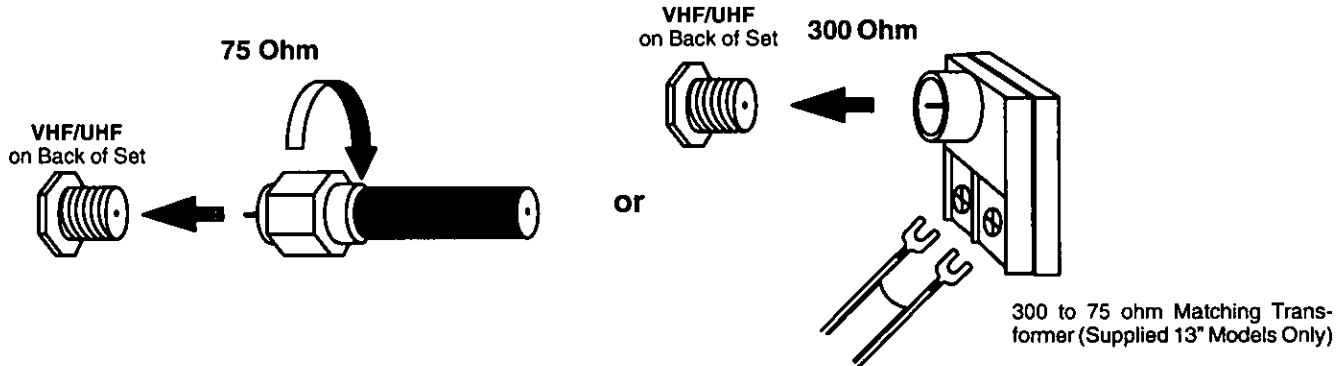

Cable Connection – For reception of cable channels, connect the cable supplied by your local cable company. **Antenna Mode must be set to CABLE.** (Refer to Antenna Mode section.)

Incoming Cable from Cable Company

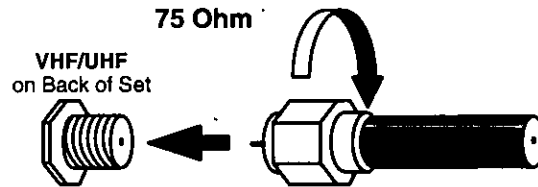

NOTE: Certain cable systems offset some channels to reduce interference or have Premium (scrambled) channels. A cable converter box is required for proper reception. Check with your local Cable company for compatibility requirements.

Other Video Equipment

VCRs, Video Disc Players, Computers, TV games, and DSS equipment can also be connected to the antenna input connection (some models).

Optional Equipment Connection & Operation

Video/Audio In & Out Connections

The IN and OUT terminals located on the back of the Monitor directly pass the input signals through the out terminals, so you may monitor or record the external Video/Audio information.

Operation

1. Connect an external Video/Audio source to the Monitor VIDEO IN terminals as shown.
2. Select video mode by pressing the TV/Video button (some models).
3. Connect the same Video/Audio THROUGH OUT jacks to a Monitor or VCR as shown. Monitor will be operating with the external Video/Audio signals. The THROUGH OUT jacks will provide the same signals for monitoring or recording.

NOTE: Video/Audio IN and OUT terminals will operate whether the Monitor is ON or OFF.

Use BNC or S-Video Connection for Video Out (The Out Terminal will be the same as the Video Input Source).

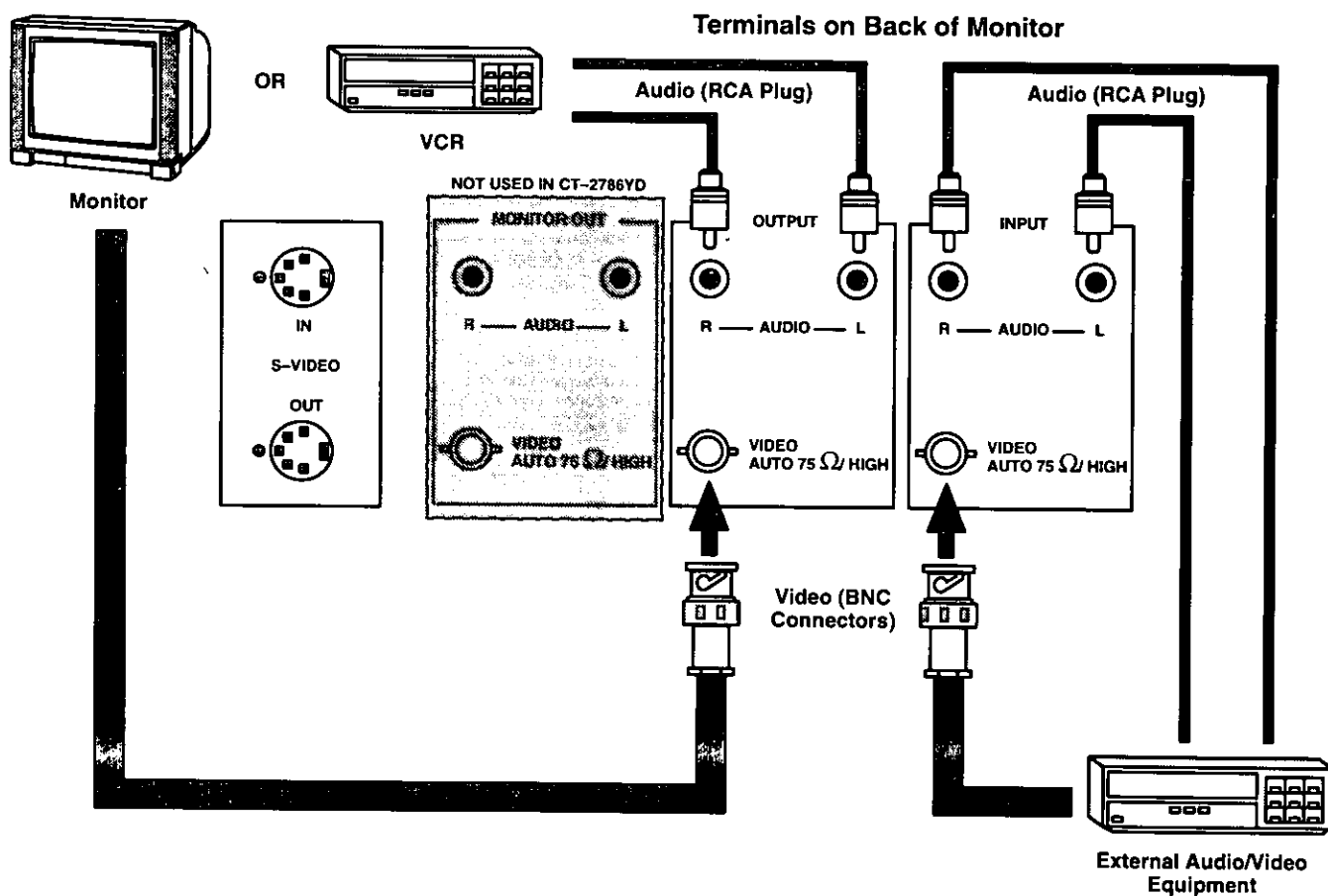

Optional Equipment Connection & Operation (cont.)

S-Video Connection

Operation for S-Video Input

1. Make connection to the S-VIDEO INPUT jack, also the L & R AUDIO INPUT terminals as shown.
2. Connect S-VIDEO INPUT to a video source as shown.
3. Press the TV/VIDEO button to select Video Mode (some models).
4. Operate optional equipment (VCR-VDP) as instructed in Optional Equipment Manual.

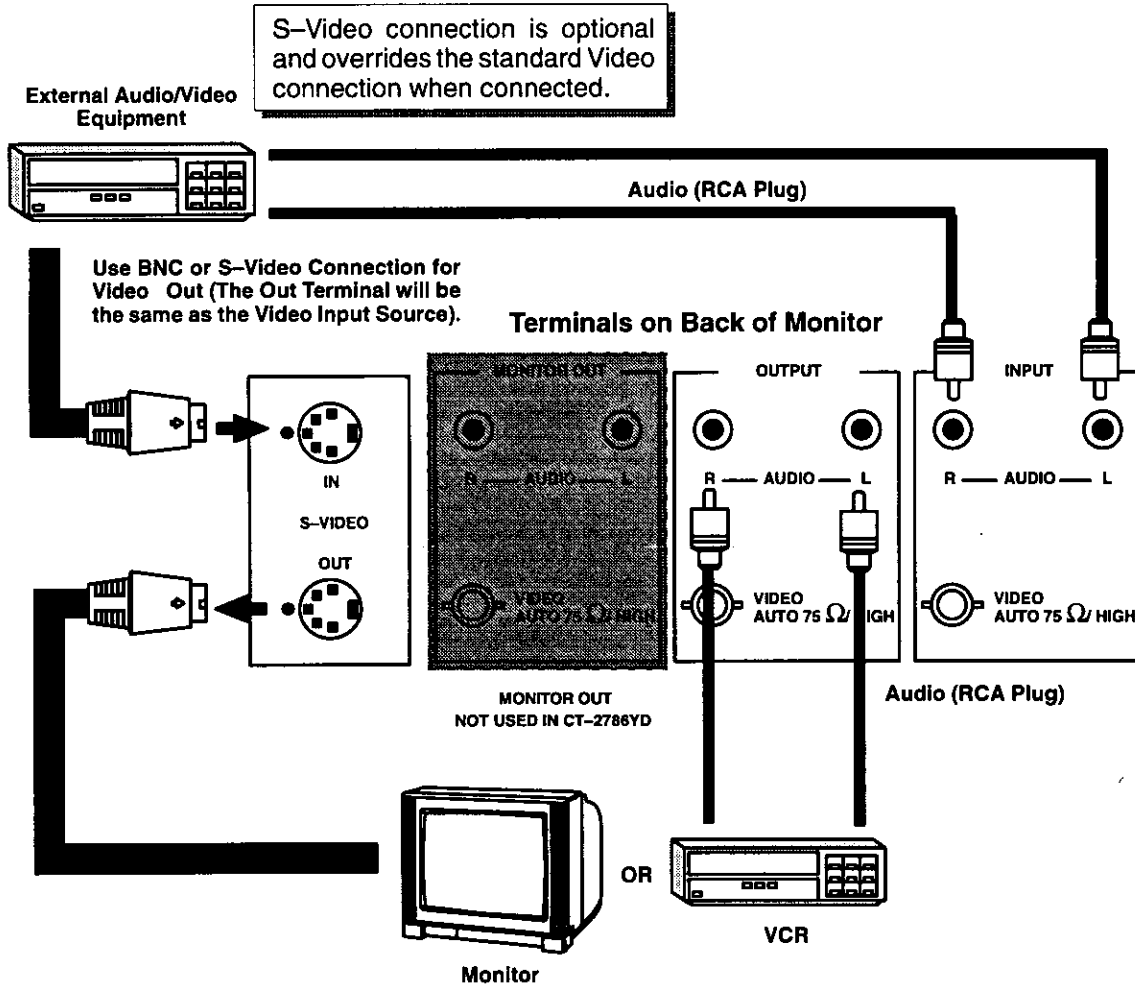

Operation for S-Video Output

1. Make connection to the S-VIDEO OUTPUT jack, also the L & R AUDIO OUTPUT terminals as shown above. (The S-Video Out terminal will be the same as the S-Video Input Source.)
2. Connect S-VIDEO OUTPUT to a Monitor or VCR as shown above.
3. Press the TV/VIDEO button to select Video Mode (some models).
4. Operate the optional equipment (VCR-VDP) as instructed in Optional Equipment Manual.

NOTE: S-Video IN and OUT terminals will operate whether the Monitor is ON or OFF.

Optional Equipment Connection & Operation (cont.)

Monitor Out Connection (CT-2786VYD only)

The Monitor Out terminals will output Audio and Video signals being displayed.

Operation

1. Make connections to the MONITOR OUT video BNC connector, also the MONITOR OUT L and R audio terminals as shown.

NOTE: The MONITOR OUT jacks will provide the same signals for monitoring or recording. The Monitor Out terminals only operate when the Monitor is ON.

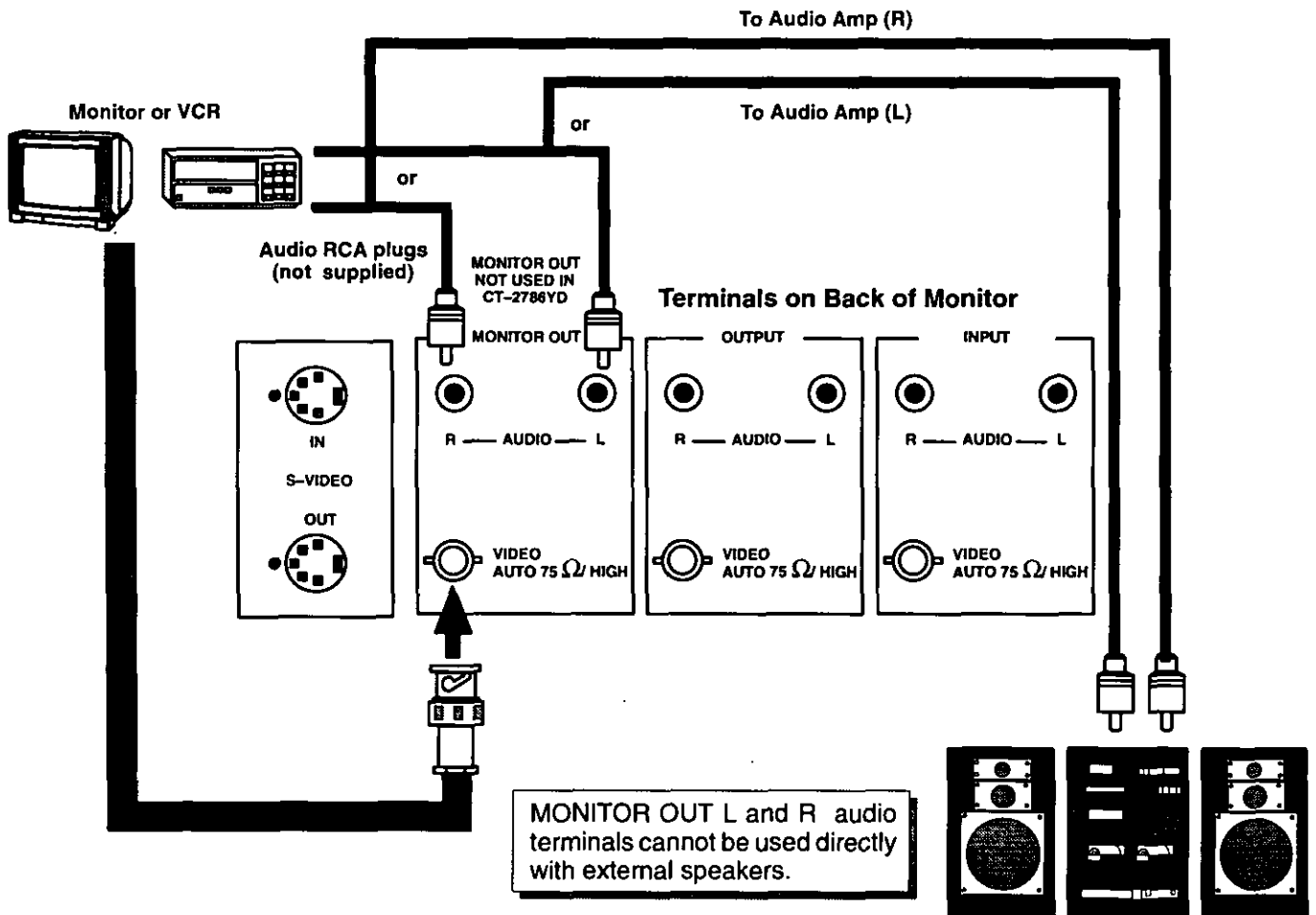

To Audio AMP Connection (CT-2786VYD only)

Connect to an external audio amp auxiliary input for monitoring sound through a stereo system.

Adjustment – When an audio amp is connected to MONITOR OUT L and R AUDIO terminals as shown above:

1. Select TV SPEAKERS "ON" Mode. (Refer to the Audio Menu TV Speakers section.)
2. Set volume of audio amp to near minimum.
3. Adjust volume of TV to desired listening level.
4. Adjust volume of audio amp to match the level of TV.
5. Select TV SPEAKERS "OFF&VAO" Mode. (Refer to the Audio Menu TV Speakers section.)
6. Bass, Treble, Balance, Volume and Mute can now be controlled by the TV Remote Control.

NOTE: When Selecting TV SPEAKERS "OFF&FAO" Mode, the TV sound output is always at a constant level and cannot be changed (Refer to the Audio Menu TV Speakers section).

Location of Control – Remote

(CT-2786VYD only)

Power Button

Press to turn ON or OFF.

Mute Button

Press to mute sound. A second press resumes sound. Press also to access and delete Closed Caption display.

Volume Buttons

Press to adjust TV sound level. Use with Channel buttons to navigate in menus.

Keypad Buttons

Press desired channel number to randomly access any channel.

R-Tune (Rapid Tune) Button

Press to switch to the previous channel.

POWER MUTE TV/VIDEO

TV/Video Button

Press to select TV or Video Input.

CH

VOL VOL

CH

Channel Buttons

Press to select channels. Use with Volume buttons to navigate in menus.

ACTION

Action Button

Press to display Main Menu and access or exit On Screen feature and Adjustment Menus.

1 2 3

4 5 6

7 8 9

R-TUNE 0 RECALL

Recall Button

Press to display Time, status of Sleep Timer, Channel, Video Mode and Channel Caption (Station Identifier).

Panasonic

EUR501371

Location of Controls – Monitor

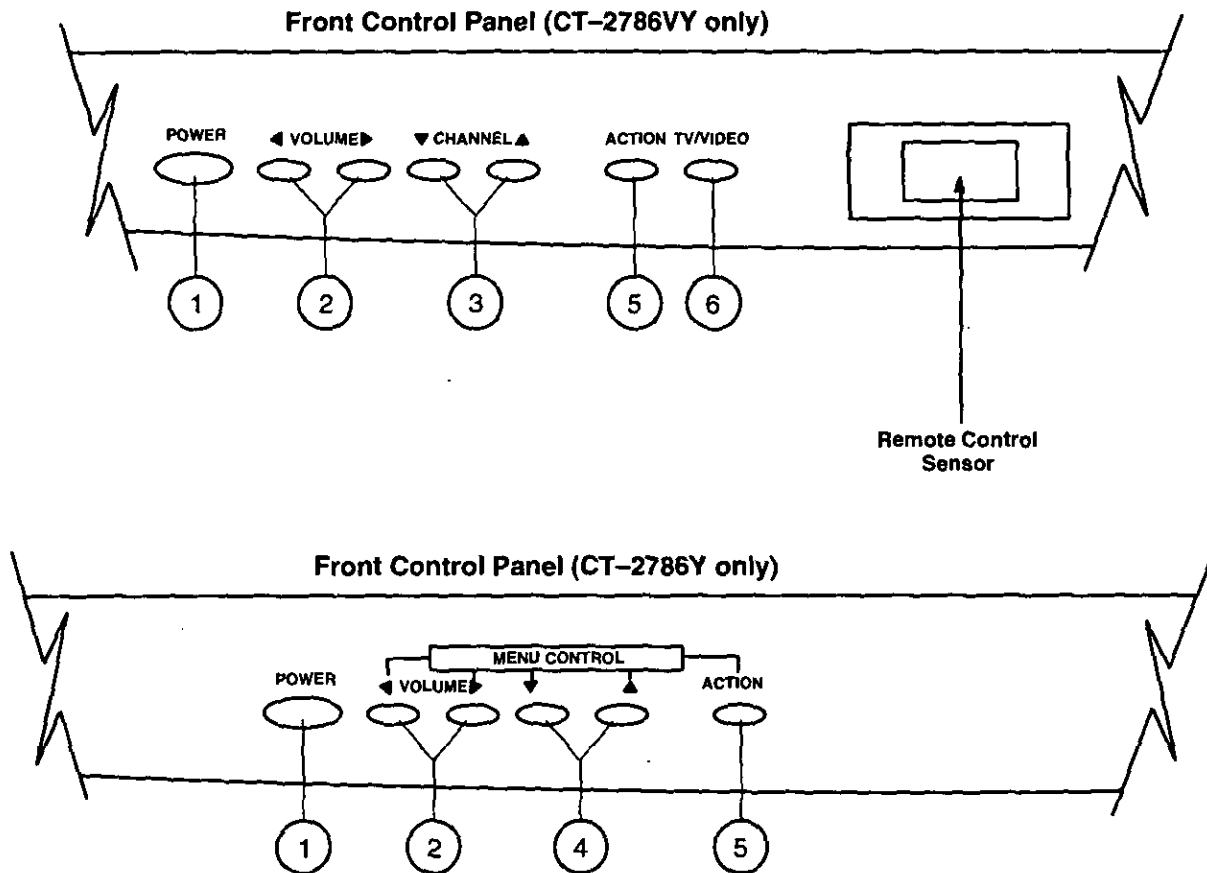

- ① **Power Button** – Press to turn ON or OFF.
- ② **Volume Buttons** – Press to adjust Sound Level. Press to adjust Video Menus and select operating features when menus are displayed.
- ③ **Channel Buttons** – Press to select programmed channels. Press to highlight desired features when menus are displayed.
- ④ **Menu Control Up/Down Buttons** – Press to highlight desired features when menus are displayed.
- ⑤ **Action Button** – Press to display Main Menu and access On Screen feature and Adjustment Menus.
- ⑥ **TV/Video Button** – Press to select TV or Video Inputs (some models).

Special Functions

R-TUNE

R-Tune (CT-2786VY only) – Pressing  will switch between the last two channels selected on the numeric keypad.

NOTE: When rapidly scanning channels with the CHANNEL UP/DOWN button, pressing the R-TUNE button will switch between the last channel scanned, and initial channel at the start of scanning.

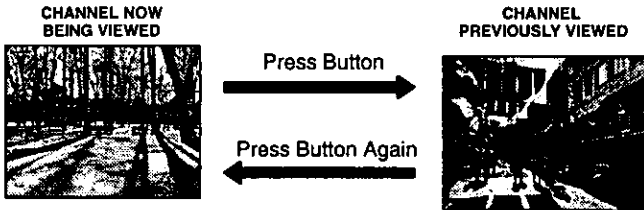

RECALL

Recall (CT-2786VY only) – Press  to review:

- ① Audio Mode status
- ② CH number or Video Input selected
- ③ Channel Caption (Station Identifier)
- ④ Clock time
- ⑤ Sleep Timer status

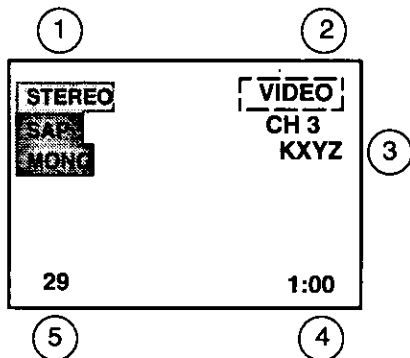

MUTE

Mute (CT-2786VY only) – Press  to quickly reduce sound level (Mute will appear on screen). Press again to restore sound. Also used to display Closed Caption (refer to CC Mode section for more information, located in the Set-Up Menu).

Main Menu Icons

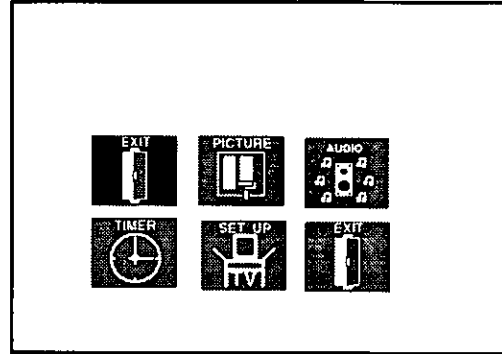



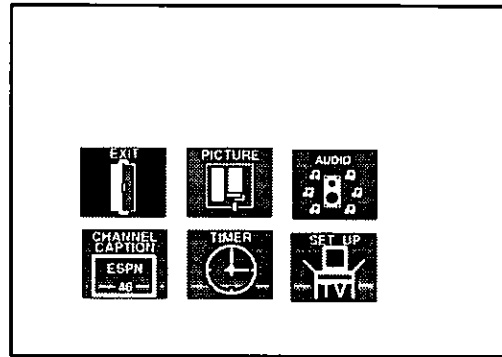

CT-2786Y only



CT-2786VY only

NOTE: When Auto Power On feature is activated, Timer Icon will change to Exit Icon.

1. Press ACTION button on the TV or Remote (some models).
2. Press  /  and  /  buttons to select the desired Icon.
3. Press ACTION button after selecting the desired Icon to access sub menus.
4. Press ACTION button twice to exit sub menus or press ACTION button once while the EXIT Icon is highlighted to exit Main Menu.

Menu Language Selection

The MENU LANGUAGE is factory set to ENGLISH. Follow the instructions to change the Language Menu to SPANISH, FRENCH, and back to ENGLISH.

1. Press ACTION button on the TV or Remote (some models).
2. Press ▲ / ▼ and ◀ / ▶ buttons to highlight the Set-Up Icon.
3. Press ACTION button to display the Set-Up Menu.

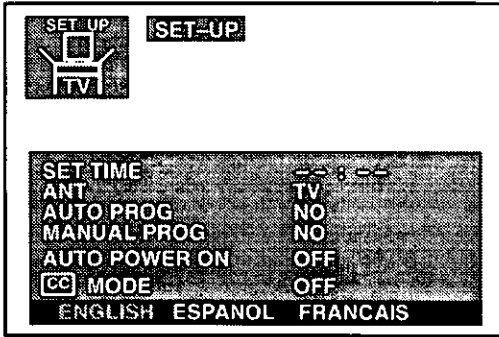

4. Press ▲ / ▼ button to highlight ENGLISH, ESPAÑOL, FRANÇAIS.
5. Press ◀ / ▶ button to select ENGLISH, ESPAÑOL, or FRANÇAIS.
6. Press ACTION button twice to exit menus.

Picture Adjustments

Picture Norm

Use to reset picture adjustments back to a factory preset level.

1. Press ACTION button on the TV or Remote (some models).
2. Press ▲ / ▼ and ◀ / ▶ buttons to highlight the Picture Icon.
3. Press ACTION button to display the Picture Adjustment Menu.

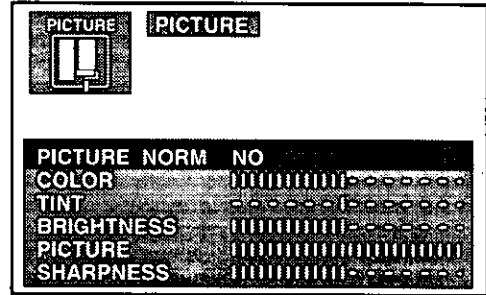

4. Press ▲ / ▼ button to highlight PICTURE NORM.
5. Press ◀ / ▶ button to select "SET" to normalize Color, Tint, Brightness, Picture, and Sharpness.
6. Press ACTION button twice to exit menus.

Color, Tint, Brightness, Picture, and Sharpness Adjustments

1. Press ACTION button on the TV or Remote (some models).
2. Press ▲ / ▼ and ◀ / ▶ buttons to highlight the Picture Icon.
3. Press ACTION button to display the Picture Adjustment Menu.

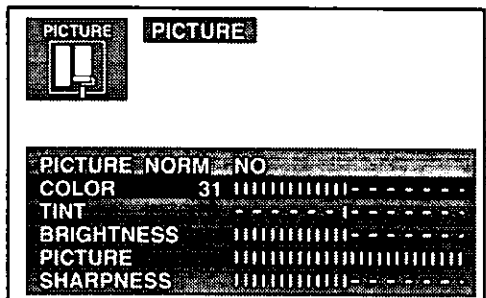

4. Press ▲ / ▼ button to select the desired Picture Adjustment (Color, Tint, Brightness, Picture, or Sharpness).
5. Press ◀ / ▶ button to adjust your selection.
6. Repeat steps 4 and 5 for the remaining Picture Adjustments.
7. Press ACTION button twice to exit menus.

Audio Adjustments

Audio Norm

This feature is used to reset BASS, TREBLE, and BALANCE back to a factory preset level. **NOTE:** Bass and Treble is automatically set when AI Sound is ON.

1. Press ACTION button on the TV or Remote (some models).
2. Press ▲ / ▼ and ◀ / ▶ buttons to highlight the Audio Icon.
3. Press ACTION button to display the Audio Adjustment Menu.

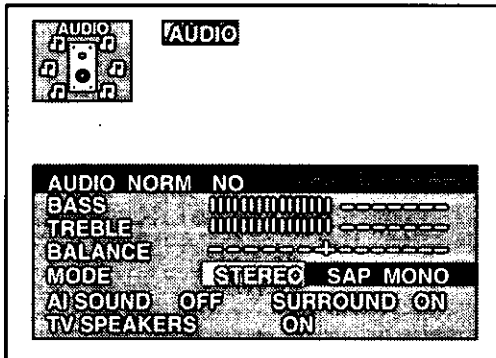

NOTE: For model CT-2786Y, the MODE selections will not be displayed in the Audio menus.

4. Press ▲ / ▼ button to highlight AUDIO NORM.
5. Press ◀ / ▶ button to select SET to normalize Bass, Treble, and Balance.
6. Press ACTION button twice to exit menus.

Bass, Treble, and Balance

1. Press ACTION button on the TV or Remote (some models).
2. Press ▲ / ▼ and ◀ / ▶ buttons to highlight the Audio Icon.
3. Press ACTION button to display the Audio Adjustment Menu.

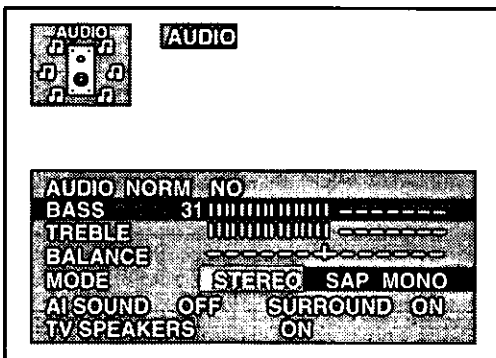

4. Press ▲ / ▼ button to highlight BASS, TREBLE, or BALANCE.
5. Press ◀ / ▶ button to adjust for desired audio response.
6. Press ACTION button twice to exit menus.

Helpful Hints:

BASS – To increase or decrease the Bass response.
TREBLE – To increase or decrease the Treble response.
BALANCE – To emphasize the LEFT/RIGHT speaker volume.

Mode (Stereo/SAP/Mono) (CT-2786VY only)

When Audio is broadcast in Stereo or SAP, an On-Screen display will appear on initial "Turn On" and "Channel Change". The available choices will be highlighted.

1. Press ACTION button on the TV or Remote (some models).
2. Press ▲ / ▼ and ◀ / ▶ buttons to highlight the Audio Icon.
3. Press ACTION button to display the Audio Adjustment Menu.

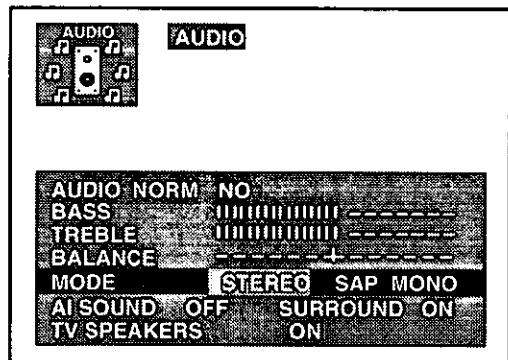

4. Press ▲ / ▼ button to highlight MODE.
5. Press ◀ / ▶ button to select STEREO, SAP (Second Audio Programming), or MONO. The selected mode will be highlighted.
6. Press ACTION button twice to exit menus.

Helpful Hints:

STEREO – Two channel Audio reception.
SAP – Second Audio Programming (typically used for bilingual audio).
MONO – Use when stereo signal is weak.

Audio Adjustments (cont.)

AI Sound

This feature regulates the volume between programs and commercial audio to maintain a constant sound output level.

1. Press ACTION button on the TV or Remote (some models).
2. Press ▲ / ▼ and ◀ / ▶ buttons to highlight the Audio Icon.
3. Press ACTION button to display the Audio Adjustment Menu.

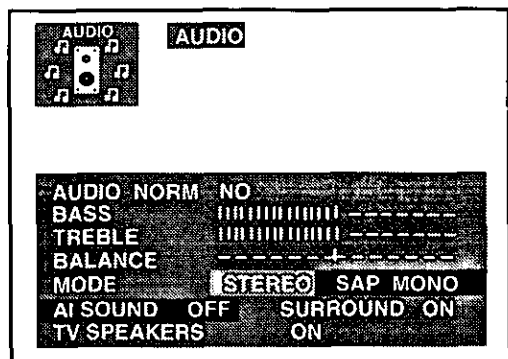

4. Press ▲ / ▼ button to highlight AI SOUND.
5. Press ◀ / ▶ button to select ON or OFF.
6. Press ACTION button twice to exit menus.

Surround

Use the Surround Feature to enhance audio response when listening to Stereo broadcasts.

1. Press ACTION button on the TV or Remote (some models).
2. Press ▲ / ▼ and ◀ / ▶ buttons to highlight the Audio Icon.
3. Press ACTION button to display the Audio Adjustment Menu.

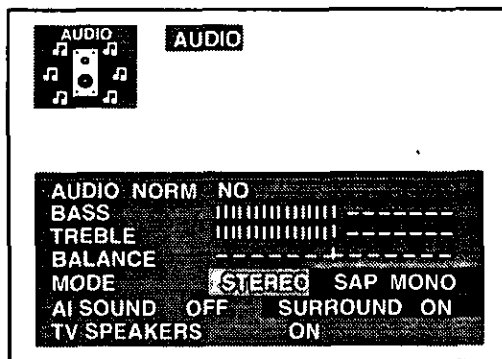

4. Press ▲ / ▼ button to highlight SURROUND.
5. Press ◀ / ▶ button to select ON or OFF.
6. Press ACTION button twice to exit menus.

TV Speakers (CT-2786VY only)

This feature is used to turn the internal speakers "ON" or "OFF". It is used when the TV is connected to an External Audio Amplifier. (Refer to "To Audio Amp Connection" section for further information.)

1. Press ACTION button on the TV or Remote (some models).
2. Press ▲ / ▼ and ◀ / ▶ buttons to highlight the Audio Icon.
3. Press ACTION button to display the Audio Adjustment Menu.

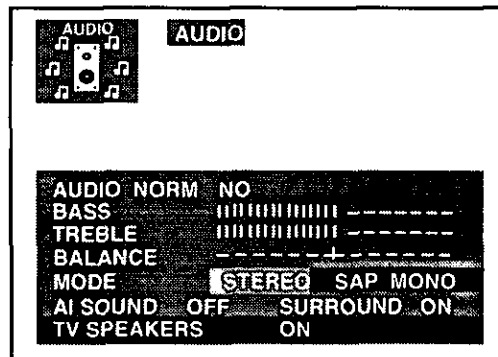

4. Press ▲ / ▼ button to highlight TV SPEAKERS.
5. Press ◀ / ▶ button to select ON, OFF&VAO or OFF&FAO.
 - ON – TV SPEAKERS operate normally.
 - OFF&VAO (Variable Audio Output) – TV SPEAKERS off, the sound output varies according to the TV volume. Use the TV remote to control the volume, muting, bass, treble, and balance of the External Amplifier System.
 - OFF&FAO (Fixed Audio Output) – TV SPEAKERS off, sound output is not adjustable. The audio is controlled by the External Amplifier System volume control.
6. Press ACTION button twice to exit menus.

Channel Caption (CT-2786VY only)

This feature allows you to enter the call names of up to 30 stations into memory (using up to 4 characters for each station). The Channel Caption will then display along with the channel number when changing channels or pressing RECALL..

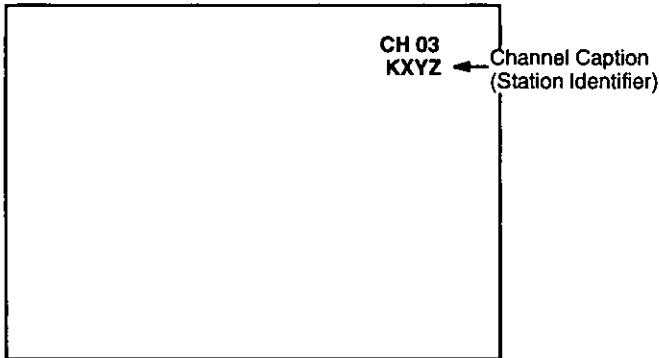

1. Press ACTION button on the TV or Remote (some models).
2. Press ▲ / ▼ and ◀ / ▶ buttons to highlight the Channel Caption Icon.
3. Press ACTION button to display the Channel Caption Menu.

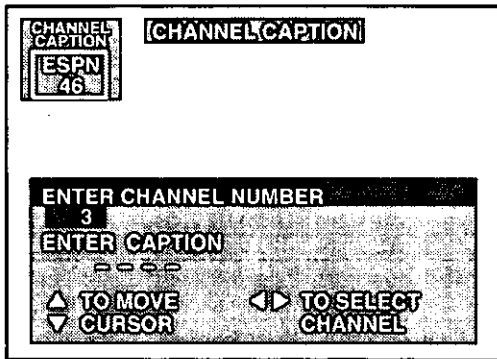

4. Press ◀ / ▶ button or use the Remote Control Keypad (some models) to enter the channel number you wish to assign a Station Identifier.
5. Press ▼ button to highlight ENTER CAPTION.
6. Press ◀ / ▶ button to select first character in Station Identifier. Then press ▼ button to move cursor to the second position and repeat until the complete Station Identifier is entered (up to 4 characters).
7. Press ▲ / ▼ button to highlight ENTER CHANNEL NUMBER. Then repeat steps 4 through 6 to continue adding Channel Station Identifier(s).
8. Press ACTION button twice to exit menus.

NOTE: To delete a Channel Caption (Station Identifier) from memory, all four character positions in the "ENTER CAPTION" area must display a dash mark (-).

Helpful Hints:

When the Maximum amount of station identifiers are entered, "FULL" will be displayed in the caption position.

Timer Features

Sleep Timer

This feature is used for automatic turn off in 30, 60 or 90 minutes. Display will flash 3, 2 and 1 to indicate the last three remaining minutes prior to turn off. The Recall display will also appear.

NOTE: This feature will be disabled when Auto Power On is activated.

1. Press ACTION button on the TV or Remote (some models).
2. Press ▲ / ▼ and ◀ / ▶ buttons to highlight the Timer Icon.
3. Press ACTION button to display the Timer Control Menu.

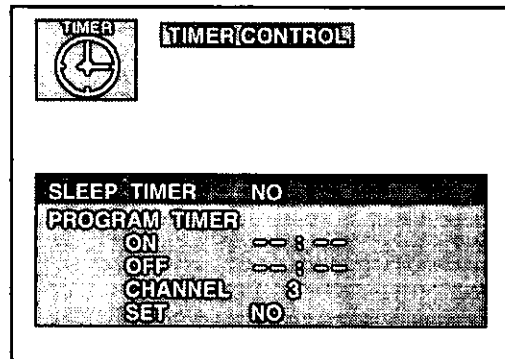

4. Press ▶ button to select NO, 30, 60 or 90 minutes (Sleep Timer will be activated).
5. Press ACTION button twice to exit menus.

NOTE: To deactivate Sleep Timer repeat steps 1 through 4. In step 4 select "NO" instead of minutes.

Helpful Hints:

Press the RECALL button to display the remaining minutes for Sleep Timer, the status will display in the bottom left corner (red).

Timer Features (cont.)

Special Feature:

Automatic turn "OFF" after 90 minutes.

The TV has a special feature that will shut itself **OFF** after 90 minutes when turned **ON** by the program timer unless a function key is pressed during the 90 minutes.

This feature is useful so that the TV will not remain **ON** unattended for an extended period of time.

Programming the **OFF** timer will cancel the automatic **OFF** Special Feature.

Program Timer

This feature is capable of turning the TV on, tuned to a desired channel (some models) and off at a predetermined time (one day or daily). The clock must be set for this feature to operate. (Refer to the Set-Up Menu to set time.)

NOTE: This feature will be disabled when Auto Power On is activated.

1. Press ACTION button on the TV or Remote (some models).
2. Press ▲ / ▼ and ◀ / ▶ buttons to highlight the Timer Icon.
3. Press ACTION button to display the Timer Control Menu.

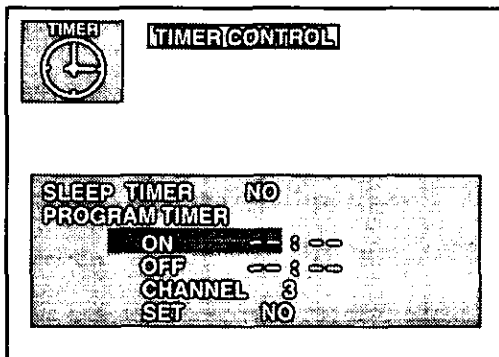

NOTE: Timer Control menu will not display channel option for model CT-2786Y.

4. Press ▼ button to highlight ON (time).
5. Press ◀ / ▶ button repeatedly to set hours (set AM/PM accordingly).
6. Press ▼ button to highlight the minutes position.
7. Press ◀ / ▶ button repeatedly to set minutes.
8. Press ▼ button to highlight OFF (time).

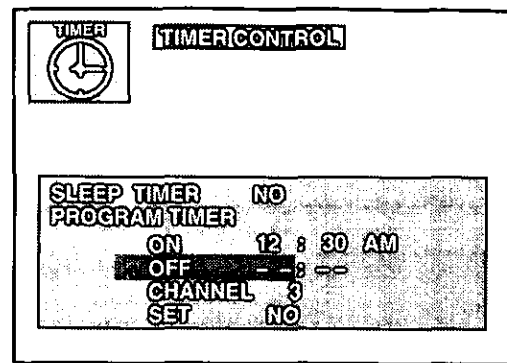

9. Repeat steps 5 through 7 for setting OFF (time).
10. Press ▼ button to highlight CHANNEL.

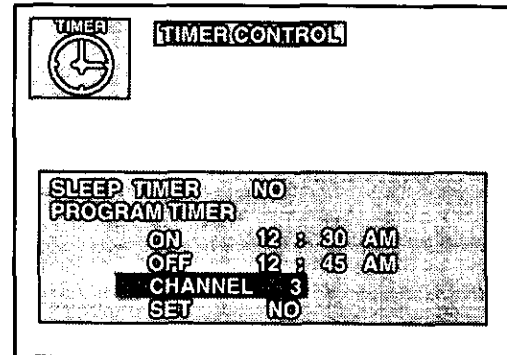

11. Press ◀ / ▶ button or use the Remote Control Keypad (some models) to enter the channel number desired when the set turns "ON".
12. Press ▼ button to highlight SET.

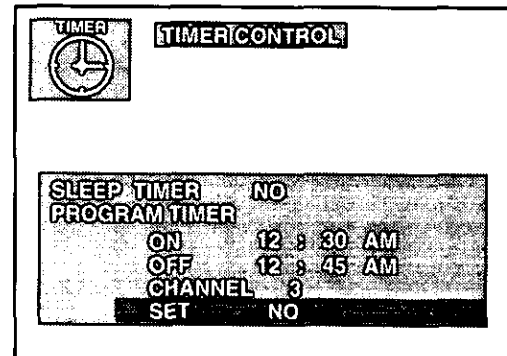

13. Press ▶ button to select:
 - NO – not activated
 - ONE DAY – activated
 - DAILY – activated
 14. Press ACTION button twice to exit menus.
- NOTE: To deactivate Program Timer select NO in step 13.**

Helpful Hints:

- If the Program Timer "ON" functions while the set is operating, the set will automatically tune to the channel designated in the Timer Program.

Set-Up Features

Set Time

Clock (when set) will display on screen at initial "Turn On", after a channel change and when pressing the RECALL button. The time must be set first in order to operate the Program ON/OFF Timer.

NOTE: This feature will be disabled when Auto Power On is activated.

1. Press ACTION button on the TV or Remote (some models).
2. Press ▲ / ▼ and ◀ / ▶ buttons to highlight the Set-Up Icon.
3. Press ACTION button to display the Set-Up Menu.

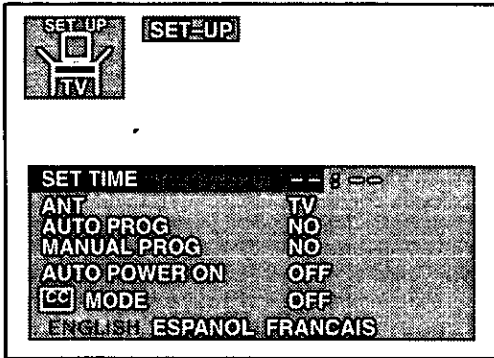

NOTE: For model CT-2786Y, the ANT, AUTO PROG, and MANUAL PROG selections will not be displayed in the Set-Up menus.

4. Press ◀ / ▶ button to set hours (set AM/PM accordingly).
5. Press ▼ button to select minutes position.
6. Press ◀ / ▶ button repeatedly to set minutes.
7. Press ACTION button twice to exit menus.

Antenna (Ant) CT-2786VY only

The proper Input mode must be selected for the type of signal at the antenna input.

- TV mode is used when the Monitor is not connected to a cable TV system, for example when using a VHF/UHF antenna (channels 02 – 69).
- Cable mode is used when the Monitor is connected to a Cable TV system and you are not using a cable company converter box (channels 01 – 125).

1. Press ACTION button on the TV or Remote (some models).
2. Press ▲ / ▼ and ◀ / ▶ buttons to highlight the Set-Up Icon.
3. Press ACTION button to display the Set-Up Menu.

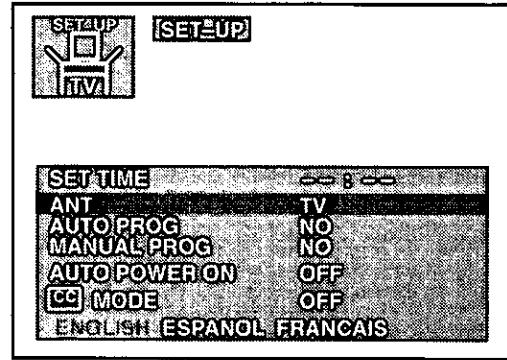

4. Press ▼ button to highlight ANT.
5. Press ◀ / ▶ button to select TV or CABLE.
6. Press ACTION button twice to exit menus.

Auto Prog (CT-2786VY only)

This feature allows you to place all channels with a video signal into Channel Scan Memory.

1. Press ACTION button on the TV or Remote (some models).
2. Press ▲ / ▼ and ◀ / ▶ buttons to highlight the Set-Up Icon.
3. Press ACTION button to display the Set-Up Menu.

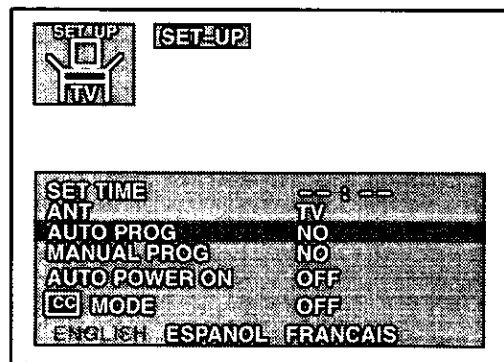

4. Press ▼ button to highlight AUTO PROG.
5. Press ◀ / ▶ button to start Auto Programming. Channels will automatically advance until all channels have been scanned.
6. Press ACTION button twice after completion of Auto Programming to exit menus.

NOTE: Channel numbers with signal present will turn blue which indicates stored in Channel Scan Memory.

Set-Up Features (cont.)

Manual Prog (CT-2786VY only)

This feature allows you to select which channels are placed into Channel Scan Memory.

1. Press ACTION button on the TV or Remote (some models).
2. Press ▲ / ▼ and ◀ / ▶ buttons to highlight the Set-Up Icon.
3. Press ACTION button to display the Set-Up Menu.

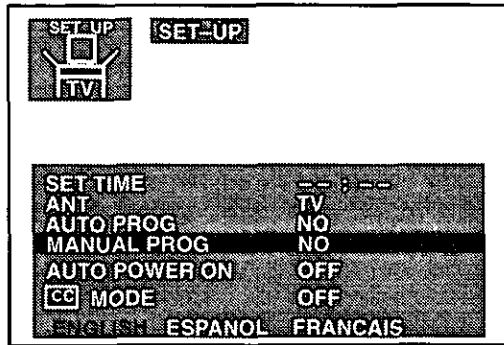

4. Press ▼ button to highlight MANUAL PROG.
5. Press ◀ / ▶ button to display the Manual Programming Menu.

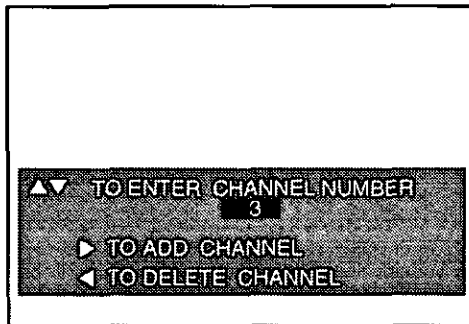

6. Use the ▲ / ▼ button or the Remote Keypad (some models) "0 through 9" buttons to select channels.
7. Press ▶ button to **add** channel(s) to memory (Blue). Press ◀ button to **delete** channels from memory (Yellow).
8. Repeat steps 6 and 7 to continue adding or deleting channels.
9. Press ACTION button twice to exit menus.

Auto Power On

This feature allows the user to power up the TV at the same time as the cable box (or other components). Of course, the TV must be plugged into the cable box.

NOTE: When this feature is activated (on), Timer features will be disabled. Icon changes to Exit.

1. Press ACTION button on the TV or Remote (some models).
2. Press ▲ / ▼ and ◀ / ▶ buttons to highlight the Set-Up Icon.
3. Press ACTION button to display the Set-Up Menu.

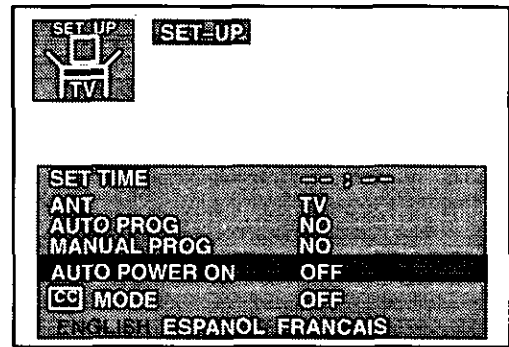

4. Press ▼ button to highlight AUTO POWER ON.
5. Press ◀ / ▶ button to select SET or OFF.
6. Press ACTION button twice to exit menus.

CC (Closed Caption) Mode

This Monitor has a built in decoder that provides a visual depiction of the audio portion of a television program, in the form of written words across the screen (White or Colored letters on a black background). It allows the viewer to read the dialogue of a television program or other information.

NOTE: For CT-2786VY only – When the Closed Caption is in the OFF Mode, the viewer may display closed caption by pressing the Mute button on the remote control. Press again to delete.

1. Press ACTION button on the TV or Remote (some models).
2. Press ▲ / ▼ and ◀ / ▶ buttons to highlight the Set-Up Icon.
3. Press ACTION button to display the Set-Up Menu.

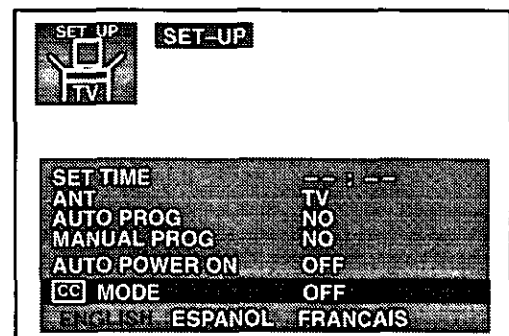

4. Press ▼ button to highlight CC MODE.
5. Press ▶ button to select OFF, C1, or C2.
6. Press ACTION button twice to exit menus.

Instant-On Feature

This Monitor has an Instant-On feature which automatically turns the unit ON when AC power is supplied.

This feature initiates the Monitor to turn ON automatically when using it with other equipment connected to a main power supply switch. (Such as: AC power strip or when plugged directly into the back of a computer.)

Once initial power has been supplied and the Monitor turns ON, the POWER switch located on the front of the Monitor may be used to turn the Monitor OFF and ON as desired.

NOTE: This feature can also be activated with Auto Power On feature, located in the Set-up menu.

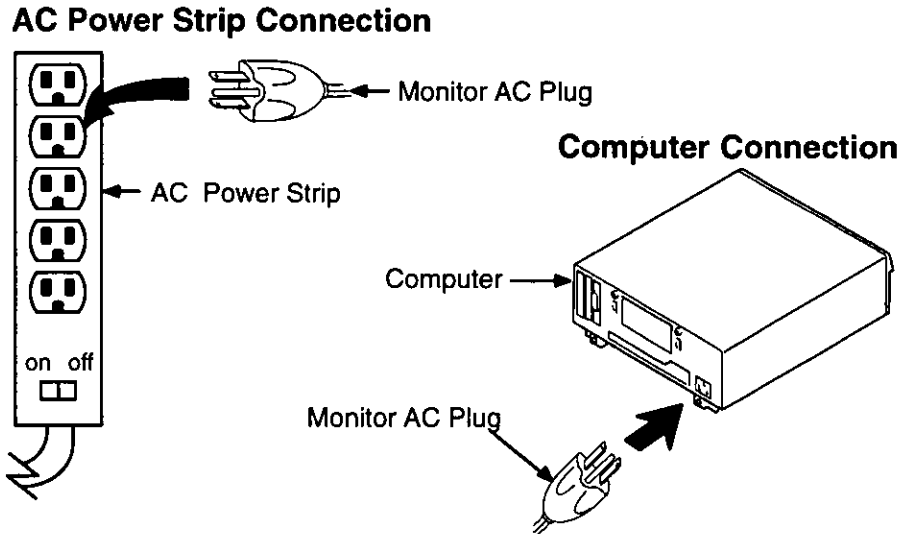

Procedure for Instant-On feature

With the Monitor turned ON, press the ACTION and VOL LEFT (◀) buttons on the Control panel simultaneously, then quickly press the ACTION and DOWN (▼) buttons on the Control panel simultaneously. This will activate the Instant-On feature, to deactivate repeat procedure.

NOTE: There will be no On-Screen display.

To confirm if the Instant-On feature is activated. Turn the Monitor OFF, then unplug it and plug it back in. The Monitor should turn on automatically.

Control Panel Lock Feature

Procedure for Control Panel Lock feature

With the Monitor turned ON, press the ACTION and VOL RIGHT (▶) buttons simultaneously, then quickly press the ACTION and UP (▲) buttons simultaneously. This will activate the Keyboard Lock feature, to deactivate repeat procedure.

NOTE: There will be no On Screen display.















To confirm if the Control Panel Lock feature is activated, press any button other than the POWER button (the Power button is never disabled).

NOTES:

NOTES:

Troubleshooting Chart

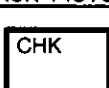
Before you call for service, determine the symptoms and make a few simple checks shown below.

Symptoms		Check
Picture	Sound	
 SNOWY PICTURE	 NOISY SOUND	<ul style="list-style-type: none"> - INPUT CONNECTORS SEATED PROPERLY - EQUIPMENT CONNECTED TO INPUT CONNECTIONS - ANTENNA LOCATION AND/OR CONNECTION
 INTERFERENCE	 NOISY SOUND	<ul style="list-style-type: none"> - ELECTRICAL APPLIANCES, LIGHTS, CARS AND TRUCKS - DIATHERMY AND OTHER MEDICAL EQUIPMENT - VIDEO INPUT CONNECTOR SEATED PROPERLY
 NORMAL PICTURE	 NO SOUND	<ul style="list-style-type: none"> - VOLUME CONTROL SETTING - TV SPEAKERS (IF APPLICABLE) IN THE OFF MODE - AUDIO INPUT CONNECTOR SEATED PROPERLY - TRY ANOTHER CHANNEL
 NO PICTURE	 NO SOUND	<ul style="list-style-type: none"> - THAT AC POWER LINE IS PLUGGED INTO AC OUTLET - BRIGHTNESS AND AUDIO CONTROLS SET PROPERLY - VIDEO AND AUDIO INPUT CONNECTORS SEATED PROPERLY - TRY ANOTHER CHANNEL
 NO COLOR	 NORMAL SOUND	<ul style="list-style-type: none"> - COLOR CONTROL SETTINGS - TRY ANOTHER CHANNEL
 BLACK PICTURE	 NO SOUND	<ul style="list-style-type: none"> - MONITOR/RECEIVER IN VIDEO MODE WITH NO SIGNAL
 CHK MODE	 NORMAL SOUND	<ul style="list-style-type: none"> - PRESS AND HOLD ACTION AND POWER BUTTONS ON THE CONTROL PANEL AT THE SAME TIME FOR 5 SECONDS. SCREEN WILL SHUT OFF, THEN TURN BACK ON. TV WILL BE SET TO CHANNEL 3 AND CYCLE THROUGH A SPECIAL TEST

Panasonic®

BROADCAST AND DIGITAL SYSTEMS

PANASONIC BROADCAST AND DIGITAL SYSTEMS COMPANY

Division of Matsushita Electric Corporation of America

Executive Office

One Panasonic Way, Secaucus, New Jersey, 07094 (201) 348-7000

GSA - 52 West Gude Drive, Rockville, Maryland 20850 (301) 738-3840

Southern Regional Sales Office, 1225 Northbrook Parkway, Suite 1-160, Suwanee, Georgia 30174 (770) 338-6841

Eastern Regional Sales Office, Panasonic BTS, 43 Hartz Way, Secaucus, New Jersey 07094 (201) 348-7620

Midwest Regional Sales Office, Panasonic BTS, 1707 North Randall Road, Elgin, Illinois 60123 (847) 468-5200

Western Regional Sales Office, Panasonic BTS, 6550 Katella Avenue, Cypress, California 90630 (714) 373-7271

PANASONIC CANADA INC.

5770 Ambler Drive, Mississauga, Ontario, L4W 2T3 (905) 624-5010

PANASONIC SALES COMPANY

San Gabriel Industrial Park, 65th Infantry Ave., KM.9.5, Carolina, Puerto Rico 00630 (787) 750-4300

Free Manuals Download Website

<http://myh66.com>

<http://usermanuals.us>

<http://www.somanuals.com>

<http://www.4manuals.cc>

<http://www.manual-lib.com>

<http://www.404manual.com>

<http://www.luxmanual.com>

<http://aubethermostatmanual.com>

Golf course search by state

<http://golfingnear.com>

Email search by domain

<http://emailbydomain.com>

Auto manuals search

<http://auto.somanuals.com>

TV manuals search

<http://tv.somanuals.com>