

Color Television

Operating Instructions

Panasonic®

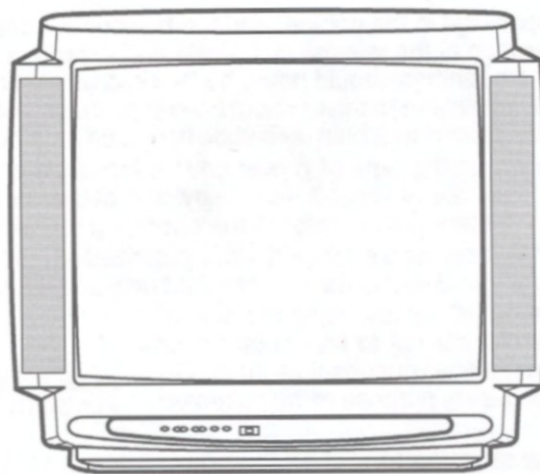

CT-27S20

Read these instructions completely before operating this set.
Contents subject to change without notice or obligation.

Safety Instructions

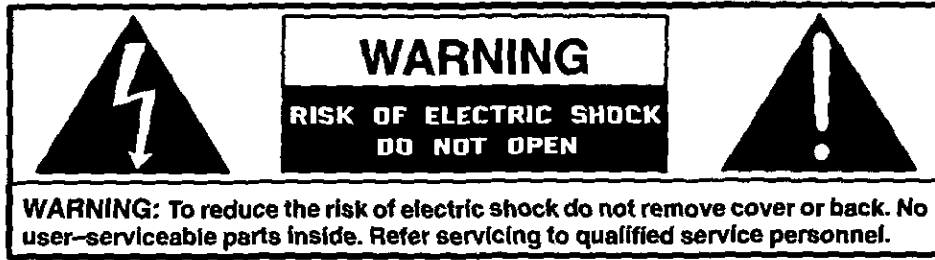

The lightning flash with arrow-head within a triangle is intended to tell the user that parts inside the product are a risk of electric shock to persons



The exclamation point within a triangle is intended to tell the user that important operating and servicing instructions are in the papers with the appliance

Note To CATV System Installer: This reminder is provided to call the CATV system installer's attention to Article 820-40 of the NEC that provides guidelines for proper grounding and, in particular, specifies that the cable ground shall be connected to the grounding system of the building, as close to the point of cable entry as practical

Safety Instructions For Television Receivers

- 1 Read and apply the operating instructions provided with your television receiver
- 2 Read all of the instructions given here and retain them for later use
- 3 Unplug this television receiver from the wall outlet before cleaning. Do not use liquid or aerosol cleaners. Use a damp cloth for cleaning.
- 4 Do not use attachments not recommended by the television receiver manufacturer as they may cause hazards.
- 5 Do not use this television receiver near water. For example, avoid placing it near a bathtub, washbowl, kitchen sink, or laundry tub, in a wet basement, or near a swimming pool, etc.
- 6 Do not place this television receiver on an unstable cart, stand, or table. The television receiver may fall, causing serious injury to a child or adult, and serious damage to the appliance. Use only with a cart or stand recommended by the manufacturer, or sold with the television receiver. Wall or shelf mounting should follow the manufacturer's instructions, and should use a mounting kit approved by the manufacturer.
- 6A An appliance and cart combination should be moved with care. Quick stops, excessive force, and uneven surfaces may cause the appliance and cart combination to overturn.
- 7 Slots and openings in the cabinet and the back or bottom are provided for ventilation, and to insure reliable operation of the television receiver and to protect it from overheating. These openings must not be blocked or covered. The openings should never be blocked by placing the television receiver on a bed, sofa, rug or other similar surface. This television receiver should never be placed near or over a radiator or heat register. This television receiver should not be placed in a built-in installation such as a bookcase unless proper ventilation is provided.
- 8 Operate only from the type of power source indicated on the marking label. If you are not sure of the type of power supplied to your home, consult your television dealer or local power company. For television receivers designed to operate from battery power, refer to the operating instructions.
- 9 This television receiver is equipped with a polarized alternating-current line plug (a plug having one blade wider than the other). This plug will fit into the power outlet only one way. This is a safety feature. If you are unable to insert the plug fully into the outlet, try reversing the plug. If the plug should still fail to fit, contact your electrician to replace your obsolete outlet. Do not defeat the safety purpose of the polarized plug.
- 10 Do not allow anything to rest on the power cord. Do not locate this television receiver where the cord will be abused by persons walking on it.
- 11 Follow all warnings and instructions marked on the television receiver.
- 12 Do not overload wall outlets and extension cords as this can result in fire or electric shock.
- 13 Never push objects of any kind into this television receiver through cabinet slots as they may touch dangerous voltage points or short out parts that could result in a fire or electric shock. Never spill liquid of any kind on the television receiver.

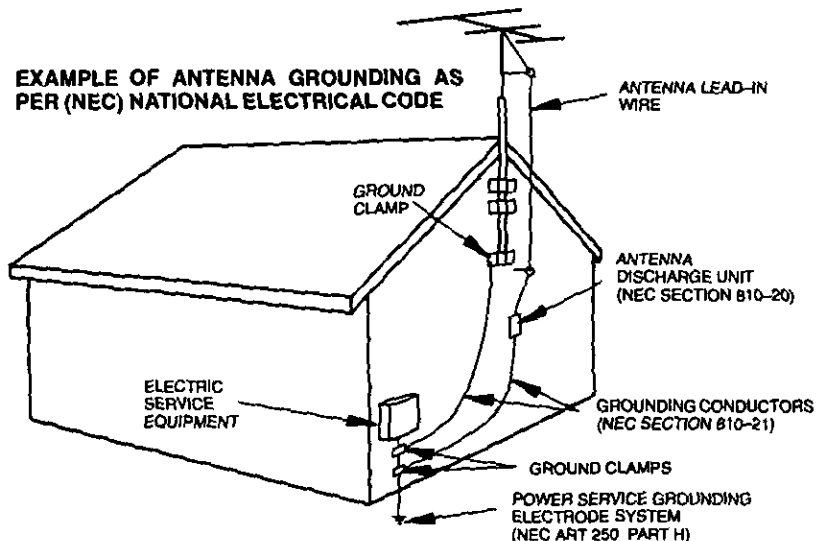

14. If an outside antenna is connected to the television equipment, be sure the antenna system is grounded so as to provide some protection against voltage surges and built up static charges. In the U.S. Section 810 of the National Electrical Code and in Canada Part 1 of the Canadian Electrical Code provides information with respect to proper grounding of the mast and supporting structure, grounding of the lead-in wire to an antenna discharge unit, size of grounding conductors, location of antenna-discharge unit, connection to grounding electrodes, and requirements for the grounding electrode. See Figure.
15. For added protection for this television receiver during a lightning storm, or when it is left unattended and unused for long periods of time, unplug it from the wall outlet and disconnect the antenna. This will prevent damage to the receiver due to lightning and power-line surges.
16. An outside antenna system should not be located in the vicinity of overhead power lines or other electric light or power circuits, or where it can fall into such power lines or circuits. When installing an outside antenna system extreme care should be taken to keep from touching such power lines or circuits as contact with them might be fatal.
17. Unplug this television receiver from the wall outlet, and refer servicing to qualified service personnel under the following conditions:
 - a. When the power cord or plug is damaged or frayed.
 - b. If liquid has been spilled into the television receiver.
 - c. If the television receiver has been exposed to rain or water.
 - d. If the television receiver does not operate normally by following the operating instructions. Adjust only those controls that are covered by the operating instructions as improper adjustment of other controls may result in damage and will often require extensive work by a qualified technician to restore the television receiver to normal operation.
 - e. If the television receiver has been dropped or the cabinet has been damaged.
 - f. When the television receiver exhibits a distinct change in performance – this indicates a need for service.
18. Do not attempt to service this television receiver yourself as opening or removing covers may expose you to dangerous voltage or other hazards. Refer all servicing to qualified service personnel.
19. When replacement parts are required, be sure the service technician has used replacement parts specified by the manufacturer that have the same characteristics as the original part. Unauthorized substitutions may result in fire, electric shock, or other hazards.
20. Upon completion of any service or repairs to this television receiver, ask the service technician to perform routine safety checks to determine that the television is in safe operating condition.
21. **WARNING: To prevent fire or shock hazard, do not expose this appliance to rain or moisture.**
22. **CAUTION: TO PREVENT ELECTRIC SHOCK DO NOT USE THIS (POLARIZED) PLUG WITH A RECEPTACLE OR OTHER OUTLET UNLESS THE BLADES CAN BE FULLY INSERTED TO PREVENT BLADE EXPOSURE.**

NOTE: This equipment is designed to operate in the U.S.A., Canada and other countries where the broadcasting system and AC house current is exactly the same as in the U.S.A. and Canada.

Important Information Regarding Use of Video Games, Computers, Teletext or Other Fixed Image Displays.

The extended use of fixed image program material can cause a permanent "shadow image" on the picture tube. This background image is viewable on normal programs in the form of a stationary fixed image. This type of irreversible picture tube deterioration can be limited by observing the following steps:

- A. Reduce the brightness/contrast setting to a minimum viewing level.
- B. Do not display the fixed image for extended periods of time.
- C. Turn the power off when not in actual use.

NOTE: The marking or retained image on the picture tube resulting from fixed image use is not an operating defect and as such is not covered by Warranty. This product is not designed to display fixed image patterns for extended periods of time.

Specifications

- | | |
|-------------------------------|---|
| Power Source: | 120V, 60Hz, AC |
| Channel Capability: | 181 channels (See chart)
VHF 2~13, UHF 14~69, Cable 125 channels |
| Video Input Jack: | 1V p-p, 75 ohm, phono jack type |
| Audio Input Jacks: | 500 mV rms 47K ohm |
| To Audio AMP Jacks: | 0~2.0V rms 4.7K ohm |
| Stereo Sound | |
| Closed Caption Display | |
| Picture in Picture: | 1 Tuner |

Channel Capability Chart

BAND	USA/CAN
VHF	12
UHF	56
CABLE (Mid-Band)	15
CABLE (Super Band)	14
CABLE (Hyper Band)	28
CABLE (Ultra Band)	56
TOTAL CHANNELS	181

Specifications are subject to change without notice or obligation.

Introduction

Congratulations on Your New Purchase

Your new video component features an all solid state chassis which is designed to give you many years of enjoyment. It was thoroughly tested and adjusted at the factory for best performance.



In order for you to take full advantage of your new video component, please read and follow the installation and operating instructions supplied with this product.

Customer's Record

The model and serial number of this product may be found on its back cover. You should note the model and serial number in the space provided and retain this book as a permanent record of your purchase to aid in identification in the event of theft or loss.

Model Number: _____ Serial Number: _____

Table of Contents

Safety Instructions	2	Picture Norm	17
Specifications	3	Game Guard	18
Introduction	4	Game Guard (Lockout)	18
Installation	5	Game Guard (Unlock)	19
Receiver Location	5	Timer Features	20
Optional External Equipment Connections	5	Sleep Timer	20
AC Power Supply Cord	5	Program Timer	21
Battery Installation	5	Set-Up Features	22
Antenna/Cable Connections	6	Menu	22
Other Video Equipment	6	 On Mute	23
Picture in Picture External Video and		Set Time	24
Antenna Connection	7	Antenna	25
Location of Controls (Remote)	8	Auto Program	26
Location of Controls (Receiver)	9	Manual Program	27
Remote Control Quick Reference Functional		 Mode	28
Key Chart	10	Language	29
Control Operation	12	Channel Caption	30
Power Button	12	Audio Adjustments	31
Volume (Vol) Buttons	12	Audio Mode Selection	31
Mute Button	12	AI Sound	31
Channel Change Features	12	Input Select	32
Channel (Ch) Buttons	12	Main (Picture) Input Selection	32
Numeric Keypad (0 through 9 Buttons)	12	PIP Input Selection	32
VCR Function Buttons	12	Programming The Universal Remote Control	33
Recall Button	13	VCR Infrared Codes Index	34
R-Tune Button	13	Cable Converter Box and CD Players	
Multi Button	13	Infrared Codes Index	35
TV/Video Button	14	Cassette Players, Receivers, and Amplifiers	
PIP (Picture in Picture) Button	14	Infrared Codes Index	36
Swap Button	15	Laser Disc, DSS, and DVD Infrared Codes Index .	37
Size Button	15	Optional Equipment Connection and Operation .	38
Freeze Button	15	Stereo Connection (To Audio AMP)	38
Move Button	15	Video/Audio Connection	38
Main Menu (Icons)	16	Care and Cleaning	39
Picture Adjustments	17	Power Loss	39
Color, Tint, Brightness, Picture and Sharpness		Troubleshooting Chart	40
Adjustments	17		

Installation

Receiver Location

This unit is intended to be used with an optional stand or entertainment center. Consult your dealer for available options. Locate for comfortable viewing. Avoid placing where sunlight or other bright light (including reflections) will fall on the screen.

Use of some types of fluorescent lighting can reduce remote control transmitter range.

Adequate ventilation is essential to prevent internal component failure. Keep away from areas of excessive heat or moisture.

To insure optimum color purity do not position magnetic equipment (motors, fans, other speakers, etc.) nearby.

Optional External Equipment Connections

The Video/Audio connections between components can be made with shielded video and audio cables. For best performance, video cables should utilize 75 ohm coaxial shielded wire. Cables are available from your dealer or electronic supply house.

Before you purchase any cables, be sure you know what type of output and input connectors your various components require. Also determine the length of cable you'll need.

AC Power Supply Cord

CAUTION: To prevent electric shock, match wide blade of plug to wide slot of AC outlet and fully insert. DO NOT USE this (polarized) plug with a receptacle or other outlet unless the blade can be fully inserted to prevent blade exposure.

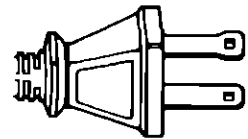

Polarized Plug

Remote Control Battery Installation

Batteries Use two "AA" batteries.

- 1 Turn the Transmitter face down. To remove top cover, press down on marking and slide cover off in the direction indicated.
- 2 Install the batteries as shown in the battery compartment. (Polarity (+) or (-) must be correct.)
- 3 Replace the cover and slide in reverse until the lock snaps.

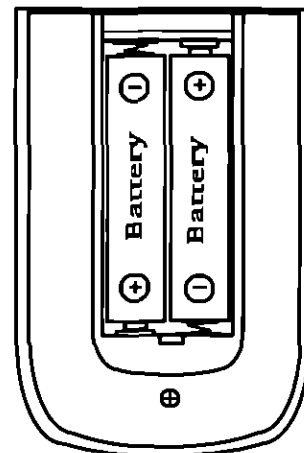

Helpful Hint:

For frequent Remote Control users, replace old batteries with Alkaline batteries for longer life.

CAUTION: Incorrect installation can cause battery leakage and corrosion that will damage the Remote Control Transmitter.

Note: In order to maximize the life of the batteries, the lighted buttons on the Remote Control can be turned OFF and ON by pressing R-TUNE and RECALL at the same time.

Observe the Following Precautions:

- 1 Batteries should be replaced as a pair. Always use new batteries when replacing the old set.
- 2 Do not combine a used battery with a new one.
- 3 Do not mix battery types (Example "Zinc Carbon" with "Alkaline").
- 4 Do not attempt to charge, short-circuit, disassemble, heat or burn used batteries.
- 5 Battery replacement is necessary when Remote Control reacts sporadically or stops operating the Receiver.

Helpful Hint:

Whenever you remove the batteries to replace them, you may need to reset the Remote Control Infrared Codes. We recommend that you initially record the codes on page 33, when you setup the remote.

Press Down Here
And Slide Cover
Back

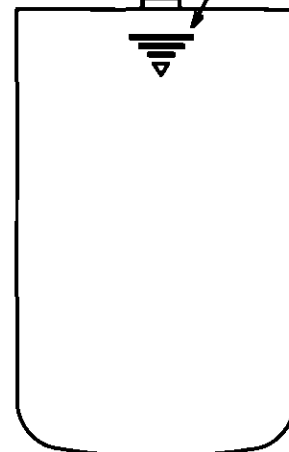

Installation (cont.)

Antenna/Cable Connections

Antenna Connection – For proper reception of VHF/UHF channels an external antenna is required. For best reception an outdoor antenna is recommended. Antenna Mode must be set to TV (Refer to Antenna Mode section)

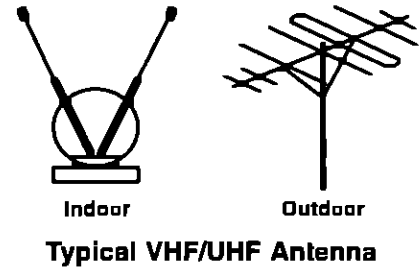

Incoming Cable From Home Antenna (75 Ohm)

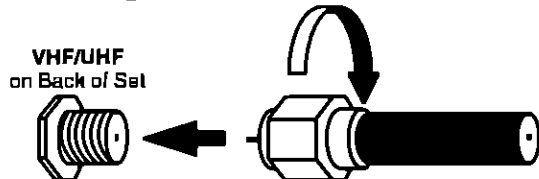

Incoming Cable From Home Antenna (300 Ohm)

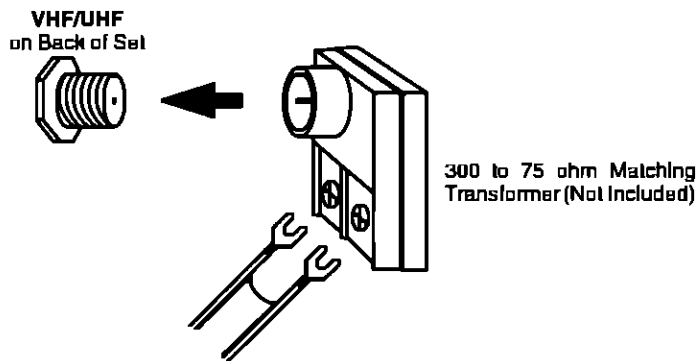

Cable Connection – For reception of cable channels, connect the cable supplied by your local cable company. Antenna Mode must be set to CABLE (Refer to Antenna Mode section)

Incoming 75 Ohm Cable (From Cable Company)

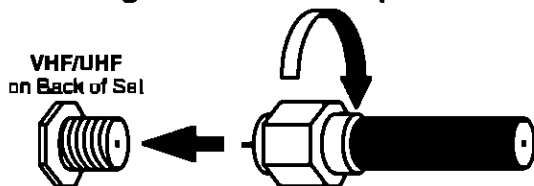

NOTE: Certain cable systems offset some channels to reduce interference or have Premium (scrambled) channels. A cable converter box is required for proper reception. Check with your local Cable company for compatibility requirements.

Other Video Equipment

VCRs, Video Disc Players, Computers, TV games, and Teletext equipment can also be connected to the antenna input connection.

Picture in Picture External Video and Antenna Connection

This Receiver has the "PICTURE IN PICTURE" feature. For the proper operation of this feature, a second video source is required (such as a VCR). We recommend that you make your antenna and External Video connection as shown below, when a second video source is available.

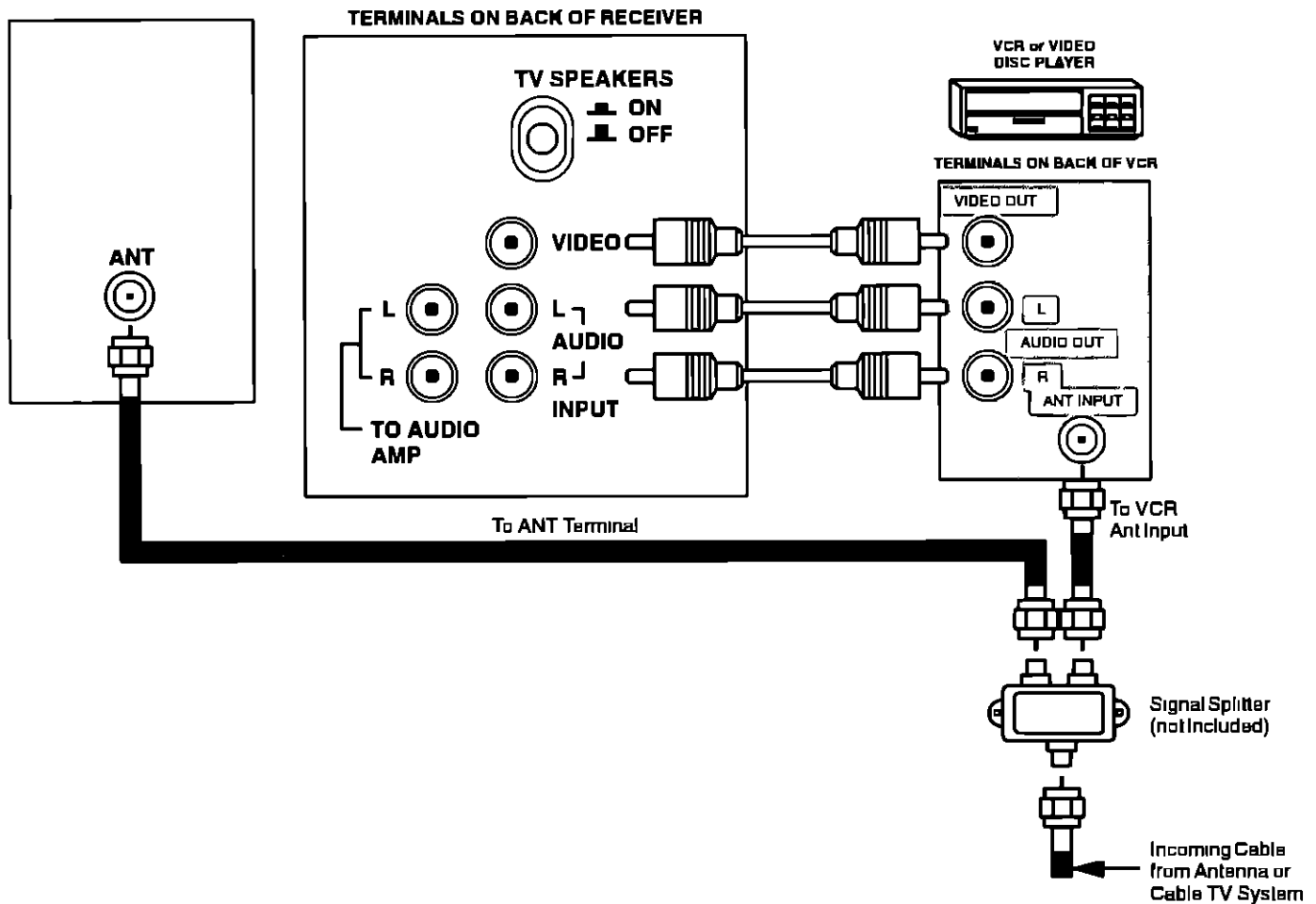

Helpful Hints:

The PIP will operate using Audio/Video input terminals. Use the TV/VIDEO button (when the PIP frame is displayed) to select Video mode.

Location of Controls for the Illuminated Home Theater Remote Unit

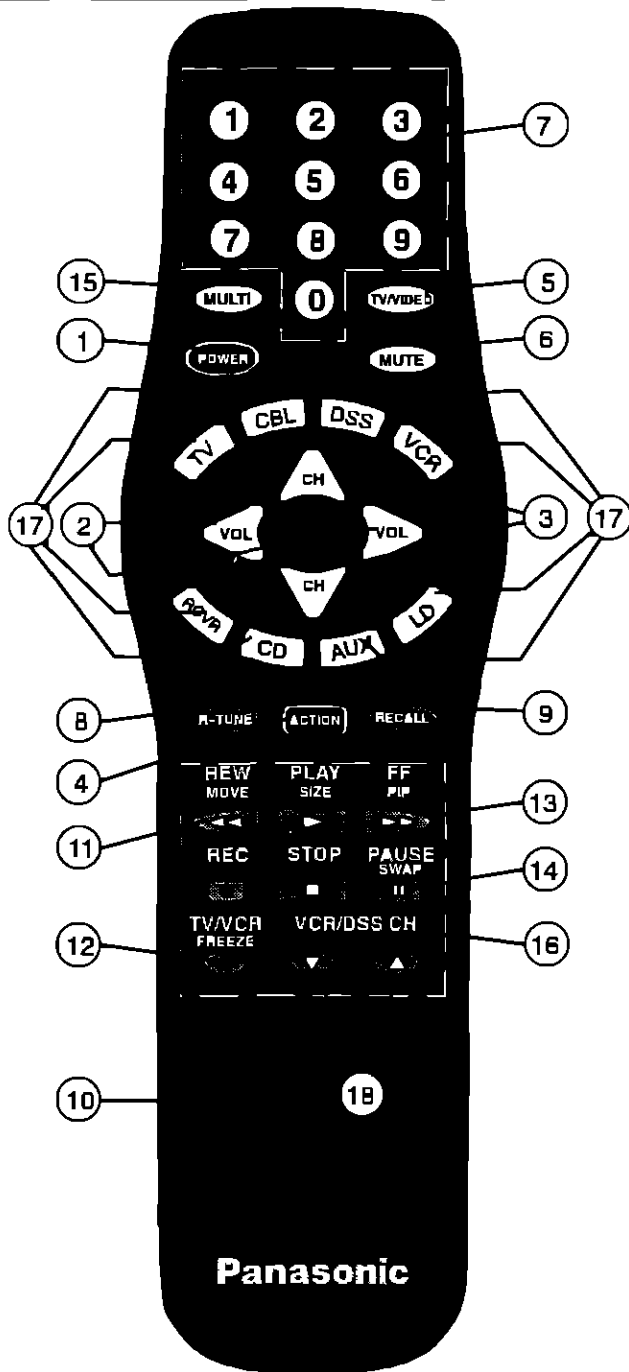

Basic Remote Control Functions

The following is a basic overview of the remote control unit for television operation. Ensure the TV mode is selected by initially pressing **TV**. Please refer to the indicated pages for more information.

- ① **Power Button** – Press to turn the TV ON or OFF
- ② **Volume Buttons** – Press to adjust TV sound level. Use with Channel buttons to navigate in menus.
- ③ **Channel Buttons** – Press to select channels. Use with Volume buttons to navigate in menus.
- ④ **Action Button** – Press to display Main Menu and access or exit On-Screen feature and Adjustment Menus.
- ⑤ **TV/Video Button** – Press to select TV or Video Inputs, for the Main Picture or the PIP frame (when the PIP frame is displayed).
- ⑥ **Mute Button** – Press to mute sound. A second press returns sound.
- ⑦ **Numeric Keypad (0 through 9 Buttons)** – Press desired channel number to access any channel.
- ⑧ **R-Tune (Rapid Tune) Button** – Switches between two (2) channels.
- ⑨ **Recall Button** – Press to display Time, status of Sleep Timer, Channel, Video Mode, Channel Caption (Station Identifier), and Audio Mode.
- ⑩ **Size Button** – Press to select size of PIP frame (when the PIP frame is displayed).
- ⑪ **Move Button** – Press to position PIP frame to any corner of the Main Picture (when PIP frame is displayed).
- ⑫ **Freeze Button** – Press to stop action in the Main Picture or PIP frame (when the PIP frame is displayed).
- ⑬ **PIP (Picture In Picture) Button** – Press to display the PIP frame, press again to remove PIP frame.
- ⑭ **Swap Button** – Press to interchange PIP frame with Main Picture (when the PIP frame is displayed).

Note: In order to maximize the life of the batteries, the lights can be turned OFF and ON by pressing R-TUNE and RECALL at the same time.

Helpful Hints:

If the selected component does not respond to the remote control, ensure that the proper mode is selected. First, press the **Mode Selection Button** that corresponds to that component. For example, after first pressing the TV Mode Button, the remote will remain in the TV mode for any following commands. If a different mode button is pressed while operating the television, the TV mode button must be pressed again to reset the TV mode condition.

- ⑮ **Multi Button** – Programmable to operate up to six (6) Remote Function buttons simultaneously.
- ⑯ **VCR Function Buttons** – Programmable to operate many brands of VCR's.
- ⑰ **Mode Selection Buttons** – Selects the operation mode for the remote control.
- ⑱ **VCR/DSS Channel Buttons** – These buttons are used to select VCR or DSS Up/Down channels.

NOTE: For more information on the Remote Control, please refer to the Remote Control Quick Reference Functional Key Chart (pages 10 and 11).

Location of Controls (Receiver)

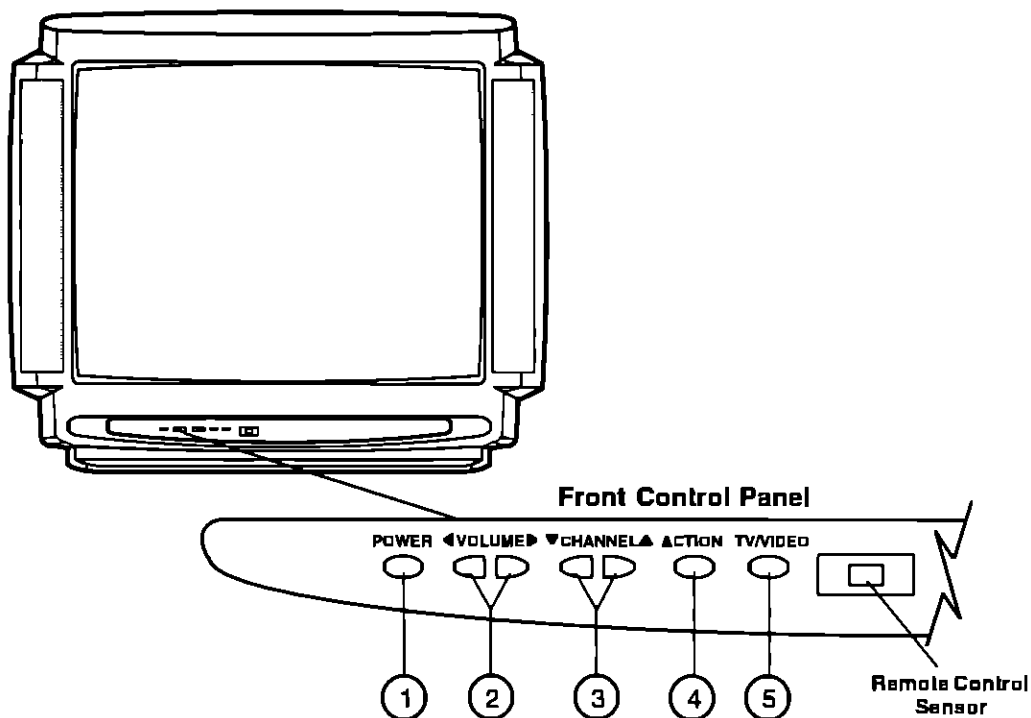









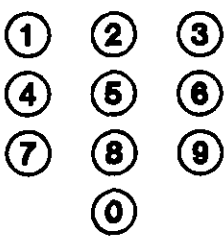













Quick Reference Control Operation (Remote Control and Receiver)

- ① **Power Button** – Press to turn ON or OFF
- ② **Volume Buttons** – Press to adjust Sound Level Press to adjust Audio Menus, Video Menus, and select operating features when menus are displayed
- ③ **Channel Buttons** – Press to select programmed channels Press to highlight desired features when menus are displayed Also used to select Cable Converter box channels after programming Remote Control Infrared codes
- ④ **Action Button** – Press to display Main Menu and access or exit On-Screen feature and Adjustment Menus
- ⑤ **TV/Video Button** – Press to select TV or Video Input, for the Main Picture or the PIP frame (when the PIP frame is displayed)











Remote Control

Quick Reference Functional Key Chart

KEY	MODE	FUNCTION
	TV VCR CABLE, DSS	Selects Channel Selects Channel Selects Channel
	RECEIVER/AMPLIFIER	 Selects Tuner  Selects CD Player  Selects Tape Cassette Player  VCR 1  VCR 2  VCR 3
	CD PLAYER	Selects Track Number
	LD PLAYER	Selects Track Number
	ALL COMPONENTS	Programmable Button That Can Operate Up To Six Remote Functions At Once
	TV	Selects the TV Input Mode
	ALL COMPONENTS	Turns On and Off Selected Components
	TV, DSS, VCR, LDP CABLE RECEIVER/AMPLIFIER	Mutes TV Audio Mutes Audio Mutes Audio
	TV	TV Mode Selection for Remote Control
	CABLE	Cable Mode Selection for Remote Control
	DSS (DIGITAL SATELLITE SYSTEM)	DSS Mode Selection for Remote Control
	VCR	VCR Mode Selection for Remote Control
	RECEIVER/AMPLIFIER	Receiver/Amplifier Mode Selection for Remote Control
	COMPACT DISC	CD Mode Selection for Remote Control
	CASSETTE PLAYER, DVD	AUX Mode Selection for Remote Control Enables User to Operate a Tape Cassette Player, or Digital Video Disc
	LASER DISC PLAYER	LD Mode Selection for Remote Control
 	TV CABLE DSS LDP CD RECEIVER/AMPLIFIER DVD	Channel Up/Down, Menu Navigation Channel Up/Down DSS Guides and Menu Navigation Skip FF, REW Preset or Tuning Frequency Skip FWD / Skip REW
 	TV CABLE DSS RECEIVER/AMPLIFIER VCR LDP	Volume Up/Down, Menu Navigation Volume Up/Down DSS Guides and Menu Navigation Volume Up/Down TV Volume Up/Down TV Volume Up/Down

Remote Control

Quick Reference Functional Key Chart (cont.)

KEY	MODE	FUNCTION
	LDP TV CABLE VCR DSS RECEIVER/AMPLIFIER CD TAPE CASSETTE PLAYER	Side A/B Switches Between Two (2) Channels Switches Between Two (2) Channels Switches Between Two (2) Channels Switches Between Two (2) Channels Switches between AM and FM Selects Next Disc Selects Tape Cassette Player A or B
	TV DSS	Activates TV Menus Acts as Menu Button for DSS
	TV DSS VCR LDP	Displays Channel, Time, and Audio Mode Displays Current DSS Settings Displays Current VCR Settings Displays Current LDP Settings
	TV DSS VCR LDP TAPE CD DVD	PIP Move DSS Guide Rewind Rewind Rewind Selects Previous Track Rewind
	TV DSS VCR LDP TAPE CD DVD	PIP Size Enter/Select Play Play Play (in Normal Direction) Play Play
	TV DSS VCR LDP TAPE CD DVD	PIP On/Off Exit/Clear Fast Forward Fast Forward Fast Forward Selects Next Track Fast Forward
	DSS VCR TAPE CABLE	One Touch Record in DSS Mode Record Record VCR Record
	DVD VCR LDP TAPE CD CABLE	Stop Stop Stop Stop Stop VCR Stop
	DVD TV VCR LDP TAPE CD CABLE	Pause PIP Swap Pause Pause Pause Pause VCR Pause
	TV VCR DSS CABLE	PIP Freeze Selects TV/VCR Mode Selects TV/DSS Mode Selects TV/VCR Mode
	TV VCR DSS CABLE	PIP Channel Up/Down (2 Tuner PIP Models Only) Channel Up/Down Channel Up/Down VCR Up/Down

Control Operation

Helpful Hints:

- Press the TV Mode Selection button to operate TV Remote functions, if necessary



Power Button – Press the POWER button after selecting a mode to turn ON Press again to turn OFF



Volume Button – Press the or button for desired listening level (when On-Screen menus are not displayed)

Located On Remote Control

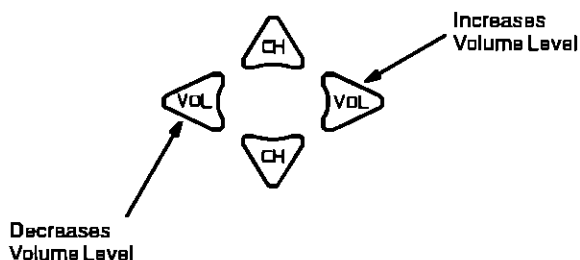

Mute Button – Press the MUTE button to quickly reduce sound level (Mute will appear on screen) Press again to restore sound



Helpful Hints:

Helpful information will display On Screen momentarily when Receiver is first turned on and when the channel is changed.

NOTE: If "SPEAKER OFF" is displayed On Screen after pressing the VOLUME button, refer to Audio Menu to turn Speakers "ON".

Channel Change (UP/DOWN)

Press the or button to sequentially scan through programmed channels (when On-Screen menus are not displayed)

NOTE: Press the TV Mode button to operate TV Remote functions, if necessary

Located On Remote Control

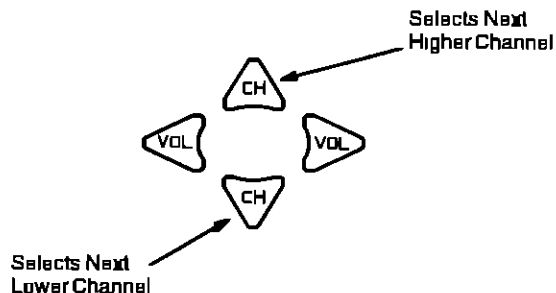

Numeric Keypad (0 through 9 Buttons)

Press two digits on numeric keypad (0 through 9 buttons) (Example press 0, then 5 for channel 05) For channels over 99, press three digits on keypad

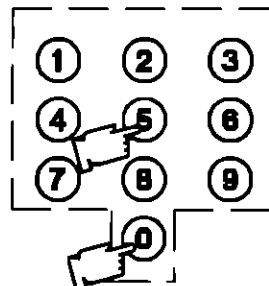

VCR Function Buttons – The VCR FUNCTION buttons have been designed to operate numerous brands of VCRs The infrared code must be obtained prior to use (Please refer to Programming the Universal Remote for programming instructions)

NOTE: Press the VCR Mode Selection button to operate VCR Remote functions

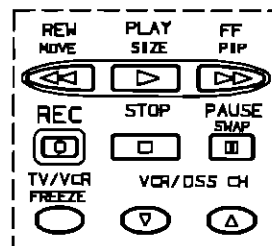

Control Operation (cont.)

Helpful Hints:

Press the TV Mode Selection button to operate TV Remote functions, if necessary



Recall Button — Press the RECALL button to review

- ① Audio Mode status
- ② CH number or Video Input selected
- ③ Sleep Timer status
- ④ Clock time
- ⑤ Channel Caption (Station Identifier)

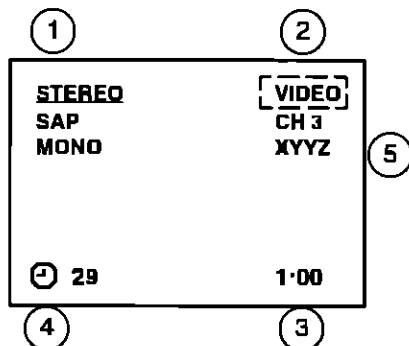

R-Tune Button — Press the R-TUNE (RAPID TUNE) button to instantly switch between the last two channels selected (without any On-Screen display being activated)

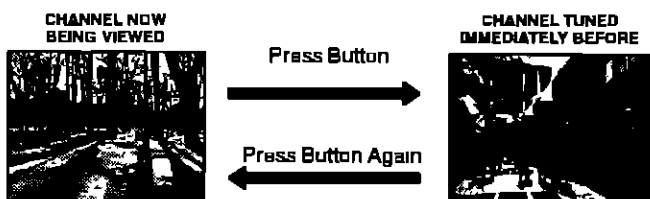

Multi Button

The MULTI button can be programmed to operate up to six (6) Remote function buttons at the same time. For Example: TV Power/On, VCR Power/On and Cable box Power/On (selected brands) can be operated at the same time with one press of the MULTI button

Procedure

- 1 First program the Remote for the selected device Infrared access code Confirm that the Remote Control is compatible with the equipment
- 2 Face the Remote Control transmitter away from all equipment remote sensors
- 3 Press and hold the Remote POWER button, then press and hold the ACTION button down at the same time for three seconds (All previous commands are erased)

PRESS AT THE SAME TIME FOR THREE SECONDS

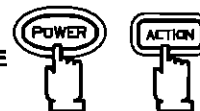

- 4 After three seconds, let go of the POWER and ACTION buttons
- 5 Press the MULTI button (Waiting more than 30 seconds without pressing another button will exit the programming mode)
- 6 Press a maximum of six (6) function buttons on the Remote

Each button you press is equal to one function. If six Remote button functions are entered, all will register in the MULTI button memory in the sequence entered. When finished, press the MULTI button to end the program mode.

The following is an example flow chart of Remote functions that can be programmed into the MULTI button (The VCR Mode button should be programmed before starting procedure).

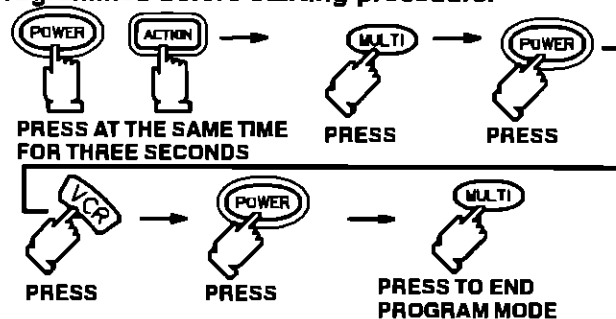

Now you can turn the TV and VCR ON/OFF at the same time with one press of the MULTI button

To delete entered functions — Press and hold the Remote POWER button then press and hold the ACTION button down at the same time for three seconds. Now you can enter from one to six different Remote functions

NOTE: You can also program the MULTI button to perform most individual Remote Control button functions. Buttons which continuously perform a function as long as pressed (Volume Up/Down, Channel Up/Down, etc.) cannot be programmed. Only those buttons which perform a function when initially pressed (Power On/Off, Mute, Direct Channel Entry, etc.) can be programmed.

Control Operation (cont.)

Helpful Hints:

Press the TV Mode Selection button to operate TV Remote functions, if necessary



TV/Video Button – Press the TV/VIDEO button to select desired input for Main Picture or PIP frame (when the PIP Frame is displayed)



Signal coming from

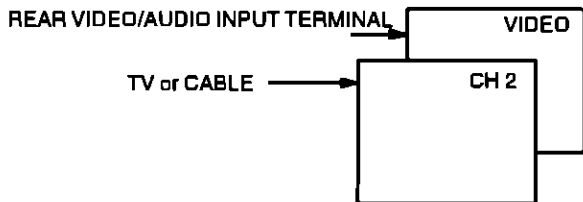

Signal coming from.

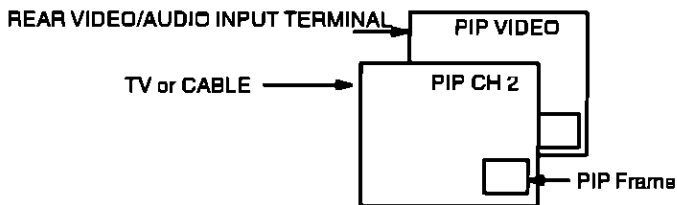

PIP (Picture in Picture) Button – This feature allows monitoring one channel while watching another when a second video source with a tuner is connected (such as a VCR) to the television

NOTE: When the Main Picture is in Video mode with no signal, the PIP will not operate properly

PIP Operation

- 1 Turn VCR ON and select a desired channel
- 2 Press the TV Mode Selection button to operate TV Remote functions, if necessary



- 3 Press the PIP button (television must be ON) The PIP frame will appear at the position it was last displayed. The Main Picture Video Source and PIP Video Source will display on screen momentarily. Audio will be that of Main Picture

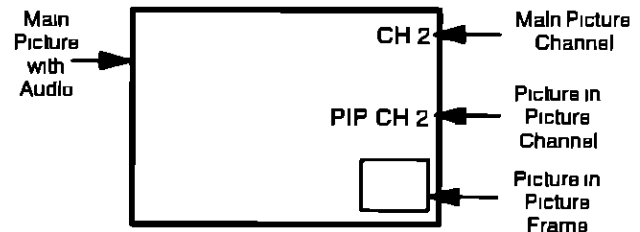

- 4 Press the PIP button again to cancel PICTURE IN PICTURE feature (if desired)



NOTE: For PIP Video source connection, refer to the PIP External Video and Antenna Connections section

Control Operation (cont.)

Helpful Hints:

Press the TV Mode Selection button to operate TV Remote functions, if necessary



Swap Button – Press the SWAP button (when the PIP frame is displayed) to interchange what is being viewed on the Main Picture with that of the PIP frame

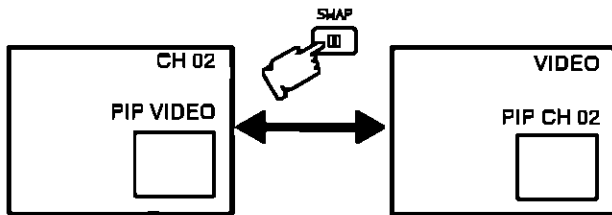

- Audio will be that of the Main Picture



Displays and Exits Menus

Located On Remote Control

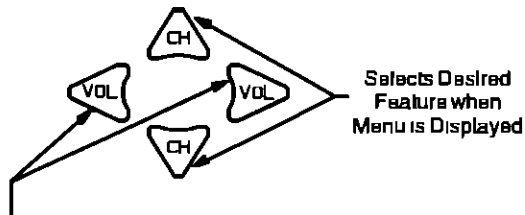

Selects or Adjusts Features when Menu is Displayed

Size Button – Press the SIZE button (when the PIP frame is displayed) to choose either the large or small PIP frame

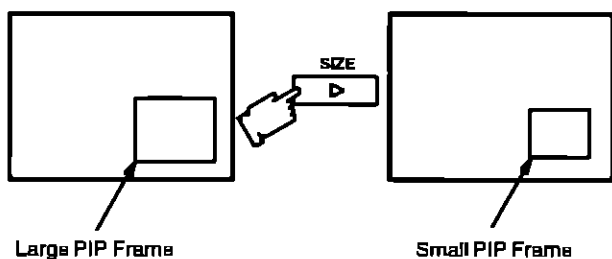

Large PIP Frame

Small PIP Frame

Freeze Button – Press the FREEZE button to stop action in the PIP frame

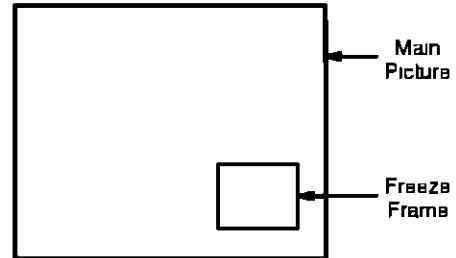

NOTES:

- Pressing the FREEZE button when the PIP frame is not displayed will stop action in the Main Picture and display it on the PIP frame
- Pressing the FREEZE button when PIP frame is displayed will stop action in the PIP frame, press the FREEZE button again to continue action
- Press the PIP button to delete PIP frame

Move Button – The PIP frame may be located at any corner of the Main Picture by pressing the PIP MOVE button (when the PIP frame is displayed)



NOTE: Each time MOVE button is pressed (when the PIP frame is displayed), the PIP frame will move (counterclockwise) as illustrated

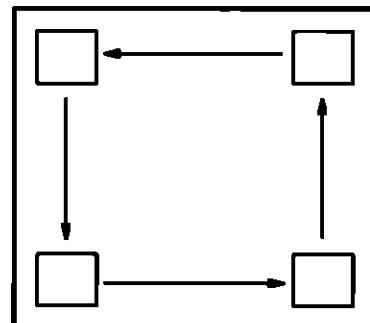

Main Menu (Icons)

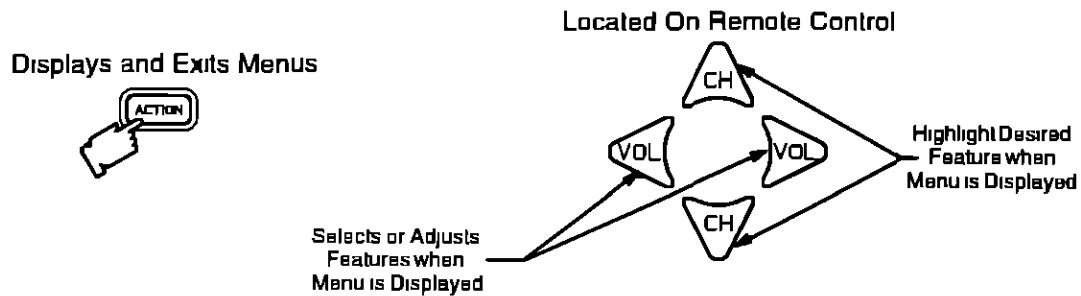
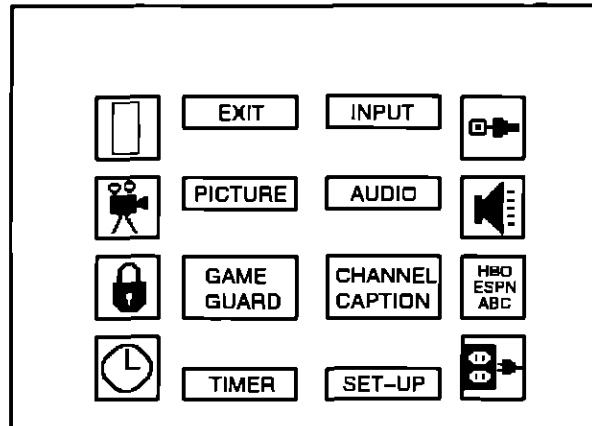

- 1 Press the ACTION button to display the Main Menu with Icons
- 2 Press the or and the or buttons to select the desired Icon when the Main Menu is displayed (selected Icon will be indicated in Red)
- 3 Press the buttons for left and right movement and the buttons for up or down movement
- 4 To exit the Main Menu first select the EXIT Icon, then press the ACTION button

The Language Menu is factory set to ENGLISH. Follow these instructions to change the Language Menu to Spanish and back to English.

- 1 Press the ACTION button to display the Main Menu
- 2 Press the and buttons to select the SET-UP Icon

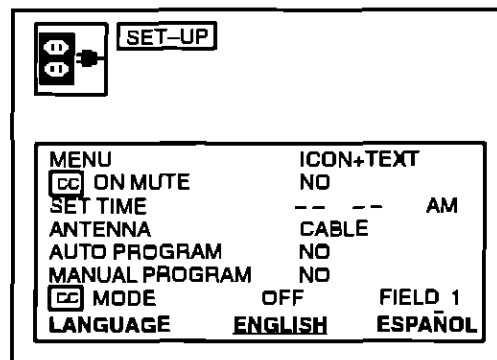

- 3 Press the ACTION button to display the SET-UP Menu
- 4 Press the button to select LANGUAGE
- 5 Press the or button to highlight ENGLISH or ESPAÑOL. The selected mode will be underlined
- 6 Press ACTION button twice to exit menus

Picture Adjustments

- Picture Norm
- Color
- Tint
- Brightness
- Picture
- Sharpness

Displays and Exits Menus



Located On Remote Control

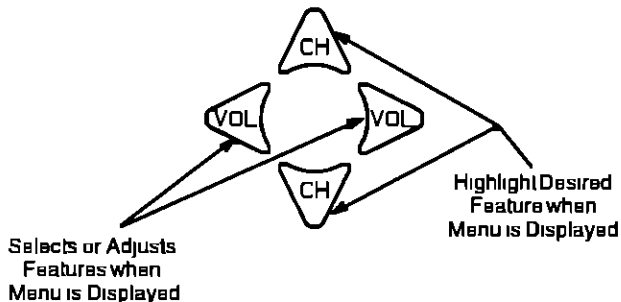

Picture Norm – This feature is used to reset Color, Tint, Brightness, Picture and Sharpness adjustments back to a factory preset level

- 1 Press the ACTION button to display the Main Menu
- 2 Press the button to select the Picture Icon
- 3 Press the ACTION button to display the Picture Adjustment Menu

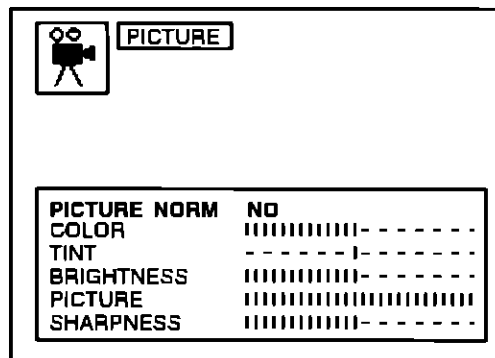

- 4 Press the or button to highlight PICTURE NORM (if necessary)
- 5 Press the or button to select SET to Normalize Color, Tint, Brightness, Picture and Sharpness
- 6 Press ACTION button twice to exit menus

Color, Tint, Brightness, Picture and Sharpness Adjustments

- 1 Press the ACTION button to display the Main Menu
- 2 Press the button to select the Picture Icon
- 3 Press the ACTION button to display the Picture Adjustment Menu

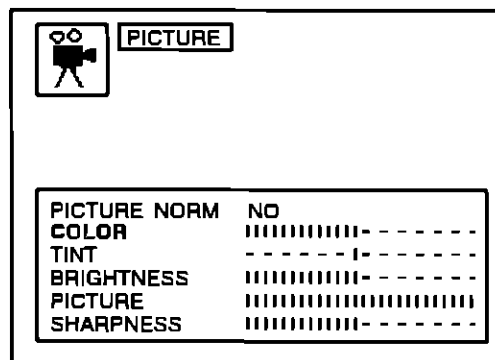

- 4 Press the or button to select the desired Picture Adjustment (Color, Tint, Brightness, Picture or Sharpness)
- 5 Press the or button to adjust your selection (The Selected Picture adjustment will be displayed)
- 6 Repeat steps 4 and 5 for the remaining Picture Adjustments
- 7 Press ACTION button twice to exit menus

Helpful Hints:

Picture Adjustments.

COLOR – adjust for desired color intensity.

TINT – adjust for natural flesh tones

BRIGHTNESS – adjust so dark areas of picture slightly become black for a crisp detail

PICTURE – adjust the white areas of the picture as desired

SHARPNESS – adjust for best clarity of outline detail

Game Guard

Displays and Exits Menus



Located On Remote Control

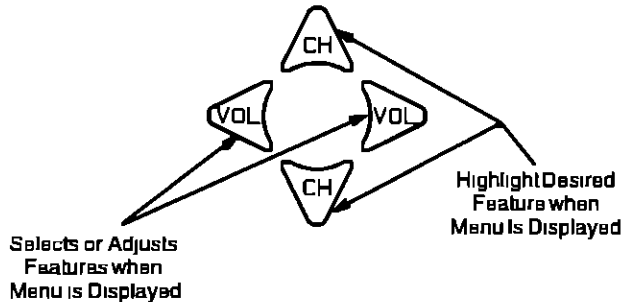

Game Guard (Lockout) – Prevents video games and other video sources from being viewed. Channel 3, 4, and all video inputs are locked out for 12, 24, or 48 hours.

NOTE: Be sure to understand this feature before attempting its use. Use a code that you will easily remember.

- 1 Press the ACTION button to display the Main Menu
- 2 Press the button to select the Game Guard icon
- 3 Press the ACTION button to display the Game Guard Menu

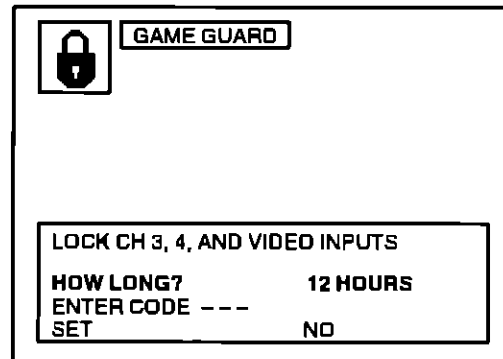

- 4 Press the button to select the desired hours (12, 24, or 48) for Game Guard (Lockout) to be activated
- 5 Press the button to select ENTER CODE. Then enter a 3-digit code with the numeric keypad (0 through 9 buttons).
IMPORTANT NOTE: Use a code you can easily remember.
- 6 Press the or button after entering 3-digit code. "Game Guard Locked" will display On Screen

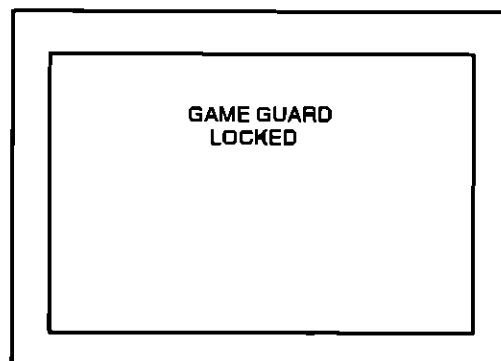

Game Guard Activated

Game Guard (Unlock)

To unlock the Game Guard feature, repeat steps 1 through 3. Enter the same 3-digit code previously used in step 5 with numeric keypad (0 through 9 buttons)

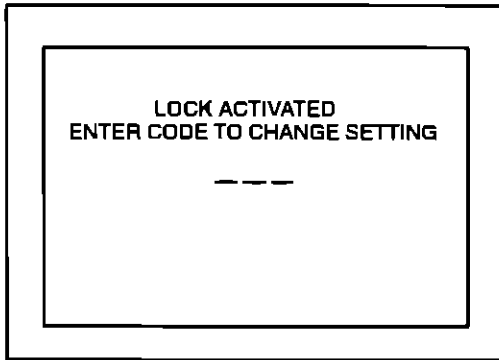

Enter Same 3-Digit Code Previously Used

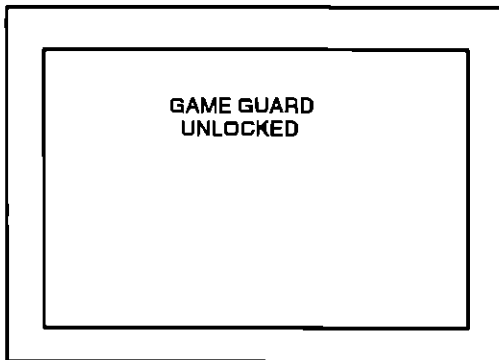

If 3-Digit Code is the Same

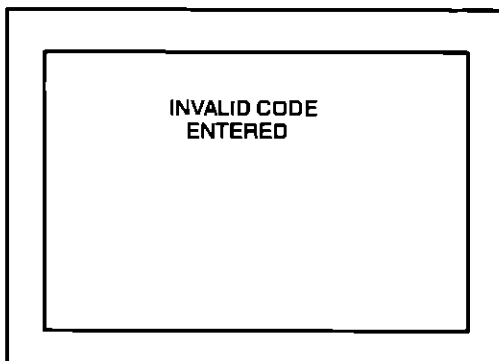

If 3-Digit Code is Not the Same

Timer Features

Displays and Exits Menus



Located On Remote Control

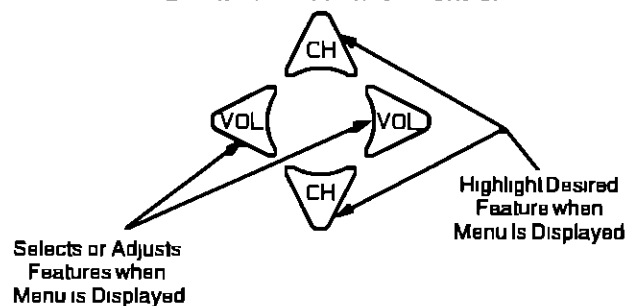

Sleep Timer— This feature is used for automatic turn off in 30, 60, or 90 minutes

NOTE: Display will flash 3, 2, and 1 to indicate the last three remaining minutes prior to turn off. The Recall display will also appear

- 1 Press the ACTION button to display the Main Menu
- 2 Press the  button to select the Timer Icon
- 3 Press the ACTION button to display the Timer Control Menu

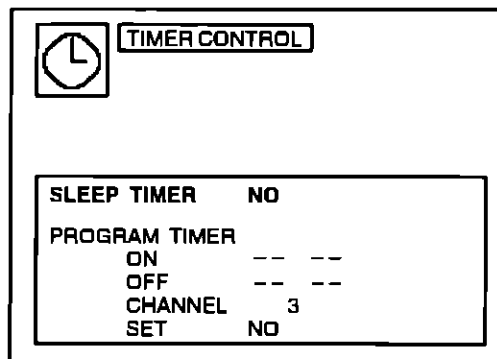

- 4 Press the  button to select NO (OFF), 30, 60, or 90 minutes (Sleep Timer will be activated)
- 5 Press ACTION button twice to exit menus

NOTE: To deactivate Sleep Timer repeat steps 1 through 4. In step 4 select "NO" instead of minutes

Helpful Hints:

Press the RECALL button to display the remaining minutes for Sleep Timer, the time will display in the bottom left corner

Timer Features (cont.)

Special Feature:

Automatic OFF after 90 minutes.

The TV has a special feature that will shut itself **OFF** after 90 minutes when turned **ON** by the program timer unless a function key is pressed during the 90 minutes

This feature is useful so that the TV will not remain **ON** unattended for an extended period of time

Programming the **OFF** timer will also cancel the automatic **OFF** feature

Displays and Exits Menus



Located On Remote Control

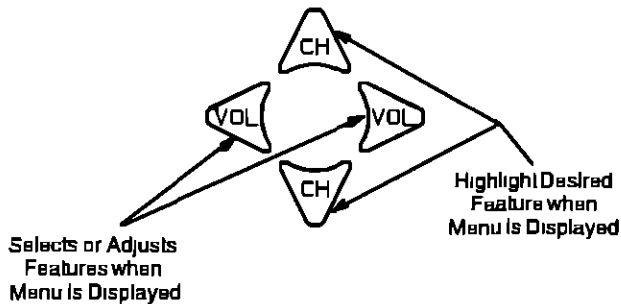

Program Timer — This feature is capable of turning the TV on, tuned to a desired channel and off at a predetermined time (one day or everyday)

NOTE: The clock must be set for this feature to operate (Refer to the Set-Up Menu to set time)

- 1 Press the ACTION button to display the Main Menu
- 2 Press the button to select the Timer Icon
- 3 Press the ACTION button to display the Timer Control Menu

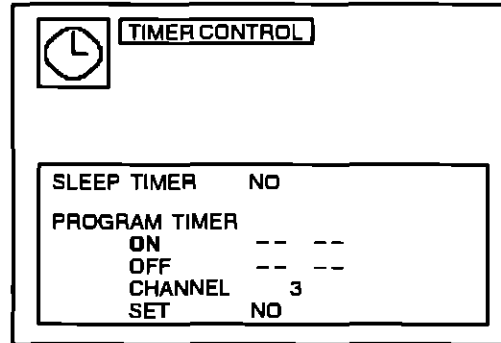

- 4 Press the button to select ON (time)
- 5 Press the or button repeatedly to set hours (set AM/PM accordingly)
- 6 Press the button to select the minutes position
- 7 Press the or button repeatedly to set minutes
- 8 Press the button to select OFF (time)
- 9 Repeat steps 5 through 7 for setting OFF (time)
- 10 Press the button to select CHANNEL
- 11 Press the or button or use the Remote Control Keyboard to enter the channel number desired when the set turns ON
- 12 Press the button to select SET
13. Press the button to select
 - NO – not activated
 - ONE DAY – activated
 - EVERY DAY – activated

NOTE: To deactivate Program Timer select NO in step 13

- 14 Press ACTION button twice to exit menus

Helpful Hints:

- If you see "GAME GUARD" in the upper right hand corner, the channel or Video Input you have selected has been locked out.
- If the Program Timer "ON" functions while the set is operating, the set will automatically tune to the channel designated in the Timer Program.

Set-Up Features

- Menu
- CC (Closed Caption) on Mute
- Set Time
- Antenna (TV or Cable)
- Auto Program
- Manual Program
- CC (Closed Caption) Mode
- Language (English or Spanish)

Displays and Exits Menus



Located On Remote Control

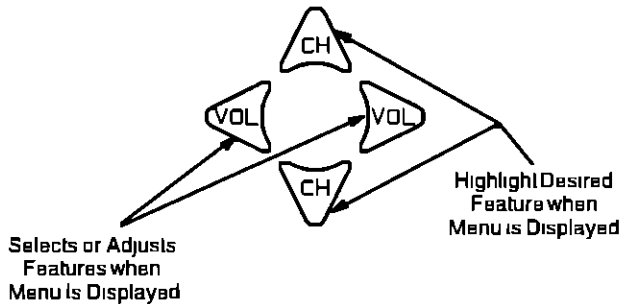

Menu – The Main Menu can be displayed in two formats: Icon with Text or Icon without Text for those familiar with the Icon system.

- 1 Press the ACTION button to display the Main Menu
- 2 Press the and buttons to select the Set-Up Icon
- 3 Press the ACTION button to display the Set-Up Menu

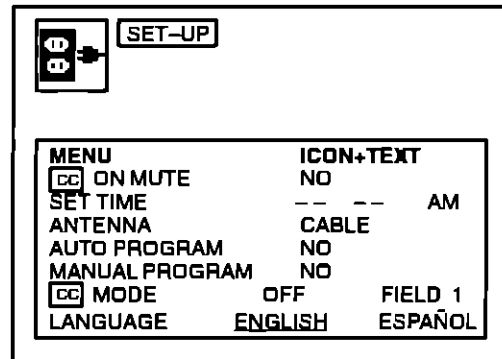

- 4 Press the or button to select ICON with TEXT or ICON only
- 5 Press ACTION button twice to exit menus

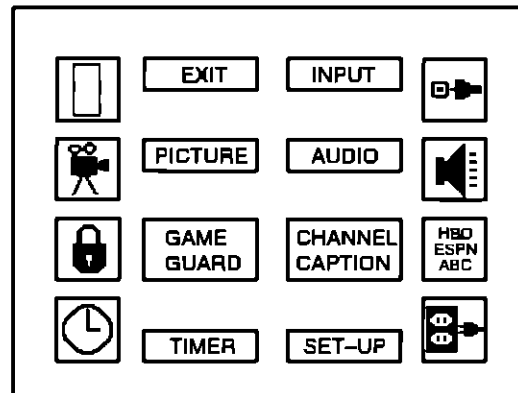

Icon with Text

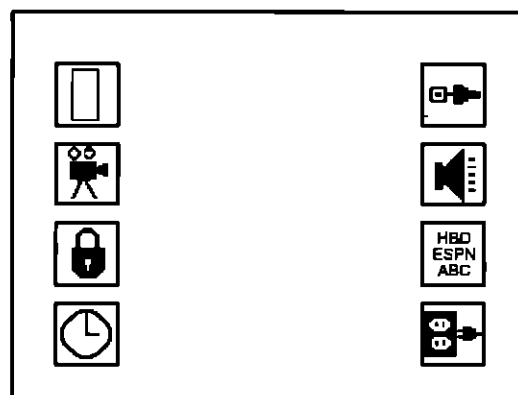

Icon (Only)

Set-Up Features (cont.)

Displays and Exits Menus



Located On Remote Control

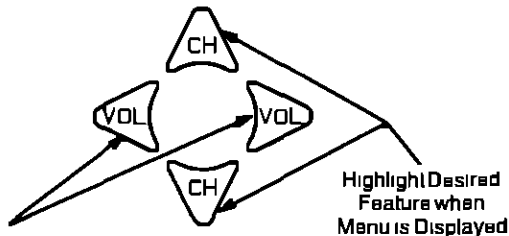

Selects or Adjusts Features when Menu is Displayed

Highlight Desired Feature when Menu is Displayed

CC On Mute – Activates the On-Screen Closed Captioning when the MUTE button on the Remote Control is pressed. To deactivate, press the MUTE button again.

NOTE: This feature only functions when the Close Caption Mode is in the "OFF" position. The program being viewed must be broadcast with Closed Caption. (Refer to your local TV guide.)

- 1 Press the ACTION button to display the Main Menu
- 2 Press the and buttons to select the Set-Up Icon
- 3 Press the ACTION button to display the Set-Up Menu

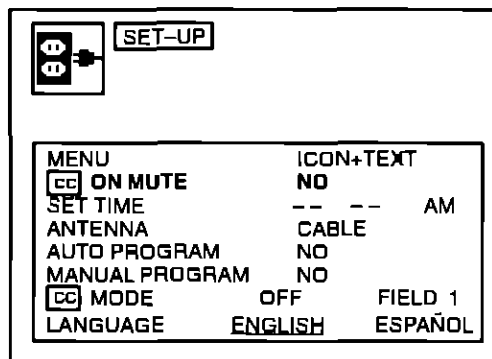

- 4 Press the button to select CC ON MUTE
- 5 Press the button to select NO (OFF), CAP C1 or CAP C2

Recommended Set Up:

- 1 Place CC ON MUTE into the CAP C1 Mode
- 2 Press the button to select CC MODE
- 3 Press the button to select OFF
- 4 Press the button to select the Field position
- 5 Press the or button to select FIELD 1

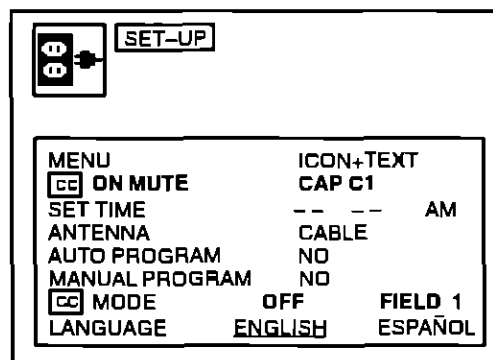

- 6 Press ACTION button twice to exit menus
- 7 Press the MUTE button when the program being viewed is broadcast with Closed Caption to activate. Press again to deactivate.

Set-Up Features (cont.)

Displays and Exits Menus



Located On Remote Control

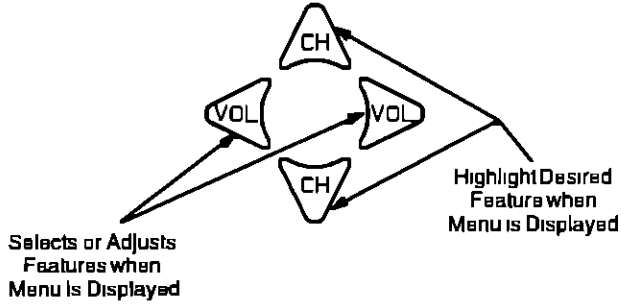

Set Time – Clock (when set) will display on screen at initial “Turn On”, after a channel change and when pressing the RECALL button. The time must be set first in order to operate the Program ON/OFF Timer.

- 1 Press the ACTION button to display the Main Menu
- 2 Press the and buttons to select the Set-Up Icon
- 3 Press the ACTION button to display the Set-Up Menu

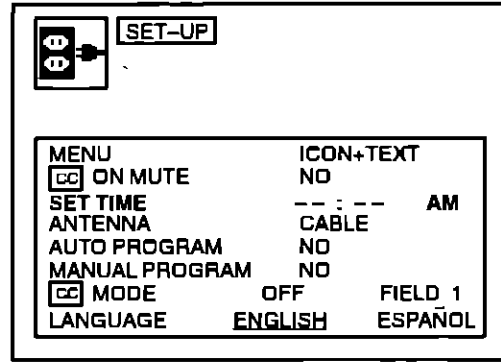

- 4 Press the button to select SET TIME
- 5 Press the or button to set hours (set AM/PM accordingly)
- 6 Press the button to select minutes position
- 7 Press the or button repeatedly to set minutes
- 8 Press ACTION button twice to exit menus

Set-Up Features (cont.)

Displays and Exits Menus



Located On Remote Control

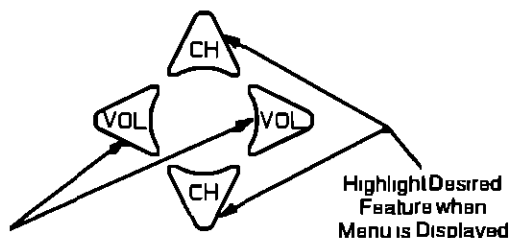

Selects or Adjusts Features when Menu is Displayed

Highlight Desired Feature when Menu is Displayed

Antenna— The proper input mode must be selected for the type of signal at the antenna input

- TV mode is used when the Receiver is not connected to a cable TV system, for example when using a VHF/UHF antenna (channels 02 – 69)
 - Cable mode is used when the Receiver is connected to a Cable TV system and you are not using a cable company converter box (channels 01 – 125)
- 1 Press the ACTION button to display the Main Menu
 - 2 Press the and buttons to select the Set-Up Icon
 - 3 Press the ACTION button to display the Set-Up Menu

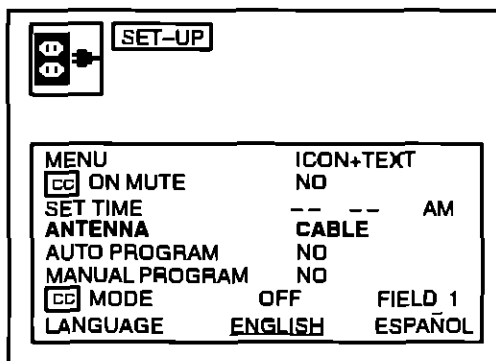

- 4 Press the button to select ANTENNA
- 5 Press the or button to select TV or CABLE
- 6 Press ACTION button twice to exit menus

Set-Up Features (cont.)



Displays and Exits Menus



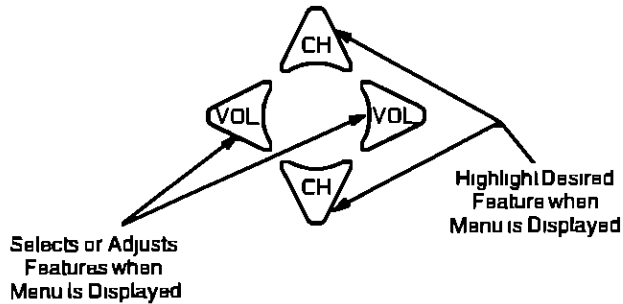



Located On Remote Control

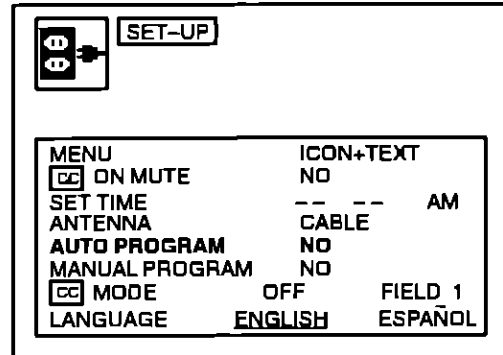

Auto Program – This feature allows you to place all channels with a video signal into Channel Scan Memory

- 1 Press the ACTION button to display the Main Menu
- 2 Press the  and  buttons to select the Set-Up Icon
- 3 Press the ACTION button to display the Set-Up Menu



- 4 Press the  button to select AUTO PROGRAM
- 5 Press the  or  button to start Auto Programming Channels will automatically advance until all channels have been scanned
- 6 Press ACTION button twice (after completion of Auto Programming) to exit menus

NOTE: Channel numbers with signal present will turn blue, which indicates stored in Channel Scan Memory

Set-Up Features (cont.)

Displays and Exits Menus



Located On Remote Control

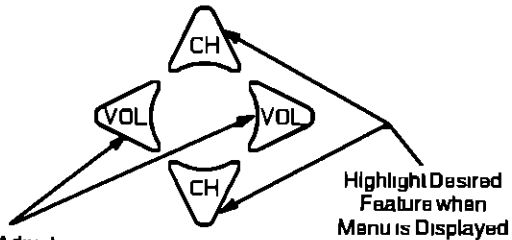

Selects or Adjusts Features when Menu is Displayed

Manual Program – This feature allows you to select which channels are placed into Channel Scan Memory

- 1 Press the ACTION button to display the Main Menu
- 2 Press the and buttons to select the Set-Up Icon
- 3 Press the ACTION button to display the Set-Up Menu

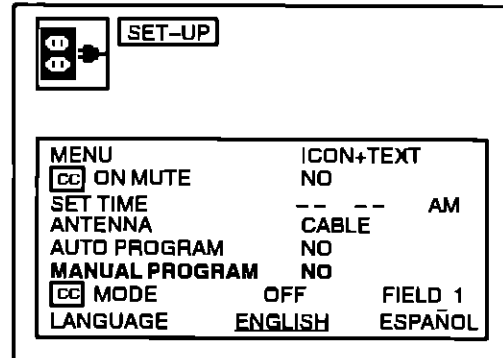

- 4 Press the button to select MANUAL PROGRAM
- 5 Press the or button to display the Manual Program Menu

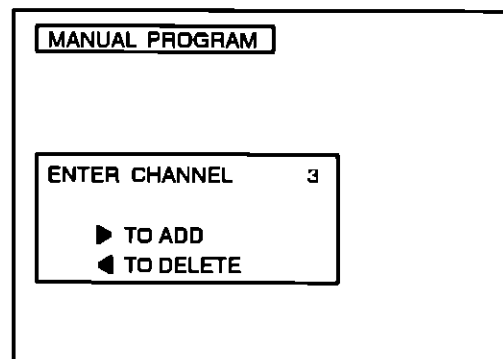

- 6 Use the or button or the numeric keypad (0 through 9 buttons) to select channels
- 7 Press the button to add channel(s) to memory (Blue) Press the button to delete channels from memory (Yellow)
- 8 Repeat steps 6 and 7 to continue adding or deleting channels
- 9 Press ACTION button twice to exit menus

Set-Up Features (cont.)

Displays and Exits Menus



Located On Remote Control

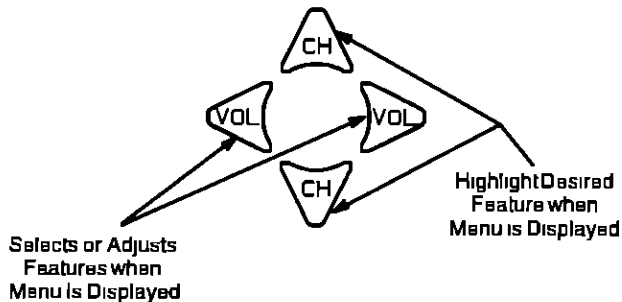

CC Mode – This Receiver has a built in decoder that provides a visual depiction of the audio portion of a television program in the form of written words across the screen (white or colored letters on a black background) It allows the viewer to read the dialogue of a television program or other information

- 1 Press the ACTION button to display the Main Menu
- 2 Press the and buttons to select the Set-Up Icon
- 3 Press the ACTION button to display the Set-Up Menu

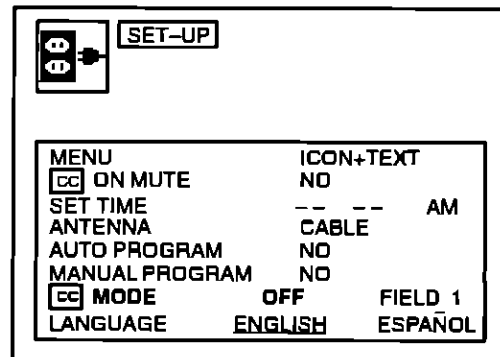

- 4 Press the button to select CC MODE
- 5 Press the button to select OFF, CAP C1, TEXT C1, CAP C2, or TEXT C2
 - CAPTION OFF – Recommended mode when you do not wish to view Closed Caption.
 - CAPTION C1 – For video related information that can be displayed (up to four (4) lines of script strategically placed on the television screen so that it does not obstruct relevant parts of the picture) Script can be in any language
 - TEXT C1 – Blanks out a large portion of the picture on the television screen, and displays program guide or any other information currently being transmitted
 - CAPTION C2 – Another mode used for video related information that can be displayed (up to four (4) lines of script strategically placed on the television screen so that it does not obstruct relevant parts of the picture)
 - TEXT C2 – Another mode which displays information and blanks out a large portion of the picture on the television screen
- 6 Press the button to select the Field position
- 7 Press the or button to select FIELD 1 or FIELD 2
- 8 Press ACTION button twice to exit menus

Helpful Hints:

- Closed Caption information may be transmitted on either or both Caption Fields
- Most Closed Caption information is transmitted on Field 1 in Cap C1 Mode
- De-select Text mode if large portion of the picture is blanked out.

Set-Up Features (cont.)

Displays and Exits Menus



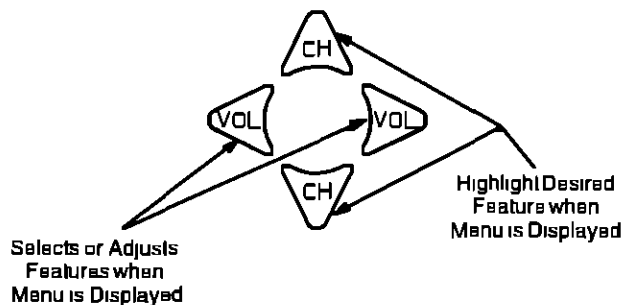

Located On Remote Control





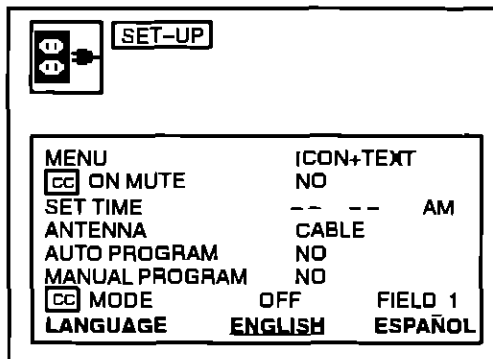

Language (English or Spanish)

The Language Menu is factory set to ENGLISH. Follow these instructions to change the Language Menu to Spanish and back to English.

- 1 Press the ACTION button to display the Main Menu
- 2 Press the  and  buttons to select the Set-Up Icon
- 3 Press the ACTION button to display the Set-Up Menu



- 4 Press the  or  button to select LANGUAGE
- 5 Press the  or  button to underline ENGLISH or ESPAÑOL
- 6 Press ACTION button twice to exit menus

Helpful Hints:

Language Menu does not affect Closed Caption or other transmitted text information

Channel Caption

Displays and Exits Menus



Located On Remote Control

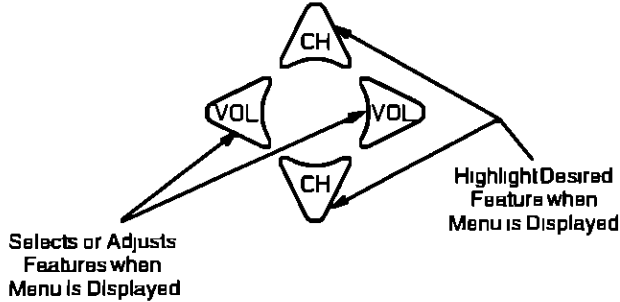

Channel Caption (Station Identifier)

This feature allows you to enter the call names of up to 30 stations into memory (using up to four (4) characters for each station). The call name will then display along with the channel number when changing channels or pressing RECALL.

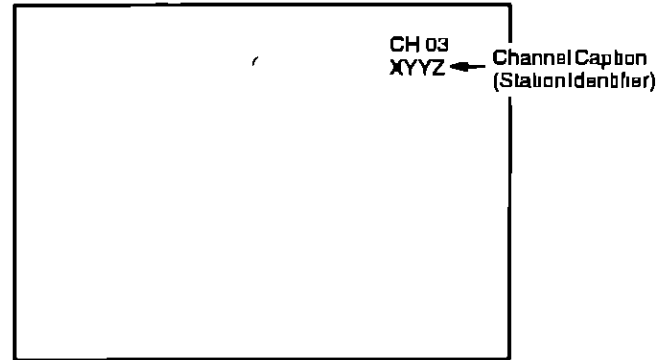

1. Press the ACTION button to display the Main Menu
2. Press the and buttons to select the Channel Caption Icon
3. Press the ACTION button to display the Channel Caption Menu

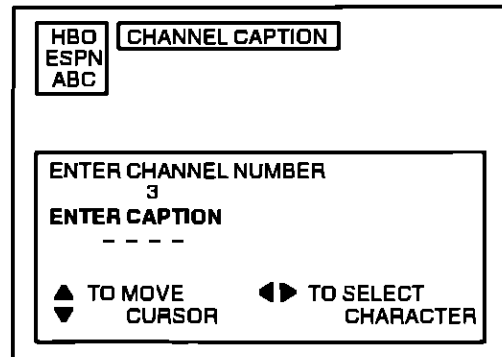

4. Press the or button, or use the numeric keypad (0 through 9 buttons), to enter channel number you wish to assign a Station Identifier
5. Press the button to select ENTER CAPTION
6. Press the or button to select first character in Station Identifier. Then press the button to move cursor to the second position and repeat until the complete Station Identifier is entered (up to four (4) characters)
7. Press the or button to select ENTER CHANNEL NUMBER. Then repeat steps 4 through 6 to continue adding Channel Station Identifier(s)
8. Press ACTION button twice to exit menus

NOTE: To delete a Channel Caption (Station Identifier) from memory all four character positions must display dash mark (-)

Helpful Hints:

When the maximum number of station identifiers are entered, "FULL" will be displayed in the characters position

Audio Adjustment

Displays and Exits Menu



Located On Remote Control

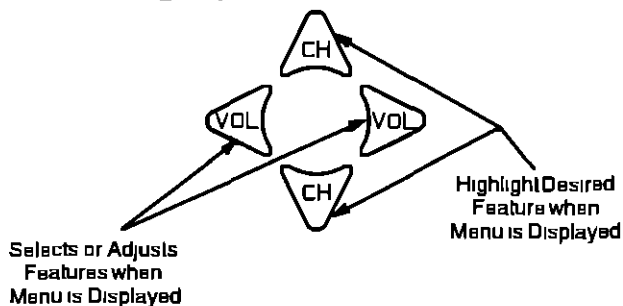

Mode (Stereo/SAP/Mono)

When Audio is broadcast in Stereo or SAP an ON Screen display will appear on initial "Turn On" and "Channel Change" The available choices will be indicated in red

- 1 Press the ACTION button to display the Main Menu
- 2 Press the and buttons to select the Audio Icon
- 3 Press the ACTION button to display the Audio Adjustment Menu

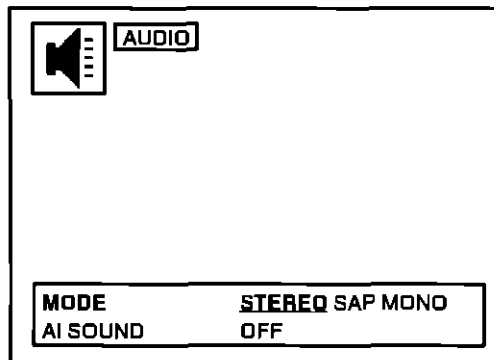

- 4 Press the or button to select MODE (if necessary)
- 5 Press the or button to select
 - STEREO – Two channel Audio reception
 - SAP – Second Audio Programming (Typically used for bilingual audio)
 - MONO – Use when stereo signal is weak

NOTE: The selected mode will be underlined

- 6 Press ACTION button twice to exit menus

AI Sound – This feature regulates the volume between programs and commercial audio to maintain a constant sound output level

- 1 Press the ACTION button to display the Main Menu
- 2 Press the and buttons to select the Audio Icon
- 3 Press the ACTION button to display the Audio Adjustment Menu

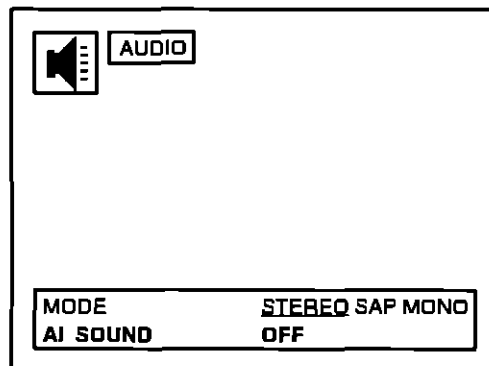

- 4 Press the or button to highlight AI SOUND
- 5 Press the or button to select ON or OFF
- 6 Press ACTION button twice to exit menus

Input Select

Displays and Exits Menus



Located On Remote Control

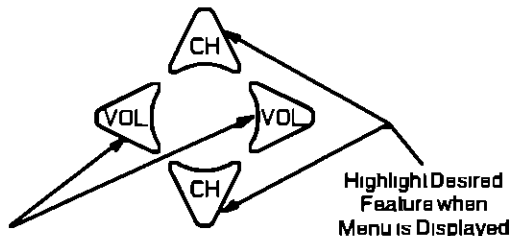

Selects or Adjusts Features when Menu is Displayed

Highlight Desired Feature when Menu is Displayed

Main (Picture) Input Selection

This feature is used to select TV Mode Operation or Video Input for the Main Picture (Used with optional accessory Video equipment)

- 1 Press the ACTION button to display the Main Menu
- 2 Press the button to select the Input Icon
- 3 Press the ACTION button to display the Input Select Menu

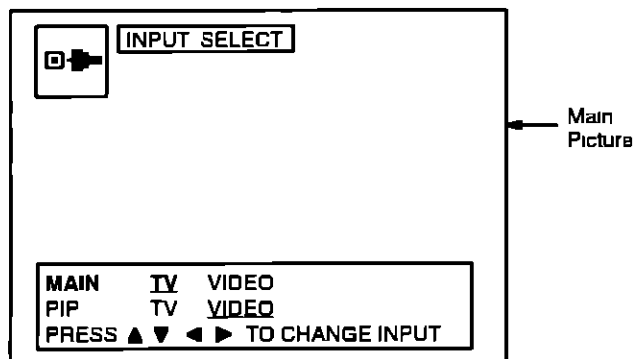

- 4 Press the or button to select MAIN
- 5 Press the or button to select TV or Video Mode for Main Picture. The selected mode will be underlined.
- 6 Press ACTION button twice to exit menus

PIP Input Selection

This feature is used to select TV Mode Operation or Video Input for the PIP (Picture in Picture) frame (Used with optional accessory Video equipment)

- 1 Press the ACTION button to display the Main Menu
- 2 Press the button to select the Input Icon
- 3 Press the ACTION button to display the Input Select Menu

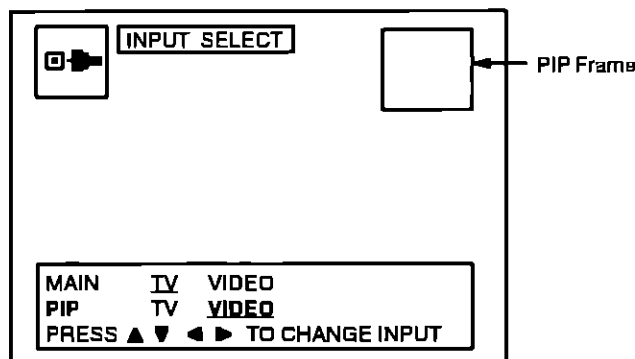

- 4 Press the or button to select PIP (the PIP frame will appear in the top right corner)
- 5 Press the or button to select TV or Video Mode for the PIP frame. The selected mode will be underlined.
- 6 Press ACTION button twice to exit menus

NOTE: The PIP frame will remain on screen (if desired) To delete PIP frame, press the PIP button

Helpful Hints:

The Game Guard feature must be deactivated before selecting Video Input for Main picture or PIP frame.

Programming the Illuminated Remote Control Using Access Codes

The remote control can be preset for other manufacturers, by utilizing the **MODE SELECTION BUTTONS** for **CABLE**, **DSS**, **VCR**, **RCVR** (a Receiver or Amplifier), **CD**, **LD**, and **AUX** (for **Cassette Players** or a **DVD**)

Procedure – Code Known

Procedure for setting up the remote using the numerical buttons.

- Determine brand of device
- Identify code(s) associated with the brand in the infrared code index (located in this manual on pages 34 thru 37) Record all possible codes
- Confirm the device is plugged in and operating properly

1 Press and hold the **ACTIV** button, then the **MODE** button so that both are pressed at the same time for at least 5 seconds. All of the Mode buttons will flash.

2 Press the desired Mode button That Mode button will illuminate steadily. All other buttons will go out.

3 Enter the 3-digit code, by using the numeric keypad (0 through 9 buttons).

- If you entered a valid code, the mode key will blink twice then go out

Now your remote is set for this code.

4 Press **MODE** to test your device.

NOTE: Some brands have multiple codes. Repeat the procedure using each listed code until the device responds correctly.

- If you enter an unlisted code, or if you do not complete your entry within 30 seconds, the mode key illumination will go out and the settings will not change

Code From Index Sheet

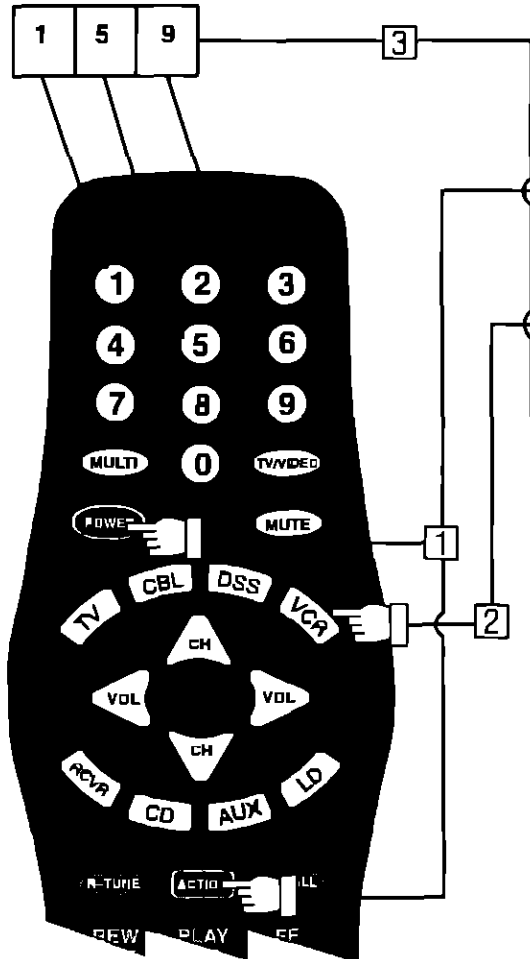

Infrared Remote Codes for Specific Components

Helpful Hint: Write down the code numbers for your components in the space provided below. This will serve as a handy reference whenever you need to reprogram your remote control.

CABLE Cable TV Converter Box	VCR Video Cassette Recorder	CD Compact Disc Player
DSS Digital Satellite System	RCVR Receiver or Amplifier	LD Laser Disc Player
_____ Other Component	_____ Other Component	_____ Other Component
_____ Other Component	_____ Other Component	_____ Other Component

VCR Infrared Codes Index

The Universal Infrared Remote Control is capable of operating many brands of VCRs Refer to page 33 for programming procedures

NOTE: The Universal Remote Control memory is limited, therefore, some models of VCRs may not operate The Universal Remote Control is not designed to control all features that are available in all models

NOTE: After entering the proper infrared code, press the Remote VCR Selection Mode button (*) To operate the Remote VCR function buttons, refer to pages 10 and 11 for Remote Control Key Functions

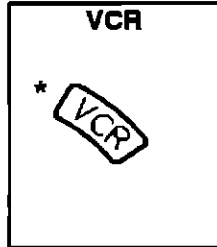

Code Index For VCRs

VCR Brand	Code(s)	VCR Brand	Code(s)
Adventura	000	MTC	000, 240
Aiko	278	Multitech	000, 072
Aiwa	000	NEC	038, 041, 067
Akai	041, 061	Nikko	037
American High	035	Noblex	240
Asha	240	Olympus	035
Audiovox	037	Optimus	037, 048, 104
Beaumarck	240	Panasonic	035, 162, 225, 454
Bell & Howell	104	Penney	035, 037, 038, 042
Broksonic	121, 184		240
Calix	037	Pentax	042
Canon	035	Philco	035
Carver	081	Philips	035, 081
CCE	072, 278	Pilot	037
Citizen	037, 278	Pioneer	067
Coll	072	Protec	072
Craig	037, 047, 072, 240	Pulsar	039
Curtis Mathes	035, 041, 060	Quarter	046
Cybemex	240	Quartz	046
Daewoo	045, 278	Quasar	035
Dynatech	000	Radio Shack	000, 037
Electrohome	037	Radix	037
Electrophonic	037	Randex	037
Emerex	032	RCA	042, 060
Emerson	000, 002, 037, 043, 061, 121, 184, 278	Realistic	000, 035, 037, 046
Fisher	047, 104		047, 048, 104, 240
Fuji	033, 035	Ricoh	034
Funai	000	Runco	039
Garrard	000	Samsung	045, 240
GE	035, 060	Sanky	039, 048
Goldstar	037, 038	Sansul	041, 067
Gradiente	000	Sanyo	046, 047, 104, 240
Harley Davidson	000	Scott	043, 045, 121, 184
Harman/Kardon	038	Sears	035, 037, 042, 046, 047, 104
Harwood	072	Sharp	048
Headquarter	046	Shinlom	072
HI-Q	047	Shogun	240
Hitachi	041, 042	Singer	072
Jensen	041	Sony	032, 033, 034, 035
JVC	041, 067	STS	042
Kenwood	038, 041, 067	Sylvania	000, 035, 043, 081
KLH	072	Symphonic	000
Kodak	035, 037	Tatung	041
Lloyd	000	Teac	000, 041
Logik	072	Technics	035, 162
LXI	037	Teknika	000, 035, 037
Magnavox	035, 039, 081	TMK	240
Magnin	240	Toshiba	043, 045
Marantz	035, 081	Television	037, 240
Marta	037	Unitach	240
Matsushita	035	Vector	045
MEI	035	Vector Research	038
Memorex	000, 035, 037, 039, 046, 047, 048, 104	Video Concepts	045, 061
	240	Videasonic	240
MGA	043, 061	Wards	000, 035, 042, 047, 048, 072, 240
MGN Technology	240	XR-1000	000, 035, 072
Minolta	042	Yamaha	038
Mitsubishi	043, 061, 067	Zenith	033, 034, 039
Motorola	035, 048		

CABLE CONVERTER BOX AND CD PLAYERS

Infrared Codes Index

The Universal Infrared Remote Control is capable of operating many brands of Cable Converter Boxes, and CD Players. Refer to page 33 for programming procedures.

NOTE: The Universal Remote Control memory is limited; therefore, some models of Cable Converter Boxes and CD Players may not operate. The Universal Remote Control is not designed to control all features that are available in all models.

NOTE: After entering the proper infrared code, press the Remote **CBL** Selection Mode button (☆). To operate the Remote Cable function buttons, refer to pages 10 and 11 for Remote Control Key Functions.

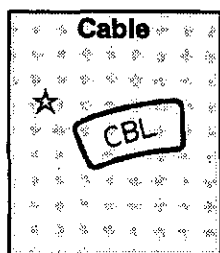

Codes For Cable Converter Box			
Brand of Cable-TV Box	Code(s)	Brand of Cable-TV Box	Code(s)
ABC	003, 007, 008, 011, 013, 014, 017	Pioneer	144, 533
Archer	153	Pulsar	000
Century	153	RCA	021
Citizen	153	Regal	020, 259
Contec	019	Rembrandt	011
Dae Ryung	008	Runco	000
Garrard	153	Samsung	144
Gemini	015	Scientific Atlanta	008, 017, 477
General Instrument	011, 476	Signal	015
Goldstar	144	Signature	011
Hamlin	009, 020, 259	Sprucer	021
Hitachi	011	Starcom	003, 015
Hytex	007	Stargate	015
Jasco	153	Starquest	015
Jerrold	003, 011, 012, 014, 015, 476	Tocom	012, 013
Memorex	000	Toshiba	000
Oak	007, 019	Tusa	015
Panasonic	000, 021, 107	Unika	153
Paragon	000	United Artists	007
Philips	153	United Cable	003
		Universal	153
		Zenith	000, 525

NOTE: After entering the proper infrared code press the Remote **CD** Selection Mode button (☆☆). To operate the Remote CD Player function buttons, refer to pages 10 and 11 for Remote Control Key Functions.

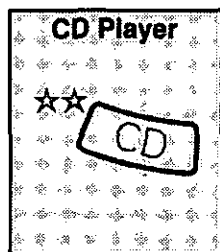

Codes For CD Players			
Brand of CD Players	Code(s)	Brand of CD Players	Code(s)
Aiwa	124, 157	Onkyo	101
CA Audio Lab	029	Optimus	000, 032, 037, 305, 426, 468
Carver	157	Panasonic	029, 367
Denon	003	Philips	157
DKK	000	Pioneer	032, 468
Emerson	305	Proton	157
Fisher	048	QED	157
Genexxa	032, 305	Quasar	029
Harman-Kardon	426	RCA	305
Hitachi	032	Rotel	157
JVC	072	SAE	157
Kenwood	028, 037, 048, 190	Sansui	157, 305
Krell	157	Scott	305
LXI	305	Sears	305
Magnavox	157	Sharp	037
Marantz	029, 157	Sherwood	426
MCS	029	Sony	000
Mission	157	Technics	029, 303
Nakamichi	147	Victor	072
NSM	157		

CASSETTE PLAYERS, RECEIVERS, and AMPLIFIERS

Infrared Codes Index

The Universal Infrared Remote Control is capable of operating many brands of Cassette Players, Receivers, or Amplifiers. Refer to page 33 for programming procedures.

NOTE: The Universal Remote Control memory is limited; therefore, some models of Cassette Players, Receivers, and Amplifiers may not operate. The Universal Remote Control is not designed to control all features that are available in all models.

NOTE: After entering the proper infrared code, press the Remote **AUX** Selection Mode button (*). To operate the Remote Cassette Player function buttons, refer to pages 10 and 11 for Remote Control Key Functions.

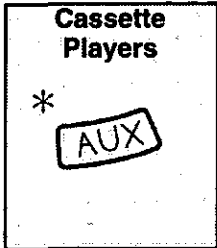

Code Index For Cassette Players			
Brand of Cassette Players	Code(s)	Brand of Cassette Players	Code(s)
Aiwa	029	Panasonic	272
Carver	029	Philips	029
Denon	076	Pioneer	027, 220
Kenwood	070	Sansui	029
Magnavox	029	Sherwood	337, 338
Marantz	029	Sony	170, 243
Nakamichi	147	Technics	229
Optimus	027, 220, 337, 338	Wards	027
		Yamaha	094, 097

NOTE: After entering the proper infrared code, press the Remote **RCVR** Selection Mode button (**). To operate the Remote Receiver or Amplifier function buttons, refer to pages 10 and 11 for Remote Control Key Functions.



Code Index For Receivers And Amplifiers			
Brand of Receiver / Amplifier	Code(s)	Brand of Receiver / Amplifier	Code(s)
ADC	531	Panasonic	039
Aiwa	121, 158, 189	Penney	195
Carver	008, 042, 189, 269	Philips	189, 269
Casio	195	Pioneer	013, 014, 080, 300, 531
Clarinette	195	Quasar	039
Denon	004	RCA	531
Fisher	042, 219	Realistic	195
JVC	074	Sansui	189, 321
Kenwood	027, 186	Sanyo	219
Lloyd's	195	Sharp	186
Magnavox	189, 195, 269, 531	Sherwood	502
Marantz	039, 189, 269, 321	Sony	158
MCS	039	Technics	039, 208, 308, 309, 518
Modulaire	195	Victor	074
NAD	320	Wards	013, 014, 042, 080, 158, 189
Nakamichi	321, 347	Yamaha	176, 186, 354
Onkyo	135	Yorx	195
Optimus	013, 080, 186, 219, 300, 531		

LASER DISC, DSS (Digital Satellite System), and DVD (Digital Videodisc) Infrared Codes Index

The Universal Infrared Remote Control is capable of operating selected brands of Laser Disc, DSS Digital Satellite System, and DVD (Digital Videodisc) Refer to page 33 for programming procedures

NOTE: The Universal Remote Control memory is limited, therefore, some models of Laser Disc, DSS Digital Satellite System, and DVD (Digital Videodisc) may not operate The Universal Remote Control is not designed to control all features that are available in all models

NOTE: After entering the proper infrared code, press the Remote LD Selection Mode button (○) To operate the Remote Laser Disc function buttons, refer to pages 10 and 11 for Remote Control Key Functions

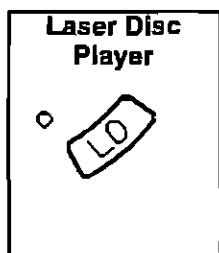

Codes For Laser Disc	
Brand of Laser Disc	Code(s)
Mitsubishi	059
NAD	059
Panasonic	204
Pioneer	059
Quasar	204
Sony	201

NOTE: After entering the proper infrared code, press the Remote DSS Selection Mode button (◇◇) To operate the Remote Satellite function buttons, refer to pages 10 and 11 for Remote Control Key Functions

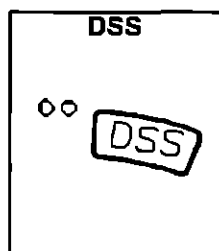

Codes For DSS (Digital Satellite System)	
Brand of Satellite	Code(s)
Panasonic	701
RCA	566
Sony	639

NOTE: After entering the proper infrared code, press the Remote AUX Selection Mode button (★) To operate the Remote DVD (Digital Videodisc) function buttons, refer to pages 10 and 11 for Remote Control Key Functions

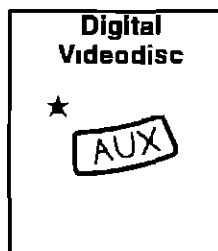

Codes For DVD (Digital Videodisc)	
Brand of DVD	Code(s)
Panasonic	490

Optional Equipment Connection and Operation

To Audio AMP Connection (Stereo)

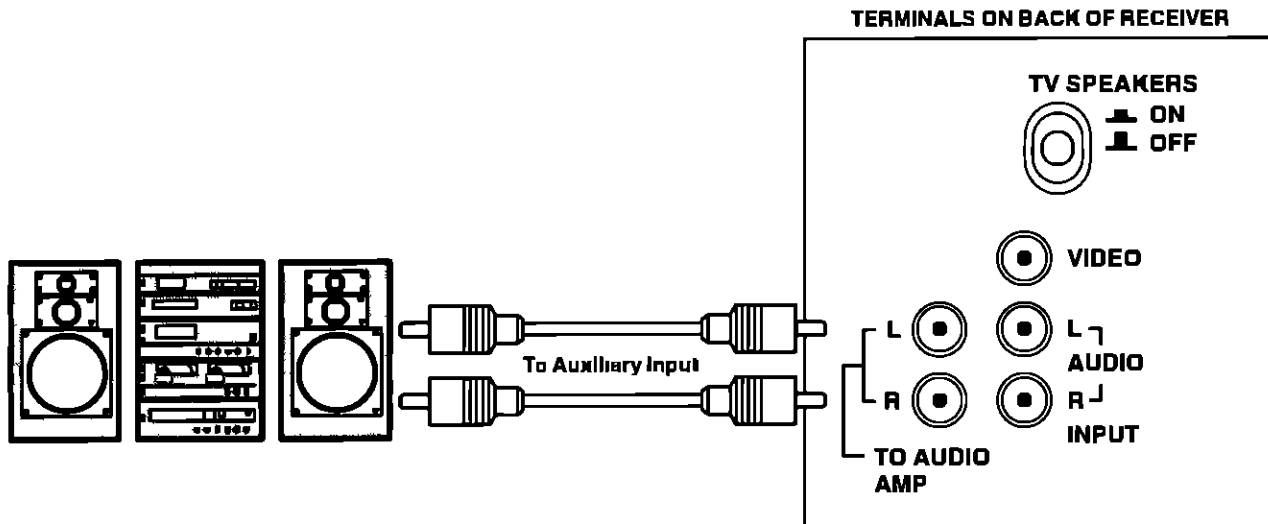

To Audio AMP

Connect to an external audio amp auxiliary input for monitoring sound through a stereo system

NOTE: "TO AUDIO AMP" terminals cannot be used for external speakers

Adjustment – When an audio amp is connected to "TO AUDIO AMP" terminals as shown

- 1 Press the TV SPEAKERS button (located on back of Receiver) to turn INT SPEAKERS "ON" ()
- 2 Set volume of audio amp to near minimum
- 3 Adjust volume of TV to desired listening level
- 4 Adjust volume of audio amp to match the level of TV.
- 5 Press the TV SPEAKERS button (located on back of Receiver) to turn INT SPEAKERS "OFF" ()
- 6 Volume and mute can now be controlled by the TV Remote Control

Video/Audio Connection

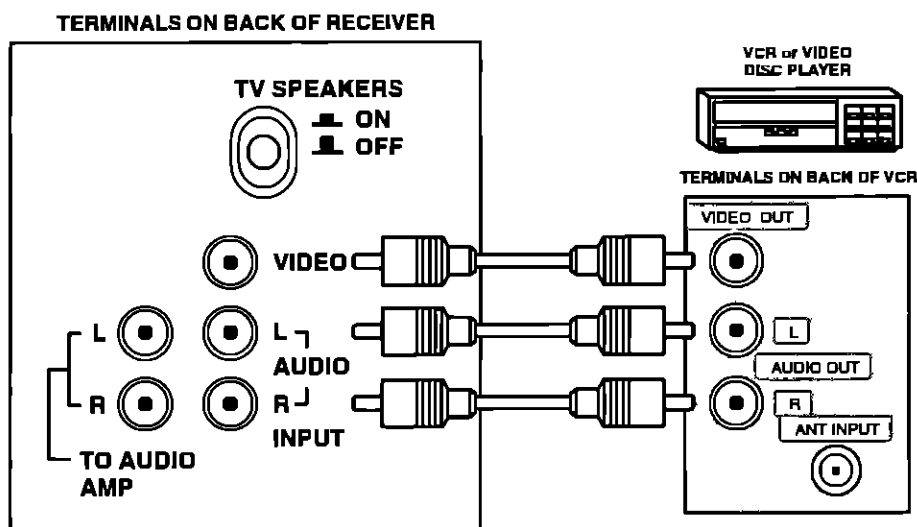

Operation

1. Connect optional equipment as shown to INPUT
2. Select the Video mode by pressing the TV/VIDEO button (or refer to the Input Selection Menu)
3. Operate optional equipment (VCR-VDP) as instructed in Optional Equipment manual.

Care and Cleaning

Picture Tube (Turn set off)

Use a mild soap solution or window cleaner and a clean cloth DO NOT USE ABRASIVE CLEANERS Avoid excessive moisture and always wipe dry

Plastic Cabinets

Wipe the cabinet with a soft cloth dampened with water or a mild detergent solution and wipe dry with a soft clean cloth Avoid excessive moisture Do not use benzene, thinners or other petroleum based cleaners

Wood Cabinets

When dusting or polishing the cabinet, use a clean soft cloth and stroke straight with the grain An occasional coat of furniture polish will help preserve the finish Do not use benzene, thinners or other petroleum based cleaners Do not place objects made of plastic or rubber directly on top of the cabinet A chemical reaction could result causing permanent marring of the finish

Remote Control Transmitter

Do not use benzene, thinners or other petroleum based cleaners to clean the Remote Control Transmitter To clean, wipe with a soft cloth slightly moistened with a mild detergent and then wipe dry with a soft clean cloth



















Power Loss

Prolonged power interruption causes the following features to reset to their factory preset state.

FEATURE	FACTORY PRESET STATE	FEATURE	FACTORY PRESET STATE
POWER	OFF	CLOCK	NOT SET
VOLUME	APPROX -1/3	SLEEP TIMER	NO/OFF
CHANNEL	CH 03	TIMER	NO/OFF
PROGRAM MEMORY	UNPROGRAMMED	ANTENNA (TV or CABLE)	CABLE
VIDEO MENUS	NORMALIZED	TV/VIDEO	TV
STEREO/SAP/MONO	STEREO	MENU LANGUAGE	ENGLISH

Troubleshooting Chart

Before you call for service, determine the symptoms and make a few simple checks shown below

Symptoms		Check
Picture	Sound	
 SNOWY PICTURE	 NOISY SOUND	- ANTENNA LOCATION AND/OR CONNECTION
 MULTIPLE IMAGE	 NORMAL SOUND	- ANTENNA DIRECTION AND/OR LOCATION - ANTENNA LEAD-IN WIRE
 INTERFERENCE	 NOISY SOUND	- ELECTRICAL APPLIANCES, LIGHTS, CARS AND TRUCKS - DIATHERMY AND OTHER MEDICAL EQUIPMENT
 NORMAL PICTURE	 NO SOUND	- VOLUME CONTROL SETTING - MUTE CONTROL (IF APPLICABLE) - TRY ANOTHER CHANNEL - TV SPEAKERS (IF APPLICABLE) IN THE OFF MODE
 NO VIDEO	 NOISY SOUND	- TV OR CABLE TUNING MODE SET TO PROPER SETTING - ANTENNA INPUT CORRECT (IF APPLICABLE)
 NO PICTURE	 NO SOUND	- CHECK THAT AC POWER LINE IS PLUGGED INTO AC OUTLET - BRIGHTNESS AND AUDIO CONTROLS SET PROPERLY - TRY ANOTHER CHANNEL
 NO COLOR	 NORMAL SOUND	- COLOR CONTROL SETTINGS - TRY ANOTHER CHANNEL
 BLUE PICTURE	 NO SOUND	- RECEIVER IN VIDEO MODE WITH NO SIGNAL
 BLACK BOX IN PICTURE	 SOUND	- CC (CLOSED CAPTION) IN TEXT MODE - SELECT CAPTION OFF MODE TO ELIMINATE BLACK BOX

Should this unit turn ON momentarily and then turn OFF, or fail to operate, unplug the AC cord and contact your Authorized Servicer for repairs

Matsushita Consumer Electronics Company, Division of Matsushita Electric Corporation of America
One Panasonic Way
Secaucus, New Jersey 07094

Matsushita Electric of Canada Limited
5770 Ambler Drive
Mississauga, Ontario L4W 2T3
Canada

Panasonic Sales Company, Division of Matsushita Electric of Puerto Rico Inc ("PSC")
Ave 65 de Infantena, Km 9 5
San Gabriel Industrial Park
Carolina, Puerto Rico 00985
Tel (809) 705-4300
FAX (809) 768-2910

Free Manuals Download Website

<http://myh66.com>

<http://usermanuals.us>

<http://www.somanuals.com>

<http://www.4manuals.cc>

<http://www.manual-lib.com>

<http://www.404manual.com>

<http://www.luxmanual.com>

<http://aubethermostatmanual.com>

Golf course search by state

<http://golfingnear.com>

Email search by domain

<http://emailbydomain.com>

Auto manuals search

<http://auto.somanuals.com>

TV manuals search

<http://tv.somanuals.com>