

Panasonic®

Color Television Operating Instructions



CT-32S21



CT-3268S

Read these instructions completely before operating.
Contents subject to change without notice or obligation.

Copyright 1997 by Matsushita Electric Corporation
of America. All rights reserved. Unauthorized
copying and distribution is a violation of law.

Printed in U.S.A.
TQB2AA0122

Safety Instructions

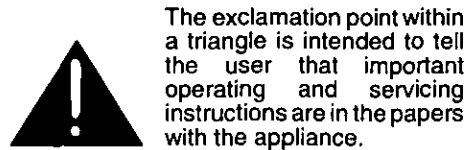
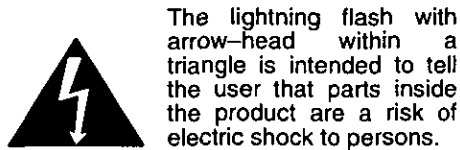
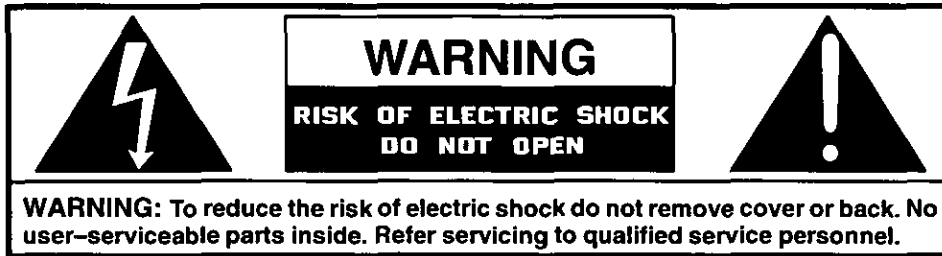

Note To CATV System Installer: This reminder is provided to call the CATV system installer's attention to Article 820-40 of the NEC that provides guidelines for proper grounding and, in particular, specifies that the cable ground shall be connected to the grounding system of the building, as close to the point of cable entry as practical.

Safety Instructions For Television Receivers

1. Read and apply the operating instructions provided with your television receiver.
2. Read all of the instructions given here and retain them for later use.
3. Unplug this television receiver from the wall outlet before cleaning. Do not use liquid or aerosol cleaners. Use a damp cloth for cleaning.
4. Do not use attachments not recommended by the television receiver manufacturer as they may cause hazards.
5. Do not use this television receiver near water. For example: Avoid placing it near a bathtub, washbowl, kitchen sink, or laundry tub, in a wet basement, or near a swimming pool, etc.
6. Do not place this television receiver on an unstable cart, stand, or table. The television receiver may fall, causing serious injury to a child or adult, and serious damage to the appliance. Use only with a cart or stand recommended by the manufacturer, or sold with the television receiver. Wall or shelf mounting should follow the manufacturer's instructions, and should use a mounting kit approved by the manufacturer.
- 6A. An appliance and cart combination should be moved with care. Quick stops, excessive force, and uneven surfaces may cause the appliance and cart combination to overturn.
7. Slots and openings in the cabinet and the back or bottom are provided for ventilation, and to insure reliable operation of the television receiver and to protect it from overheating. These openings must not be blocked or covered. The openings should never be blocked by placing the television receiver on a bed, sofa, rug or other similar surface. This television receiver should never be placed near or over a radiator or heat register. This television receiver should not be placed in a built-in installation such as a bookcase unless proper ventilation is provided.
8. Operate only from the type of power source indicated on the marking label. If you are not sure of the type of power supplied to your home consult your television dealer or local power company. For television receivers designed to operate from battery power, refer to the operating instructions.
9. This television receiver is equipped with a polarized alternating-current line plug (a plug having one blade wider than the other). This plug will fit into the power outlet only one way. This is a safety feature. If you are unable to insert the plug fully into the outlet, try reversing the plug. If the plug should still fail to fit, contact your electrician to replace your obsolete outlet. Do not defeat the safety purpose of the polarized plug.
10. Do not allow anything to rest on the power cord. Do not locate this television receiver where the cord will be abused by persons walking on it.
11. Follow all warnings and instructions marked on the television receiver.
12. Do not overload wall outlets and extension cords as this can result in fire or electric shock.
13. Never push objects of any kind into this television receiver through cabinet slots as they may touch dangerous voltage points or short out parts that could result in a fire or electric shock. Never spill liquid of any kind on the television receiver.

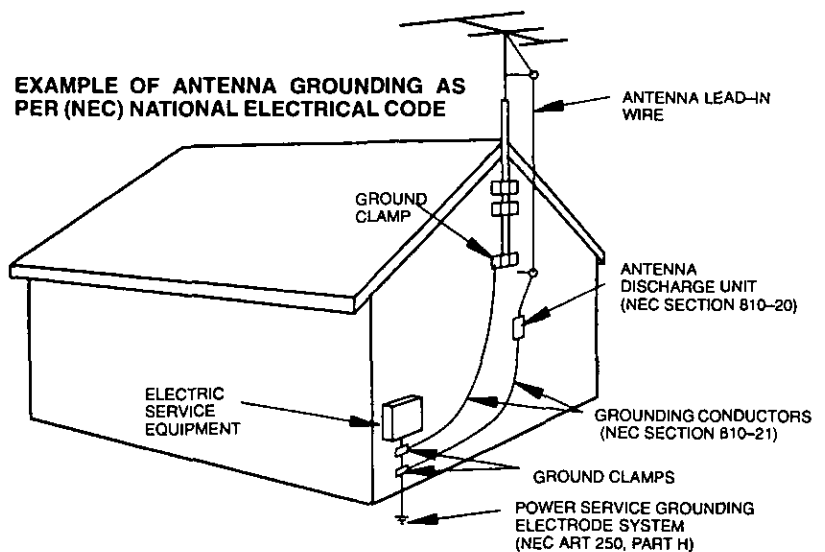

14. If an outside antenna is connected to the television equipment, be sure the antenna system is grounded so as to provide some protection against voltage surges and built up static charges. In the U.S. Section 810 of the National Electrical Code and in Canada Part 1 of the Canadian Electrical Code provides information with respect to proper grounding of the mast and supporting structure, grounding of the lead-in wire to an antenna discharge unit, size of grounding conductors, location of antenna-discharge unit, connection to grounding electrodes, and requirements for the grounding electrode. See Figure.
15. For added protection for this television receiver during a lightning storm, or when it is left unattended and unused for long periods of time, unplug it from the wall outlet and disconnect the antenna. This will prevent damage to the receiver due to lightning and power-line surges.
16. An outside antenna system should not be located in the vicinity of overhead power lines or other electric light or power circuits, or where it can fall into such power lines or circuits. When installing an outside antenna system extreme care should be taken to keep from touching such power lines or circuits as contact with them might be fatal.
17. Unplug this television receiver from the wall outlet, and refer servicing to qualified service personnel under the following conditions:
 - a. When the power cord or plug is damaged or frayed.
 - b. If liquid has been spilled into the television receiver.
 - c. If the television receiver has been exposed to rain or water.
 - d. If the television receiver does not operate normally by following the operating instructions. Adjust only those controls that are covered by the operating instructions as improper adjustment of other controls may result in damage and will often require extensive work by a qualified technician to restore the television receiver to normal operation.
 - e. If the television receiver has been dropped or the cabinet has been damaged.
 - f. When the television receiver exhibits a distinct change in performance – this indicates a need for service.
18. Do not attempt to service this television receiver yourself as opening or removing covers may expose you to dangerous voltage or other hazards. Refer all servicing to qualified service personnel.
19. When replacement parts are required, be sure the service technician has used replacement parts specified by the manufacturer that have the same characteristics as the original part. Unauthorized substitutions may result in fire, electric shock, or other hazards.
20. Upon completion of any service or repairs to this television receiver, ask the service technician to perform routine safety checks to determine that the television is in safe operating condition.
21. **WARNING: To prevent fire or shock hazard, do not expose this appliance to rain or moisture.**
22. **CAUTION: TO PREVENT ELECTRIC SHOCK DO NOT USE THIS (POLARIZED) PLUG WITH A RECEPTACLE OR OTHER OUTLET UNLESS THE BLADES CAN BE FULLY INSERTED TO PREVENT BLADE EXPOSURE.**

NOTE: This equipment is designed to operate in the U.S.A., Canada and other countries where the broadcasting system and AC house current is exactly the same as in the U.S.A. and Canada.

Important Information Regarding Use of Video Games, Computers, DSS or Other Fixed Image Displays.

The extended use of fixed image program material can cause a permanent "shadow image" on the picture tube. This background image is viewable on normal programs in the form of a stationary fixed image. This type of irreversible picture tube deterioration can be limited by observing the following steps:

- A. Reduce the brightness/contrast setting to a minimum viewing level.
- B. Do not display the fixed image for extended periods of time.
- C. Turn the power off when not in actual use.

NOTE: The marking or retained image on the picture tube resulting from fixed image use is not an operating defect and as such is not covered by Warranty. This product is not designed to display fixed image patterns for extended periods of time.

Specifications

Power Source	120V AC, 60Hz
Channel Capability	181 channels (See chart) VHF 2-13, UHF 14-69, Cable 125 channels
Video Input Jacks (2):	1V p-p, 75 ohm, phono jack type
Audio Input Jacks (2):	500mV rms 47K ohm
To Audio AMP Jacks:	0-2.0V rms 4.7K ohm
S-VHS Input Jack	S-Video (y-c) connector (CT-32S21 ONLY)
Stereo Sound	
Closed Caption Display	
Picture In Picture	1 Tuner

Channel Capability Chart

BAND	CHANNELS
VHF	12
UHF	56
CABLE (Mid-Band)	15
CABLE (Super Band)	14
CABLE (Hyper Band)	28
CABLE (Ultra Band)	56
TOTAL CHANNELS	181

Specifications are subject to change without notice or obligation.

Introduction

Congratulations on Your New Purchase

Your new video component features an all solid state chassis which is designed to give you many years of enjoyment. It was thoroughly tested and adjusted at the factory for best performance.

In order for you to take full advantage of your new video component, please read and follow the installation and operating instructions supplied with this product.

Customer's Record

The model and serial number of this product may be found on its back cover. You should note the model and serial number in the space provided and retain this book as a permanent record of your purchase to aid in identification in the event of theft or loss.

Model Number: _____ Serial Number: _____

Table of Contents

Safety Instructions	2	Picture Adjustments	21
Specifications	3	Picture Norm	21
Introduction	4	Color, Tint, Brightness, Picture and Sharpness ..	21
Installation	5	Audio Adjustments	22
Television Location	5	Mode	22
Optional External Equipment Connections	5	AI Sound (for CT-32S21 only)	22
AC Power Supply Cord	5	TV Speakers	22
Remote Control Battery Installation	5	Lock Features	23
Antenna/Cable Connections	6	Lock Game Guard	23
Other Video Equipment	6	Unlock Game Guard	23
Care and Cleaning	6	Channel Caption	24
Optional Equipment Connection and Operation ..	7	Timer Features	24
To Audio AMP Connection	7	Sleep Timer	24
Audio/Video Input Connection	7	Program Timer	25
VCR and Cable Box Connection	8	Set-Up Features	26
PIP Operation with VCR and Cable Box	8	Set Time	26
PIP Operation Using VCR as Second Tuner	9	Antenna (Ant)	26
Location of Controls (TV)	10	Auto Prog	26
Location of Controls Remote (for CT-3268S)	11	Manual Prog	27
Remote Quick Reference Functional Key Chart		Auto Power On	27
(for CT-3268S)	12	CC (Closed Caption) Mode	27
Location of Controls Remote (for CT-32S21)	14	Programming the Universal Remote Control	
Remote Quick Reference Functional Key Chart		(for CT-3268S)	28
(for CT-32S21)	15	VCR and Cable Box Infrared Codes Index	
Special Functions	17	(for CT-3268S)	29
Recall Button	17	Programming the Home Theater Remote	
R-Tune Button	17	(for CT-32S21)	30
Multi Button (for CT-32S21)	17	VCR Infrared Codes Index (for CT-32S21)	31
Multi Button (for CT-3268S)	18	Cable Box and CD Players Infrared Codes Index	
Cable Power Button (for CT-3268S)	18	(for CT-32S21)	32
PIP (Picture in Picture) Button	18	Cassette Deck, Receivers, and Amplifiers	
Swap Button	19	Infrared Codes Index (for CT-32S21)	33
Size Button	19	Laser Disc, DSS, and DVD Infrared Codes Index	
Freeze Button	19	(for CT-32S21)	34
Move Button	19	Troubleshooting Chart	35
Main Menu Icons	20		
Menu Language Selection	20		

Installation

Television Location

This television is intended to be used with an optional stand or entertainment center. Consult your dealer for available options.

Locate for comfortable viewing. Avoid placing where sunlight or other bright light (including reflections) will fall on the screen.

Use of some types of fluorescent lighting may reduce remote control transmitter range.

Adequate ventilation is essential to prevent internal component failure. Keep away from areas of excessive heat or moisture.

To insure optimum color purity do not position magnetic equipment (motors, fans, other speakers, etc.) nearby.

Optional External Equipment Connections

The Video/Audio connections between components can be made with shielded video and audio cables. For best performance, video cables should utilize 75 ohm coaxial shielded wire. Cables are available from your dealer or electronic supply house.

Before you purchase any cables, be sure you know what type of output and input connectors your various components require. Also determine the length of cable you'll need.

AC Power Supply Cord

CAUTION: TO PREVENT ELECTRIC SHOCK, MATCH WIDE BLADE OF PLUG TO WIDE SLOT OF AC OUTLET AND FULLY INSERT. DO NOT USE THIS (POLARIZED) PLUG WITH A RECEPTACLE OR OTHER OUTLET UNLESS THE BLADE CAN BE FULLY INSERTED TO PREVENT BLADE EXPOSURE.

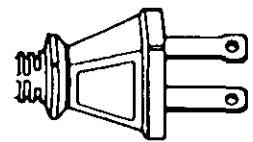

Polarized Plug

Remote Control Battery Installation

Batteries: Use two "AA" batteries.

1. Remove the battery compartment cover on back of the remote.
2. Install the batteries in the battery compartment. (Polarity (+) or (-) must be correct.)
3. Reattach the battery cover.

Helpful Hints:

For frequent Remote Control users, replace old batteries with Alkaline batteries for longer life.

Precaution on Battery Use

Incorrect installation can cause battery leakage and corrosion that will damage the Remote Control Transmitter.

Observe the Following Precautions:

1. Batteries must be replaced as a pair.
2. Do not combine a used battery with a new one.
3. Do not mix battery types (Example: "Zinc Carbon" with "Alkaline").
4. Do not attempt to charge, short-circuit, disassemble, heat or burn used batteries.
5. Battery replacement is necessary when Remote Control reacts sporadically or stops operating the Receiver.

Helpful Hints:

Whenever you remove the batteries to replace them, **you may need to reset the Remote Control Infrared Codes.** We recommend that you initially record the codes in the Infrared Remote Codes for Specific Components section, prior to setting up the remote.

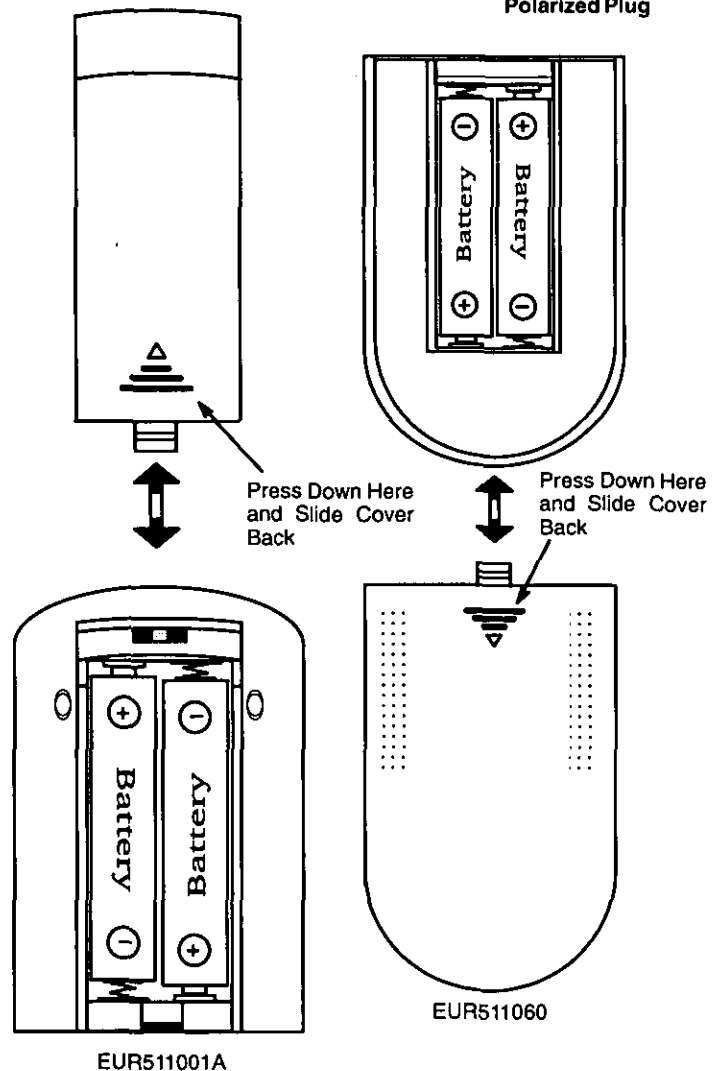

Installation (cont.)

Antenna/Cable Connections

Antenna Connection – For proper reception of VHF/UHF channels, an external antenna is required. For best reception an outdoor antenna is recommended. **Antenna Mode must be set to TV.** (Refer to Antenna Mode section.)

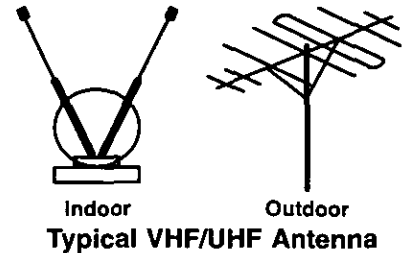

Incoming Cable from Home Antenna

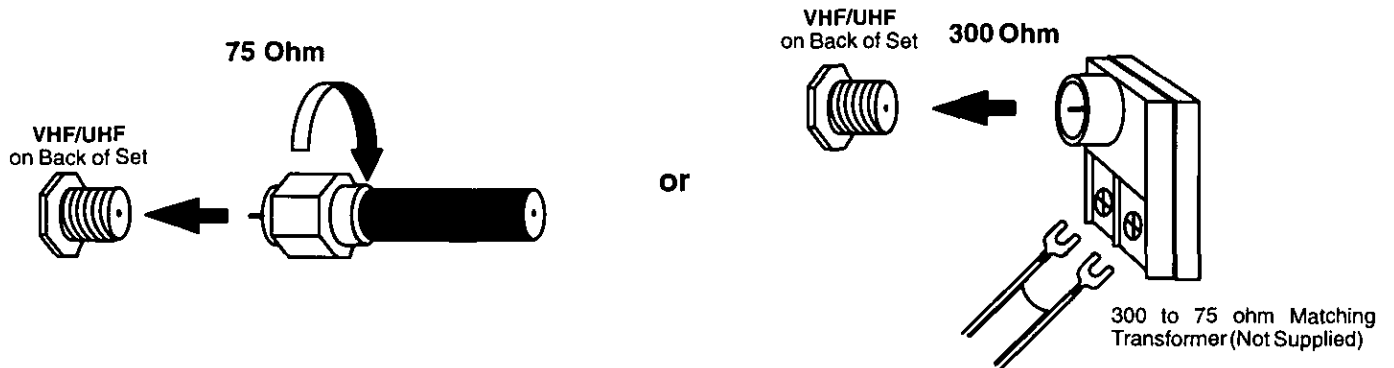

Cable Connection – For reception of cable channels, connect the cable supplied by your local cable company. **Antenna Mode must be set to CABLE.** (Refer to Antenna Mode section.)

Incoming Cable from Cable Company

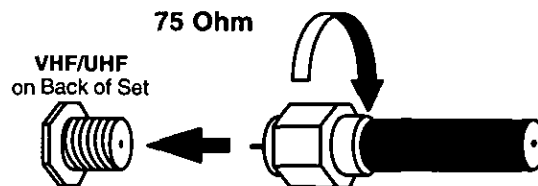

NOTE: Certain cable systems offset some channels to reduce interference or have Premium (scrambled) channels. A cable converter box is required for proper reception. Check with your local Cable company for compatibility requirements.

Other Video Equipment

VCRs, Video Disc Players, Computers, TV games, and DSS equipment can also be connected to the antenna input connection.

Care and Cleaning

Picture Tube (Turn set off)

Use a mild soap solution or window cleaner and a clean cloth. **DO NOT USE ABRASIVE CLEANERS.** Avoid excessive moisture and wipe dry.

Plastic Cabinets

Wipe the cabinet with a soft cloth dampened with water or a mild detergent solution and wipe dry with a soft clean cloth. Avoid excessive moisture. Do not use benzene, thinners or other petroleum based cleaners.

Wood Cabinets

When dusting or polishing the cabinet, use a clean soft cloth and stroke straight with the grain. An occasional coat of furniture polish will help preserve the finish. Do not use benzene, thinners or other petroleum based cleaners. Do not place objects made of plastic or rubber directly on top of the cabinet. A chemical reaction could result causing permanent marring of the finish.

Remote Control Transmitter

Do not use benzene, thinners or other petroleum based cleaners to clean the Remote Control Transmitter. To clean, wipe with a soft cloth slightly moistened with a mild detergent and then wipe dry with a soft clean cloth.

Optional Equipment Connection and Operation

To Audio AMP Connection (Stereo)

Connect to an external audio amp auxiliary input for monitoring sound through a stereo system.

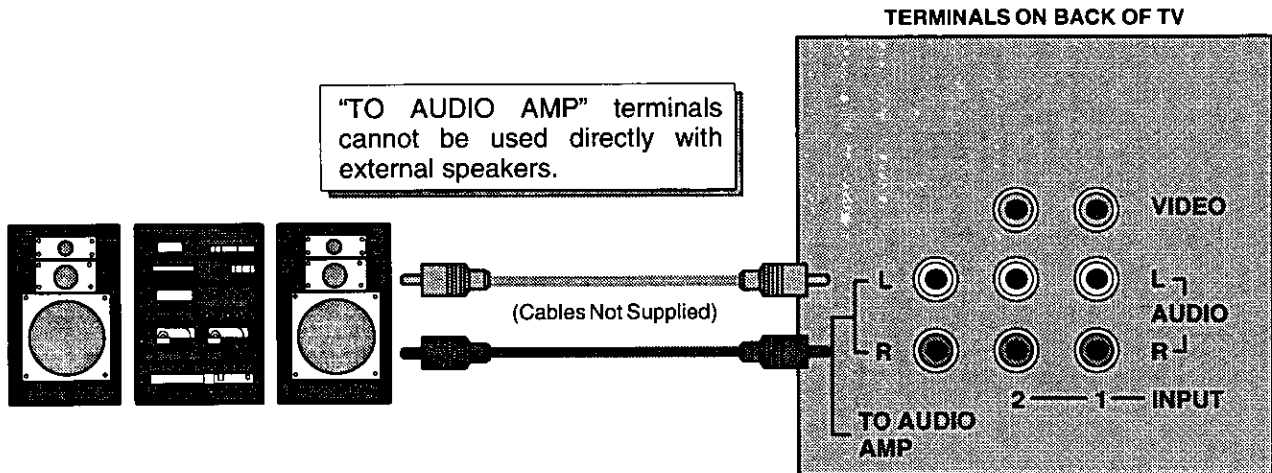

Adjustment – When an audio amp is connected to "TO AUDIO AMP" terminals:

1. Select TV SPEAKERS "ON" Mode. (Refer to the Audio Menu TV Speakers section.)
2. Set volume of audio amp to near minimum.
3. Adjust volume of TV to desired listening level.
4. Adjust volume of audio amp to match the level of TV.
5. Select TV SPEAKERS "OFF&VAO" Mode. (Refer to the Audio Menu TV Speakers section.)
6. Volume and mute can now be controlled by the TV Remote Control.

NOTE: When Selecting TV SPEAKERS "OFF&FAO" Mode, the TV sound output is always at a constant level and cannot be changed (Refer to the Audio Menu TV Speakers section).

Audio/Video Input Connection

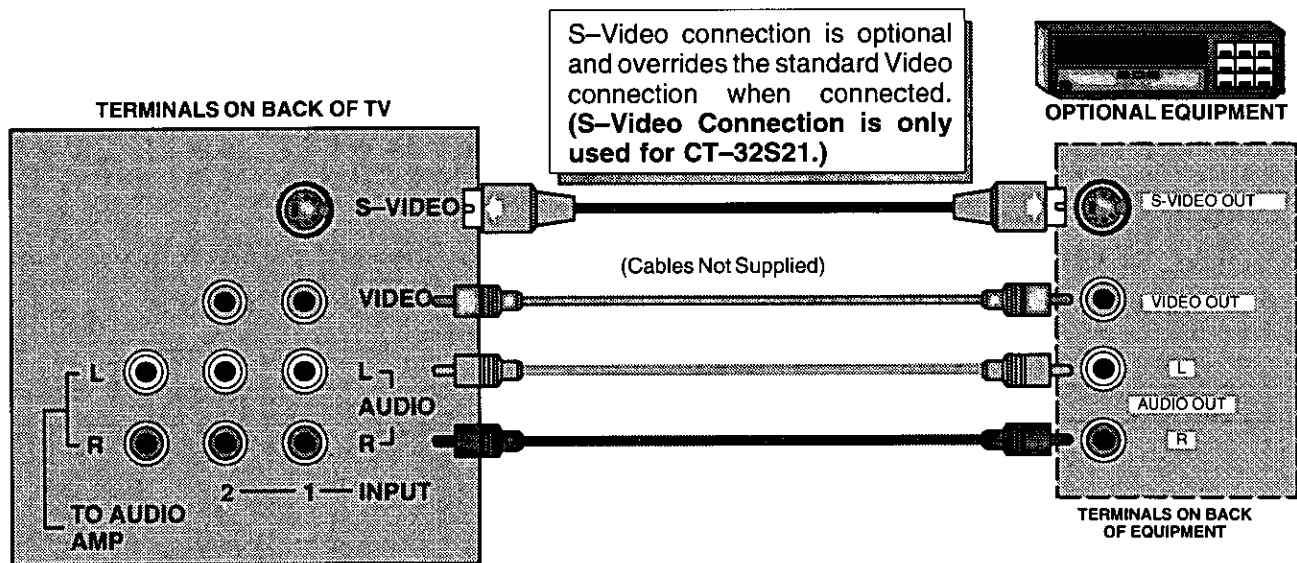

Operation

1. Connect optional equipment as shown to INPUT 1 or 2 terminals. If S-Video is to be used, connect S-Video (YC) connector to S-Video terminal and connect audio cables to L & R Audio INPUT 1 terminals. (**S-Video Connection is only used for CT-32S21.**)
2. Select the desired Video mode by pressing the TV/VIDEO button.
3. Operate optional equipment (VCR-VDP) as instructed in Optional Equipment manual.

NOTE:

- You must select the same VIDEO Mode that the equipment is connected to.
- Connection of optional S-VIDEO jack automatically disconnects the Normal Video Input 1 jack. (**S-Video Connection is only used for CT-32S21.**)

Optional Equipment Connection and Operation (cont.)

VCR and Cable Box Connection

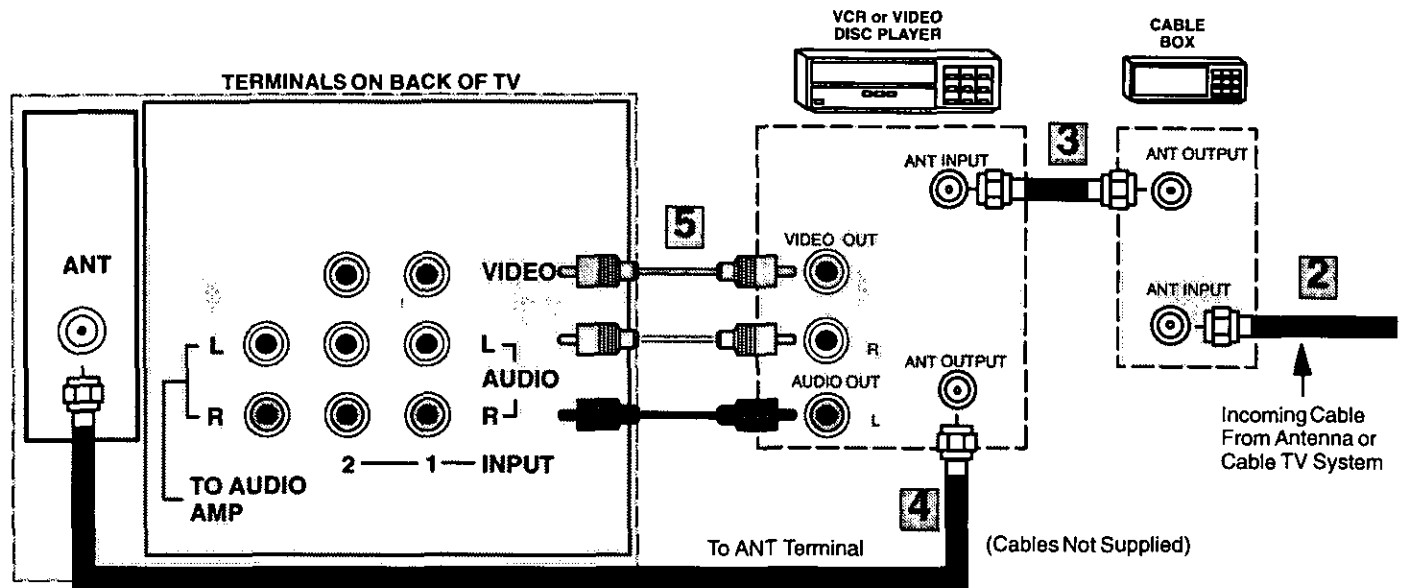

Connection

1. Program Remote Control for VCR and Cable Box.
2. Connect incoming Cable to optional cable box ant input.
3. Connect a cable from Cable box ant output to VCR ant input.
4. Connect a cable from VCR ant output to TV ant input.
5. Connect RCA cables from VCR Audio/Video output to TV Audio/Video input, 1 or 2. Select the same VIDEO Mode that the equipment is connected to.

Picture in Picture Operation with VCR and Cable Box

This Receiver has the "PICTURE IN PICTURE" feature. For the proper operation of this feature a second video source is required (such as a VCR). We recommend that you make your antenna and External Video connection as shown below when a second video source is available.

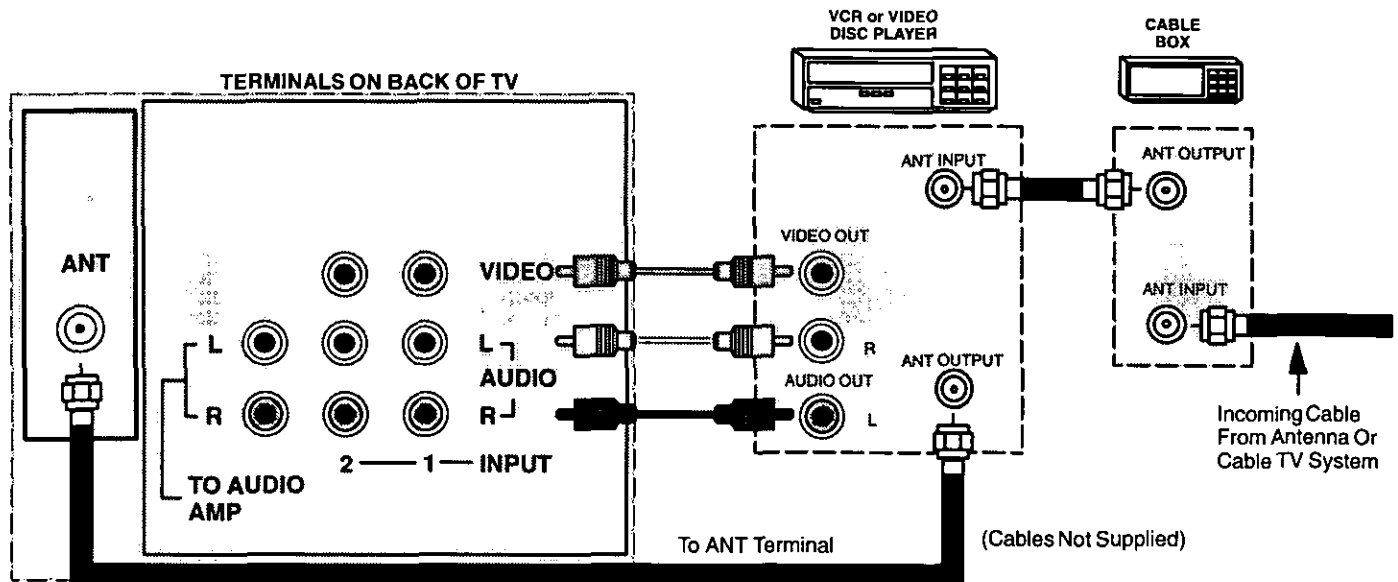

Operation

1. Press the PIP button to display the PIP frame.
2. Press the TV/VIDEO button to select the desired video mode. Select the same VIDEO Mode that the equipment is connected to.
3. Turn VCR ON. **NOTE:** PIP video and Main video source will be the same.
4. Press PLAY button for VCR. **NOTE:** PIP video and Main video source will be from VCR.
5. Press TV/VCR button to display TV video source for Main picture.

Optional Equipment Connection and Operation (cont.)

Picture in Picture Operation Using VCR as Second Tuner

This Television has the "PICTURE IN PICTURE" feature. For the proper operation of this feature a second video source is required (such as a VCR). We recommend that you make your antenna and External Video connection as shown below when a second video source is available.

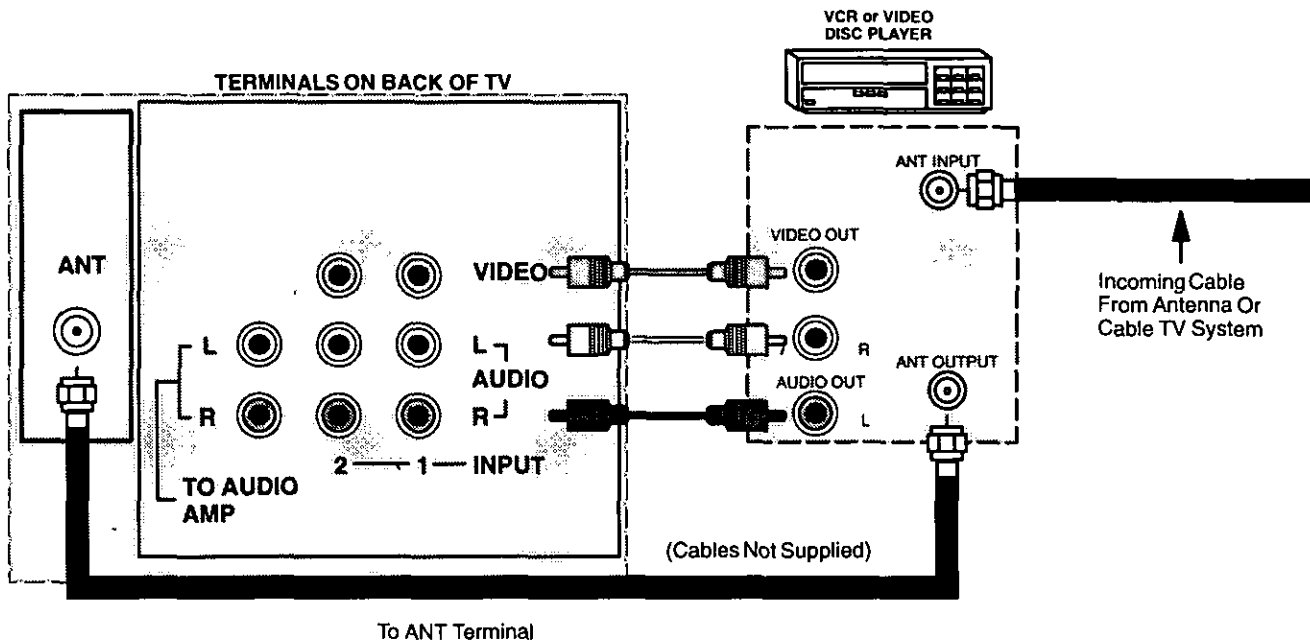

Operation

1. Press the PIP button to display the PIP frame.
2. Press the TV/VIDEO button to select the desired video mode. Select the same VIDEO Mode that the equipment is connected to.
3. Turn VCR ON. **NOTE:** You may lose TV video source for Main Picture.
4. Press TV/VCR button to display TV video source for Main Picture.
5. Use the VCR Tuner to select channels in the PIP frame.

Helpful Hints:

The PIP will operate using Audio/Video input terminals 1 or 2. Use the TV/VIDEO button (when the PIP frame is displayed) to select proper mode.
The PIP feature will operate using S-Video input terminal 1 (For CT-32S21 only).

Location of Controls Television

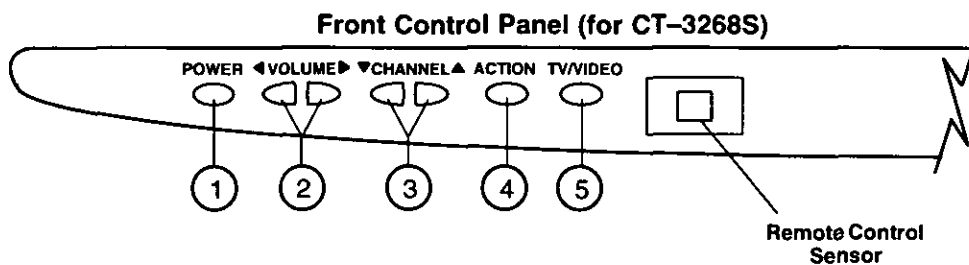
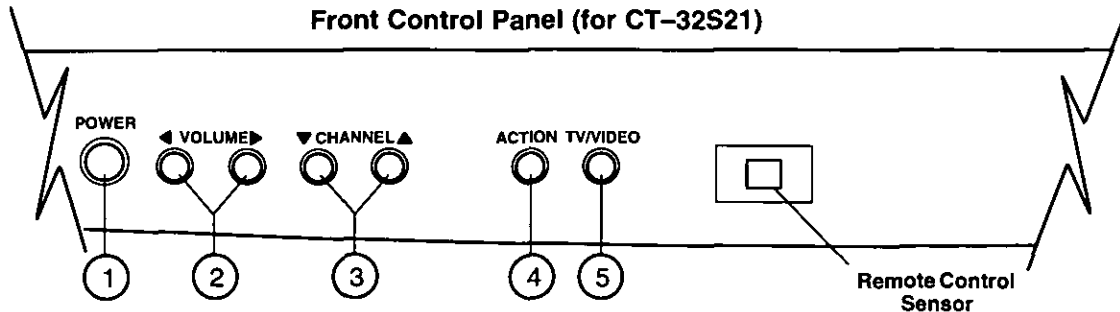

- ① **Power Button** – Press to turn ON or OFF.
- ② **Volume Buttons** – Press to adjust Sound Level. Press to adjust Audio Menus, Video Menus and select operating features when menus are displayed.
- ③ **Channel Buttons** – Press to select programmed channels. Press to highlight desired features when menus are displayed.
- ④ **Action Button** – Press to display Main Menu and access On Screen feature and Adjustment Menus.
- ⑤ **TV/Video Button** – Press to select TV or one of two Video Inputs.

Location of Controls Remote

(for CT-3268S)

Power Button
Press to turn ON or OFF.

TV/Video Button
Press to select TV or one of two Video Inputs, for the Main Picture or the PIP frame (when the PIP frame is displayed).

Volume Buttons
Press to adjust TV sound level. Use with Channel buttons to navigate in menus.

Keypad Buttons
Press desired channel number to randomly access any channel.

R-Tune (Rapid Tune) Button
Press to switch to the previous channel.

VCR Function Buttons
Programmable to operate many brands of VCR's.

TV/VCR/CABLE Switch
This switch is used to select the proper mode when programming Remote Control Infrared codes or operating the TV or external equipment (VCR or Cable box).

PIP Move Button
Press to position PIP frame to any corner of the Main Picture (when PIP frame is displayed).

PIP Freeze Button
Press to stop action in the Main Picture or PIP frame (when the PIP frame is displayed).

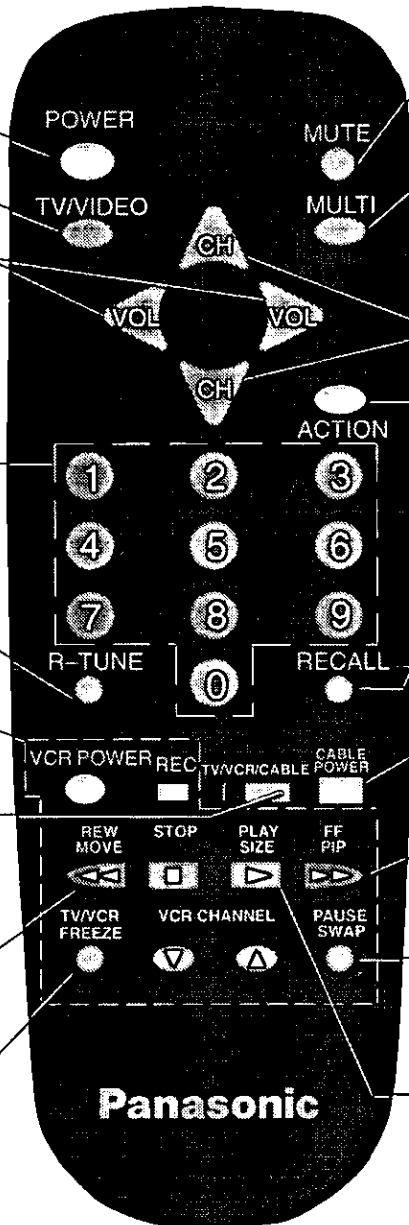

Mute Button
Press to mute sound. A second press resumes sound. Press also to access and delete Closed Caption.

Multi Button
Programmable to operate up to six Remote Control Function buttons simultaneously.

Channel Buttons
Press to select channels. Use with Volume buttons to navigate in menus.

Action Button
Press to display Main Menu and access or exit On Screen feature and Adjustment Menus.

Recall Button
Press to display Time, status of Sleep Timer, Channel, Video Mode, Channel Caption (Station Identifier) and Audio Mode.

Cable Power Button – Programmable to operate selected CATV converter boxes.

PIP (Picture In Picture) Button
Press to display the PIP frame, press again to remove PIP frame.

PIP Swap Button
Press to interchange PIP frame with Main Picture (when the PIP frame is displayed).











PIP Size Button
Press to select size of PIP frame (when the PIP frame is displayed).

EUR511001A

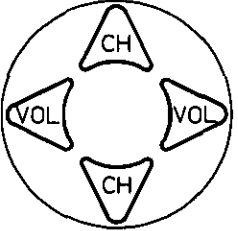



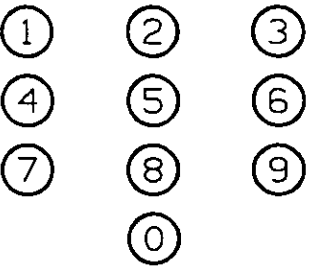





Remote Control

Quick Reference Functional Key Chart

(for CT-3268S)

KEY	OPERATES	FUNCTION
POWER 	TV	Turns TV On and Off
MUTE 	TV	Mutes TV Audio
TV/VIDEO 	TV	Selects the TV Input Mode
MULTI 	ALL COMPONENTS	Programmable Button that can operate up to six (6) Remote Functions at once
 ACTION	TV	Activates TV Menus
	TV CABLE   TV CABLE VCR  	Channel Up/Down, Menu Navigation Channel Up/Down Volume Up/Down, Menu Navigation Search for Infrared Code when Programming Remote
	TV VCR CABLE	Selects Channel Selects Code in Game Guard Menu Selects Channel in Channel Caption Menu Selects Channel in Timer Menu Selects Infrared Code when Programming Remote Selects Infrared Code when Programming Remote
R-TUNE 	TV	Switches Between Two (2) Channels
RECALL 	TV	Displays Channel (or Video Mode), Channel Caption, Time, Sleep Time, and Audio Mode

Remote Control
Quick Reference Functional Key Chart (cont.)
(for CT-3268S)

KEY	OPERATES	FUNCTION
TV/VCR/CABLE 	TV VCR CABLE	TV Mode Selection for Remote Control VCR Mode Selection for Remote Control CATV Mode Selection for Remote Control
CABLE POWER 	CABLE	Turns Cable On and Off
VCR POWER 	VCR	Turns VCR On and Off
REC 	VCR	Record
STOP 	VCR	Stop
VCR CHANNEL 	VCR	VCR Channel Up/Down
FF PIP 	TV VCR	PIP ON/Off Fast Forward
PLAY SIZE 	TV VCR	PIP Size Play
REW MOVE 	TV VCR	PIP Move Rewind
PAUSE SWAP 	TV VCR	PIP Swap Pause
TV/VCR FREEZE 	TV VCR	PIP Freeze Selects TV/VCR Mode

Location of Controls Remote (for CT-32S21)

Basic Remote Control Functions

The following is an overview of the Remote Control unit for television operation. Ensure the TV mode is selected by initially pressing .

Multi Button

Programmable to operate up to six Remote Control Function buttons simultaneously.

Power Button

Press to turn ON or OFF.

Mode Selection Buttons

Select the operation mode for the remote control.

Volume Buttons

Press to adjust TV sound level. Use with Channel buttons to navigate in menus.

Action Button

Press to display Main Menu and access or exit On Screen feature and Adjustment Menus.

R-Tune (Rapid Tune) Button

Press to switch to the previous channel.

PIP Move Button

Press to position PIP frame to any corner of the Main Picture (when PIP frame is displayed).

PIP Freeze Button

Press to stop action in the Main Picture or PIP frame (when the PIP frame is displayed).

PIP Size Button

Press to select size of PIP frame (when the PIP frame is displayed).

Keypad "0 through 9" Buttons

Press desired channel number to randomly access any channel.

TV/Video Button

Press to select TV or one of two Video Inputs, for the Main Picture or the PIP frame (when the PIP frame is displayed).

Mute Button

Press to mute sound. A second press resumes sound.

Channel Buttons

Press to select channels. Use with Volume buttons to navigate in menus.

Recall Button

Press to display Time, status of Sleep Timer, Channel, Video Mode, Channel Caption (Station Identifier) and Audio Mode.

PIP (Picture In Picture) Button

Press to display the PIP frame, press again to remove PIP frame.

PIP Swap Button

Press to interchange PIP frame with Main Picture (when the PIP frame is displayed).

VCR Function Buttons

Programmable to operate many brands of VCR's.

VCR/DSS Channel Buttons

Select VCR or DSS Up/Down channels.

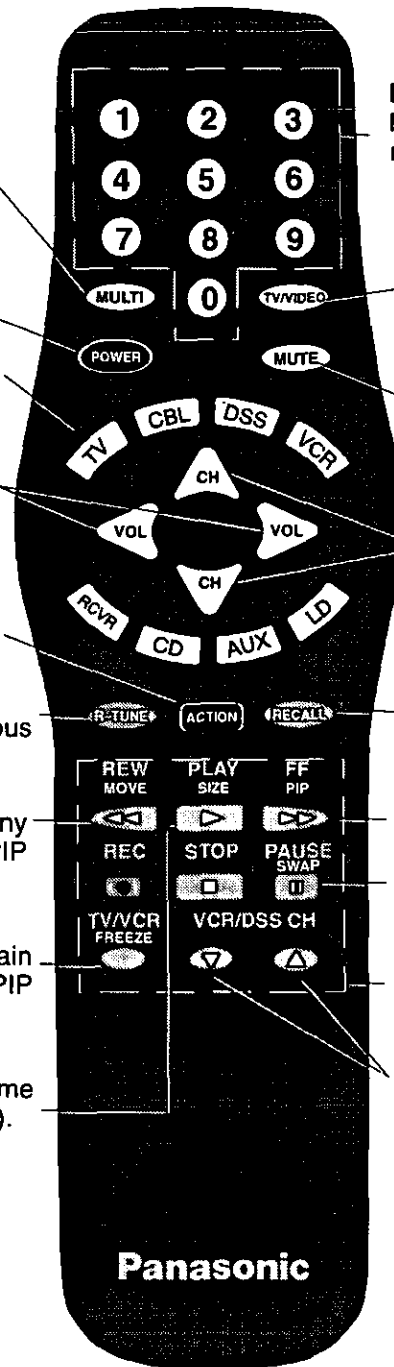

Home Theater Remote Control
EUR511060

Note:

For more information on the Remote Control, please refer to the Remote Control Quick Reference Functional Key Chart.











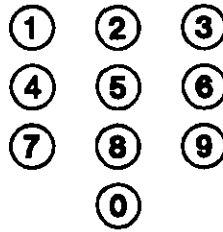



Helpful Hints:

If the selected component does not respond to the remote control, ensure that the proper mode is selected. **First**, press the **Mode Selection Button** that corresponds to that component. For example, after first pressing the TV Mode Button, the remote will remain in the TV mode for the following commands. If a different mode button is pressed while operating the television, the TV mode button must be pressed again to enable the TV mode condition.

Remote Control

Quick Reference Functional Key Chart











(for CT-32S21)

KEY	MODE	FUNCTION
	TV VCR, VCR 2 CABLE, DSS	Selects Channel Selects Channel Selects Channel
	RECEIVER/AMPLIFIER	① Selects Tuner ⑤ Selects CD Player ⑥ Selects Tape Cassette Player ⑦ VCR 1 ⑧ VCR 2
	CD PLAYER	Selects Track Number
	LD PLAYER	Selects Track Number
	ALL COMPONENTS	Programmable Button That Can Operate Up To Six (6) Remote Functions At Once
	TV	Selects the TV Input Mode
	ALL COMPONENTS	Turns On and Off Selected Components
	TV, DSS, VCR, VCR 2 LDP CABLE RECEIVER/AMPLIFIER	Mutes TV Audio Mutes Audio Mutes Audio
	TV	TV Mode Selection for Remote Control
	CABLE	Cable Mode Selection for Remote Control
	DSS (DIGITAL SATELLITE SYSTEM)	DSS Mode Selection for Remote Control
	VCR, VCR 2	VCR Mode Selection for Remote Control
	RECEIVER/AMPLIFIER	Receiver/Amplifier Mode Selection for Remote Control
	COMPACT DISC	CD Mode Selection for Remote Control
	CASSETTE DECK, VCR 2, DVD	AUX Mode Selection for Remote Control Enables User to Operate a Cassette Deck, Digital Video Disc or Second VCR
	LASER DISC PLAYER	LD Mode Selection for Remote Control
	TV CABLE DSS LDP CD RECEIVER/AMPLIFIER DVD	Channel Up/Down, Menu Navigation Channel Up/Down DSS Guides and Menu Navigation Skip FF, REW Preset or Tuning Frequency Skip FWD/Skip REW
	TV CABLE DSS RECEIVER/AMPLIFIER VCR, VCR 2 LDP	Volume Up/Down, Menu Navigation Volume Up/Down DSS Guides and Menu Navigation, Also Switches Between Normal Audio and SAP Volume Up/Down TV Volume Up/Down TV Volume Up/Down

Remote Control

Quick Reference Functional Key Chart (cont.)

(for CT-32S21)

KEY	MODE	FUNCTION
	LDP TV CABLE VCR, VCR 2 DSS RECEIVER/AMPLIFIER CD AUDIO TAPE RECORDER	A/B Repeat Switches Between Two (2) Channels Switches Between Two (2) Channels Switches Between Two (2) Channels Switches Between Two (2) Channels Switches between AM and FM Selects Next Disc Selects Audio Tape Recorder A or B
	TV DSS	Activates TV Menus Acts as Menu Button for DSS
	TV DSS VCR, VCR 2 LDP	Displays Channel, Sleep Time, Channel Caption, Time, and Audio Mode Displays Current DSS Settings Displays Current VCR Settings Displays Current LDP Settings
	TV DSS VCR, VCR 2 LDP TAPE CD DVD	PIP Move DSS Guide Rewind Rewind Rewind Selects Previous Track Rewind
	TV DSS VCR, VCR 2 LDP TAPE CD DVD	PIP Size Enter/Select Play Play Play (In Normal Direction) Play Play
	TV DSS VCR, VCR 2 LDP TAPE CD DVD	PIP On/Off Exit/Clear Fast Forward Fast Forward Fast Forward Selects Next Track Fast Forward
	DSS VCR, VCR 2 TAPE CABLE	One Touch Record in DSS Mode Record Record VCR Record
	DVD VCR, VCR 2 LDP TAPE CD CABLE	Stop Stop Stop Stop Stop VCR Stop
	DVD TV VCR, VCR 2 LDP TAPE CD CABLE	Pause PIP Swap Pause Pause Pause Pause VCR Pause
	TV VCR, VCR 2 DSS CABLE	PIP Freeze Selects TV/VCR Mode Selects TV/DSS Mode Selects TV/VCR Mode
	VCR, VCR 2 DSS	Channel Up/Down Channel Up/Down

Special Functions

Recall Button

Press the RECALL button to review:

- ① Audio Mode status
- ② CH number or Video Input selected
- ③ Channel Caption (Station Identifier)
- ④ Clock time
- ⑤ Sleep Timer status

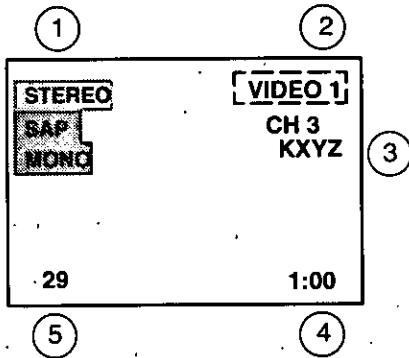

R-Tune Button

Pressing the R-TUNE (RAPID TUNE) button will switch between the last two channels selected on the numeric keypad.

Note: When scanning channels with the CHANNEL UP/DOWN button, pressing the R-TUNE button will switch between the last two channels scanned.

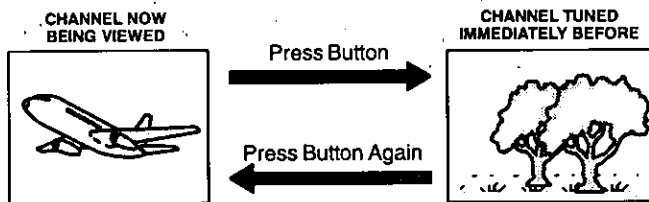

Multi Button (for CT-32S21)

The MULTI button can be programmed to operate up to six (6) Remote function buttons at the same time. **For Example:** TV Power/On, VCR Power/On, and Cable box Power/On (selected brands) can be operated at the same time with one press of the MULTI button. (The VCR Mode button should be programmed before starting procedure).

Procedure

1. Program the Remote for the selected device Infrared access code. Confirm that the Remote Control is compatible with the device.
2. Face the Remote Control transmitter away from all equipment remote sensors.
3. Press and hold the Remote POWER button, then press and hold the ACTION button down at the same time for three seconds. (All previous commands are erased.)

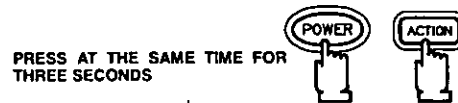

4. After three seconds, release the POWER and ACTION buttons.
5. Press the MULTI button. (Waiting more than 30 seconds without pressing another button will exit the programming mode.)
6. Press a maximum of six (6) function buttons on the Remote Control.

Each button you press is equal to one function. If six (6) Remote button functions are entered, all will register in the MULTI button memory in the sequence entered. When finished, press the MULTI button to exit the programming mode.

The following is an example flow chart of Remote functions that can be programmed into the MULTI button.

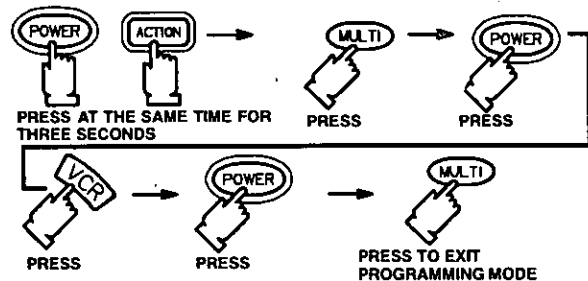

You can now turn the TV and VCR ON/OFF at the same time with one press of the MULTI button.

To delete entered functions – Press and hold the Remote POWER button, then press and hold the ACTION button down at the same time for three seconds. You can now enter from one to six different Remote functions.

NOTE: You can also program the MULTI button to perform most individual Remote Control button functions. Buttons which continuously perform a function as long as pressed (Volume Up/Down, Channel Up/Down, etc.) cannot be programmed; only those buttons which perform a function when initially pressed (Power On/Off, Mute, Direct Channel Entry, etc.) can be programmed.

Special Functions (cont.)

Multi Button (for CT-3268S)

The MULTI button can be programmed to operate up to 6 Remote function buttons at the same time.

For Example: TV Power/On, VCR Power/On (selected brands) can be operated at the same time with one press of the MULTI button.

Procedure

1. First program the Remote for the selected VCR Infrared access code. Confirm that the Remote Control is compatible with the equipment.
2. Face the Remote Control transmitter away from all equipment remote sensors.
3. Press and hold down the Remote TV Power button, then press and hold down the MULTI button at the same time. Release buttons (All previous commands will be erased.)

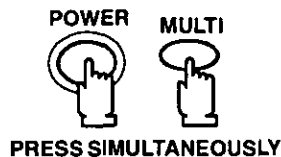

4. Press a maximum of 6 Function buttons on the Remote.
Each button you press is equal to one function. If six Remote button functions are entered, all will register in the MULTI button memory in the sequence entered. When less than six Remote button functions are entered, press the MULTI button to end the program mode. (Waiting more than 30 seconds without pressing another button will also end the program mode.)

The following is an example of Remote functions that can be programmed into the MULTI button.

- TV Power - For turning TV ON and OFF.
 - VCR Power - For turning VCR ON and OFF (selected brands after programming its Infrared access code, if necessary).
- Both can be turned ON or OFF with one press of the MULTI button.

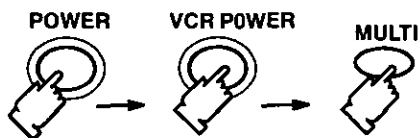

To delete entered functions - Repeat step 3. Now you can enter from one to six different Remote functions.

NOTE: You can also program the MULTI button to perform most individual Remote Control button functions. Buttons which continuously perform a function as long as pressed (Volume Up/Down, Channel Up/Down, etc.) cannot be programmed. Only those buttons which perform a function when initially pressed (Power On/Off, Mute, Direct Channel Entry, etc.) can be programmed.

Cable Power Button (for CT-3268S)

The  on the Remote Control has been designed to operate selected brands of Cable Television Converter boxes. The proper cable television converter box infrared code must be obtained prior to use. (Please refer to Programming the Universal Remote for programming instructions.) The Remote Control TV/VCR/CABLE switch should be in the CABLE position.

NOTE: The  or  on the Remote may be used for selecting Cable Converter box channels.

PIP (Picture in Picture) Button

This feature allows the viewer to monitor one channel program while watching another. The monitored source (PIP) must be a different video source (such as a VCR) when connected to the input jacks.

- When the Main Picture is in Video mode with no signal, the PIP will not operate properly.

PIP Operation

1. Turn VCR ON and select a desired channel.
2. Press the TV Mode Selection button to operate TV Remote functions, if necessary (some models).
3. Press the PIP button (set must be ON). The PIP frame will appear at the position it was last displayed. The Main Picture Video Source and PIP Video Source will display on screen momentarily. Audio will be that of Main Picture.

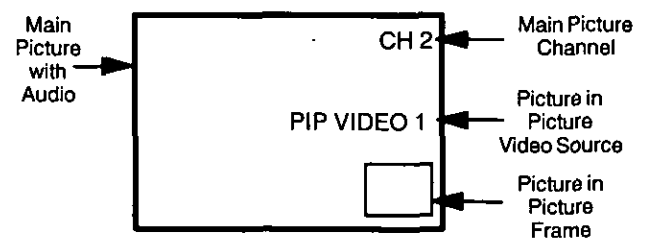

4. Press the PIP button again to cancel PICTURE IN PICTURE feature (if desired).

NOTE: For PIP Video source connection, refer to the PIP Operation Using VCR As second Tuner section.

Special Functions (cont.)

Swap Button

Press the SWAP button (when the PIP frame is displayed) to interchange what is being viewed on the Main Picture with that of the PIP frame.

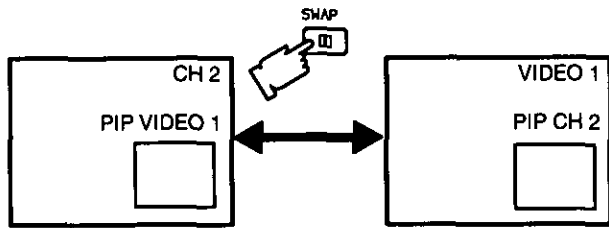

NOTE: Audio will be that of Main Picture.

Size Button

Press the SIZE button (when the PIP frame is displayed) to choose either the large or small PIP frame.

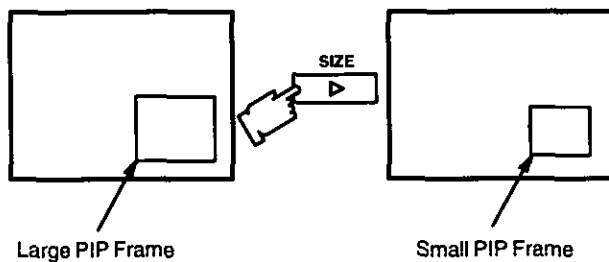

Freeze Button

Press the FREEZE button to stop action in the PIP frame.

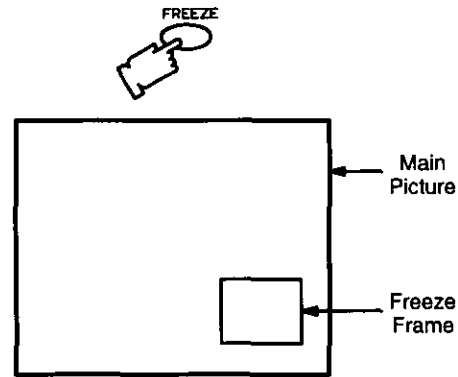

NOTES:

- Pressing the FREEZE button when the PIP frame is not displayed, will stop action in the Main Picture and display it within the PIP frame.
- Pressing the FREEZE button when PIP frame is displayed, will stop action in the PIP frame. Press the FREEZE button again to continue action.
- Press the PIP button to delete PIP frame.

Move Button

The PIP frame may be located at any corner of the Main Picture by pressing the PIP MOVE button (when the PIP frame is displayed).

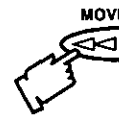

NOTE: Each time MOVE button is pressed (when the PIP frame is displayed), the PIP frame will move counterclockwise as illustrated.

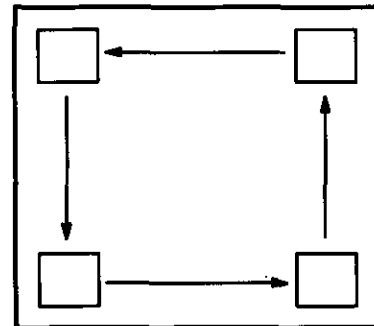

Main Menu Icons

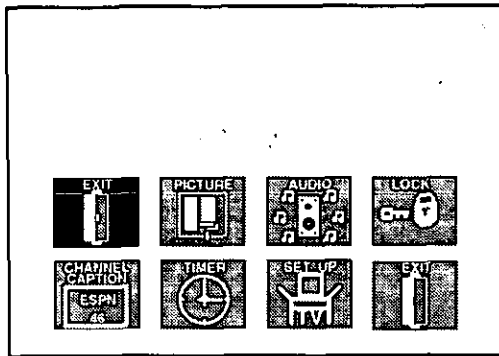

NOTE: When Auto Power On feature is activated, Timer Icon will change to an Exit Icon.



Display and Exit Menus

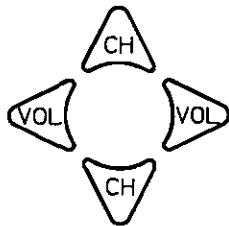

CH BUTTONS
Highlight Desired
Feature when
Menu is Displayed

VOL BUTTONS
Selects or Adjusts
Features when
Menu is Displayed

Located On Remote Control

1. Press **ACTION**.
2. Press **CH** or **CH** and **VOL** or **VOL** to select the desired icon.
3. Press **ACTION** after selecting the desired icon to access sub menus.
4. Press **ACTION** twice to exit sub menus or press **ACTION** once while the EXIT icon is highlighted to exit Main Menu.

Menu Language Selection

The MENU LANGUAGE is factory set to ENGLISH. Follow the instructions to change the Menu Language to SPANISH, FRENCH, and back to ENGLISH.

1. Press **ACTION**.
2. Press **CH** or **CH** and **VOL** or **VOL** to highlight the Set-Up icon.
3. Press **ACTION** to display the Set-Up Menu.

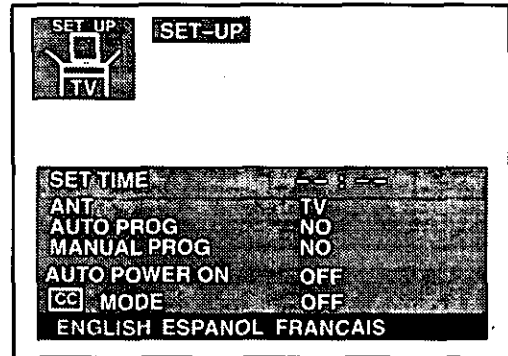

4. Press **CH** or **CH** to highlight ENGLISH, ESPAÑOL, FRANCAIS.
5. Press **VOL** or **VOL** to select ENGLISH, ESPAÑOL, or FRANCAIS.
6. Press **ACTION** twice to exit menus.

Picture Adjustments

Picture Norm

Use to reset Color, Tint, Brightness, Picture, and Sharpness adjustments back to a factory preset level.

1. Press **[ACTION]**.
2. Press **[CH]** or **[CH]** and **[VOL]** or **[VOL]** to highlight the Picture Icon.
3. Press **[ACTION]** to display the Picture Adjustment Menu.

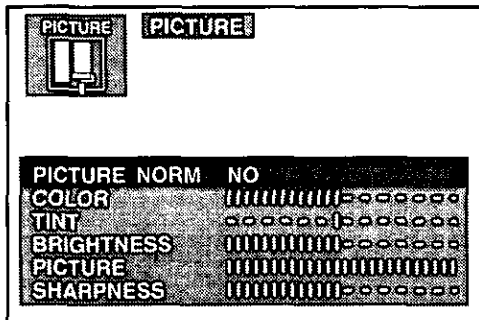

4. Press **[CH]** or **[CH]** to highlight PICTURE NORM.
5. Press **[VOL]** or **[VOL]** to select "SET" to normalize Color, Tint, Brightness, Picture, and Sharpness.
6. Press **[ACTION]** twice to exit menus.

Color, Tint, Brightness, Picture, and Sharpness Adjustments

1. Press **[ACTION]**.
2. Press **[CH]** or **[CH]** and **[VOL]** or **[VOL]** to highlight the Picture Icon.
3. Press **[ACTION]** to display the Picture Adjustment Menu.

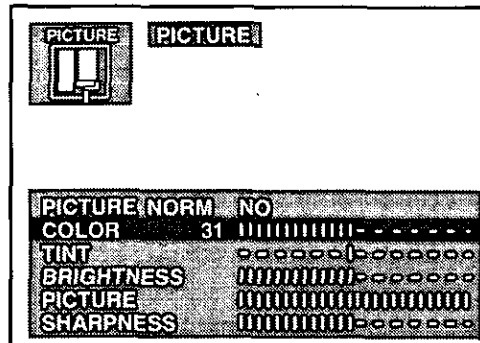

4. Press **[CH]** or **[CH]** to select the desired Picture Adjustment (Color, Tint, Brightness, Picture, or Sharpness).
5. Press **[VOL]** or **[VOL]** to adjust your selection. (The Selected Picture Adjustment will be displayed.)
6. Repeat steps 4 and 5 for the remaining Picture Adjustments.
7. Press **[ACTION]** twice to exit menus.

Helpful Hints:

- COLOR** – Adjust for desired color intensity.
- TINT** – Adjust for natural flesh tones.
- BRIGHTNESS** – Adjust so dark areas of picture slightly become black for a crisp detail.
- PICTURE** – Adjust the white areas of the picture as desired.
- SHARPNESS** – Adjust for best clarity of outline detail.

Audio Adjustments

Mode

When Audio is broadcast in Stereo or SAP, an On-Screen display will appear on initial "Turn On" and "Channel Change". The available choices will be highlighted.

1. Press **(ACTION)**.
2. Press **CH** or **CH** and **VOL** or **VOL** to highlight the Audio Icon.
3. Press **(ACTION)** to display the Audio Adjustment Menu.

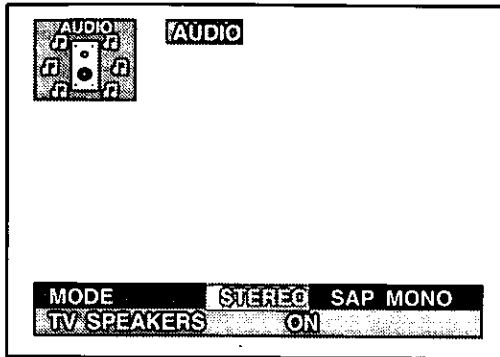

4. Press **CH** or **CH** to highlight MODE.
5. Press **VOL** or **VOL** to select STEREO, SAP (Second Audio Programming), or MONO. The selected mode will be highlighted.
6. Press **(ACTION)** twice to exit menus.

Helpful Hints:

STEREO – Two channel Audio reception.

SAP – Second Audio Programming (such as bilingual audio, weather reports, etc.).

MONO – Use when stereo signal is weak.

AI Sound (Used in CT-32S21 only)

This feature regulates the volume between programs and commercial audio to maintain a constant sound output level.

1. Press **(ACTION)**.
2. Press **CH** or **CH** and **VOL** or **VOL** to highlight the Audio Icon.
3. Press **(ACTION)** to display the Audio Adjustment Menu.

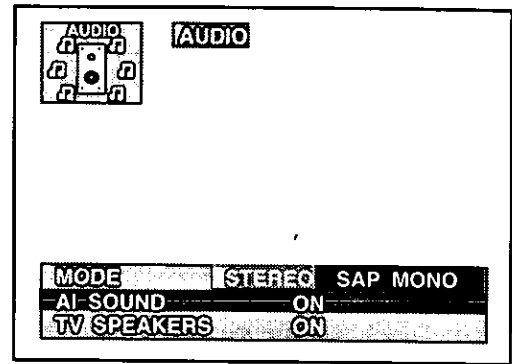

4. Press **CH** or **CH** to highlight AI SOUND.
5. Press **VOL** or **VOL** to select ON or OFF.
6. Press **(ACTION)** twice to exit menus.

TV Speakers

This feature is used to turn the internal speakers "ON" or "OFF". It is used when the TV is connected to an External Audio Amplifier. (Refer to "To Audio Amp Connection" section for further information.)

1. Press **(ACTION)**.
2. Press **CH** or **CH** and **VOL** or **VOL** to highlight the Audio Icon.
3. Press **(ACTION)** to display the Audio Adjustment Menu.

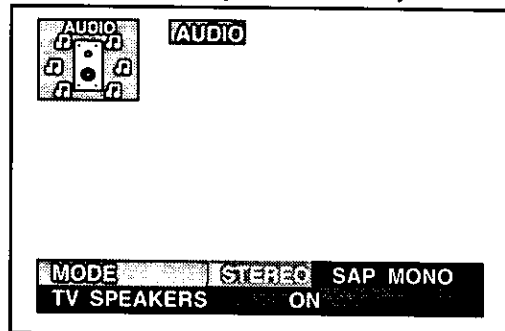

4. Press **CH** or **CH** to highlight TV SPEAKERS.
5. Press **VOL** or **VOL** to select ON, OFF&VAO or OFF&FAO.
 - ON – TV SPEAKERS operate normally
 - OFF&VAO (Variable Audio Output) – TV SPEAKERS off, the sound output varies according to the TV volume. Use the TV remote to control the volume and muting of the External Amplifier System
 - OFF&FAO (Fixed Audio Output) – TV SPEAKERS off, sound output is not adjustable. The audio is controlled by the External Amplifier System volume control
6. Press **(ACTION)** twice to exit menus.

Lock Features

Lock Game Guard

Prevents video games and other video sources from being viewed. Channel 3, 4 and video inputs are locked out for 12, 24 or 48 hours. **NOTE:** Be sure to understand this feature before attempting its use. **Use a code that you will easily remember or write the code on a piece of paper.**

1. Press **(ACTION)**.
2. Press **CH** or **CH** and **VOL** or **VOL** to highlight the Lock icon.
3. Press **(ACTION)** to display the Lock Menu.

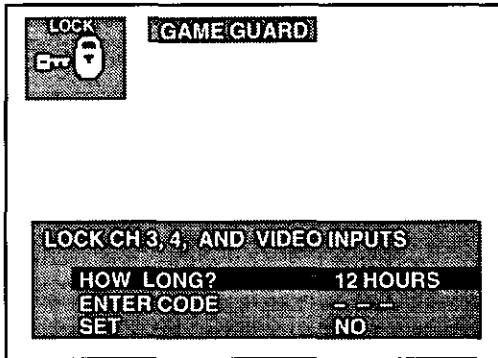

4. "HOW LONG" should already be highlighted. Press **VOL** to select the desired amount of time (12, 24 or 48 hours) for Game Guard Lockout to be activated.
5. Press **CH** to highlight ENTER CODE. Then enter a 3 digit code with the Remote Control Keypad. "SET" should be highlighted after entering the last digit. **IMPORTANT NOTE: Use a code you can easily remember or write the code on a piece of paper.**
6. Press **VOL** after entering three digit code. "Game Guard Locked" will display On Screen.



Game Guard Activated

Unlock Game Guard

To unlock the Game Guard feature, repeat steps 1 through 3. Enter the same 3 digit code previously used in step 5 with Remote Control Keypad.

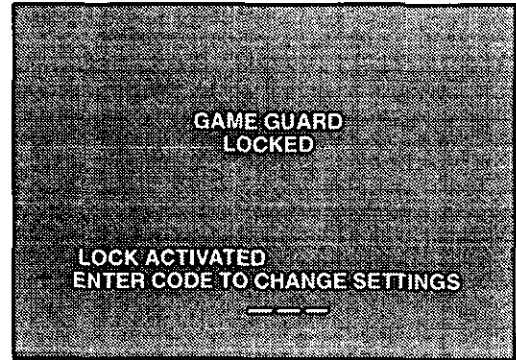

Enter Same 3 Digit Code Previously Used

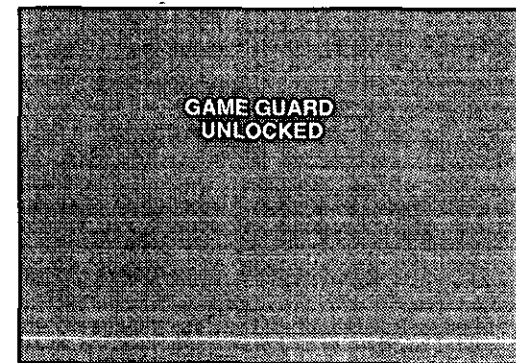

If 3 Digit Code Is The Same

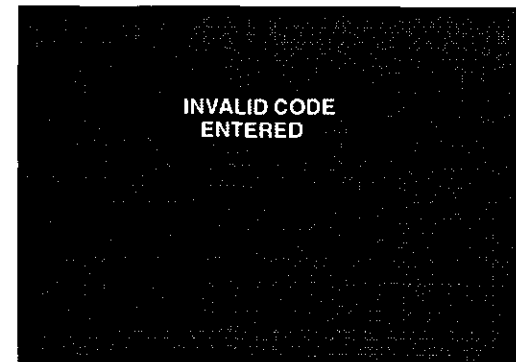

If 3 Digit Code Is Not The Same

Channel Caption

This feature allows you to enter the call names of up to 30 stations into memory (using up to 4 characters for each station). The call name will then display along with the channel number when changing channels or pressing RECALL.

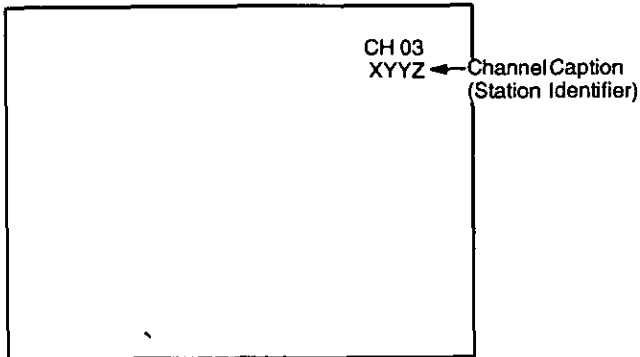

1. Press **ACTION**.
2. Press **CH** or **CH** and **VOL** or **VOL** to highlight the Channel Caption Icon.
3. Press **ACTION** to display the Channel Caption Menu.

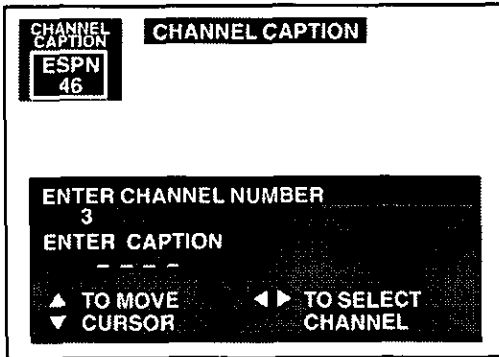

4. Press **VOL** or **VOL**, or use the Remote Control Keypad to enter the channel number you wish to assign a Station Identifier.
5. Press **CH** to highlight ENTER CAPTION.
6. Press **VOL** or **VOL** to select first character in Station Identifier. Then press **CH** to move cursor to the second position and repeat until the complete Station Identifier is entered (up to 4 characters).
7. Press **CH** or **CH** to highlight ENTER CHANNEL NUMBER. Then repeat steps 4 through 6 to continue adding Channel Station Identifier(s).
8. Press **ACTION** twice to exit menus.

NOTE: To delete a Channel Caption (Station Identifier) from memory all four character positions in the "ENTER CAPTION" area must display a dash mark (-).

Helpful Hints:

When the Maximum amount of station identifiers are entered, "FULL" will be displayed in the caption position.

Timer Features

Sleep Timer

This feature is used for automatic turn off in 30, 60 or 90 minutes. Display will flash 3, 2 and 1 to indicate the last three remaining minutes prior to turn off. The Recall display will also appear.

NOTE: This feature will be disabled when Auto Power On is activated.

1. Press **ACTION**.
2. Press **CH** or **CH** and **VOL** or **VOL** to highlight the Timer Icon.
3. Press **ACTION** to display the Timer Control Menu.

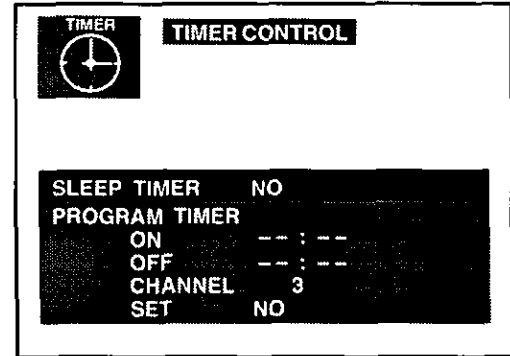

4. Press **VOL** to select NO, 30, 60 or 90 minutes (Sleep Timer will be activated).
5. Press **ACTION** twice to exit menus.

NOTE: To deactivate Sleep Timer repeat steps 1 through 4. In step 4 select "NO" instead of minutes.

Helpful Hints:

Press the RECALL button to display the remaining minutes for Sleep Timer, the status will display in the bottom left corner.

Timer Features (cont.)

Special Feature:

Automatic turn "OFF" after 90 minutes.

The TV has a special feature that will shut itself OFF after 90 minutes when turned ON by the program timer unless a function key is pressed during the 90 minutes.

This feature is useful so that the TV will not remain ON unattended for an extended period of time.

Programming the OFF timer will cancel the automatic OFF Special Feature.

Program Timer

This feature is capable of turning the TV on, tuned to a desired channel and off at a predetermined time (one day or daily). The clock must be set for this feature to operate. (Refer to the Set-Up Menu to set time.)

NOTE: This feature will be disabled when Auto Power On is activated.

1. Press **ACTION**.
2. Press **CH** or **CH** and **VOL** or **VOL** to highlight the Timer Icon.
3. Press **ACTION** to display the Timer Control Menu.

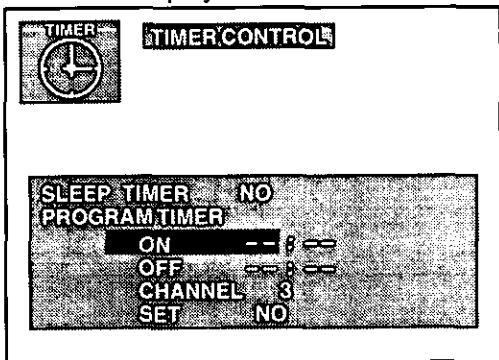

4. Press **CH** to highlight ON (time).
5. Press **VOL** or **VOL** repeatedly to set hours (set AM/PM accordingly).
6. Press **CH** to highlight the minutes position.
7. Press **VOL** or **VOL** repeatedly to set minutes.
8. Press **CH** to highlight OFF (time).

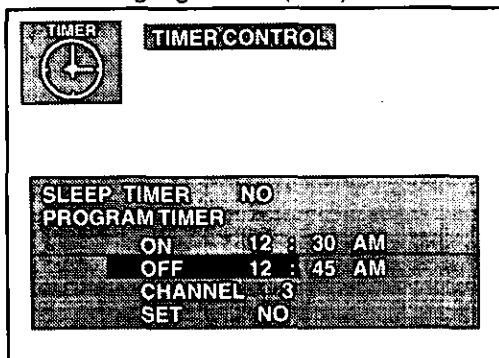

9. Repeat steps 5 through 7 for setting OFF (time).
10. Press **CH** to highlight CHANNEL.

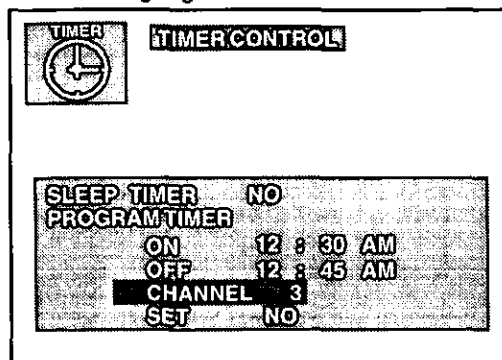

11. Press **VOL** or **VOL** or use the Remote Control Keypad to enter the channel number desired when the set turns "ON".
12. Press **CH** to highlight SET.

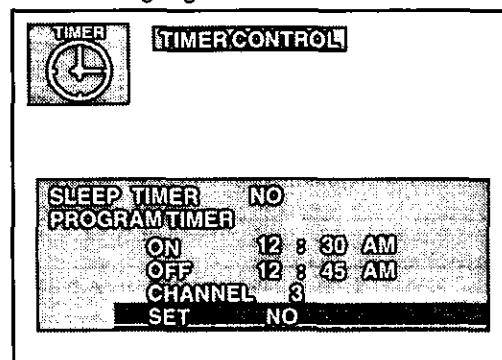

13. Press **VOL** to select:
 - NO – not activated
 - ONE DAY – activated
 - DAILY – activated
 14. Press **ACTION** twice to exit menus.
- NOTE: To deactivate Program Timer select NO in step 13.**

Helpful Hints:







- If the Program Timer "ON" functions while the set is operating, the set will automatically tune to the channel designated in the Timer Program.

Set-Up Features





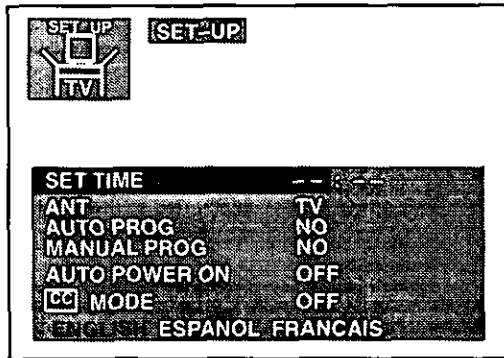

Set Time

Clock (when set) will display on screen at initial "Turn On", after a channel change and when pressing the RECALL button. The time must be set first in order to operate the Program ON/OFF Timer.

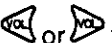
NOTE: This feature will be disabled when Auto Power On is activated.

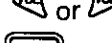
1. Press .
2. Press  or  and  or  to highlight the Set-Up Icon.
3. Press  to display the Set-Up Menu.









4. Press  or  to set hours (set AM/PM accordingly).
5. Press  to select minutes position.
6. Press  or  repeatedly to set minutes.
7. Press  twice to exit menus.

Antenna (Ant)





The proper Input mode must be selected for the type of signal at the antenna input.

- TV mode is used when the Receiver is not connected to a cable TV system, for example when using a VHF/UHF antenna (channels 02 – 69).
- Cable mode is used when the Receiver is connected to a Cable TV system and you are not using a cable company converter box (channels 01 – 125).

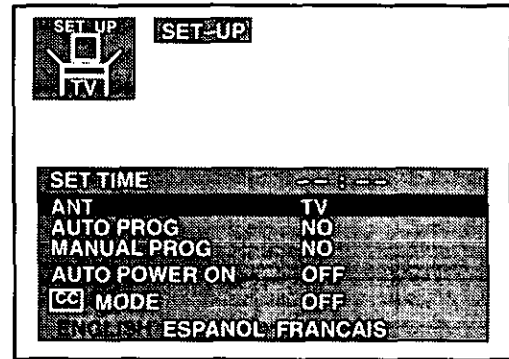
NOTE: This feature is disabled when Game Guard Lock is activated.

1. Press .
2. Press  or  and  or  to highlight the Set-Up Icon.
3. Press  to display the Set-Up Menu.









4. Press  to highlight ANT.
5. Press  or  to select TV or CABLE.
6. Press  twice to exit menus.





Auto Prog

This feature allows you to place all channels with a video signal into Channel Scan Memory.

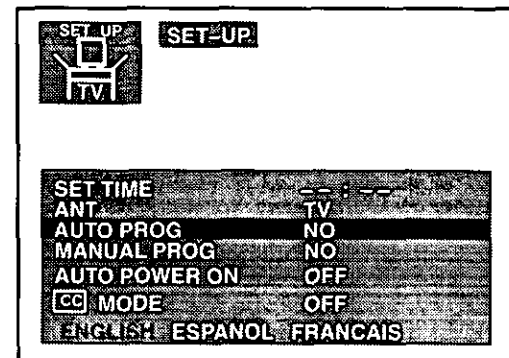
NOTE: This feature is disabled when Game Guard Lock is activated.

1. Press .
2. Press  or  and  or  to highlight the Set-Up Icon.
3. Press  to display the Set-Up Menu.



4. Press  to highlight AUTO PROG.
5. Press  or  to start Auto Programming. Channels will automatically advance until all channels have been scanned.
6. Press  twice after completion of Auto Programming to exit menus.

NOTE: Channel numbers with signal present will turn blue which indicates stored in Channel Scan Memory.

Set-Up Features (cont.)

Manual Prog

This feature allows you to select which channels are placed into Channel Scan Memory.

1. Press **(ACTION)**.
2. Press **CH** or **CH** and **VOL** or **VOL** to highlight the Set-Up Icon.
3. Press **(ACTION)** to display the Set-Up Menu.

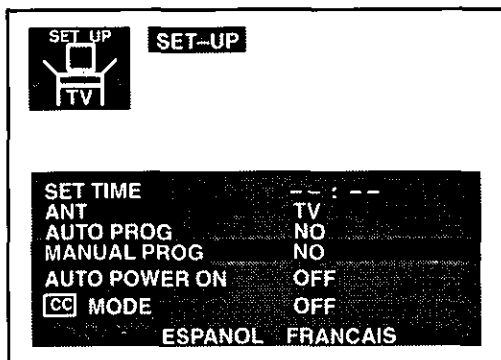

4. Press **CH** to highlight MANUAL PROG.
5. Press **VOL** or **VOL** to display the Manual Programming Menu.

NOTE: This feature is disabled when Game Guard Lock is activated.

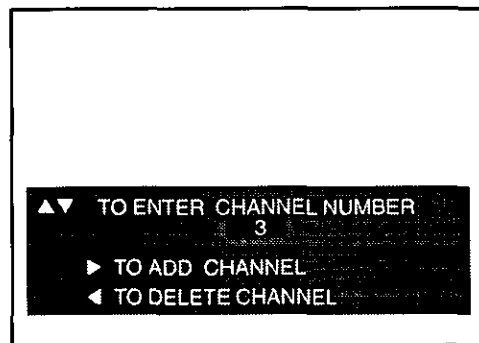

6. Use the **CH** or **CH** or the Remote Keypad "0 through 9" buttons to select channels.
7. Press **VOL** to **add** channel(s) to memory (Blue). Press **VOL** to **delete** channels from memory (Yellow).
8. Repeat steps 6 and 7 to continue adding or deleting channels.
9. Press **(ACTION)** twice to exit menus.

Auto Power On

This feature allows the user to power up the TV at the same time as the cable box (or other components). The TV must be plugged into the cable box switched outlet.

NOTE: When this feature is activated (on), Timer features will be disabled and will reset.

1. Press **(ACTION)**.

2. Press **CH** or **CH** and **VOL** or **VOL** to highlight the Set-Up Icon.
3. Press **(ACTION)** to display the Set-Up Menu.

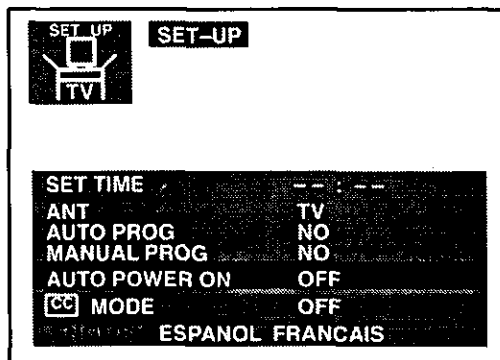

4. Press **CH** to highlight AUTO POWER ON.
5. Press **VOL** or **VOL** to select SET or OFF.
6. Press **(ACTION)** twice to exit menus.

CC (Closed Caption) Mode

This Receiver has a built in decoder that provides a visual depiction of the audio portion of a television program, in the form of written words across the screen (White or Colored letters on a black background). It allows the viewer to read the dialogue of a television program or other information.

When the Closed Caption is in the OFF Mode:
The viewer may display closed caption by pressing **(MUTE)** on the remote control. Press again to delete.

1. Press **(ACTION)**.
2. Press **CH** or **CH** and **VOL** or **VOL** to highlight the Set-Up Icon.
3. Press **(ACTION)** to display the Set-Up Menu.

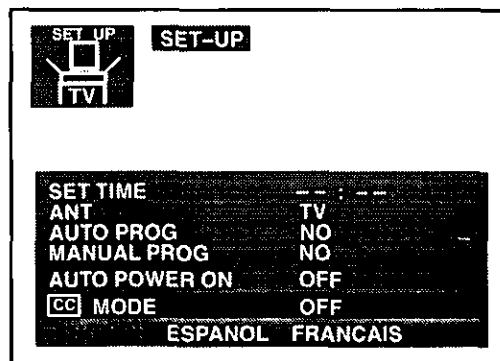

4. Press **CH** to highlight CC MODE.
5. Press **VOL** to select OFF, C1, or C2.
6. Press **(ACTION)** twice to exit menus.



Programming The Universal Remote Control (for CT-3268S)

VCR

Preferred Procedure – Code Known Programming Universal Remote Using Infrared Access Codes for VCRs

- Determine brand of VCR.
- Identify code(s) associated with the brand in the infrared code index for VCRs (located in this manual).

Procedure

1. Place the Remote  into the VCR position.
2. Press and hold  down on Universal Remote.
3. Enter two digit code using keypad “0 through 9” buttons.



Release  The Universal Remote is now programmed.

NOTE: Some brands have multiple codes. Repeat procedure using each code listed until VCR responds correctly.



Alternate Procedure – Code Unknown Programming Universal Remote Using the “Sequence Method” for VCRs

- Confirm VCR is plugged in and operating properly, then turn OFF.

Procedure

1. Place the Remote  into the VCR position.
2. Press and hold the  down on Universal Remote.
3. Press  repeatedly. Check for the VCR to turn ON after each press. When the VCR turns ON, release VCR Power button. The proper infrared code has now been accessed.

NOTES:

1. It may take several attempts before the correct code is found.
2. The  can be used to return to a code that was accidentally passed by.
3. Some Remote Controls may have unique operating functions for some buttons. For Example: The POWER button may only turn the VCR OFF as opposed to both ON and OFF. It will then be necessary to modify the procedure. Turn the VCR ON and repeatedly press the  until the VCR turns OFF.



NOTE: When operating equipment (VCR or Cable box) with the Universal Remote Control, the TV/VCR/CABLE Switch should be set to the same position where the Access Code was first programmed for the equipment. Otherwise, leave the switch in the TV position.



Cable Box

Preferred Procedure – Code Known Programming Universal Remote Using Infrared Access Codes for Cable Boxes

- Determine brand of Cable box.
- Identify code(s) associated with the brand in the infrared code index for Cable boxes (located in this manual).

Procedure

1. Place the Remote  into the CABLE position.
2. Press and hold the  down on Universal Remote.
3. Enter two digit code using keypad “0 through 9” buttons.



Release  The Universal Remote is now programmed. Use the Remote  and  for selecting Cable Box channels.

NOTE: Some brands have multiple codes. Repeat procedure using each code listed until Cable box responds correctly.



Alternate Procedure – Code Unknown Programming Universal Remote Using the “Sequence Method” for Cable Boxes

- Confirm Cable box is plugged in and operating properly, then turn OFF.

Procedure

1. Place the Remote  into the CABLE position.
2. Press and hold  down on Universal Remote.
3. Press  repeatedly. Check for the Cable box to turn ON after each press. When the Cable box turns ON, release Cable Power button. The proper infrared code has now been accessed.

NOTES:

- It may take several attempts before the correct code is found.
- The  can be used to return to a code that was accidentally passed by.
- Some Remote Controls may have unique operating functions for some buttons. For Example: The POWER button may only turn the Cable box OFF as opposed to both ON and OFF. It will then be necessary to modify the procedure. Turn the Cable box ON and repeatedly press the  until the Cable box turns OFF.

VCR and Cable Box Infrared Codes Index

(for CT-3268S)

The Universal infrared Remote Control is capable of operating many brands of VCRs and Cable Boxes after entering the proper infrared code.

NOTE: The Universal Remote Control memory is limited. Some models of VCRs or Cable Boxes may not operate. The Universal Remote Control is not designed to control all features that are available in all models.

Code Index for VCRs			
Brand of VCR	Code(s)	Brand of VCR	Code(s)
Audio Dynamics	14, 16	NEC	02, 14, 16, 30
Broksonic	10	Panasonic	00, 01
Canon	00, 01	Pentax	05
Capehart	01	Philco	00, 29
Citizen	09	Philips	00, 29
Craig	12	Pioneer	05
Curtis Mathes	00, 08, 15	Quasar	00, 01
DBX	14, 16	RCA	05, 07, 08, 28, 35
Emerson	10, 20, 34, 35, 36, 37	Realistic	00, 02, 06, 12, 15
Fisher	12, 18, 19	Samsung	07, 32
Funai	15	Sanyo	02, 12
GE	00, 07, 08, 32	Scott	04, 13, 33, 36
Goldstar	09	Sears	02, 05, 18, 19
Hitachi	05, 35, 36	Sharp	06, 24
Instant Replay	00	Sony	17, 26, 33, 34
JC Penney	00, 02, 05, 14, 16, 30	Sylvania	00, 29
JVC	02, 14, 16, 30	Symphonic	15
Kenwood	02, 14, 16, 30	Tashiko	09
Magnavox	00, 29	Tatung	30
Marantz	02, 14, 16, 29, 30	Teac	15, 30
Marta	09	Teknika	21
Memorex	00, 12	Toshiba	05, 13
MGA	04, 27	Vector Research	14, 16
Minolta	05	Video Concepts	14, 16
Mitsubishi	04, 27	Wards	06
Montgomery Ward	06	Yamaha	02, 14, 16, 30
Multitech	07, 15, 32	Zenith	11, 17

Code Index for Cable Box			
Brand of Cable Box	Code(s)	Brand of Cable Box	Code(s)
G.I.	04, 05, 15, 23, 24, 25, 30, 36	Pioneer	18, 20
Hamlin	12, 13, 34	RCA	27
Jerrold	04, 05, 15, 23, 24, 25, 30, 36	Regency	02
Macom	27	Scientific Atlantic	03, 22
Magnavox	19, 26, 28, 29, 32, 33, 40, 41	Sylvania	11
Oak	14, 16, 18	Texscan	10, 11
Oak Sigma	16	Tocom	17, 21
Panasonic	27, 39	Unika	31
Philips	19, 26, 28, 29, 32, 33, 40, 41	Viewstar	19, 26, 28, 29, 32, 33, 40, 41
		Zenith	01, 42

Programming the Home Theater Remote (for CT-32S21)

The remote control can be set to control other manufacturers components, by utilizing the **MODE SELECTION BUTTONS** for **CABLE**, **DSS**, **VCR**, **RCVR** (a Receiver or Amplifier), **CD**, **LD**, and **AUX** (for Cassette Players, Second VCR or a DVD.)

Code Known

Use the following procedure for setting up the remote control using the numerical buttons when the component's remote code is known.

- 1 Determine the brand of the component.
- 2 Identify the code(s) associated with the brand from the infrared code index (see following pages). Record all possible codes.
- 3 Confirm that the component is plugged in and operating properly, then turn it OFF.
- 4 Press and hold the **ACT** button, then the **POWER** button so that both are pressed at the same time for at least 5 seconds. All Mode buttons will flash. Then let go of the buttons.
- 5 Press the appropriate Mode button for the component. The pressed button will illuminate steadily. All other buttons will go out.
- 6 Enter the 3-digit code, by using the Remote Control Keypad "0" through "9" buttons. If a proper code was entered, the Mode button will blink twice then go out.

Now the remote is set for the entered code.

- 7 Press the **POWER** button to test the remote. If the correct code is setup for the component (in step 6), the component will turn on.

NOTE: Some brands have multiple codes. Repeat the procedure using another listed code until the component responds correctly.

Code Unknown

Use the following procedure for setting up the remote control when the component's remote access code is not known. This procedure uses the "sequence method".

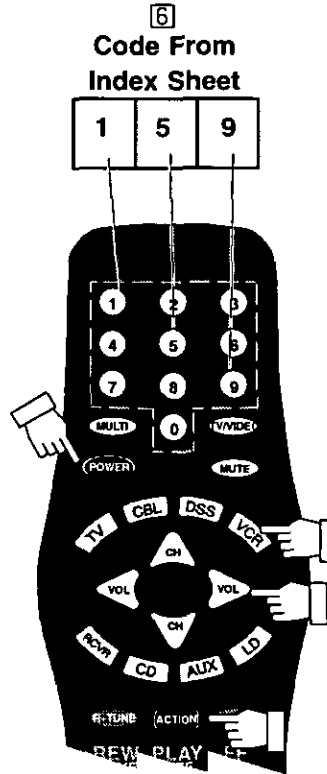

EUR511060

- 1 Confirm that the component is plugged in and operating properly, then turn it OFF.
- 2 Press and hold the **ACT** button, then the **POWER** button so that both are pressed at the same time for at least 5 seconds. All Mode buttons will flash. Then let go of the buttons.
- 3 Press the appropriate Mode button for the device. The pressed button will illuminate steadily. All other buttons will go out.
- 4 Press the **VOL** button to step over to the next code.
- 5 Press the **POWER** button to test the remote. If the correct code is sent, the component will turn on.
- 6 Once the correct code is found, press the **ACT** button to store the code.
- 7 Repeat from step 3 above until the proper component code is found. It may take several attempts before the correct code is found.

NOTE: If an incorrect code is entered, or when the operation is not completed within 30 seconds, the settings will not change.

Infrared Remote Codes for Specific Components

Helpful Hint: Write down the code numbers for your components in the space provided below. This will serve as a handy reference whenever you need to reprogram your remote control.

CABLE Cable TV Converter Box	VCR Video Cassette Recorder	CD Compact Disc Player
DSS Digital Satellite System	RCVR Receiver or Amplifier	LD Laser Disc Player
Other Component	Other Component	Other Component
Other Component	Other Component	Other Component

VCR Infrared Codes Index (for CT-32S21)

The Universal Infrared Remote Control is capable of operating many brands of VCRs. Refer to the Programming the Remote Control section for procedures.

Note: The Universal Remote Control memory is limited; therefore, some models of VCRs may not operate. The Universal Remote Control is not designed to control all features that are available in all models.

Note: After entering the proper infrared code, press the Remote **VCR (*)** Selection Mode button. **A second VCR can be activated** using the same codes, from **AUX (**)** Selection Mode button. Then refer to the Remote Control Key Functions section, for Remote VCR and VCR 2 function key listing.

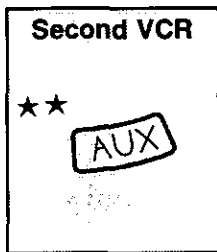
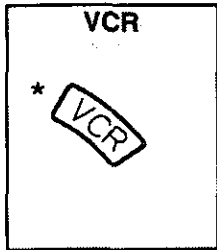

Code Index for VCRs			
VCR Brand	Code(s)	VCR Brand	Code(s)
Admiral	200	Pentax	000, 011, 300
Aiwa	137, 160	Philco	081, 125, 130, 136, 137, 150
Akai	014, 015, 016, 142	Philips	125, 130, 150
Audio Dynamic	011, 240	Pioneer	125
Bell & Howell	005, 013	Proscan	000, 001, 002, 125, 130, 150, 300, 310
Broksonic	081, 136	Quasar	100, 101, 125, 130
Canon	125, 135	Radio Shack	005, 009, 130, 137, 170, 210, 241
Citizen	006	RCA	000, 001, 002, 125, 130, 150, 170, 300, 310
Craig	005, 006, 141	Realistic	005, 009, 130, 137, 210, 241
Curtis Mathes	130, 137, 300	Samsung	002, 004, 220
Daewoo	001, 130, 250	Sansui	081, 136, 240
DBX	010, 011, 240	Sanyo	005, 009
Dimensia	300	Scott	001, 002, 004, 009, 081, 136, 230, 241, 330, 340
Emerson	003, 051, 080, 081, 135, 136, 243, 250	Sears	000, 005, 006, 007, 008,
Fisher	005, 007, 008, 009	Shaintom	050
Funai	081, 136, 137	Sharp	200, 210
GE	130, 170, 300	Signature 2000	137, 200
Goldstar	006	Singer	050
Go Video	220	Sony	140, 141, 142
Hitachi	000, 125, 300,	SV2000	137
Instant Replay	125, 130,	Sylvania	125, 130, 137, 150
Jensen	240	Symphonic	137
JVC	010, 011, 190, 240	Tashiro	006
Kenwood	006, 010, 011, 240	Tatung	010, 011, 240
LXI	000, 005, 006, 007, 008, 009, 137	Teac	010, 011, 137, 240
Magnavox	025, 130, 150	Technics	100, 101, 125, 130
Marantz	010, 011, 240	Teknika	130, 137
Marta	006	Toshiba	001, 310
Memorex	009, 130	Vector Research	011
MGA	230, 241, 242, 243, 330, 340	Wards	006, 009, 200, 210, 290
Minolta	000, 300	Yamaha	005, 010, 011, 240
Mitsubishi	230, 241, 242, 243, 330, 340	Zenith	290
Multitech	004, 137, 330		
NEC	010, 011, 190, 240		
Olympic	125, 130		
Optimus	006, 200, 100, 140		
Orion	081, 136		
Panasonic	100, 101, 125, 130		
Penney	000, 005, 010, 011, 130, 240, 300		

Cable Box and CD Players

Infrared Codes Index (for CT-32S21)

The Universal Infrared Remote Control is capable of operating many brands of Cable Boxes and CD Players. Refer to the Programming the Remote Control section for procedures.

Note: The Universal Remote Control memory is limited; therefore, some models of Cable Boxes and CD Players may not operate. The Universal Remote Control is not designed to control all features that are available in all models.

Note: After entering the proper infrared code, press the Remote **CBL** Selection Mode button (☆). Then refer to the Remote Control Key Functions section, for Remote CBL function key listing.

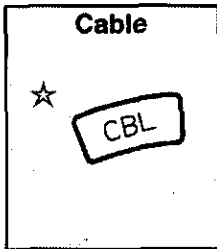

Codes for Cable Box			
Brand of Cable Box	Code(s)	Brand of Cable Box	Code(s)
ABC	530	Philips	006, 007, 540, 541, 542
Archer	531, 544	Pioneer	001, 260
Cableview	005, 544	Pulsar	005, 544
Citizen	005, 522	Puser	544
Curtis	130, 131	RCA	170, 220
Diamond	530, 531, 544	Realistic	544
Eagle	541	Regal	130, 350, 720, 730, 731, 900
Eastern	560	Regency	560
Gcbrand	005, 544	Rembrandt	005, 544, 702
Gemini	522	Samsung	005
General Instrument	122, 360, 520, 521, 522, 530, 531, 532, 533	Scientific Atlanta	122, 130, 131
Hamlin	130, 350, 720, 730, 731, 900	Slmark	001, 005
Hitachi	003, 530	Sprucer	005, 121
Jerrold	122, 360, 520, 521, 522, 530, 531, 532, 533	Stargate	005, 544
Macom	003, 004, 005	Television	001, 005
Memorex	542	Texscan	810
Movietime	005, 544	Tocom	700, 701
Oak	002, 702, 710	Toshiba	004
Panasonic	120, 121, 132	Unika	531, 544
Paragon	281	Universal	522, 544
		Videoway	006
		Viewstar	541, 542
		Zenith	000, 280, 281
		Zenith/DrakeSatellite	000

Note: After entering the proper infrared code, press the Remote **CD** Selection Mode button (☆☆). Then refer to the Remote Control Key Functions section, for Remote CD Players function key listing.

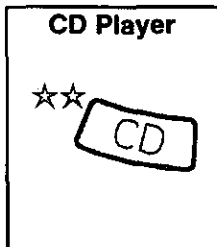

Codes for CD Players			
Brand of CD Players	Code(s)	Brand of CD Players	Code(s)
Admiral	110	Optimus	030, 057, 059, 061
Aiwa	162, 164	Panasonic	100, 101, 130
Carver	150, 151	Philips	150, 151
Denon	200	Pioneer	030
Emerson	172	Quasar	100, 101, 130
Fisher	005	RCA	160, 170, 171, 500
Garrard	057	Sansui	032, 050, 320
Harman/Kardon	059, 060	Sanyo	005
Hitachi	007	Scott	032, 050, 320
Jensen	163	Sharp	200, 201
JVC	190, 191, 270	Sherwood	059
Kardon	058	Sony	140
Kenwood	000, 001, 050, 270	Soundesigh	220
LXI	165	Teac	051, 055, 057
Magnavox	150, 161	Technics	100, 101, 130
Marantz	151	Victor	190, 191, 270
McIntosh	060	Yamaha	002, 003, 004
Nakamichi	032		
Onkyo	053, 054		

Cassette Deck, Receivers, and Amplifiers

Infrared Codes Index (for CT-32S21)

The Universal Infrared Remote Control is capable of operating many brands of Cassette Deck, Receivers, or Amplifiers. Refer to the Programming the Remote Control section for procedures.

Note: The Universal Remote Control memory is limited; therefore, some models of Cassette Deck, Receivers, and Amplifiers may not operate. The Universal Remote Control is not designed to control all features that are available in all models.

Note: After entering the proper infrared code, press the Remote **AUX** Selection Mode button (*). Then refer to the Remote Control Key Functions section, for Remote Cassette Deck function key listing.

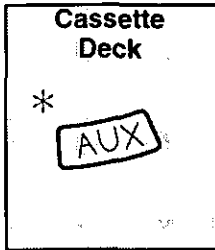

Code Index for Cassette Deck			
Brand of Cassette Deck	Code(s)	Brand of Cassette Deck	Code(s)
Aiwa	760, 761, 762	Philips	751
Denon	800	Pioneer	630
Fisher	603	RCA	763, 770, 771
Jensen	657	Sansui	631, 653
JVC	780, 781	Sharp	800
Kenwood	600, 650	Sony	740
Marantz	751	Teac	653, 654
Nakamichi	631	Technics	700, 701, 730
Onkyo	651, 652, 656	Yamaha	601, 602
Panasonic	700, 701, 730		

Note: After entering the proper infrared code, press the Remote **RCVR** Selection Mode button (**). Then refer to the Remote Control Key Functions section, for Remote Receivers/Amplifiers function key listing.

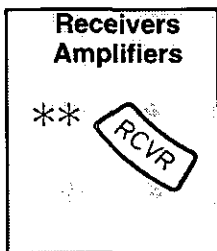

Code Index for Receivers and Amplifiers			
Brand of Receiver / Amplifier	Code(s)	Brand of Receiver / Amplifier	Code(s)
Admiral	110	Panasonic	100, 101, 130
Aiwa	160, 161	Philips	150
Denon	200, 201, 202	Pioneer	030, 032
Fisher	004	Quasar	100, 101, 130
Garrard	055	RCA	003, 130, 162, 170, 171
Harman	150, 057	Sansui	003, 053, 320
Jensen	164	Sharp	200, 203
JVC	190, 191	Sony	140
Kenwood	000, 050	Soundesign	220
Magnavox	162	Teac	053, 054, 055
Marantz	151	Technics	100, 101, 130
McIntosh	058	Victor	190, 191
Nakamichi	031	Yamaha	001, 002
Onkyo	151, 156		
Optimus	003, 162, 170, 171		

Laser Disc, DSS (Digital Satellite System), and DVD (Digital Videodisc) Infrared Codes Index (for CT-32S21)

The Universal Infrared Remote Control is capable of operating selected brands of Laser Disc, DSS Digital Satellite System, and DVD (Digital Videodisc). Refer to the Programming the Remote Control section for procedures.

Note: The Universal Remote Control memory is limited; therefore, some models of Laser Disc, DSS Digital Satellite System, and DVD (Digital Videodisc) may not operate. The Universal Remote Control is not designed to control all features that are available in all models.

Note: After entering the proper infrared code, press the Remote LD Selection Mode button (◇). Then refer to the Remote Control Key Functions section, for Remote Laser Disc function key listing.



Codes for Laser Disc			
Brand of Laser Disc	Code(s)	Brand of Laser Disc	Code(s)
Denon	370	Quasar	100, 101, 135, 380
Hitachi	000	RCA	370
Kenwood	002, 003	Samsung	160
Marantz	370	Sanyo	370
Mitsubishi	370	Sharp	200
NEC	370	Sony	140, 141, 142, 143
Panasonic	100, 101, 135, 380	Teac	370
Phillips	150	Toshiba	370
Pioneer	370	Yamaha	001
Proscan	370		

Note: After entering the proper infrared code, press the Remote DSS Selection Mode button (◇◇). Then refer to the Remote Control Key Functions section, for Remote DSS function key listing.

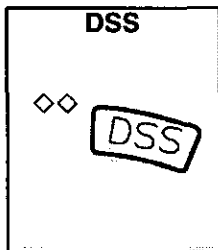

Codes for DSS (Digital Satellite System)	
Brand of Satellite	Code(s)
GE	170
Panasonic	100
RCA	170
Sony	390



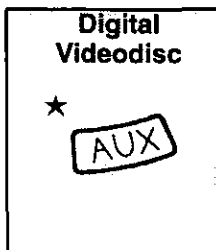













Note: After entering the proper infrared code, press the Remote AUX Selection Mode button (★). Then refer to the Remote Control Key Functions section, for Remote DVD function key listing.

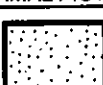

Codes for DVD (Digital Videodisc)	
Brand of DVD	Code(s)
Panasonic	102

Troubleshooting Chart

Before you call for service, determine the symptoms and make a few simple checks shown below.

Symptoms		Check
Picture	Sound	
 SNOWY PICTURE	 NOISY SOUND	<ul style="list-style-type: none"> - ANTENNA LOCATION AND/OR CONNECTION
 MULTIPLE IMAGE	 NOISY SOUND	<ul style="list-style-type: none"> - ANTENNA DIRECTION AND/OR LOCATION - ANTENNA LEAD-IN WIRE
 INTERFERENCE	 NOISY SOUND	<ul style="list-style-type: none"> - ELECTRICAL APPLIANCES, LIGHTS, CARS AND TRUCKS - DIATHERMY AND OTHER MEDICAL EQUIPMENT
 NORMAL PICTURE	 NO SOUND	<ul style="list-style-type: none"> - VOLUME CONTROL SETTING - MUTE CONTROL (IF APPLICABLE) - TRY ANOTHER CHANNEL - TV SPEAKERS SWITCH (IF APPLICABLE) IN THE OFF POSITION
 NO VIDEO	 NOISY SOUND	<ul style="list-style-type: none"> - TV OR CABLE TUNING MODE SET TO PROPER SETTING - ANTENNA INPUT CORRECT (IF APPLICABLE)
 NO PICTURE	 NO SOUND	<ul style="list-style-type: none"> - CHECK THAT AC POWER LINE IS PLUGGED INTO AC OUTLET - BRIGHTNESS & AUDIO CONTROLS SET PROPERLY - TRY ANOTHER CHANNEL
 NO COLOR	 NORMAL SOUND	<ul style="list-style-type: none"> - COLOR CONTROL SETTINGS - TRY ANOTHER CHANNEL
 BLACK PICTURE	 NO SOUND	<ul style="list-style-type: none"> - RECEIVER IN VIDEO MODE WITH NO SIGNAL

**Panasonic Consumer Electronics
Company, Division of Matsushita
Electric Corporation of America**
One Panasonic Way
Secaucus, New Jersey 07094

**Panasonic Sales Company,
Division of Matsushita Electric
of Puerto Rico Inc. ("PSC")**
Ave. 65 de Infanteria, Km 9.5
San Gabriel Industrial Park
Carolina, Puerto Rico 00985
Tel. (787) 750-4300
FAX. (787) 768-2910

Panasonic Canada Inc.
5770 Ambler Drive
Mississauga, Ontario L4W 2T3
Canada

Free Manuals Download Website

<http://myh66.com>

<http://usermanuals.us>

<http://www.somanuals.com>

<http://www.4manuals.cc>

<http://www.manual-lib.com>

<http://www.404manual.com>

<http://www.luxmanual.com>

<http://aubethermostatmanual.com>

Golf course search by state

<http://golfingnear.com>

Email search by domain

<http://emailbydomain.com>

Auto manuals search

<http://auto.somanuals.com>

TV manuals search

<http://tv.somanuals.com>