

Service Manual

Color Television

Main Manual (NA8ML)



Panasonic

Models	Chassis
CT-32SX31E	BP371
CT-32SX31UE	BP371
CT-32SX31CE	BP371
CT-36SX31E	BP372
CT-36SX31UE	BP372
CT-36SX31CE	BP372

This Service manual is issued as a service guide for the models of the **NA8ML** family listed above. Included in this manual are a set of schematic, block diagrams, functional descriptions, alignment procedures, disassembly procedures and a complete parts list.

WARNING! This Service Manual is designed for experienced repair technicians only and is not designed for use by the general public. It does not contain warnings or cautions to advise non-technical individuals of potential dangers in attempting to service a product. **Products powered by electricity should be serviced or repaired only by experienced professional technicians.** Any attempt to service or repair the product or products dealt with in this Service Manual by anyone else could result in serious injury or death."

The service technician is required to read and follow the "**Safety Precautions**" and "**Important Safety Notice**" in this Main Manual.

Panasonic®

Copyright 2001 by Matsushita Electric Corporation of America. All rights reserved. Unauthorized copying and distribution is a violation of law.

Important Safety Notice

Special components are used in this television set which are important for safety. These parts are identified on the schematic diagram by the symbol  and printed in **BOLD TYPE** on the replacement part list. It is essential that these critical parts are replaced with the manufacturer's specified replacement part to prevent X-ray radiation, shock, fire or other hazards. Do not modify the original design without the manufacturer's permission.

Safety Precautions

General Guidelines

An **Isolation Transformer** should always be used during the servicing of a receiver whose chassis is not isolated from AC power line. Use a transformer of adequate power rating as this protects the technician from accidents resulting in personal injury from electrical shocks. It will also protect the Receiver from being damaged by accidental shorting that may occur during servicing.

When servicing, observe the original lead dress, especially in the high voltage circuit. Replace all damaged parts (also parts that show signs of overheating.)

Always Replace Protective Devices, such as fishpaper, isolation resistors and capacitors, and shields after servicing the Receiver. Use only manufacturer's recommended rating for fuses, circuits breakers, etc.

High potentials are present when this Receiver is operating. Operation of the Receiver without the rear cover introduces danger for electrical shock. Servicing should not be performed by anyone who is not thoroughly familiar with the necessary precautions when servicing high-voltage equipment.

Extreme care should be practiced when **Handling the Picture Tube**. Rough handling may cause it to implode due to atmospheric pressure. (14.7 lbs per sq. in.). Do not nick or scratch the glass or subject it to any undue pressure. When handling, use safety goggles and heavy gloves for protection. **Discharge the picture tube** by shorting the anode to chassis ground (not to the cabinet or to other mounting hardware). When discharging connect cold ground (i.e. dag ground lead) to the anode with a well insulated wire or use a grounding probe.

Avoid prolonged exposure at close range to unshielded areas of the picture tube to prevent exposure to X-ray radiation.

The **Test Picture Tube** used for servicing the chassis at the bench should incorporate safety glass and magnetic shielding. The safety glass provide shielding for the tube viewing area against X-ray radiation as well as implosion. The magnetic shield limits the X-ray radiation around the bell of the picture tube in addition to the restricting magnetic effects. When using a picture tube test jig for service, ensure that the jig is capable of handling **40kV** without causing X-ray radiation.

Before returning a serviced receiver to the owner, the service technician must thoroughly test the unit to ensure that is completely safe to operate. **Do not use a line isolation transformer when testing.**

Leakage Current Cold Check

Unplug the AC cord and connect a jumper between the two plug prongs.

Measure the resistance between the jumpered AC plug and expose metallic parts such as screwheads, antenna terminals, control shafts, etc. If the exposed

metallic part has a return path to the chassis, the reading should be between 240k Ω and 5.2M Ω . If the exposed metallic part does not have a return path to the chassis, the reading should be infinite.

Leakage Current Hot Check (Fig. 1)

Plug the AC cord directly into the AC outlet. Do not use an isolation transformer during the check.

Connect a 1.5k Ω 10 watt resistor in parallel with a 0.15 μ F capacitor between an exposed metallic part and ground. Use earth ground, for example a water pipe.

Using a DVM with a 1000 ohms/volt sensitivity or higher, measure the AC potential across the resistor.

Repeat the procedure and measure the voltage present with all other exposed metallic parts.

Verify that any potential does not exceed 0.75 volt RMS. A leakage current tester (such a Simpson Model 229, Sencore Model PR57 or equivalent) may be used in the above procedure, in which case any current measure must not exceed 0.5 milliamp. If any measurement is out of the specified limits, there is a possibility of a shock hazard and the Receiver must be repaired and rechecked before it is returned to the customer.

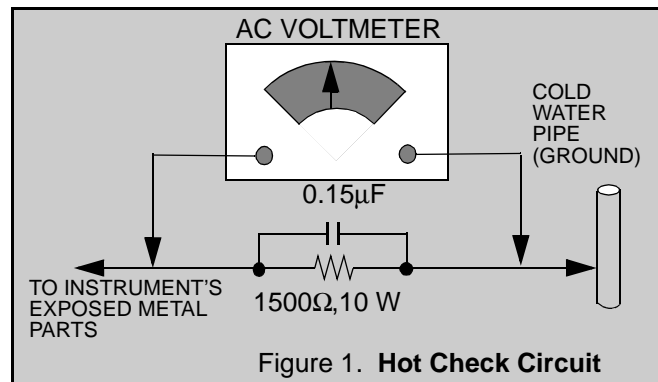

X-ray Radiation

WARNING: The potential source of X-ray radiation in the TV set is in the High Voltage section and the picture tube.

Note: It is important to use an accurate, calibrated high voltage meter.

Set the **brightness, picture, sharpness** and **color** controls to Minimum. Measure the High Voltage. The high voltage should be **31.0 \pm 1.0kV**. If the upper limit is out of tolerance, immediate service and correction is required to insure safe operation and to prevent the possibility of premature component failure.

Horizontal Oscillator Disable Circuit Test

This test must be performed as a final check before the Receiver is returned to the customer. See **Horizontal Oscillator Disable Circuit Procedure Check** in this manual.

Table of Contents

Important Safety Notice	2	Instructional Flow Chart for Serviceman Mode	24
Safety Precautions	2	Service Adjustments (Electronic Controls)	27
General Guidelines	2	Sub-Contrast Adjustment	27
Leakage Current Cold Check	2	Sub-Brightness (B02)	27
X-ray Radiation	2	Tint/Color Adjustment	27
Horizontal Oscillator		PIP Sub-Contrast Adjustment (P03)	28
Disable Circuit Test	2	Color Temperature Adjustment	28
Service Notes	4	Complete Adjustment	28
Leadless Chip Component		Horizontal Centering (D00)	29
(surface mount)	4	E-W PCC Adjustment (D0C)	29
Component Removal	4	Corner PCC Adjustment (D0B)	29
Chip Component Installation	4	H-Size Adjustment (D0D)	29
How to Replace Flat-IC	4	V-Size and V-Position Adjustment	
Horizontal Oscillator Disable Circuit	5	(D01 & D06)	29
SPECIFICATIONS		V-Linearity Adjustment (D03)	29
Receiver Feature Table	6	V-Correction Adjustment (D02)	30
OPERATION		MTS Circuit Adjustments	30
Location of Controls (Receiver)	7	Input Level Adjustment (M00)	30
Quick Reference Control Operation	7	Stereo Separation Adjustment	
Quick Reference	7	(M01 & M02)	30
Control Operation	7	Clock Adjustment (S07)	31
Location of Controls (Remote)	8	Service Adjustments	
SERVICE		(Mechanical Controls) 31	
Disassembly for Service	9	Focus (part of T551)	31
Back Cover	9	CIRCUITS & BLOCK DIAGRAMS	
A-Board - Main Chassis	9	Audio Signal Path Block Diagram	32
L-Board - CRT Output	9	Video Signal Path Block Diagram	33
Speakers	9	IIC Connection	34
Keyboard Push Button Assembly	9	Description of Connectors	35
Disassembly for CRT Replacement	9	IC101 IN/OUT Pins and Functions (VCJ)	36
CRT Replacement	9	Component Identification	37
Back Cover Removal	11	Parts List	40
Chassis Service Adjustment Procedures	12	FOLDOUTS	
140.0V B+ Voltage Confirmation	12	Schematics, Voltages and waveforms	
Source Voltage Chart	12	L-Board Voltages,	
High Voltage Check	12	PCB & schematics	53
Purity and Convergence Procedure	13	A-Board (Left Portion)	54
When the CRT or the Yoke is Replaced	13	A-Board (Right Portion)	55
Initial Center Static Convergence	14	A-Board PCB	56
Purity Adjustment	14	A-Board Voltages	57
Dynamic Convergence Adjustment	14	D-Board schematics	58
DY(YHC, YV, XV) Adjustment	14	D-Board PCB & voltages	59
Permalloy Convergence Corrector		G-Board schematics	60
Strip (Part No. 0FMK014ZZ)	15	G-Board PCB & voltages	61
DAF Adjustment	15	A-Board Waveforms	62
Serviceman Mode (Electronic Controls) 17			
Exiting the Serviceman Mode	17		
Entering Serviceman			
Mode (Back-Open Method)	23		

Service Notes

Note: These components are affixed with glue. Be careful not to break or damage any foil under the component or at the pins of the ICs when removing. Usually applying heat to the component for a short time while twisting with tweezers will break the component loose.

Leadless Chip Component (surface mount)

Chip components must be replaced with identical chips due to critical foil track spacing. There are no holes in the board to mount standard transistors or diodes. Some chips capacitor or resistor board solder pads may have holes through the board, however the hole diameter limits standard resistor replacement to 1/8 watt. Standard capacitor may also be limited for the same reason. It is recommended that identical components be used.

Chip resistor have a three digit numerical resistance code - 1st and 2nd significant digits and a multiplier. Example: 162 = 1600 or 1.6kΩ resistor, 0 = 0Ω (jumper). Chip capacitors generally do not have the value indicated on the capacitor. The color of the component indicates the general range of the capacitance.

Chip transistors are identified by a two letter code. The first letter indicates the type and the second letter, the grade of transistor.

Chip diodes have a two letter identification code as per the code chart and are a dual diode pack with either common anode or common cathode. Check the parts list for correct diode number.

Component Removal

1. Use solder wick to remove solder from component end caps or terminal.
2. Without pulling up, carefully twist the component with tweezers to break the adhesive.
3. Do not reuse removed leadless or chip components since they are subject to stress fracture during removal.

Chip Component Installation

1. Put a small amount of solder on the board soldering pads.
2. Hold the chip component against the soldering pads with tweezers or with a miniature alligator clip and apply heat to the pad area with a 30 watt iron until solder flows. Do not apply heat for more than 3 seconds.

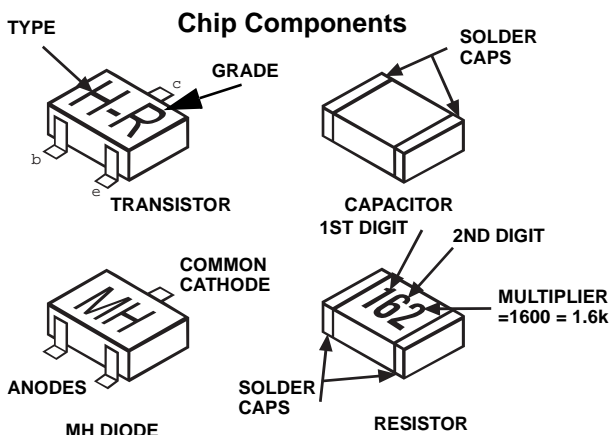

How to Replace Flat-IC

- Required Tools -

- Soldering iron
- De-solder braids
- Iron wire or small awl
- Magnifier

1. Remove the solder from all of the pins of a Flat-IC by using a de-solder braid.

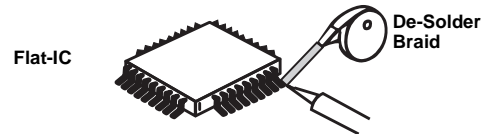

2. Put the iron wire under the pins of the Flat-IC and pull it in the direction indicated while heating the pins using a soldering iron. A small awl can be used instead of the iron wire.

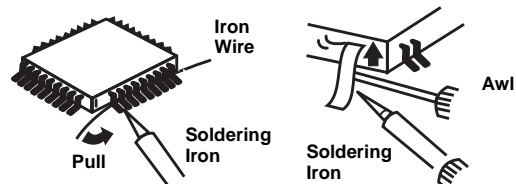

3. Remove the solder from all the pads of the Flat-IC by using a de-solder braid.

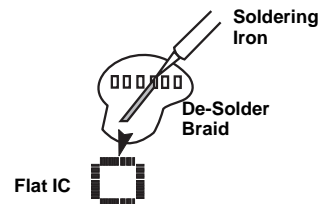

4. Position the new Flat-IC in place (apply the pins of the Flat-IC to the soldering pads where the pins need to be soldered). Properly determine the positions of the soldering pads and pins by correctly aligning the polarity symbol.

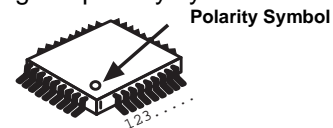

5. Solder all pins to the soldering pads using a fine tipped soldering iron.

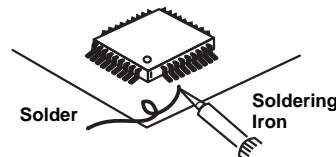

6. Check with a magnifier for solder bridge between the pins or for dry joint between pins and soldering pads. To remove a solder bridge, use a de-solder braid as shown in the figure below.

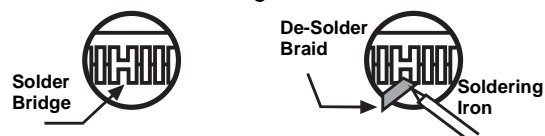

Service Notes (Continued)

IMPORTANT: To protect against possible damage to the solid state devices due to arcing or static discharge, make certain that all ground wires and CTR DAG wire are securely connected.

CAUTION: The power supply circuit is above earth ground and the chassis cannot be polarized. Use an isolation transformer when servicing the Receiver to avoid damage to the test equipment or to the chassis. Connect the test equipment to the proper ground \downarrow () or (\nearrow) when servicing, or incorrect voltages will be measured.

WARNING: This Receiver has been designed to meet or exceed applicable safety and X-ray radiation protection as specified by government agencies and independent testing laboratories.

To maintain original product safety design standards relative to X-ray radiation and shock and fire hazard, parts indicated with the symbol \triangle on the schematic must be replaced with identical parts. Order parts from the manufacturer's parts center using the parts numbers shown in this service manual, or provide the chassis number and the part reference number.

For optimum performance and reliability, all other parts should be replaced with components of identical specification.

Horizontal Oscillator Disable Circuit

This chassis employs a special circuit to protect against excessive high voltage and beam current. If, for any reason, the high voltage and beam current exceed a predetermined level this protective circuit activates and detunes the horizontal oscillator that limits the high voltage. The over-voltage protection circuit is not adjustable. However, if components indicated by the symbol \triangle on the schematic in either the horizontal sweep system or the over-voltage protection circuit itself are changed, the operation of the circuit should be checked using the following procedure:

Equipment needed to check the disabled circuit:

1. DC Ammeter
2. High Voltage Meter (0- 50kV electrostatic)
3. Variac or Isolation Transformer
4. HHS Jig (See Fig. 2)

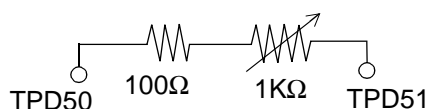

Figure 2. HHS Jig

Preparation

1. Connect Receiver to AC 120 Volts. Do not turn ON.
2. Connect HIGH VOLTAGE meter to 2nd anode (H.V. button). **Note:** Use cold ground(\nearrow) for negative lead.
3. Connect the ammeter serial from the flyback anode lead to the picture tube anode socket.
4. Prepare HHS jig to be connected between TPD50 and TPD51 as shown in Fig. 2.

Procedure:

1. Open Connector A17.
2. Turn power ON and Apply a monoscope pattern.
3. Set current within 50-100 μ A by changing the picture and bright controls.
4. Turn power OFF.
5. Connect HHS jig between **TPD50** and **TPD51** (VR should be turn fully clockwise).
6. Turn power on.
7. Turn slowly the variable resistor to increase the current until the horizontal sync frequency abruptly increases indicating that the horizontal frequency is just beginning to pull out of sync. Maintain the current within 50-100 μ A by changing the picture and bright controls
8. Observe the High Voltage meter. **HIGH VOLTAGE** should read less than **40.2kV**.
9. Turn power OFF, Remove HHS jig, HV meter, ammeter and connect A17 connector.
10. Turn Power ON. Reset Picture and Brightness controls. Confirm **B+ 140V \pm 1.5V** with 120V AC applied.
11. **IF HIGH VOLTAGE IS NOT WITHIN THE SPECIFIED LIMIT THE CAUSE MUST BE DETERMINED BEFORE THE RECEIVER IS RETURNED TO THE OWNER.**

Receiver Feature Table

FEATURE/MODEL	CT-32SX31E/UE/CE	CT-36SX31E/UE/CE
Chassis	NA8ML	
Tuning system	96K	
# of channels	181	
Menu language	Eng/Span/Fr	
Closed Caption	X	
V-Chip (USA/CANADA)	X	
2RF	X	
Remote Model #	EUR511500	
Picture tube	AMEC	
Comb Filter	3 DIG	
VM	X	
V/A norm	X	
Color Temp	X	
MTS/SAP/DBX	X	
BASS/BL/TRE Control	X	
AI Sound	X	
Surround	X	
SPATIALIZER/BBE	BBE	
Built-in audio power	10W/CH (10%)	
# of speakers	2	
A/V in (rear/front)	3(2/1)	
S-VHS Input (rear/front)	1/1	
Component Input (Y,Pb,Pr)	1	
Audio Out (FAO: F, VAO: V)	F,V	
EPJ/HPJ/MISC	HPJ	
Dimensions mm in (WxDxH)	667.3x810x568 26.52x32.4x22.72	747x936x610.5 29.88x37.44x24.42
Weight (kg/lbs)	74.8/164.56	98.5/216.7
Power source (V/Hz)	120/60	
Anode voltage	31.0kV ± 1.0kV	
Video input jack	1V _{p-p} 75Ω, phono jack	
Audio input jack	500mV RMS 47kΩ	
A-Board TNP2AH026	AB	NIL
G-Board TNPA1670	AC	
L-Board TNPA1673	AB	
D-Board TNP2AH027	AB	NIL

Specifications are subject to change without notice or obligation. Dimensions and weights are approximate.

Table 1. Receiver Features

Location of Controls (Receiver)

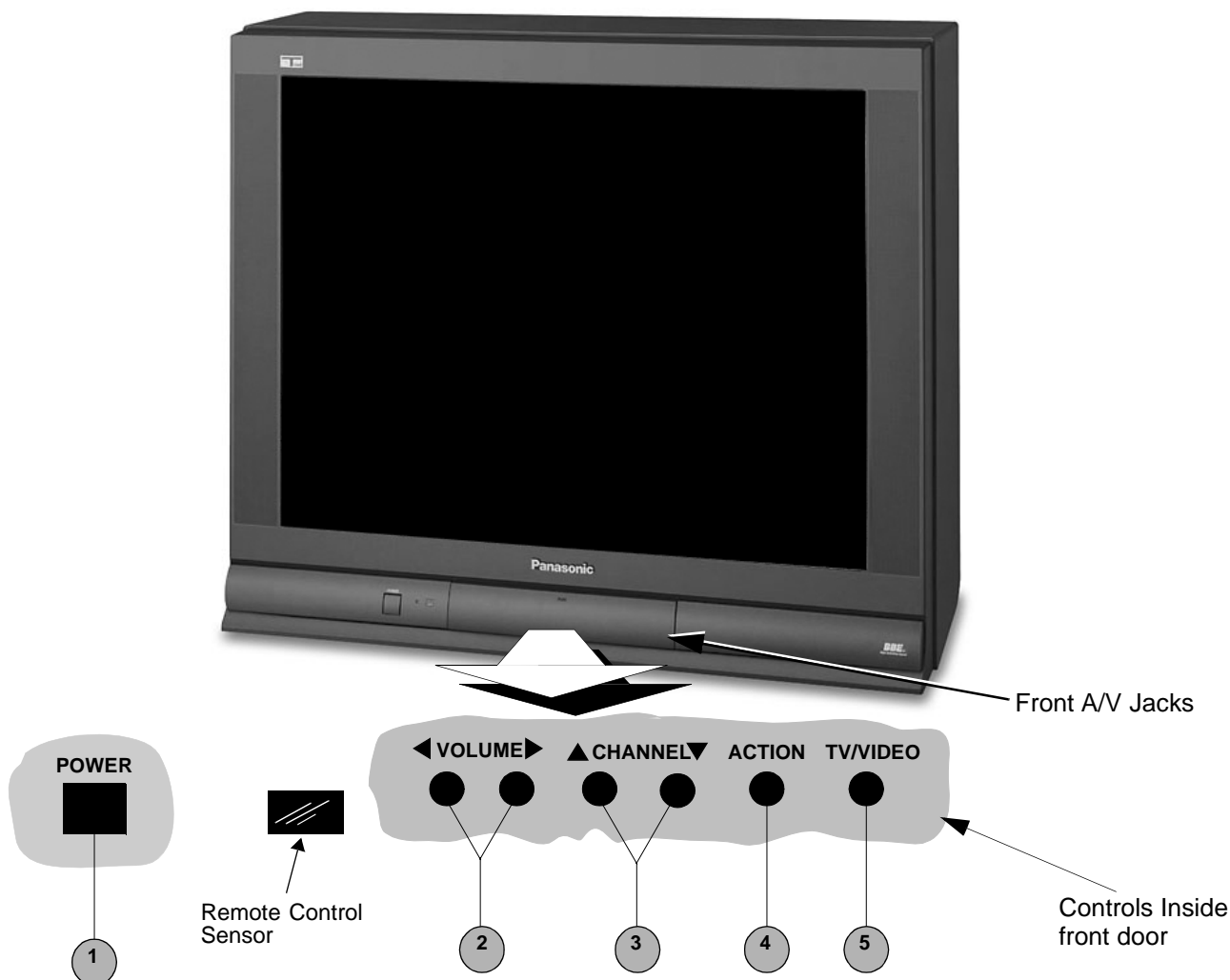

Figure 3. Location of Controls (Receiver).

Quick Reference Control Operation

Quick Reference Control Operation	
1	Power Button - Press to turn ON or OFF.
2	Volume Buttons - Press to adjust Sound Level, or to adjust Audio Menus, Video Menus, and select operating features when menus are displayed
3	Channel Buttons - Press to select programmed channels. Press to highlight desired features when menus are displayed. Also use to select Cable Converter box channels after programming Remote Control Infra-red codes (the TV/AUX/CABLE switch must be set in CABLE position).
4	Action Button - Press to display Main Menu and access On Screen feature and Adjustment Menus.
5	TV/Video Button - Press to select TV or Video Input.

Location of Controls (Remote)

POWER Button
Press to turn ON and OFF.
MUTE Button
Press to mute sound. A second press resumes sound. Press also to access and delete Closed Caption display.
VCR, DVD, LD/CD, AUX, TV, CBL, DBS, RCVR
Component function buttons
VOL (volume) Buttons
Press to adjust TV sound level. Use with Channel buttons to navigate in menus.
R-TUNE (Rapid Tune) Button.
Press to switch to the previous channel.
ACTION Button
Press to display Main Menu and access or exit On Screen features and Adjustment Menus.
REW, PLAY, FF, TV/VCR, STOP, PAUSE, REC, VCR CHANNEL
Component function buttons.



MULTI Button
Programmable button that can operate up to seven (7) functions at once
TV/VIDEO Button
Press to select TV or Video input.
CH (channel) Buttons
Press to select channels. Use with volume buttons to navigate in menus.
DBS EXIT, DBS GUIDE
DBS function buttons.
RECALL Button
Press to display Time, status of Sleep Timer, Channel, Video mode and Channel Caption (Station Identifier).
OPEN/CLOSE, SLOW, STILL
DVD function buttons.
"0" - "9"
Press numeric keypad to select any channel.

EUR511500

Figure 4. Location of Controls (Remote).

Disassembly for Service

Back Cover

Remove all the screws marked with an arrow(←) from the back of the Receiver.

Note: Screw configuration, type, and number of screws vary depending on the model of the Receiver serviced and the application; various models are covered in this Manual. Use same hardware when reassembling the receiver.

- 4 screws at the top edge of the Receiver.
- 4 screw by the A/V jacks.
- 1 screw by the antenna jacks.
- 1 screw at each lower corner of the Receiver.
- 1 screw by the retainer plate of the AC power cord.

A-Board - Main Chassis

The A-Board assembly rest on a chassis tray along with the D-Board. Slide chassis tray out. Gently lift tray and pull out. Disconnect plug connectors; release wire ties and holders as required for complete chassis removal.

1. A & D-Boards are secured to the chassis tray with five screws.
2. The A-Board is mated to the D-Board by three flexible connectors: A1, A2 & A3 (G1, G2 & G3 on the G-Board, respectively). To remove either boards, unplug the connectors on the A-Board.

Note: Some tie-wraps that secure the wire dressings may need to be unfastened for chassis removal.

L-Board - CRT Output

Plugs into the socket on the CRT neck.

To remove this board, first unplug the board from the CRT neck, then disconnect L1, L2 & L3 connectors, to disconnect the focus F1(Red Cable) & F2(White Cable) cables, pull the tab and release the cables, finally disconnect the screen cable from the D-Board Fly-Back.

To reinsert back the cables, remember the original position of cables, F1(red cable) goes to A on the CRT socket and F2(white cable) goes to B on the CRT socket.

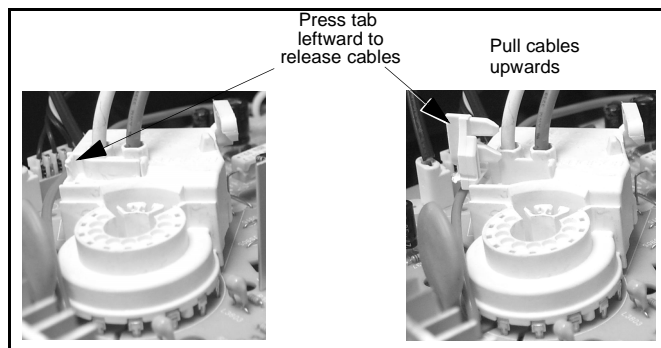

Figure 5. F1 & F2 cables release

To release screen GND cables from L-Board L11 & L12 connectors, insert a wire in both sides of connector and pull upwards the cable, then remove the wire (See Fig. 6)

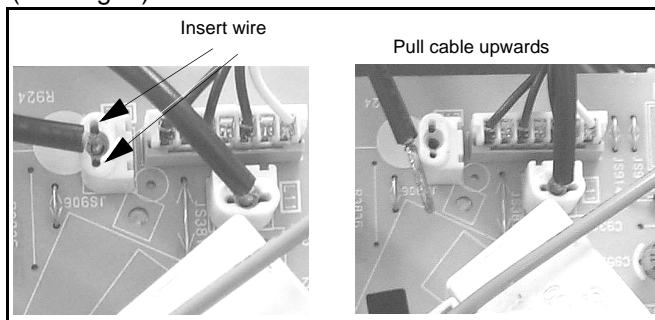

Figure 6. L-Board Screen GND cables release

Speakers

Speaker is secured to the cabinet's front with 4 screws.

Keyboard Push Button Assembly

Fastened to the inside of the cabinet front.

Disassembly for CRT Replacement

1. Discharge the CRT as instructed in the **Safety Precautions** (see page 2).
2. Disconnect the yoke (DY) plug, degaussing coil (DEG) plug and the CRT 2nd anode button from the board.
3. Remove the L-Board from the CRT socket and unplug the black wires (CRT dag ground) L11 & L12.
4. Lift the Main Chassis (A-Board) and all mounted boards completely out with the CRT Board attached.

CRT Replacement

1. Perform **Disassembly for CRT Replacement** procedure.
2. Insure that the CRT H.V. Anode button is discharged before handling the CRT. Read the **Safety Precautions** (see page 2) on handling the picture tube.
3. Remove the components from the CRT neck and place the cabinet face down on a soft pad.
4. Note the original order for the CRT mounting hardware as they are remove from the CRT mounting brackets at each corner of the CRT.
5. Remove the CRT with the degaussing coil and the dag ground braid attached.

Note: After servicing the receiver, remember to dress the cables, as shown above.

Disassembly for Service (Continued)

Note: To remove the four brackets holding the degauss coil from the corners of the CRT, first remove the CRT from the cabinet, then remove the Brackets by pressing the tab on the bracket and pull upwards. These Brackets are included in the Degauss Coil Kit, for part number, please see parts list section (See Fig. 7).

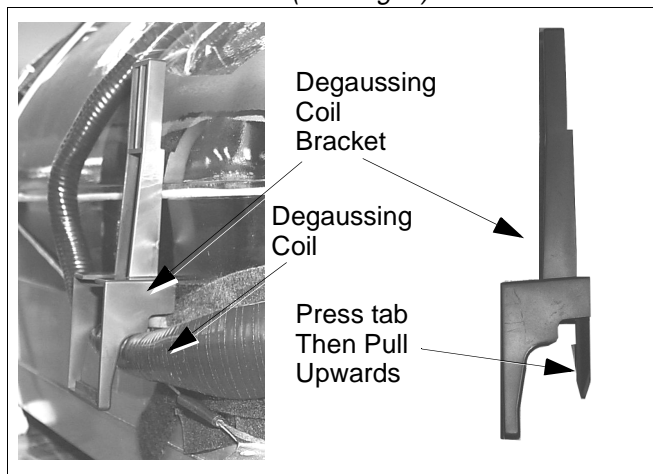

Figure 7. **Brackets removal**

Note: Reuse all the clampers and mounting brackets from the degaussing coil and screen, and when remounting the degaussing coil assure that it is not touching the speakers, this can be done by placing some tape (See Fig. 7), this may cause mask vibration. The mounting brackets and clampers are not supplied with the replacements.

Important Notice:

When ordering the CRT, please order CRT and CRT KIT also. Please see parts list section for part numbers

6. Note the original locations and mounting of the degaussing coil and the dag ground assembly to insure proper reinstallation on the replacement CRT.

To remove and remount the degaussing coil:

The degaussing coil is held in place by clampers fastened to the CRT corner ears. These clampers must be installed onto the replacement CRT prior to mounting the degaussing coil.

To remove and remount the dag ground braid:

- a. Unhook the coil spring from the bottom corners of the CRT ears.
 - b. Release the braid loop from the upper corners of the CRT ears.
7. Mount the dag ground braid on the replacement CRT. Position the degaussing coil with new ties. Dress coil as was on the original CRT.
 8. Replace the components on CRT neck and reinstall into cabinet. Verify that all ground wires and circuit board plugs get connected.

Back Cover Removal

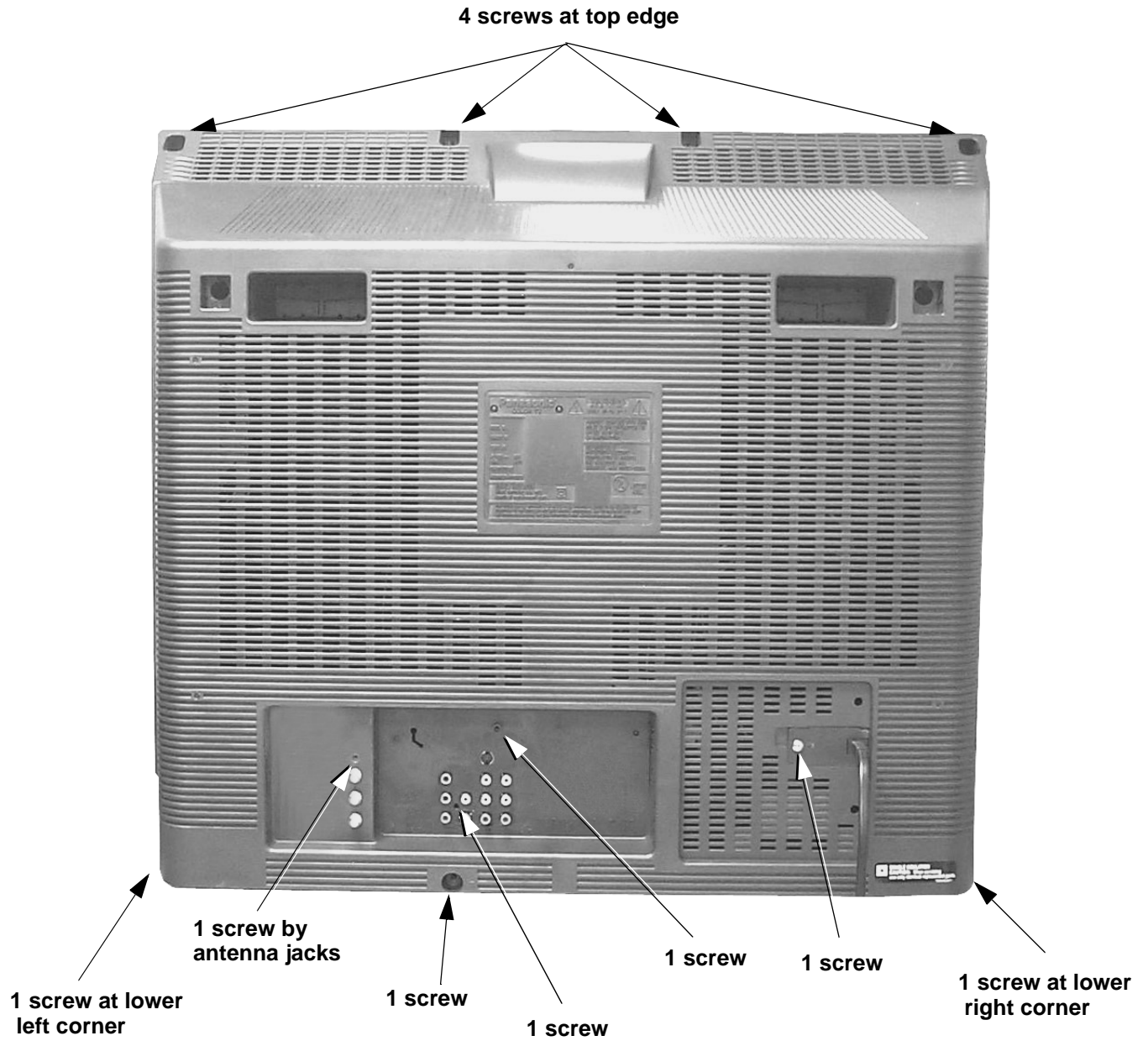
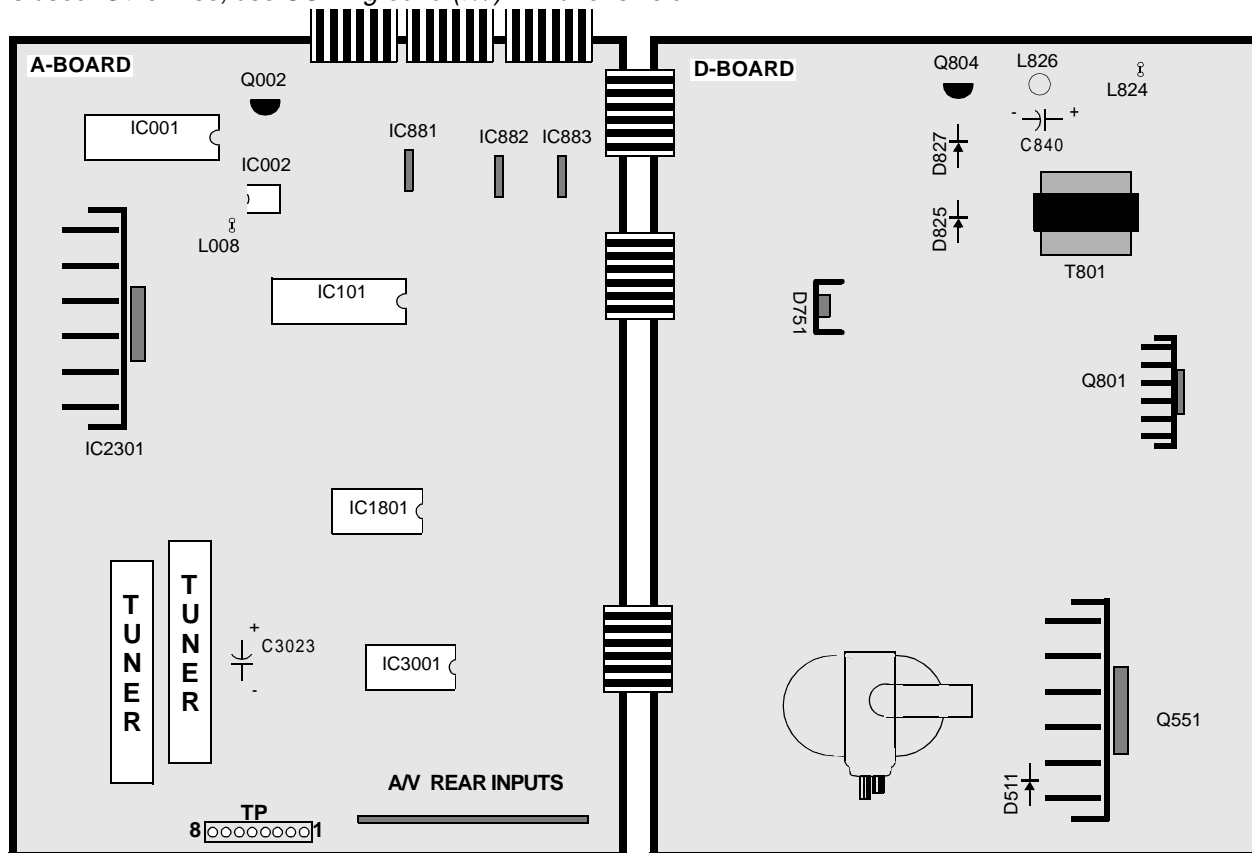

Figure 8. Back Cover Removal

Chassis Service Adjustment Procedures

All service adjustments are factory preset and should not require adjustment unless controls and/or associated components are replaced.

Note: Connect the (-) lead of the voltmeter to the appropriate ground. Use heat sink when the HOT ground symbol (∇) is used. Otherwise, use COLD ground (∇) — Tuner shield.



MOMENTARILY CONNECT A JUMPER FOR ENTERING SERVICE MODE (TP8 to COLD GND)

140.0V B+ Voltage Confirmation

1. Set the **Bright** and the **Picture** to Minimum by using the Picture Menu.
2. Connect the DVM between **TPP17** (+ side) and cold ground (∇).
3. Confirm that B+ voltage is **140.0V ± 1.5V**. This voltage supplies B+ to the Horizontal Output & Flyback circuits.

Source Voltage Chart

120V AC line input. Set the **Bright** and the **Picture** to Minimum by using the Picture Menu. Use cold ground (∇) for the (-) lead of the DVM.

LOCATION (D-Board)	VOLTAGE
TPD7 (by D511) 220V	220.0V ± 9.0V
LOCATION (A-Board)	VOLTAGE
TPA6 (by IC883) MAIN 12V	12.0V ± 0.5V
TPA7 (by IC3001) MAIN 9V	9.0V ± 0.5V
TPA8 (by L008) MAIN 5V	5.0V ± 0.3V
TPA16 (by Q002) STBY 3.3V	3.3V ± 0.2V
TPA18 (by C3023) BTL 30V	32.0V ± 2.0V

LOCATION (D-Board)	VOLTAGE
TPP17 (by D825) +B2	140.0V ± 1.5V
TPP25 (by D827) 9V	9.0V ± 1.5V
TPP19 (by Q804) 15V	15.0V ± 2.0V
TPP20 (by C840) 15V (VER.)	15.0V ± 1.5V
TPP21 (by L826) -15V (VER.)	-15.0V ± 1.5V
TPP22 (by L824) SOUND	32.5V ± 2.0V

Adjust Picture Menu for normalized video adjustments.

High Voltage Check

1. Select an active TV channel and confirm that horizontal is in sync.
2. Adjust Brightness and Picture using Picture Icon menu so video just disappears.
3. Confirm B+ 140.0V is within limit.
4. Using a high voltage meter confirm that the High Voltage is **31.0kV ± 1.0kV**.

Purity and Convergence Procedure

Adjustment is necessary only if the CRT or the deflection yoke is replaced or if the setting was disturbed. The complete procedure consists of:

1. Vertical Raster Shift Adjustment. (**Only for Models with Purity/Convergence Assembly with 4 Pairs of Rings**).
2. Initial static convergence.
3. Setting the purity.
4. Final static convergence.

When the CRT or the Yoke is Replaced

Place the yoke on the CRT neck (do not tighten the clamp).

Place the vertical raster shift tabs at 3 o'clock (90° from the purity and convergence tabs)

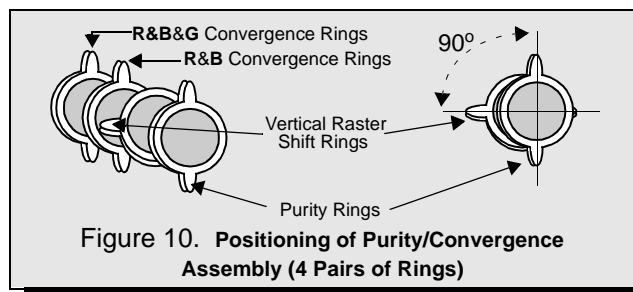
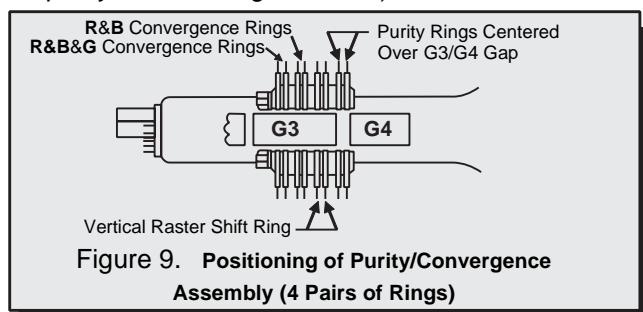

Turn the Receiver ON. Operate the Receiver for 60 minutes using the first Purity Check field (white screen) to stabilize the CRT.

Fully degauss the Receiver by using an external degaussing coil.

Slide the deflection yoke back and forth on the neck of the CRT until it produces a near white, uniform raster.

Vertical Raster Shift Adjustment (Only for Models with Purity/Convergence Assembly with 4 Pairs of Rings).

Apply a green pattern with a horizontal line, adjust the Deflection Yoke so that has no tilt, then secure it.

Adjust center line of the pattern with the mechanical center of the CRT, this center is determined by two marks at the side edges of the screen. To adjust the line, once the vertical raster shift tabs are place at 3 o'clock to reduce its magnetic field effect (see Fig. 9 and Fig. 10) open the tabs the same angle from the center, until the center line of the pattern becomes a straight line, centered with the marks of the CRT. (see Fig. 11)

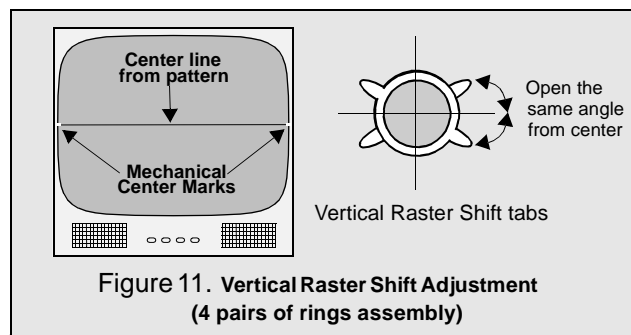

Initial Center Static Convergence

Connect a dot/cross hatch generator to the Receiver and tune in a signal. Observe misconvergence at center of the screen only.

Adjust the R&B pole magnets; by separating tabs and rotating to converge blue with red.

Adjust the R&B and R&B&G pole magnets: by separating tabs and rotating to converge blue and red (magenta) with green.

Note: Precise convergence at this point is not important.

Purity Adjustment

When the Receiver is in the Serviceman Mode for making electronic adjustments, press the **Recall** button on the Remote Control to enter Purity Check. (See the **Service Adjustments Electronic Controls** procedure).

Operate the Receiver for 60 minutes using the first Purity Check field (white screen) to stabilize the CRT.

Fully degauss the Receiver by using an external degaussing coil.

Press the **Recall** button on the Remote Control again until the Purity Check (green screen) appears.

Loosen the deflection yoke clamp screw and move the deflection yoke back as close to the purity magnet as possible.

Adjust the Purity rings to set the vertical green raster precisely at the center of the screen (see Fig. 12).

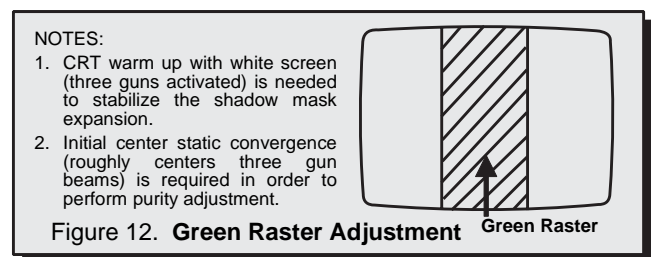

Slowly move the deflection yoke forward until the best overall green screen is displayed.

Tighten the deflection yoke clamp screw.

Press the **Recall** button on the Remote Control again until the purity check blue and red screens appear and observe that good purity is obtained on each respective field.

Press the **Recall** button on the Remote Control again until Purity check (white screen) appears. Observe the screen for uniform white. If purity has not been achieved, repeat the above procedure.

Final Convergence Procedure (see Fig. 17 through Fig. 19):

Note: Vertical size and focus adjustments must be completed prior to performing the convergence adjustment. Connect a dot pattern generator to the Receiver. The **Brightness** level should not be higher than necessary to obtain a clear pattern.

Converge the red and the blue dots at the center of the screen by rotating the R&B pole Static Convergence Magnets.

Align The converged red/blue dots with the green dots at the center of the screen by rotating the R&B&G pole Static Convergence Magnets. Melt wax with soldering iron to reseal the magnets.

Slightly tilt vertically and horizontally (do not rotate) the deflection yoke to obtain a good overall convergence.

If convergence is not reached at the edges, insert permalloy (see following section) from the DY corners to achieve proper convergence. Recheck for purity and readjust if necessary.

After vertical adjustment of the yoke, insert wedge at 11 o'clock position, then make the horizontal tilt adjustment.

Secure the deflection yoke by inserting two side wedges at 3 and 7 o'clock positions.

Apply adhesive between tab (thin portion) of wedge and CRT and place tape over the tab to secure to the CRT.

Dynamic Convergence Adjustment

Use this for a precisely overall convergence adjust at the edges.

DY(Y_{HC}, Y_v, X_v) Adjustment

Y_v Adjustment (VR1 for Horizontal dynamic convergence)

1. Apply a crosshatch pattern.
2. Adjust contrast and brightness customer controls to obtain a correct picture.
3. With a driver adjust VR1 (located in deflection yoke board Fig. 19) to obtain a proper convergence at top and bottom of the screen (See Fig. 13)

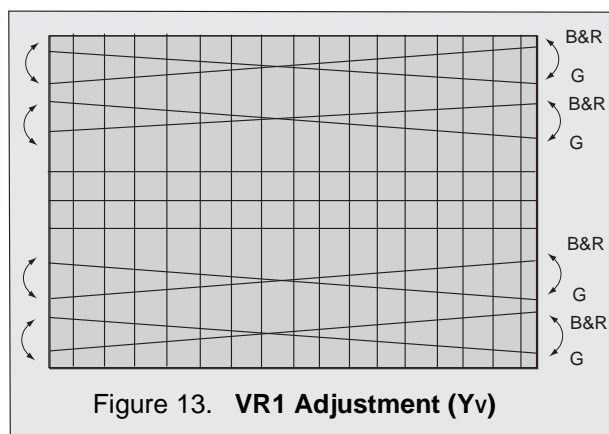

Y_H Adjustment (VR2 for Vertical dynamic convergence)

1. Apply a crosshatch pattern.
2. Adjust contrast and brightness customer controls to obtain a correct picture.
3. With a driver Adjust VR2 (located in deflection yoke board Fig. 19) to obtain a proper convergence at left and right side of the screen. (See Fig. 14)

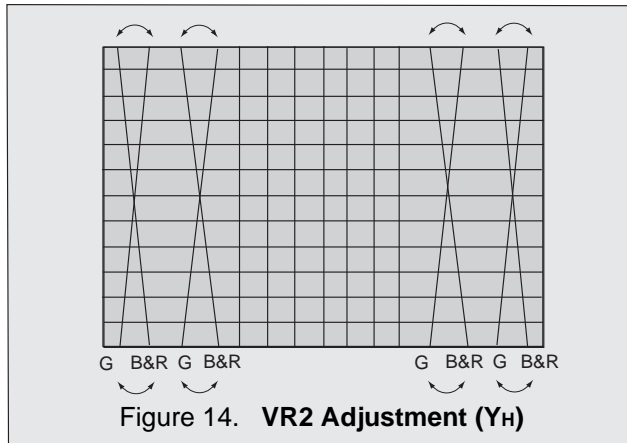

X_v Adjustment (precise adjustment)

1. Apply a crosshatch pattern.
2. Adjust contrast and brightness customer controls to obtain a correct picture.
3. With a driver adjust the coil located in deflection yoke board to obtain a proper convergence horizontally.

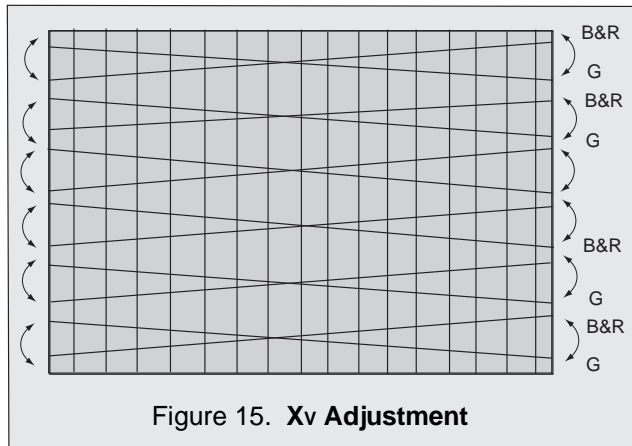

Note: Apply a red pattern and confirm purity, if purity is poor, repeat purity adjustments.

Permalloy Convergence Corrector Strip (Part No. 0FMK014ZZ)

This strip is used in some sets to match the yoke and CRT for optimum convergence. If the yoke or CRT is replaced, the strip may not be required. First converge the set without the strip and observe the corners.

If correction is needed:

1. Place strip between CRT and yoke, in quadrant needing correction. Slowly move it around for desired results.
2. Press adhesive tightly to the CRT and secure with tape.

DAF Adjustment

Preparation:

1. Apply a crosshatch pattern.
2. Set user controls, bright to center and picture to max.
3. Connect a frequency counter to TPD10.

Procedure:

1. Connect channel one of the oscilloscope with 10x1 probe to TPP33.
2. Connect channel two of the oscilloscope with 10x1 probe to CRT HEATER (L-Board).
3. Adjust R1581 so that frequency counter reads 15.7kHz±100Hz.

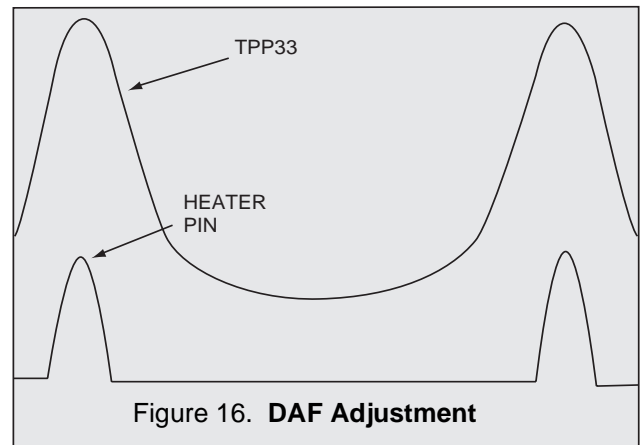

4. Adjust R1577 so that signal on TPP33 is in phase with CRT HEATER (L-Board) pin. (see Fig. 16)

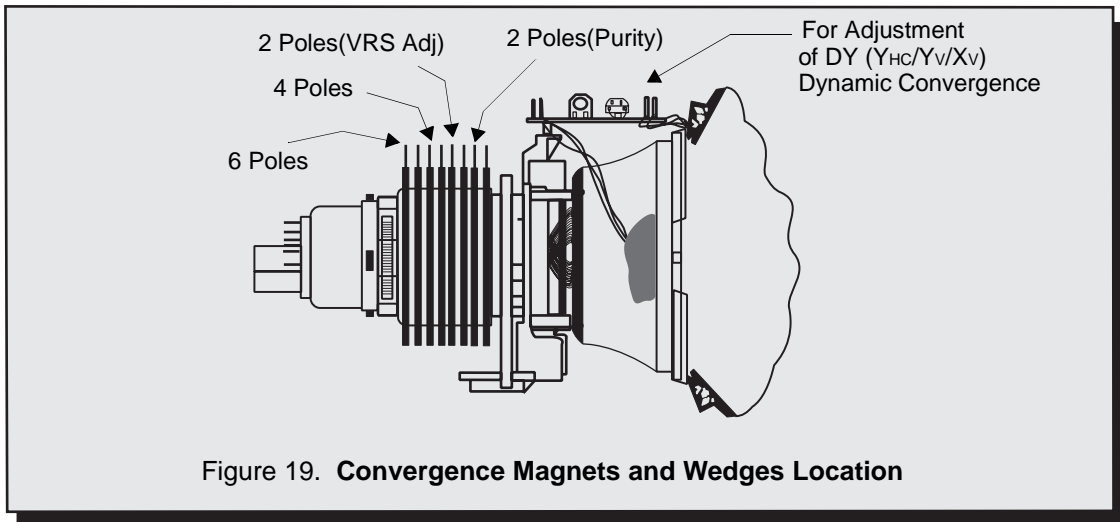
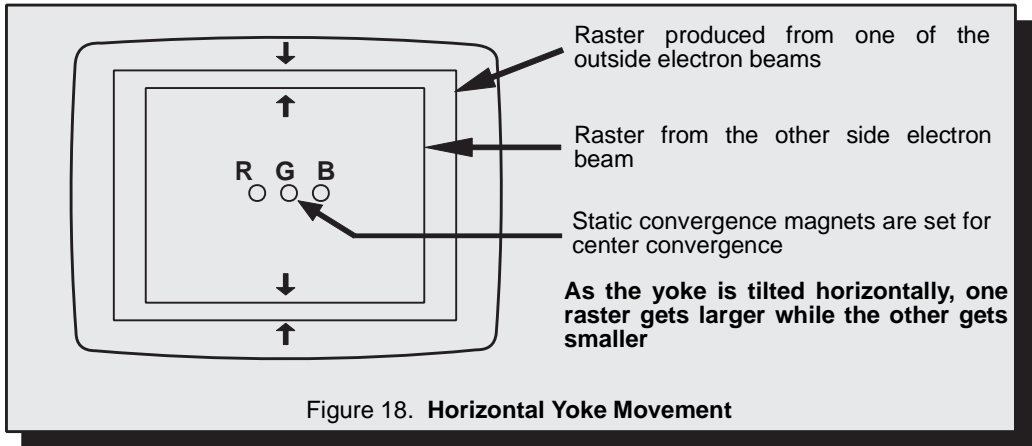
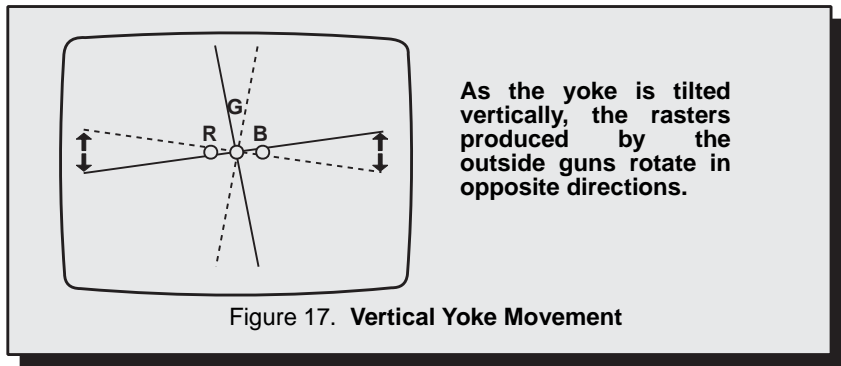

IMPORTANT NOTE:
Always Exit the Serviceman Mode Following Adjustments.

Serviceman Mode (Electronic Controls)

This Receiver has electronic technology using the I²C Bus Concept. It performs as a control function and it replaces many mechanical controls. Instead of adjusting mechanical controls individually, many of the control functions are now performed by using "On Screen Display Menu". (The **Serviceman Adjustment Mode**.)

Note: It is suggested that the technician reads all the way through and understand the following procedure for Entering/Exiting the **Serviceman Adjustment Mode**; then proceed with the instructions working with the Receiver. When becoming familiar with the procedure, the Flow Chart for Serviceman Mode may be used as a quick guide.

Quick Entry to Serviceman Mode:

At times when minor adjustments need to be done to the electronic controls, the method of Entering the serviceman Mode without removal of the cabinet back is as follows using the Remote Control:

1. Select SET-UP icon and select CABLE mode.
2. Select TIMER icon and set SLEEP time for 30 Min.
3. Press ACTION button 3 times to exit menus.
4. Tune to the Channel 124.
5. Adjust VOLUME to minimum (0).
6. Press the VOL ◀ button (decrease) on Receiver. Red "CHK" appears in upper corner.

To toggle between Aging and Serviceman modes:

While the "CHK" is displayed on the left top corner of the CRT, pressing the Action and the Volume Up buttons on the Receiver simultaneously will toggle between the modes. Red "CHK" for Serviceman and yellow "CHK" for Aging.

7. Press the Power Button on the Remote Control to select one of the Serviceman Adjustment Modes.
 - 1) **B**= Serviceman VCJ SUB-DATA ADJUSTMENT.
 - 2) **C**= Serviceman VCJ CUT-OFF ADJUSTMENT.
 - 3) **D**= Serviceman GEOMETRY ADJUSTMENT.
 - 4) **M**= Serviceman MTS ADJUSTMENTS.
 - 5) **P**= Serviceman PIP ADJUSTMENT.
 - 6) **S**= Serviceman S OPTION ADJUSTMENTS.
 - 7) **X** = Serviceman X OPTION ADJUSTMENT.
 - 8) **E** = Serviceman E OPTION ADJUSTMENTS
 - 9) "CHK" = Normal operation of CHANNEL ▲▼ and VOLUME ◀▶.

Note: Only the applicable settings for the Receiver serviced will be available (See a in Fig. 20).

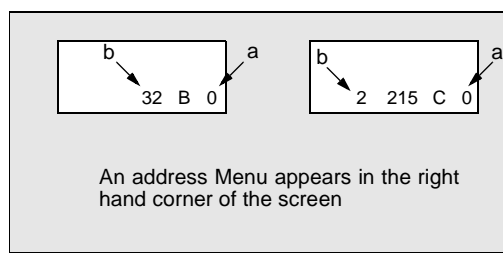

Figure 20. Serviceman Mode Menu Adjustments.

Exiting the Serviceman Mode:

Press the **Action** and the **Power** buttons on the **Receiver** simultaneously for at least 2 seconds.

THE RECEIVER EXITS SERVICEMAN MODE.

The Receiver momentarily shuts off; then comes back on tuned to channel 3 with a preset level of sound. Any programmed channels, channels caption data and some others user defined settings will be erased.

IMPORTANT NOTE:
Always Exit the Serviceman Mode
Following Adjustments.

Press the **Power Button** on the **Remote Control** to select the Serviceman Adjustment .

For Adjustments:

1. Press **Channel Up/Down** on the **Remote Control** to select one of the available Service Adjustments (**a** in Fig. 20).

Note: Write Down the original value set (**b** in Fig. 20) for each address before modifying anything. It is easy to erroneously adjust the wrong item.

2. Press **Volume Up/Down** on the **Remote Control** to adjust the level of the selected Service Adjustment (**b** in Fig. 20).

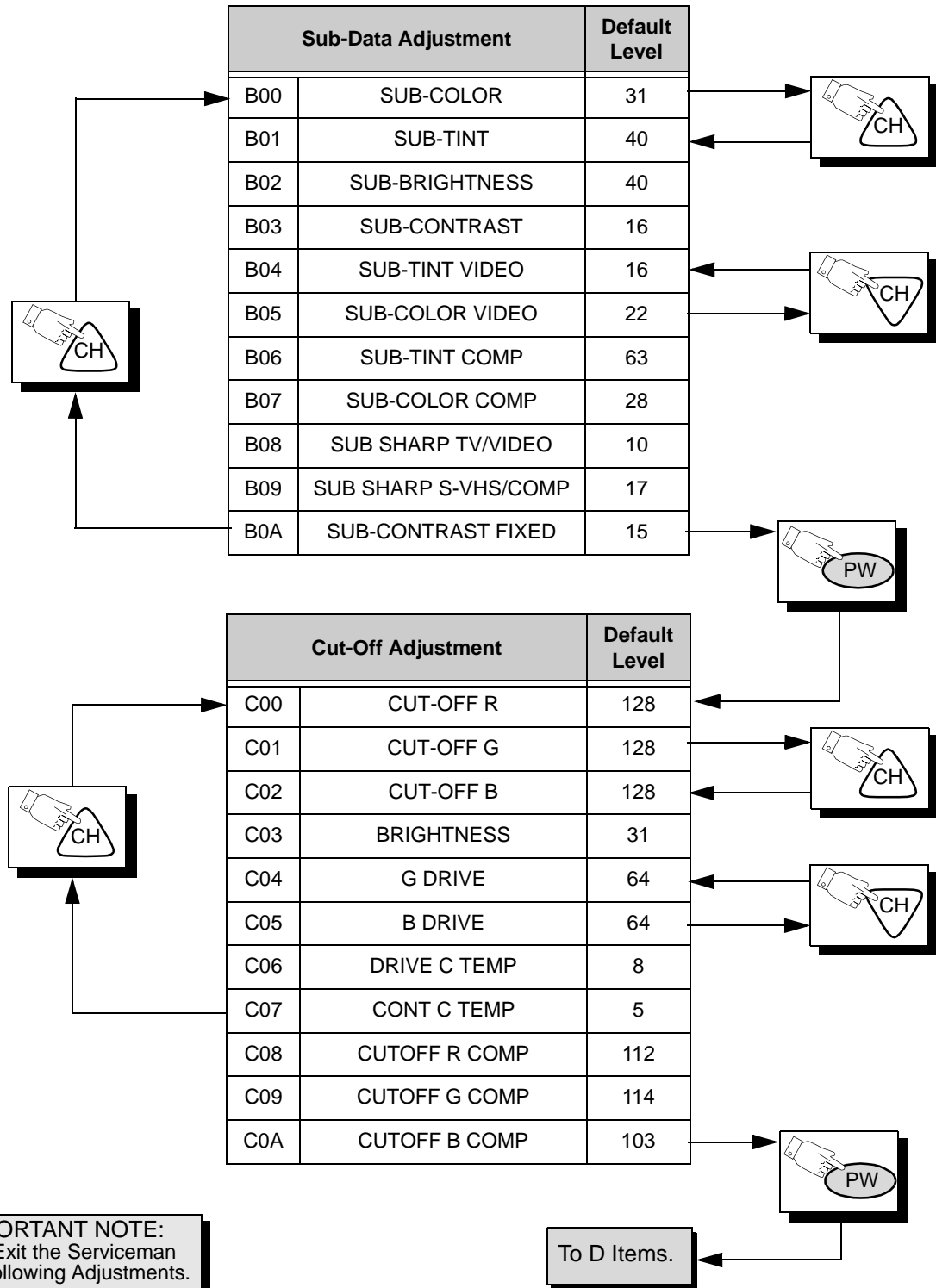

IMPORTANT NOTE:
Always Exit the Serviceman Mode Following Adjustments.

To D Items.

Press the Power Button on the Remote Control to select the Serviceman Adjustment

For Adjustments:

1. Press Channel Up/Down on the Remote Control to select one of the available Service Adjustments (a in Fig. 20).

Note: Write Down the original value set (b in Fig. 20) for each address before modifying anything. It is easy to erroneously adjust the wrong item.

2. Press Volume Up/Down on the Remote Control to adjust the level of the selected Service Adjustment (b in Fig. 20).

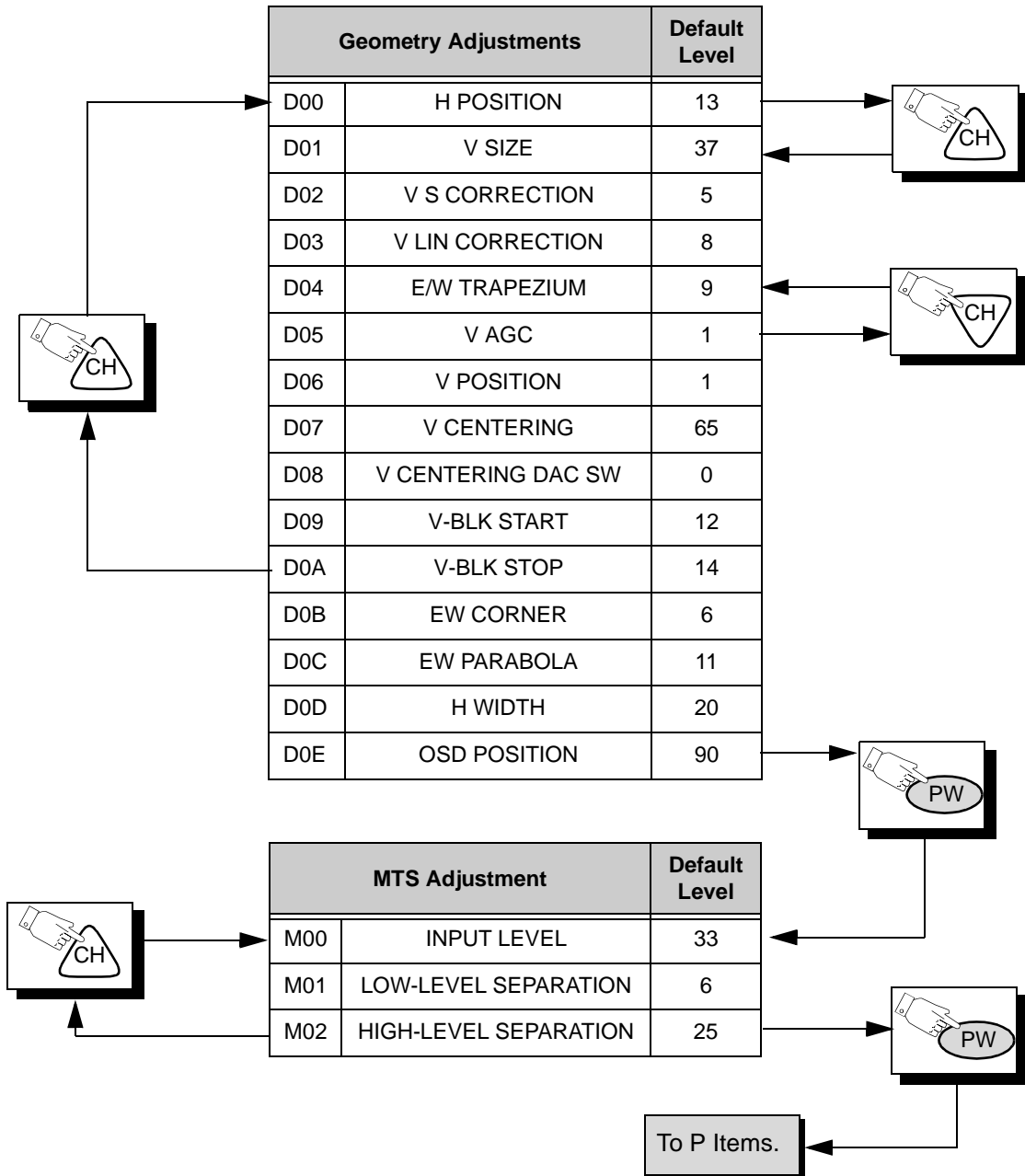

Note: Some adjustment modes may not be available in some formats.

IMPORTANT NOTE:
Always Exit the Serviceman Mode Following Adjustments.

Press the Power Button on the Remote Control to select the Serviceman Adjustment

For Adjustments:

1. Press Channel Up/Down on the Remote Control to select one of the available Service Adjustments (a in Fig. 20).

Note: Write Down the original value set (b in Fig. 20) for each address before modifying anything. It is easy to erroneously adjust the wrong item.

2. Press Volume Up/Down on the Remote Control to adjust the level of the selected Service Adjustment (b in Fig. 20).

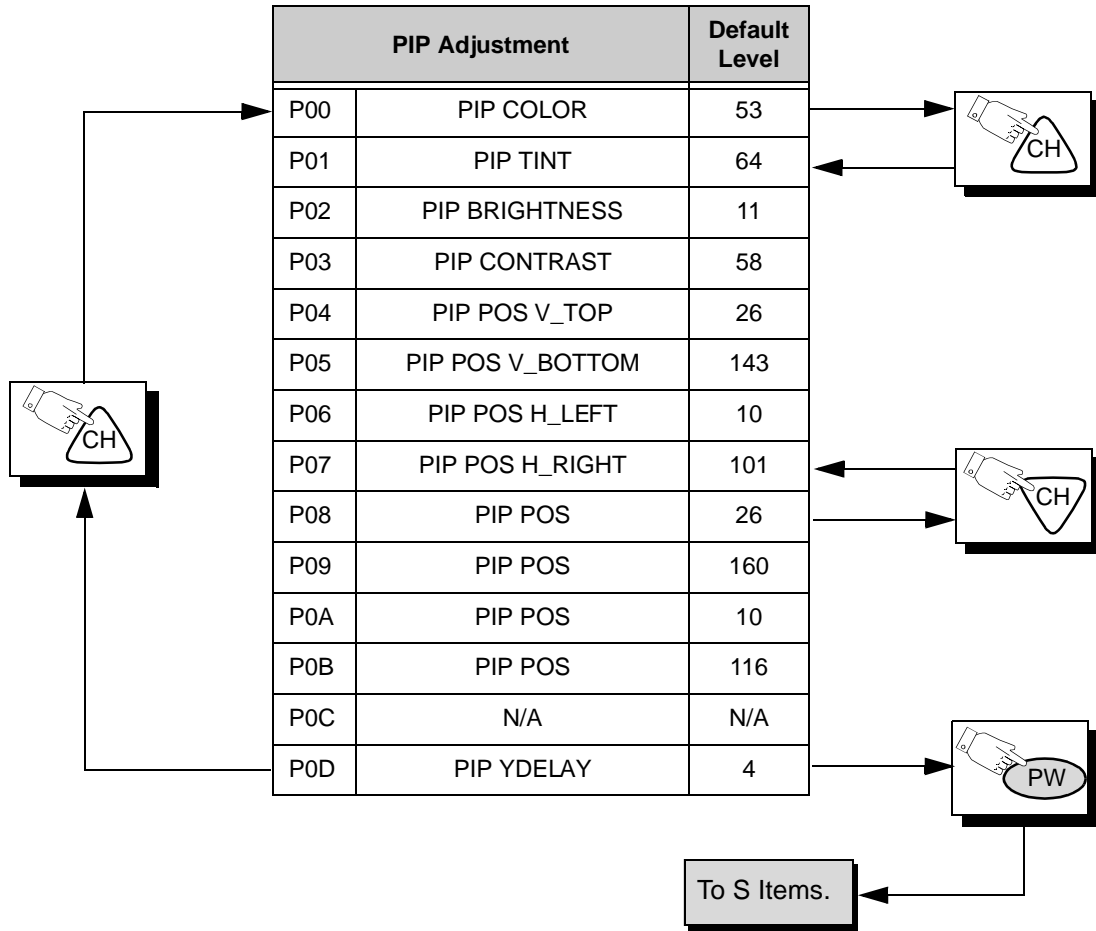

Note: Some adjustment modes may not be available in some formats.

Press the Power Button on the Remote Control to select the Serviceman Adjustment

For Adjustments:

1. Press Channel Up/Down on the Remote Control to select one of the available Service Adjustments (a in Fig. 20).

Note: Write Down the original value set (b in Fig. 20) for each address before modifying anything. It is easy to erroneously adjust the wrong item.

2. Press Volume Up/Down on the Remote Control to adjust the level of the selected Service Adjustment (b in Fig. 20).

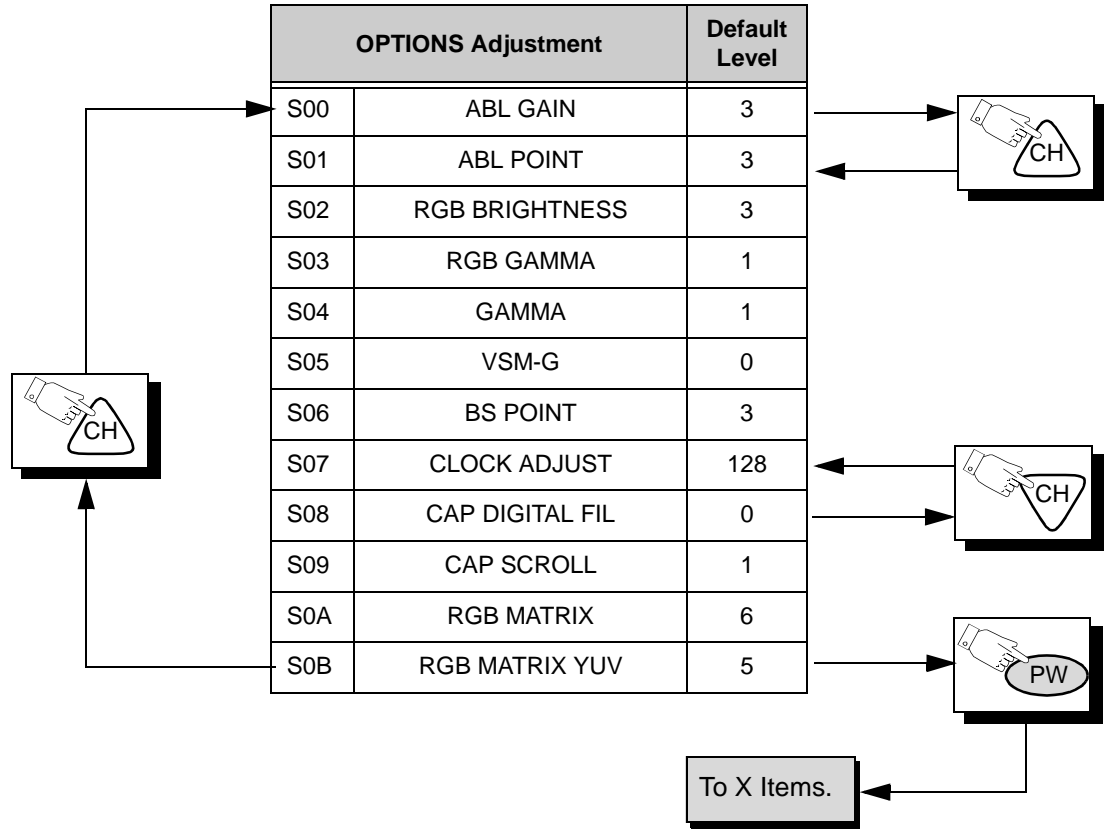

IMPORTANT NOTE:
Always Exit the Serviceman Mode Following Adjustments.

Press the Power Button on the Remote Control to select the Serviceman Adjustment

For Adjustments:

1. Press Channel Up/Down on the Remote Control to select one of the available Service Adjustments (a in Fig. 20).

Note: Write Down the original value set (b in Fig. 20) for each address before modifying anything. It is easy to erroneously adjust the wrong item.

2. Press Volume Up/Down on the Remote Control to adjust the level of the selected Service Adjustment (b in Fig. 20).

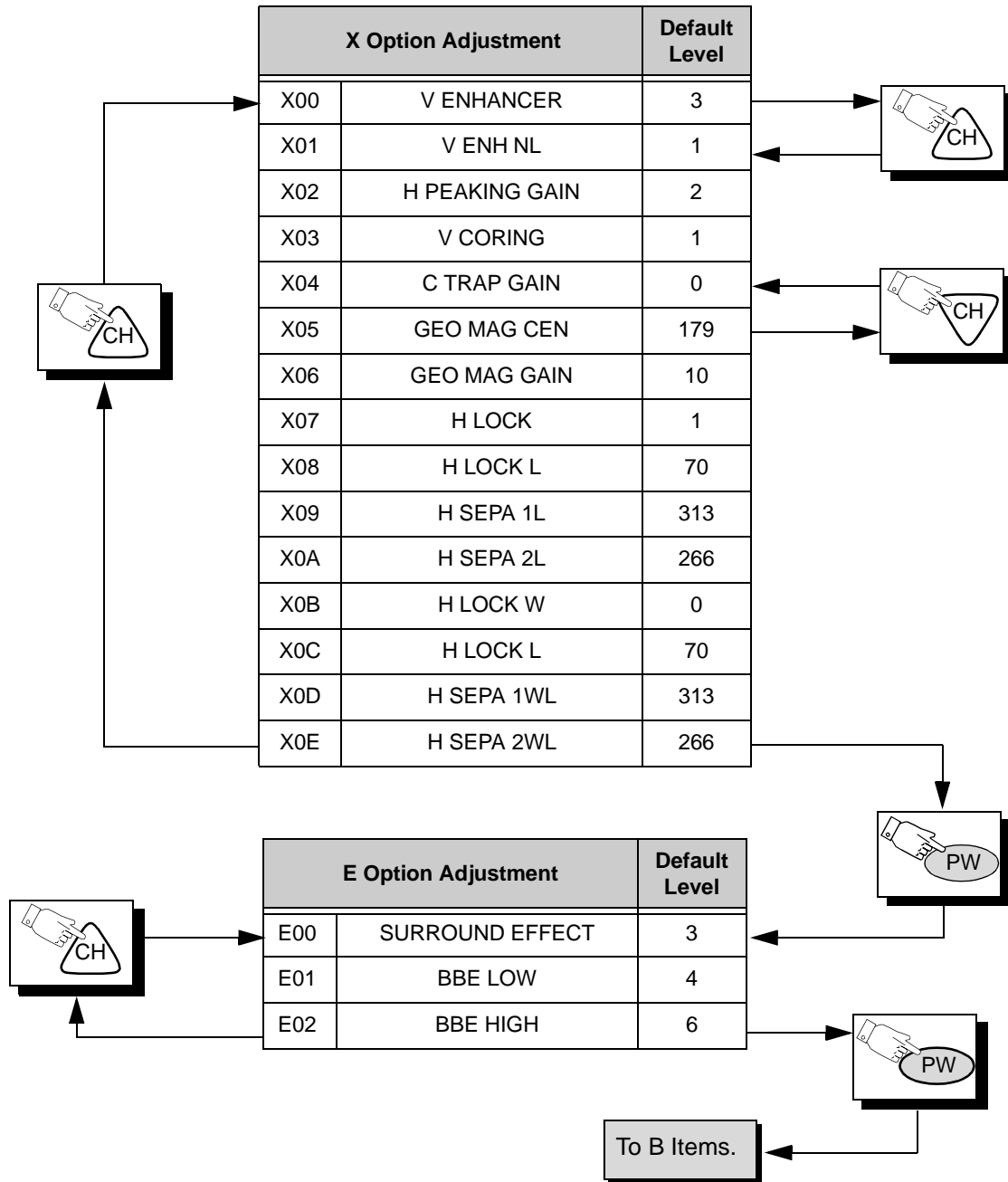

To Check Purity:

Press the **Recall** Button on the **Remote Control** when in Serviceman Mode (red "CHK" is displayed) to enter the Purity Field Check Mode.

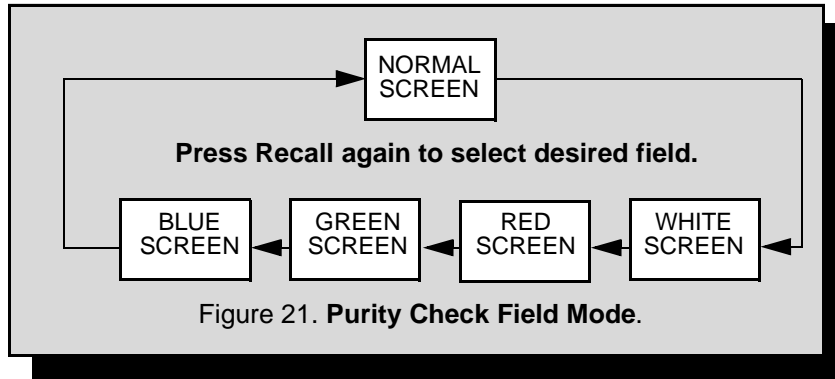

Helpful Hints

Entering Serviceman Mode (Back-Open Method)

1. While the Receiver is ON or Pugged and operating in Normal Mode, momentarily short test point **FA1** (TP8) to Cold Ground (\rightarrow) **FA2** (TP3) A-Board.

The Receiver enters the Aging Mode.

Yellow letters "CHK" appear in the upper left corner of the CRT.
(The Volume Up/Down will adjust rapidly).

2. Simultaneously press the **Action** and the **Volume Up** buttons on the **Receiver** Control Panel.

The Receiver enters the Serviceman Mode.

The letter in "CHK" turn red.
(The Volume Up/Down will adjust normally).
(All customer controls are set to nominal level).

IMPORTANT NOTE:
Always Exit the Serviceman
Mode Following Adjustments.

Instructional Flow Chart for Serviceman Mode

IMPORTANT NOTE:
Always Exit the Serviceman Mode Following Adjustments.

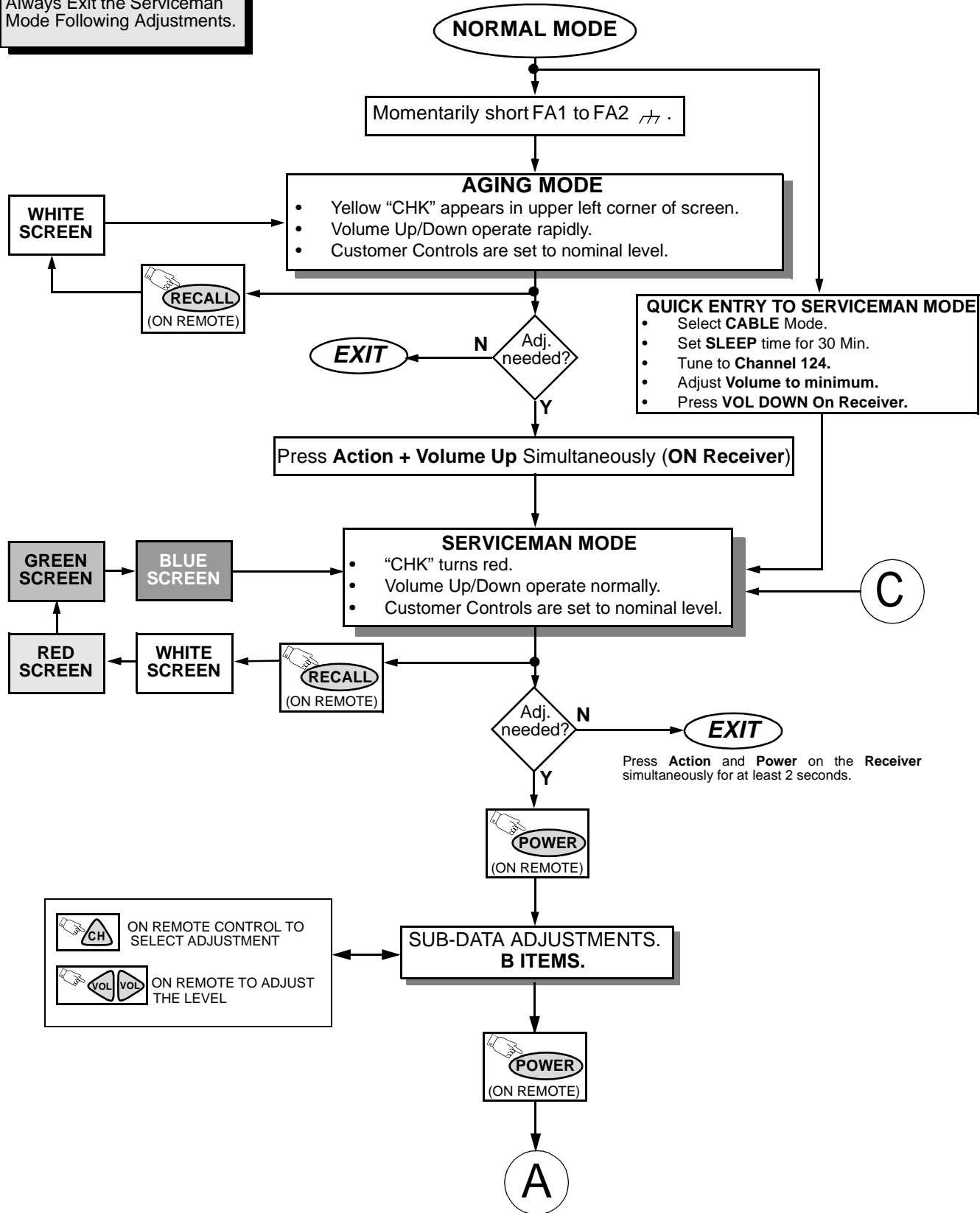

Figure 22. Flow Chart for Serviceman Mode.

Instructional Flow Chart for Serviceman Mode - Continued

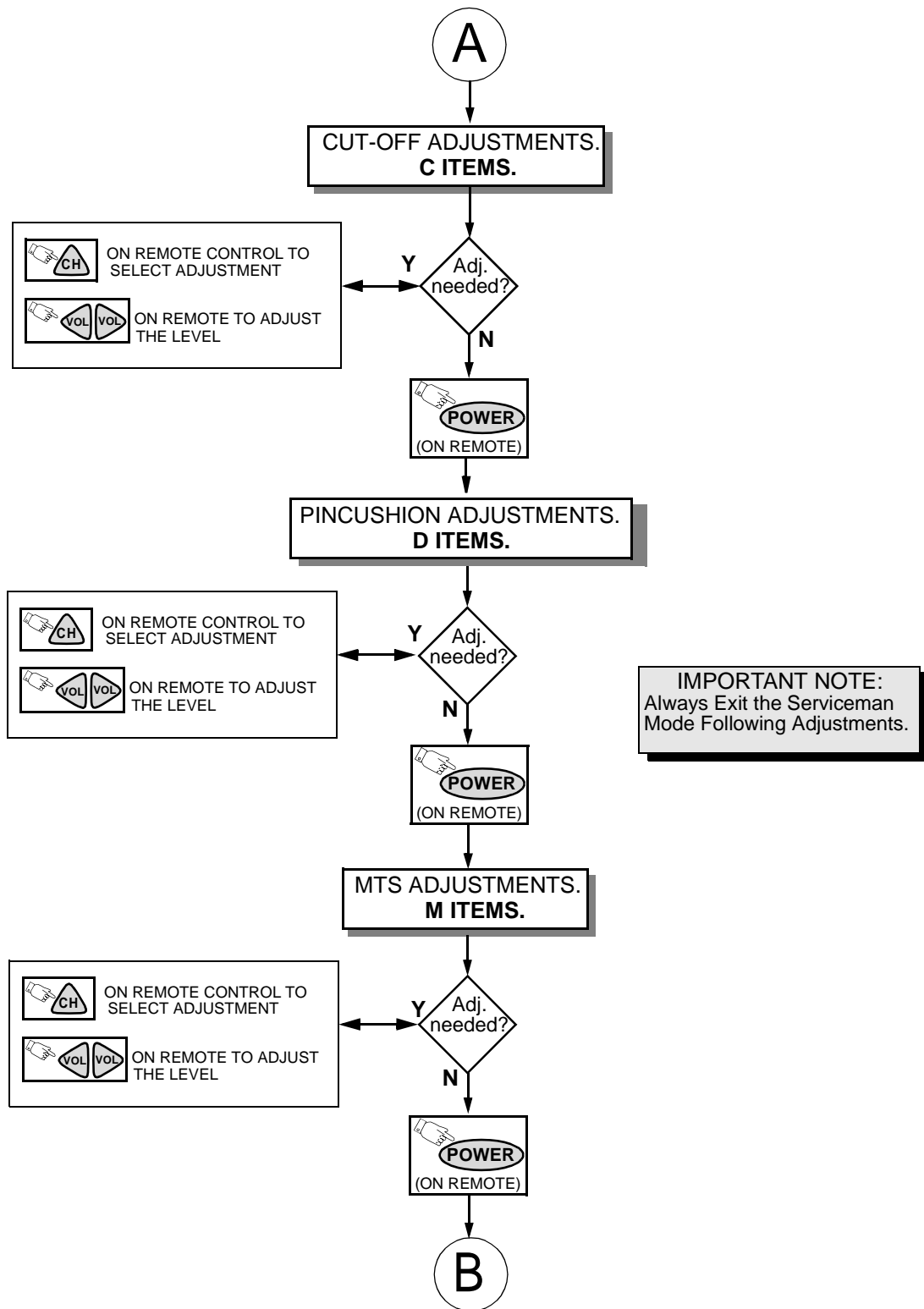
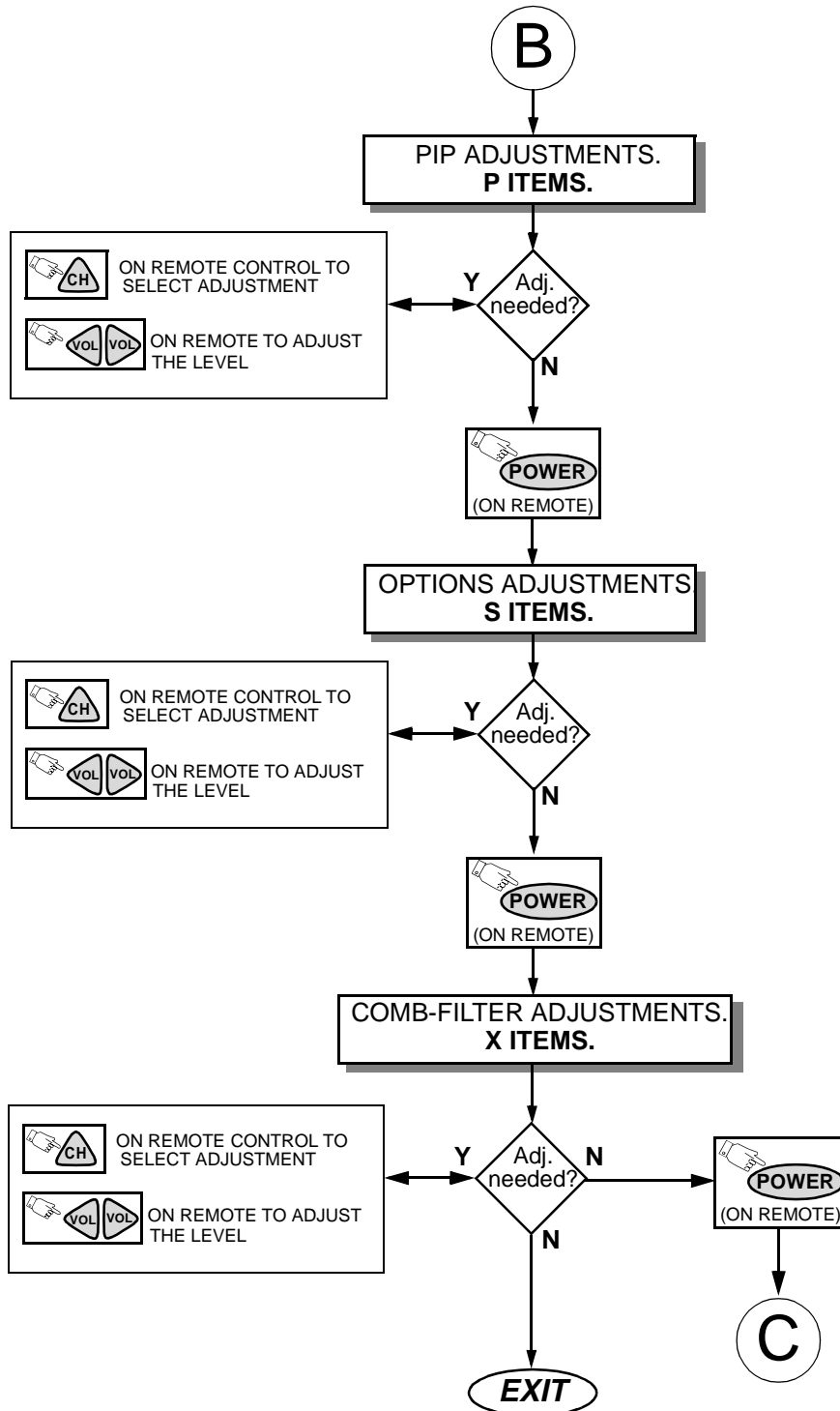

Figure 23. Flow Chart for Serviceman Mode (cont).

Instructional Flow Chart for Serviceman Mode - Continued



Press Action and Power on the Receiver simultaneously for at least 2 seconds.

Figure 24. Flow Chart for Serviceman Mode (cont).

Note: Some adjustments modes may not be available in some models depending on available options.

IMPORTANT NOTE:
Always Exit the Serviceman Mode Following Adjustments.

Service Adjustments (Electronic Controls)

Sub-Contrast Adjustment

Serviceman DAC Adjustment (B02, B03)

This adjustment is factory set. **Do not adjust** unless repairs are made to associated circuit, the CRT Board or when the CRT is replaced.

Preparation:

1. Apply a Black-White pattern.
2. Set the picture settings to normal and color to minimum.
3. RGB GAMMA (S03) DAC from 1 to 0
4. Connect the oscilloscope to TP47R.
5. Connect a jumper from TPD2 to cold ground (↗).

Procedure:

1. In the Serviceman Mode, select DAC B2 for Sub-Brightness to obtain $2.6 \pm 0.1V$ between 7.5IRE and GND level at TP47R (See Fig. 25)
2. In the Serviceman Mode, select DAC B03 for Sub-Contrast to obtain $1.5 \pm 0.1V$ between 7.5IRE and 100IRE level at TP47G
3. Remove short jumper and set RGB GAMMA (S03) DAC to 1.
4. Set the picture settings to normal.

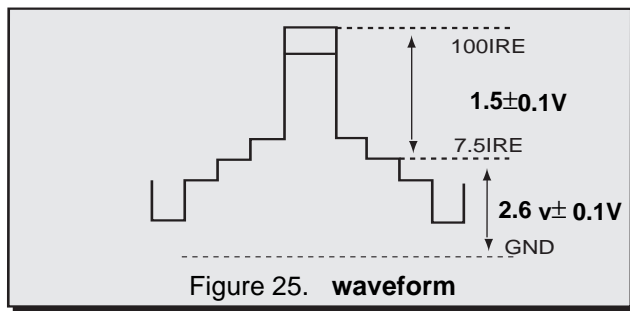

Sub-Brightness (B02)

Adjustment of this control is important for setting proper operation of customer brightness and picture controls. **Do not adjust** the SCREEN VR after the Sub-Brightness is set.

Preparation:

1. Normalize picture settings.
2. Switch COLOR TEMPERATURE to NORMAL.

Procedure:

1. Apply a black white cross pattern.
2. In the Serviceman Mode for making electronic adjustments, select the DAC adjustment (B02) and adjust data so that 7.5IRE part is the same light output as the 3IRE part (See Fig. 26).

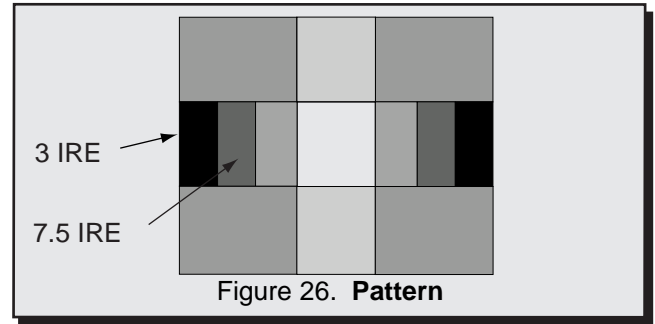

Tint/Color Adjustment

Serviceman DAC Adjustment (B01) (B00)

Preparation:

1. Apply a rainbow color bar signal.
2. Preset the following controls:
 - Brightness Min.
 - Color Center.
 - Tint Center.
 - Picture Max.
 - Sharpness Min.
3. Set RGB GAMMA (S03) DAC to 0
4. Connect the oscilloscope to TP47B (A-Board).
5. Connect a jumper from TPD2 to GND (↗).

Procedure:

1. In the Serviceman Mode for making electronic adjustments, select (B01) DAC Sub-Tint Adjustment. Adjust until the waveform measured is as the one shown in Fig. 27.

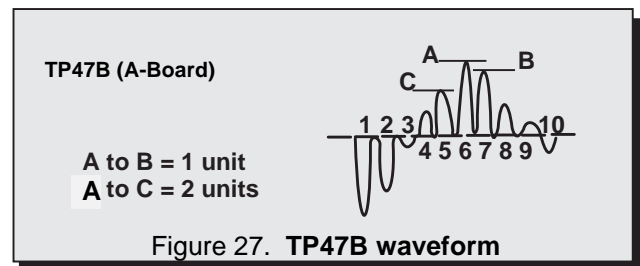

2. Connect the oscilloscope to TP47G or TP35 (L-Board) and cold GND.
3. Select DAC Sub-Color Adjustment (B00) and adjust for peak to peak amplitude to be **0.50Vp-p ± 0.05V** as shown in Fig. 28.

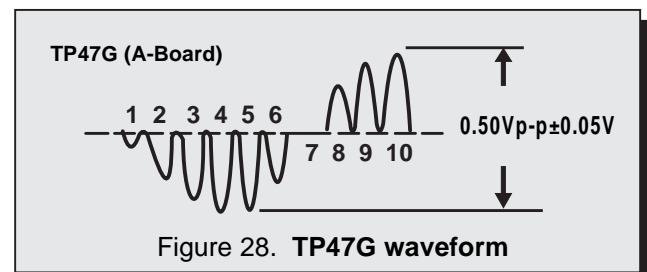

4. Remove short jumper and set RGB GAMMA (S03) DAC to 1.

PIP Sub-Contrast Adjustment (P03)

Procedure:

1. Connect the oscilloscope to TPY1.
2. Apply a color bar signal in main and PIP (PIP on).
3. In the Serviceman Mode for making electronic adjustments, select the DAC adjustment (P03) for PIP Sub-Subcontrast so that child (PIP) level is 90% of parent (MAIN) signal (See Fig. 29)

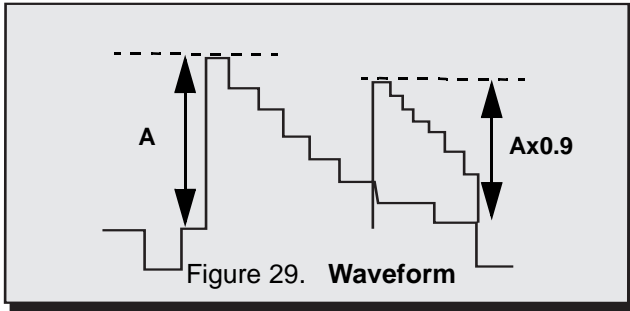

Color Temperature Adjustment (B/W Tracking)

Serviceman DAC Adjust. (C00) (C01) (C02) (C04) (C05) Minor Touch-Up Method

OBSERVE low and high brightness areas of a B/W picture for proper tracking. Adjust only as required for "good gray scale and warm highlights".

1. LOW LIGHT areas – In Serviceman Mode for making electronic adjustments, select Cutoff (C00) RED, (C01) GRN, (C02) BLU and adjust the picture for gray.
2. HIGH LIGHT areas – In Serviceman Mode for making electronic adjustments, select Drive (C04) GRN, (C05) BLU and adjust the picture for warm whites.

Complete Adjustment

Preparation:

1. Turn the Receiver "ON" and allow 10 minutes warm up at high brightness.
2. Apply a color bar signal with color "OFF".
3. Turn the SCREEN control (part of FBT T551) fully counterclockwise.

Procedure:

Preset the following Serviceman DACs for best results:

- C0..... 128
- C1..... 128
- C2..... 128
- C4..... 64
- C5..... 64

1. Connect the oscilloscope to TP37 (L-Board).
2. In Serviceman Mode for making electronic adjustment, select the Sub-Bright DAC (B02).
3. Press the R-Tune key on the remote.

4. Observe the oscilloscope waveform at Horizontal rate and adjust the Serviceman Mode Sub-Bright DAC (B02) level until a scanning period of **2.3±0.05V** above DC ground is measured, as indicated in Fig. 30.

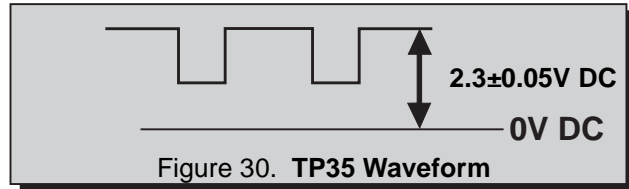

5. Press the R-Tune key on the remote.
6. Connect the scope to RED Cathode (KR) on the CRT-Board.
7. In the Serviceman Mode for making electronic adjustments, select the RED CUTOFF DAC (C00).
8. Press the R-Tune key on the remote.
9. View scope trace at Horizontal rate and adjust the Serviceman Mode DAC (C00) level until a scanning period of **170±2V** above DC ground is measured, as indicated in Fig. 31.
10. Press the R-Tune key on the remote.
11. Write the same C00 data to C01 and C02.
12. Press the R-Tune key on the remote.
13. Turn the Screen Control (part of FBT) slowly clockwise until a slightly color horizontal line appears.
14. Adjust DAC C01 and C02 until the horizontal line becomes white.
15. Press the R-Tune key on the Remote

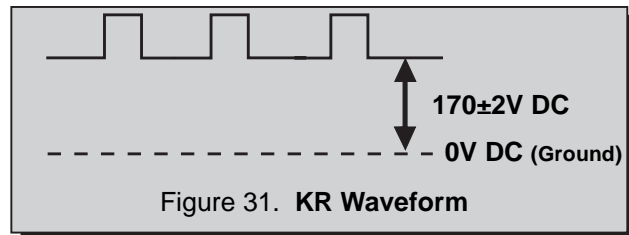

16. In the Serviceman Mode for making electronic adjustments select the DAC DRIVE adjustments (C04) GRN, (C05) BLUE and adjust for warm white in a white color bar pattern.
17. Apply a monoscope pattern and check for a good picture.
18. EXIT the Serviceman Mode.

Service Adjustments (Electronic Controls, cont.)

Horizontal Centering (D00)

This Adjustment helps to center the picture horizontally

Preparation:

Connect a monoscope pattern signal.

Procedure:

1. In the Serviceman Mode for making electronic adjustments. Select the Horizontal Centering Adjustment DAC (D00) and adjust until the center of the monoscope pattern is centered on CRT.
2. EXIT the Serviceman Adjustment Mode.

E-W PCC Adjustment (D0C)

This adjustmet helps to correct left and right sides of picture.

Preparation:

1. Apply a Crosshatch pattern
2. Normalize the Picture Icon Video adjustments.

Procedure:

1. Adjust "D0C" DATA so that the 1st line and 3rd line make a good balance (See Fig. 32).

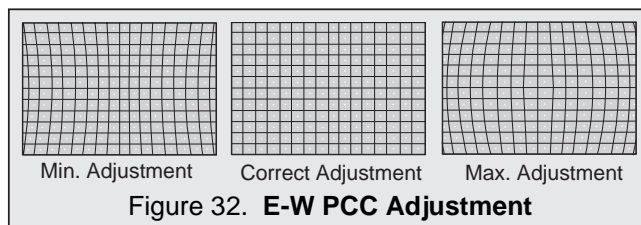

Corner PCC Adjustment (D0B)

Preparation:

1. Apply a Crosshatch pattern
2. Normalize the Picture Icon Video adjustments.

Procedure:

1. To adjust upper and lower linearity.
2. Adjust "D0B" to straighten upper and lower lines (See Fig. 33)

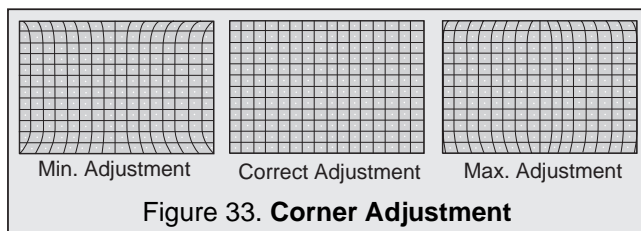

H-Size Adjustment (D0D)

Preparation:

1. Apply a Monoscope pattern

Procedure:

1. Adjust "D0D" DATA so that width "A" and "B" becomes 5.00 ± 0.40 (when using factory pattern) (See Fig. 34).

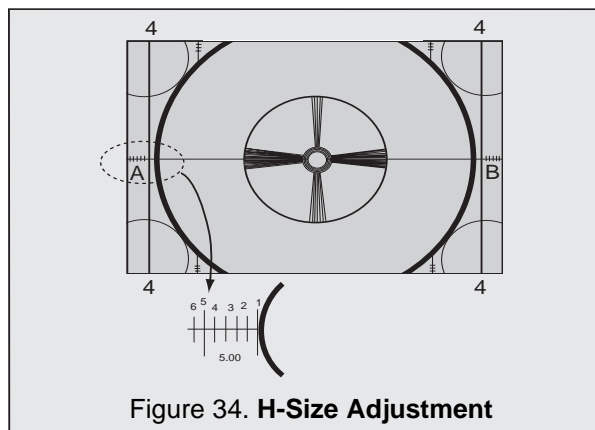

Note: When using a different pattern, correlate with factory pattern.

V-Size and V-Position Adjustment (D01 & D06)

Preparation:

1. Apply a Crosshatch pattern.

Procedure:

1. Apply a monoscope pattern.
2. Enter Serviceman Mode
3. Adjust (D06) to center the picture to the marks on the CRT.
4. Adjust (D01) to make circle of monoscope pattern a round circle.

V-Linearity Adjustment (D03)

Preparation:

1. Apply a Crosshatch pattern

Procedure:

1. Enter Serviceman Mode, Adjust linearity data "D03" so that interval of "a" is same as "b" ($a=b$). (See Fig. 35)

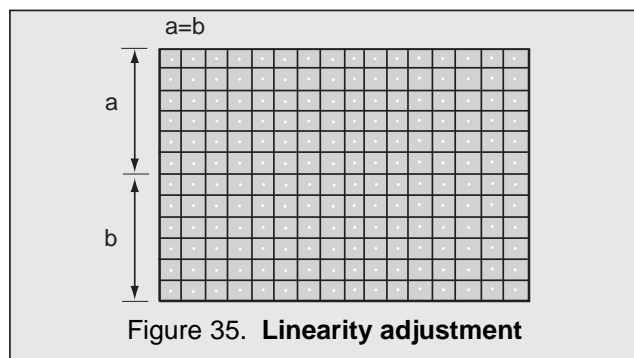

V-Correction Adjustment (D02)

Preparation:

1. Apply a Crosshatch pattern.
2. Adjust (D01) so that V-Size is regular size.
3. If $b-a < -1.5\text{mm}$ (in top and bottom), increase (D02) by one step and adjust (D01) so that V-Size is regular; repeat steps until $b-a \leq 1.5\text{mm}$
4. If $b-a > 1.5\text{mm}$ (in top and bottom), decrease (D02) by one step and adjust (D01) so that V-Size is regular; repeat steps until $b-a \leq 1.5\text{mm}$.

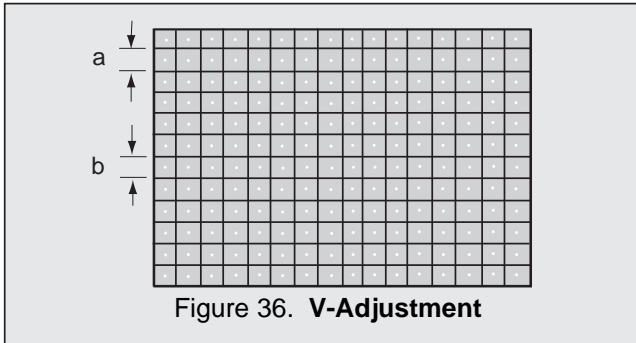

MTS Circuit Adjustments

The MTS Circuit Adjustments require two steps:

1. Input Level Adjustment.
2. Stereo Separation Adjustment.

Input Level Adjustment (M00)

Preparation:

1. Connect an RMS meter with filter jig as shown in Fig. 37.

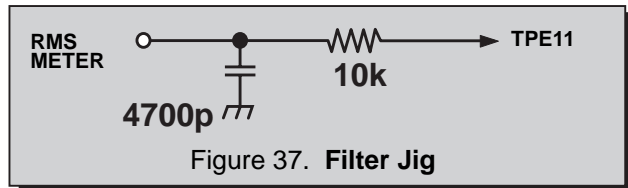

2. Connect an RF signal generator to the RF antenna input.

Procedure:

1. Apply the following signal from the RF signal generator:
Video: 100 IRE flat field, 30% modulation.
Audio: 300Hz, 100% modulation, monaural ($70 \pm 5\text{dB}$, 75Ω OPEN, P/S 10dB).
2. Adjust the MTS Input Level Adjustment (M0) until the voltage measured is $106 \pm 6.0\text{mV rms}$.

Stereo Separation Adjustment (M01 & M02)

Preparation:

1. Connect an RF signal generator to the RF antenna input.
2. Connect oscilloscope to TPE10.

Procedure:

1. Select Stereo Mode in Audio menu
2. Apply the following signal from the RF signal generator:
Video: 100 IRE flat field, 30% modulation.
Audio: 300Hz, 100% modulation, stereo (left only) ($70 \pm 5\text{dB}$, 75Ω OPEN, P/S 10dB).
3. Adjust the MTS Low-Level Separation Adjustment (M01) until the amplitude displayed on the scope is minimum.
4. Apply the following signal from the RF signal generator:
Video: 100 IRE flat field, 30% modulation.
Audio: 3KHz, 100% modulation, stereo (left only) ($70 \pm 5\text{dB}$, 75Ω OPEN, P/S 10dB).
5. Adjust the MTS High-Level Separation Adjustment (M02) until the amplitude displayed on the scope is minimum.
6. Repeat above steps 2 through 5 until the amplitude is minimum for both signals.

Service Adjustments (Electronic Controls, cont.)

Clock Adjustment (S07)

Preparation:

Connect the frequency counter to TPS1 (IC001 pin-13) and cold ground (\nearrow).

Note: *Frequency Counter probe capacitance should be 8pF or less.*

Procedure:

1. Measure TPS1 (IC001 pin 13) for the frequency of the waveform and record the reading.

Note: *Pin 13 measurement must have at least four digits of resolution following the decimal point. Example: 000.0000*

2. Place the Receiver into Serviceman Mode for making electronic adjustment, select the Clock Adjustment DAC (S07).

3. Calculate and set S07 based on the following formula:

$$S07 = 128 + \{873.90625 - pin13[Hz]\}968$$

Figure 38. Set Turned ON

$$S07 = 128 + \{218.47656 - pin13[Hz]\}3873$$

Figure 39. Set Turned OFF

Note: *Pin 13 measurement will not change regardless of the value stored in S07.*

Service Adjustments (Mechanical Controls)

Focus (part of T551)

This adjustment is to make the picture clear

Preparation:

Connect a Signal generator and select a dot pattern.

Procedure:

Adjust the FOCUS controls to obtain the sharpest and clearest dot pattern.

- a. Adjust VF1 to minimize width on vertical lines on corners.
- b. Adjust VF2 to minimize width on horizontal lines on corners.

Free Manuals Download Website

<http://myh66.com>

<http://usermanuals.us>

<http://www.somanuals.com>

<http://www.4manuals.cc>

<http://www.manual-lib.com>

<http://www.404manual.com>

<http://www.luxmanual.com>

<http://aubethermostatmanual.com>

Golf course search by state

<http://golfingnear.com>

Email search by domain

<http://emailbydomain.com>

Auto manuals search

<http://auto.somanuals.com>

TV manuals search

<http://tv.somanuals.com>