

Panasonic®

■ This product is eligible for the AVCCAM 3 Year Warranty Repair Program. For details, see page 9.

Operating Instructions

Memory Card Camera-Recorder

Model No. **AG-3DA1P**

Model No. **AG-3DA1E**

AVCCAM

3D PROFESSIONAL

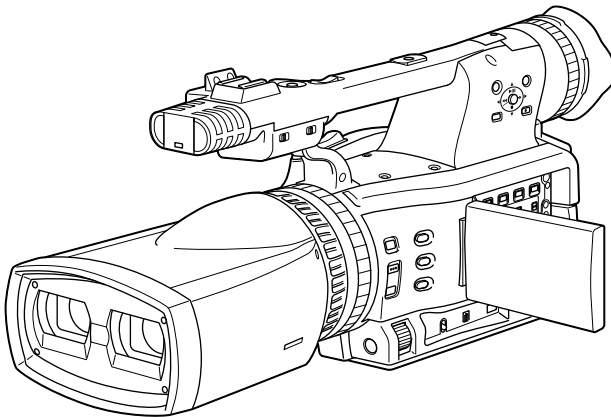

AVCHD™

Before operating this product, please read the instructions carefully and save this manual for future use.

SS0710AS1080 -PS 

Printed in Japan

ENGLISH

VQT2Z46-1

Download from Www.Somanuals.com. All Manuals Search And Download.

Before use

Description of parts

Preparation

Shooting

Playback

Editing

Displays

Menu

Reference

Read this first! (For AG-3DA1P)

 indicates safety information.



CAUTION
RISK OF ELECTRIC SHOCK
DO NOT OPEN



CAUTION: TO REDUCE THE RISK OF ELECTRIC SHOCK, DO NOT REMOVE COVER (OR BACK). NO USER-SERVICEABLE PARTS INSIDE. REFER TO SERVICING TO QUALIFIED SERVICE PERSONNEL.



The lightning flash with arrowhead symbol, within an equilateral triangle, is intended to alert the user to the presence of uninsulated "dangerous voltage" within the product's enclosure that may be of sufficient magnitude to constitute a risk of electric shock to persons.



The exclamation point within an equilateral triangle is intended to alert the user to the presence of important operating and maintenance (servicing) instructions in the literature accompanying the appliance.

WARNING:

This equipment must be grounded. To ensure safe operation, the three-pin plug must be inserted only into a standard three-pin power outlet which is effectively grounded through normal household wiring. Extension cords used with the equipment must have three cores and be correctly wired to provide connection to the ground. Wrongly wired extension cords are a major cause of fatalities.

The fact that the equipment operates satisfactorily does not imply that the power outlet is grounded or that the installation is completely safe. For your safety, if you are in any doubt about the effective grounding of the power outlet, please consult a qualified electrician.

WARNING:

- To reduce the risk of fire or electric shock, do not expose this equipment to rain or moisture.
- To reduce the risk of fire or electric shock hazard, keep this equipment away from all liquids. Use and store only in locations which are not exposed to the risk of dripping or splashing liquids, and do not place any liquid containers on top of the equipment.

WARNING:

Always keep memory cards (optional accessory) or accessories (screw spacer, microphone holder screws, microphone holder adapter, INPUT terminal covers) out of the reach of babies and small children.

CAUTION:

To reduce the risk of fire or electric shock and annoying interference, use the recommended accessories only.

CAUTION:

Do not jar, swing, or shake the unit by its handle. Any strong jolt to the handle may damage the unit or result in personal injury.

CAUTION:

The mains plug of the power supply cord shall remain readily operable. The AC receptacle (mains socket outlet) shall be installed near the equipment and shall be easily accessible. To completely disconnect this equipment from the AC mains, disconnect the power cord plug from the AC receptacle.

CAUTION:

Danger of explosion or fire if battery is mistreated.

- Do not leave the battery in an automobile exposed to direct sunlight for a long period of time with doors and windows closed.
- Do not disassemble the battery or dispose of it in fire.
- Do not store in temperatures over 60 °C (140 °F).
- Use specified battery charger.
- Replace only with same or specified type.

CAUTION:

In order to maintain adequate ventilation, do not install or place this unit in a bookcase, built-in cabinet or any other confined space. To prevent risk of electric shock or fire hazard due to overheating, ensure that curtains and any other materials do not obstruct the ventilation.

CAUTION:

Do not lift the unit by its handle while the tripod is attached. When the tripod is attached, its weight will also affect the unit's handle, possibly causing the handle to break and hurting the user. To carry the unit while the tripod is attached, take hold of the tripod.

CAUTION:

Excessive sound pressure from earphones and headphones can cause hearing loss.

 indicates safety information.

CAUTION:

Do not leave the unit in direct contact with the skin for long periods of time when in use. Low temperature burn injuries may be suffered if the high temperature parts of this unit are in direct contact with the skin for long periods of time. When using the equipment for long periods of time, make use of the tripod.

CAUTION:

This apparatus can be operated at a voltage in the range of 110 – 240 V AC. Voltages other than 120 V are not intended for U.S.A. and Canada. Operation at a voltage other than 120 V AC may require the use of a different AC plug. Please contact either a local or foreign Panasonic authorized service center for assistance in selecting an alternate AC plug.

FCC NOTICE (USA)

This device complies with part 15 of the FCC Rules. Operation is subject to the following two conditions:

(1) This device may not cause harmful interference, and (2) this device must accept any interference received, including interference that may cause undesired operation

CAUTION:

This equipment has been tested and found to comply with the limits for a Class B digital device, pursuant to Part 15 of the FCC Rules. These limits are designed to provide reasonable protection against harmful interference in a residential installation. This equipment generates, uses and can radiate radio frequency energy and, if not installed and used in accordance with the instructions, may cause harmful interference to radio communications. However, there is no guarantee that interference will not occur in a particular installation. If this equipment does cause harmful interference to radio or television reception, which can be determined by turning the equipment off and on, the user is encouraged to try to correct the interference by one of the following measures:

- Reorient or relocate the receiving antenna.
- Increase the separation between the equipment and receiver.
- Connect the equipment into an outlet on a circuit different from that to which the receiver is connected.
- Consult the dealer or an experienced radio/TV technician for help.

The user may find the booklet "Something About Interference" available from FCC local regional offices helpful.

FCC Warning:

To assure continued FCC emission limit compliance, follow the attached installation instructions and the user must use only shielded interface cables when connecting to host computer or peripheral devices. Also any unauthorized changes or modifications to this equipment could void the user's authority to operate this device.

NOTIFICATION (Canada)

This class B digital apparatus complies with Canadian ICES-003.



A lithium ion/polymer battery that is recyclable powers the product you have purchased.

Please call 1-800-8-BATTERY for information on how to recycle this battery.

For USA-California Only

This product contains a CR Coin Cell Lithium Battery which contains Perchlorate Material – special handling may apply.

See www.dtsc.ca.gov/hazardouswaste/perchlorate.

IMPORTANT SAFETY INSTRUCTIONS

- 1) Read these instructions.
- 2) Keep these instructions.
- 3) Heed all warnings.
- 4) Follow all instructions.
- 5) Do not use this apparatus near water.
- 6) Clean only with dry cloth.
- 7) Do not block any ventilation openings. Install in accordance with the manufacturer's instructions.
- 8) Do not install near any heat sources such as radiators, heat registers, stoves, or other apparatus (including amplifiers) that produce heat.
- 9) Do not defeat the safety purpose of the polarized or grounding-type plug. A polarized plug has two blades with one wider than the other. A grounding-type plug has two blades and a third grounding prong. The wide blade or the third prong are provided for your safety. If the provided plug does not fit into your outlet, consult an electrician for replacement of the obsolete outlet.
- 10) Protect the power cord from being walked on or pinched particularly at plugs, convenience receptacles, and the point where they exit from the apparatus.
- 11) Only use attachments/accessories specified by the manufacturer.
- 12) Use only with the cart, stand, tripod, bracket, or table specified by the manufacturer, or sold with the apparatus. When a cart is used, use caution when moving the cart/ apparatus combination to avoid injury from tip-over.
- 13) Unplug this apparatus during lightning storms or when unused for long periods of time.
- 14) Refer all servicing to qualified service personnel. Servicing is required when the apparatus has been damaged in any way, such as power-supply cord or plug is damaged, liquid has been spilled or objects have fallen into the apparatus, the apparatus has been exposed to rain or moisture, does not operate normally, or has been dropped.



Note:

Camera-Recorder

The rating plate is on the underside of the viewfinder.

Battery Charger / AC Adaptor

The rating plate is on the underside of the Battery Charger and AC Adaptor. Disconnect the AC mains plug from the AC mains socket when not in use.



Conforms to ANSI/UL Std. 60065

Read this first! (For AG-3DA1E)

 indicates safety information.

WARNING:

This equipment must be earthed. To ensure safe operation, the three-pin plug must be inserted only into a standard three-pin power point which is effectively earthed through normal household wiring. Extension cords used with the equipment must have three cores and be correctly wired to provide connection to the earth. Wrongly wired extension cords are a major cause of fatalities. The fact that the equipment operates satisfactorily does not imply that the power point is earthed or that the installation is completely safe. For your safety, if you are in any doubt about the effective earthing of the power point, please consult a qualified electrician.

WARNING:

- To reduce the risk of fire or electric shock, do not expose this equipment to rain or moisture.
- To reduce the risk of fire or electric shock hazard, keep this equipment away from all liquids. Use and store only in locations which are not exposed to the risk of dripping or splashing liquids, and do not place any liquid containers on top of the equipment.

WARNING:

Always keep memory cards (optional accessory) or accessories (screw spacer, microphone holder screws, microphone holder adapter, INPUT terminal covers) out of the reach of babies and small children.

CAUTION:

Do not remove panel covers by unscrewing them. To reduce the risk of electric shock, do not remove the covers. No user serviceable parts inside. Refer servicing to qualified service personnel.

CAUTION:

To reduce the risk of fire or electric shock and annoying interference, use the recommended accessories only.

CAUTION:

Do not jar, swing, or shake the unit by its handle. Any strong jolt to the handle may damage the unit or result in personal injury.

CAUTION:

The mains plug of the power supply cord shall remain readily operable. The AC receptacle (mains socket outlet) shall be installed near the equipment and shall be easily accessible. To completely disconnect this equipment from the AC mains, disconnect the power cord plug from the AC receptacle.

CAUTION:

Danger of explosion or fire if battery is mistreated.

- Do not leave the battery in an automobile exposed to direct sunlight for a long period of time with doors and windows closed.
- Do not disassemble the battery or dispose of it in fire.
- Do not store in temperatures over 60 °C (140 °F).
- Use specified battery charger.
- Replace only with same or specified type.

CAUTION:

In order to maintain adequate ventilation, do not install or place this unit in a bookcase, built-in cabinet or any other confined space. To prevent risk of electric shock or fire hazard due to overheating, ensure that curtains and any other materials do not obstruct the ventilation.

CAUTION:

Do not lift the unit by its handle while the tripod is attached. When the tripod is attached, its weight will also affect the unit's handle, possibly causing the handle to break and hurting the user. To carry the unit while the tripod is attached, take hold of the tripod.

CAUTION:

Excessive sound pressure from earphones and headphones can cause hearing loss.

CAUTION:

Do not leave the unit in direct contact with the skin for long periods of time when in use. Low temperature burn injuries may be suffered if the high temperature parts of this unit are in direct contact with the skin for long periods of time. When using the equipment for long periods of time, make use of the tripod.

Note:

Camera-Recorder

The rating plate is on the underside of the viewfinder.

Battery Charger / AC Adaptor

The rating plate is on the underside of the Battery Charger and AC Adaptor. Disconnect the AC mains plug from the AC mains socket when not in use.

 indicates safety information.

Caution for AC Mains Lead

For battery charger

FOR YOUR SAFETY PLEASE READ THE FOLLOWING TEXT CAREFULLY.

This product is equipped with 2 types of AC mains cable. One is for continental Europe, etc. and the other one is only for U.K.

Appropriate mains cable must be used in each local area, since the other type of mains cable is not suitable.

FOR CONTINENTAL EUROPE, ETC.
Not to be used in the U.K.

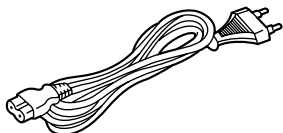

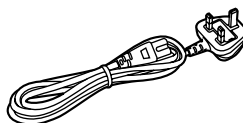

FOR U.K. ONLY



FOR U.K. ONLY

This appliance is supplied with a moulded three pin mains plug for your safety and convenience.

A 5 amp fuse is fitted in this plug. Should the fuse need to be replaced please ensure that the replacement fuse has a rating of 5 amps and that it is approved by ASTA or BSI to BS1362.

Check for the ASTA mark  or the BSI mark  on the body of the fuse.

If the plug contains a removable fuse cover you must ensure that it is refitted when the fuse is replaced.

If you lose the fuse cover the plug must not be used until a replacement cover is obtained.

A replacement fuse cover can be purchased from your local Panasonic Dealer.

How to replace the fuse

1. Open the fuse compartment with a screwdriver.

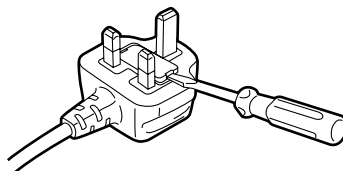

2. Replace the fuse

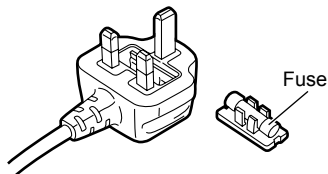

EEE Yönetmeliğine Uygundur.
EEE Complies with Directive of Turkey.

 indicates safety information.

Caution for AC Mains Lead For AC adaptor

FOR YOUR SAFETY PLEASE READ THE FOLLOWING TEXT CAREFULLY.

This product is equipped with 2 types of AC mains cable. One is for continental Europe, etc. and the other one is only for U.K.

Appropriate mains cable must be used in each local area, since the other type of mains cable is not suitable.

FOR CONTINENTAL EUROPE, ETC.
Not to be used in the U.K.

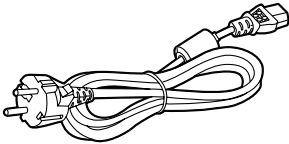

FOR U.K. ONLY

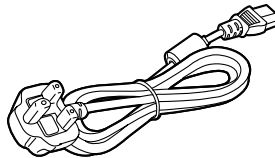



FOR U.K. ONLY

This appliance is supplied with a moulded three pin mains plug for your safety and convenience.

A 5 amp fuse is fitted in this plug.

Should the fuse need to be replaced please ensure that the replacement fuse has a rating of 5 amps and that it is approved by ASTA or BSI to BS1362.

Check for the ASTA mark  or the BSI mark  on the body of the fuse.

If the plug contains a removable fuse cover you must ensure that it is refitted when the fuse is replaced.

If you lose the fuse cover the plug must not be used until a replacement cover is obtained.

A replacement fuse cover can be purchased from your local Panasonic Dealer.

How to replace the fuse

1. Open the fuse compartment with a screwdriver.

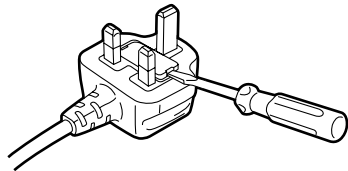

2. Replace the fuse

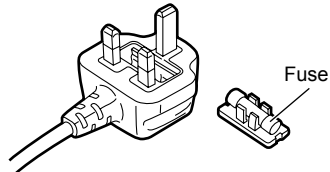

EMC NOTICE FOR THE PURCHASER/USER OF THE APPARATUS

1. Applicable standards and operating environment

The apparatus is compliant with:

- standards EN55103-1 and EN55103-2 2009, and
- electromagnetic environments E1, E2, E3 and E4.

2. Pre-requisite conditions to achieving compliance with the above standards

<1> **Peripheral equipment to be connected to the apparatus and special connecting cables**

- The purchaser/user is urged to use only equipment which has been recommended by us as peripheral equipment to be connected to the apparatus.
- The purchaser/user is urged to use only the connecting cables described below.

<2> **For the connecting cables, use shielded cables which suit the intended purpose of the apparatus.**

- Video signal connecting cables
Use double shielded coaxial cables, which are designed for 75-ohm type high-frequency applications, for SDI (Serial Digital Interface).
Coaxial cables, which are designed for 75-ohm type high-frequency applications, are recommended for analog video signals.
- Audio signal connecting cables
If your apparatus supports AES/EBU serial digital audio signals, use cables designed for AES/EBU.
Use shielded cables, which provide quality performance for high-frequency transmission applications, for analog audio signals.
- Other connecting cables (IEEE1394, USB)
Use shielded cables, which provide quality performance for high-frequency applications, as connecting cables.
- When connecting to the DVI signal terminal, use a cable with a ferrite core.
- If your apparatus is supplied with ferrite core(s), they must be attached on cable(s) following instructions in this manual.

3. Performance level

The performance level of the apparatus is equivalent to or better than the performance level required by these standards.

However, the apparatus may be adversely affected by interference if it is being used in an EMC environment, such as an area where strong electromagnetic fields are generated (by the presence of signal transmission towers, cellular phones, etc.). In order to minimize the adverse effects of the interference on the apparatus in cases like this, it is recommended that the following steps be taken with the apparatus being affected and with its operating environment:

1. Place the apparatus at a distance from the source of the interference.
2. Change the direction of the apparatus.
3. Change the connection method used for the apparatus.
4. Connect the apparatus to another power outlet where the power is not shared by any other appliances.

Pursuant to at the directive 2004/108/EC, article 9(2)

Panasonic Testing Centre

Panasonic Service Europe, a division of Panasonic Marketing Europe GmbH
Winsbergring 15, 22525 Hamburg, F.R. Germany

Read this first! (For AG-3DA1P/AG-3DA1E)

Recommendation for Use of Genuine Panasonic Battery (Rechargeable Battery)

Thank you for using a Panasonic product.

It has been found that counterfeit battery packs which look very similar to the genuine product are made available to purchase in some markets. Some of these battery packs are not adequately protected with internal protection to meet the requirements of appropriate safety standards. There is a possibility that these battery packs may lead to fire or explosion. Please be advised that we are not liable for any accident or failure occurring as a result of use of a counterfeit battery pack. To ensure that safe products are used we would recommend that a genuine Panasonic battery pack is used.

- Be aware that many batteries sold at extremely cheap prices or in situations where it is difficult to verify the actual products before purchase have proven to be counterfeit.

■ Batteries that may be used with this product (Correct as of August 2010)

Panasonic CGA-D54 batteries may be used with the AG-3DA1P.

Panasonic CGA-D54s batteries may be used with the AG-3DA1E.

To remove the battery



Main Power Battery

(Refer to page 24 for the detail.)

Press the battery release button.

Back-up Battery

- For the removal of the battery for disposal at the end of its service life, please consult your dealer.

Battery release button

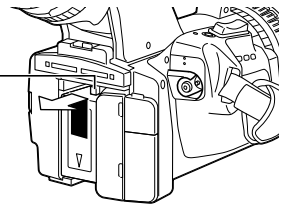

3D image shooting/viewing

- Do not set a wide parallax (parallax between the left and right eyes) when shooting a 3D image. Viewing the 3D image shot with a wide parallax may cause eyestrain or other adverse effects. For details on the parallax, see "Adjusting the convergence point." (Page 38)
- When viewing 3D images, observe the viewing precautions indicated in the operating instructions of the monitor. If you continue viewing 3D images in incorrect conditions, it may cause eyestrain or other adverse effects.

AVCCAM 3 Year Warranty Repair Program*1

Thank you for purchasing this Panasonic AVCCAM device.

Register as a user for this device to receive a special service warranty up to three years of free warranty repairs.

Customers who register as users on the website will receive an extended warranty repair valid for up to three years.



	1st year	2nd year	3rd year
AVCCAM device*2	Basic warranty*3	Extended warranty repair*4	

*1: Please note that this extended warranty is not available in some countries/regions. *2: Not all models eligible for extended warranty coverage.
*3: The basic warranty period may vary depending on the country/region. *4: Not all repair work is covered by this extended warranty.



Purchase AVCCAM product



Register online within 1 month



"Registration Notice" e-mail sent

Free 3 years of Warranty Repairs

Make sure to save the "Registration Notice" e-mail during the warranty period.

Details about user registration and the extended warranty: http://panasonic.biz/sav/pass_e
Please note, this is a site that is not maintained by Panasonic Canada Inc. The Panasonic Canada Inc. privacy policy does not apply and is not applicable in relation to any information submitted. This link is provided to you for convenience.

- SDHC Logo is a trademark of SD-3C, LLC.
- “AVCHD” and the “AVCHD” logo are trademarks of Panasonic Corporation and Sony Corporation.
- This product has been manufactured under license from Dolby Laboratories.
Dolby and the double-D symbol are trademarks of Dolby Laboratories.
- HDMI, the HDMI logo, and High-Definition Multimedia Interface are trademarks or registered trademarks of HDMI Licensing LLC in the United States and/or other countries.
- Microsoft®, Windows®, and Windows Vista® are either registered trademarks or trademarks of Microsoft Corporation in the United States and/or other countries.
- Screenshots are used in accordance with Microsoft Corporation guidelines.
- IBM and PC/AT are registered trademarks of International Business Machines Corporation.
- Intel® is a registered trademark or a trademark of Intel Corporation in the United States and/or other countries.
- Apple®, Macintosh®, and Mac OS® are trademarks of Apple Inc., registered in the United States and other countries.
- Other model names, company names, and product names listed in these operating instructions are trademarks or registered trademarks of their respective companies.
- This product is licensed under the AVC Patent Portfolio License for the personal and non-commercial use of a consumer, and no license is granted or shall be implied for any use other than the personal uses detailed below.
 - To encode video in compliance with the AVC standard (“AVC Video”)
 - To decode AVC Video that was encoded by a consumer engaged in a personal and non-commercial activity
 - To decode AVC Video that was obtained from a video provider licensed to provide AVC Video
 - Additional information may be obtained from MPEG LA, LLC (<http://www.mpegla.com>).
 - Separate license contracts must be obtained from MPEG LA where SD Memory Cards containing information recorded with this product are to be distributed to end users for commercial purposes. “End user” refers to persons or organizations handling such contents for personal use.

Note concerning illustrations in these instructions

- Illustrations (camera-recorder, menu screens, etc.) in these operating instructions differ slightly from the actual camera-recorder.

References

- References are shown as (Page 00).

Terminology

- Both SD Memory Cards and SDHC Memory Cards as referred to as “SD Memory Cards” in these operating instructions.
- Video that is created during a single recording operation is referred to as a “clip” in these operating instructions.

Overview

This camera-recorder is an integrated 3D camera-recorder equipped with twin lenses in a single body. The twin-lens system allows you to adjust the convergence point within the camera and record 3D images with natural sense of depth.

The main features of the unit are as follows:

- Compact and lightweight, with high mobility.
- Easy 3D recording with no need for adjusting two lenses.
- Use of two SD Memory Cards allows simultaneous recording/playback of two channels (AVCHD, PH mode).
- Two-channel HD SDI outputs (L and R channels) and HDMI (3D) output are provided for 3D video signals.

3D image and convergence point

When shooting

When viewing a 3D image

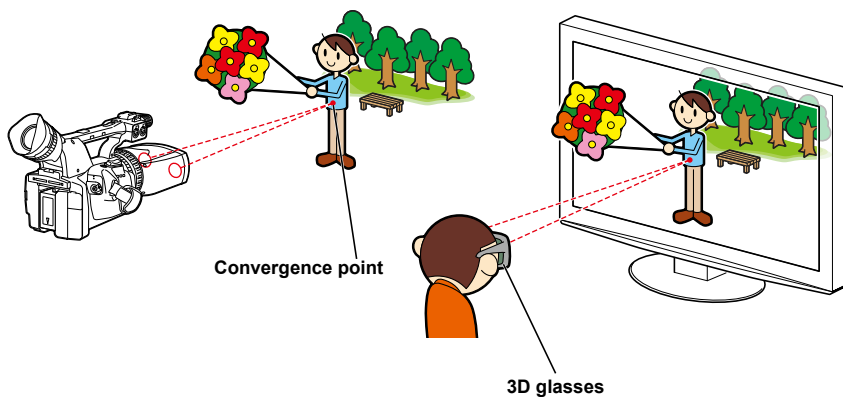

- The illustration above is an image for explanation.

The convergence point is a point where the optical axes of the left and right lenses converge. This indicates the reference plane when viewing a 3D image.

When shooting, adjust the convergence point by shooting the subject you want to set on the reference plane so that the image of the subject from the left lens is completely superimposed onto that from the right lens.

When viewing the 3D image, a subject located closer than the convergence point is displayed in front of the screen, and a subject located farther than the convergence point is displayed behind the screen.

Contents

Read this first! (For AG-3DA1P)	2
Read this first! (For AG-3DA1E)	5
Read this first! (For AG-3DA1P/AG-3DA1E)	9
Overview	11
Operating precautions	14

Before use

Precaution for use	16
SD Memory Cards compatible with this product	17
CLASS 4 (SD speed class 4)	18
SDHC Memory Cards	18
Compatibility with equipment other than AG-3DA1 (this product)	18
About AVCHD	18
Accessories	19
Optional accessories	19

Description of parts

Description of parts	20
Right side and rear side	20
Left side	21
Terminals and mounting parts	22

Preparation

Charging the battery	23
Charging	23
Power sources	24
Using the battery	24
Using the AC adaptor	24
Turn on/off the camera	25
Tally lamp	25
Viewfinder	26
Using the viewfinder	26
Using the LCD	27
Emphasizing outlines	27
Setting the calendar	28

Shooting

Basic shooting operations	30
Preparing for recording	30
Formatting a card	30
Basic shooting operation	31
Checking photos taken (REC CHECK)	31
SD Memory Card access lamps	32
SD Memory Card recording times	32
Removing SD Memory Cards	33
Protecting SD Memory Cards	33
Repairing SD Memory Cards	33
Using the zoom function	34
Shooting in progressive mode	35
Adjusting the focus	36
Manual focusing	36
Using focus assist	36
Adjusting the brightness	37
Adjusting the convergence point	38
Tips on convergence point adjustment	38
Adjusting the white balance	40
White balance adjustments	40
Using presets	40
Black balance adjustments	41
Shooting techniques for different targets	42
Low angle recording	42
Zebra pattern	42
Checking and displaying shooting status	43
Using the USER buttons	43
Color bars	43
Wave form monitor function	44
Adjusting the volume while shooting	44
Shot mark function	44
3D FINE function	45
Adjusting the shutter speed	46
Synchro scan	47
Switching Audio Input	48
Using the built-in microphone	48
Using an external microphone and audio equipment	48
Adjusting the recording level	49
Clip metadata	50
Uploading the metadata (META DATA)	51
Selecting the USER CLIP NAME recording method	52
Using the Counter	53
Charging the built-in battery/Setting the time code	54
Recharging the built-in battery	54
Setting the time code	54
Specifying the time code (TC PRESET)	54
Setting user information	56

Playback

Basic playback operations	57
Thumbnail screen	58
Basic thumbnail screen operations	58
Adding shot marks to clips	59
Playback settings (PLAY SETUP)	60
Resume playback (RESUME PLAY)	60
Thumbnail operations	61
Selecting the thumbnail display method (THUMBNAIL SETUP)	61
Deleting and protecting clips (OPERATION)	62
Checking clip information (CARD FUNCTIONS)	63
Useful playback functions	64
Fast forward/rewind	64
Next/previous clip	64
Frame-by-frame playback	65
Adjust volume	65
Viewing images on a monitor or television ...	65
Checking the date and time.....	65

Editing

Connecting external units	66
Headphones	66
External microphone	66
TV/Monitor.....	67

Displays

Screen displays	68
Regular displays	68
Main warning displays	71
Setting the DISPLAY items	74

Menu

Using the setup menus	75
Using the menus	75
Initializing the menu settings	76
Setup menu structure	77
Camera mode menu.....	77
Playback mode menu	77
Setup menu list	78
CAMERA SETUP screen.....	78
SW MODE screen	79
RECORDING SETUP screen.....	80
TC/UB SETUP screen	80
AV OUT SETUP screen.....	81
DISPLAY SETUP screen	81
CARD FUNCTIONS screen	82
META DATA screen	82
OTHER FUNCTIONS screen	83
PLAY SETUP screen	84
THUMBNAIL SETUP screen	84
OPERATION screen.....	84

Reference

Before calling for service	85
Updating the firmware in the camera	87
Cleaning	88
Storage Precautions	89
Recording format	90
How to handle data recorded on SD Memory Card	91
Specifications	92
Index	94

Operating precautions

Do not allow any water to get into the camera-recorder when using it in the rain or snow or at the beach.

- Failure to heed this caution will cause the camera-recorder or a card to malfunction (and may result in irreparable damage).

Keep the camera-recorder away from equipment (such as TV sets and video game machines) that generate magnetic fields.

- Using the camera-recorder on top of or near a TV set may cause distortion in the images and/or sound due to the electromagnetic waves that the set emits.
- The powerful magnetic fields generated by speakers or large motors may damage your recordings or distort the images.
- The electromagnetic waves emitted from a microcomputer will adversely affect the camera-recorder, causing the images and/or sound to be distorted.
- If the camera-recorder is so adversely affected by products that generate magnetic fields that it no longer operates properly, turn it off and remove the battery or unplug the AC adaptor from the power outlet. Then install the battery again or reconnect the AC adaptor. After this, turn the camera-recorder back on.

Do not use the camera-recorder near radio transmitters or high-voltage equipment.

- Using the camera-recorder near a radio transmitter or high-voltage equipment may adversely affect the recorded images and/or sound.

Do not allow any sand or dust to get into the camera-recorder when using it at the beach and other similar places.

- Sand and dust can damage the camera-recorder or a card. (Be especially careful when inserting or removing a card.)

Battery charger and battery

- If the CHARGE lamp continues to blink even when the battery temperature is normal, there may be something wrong with the battery or battery charger. Contact your dealer.
- The battery takes longer to charge when it is warm.
- The battery charger can interfere with radio reception so keep radios at least 1 meter away from it.

- The battery charger may make some noise when you are using it, but this is normal.

Take precautions not to drop the camera-recorder when moving it.

- Strong impacts may damage the camera-recorder and cause it to stop working.
- Strong shock may lead to vertical misalignment of the images from the two lenses.
- Handle the camera-recorder with care, securely gripping the handle or hand strap to carry it.

Do not spray the camera-recorder with insect sprays or other volatile substances.

- These can warp the camera-recorder or cause the finish to come off.
- Do not leave the camera-recorder in contact with rubber or PVC products for extended periods of time.

After use, remove the battery and disconnect the AC power supply cable.

Battery characteristics

This camera-recorder uses a rechargeable lithiumion battery that uses its internal chemical reaction to generate electrical energy. This reaction is easily influenced by the ambient temperature and humidity, and the battery's effective operating time is reduced as the temperature rises or falls. In very low temperatures, the battery may last only 5 minutes.

Protective circuitry functions if you use the battery where it is very hot and you will have to wait before you can use it again.

Remove the battery after use.

Completely remove the battery. (The battery continues to be used even if you have turned the camera-recorder off.) The battery can over discharge if you leave it in the camera-recorder and it may become impossible to recharge it.

Disposing of spent batteries

The battery will become unchargeable. Rather than throwing the battery into the garbage, take it to a store that can assist in recycling it.

What to remember when throwing memory cards away or transferring them to others

Formatting memory cards or deleting data using the functions of the unit or a computer will merely change the file management information: it will not completely erase the data on the cards. When throwing these cards away or transferring them to others, either physically destroy them or use a data deletion program for computers (commercially available) to completely erase the data. Users are responsible for managing the data on their memory cards.

Liquid crystal displays

- Images or letters can get burned onto the screen of the LCD or viewfinder if they are displayed for a long time, but you can fix this by leaving the camera-recorder off for several hours.
- The pixels of the LCD monitor are controlled to obtain high precision with 99.99 % of the effective pixels. This leaves less than 0.01 % of pixels that may not light or may remain on all the time. These phenomena are normal and will have no effect on the images you shoot.
- Condensation may form if you use the camera-recorder where temperatures fluctuate. Wipe dry with a soft, dry cloth.
- The LCD may appear dim after immediately turning on a cold camera-recorder, but will brighten as the camera-recorder warms up.

Do not point the lens or viewfinder at the sun.

Doing so may damage the parts inside.

Protective caps for the connectors

Keep the protective caps fitted over any connectors that are not being used.

Precaution for use

Always take some trial shots before actual shooting.

- When shooting important events (such as weddings), always take some trial shots and check that the sound and images have been recorded properly before actual shooting.

Be sure to check and set the calendar and time zone.

- These settings affect the control and playback sequence of the recorded contents. Before making a recording, set and check the calendar and time zone. (Page 28)

Panasonic makes no guarantees for your recordings.

- Please understand that Panasonic makes no guarantees for your recordings in cases where images and/ or sound were not recorded as you intended due to problems with the camera-recorder or SD/SDHC Memory Cards.

Respect copyrights

- Copyright laws forbid the use of video and audio material you have recorded for any purpose other than your own personal enjoyment. Remember that restrictions apply to the shooting of certain material even if it is intended for private use.

Caution regarding laser beams

- The MOS may be damaged if it is subjected to light from a laser beam.
When using the camera-recorder in locations where laser irradiation equipment is used, be careful not to allow the laser beam to shine directly on the lens.

Media that can be used in this unit

- SD/SDHC Memory Cards can be used in this unit. For details, refer to page 17.

Mounting the camera-recorder on a tripod

- There are tripod mounting holes that are compatible with 1/4-20UNC screws. A removable screw spacer is installed in one of the screw holes, which is compatible with 3/8-16UNC screws when the screw spacer is removed. Use the size that matches the diameter of the tripod's fixing screw. To remove the screw spacer, use a slot screwdriver.
- The tripod mounting hole is 5.5 mm deep. Do not force the tripod screw beyond this depth.

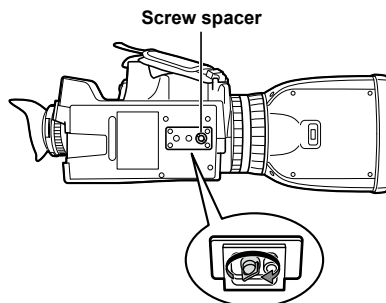

Attach the tripod to the tripod hole.

SD Memory Cards compatible with this product

Use SD Memory Cards or SDHC Memory Cards of SD speed class 4 or above. It is recommended that you use the Panasonic SDHC Memory Cards listed below (correct as of August 2010).

- SDXC cards are not available for this product.

Card type	Recording capacity	Recording/playback
SD Memory Card	512 MB	RP-SDV512
	1 GB	RP-SDV01G RP-SDM01G
	2 GB	RP-SDV02G RP-SDM02G
SDHC Memory Card	4 GB	RP-SDV04G RP-SDM04G RP-SDW04G RP-SDP04G
	6 GB	RP-SDM06G
	8 GB	RP-SDV08G RP-SDM08G RP-SDW08G RP-SDP08G
	12 GB	RP-SDM12G RP-SDP12G
	16 GB	RP-SDV16G RP-SDM16G RP-SDW16G RP-SDP16G
	32 GB	RP-SDV32G RP-SDW32G RP-SDP32G

- Please see our support page at the following website for the latest information not included in these operating instructions.
<http://pro-av.panasonic.net/>
- This product is compatible with SD Memory Cards formatted under the SD-standard FAT12 and FAT16 formats, and with SDHC Memory Cards formatted under the FAT32 format.
- Only SDHC Memory Cards may be used for capacities of 4 GB or greater.
- 4 GB (or greater) memory cards without the SDHC logo are not based on the SD standard.
- Use this product to format the SD Memory Cards to be used. Formatting memory cards on computers or other devices may cause recording to take longer than normal, or may cause cards to become incompatible with this product. (Page 30) (Use this product to reformat any cards that have already been formatted on computers, etc.)
- Always install the relevant special adapter when using microSD/microSDHC cards with this product. (The product will not operate correctly if only the adapter is inserted – always insert a memory card into the adapter first.)
- MultiMediaCards cannot be used with this product.
- SD/SDHC Memory Cards with a memory size from 8 MB to 32 GB can be used to read metadata.

Precaution for use (continued)

CLASS 4 (SD speed class 4)

This refers to a class 4 speed standard (SD speed class) for the continuous writing of data between SD-compatible devices and SD Memory Cards, as designated by the SD standards.

When the use of an SD speed class 4 card is recommended for SD-compatible products, this indicates that stable recording operation can be achieved when using SD Memory Cards of class 4 and above.

Cautions for usage

- Do not allow dirt, water, or other substances to come into contact with the connector part on the reverse of the card.
- Do not leave the card in the following places:
 - In direct sunlight or in places of high humidity, e.g. close to heating equipment
 - In highly humid or dusty locations
 - In locations with high variations in temperature (condensation may appear on card)
 - In places subject to static electricity or electromagnetic waves
- Store cards in bags or cases after use.

SDHC Memory Cards

- SDHC Memory Cards cannot be used with non-SDHC-compatible equipment.
- Ensure that all equipment is SDHC-compatible when using card with other devices.



To play back 3D images shot with this product, use the PB mode of this product. Note the following when you play back clips of either the left or right channel of the 3D image.

Compatibility with equipment other than AG-3DA1 (this product)







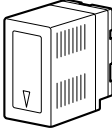
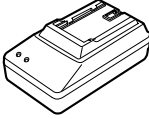
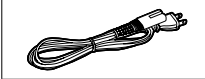

- Recorded video cannot be used with non-AVCHD-compatible equipment.
For details, please see your product's operating instructions.
- Recorded video cannot be played back on non-compatible (non-AVCHD-compatible) equipment.
- Playback may not always be possible on all AVCHD-compatible equipment.
Clip information such as meta data and 3D information cannot be read with AVCHD-compatible equipment other than this product.
- If you perform additional recording or delete clips with another equipment, the 3D information is lost and playback or recording is no longer possible with the product.

About AVCHD

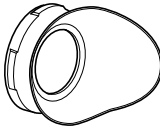
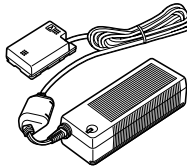
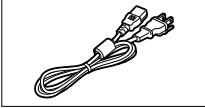
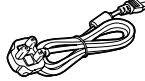
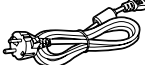
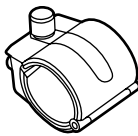
- AVCHD is a standard for the recording and playback of highly detailed, high-definition video.
- Video is compressed in the MPEG-4 AVC/H.264 formats, and audio is recorded in Dolby Digital.

Accessories

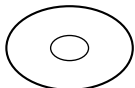
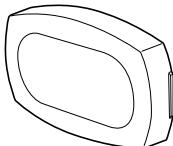
Before use

<p>Battery</p>  <p>For part numbers for the battery, see "Optional accessories" below.</p>	<p>Battery charger / AC power supply cables</p> <div style="display: flex; justify-content: space-around;"> <div data-bbox="348 169 557 288">  </div> <div data-bbox="572 140 788 248"> <p>AG-3DA1P</p>  </div> <div data-bbox="803 140 1024 411"> <p>AG-3DA1E</p> <p>(For the U.K.)</p>  <p>(For areas other than the U.K.)</p>  </div> </div>		
<p>Eye cup</p> 	<p>AC adaptor / AC power supply cables</p> <div style="display: flex; justify-content: space-around;"> <div data-bbox="348 480 557 647">  </div> <div data-bbox="572 459 788 595"> <p>AG-3DA1P</p>  </div> <div data-bbox="803 459 1024 738"> <p>AG-3DA1E</p> <p>(For the U.K.)</p>  <p>(For areas other than the U.K.)</p>  </div> </div>		
<p>Microphone holder</p> 	<p>Microphone holder screws</p> <p>Length 6-mm (2)</p>  <p>Length 12-mm (2)</p> 	<p>Microphone holder adaptor</p> 	<p>CD-ROM</p> 
<p>The following accessories are attached to the unit.</p>			
<p>Lens cap</p> 		<p>INPUT terminal cover (2)</p> 	<p>Screw spacer</p> 

- After unpacking, dispose of the AC power supply cable caps and packing materials properly.
- Please consult a retailer when purchasing additional accessories.

Optional accessories

- **XLR microphone**
AG-MC200G
- **Battery**
CGA-D54 (7.2 V, 5400 mAh: equivalent to accessory battery for the AG-3DA1P)
CGA-D54s (7.2 V, 5400 mAh: equivalent to accessory battery for the AG-3DA1E)

Description of parts

Right side and rear side

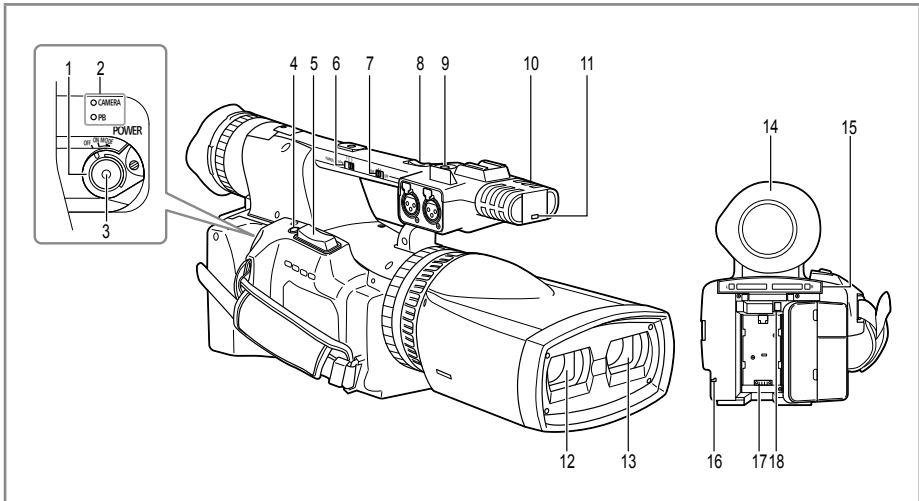

- | | |
|--|---|
| 1 POWER/Mode selector switch (Page 24) | 10 Built-in stereo microphone (Page 48) |
| 2 Mode lamps (Pages 31 and 57) | 11 Tally lamp (Front) (Page 25) |
| 3 START/STOP button (Page 31) | 12 Right lens |
| 4 REC CHECK button (Page 31) | 13 Left lens |
| 5 Zoom button (Page 34) | 14 Viewfinder (Page 26) |
| 6 HANDLE ZOOM switch (Page 34) | 15 SD Memory Card slot cover (Page 30) |
| 7 REC selector switch (Page 42) | 16 Tally lamp (Rear) (Page 25) |
| 8 Handle zoom button (Page 34) | 17 Battery compartment (Page 24) |
| 9 Handle START/STOP button (Page 42) | 18 Battery release button (Page 24) |

Left side

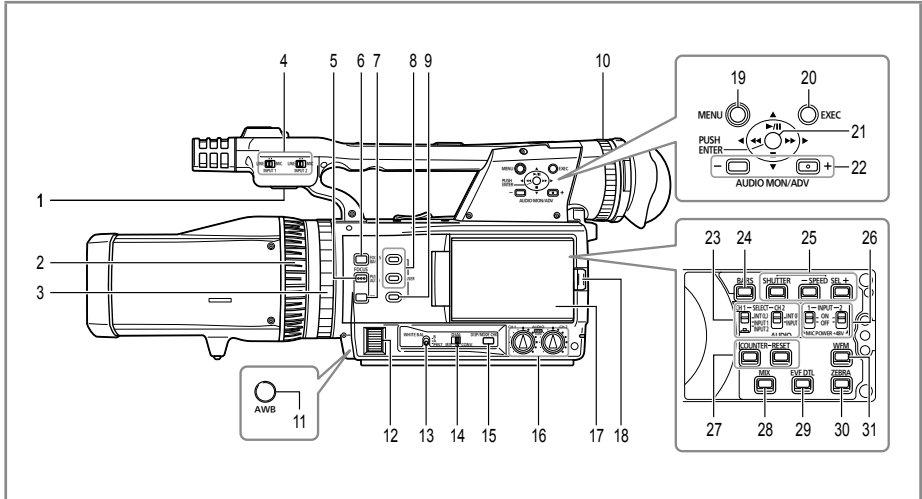

Description of parts

- | | |
|--|--|
| <p>1 Built-in speaker (Page 65)</p> <p>2 Focus ring (Page 36)</p> <p>3 Zoom ring (Page 34)</p> <p>4 INPUT 1/2 (LINE/MIC) switches (Page 48)</p> <p>5 PUSH AUTO button (Page 36)</p> <p>6 FOCUS BAR button (Page 36)</p> <p>7 ∞ button (Page 36)</p> <p>8 USER 1/2 buttons (Pages 43 and 79)</p> <p>9 3D GUIDE button (Page 38)</p> <p>10 Diopter adjustment dial (Page 26)</p> <p>11 AWB button (Page 40)</p> <p>12 IRIS/CONV. dial (Pages 37 and 38)</p> <p>13 WHITE BAL switch (Page 40)</p> <p>14 DIAL (IRIS/CONV.) selector switch (Pages 37 and 38)</p> <p>15 DISP/MODE CHK button (Page 43)</p> <p>16 AUDIO LEVEL control knobs (CH1, CH2) (Page 49)</p> | <p>17 LCD monitor (Page 27)</p> <p>18 OPEN button (Page 27)</p> <p>19 MENU button (Page 75)</p> <p>20 EXEC button (Pages 45 and 62)</p> <p>21 Operation lever (Page 75)</p> <p>22 AUDIO MON/ADV buttons (Pages 44 and 65)</p> <p>23 CH1, CH2 SELECT switches (Page 48)</p> <p>24 BARS button (Page 43)</p> <p>25 SHUTTER, SPEED SEL +/- buttons (Page 46)</p> <p>26 INPUT 1/2 switches (MIC POWER +48V) (Page 48)</p> <p>27 COUNTER - RESET buttons (Page 53)</p> <p>28 MIX button (Page 38)</p> <p>29 EVF DTL button (Page 27)</p> <p>30 ZEBRA button (Page 42)</p> <p>31 WFM button (Page 44)</p> |
|--|--|

Terminals and mounting parts

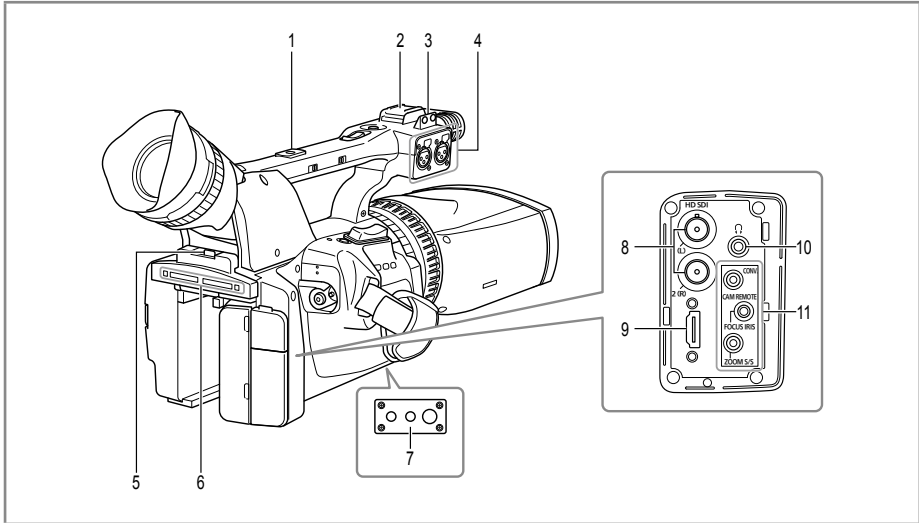

1 Accessory mounting hole

2 Light shoe

3 Microphone shoe (Page 66)

**4 Audio INPUT 1/2 terminals (XLR 3 pin)
(Page 48)**

5 Card slot cover OPEN lever (Page 30)

**6 SD Memory Card slots and access lamps
(Page 32)**

7 Tripod hole (Page 16)

8 HD SDI L/R terminals (Page 67)

9 HDMI OUT terminal (Page 67)

**10 Headphone jack (3.5 mm stereo mini jack)
(Page 66)**

11 CAM REMOTE jack*

CONV. (2.5 mm super mini jack)

You can connect a remote control unit (optional) to control the convergence point adjustment (adjustment of the reference plane for the 3D image).

FOCUS/IRIS (3.5 mm mini jack)

You can connect a remote control unit (optional) to control the FOCUS and IRIS (aperture).

ZOOM S/S (2.5 mm super mini jack)

You can connect a remote control unit (optional) to control zoom and start/stop of recording.

* Do not connect any equipment except the remote controller to the remote control jack. Connecting any equipment other than the remote control may cause the image brightness to change and/or the images to appear out of focus.

Charging the battery

Charging

Before using the battery, fully charge it with the battery charger.

Keep a spare battery with you.

- 1 Align the battery with the \Rightarrow marking on the battery charger, place it flat, slide it in the direction shown below and press firmly.

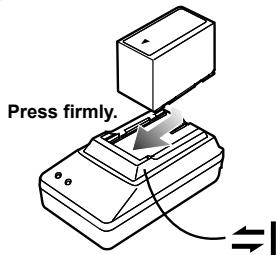

- 2 Connect the AC power supply cable.

Connect the AC power supply cable in the order 1 and 2.

- The POWER lamp and CHARGE lamp on the battery charger light, and charging begins.
- If the CHARGE lamp does not light when attached, detach the battery and then attach it again.

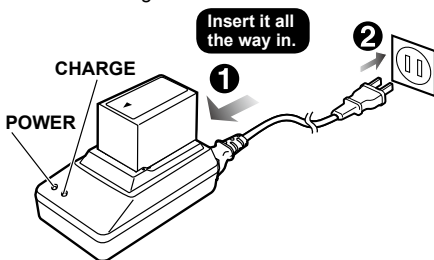

- When the battery is charged, the CHARGE lamp on the battery charger goes out.

- 3 Slide the battery and remove it.

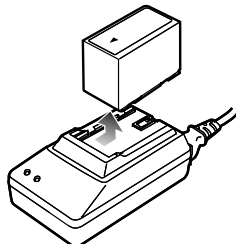

■ Charging time and available recording time (Approx.)

Battery model (included)	Voltage/capacity	Charging time	Maximum continuous recording time
CGA-D54 (AG-3DA1P)	7.2 V/ 5400 mAh	Approx. 330 minutes	Approx. 180 minutes
CGA-D54s			
AG-3DA1E			

- The times apply when the ambient operating temperature is 20 °C (68 °F) and humidity is 60 %. Charging may take longer at other temperatures and humidity levels.

■ Remaining battery capacity displays

The battery display will change

as battery capacity decreases. will be displayed in red when the battery is empty.

(For details on the remaining battery capacity displays: Page 70)

- **Keep metal objects (such as necklaces and hairpins) away from the battery. Short-circuiting may occur across the terminals, causing the battery to heat up, and you may seriously burn yourself if you touch the battery in this state.**
- The battery becomes hot while it is being used or charged. The camera itself also becomes hot during use.
- Discharge the battery before storing it.
- When storing it for an extended time, charge it at least once a year, use up its charge in the camera, and then store it again.
- If the battery is extremely hot or cold, the CHARGE lamp will blink several times before charging starts.
- If the CHARGE lamp continues to blink even when the battery temperature is normal, there may be something wrong with the battery or battery charger. Contact your dealer.
- The battery takes longer to charge when it is warm.
- The battery charger can interfere with radio reception so keep radios at least 1 meter away from it.
- The battery charger may make some noise when you are using it, but this is normal.

Description of parts

Preparation

Power sources

Using the battery

Installation

Insert the battery until it clicks into place.

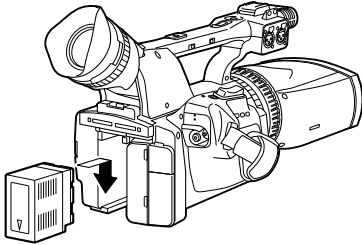

Removal

- 1 Set the **POWER/Mode selector switch** to **OFF**, and check that the mode lamps are off. (Page 25)
- 2 Remove the battery while pressing the **battery release button**.
 - Support the battery with your hand to ensure that it will not fall.

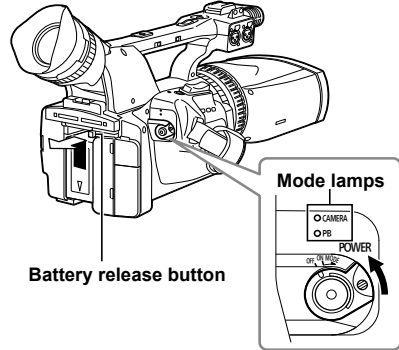

Using the AC adaptor

Installation

- 1 Insert the **DC cable's battery connector** until it clicks into place.
- 2 Connect the **AC power supply cable**. Connect the AC power supply cable in the order 1 and 2.

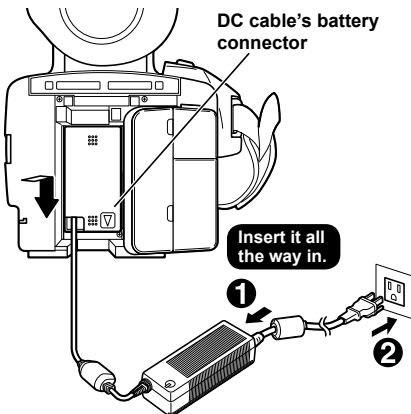

Removal

- 1 Set the **POWER/Mode selector switch** to **OFF**, and check that the mode lamps are off. (Page 25)
- 2 Remove the **DC cable's battery connector** while pressing the **battery release button**.
- 3 Disconnect the **AC power supply cable** from the power outlet.

CAUTION:

- Disconnect the AC power supply cable from the power outlet when the unit is not going to be used.
- When the AC power supply cable is disconnected from the power outlet, the power lamp on the AC adaptor remains lit for a while then shuts off. This is not a malfunction.

Turn on/off the camera

While pressing the lock release button, move the POWER/Mode selector switch to ON or OFF.

Turn on the camera:

The mode lamp (CAMERA) lights red (CAMERA mode) and the camera is now in the recording pause mode.

Turn off the camera:

The mode lamp (CAMERA) goes out.

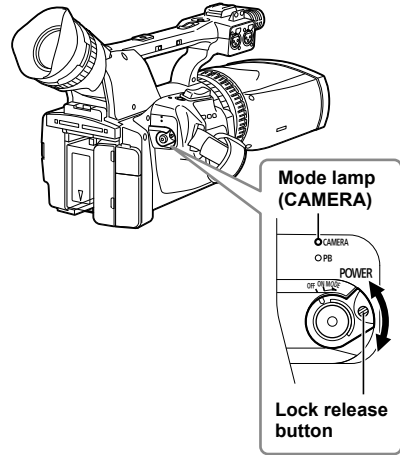

Preparation

Tally lamp

The tally lamp can be illuminated during recording by setting the REC LAMP item on the OTHER FUNCTIONS screen (Page 83) to any setting other than OFF.

The tally lamp will flash in any of the following circumstances.

- Recording error has occurred (flashes 4 times per second)
- Battery is empty (flashes 4 times per second)
- Available SD Memory Card capacity is low (flashes 4 times per second)
- Problem with focus function (flashes 4 times per second)
- Remaining memory capacity of the SD Memory Card is less than 2 minutes* (flashes once per second)

* Time for a rough guide

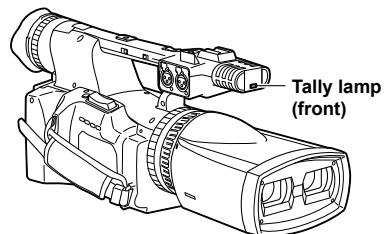
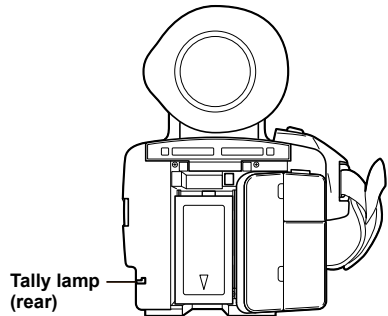

Viewfinder

This camera has two viewfinders; one is a miniature LCD in the viewfinder and the other is a retractable 3.2-type LCD.

Use the viewfinder that best suits the application and shooting conditions.

- The brightness and hue may differ between the images appearing on the viewfinder and LCD monitor and those displayed on a TV monitor. To see how the final images will appear, check them on a TV monitor.

Using the viewfinder

- 1** Set the **POWER/Mode selector switch** to **ON** (Page 25) and check that images appear in the viewfinder.

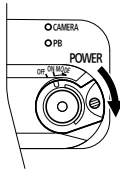

- 2** Adjust the viewfinder's angle so that the screen is positioned where it is easiest to see.

- You can move the viewfinder out to about 90° perpendicular to the camera.

- 3** Adjust the diopter adjustment dial so that you can see the characters on the viewfinder screen clearly.

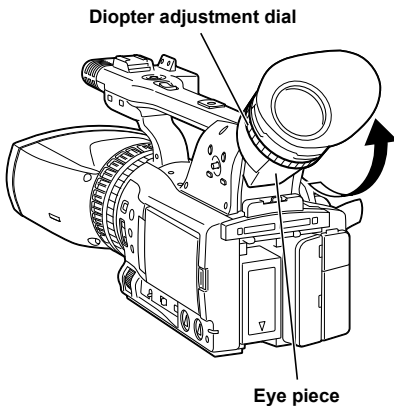

Do not allow the eyepiece of the viewfinder to remain in direct contact with sunlight or other strong light sources.

- Internal components may be damaged and fire may be caused if light accumulates through the lens.
-

Fitting the eye cup

Attach the eye cup by aligning the ridges on the eye cup holder with the grooves on the eye cup and fitting them together.

- Turning the eye cup after attaching it may cause the eye cup holder to come off. If the eyecup holder does come off, see "Cleaning the Viewfinder" (Page 88) for details on how to refit it.

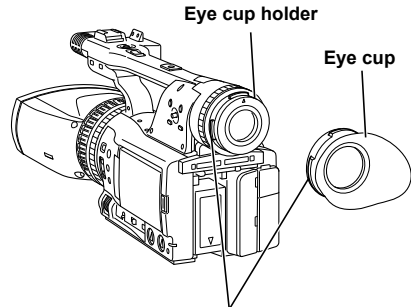

Align the ridges with the grooves.

Using the LCD

- 1 Set the **POWER/Mode selector switch to ON.** (Page 25)
- 2 Hold down the **OPEN button** and open the LCD monitor.
 - It can open out to 90°. Do not try to open it further as this will damage the camera.

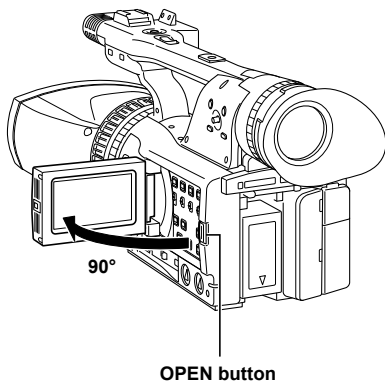

- 3 Position the LCD monitor where it is easiest to see.
 - The monitor can be rotated 180° toward the lens and 90° toward you.

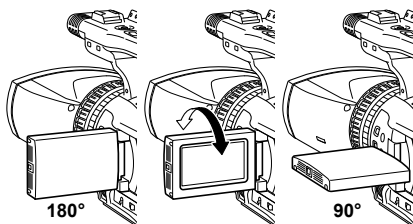

- Do not apply unnecessary force to the open LCD. This can damage the camera.
- Ensure the LCD is fully closed.

Emphasizing outlines

Emphasizing the outlines of the images you see in the viewfinder or on the LCD makes it easier to focus.

Emphasizing the outlines does not effect the images you shoot.

- 1 In **CAMERA mode**, press the **EVF DTL button**.
“EVF DTL ON” appears on the screen for about 2 seconds.

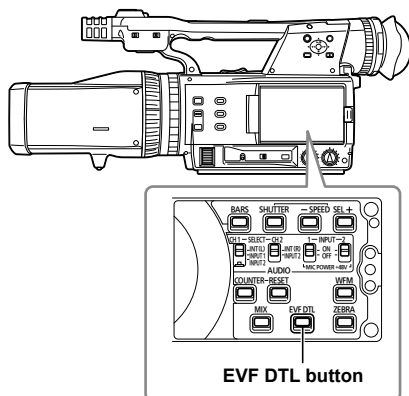

Press the EVF DTL button again to return to the original display. “EVF DTL OFF” appears on the screen for about 2 seconds.

Setting the calendar

The CLOCK SET value is recorded in the contents (clip). Before carrying out recording, be sure to check and set CLOCK SET and TIME ZONE. This shows you how to adjust the calendar to 17:20 on 25 December, 2010.

- 1 Set the camera's POWER/Mode selector switch to ON. (Page 25)
- 2 Press the MENU button.
 - Menu operation (Page 75)
- 3 Select the TIME ZONE item on the settings menu OTHER FUNCTIONS screen, and push the Operation lever (or tilt lever in direction).



- 4 Pushing the Operation lever twice brings up the setting screen. Tilt the Operation lever in the ◀▶ directions to set the time difference from Greenwich Mean Time, and push the Operation lever again. Factory default setting is +00:00.



- 5 Tilt the Operation lever in the ◀ direction and select YES in the CLOCK SET item on the settings menu OTHER FUNCTIONS screen.

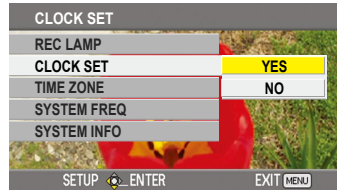

- 6 Tilt the Operation lever in the ▲▼ directions and set to DEC.

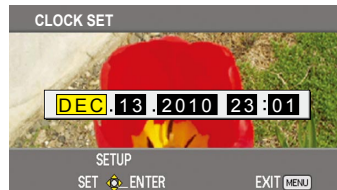

- 7 Tilt the Operation lever to the ▶ direction to change to the next item, and set to 25 by tilting in the ▲▼ directions.



- 8 Repeat steps 6 and 7 to set the remaining items.

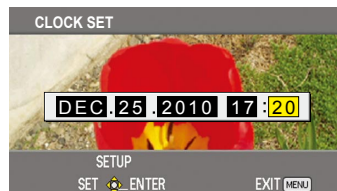

- The date can be set to any date between 1 January, 2001 and 31 December, 2039.
- Time is displayed in 24-hour format.

-
- 9** When settings are complete, push the Operation lever, select YES on the confirmation screen, and push the Operation lever again.



-
- The clock can vary in accuracy so check that the time is correct before shooting.
 - When using the camera overseas, do not set the CLOCK SET option to the local time, but instead enter the time difference from Greenwich mean time according to TIME ZONE.
-

Basic shooting operations

Preparing for recording

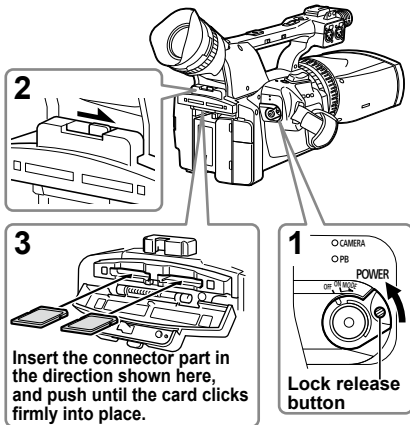

1 While pressing the lock release button, turn the **POWER/Mode selector switch to OFF**.

- Check that the mode lamps are off.

2 Tilt the viewfinder upwards, and open the SD Memory Card slot cover by sliding the **OPEN** lever to the right.

3 Fully insert two SD Memory Cards into the card slots.

- Be sure to insert two SD Memory Cards.
- Use SD Memory Cards of the same type and capacity.

4 Close the SD Memory Card slot cover.

- Ensure that the cover firmly clicks into place.

- Do not perform any of the following operations while the SD Memory Card access lamp is flashing. Performing these operations may damage the SD Memory Card or its contents, or cause the camera to fail to operate correctly.
 - Opening the card slot cover and removing the SD Memory Card
 - Switching off the power
 - Shaking or striking the camera
- Always format SD Memory Cards that have been used in other devices when first using them with this camera. (below)
- If the system frequency of the camera is changed, the SD Memory Card will no longer be able to be used. Such cards may be used again by formatting them with the current **SYSTEM FREQ** settings.

- When an SD Memory Card is formatted, all data recorded on the card will be erased and will not be restorable. Save all important data to your computer.
- If "CHECK CARD" is displayed on the viewfinder or the LCD monitor, please remove the SD Memory Cards and insert them again.
- Mosaic-like noise may appear on the playback screen under the following shooting conditions:
 - When there are complex patterns in the background
 - When the camera is moved in large motions or when it is moved very quickly
 - When a fast-moving subject has been recorded

Formatting a card

If you use SD Memory Cards for the first time for shooting with this camera, format the cards as follows:

- Be sure to format the two cards simultaneously using this product.

1 While pressing the lock release button, turn the **POWER/Mode selector switch to ON**.

- Check that the mode lamp (CAMERA) is lighted red.

2 Press the **MENU** button.

3 Tilt the Operation lever in the **▲▼** directions to select **CARD FUNCTIONS**, and push the Operation lever (or tilt in the **▶** direction).

4 Confirm that **CARD FORMAT** is selected, and push the Operation lever.

5 Tilt the Operation lever in the **▲▼** directions to select whether or not to format (**YES** or **No**), and push the Operation lever.

- By selecting **YES**, SD Memory Cards will be formatted. Proceeding will erase all data from the cards.
- If only one SD Memory Card is inserted, **CAN NOT OPERATE PLEASE INSERT THE TWO CARDS** is displayed. Be sure to insert two cards.

Basic shooting operation

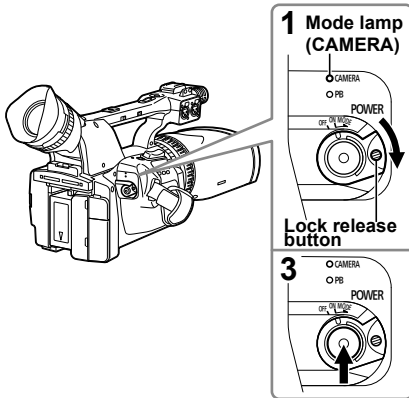

1 While pressing the lock release button, turn the POWER/Mode selector switch to ON.

- Check that the mode lamp (CAMERA) is lighted red (CAMERA mode).

2 Adjust the focus, brightness, white balance, and convergence point.

- Focus adjustment (Page 36)
- Brightness adjustment (Page 37)
- White balance adjustment (Page 40)
- Convergence point adjustment (Page 38)

3 Press the START/STOP button (Red) to start shooting.

- Press again to return the camera to the recording pause mode.
- Use the handle START/STOP button to make it easier to shoot from low angles. (Page 42)
The handle START/STOP button can be enabled (ON) and disabled (OFF) with the handle REC selector switch.
- Shooting is not possible when a menu screen is displayed. First, close the menu screen, and then press the START/STOP button.
- Shooting stops when the SD Memory Card slot cover is opened during shooting.

- The images shot from when shooting starts until it is stopped are recorded as one clip.
- When recording is paused after a short period, a small amount of time may be required after pressing the START/STOP button to stop recording before writing to the SD Memory Card is terminated. This means that operations cannot be accepted if the START/STOP button is pressed immediately.
- The camera will read information from the SD Memory Card immediately after the card is inserted. Press the START/STOP button to begin recording after PAUSE is displayed in the operation status display. (Page 70)
- The camera's factory default setting is 1080/60i recording (AG-3DA1P) or 1080/50i recording (AG-3DA1E).
(To view current setting status: Page 43)
- The upper limit for the number of clips which can be recorded on a single SD Memory Card is 200. (However, this number may exceed 200 clips at times such as when shooting immediately after the POWER/Mode selector switch has been set to ON.)

Checking photos taken (REC CHECK)

Press the REC CHECK button while recording is paused. The last two seconds of video and audio will be played, and the camera will then return to the recording pause mode.

- Only the POWER/Mode selector switch is operable during REC CHECK.
- The REC CHECK images are also recorded when a device is connected to the camera and backup images have been recorded.
- The REC CHECK function does not work when PB has been selected as the operation mode.
- This function also does not work if the REC FORMAT has been changed or if the camera has been set to CAMERA mode after having switched to PB mode after recording.

SD Memory Card access lamps

Each SD Memory Card access lamp indicates the status of the SD Memory Card inserted in the corresponding SD card slot.

Illuminated:

Reading/writing possible

Flashing (fast):

Verifying card/inspecting card for possible defects

Flashing (slow): Accessing card

Off: No card inserted/unformatted, incompatible card inserted or card full

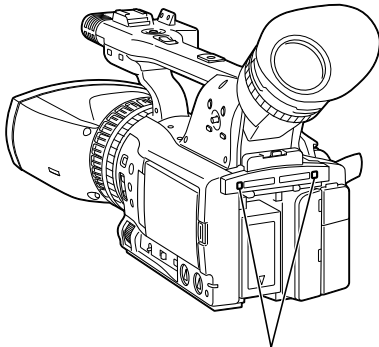

SD Memory Card access lamps

SD Memory Card recording times

- Total available recording times (approx.) when using SDHC Memory Cards manufactured by Panasonic

SDHC Memory Card capacity	Recording mode PH (1920 × 1080 pixels or 1280 × 720 pixels)
4 GB	Approx. 21 min
8 GB	Approx. 45 min
16 GB	Approx. 90 min
32 GB	Approx. 180 min

- This product allows PH recording mode only.
- The quality of AVCCAM recording modes are PH>HA>HG>HE in the order of high to low quality.
- Use an SD Memory Card of SD speed class 4 or above. Recording cannot be completed on SD Memory Cards of lower speed classes.
- This camera uses the VBR recording system. “VBR” stands for Variable Bit Rate, and it refers to a system in which the bit rate (volume of data per given time period) varies automatically depending on the subject which is being shot. This means that the recording times will be shorter when fast-moving subjects have been recorded.
- Times displayed include time needed for processing, etc. – actual available recording times will be slightly shorter.
- Repeatedly recording or deleting images over and over again may reduce the recording time on the SD Memory Card. In such cases, format the SD Memory Card using the camera. When a card is formatted, all of its recorded data will be erased, and it will not be subsequently possible to restore this data. Save any valuable data on your PC prior to formatting.

Removing SD Memory Cards

1 Tilt the viewfinder upwards, and open the SD Memory Card slot cover by sliding the OPEN lever to the right.

- Ensure that the SD Memory Card access lamps are not flashing before opening the cover.

2 Press the center of the SD Memory Card so that it pops out slightly, and pull the card straight outwards.

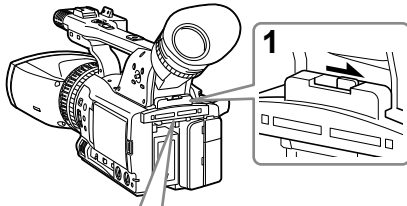

2 SD Memory Card access lamps

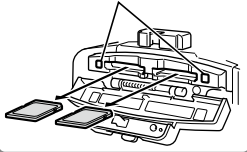

- Do not remove the SD Memory Card or switch off the power in the following circumstances. Doing so may damage your SD Memory Card.
 - 1) While the SD Memory Card access lamp is still flashing after an SD Memory Card has been inserted.
 - 2) While the SD Memory Card access lamp is flashing such as during recording or during recording finalization.
- It is recommended that you note "Right" or "Left" on the SD Memory Cards. If the left and right SD Memory Cards are inserted in the wrong respective slots, CHECK CARD LEFT/RIGHT is displayed on the viewfinder and LCD monitor.

Protecting SD Memory Cards

Move the write-protect switch on the SD Memory Card to the "LOCK" position to prevent recorded contents being accidentally erased from the card.

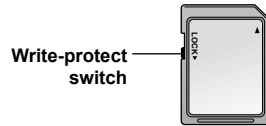

Repairing SD Memory Cards

Never remove the SD Memory Card or disconnect the battery or DC cable's battery connector while the SD Memory Card access lamp is flashing, as doing so may damage the SD Memory Card. In the event that the SD Memory Card has been removed while the SD Memory Card access lamp was flashing, or that the battery or DC cable's battery connector has been disconnected during recording or the recording finalization process, a repair verification screen will be displayed the next time the power is switched on in order to allow errors to be repaired.

In this case, use the AVCCAM Restorer contents repair software to repair the errors.

Using the zoom function

This camera has an approximately 5.6 × optical zoom function. Zoom with the zoom button or the zoom ring.

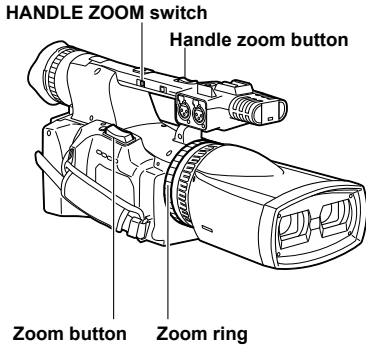

Zoom button

Using the zoom button, you can perform the motor-driven zoom.

- T:** Zoom in
- W:** Zoom out

Gently press the zoom button on the hand strap side to zoom slowly, firmly press to zoom faster.

Handle zoom button

You can change the zoom speed on the handle zoom button by selecting one of three speeds with the HANDLE ZOOM switch.

Set the HANDLE ZOOM switch speeds by going to the setup menus, SW MODE screen, HANDLE ZOOM. (Page 79)

Zoom ring

Using the zoom ring, you can perform manual zooming.

-
-
- During zooming, the image may move horizontally in small motions. This phenomenon is caused by the camera's control action to keep the convergence point constant, and it does not indicate a malfunction.
-
-

Shooting in progressive mode

Selecting 1080/30P and 1080/24P (when SYSTEM FREQ is set to 59.9 Hz) , or 1080/25P (when SYSTEM FREQ is set to 50 Hz) in the REC FORMAT item (Page 80) on the setting menu RECORDING SETUP screen enables shooting in progressive mode.

30P mode (when SYSTEM FREQ is set to 59.9 Hz):

Shoot 30 frames a second in the progressive mode.

For output and recording, the 30-frame-per-second signal is converted to 60-field-per-second interlace.

This mode gives you high quality images.

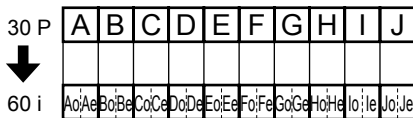

24P mode (when SYSTEM FREQ is set to 59.9 Hz):

Shoot 24 frames a second in the progressive mode.

The video signal will be recorded natively.

25P mode (when SYSTEM FREQ is set to 50 Hz):

Shoot 25 frames a second in the progressive mode.

For output and recording, the 25-frame-per-second signal is converted to 50-field-per-second interlace.

This mode gives you high quality images.

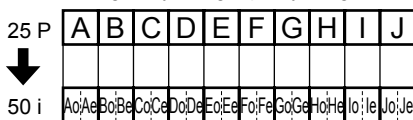

Note the following when shooting in progressive mode.

- Set the shutter speed to 1/50 (OFF) for best results.
 - There may be a slight delay to the start of recording when you use the 24P mode because 4 frames are recorded at a time. (Only when SYSTEM FREQ is set to 59.9 Hz)
-
-

Adjusting the focus

Manual focusing

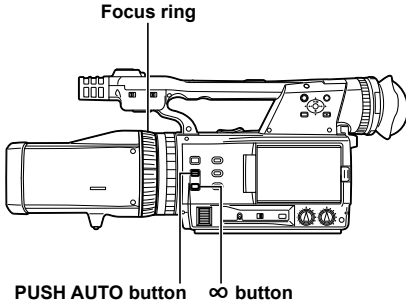

Turn the focus ring by hand to adjust the focus manually.

Temporarily switching to auto focus

The camera will focus automatically while you press down the PUSH AUTO button.

- The correct focus may not be obtained with auto focusing, depending on the condition of the subject. In this case, use manual focusing.
- Auto focus may not work properly if there is flickering. Select a shutter speed suited to the ambient light. (Page 46)
- If the auto focus mode is set with any format except 60i and 60P (when SYSTEM FREQ is set to 59.9 Hz), or 50i and 50P (when SYSTEM FREQ is set to 50 Hz), controlling the focus will take slightly longer than in the normal focus mode.

Adjusting the focus to infinity

Press the ∞ button to focus the camera to infinity. MF95 is displayed on the viewfinder and LCD monitor.

Using focus assist

Pressing the FOCUS BAR button displays the focus bar indicating the focus adjustment on the viewfinder or LCD monitor. Adjust the focus so that the bar becomes as long as possible.

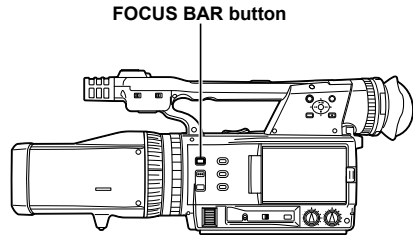

- Press the FOCUS BAR button to make the focus bar disappear.

Adjusting the brightness

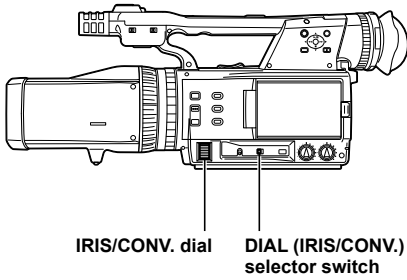

1 Set the DIAL (IRIS/CONV.) selector switch to IRIS.

With this setting, the camera will adjust the image brightness by controlling the aperture of the lens iris and gain according to the setting of the IRIS/CONV. dial.

2 Turn the IRIS/CONV. dial to adjust the brightness.

To get a brighter image when the lens aperture is OPEN, the camera will enter the gain adjustment automatically.

- The adjusted iris and gain values are displayed on the screen.

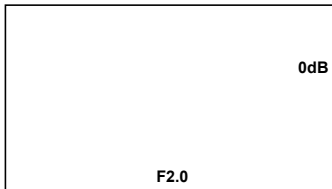

- Set the direction of the IRIS/CONV. dial and aperture control in the setup menus, SW MODE screen, IRIS DIAL. (Page 79)

When this camera's lens aperture is open, the F-value will be F1.8 when the lens zoom is set to maximum wide-angle (W), and F2.4 when set to maximum telescopic (T).

Adjusting the convergence point

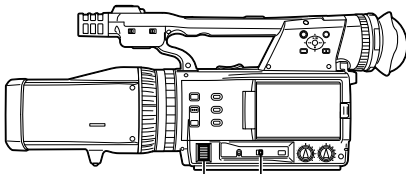

IRIS/CONV. dial DIAL (IRIS/CONV.) selector switch

1 Set the DIAL (IRIS/CONV.) selector switch to CONV.

With this setting, the camera will adjust the convergence point (depth of the reference plane for the 3D image) according to the setting of the IRIS/CONV. dial.

2 Turn the IRIS/CONV. dial to adjust the convergence point.

Tips on convergence point adjustment

Using the MIX button

If you press the MIX button, the image from the left lens and that from the right lens are superimposed on the LCD monitor and viewfinder (MIX image).

Turn the IRIS/CONV. dial so that the outline of the subject at the reference plane from the left lens is completely aligned with that from the right lens.

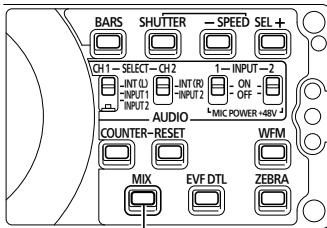

MIX button

Press the MIX button again to display the image shot by the left lens only.

- The left and right images will not be perfectly aligned if the subject is located at a distance of less than 2.2 m.
- The MIX image does not affect the recorded image.
- The MIX image is cancelled when the display status is changed, for example, when a menu is changed or REC CHECK is performed.

3D guide function

If you press the 3D GUIDE button, the viewfinder and the LCD monitor display a guide for the distance range within which the camera can shoot the subject so as to comfortably reproduce a 3D image. The 3D guide display (Page 69) changes as follows each time you press the 3D GUIDE button: no display → Guide display 1 → Guide display 2 → no display...

When shooting, select the guide display according to the size of monitor you intend to use for viewing.

Guide display 1 (3D indication in white):

Target monitor screen size is less than 77-type.

Guide display 2 (3D indication in green):

Target monitor screen size is 77-type or greater.

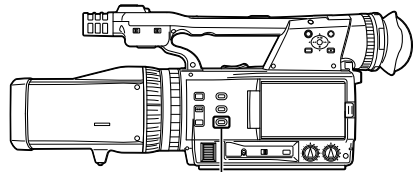

3D GUIDE button

- If you shoot a subject beyond the distance range shown by the guide display, a double image or strangeness feeling may be produced, or the shot image may not be reproduced as a 3D image correctly.
- If the subject is outside the distance range shown by the guide display, readjust the convergence point so that the subject goes within the distance range of the guide display.

Convergence display

If you set CONVERGENCE to ON, on the setup menu DISPLAY SETUP screen (Page 81), the convergence display indicates the distance between the camera and the adjusted reference plane as C00 to C99. The larger the number, the greater the distance to the reference plane.

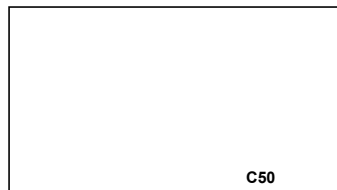

What is convergence point adjustment?

• What is parallax?

⇒ A human's stereoscopic viewing takes advantage of the brain's ability to process information from the left and right eyes of two images seen from their respective perspectives. The misalignment of the two images is called binocular parallax.

Mainly binocular parallax is used by 3D equipment to create the feeling of stereoscopic images. When shooting, the images from the left and right lenses are misaligned because of the difference in the positions of the lenses as well as in the directions of the optical axes. This misalignment (called parallax) changes according to the distance of the subject being shot (illustration at right). If parallax is excessive, it is difficult to fuse the two images within the brain. This may produce a double image, create a feeling of strangeness, etc., causing eyestrain. Limiting the parallax appropriately during shooting is important for comfortable 3D viewing.

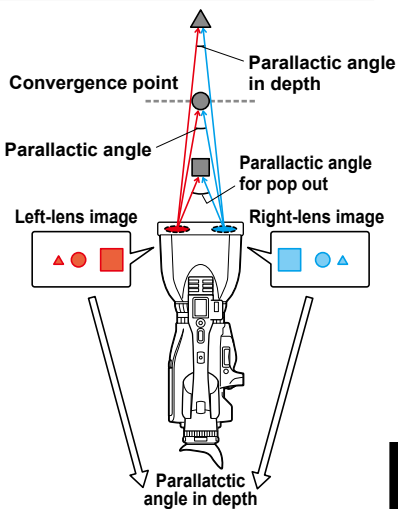

• Are there guidelines for appropriate parallax?

⇒ There are two guidelines for parallax.

① Parallax angle for pop out: 1 degree or less

A parallax angle is produced between the left and right lenses and the subject (illustration at right). It also changes according to the distance of the subject being shot.

It is usually said that a parallax angle for pop out within 1 degree is appropriate for comfortable 3D viewing.

Assuming that people view 3D images from a distance three times the effective height of the screen, a parallax angle of 1 degree corresponds to misalignment of approximately 3 % the effective width of the screen. This leads to one of the guidelines for parallax, which is to limit horizontal misalignment to within 3 % the effective width of the screen.

② Parallax in depth: 50 mm or less

Parallax in depth is created when an image from the right lens is displayed to the right and an image from the left lens to the left on the screen.

If the value of this parallax exceeds the pupil distance of a viewer, it will cause eyestrain.

In consideration of individual differences of viewers such as age and pupil distance, setting parallax to within 50 mm is preferable.

Parallax in depth is related to screen size. For a 16:9 screen, if the screen size is 77-type or less, limiting parallax to within 3 % the effective width of the screen means that parallax in depth will not exceed 50 mm. If the target screen size is 103-type, limit parallax to 2.2 %. For a 200-type screen, limit parallax to 1.1 %.

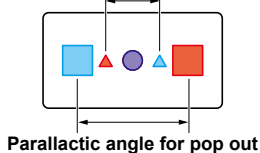

- Extreme parallax between left and right images is demonstrated in the illustration above.

■ Parallax for pop out

Parallax: Approx. 3 % or less (any screen size)

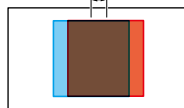

■ Parallax in depth

For a screen of 77-type or less

Parallax: Approx. 3 % or less

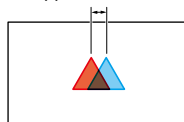

For a screen of 77-type or more

Parallax: 50 mm or less

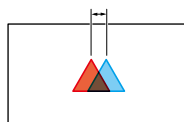

• How to operate this camera

⇒ The 3D guide function of this camera (Page 38) provides a rough guide of distance ranges from the subject for achieving appropriate parallax in two cases: for an intended screen size of 77-type or less, and for 200-type. Referring to the guide, change the layout of the subject or adjust the zoom and convergence, so that the subject can be shot within the distance range shown by the 3D guide function. Check the parallax value (% effective screen width), using a monitor.

Adjusting the white balance

In order to reproduce the white accurately, adjust the ratio between the three RGB primary colors. If the white balance is not adjusted properly, not only will the white be reproduced poorly but the color tones of the entire screen will also be downgraded. When you are shooting in manual mode, readjust the white balance whenever lighting conditions change.

You can save adjustments and reselect them by setting the WHITE BAL switch to A or B.

You can also use the preset values.

Use the settings to suit the shooting conditions.

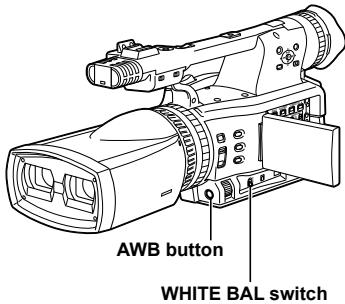

White balance adjustments

- 1 Set the shutter speed. (Page 46)
- 2 Place a white pattern in a location with the same lighting conditions and light source as the subject, then zoom in and fill the whole screen with white.
Something white (a white cloth or wall) near the subject can be used instead.
 - Do not include bright spotlights in your shot.
- 3 Set the WHITE BAL switch to A or B (whichever one you want to save the adjustment in).

4 Hold down the AWB button for a while.

The following messages appear on the screen.

Message during adjustment

AWB ABB Ach* ACTIVE

- The camera performs the white balance adjustment and the black balance adjustment in sequence. The adjustment will be finished in a few seconds.

Message after adjustment

AWB ABB Ach* END

- An error message appears on the screen when white balance adjustment is not possible.

Message when adjustment cannot be done

AWB Ach* NG

* Bch when the WHITE BAL switch is set to B.

Using presets

Use this feature when you have no time to make white balance adjustments.

1 Set the WHITE BAL switch to PRST.

The current white balance value appears.

- White balance values 3200 K and 5600 K are preset in the PRST position.
Guide to the preset values
P3.2K (3200 K): halogen light
P5.6K (5600 K): outdoors

2 Press the AWB button.

White balance switches between 3200 K and 5600 K.

Black balance adjustments

In order to reproduce the black accurately, adjust the zero level of all three RGB primary colors.

If the black balance is not adjusted properly, not only will the black be reproduced poorly but the color tones of the entire screen will also be downgraded.

It is not normally necessary to adjust the black balance. Adjust it when:

- You use the camera for the first time.
- You use the camera after not using it for a long time.
- The ambient temperature changes greatly.
- You switch to the normal (OFF) shutter speed or to slow shutter.
- You switch between the progressive and normal (60i*) modes.
 - * 50i when SYSTEM FREQ is set to 50 Hz

By pressing the AWB button, first the white balance is adjusted automatically, then the black balance is adjusted. Set the conditions for white balance adjustment before proceeding.

-
-
- Only the black balance is adjusted when the WHITE BAL switch is set to PRST.
-
-

Shooting techniques for different targets

Low angle recording

Recording can be controlled with the handle START/STOP button during low angle recording by moving the REC selector switch to the ON position.

- To prevent erroneous operation when not using the handle START/STOP button, set the REC selector switch to the OFF position.

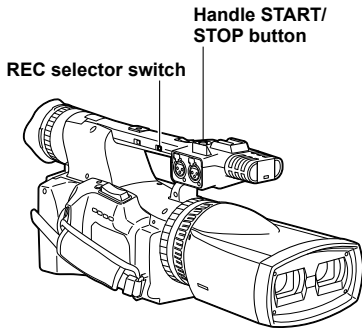

Zebra pattern

Press the ZEBRA button in the CAMERA mode to show the zebra pattern on the viewfinder and the LCD monitor so you can check the brightness of the subject.

Parts that may be whited out through over exposure are shown as a zebra pattern.

- Very bright
- Reflecting parts

You can remove most overexposed parts by adjusting the iris and shutter speed in the manual mode to remove the areas with zebra patterns.

The display changes as follows each time you press the ZEBRA button: OFF → ZEBRA1 → ZEBRA2 → OFF ...

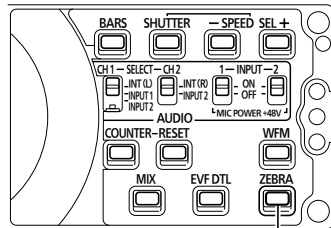

ZEBRA button

The zebra pattern you have set appears as a percentage on the display for about 2 seconds.

- In the setup menus, DISPLAY SETUP screen, ZEBRA DETECT1 and ZEBRA DETECT2, set the brightness for the zebra patterns. (Page 81)

Checking and displaying shooting status

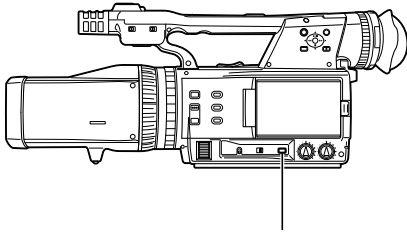

DISP/MODE CHK button

Pressing the DISP/MODE CHK button during recording or while recording is paused will remove all displays from the screen except for the operation status, counter, and warning display. Press the button again to return to the normal display. (Page 74)

- The normal display is resumed when the power is turned on.

During recording or while recording is paused, information such as recording functions setting status and a list of functions allocated to the USER buttons can be displayed by keeping the DISP/MODE CHK button held down. Release the button to return to the normal display.

Pressing the DISP/MODE CHK button while the thumbnail screen is displayed in PB mode will display the properties of the selected clip. (Clips can be selected by moving the cursor with the Operation lever.)

Using the USER buttons

You can allocate one of three features to each of the USER 1, 2 buttons.

For details, see the setup menu, SW MODE screen, USER1 and USER2. (Page 79)

- If you press a USER button to which one of the functions has been allocated and then turn off the power, the added effect to the image will not be retained.

Color bars

Press the BARS button in the CAMERA mode to output a color bar screen to a television or monitor so you can adjust them. Press the button again to turn the feature off.

- While the color bar is displayed, a test tone of 1 kHz* will be output from the headphone terminal, the HD SDI terminals or the HDMI terminal. There will be no speaker output.
* 997 Hz when SYSTEM FREQ is set to 50 Hz
- The color bar can be recorded by pressing the START/STOP button.
- The BARS button does not work in the PB mode.
- The color bar display is canceled when the power is turned off.

Shooting techniques for different targets (continued)

Wave form monitor function

An image wave form can be displayed on the LCD monitor by pressing the WFM button while in CAMERA mode.

The display changes as follows each time you press the WFM button: OFF → WFM (wave form)

→ VECTOR → OFF...

- Wave forms will not be displayed in the viewfinder.
- Wave forms cannot be recorded.
- While wave forms are displayed, use the viewfinder as well since part of the recording screen will be hidden by the wave forms.
- Wave forms are not displayed when the adjustment using the 3D FINE function is being performed (Page 45), the images from both the left and right lenses are displayed (MIX image: Page 38) or only the image from the right lens is being displayed (R-IMAGE image: Page 79).
- To display the left-lens image when the MIX or R-IMAGE image is on the screen, press the WFM button.

Adjusting the volume while shooting

AUDIO MON/ADV buttons

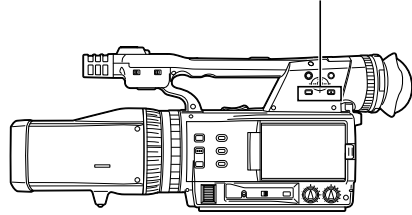

If you are monitoring the sound through headphones while shooting, you can adjust the volume with the AUDIO MON/ADV buttons. (To adjust the recording level: Page 49)

- Volume adjustments will be memorized if the power is turned off by moving the POWER/ Mode selector switch to the OFF position.

Shot mark function

The marks attached to the thumbnails of clips are called shot marks. On the thumbnail screen monitor you can select only those clips with a shot mark and display them or play them back. During recording, when you press the USER button to which the SHOT MARK function has been allocated, MARK ON appears in the LCD monitor or the viewfinder, and a shot mark is set for the thumbnail of the clip being recorded. If you press the button again, the shot mark is released. You can also set or release the shot marks by performing the thumbnail operations for clips. (Page 59)

However, note that you cannot set or release shot marks during playback.

- INVALID appears when you cannot set or release shot marks.

3D FINE function

As the left and right lenses are linked, you normally do not need to adjust them.

If you wish to perform fine adjustments between the two lenses, the 3D FINE function allows you to adjust the vertical position of the images, focus and iris.

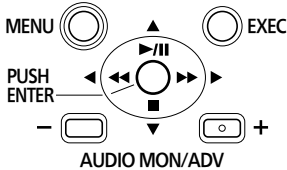

1 Perform zoom adjustment (Page 34), focus adjustment (Page 36) or brightness adjustment (Page 37).

2 Press the EXEC button.

The fine adjustment screen is displayed.

3 Adjust the vertical position of the images, focus and iris finely.

Vertical position of the images

(VERTICAL): Tilt the Operation lever in the ▼ ▲ directions. The image from the right lens moves upwards by tilting it in the ▲ direction, and downwards by tilting it in the ▼ direction.

- This product is preadjusted at the factory to minimize vertical misalignment.*1 The specification for vertical misalignment is 1.2 % or less.

*1 It is indicated in percentage of vertical misalignment between the images from the left and right lenses at the center of the screen according to the effective height of the screen, when measured under the following conditions: the zoom position at the maximum wide-angle (Z00), the convergence point in the center (C50), and shooting a subject at a distance of 4.3 m.

Focus (FOCUS): Tilt the Operation lever in the ◀ ▶ directions. The focal length for the right lens is increased by tilting it in the ◀ direction, and is reduced by tilting it in the ▶ direction.

Iris (IRIS): Press the AUDIO MON/ADV +/- buttons. The iris of the right lens is opened by pressing the + button, and is closed by pressing the – button.

4 Press the EXEC button to confirm the adjustments.

- When the adjustment screen of the 3D FINE function is being displayed, only the MIX button and the USER button with R-IMAGE allocated operate. The other buttons are not operative.
 - The fine adjustment value is cleared when a zoom operation, focus adjustment, or brightness adjustment using the IRIS/CONV. dial is performed after the adjustment.
 - The fine adjustment value is cleared when the power of the unit is turned off.
-

Adjusting the shutter speed

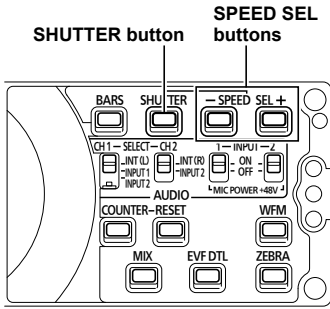

1 Press the SHUTTER button.

Each time you press the SHUTTER button, the shutter speed switches between normal (OFF) and the speed you selected with the SPEED SEL buttons.



2 After you have pressed the SHUTTER button, press SPEED SEL buttons to select the shutter speed.

The shutter speed changes as follows each time you press SPEED SEL + button (The order is reversed for the SPEED SEL - button.)

- Remember that the faster the shutter speed, the lower the sensitivity.
- The current shutter speed appears on the viewfinder and LCD monitor when you have selected ON in OTHER DISPLAY in the DISPLAY SETUP screen of the setup menus. It is not displayed if you have set the shutter speed to normal (OFF).
- With artificial lighting and especially fluorescent lights and mercury-vapor lamps, the luminance changes in synchronization with the power line frequency. When this frequency is 50 Hz, mutual interference will occur between the camera-recorder's vertical sync frequency (approx. 60 Hz) and the lighting frequency (50 Hz). This means that the white balance may change periodically. Before shooting in areas with artificial lighting or adjusting the white balance, set the shutter speed as follows.

When SYSTEM FREQ is set to 59.9 Hz

Progressive mode	Shutter speed	
	50 Hz	60 Hz
OFF (60i)	1/100	OFF (1/60)
30P	OFF (1/50)	1/60
24P	OFF (1/50)	1/120

When SYSTEM FREQ is set to 50 Hz

Progressive mode	Shutter speed	
	50 Hz	60 Hz
OFF (50i)	OFF (1/50)	1/60
25P	OFF (1/50)	1/60

When SYSTEM FREQ is set to 59.9 Hz

With the 1080/60i or 720/60P format	
Standard (OFF) 1/60	SYNCRO SCAN ↔ 1/60 ↔ 1/100 ↔ 1/120 ↔ 1/250
With the 1080/30P format	
Standard (OFF) 1/50	SYNCRO SCAN ↔ 1/30 ↔ 1/50 ↔ 1/60 ↔ 1/120 ↔ 1/250
With the 1080/24P format	
Standard (OFF) 1/50	SYNCRO SCAN ↔ 1/24 ↔ 1/50 ↔ 1/60 ↔ 1/120 ↔ 1/250

When SYSTEM FREQ is set to 50 Hz

With the 1080/50i or 720/50P format	
Standard (OFF) 1/50	SYNCRO SCAN ↔ 1/50 ↔ 1/60 ↔ 1/120 ↔ 1/250
With the 1080/25P format	
Standard (OFF) 1/50	SYNCRO SCAN ↔ 1/25 ↔ 1/50 ↔ 1/60 ↔ 1/120 ↔ 1/250

Synchro scan

Set the shutter speed of the synchro scan (used when shooting a television or computer monitor) in the setup menus, CAMERA SETUP screen, SYNCRO SCAN. (Page 78)

- Adjust the shutter speed to match the frequency of the television or computer monitor to minimize the horizontal noise that appears when shooting such subjects.
 - If the SYNCRO SCAN item is displayed in grey, it cannot be used with the current recording format. This function will only operate for preset values for each recording format.
-
-
- You can change the progressive mode in the setup menu with REC FORMAT item on the RECORDING SETUP screen. (Page 80)
-
-

Switching Audio Input

During shooting, you can record up to two channels of sound. You can also switch the input sound to be recorded on each of the channels to the built-in microphones, external microphones or audio equipment connected to camera.

CH1 SELECT switch **CH2 SELECT switch**

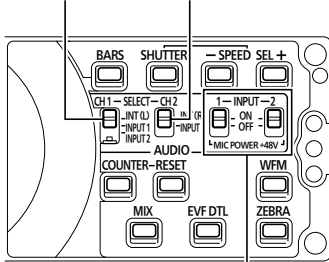

INPUT 1/2 (MIC POWER +48V) switches

Using the built-in microphone

- 1 Switch the CH1 SELECT switch to INT (L).**
 - Audio from the built-in microphone Lch is recorded to audio channel 1.
- 2 Switch the CH2 SELECT switch to INT (R).**
 - Audio from the built-in microphone Rch is recorded to audio channel 2.

Using an external microphone and audio equipment

- 1 Connect an external microphone or audio equipment to the INPUT 1/2 (XLR 3-pin) terminals. (Page 66)**

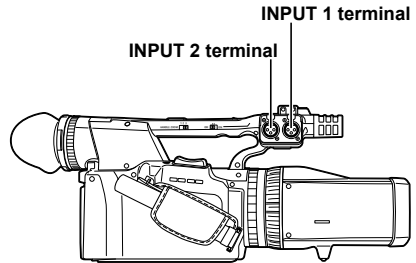

- 2 Use the INPUT 1/2 switches to switch the audio input.**

INPUT 1 switch **INPUT 2 switch**

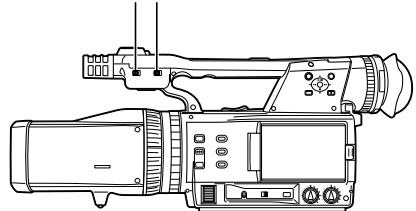

LINE: (audio equipment is connected)

Input level is 0 dBu.

MIC: (an external microphone is connected)

Input level is -50 dBu.

You can change the input level to -60 dBu in the setup menus, RECORDING SETUP screen MIC GAIN1 and MIC GAIN2. (Page 80)

Be aware that sensitivity will be higher if you choose -60 dBu so you will record more noise.

3 When using the phantom microphone (which requires +48 V power supply), set the INPUT 1/2 (MIC POWER +48V) switches to ON.

ON: (When using the phantom microphone)

+48 V power supply to INPUT 1/2 terminals.

OFF: (When a phantom microphone is not connected)

No power supply for INPUT 1/2 terminals.

- The battery will discharge faster if you use a phantom microphone.
- Set to OFF if you connect equipment not compatible with +48 V. You can damage such equipment if you leave the setting at ON.
- When using the AG-MC200G (optional), set the MIC GAIN item to -50 dBu.

4 Use the CH1 SELECT switch to select the input signal to be recorded to audio channel 1.

INT (L):

Audio from the built-in microphone Lch is recorded to audio channel 1.

INPUT 1:

Audio from a device connected to INPUT 1 terminal is recorded to channel 1.

INPUT 2:

Audio from a device connected to INPUT 2 terminal is recorded to channel 1.

5 Use the CH2 SELECT switch to select the input signal to be recorded to audio channel 2.

INT (R):

Audio from the built-in microphone Rch is recorded to audio channel 2.

INPUT 2:

Audio from a device connected to INPUT 2 terminal is recorded to channel 2.

- When inputting the microphone signal to channels 1 and 2, connect the microphone to INPUT 2 and switch both CH1 SELECT and CH2 SELECT to INPUT 2.

Adjusting the recording level

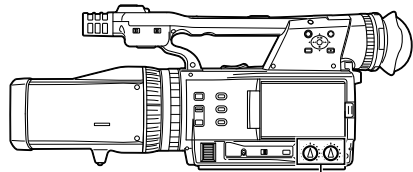

AUDIO LEVEL control knobs

Use the AUDIO LEVEL control knobs to adjust the recording level of the built-in microphone or of audio signals input through the INPUT 1/2 (XLR 3-pin) terminals.
(To adjust the volume of the sound for monitoring: Page 44)

To adjust the recording level of the audio signals, turn the AUDIO LEVEL control knobs while referring to the audio level meter at the bottom left of the viewfinder and LCD monitor.



- Check the recording volume level prior to shooting.
- The recording level of this camera is set approximately 8 dB higher than Panasonic broadcasting camera recorders (AJ series products).

Clip metadata

You can add the video and audio systems, name of the videographer, shooting location, text memos and other information to the video data you have recorded on the SD Memory Cards. This data is called the clip metadata. (Display method: Page 63)

There are two kinds of clip metadata: the data that is recorded automatically during shooting, and the data in the metadata upload file created on the SD Memory Card which is loaded in the unit. (Loading method: Page 51)

- Metadata can be produced with AVCCAM Viewer. (Page 91)
When producing metadata using AVCCAM Viewer, be sure to format SD Memory Cards with this product and record the metadata on the left-channel SD Memory Card.

What the clip metadata consists of

You can set the items underlined below by loading the metadata upload file on the SD Memory Card. All other items are set automatically during shooting.

GLOBAL CLIP ID:

This indicates the global clip ID that shows the shooting status of the clip.

USER CLIP NAME:

This indicates the name of the clip that the user has set.*1

VIDEO & AUDIO:

This indicates the recorded image's FRAME RATE, RESOLUTION, PULL DOWN*4 system and AUDIO.

ACCESS:

This indicates the CREATOR (name of the person recording), CREATION DATE (recording date), LAST UPDATE DATE (date on which the data was last updated) and LAST UPDATE PERSON (the person who last updated the data).

DEVICE:

This indicates the MANUFACTURER (manufacturer of the equipment), SERIAL NO. (serial number of the equipment) and MODEL NAME (equipment model name: AG-3DA1).

SHOOT:

This indicates the SHOOTER (name of the

videographer) and the PLACE NAME (name of location).

LOCATION:*4

This indicates ALTITUDE, LONGITUDE, LATITUDE, and SOURCE (altitude, longitude, latitude, information source).

SCENARIO:*2

This indicates the PROGRAM NAME, SCENE NO. and TAKE NO.

NEWS 1:

This indicates the REPORTER (name of the reporter) and PURPOSE (purpose of data collection).

NEWS 2:

This indicates the OBJECT (target of data collection).

MEMO:*3

This indicates the PERSON (name of the person who recorded the text memo) and TEXT (contents of memo).

*1 If there is no information in the metadata upload file, consecutive five-digit numbers will be applied to the clips in the order that they were recorded, with the first clip to be recorded being given the number 0. The USER CLIP NAME recording method is selectable. (Page 51)

*2 When SCENARIO is to be input, you must input the PROGRAM NAME. You cannot input the SCENE NO. and TAKE NO. only.

*3 When MEMO is to be input, you must input TEXT. You cannot input PERSON only.

*4 This information is not recorded with this unit.

-
- Only printable ASCII characters can be displayed by this unit.
 - Due to the limitations imposed by this unit on the number of characters which can be displayed, not all the data can be displayed. (This does not mean that the data which is not displayed has been deleted.) Use an AVCCAM viewer or other program to check all the data.
-

Uploading the metadata (META DATA)

You can perform any of the following operations. If necessary, make preparations prior to undertaking the operations.

Loading the metadata

- Load the metadata recorded on the left-channel SD Memory Card. (For details on contents of the metadata, see the previous page.)

Selecting whether to record the metadata on the SD Memory Cards

Initializing the metadata inside the unit

Displaying the metadata inside the unit

- 1 Press the mode button and select **CAMERA** mode.
- 2 Press the **MENU** button.
 - Menu operation (Page 75)
- 3 Tilt the lever in the **▲ ▼** directions to select **META DATA**, and push the Operation lever (or tilt in the **▶** direction).

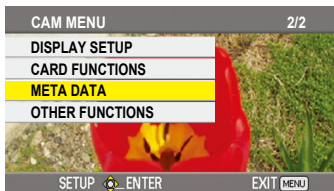

- 4 Tilt the Operation lever in the **▲ ▼** directions to select item, and push the Operation lever.

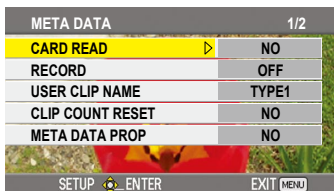

CARD READ:

Read metadata set to the SD Memory Card with the camera.

Move to **LOAD**, push the Operation lever, select whether or not to read the metadata (YES/NO), and push the Operation lever again.

- Up to 10 items of metadata on the SD Memory Card can be displayed, starting from the most recent date of production.
- If characters other than single-byte alphanumeric characters are used in the metadata file name to be loaded, they are displayed as “*”.

RECORD:

Select this to set whether to record the metadata to be loaded into the unit simultaneously on the SD Memory Cards. Select **ON** to record the metadata or **OFF** to cancel the recording, and push the Operation lever.

The factory setting for this mode is **OFF**.

USER CLIP NAME:

The **USER CLIP NAME** recording method is selectable. (For details: Page 52)

CLIP COUNT RESET:

Reset the counter value to 1.

Select whether or not to reset (YES/NO), and push the Operation lever.

META DATA PROP:

Select this to display the metadata which has been recorded in the unit.

META INITIAL SET:

Select this to initialize the metadata which has been recorded in the unit.

Select **YES** to initialize the metadata or **NO** to cancel the initialization, and push the Operation lever.

- 5 Press the **MENU** button to release the menu mode.

Clip metadata (continued)

Selecting the USER CLIP NAME recording method

Press the MENU button and select META DATA → USER CLIP NAME to select the recording method. Two options are available: TYPE1 and TYPE2.

USER CLIP NAME to be recorded

	TYPE1	TYPE2
If clip metadata has been read in	Uploaded data	Uploaded data + COUNT value*
If no clip metadata has been read in or if the setting for recording clip metadata has been turned off	Sequential 5-digit number, in order of recording	Sequential 5-digit number, in order of recording

* The COUNT value is indicated as a four-digit number. The COUNT value is incremented each time a new clip is captured if clip metadata has been read in and TYPE2 has been selected as the recording method. The COUNT value can be reset using the following procedure.

Press the MENU button, select META DATA → CLIP COUNT RESET → YES, and push the Operation lever to reset the counter value to 1.

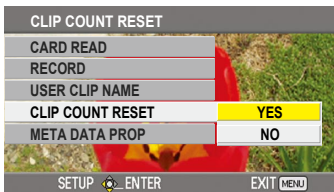

Using the Counter

You can display a counter that indicates how much time has elapsed during shooting or playback.

1 Press the COUNTER button.

Each time you press the button, the display changes as follows. (Page 68)

0 : 00. 00 (CAMERA mode only)

Counter value

CLIP 0 : 00 . 00

Displayed when CLIP is selected in the REC COUNTER item on the settings menu DISPLAY SETUP screen.

Values are automatically reset when recording is started, and counter values are displayed for each individual clip.

TC 12 : 34 : 56 . 01

Time code value

If SYSTEM FREQ is set to 59.9 Hz, time code frame digits are displayed in 24 frames when 24P is set, and in 30 frames when any other format is set.

If SYSTEM FREQ is set to 50 Hz, time code frame digits are displayed in 25 frames.

UB 12 34 56 78

User information

No display

Data is not displayed.

Resetting the counter

Press the RESET button while the counter is displayed.

Charging the built-in battery/Setting the time code

Recharging the built-in battery

The camera's internal battery saves the date and time.

When LOW INTERNAL BATTERY (indicating that the internal battery has no remaining charge) is displayed even when the date and time are set, it means that the charge of the internal battery is depleted. Do the following to recharge it.

Reset the date and time when fully recharged.

1 Connect the AC adaptor. (Page 24)

- Leave the POWER/Mode selector switch at OFF.

2 Leave the camera like this for about 4 hours.

- The internal battery charges during this time.
- Check the time code and menu operations after recharging.

If the date and time are not memorized after recharging, the internal battery requires changing. Please consult the place of purchase.

Setting the time code

In the setup menus, TC/UB SETUP screen, set the following time code related items. (Page 80)

- **TC MODE**
(Only when SYSTEM FREQ is set to 59.9 Hz)
- **TCG**
- **TC PRESET**

Specifying the time code (TC PRESET)

Set TC PRESET so you can record a value of your choice as the initial setting for the time code to be used at the start of recording.

1 Set the POWER/Mode selector switch to ON.

2 Select the TC PRESET item on the settings menu TC/UB SETUP screen.

- Menu operation (Page 75)

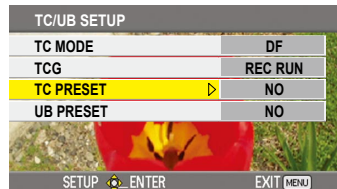

3 Tilt the Operation lever in the ▲ direction to move to YES, and push the Operation lever.

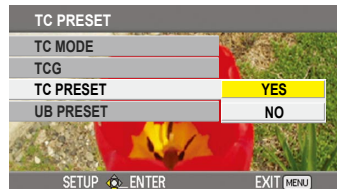

4 When the screen below appears, set the time code value.

Tilt the Operation lever in the ▲ ▼ directions and select time code value.

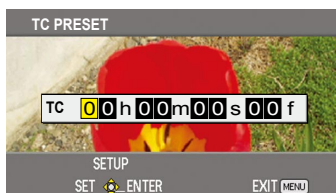

Tilt in the ► direction to move to the next digit, and tilt in the ▲ ▼ directions again to select value.

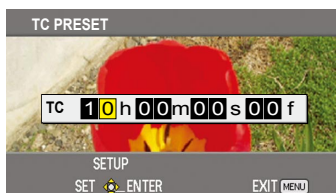

You can reset the time code to zero by pressing RESET button.

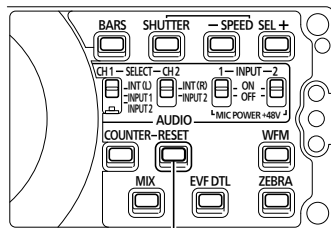

RESET button

5 Push the Operation lever when you have finished setting the time code.

6 Tilt the Operation lever in the ▲ direction to move to YES, and push the Operation lever.



With this unit, the time code value is adjusted in accordance with the format and frame rate. For this reason, bear in mind that making a change in the format or frame rate may result in discontinuity from the last time code value of the previous recording. (Only when SYSTEM FREQ is set to 59.9 Hz)

Recording format	Time code adjustment
1080/24P	Adjustable in 4-frame increments

Setting user information

Setting user information allows you to store 8-digit information in the hexadecimal format. User information is automatically saved in the memory and retained after you turn off the power.

- 1 Set the **POWER/Mode selector switch** to **ON**.
- 2 In the setup menus, **TC/UB SETUP** screen, select **UB PRESET**.
 - Menu operation (Page 75)

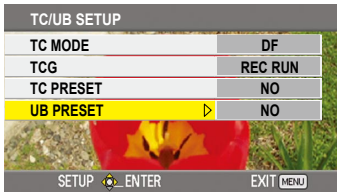

- 3 Tilt the **Operation lever** in the **▲** direction to move to **YES**, and push the **Operation lever**.



- 4 Set the user information.
 - Tilt the **Operation lever** in the **▲▼** directions and select user information characters.
 - You can use numbers from 0 to 9 and letters from A to F.

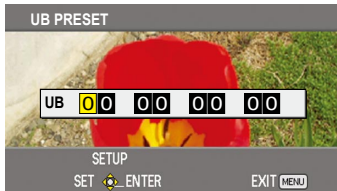

Tilt in the **▶** direction to move to the next digit, and tilt in the **▲▼** directions again to select character.

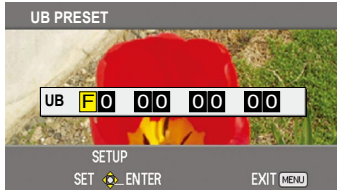

You can reset the user information to nothing by pressing **RESET** button.

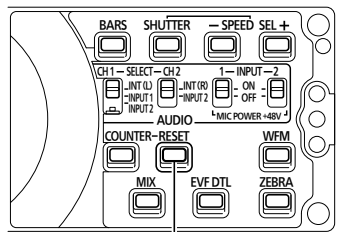

RESET button

- 5 Push the **Operation lever** when you have finished setting the user information.
- 6 Tilt the **Operation lever** in the **▲** direction to move to **YES**, and push the **Operation lever**.

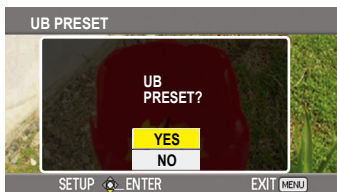

Basic playback operations

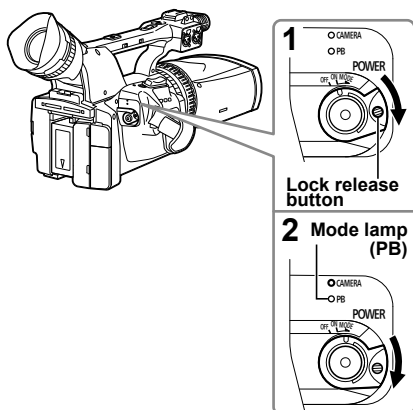

1 Turn the POWER/Mode selector switch to ON.

While pressing the lock release button, turn the switch to ON.

2 Press the POWER/Mode selector switch downwards so the mode lamp (PB) turns on.

The camera is now in the PB mode.

- Each time you press the button, the mode changes as below.

PB ↔ CAMERA

3 Play a clip using the Operating lever.

- For details on playing back clips using thumbnails, see page 58.

<p>Push</p> <p>MENU EXEC PUSH ENTER AUDIO MON/ADV</p>	<p>Play (▶)</p> <p>Push to play the clip currently indicated by the cursor.</p>
<p>Tilt rightward</p> <p>MENU EXEC PUSH ENTER AUDIO MON/ADV</p>	<p>Fast forward (▶▶)</p> <p>Tilt <u>during playback</u> to scroll quickly through the clip. Tilt <u>while paused</u> to move to the next clip.</p>
<p>Tilt leftward</p> <p>MENU EXEC PUSH ENTER AUDIO MON/ADV</p>	<p>Rewind (◀◀)</p> <p>Tilt <u>during playback</u> to scroll quickly backwards through the clip. Tilt <u>while paused</u> to move to the beginning of the current clip and then to the previous clip.</p>
<p>Tilt downwards</p> <p>MENU EXEC PUSH ENTER AUDIO MON/ADV</p>	<p>Stop (■)</p>
<p>Tilt upwards</p> <p>MENU EXEC PUSH ENTER AUDIO MON/ADV</p>	<p>Pause ()</p> <p>Tilt during playback to pause the clip.</p> <p>Play (▶)</p> <p>Tilt again to return to normal playback.</p>

- Clips shot by another AVCCAM or AVCHD device cannot be played back with this unit. Clips shot with this camera will not be played back if you record on an SD Memory Card using another AVCCAM or AVCHD device or delete some clips from the SD Memory Card.
- During initiation of an operation, for example, starting playback or between play of multiple clips in succession, video and audio are muted and a black screen appears. This is not a malfunction.
- You cannot view a 3D image during fast forward or rewind. In these modes, the image from the left lens is displayed on both the left and right channels.

Thumbnail screen

Video data created in one shooting session is called a clip. When the PB mode has been established, the clips will be displayed on the LCD monitor as thumbnails. (When there is a large number of clips, it will take some time for them to be displayed on the screen.)

You can perform the following operations using the thumbnail screen.

- Play and delete clips
- Add or delete shot marks

Basic thumbnail screen operations

To select a thumbnail:

Tilt the Operation lever in the ▲▼◀▶ directions to select a thumbnail (yellow frame moves).

To play back clips:

Select the thumbnail, and push the Operation lever.

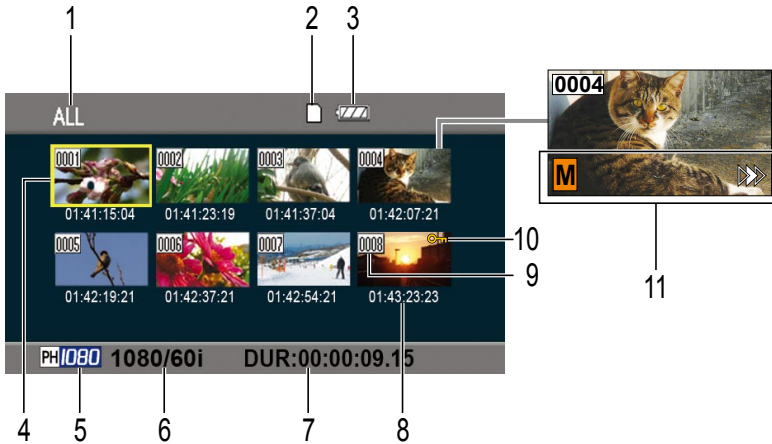
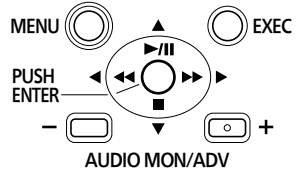

1 Thumbnail display status (Page 61)

The types of clips displayed as thumbnails appear in this area.

2 Card status display

Displays the status of SD Memory Card.

3 Battery remaining display (Page 70)

Displays the remaining battery capacity.

4 Cursor (yellow frame)

Displayed on the currently selected thumbnail.

5 Recording mode display

Displays the recording mode of the clip currently highlighted by the cursor.

6 Recording format display

Displays the recording format of the currently selected clip.

7 Duration display

Displays the duration of the currently selected clip.

8 Time display (Page 61)

Displays the time code at the start of clip recording/user information at the start of clip recording/time of recording/date of recording/date and time of recording—according to the settings.

9 Clip number

Displayed in order of recording (up to 200 clips). Numbers of clips that cannot be played back (e.g. clips of different recording formats) are displayed in red.

10  : Clip protect display

Displayed on the protected clips.

11 Indicators** : Shot mark**





This indicates that a clip has a shot mark. (Right column)

 : Resume playback display

Displayed on the clips on which the resume playback setting has been applied.

Adding shot marks to clips

Adding shot marks () will make it easier to find the clips you are looking for.

1 Tilt the Operation lever in the     directions to move the yellow frame to the clip for which a shot mark is to be added.

2 Press the USER button to which the shot mark function has been allocated. (Page 79)

To release a shot mark, repeat the above steps.

- It is possible to add shot marks to clips recorded using this product only.

Playback settings (PLAY SETUP)

Resume playback (RESUME PLAY)

Use this setting to play back from where the clip had previously been paused.

- 1 Press the MENU button.**
 - Menu operation (Page 75)
- 2 Set the RESUME PLAY item on the PLAY SETUP screen to ON.**
- 3 Press the MENU button to return to the thumbnail screen.**
- 4 Select a clip for playback.**

If playback has previously been paused, the resume playback indicator  will be displayed on the clip thumbnail, and the remainder of the clip will be played next time the clip is selected for playback.

 - To turn the resume playback setting off, select OFF in step **2**.

Thumbnail operations

Selecting the thumbnail display method (THUMBNAIL SETUP)

You can display the kind of clips you want to see as thumbnails.

You can also set more precisely how you want the thumbnails to appear on the screen.

- 1 Press the **MENU** button.
 - Menu operation (Page 75)
- 2 Select the **THUMBNAIL SETUP** screen, and push the **Operation lever** (or tilt in the ► direction).

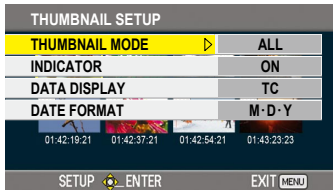

- 3 Tilt the **Operation lever** in the ▲▼ directions to select item, and push the **Operation lever**.

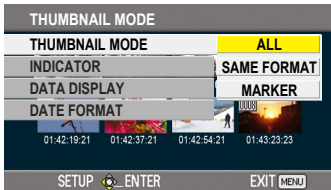

THUMBNAIL MODE:

Select the clips to be displayed.

ALL:

Display all clips.

SAME FORMAT:

Display all clips of the same format as the current recording format for CAMERA mode.

MARKER:

Display all clips with shot marks.

INDICATOR:

Set whether or not to display the indicators (ON/OFF). (Factory default setting is ON.) Clip protect display and resume playback display will still appear even if this setting is set to OFF.

DATA DISPLAY:

Select the format of clip time display – time code (TC)/user information (UB)/recording time (TIME)/recording date (DATE)/recording date and time (DATE & TIME).

DATE FORMAT:

Select the display order for recording date - year-month-date (Y-M-D)/month-date-year (M-D-Y)/date-month-year (D-M-Y).

This setting will not be reflected in CLIP PROPERTY.

- 4 Press the **MENU** button to return to the thumbnail screen.

Thumbnail operations (continued)

Deleting and protecting clips (OPERATION)

Clips may be deleted or protected.

- 1 Press the **MENU** button.
 - Menu operation (Page 75)
- 2 Select the **OPERATION** screen, and push the **Operation lever** (or tilt in the direction).

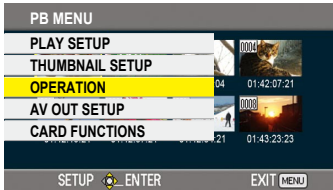

- 3 Tilt the **Operation lever** in the **▲▼** directions to select item, and push the **Operation lever**.

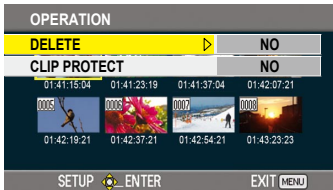

DELETE:

ALL CLIPS:

Delete all clips.

Select whether or not to delete (YES/NO), and push the **Operation lever**.

SELECT:

Delete selected clips.

Select clips with the **Operation lever**.

Selected clips will be outlined in orange. (Repeat this operation to select multiple clips.)

Press the **EXEC** button to confirm, tilt the **Operation lever** in the **▲▼** directions to select whether or not to delete (YES/NO), and push the **Operation lever**.

NO:

Return to the previous screen.

- Protected clips cannot be deleted.
- If selecting ALL CLIPS to delete all clips from the memory, this operation may take some time to complete, depending on the volume of clips to be deleted.

CLIP PROTECT:

YES:

Select clips and push the **Operation lever** to protect the selected clips. (**ON** mark will be displayed.)

- Cancel protection when the protected clip is selected.

(**ON** mark will disappear.)

Executing a format of the memory card will delete all clips even if they are protected.

NO:

Return to the previous screen.

- 4 Press the **MENU** button to return to the thumbnail screen.

Checking clip information (CARD FUNCTIONS)

Clip information can be checked.

Clip information screen

- 1 Press the **MENU** button.
 - Menu operation (Page 75)
- 2 Select **CARD FUNCTIONS**, and push the **Operation lever** (or tilt in the ► direction).



- 3 Select **YES**, and push the **Operation lever**. Information of the selected clip is displayed on **CLIP PROPERTY**. (Right column)

- Tilt the **Operation lever** in the ◀► directions to display information from previous or subsequent clips.

- 4 Press the **MENU** button to return to the thumbnail screen.

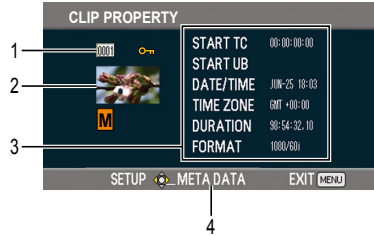

- 1 **Clip number**
- 2 **Thumbnail** (Thumbnail screen: Page 58)
- 3 **Clip information**

Displays the indicators attached to the clip, and various other information.

- START TC:** Time code value at start of recording
- START UB:** User information value at start of recording
- DATE/TIME:** Date of recording and time at start of recording
- TIME ZONE:** Time zone
- DURATION:** Clip length
- FORMAT:** Recording format

- 4 **Clip meta data**

Push the **Operation lever** while the clip information screen is displayed to display more detailed information, including video and audio formats, name of the videographer, etc.

Tilt the **Operation lever** in the ▲▼ directions to verify the desired information. (For more information on clip metadata: Page 50)

Useful playback functions

Fast forward/rewind

- 1 Tilt the Operation lever in the ◀◀ (rewind) or ▶▶ (fast forward) direction during playback.

A clip will play forwards or backwards at approximately 5 times normal speed.

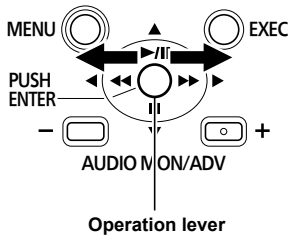

For a higher speed forward or rewind (at approximately 15 times normal speed), tilt the Operation lever in the ▶▶ (fast forward) or ◀◀ (rewind) direction again during fast forward or rewind.

To return to normal playback, tilt the Operation lever in the ▲ direction (play).

- The screen will return to the thumbnail display after the playback of the last clip is completed during fast forward playback.
- The screen will return to the thumbnail display after the playback of the first clip is completed during rewind playback.
- No audio will be played during fast forward or rewind playback.

Next/previous clip

- 1 Tilt the Operation lever in the ▲ direction during playback to pause the clip.

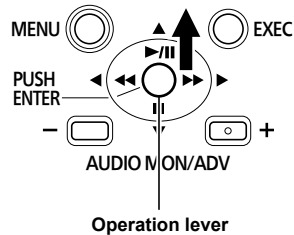

- 2 Tilt the Operation lever in the ◀◀ (rewind) or ▶▶ (fast forward) direction during playback.

- The screen will return to the thumbnail display when moving beyond the beginning of the first clip or the end of the final clip.

Frame-by-frame playback

- 1 Tilt the Operation lever in the ▲ direction during playback to pause the clip.
- 2 Press the AUDIO MON/ADV buttons.

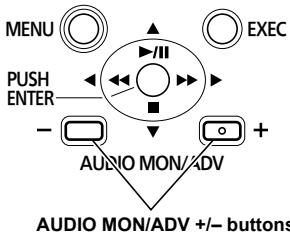

When the + button is pressed, the images are advanced in the forward direction, and when the - button is pressed, they are advanced in the reverse direction at half-second intervals. To return to normal playback, tilt the Operation lever in the ▲ direction (play).

Adjust volume

The volume of audio output from the internal speaker and headphone jack can be adjusted with the AUDIO MON/ADV buttons during playback.

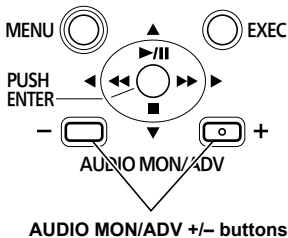

Viewing images on a monitor or television

You can view the images on a monitor or television if you connect the unit using HD SDI cables (not included) or HDMI cable (not included).

- 1 Connect the camera to the monitor or TV set. (Page 67)
- 2 Start playback.
 - To show the information that appears on the viewfinder and the LCD monitor on the monitor or television, select ON in the OUTPUT OSD item on the setup menu DISPLAY SETUP screen. (Page 81)

Checking the date and time

To show the date and time of shooting on the viewfinder and the LCD monitor, select the item to be displayed with the DATE/TIME item on the setup menu DISPLAY SETUP screen. (Page 81)

TIME: To display the time

DATE: To display the date

TIME & DATE: To display the time and date

OFF: No display

Connecting external units

Headphones

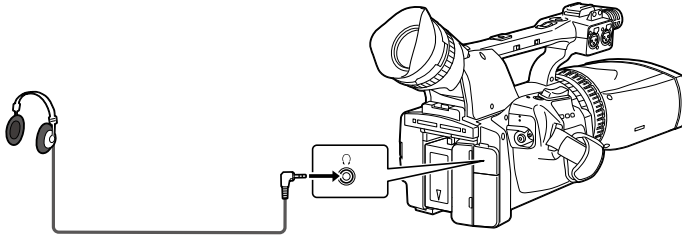

3.5-mm stereo mini jack

- Sound is no longer heard from the speaker when the headphones (optional) are connected.

External microphone

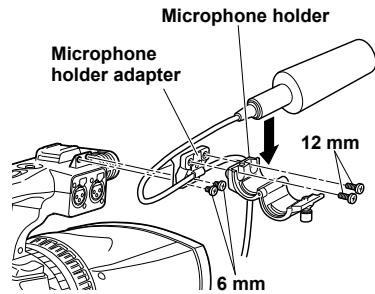
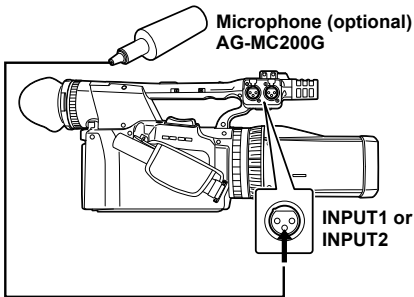

- When attaching an external microphone to the microphone shoe, use the supplied microphone holder and microphone holder adapter.
- When attaching the microphone holder and the microphone holder adapter, be sure to tighten the screws firmly even though you might hear a squeaking sound.

TV/Monitor

Only the output signals from the camera are shown.

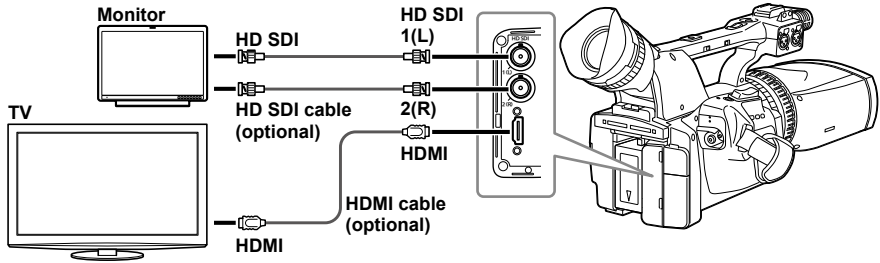

- The signals cannot be output simultaneously from both the HD SDI terminals and HDMI terminal.

-
-
- Connect the left (L) and right (R) connectors correctly. Reverse connection may cause eyestrain.
-
-

Screen displays

Regular displays

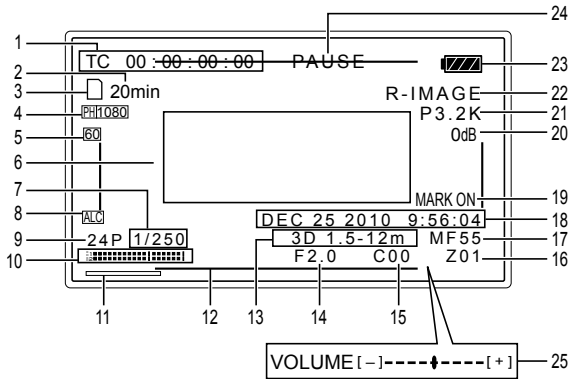

1 Time code display

Each time you press the COUNTER button, the display switches over to the following data (or no indication).

COUNTER:

Counter value

CLIP:

CLIP counter value for respective clip
Displayed when the REC COUNTER item on the settings menu DISPLAY SETUP screen is set to CLIP.

- During playback, the time code display is automatically set to CLIP, and the time code is counted from a value of 0:00:00 for each clip.

TC:

Time code value

When the time code value could not be read correctly from the SD Memory Card, [TC*] is displayed.

UB:

User information

When user information could not be read correctly from the SD Memory Card, [UB*] is displayed.

2 Media capacity display

Displays a rough guide of the remaining recording capacity of the card in use.
Not displayed during PB mode.

3 Media information display

Displays basic information about inserted SD Memory Cards.

: Recording possible with both right and left cards

: Right and/or left card is write-protected

: Recording not possible with right and/or left card

: Right and/or left card is full

- Recording may be possible in some cases even when this icon is displayed.
- Depending on the memory size and type of SD Memory Card used, the icon may not be displayed even when the card's memory becomes full during shooting and shooting is stopped.

: Playback-only

SD Memory Cards already containing 200 or more clips may be used for playback only.

: Accessing card

: No card inserted

4 Recording format display (Page 80)

5 System frequency display

60: 59.9 Hz 50: 50 Hz

6 Information display

The following information is displayed depending on the situation.

- Warning (Page 71)
- Performance of the auto white balance or the auto black balance
- Switch position

7 Shutter speed display

The shutter speed is displayed here.

8 Microphone level automatic control display

Appears when the MIC ALC item on the setup menu RECORDING SETUP screen is set to ON.

9 Frame rate display

Displays recording frame rate.

- When SYSTEM FREQ is set to 59.9 Hz, 1080/60i is not displayed.
- When SYSTEM FREQ is set to 50 Hz, 1080/50i is not displayed.

10 Audio level meter display (Page 49)

Displayed when the LEVEL METER item on the setup menu DISPLAY SETUP screen is set to ON.

11 Focus bar display

Displayed when the FOCUS BAR button is pressed.

12 Safety zone

The range of the zone is displayed when the SAFETY ZONE item on the setup menu DISPLAY SETUP screen is set to ON. (Page 81)

This indicates the range (90 %) within which signals can be displayed by an ordinary home-use TV set.



13 3D guide display

Displays the shooting range of distance within which the shot subject can be reproduced as a comfortable 3D image.

- Use this as a rough guide.

14 Iris display

Displays the F-value.

15 Convergence display

The distance of the reference plane for a 3D image is displayed with C00 to C99.

The higher the number is, the greater the distance is.

- Use this as a rough guide.

16 Zoom position display

The zoom position is displayed with Z00 (maximum wide-angle) - Z99 (maximum zoom).

17 Focus control information display

Displays the focus control information with 95 - 00.

In the manual focus mode, MF appears. MF is not displayed when the PUSH AUTO button is pressed and the auto focus mode is set. When the display is set to macro control, the black and white of MF are displayed in reverse.

95 (Focal distance: infinity)

:

00 (Focal distance: approx. 5 cm)

Depending on the zoom position, the macro range may not be enabled.

Also, depending on the zoom position, the lower limit value of the macro range may be different.

18 Date and time display

Month:

- JAN (January), FEB (February),
- MAR (March), APR (April), MAY (May),
- JUN (June), JUL (July), AUG (August),
- SEP (September), OCT (October),
- NOV (November), DEC (December)

Day of the month

Year:

2001 - 2039

Hours

Minutes

Seconds

mmm dd yyyy hh:mm:ss

19 Shot mark recording display

(SHOT MARK)

Displayed when a USER button to which the SHOT MARK function has previously been allocated is pressed during recording.

INVALID will be displayed if a shot mark cannot be attached.

(Continued on the next page)

Screen displays (continued)

20 Gain display

Displays the gain value of the image amplifier configured.

21 White balance information display

Displays the information on white balance.

P3.2 K/P5.6 K: Preset value

Ach/Bch: Value set to position A or B of WHITE BAL switch

22 Screen mode display

Displays the current screen mode.



It is cancelled when the display status is changed, for example, when a menu is changed or REC CHECK is performed.

R-IMAGE: The image from the right lens is displayed.

MIX: The images from the left and right lenses are superimposed and displayed.

23 Remaining battery capacity display

The battery display will change

 as battery capacity decreases.  will be displayed in red when the battery is empty.

- Remaining battery capacity may not be displayed correctly with use at high or low temperatures, or when the battery has not been used for a long period of time. To ensure that remaining battery capacity is displayed correctly, use the battery completely from a fully-charged state, and charge the battery again. (Remaining battery capacity may still not be displayed correctly if the battery has been used for long periods at high or low temperatures, or if the battery has been recharged a large number of times.)
- The remaining battery capacity display is a guideline and may change according to usage conditions.

24 Operation status display



REC: Recording

PAUSE: Recording standby



CHK: Rec check



 : Playback



 : Playback paused

 (): Frame-by-frame playback (Frame-by-frame reverse playback)

 (): Skip (reverse skip)

 (): Fast forward/fast playback (Rewind/fast reverse playback)

 (): High-speed forward (high-speed rewind)

 (): Paused in final scene (paused in initial scene)

25 Monitor audio level meter

When you press the AUDIO MON/ADV button, the sound volume output from the built-in speaker and headphone jack is displayed.

Main warning displays

The main warning displays appearing on the LCD monitor or viewfinder are listed below. If a warning display is not listed, check carefully the message displayed.

■ C

CANNOT BE USED DUE TO INCOMPATIBLE DATA.

No use is possible because the standard for the data is different.

If the system frequency has been changed, format the SD Memory Cards with current SYSTEM FREQ setting.

CANNOT DELETE.

Clip cannot be deleted.

CANNOT DELETE WITH THIS BUTTON

Clip cannot be deleted.

CANNOT HANDLE. THE NUMBER OF CLIPS HAS EXCEEDED THE MAXIMUM LIMIT.

The maximum number of clips has been reached and no further operation is possible.

CANNOT OPERATE. FAN MOTOR IS STOP. PLEASE TURN OFF.

The unit cannot operate, as the fan motor has stopped. Turn off the power.

CANNOT OPERATE. TEMPERATURE IS HIGH. PLEASE TURN OFF AND WAIT A WHILE.

The unit cannot operate, as the temperature is too high. Turn off the power and wait a while.

CANNOT PLAY.

No playback is possible.

CANNOT PLAY WITH THIS BUTTON

No playback is possible.

CANNOT PROTECT.

Clip protection is not possible.

CANNOT RECORD. THE NUMBER OF CLIPS HAS EXCEEDED THE MAXIMUM LIMIT.

The maximum number of clips has been reached and no further clips can be recorded.

CANNOT RECORD VIDEO IMAGES ARE PROTECTED. REMOVE PROTECTION? YES NO

Recording is not possible, as the video images in the card are protected. Do you wish to remove the protection?

Yes/No

CANNOT RECORD — INCOMPATIBLE CONTROL DATA.

Recording is not possible, as the unit does not support this control data.

CANNOT RECORD 3D CLIP INTO THIS CARD

3D clips cannot be recorded with this card.

CANNOT RECORD 3D CLIP THIS CARD. PLEASE CHANGE THE CARD.

3D clips cannot be recorded with this card. Use cards of class 4 or above.

CANNOT SELECT MORE CLIPS.

Additional clips cannot be selected.

CANNOT SET.

The operation you intended is not possible now.

CARD DOOR OPENED.

The SD Memory Card slot cover is open.

CARD ERROR. PLEASE REFORMAT.

Formatting has failed. The card needs to be reformatted.

CARD FULL.

The card is full.

(Continued on the next page)

CHECK CARD.

Please check the card.

If you use an SD Memory Card that has been used with other devices or personal computers, for the first time with this unit, CHECK CARD may be displayed and the unit cannot operate. In this case, perform the following:

- ① Remove the SD Memory Card from the unit and reinsert it. (Page 30)
The CHECK CARD display may disappear if the unit detects the card.
- ② If CHECK CARD remains displayed even if you remove and insert the card several times, check the contents of the card and delete all its data, using a personal computer.
- ③ Format the card with this unit. (Page 30)

If the data in the card is unreadable or cannot be deleted with a personal computer, the card may be damaged. Use another SD Memory Card.

CLIP NUMBER IS FULL

No more clips can be recorded with this card.

CONTROL DATA ERROR HAS BEEN DETECTED.

An error has been detected in the control information.

I

INCOMPATIBLE DATA

Data are incompatible with this unit.

If INCOMPATIBLE DATA is displayed and the unit cannot operate, perform the following:

- ① Remove the SD Memory Card from the unit.
- ② Check the contents of the card and delete all its data, using a personal computer.
- ③ Format the card with this unit. (Page 30)

If the data in the card is unreadable or cannot be deleted with a personal computer, the card may be damaged. Use another SD Memory Card.

INCOMPATIBLE CARD. PLEASE CHECK CARD.

Recording may not be successful with this card. Please check the card.

L

LOW BATTERY

The remaining battery power is low.

LOW INTERNAL BATTERY

The remaining power of the internal battery is low.

N

NO CARD

No card is inserted.

NO DATA

There are no clips in the card.

NOW ACCESSING.

PLEASE DO NOT REMOVE CARD.

Card is currently being accessed. Please do not remove the card.

P

PLAYBACK ONLY

The card is for playback only.

R

REC STOPPED BY REC SIZE LIMIT. PLEASE PUSH REC BUTTON AGAIN TO RESTART.

Recording has stopped, as the maximum file size that can be recorded has been exceeded. If you wish to continue recording, press the START/STOP button.

S

SD CARD FORMAT?

YES NO

Do you wish to format the SD Memory Card now?
Yes/No

SET DATE AND TIME

Set the date and time.

T

THE CLIP IS PROTECTED. PLEASE CANCEL PROTECTION.

The clip is protected. Please cancel the protection.

THE TC MODE IS CHANGED TO "NDF"

NDF is selected as the TC MODE setting.
(Only when SYSTEM FREQ is set to 59.9 Hz)

THIS CARD CANNOT RECORD IN VIDEO MODE.

The card cannot be used for video recording.

THUMBNAIL DATA ERROR IS DETECTED.

An error has been detected in the thumbnail information.

TURN POWER OFF

Turn the power off.

U

UNABLE TO FORMAT.

The card cannot be formatted.

USER CLIP NAME MODIFIED

The user clip name you entered has been modified.

W

WRITE PROTECT

The card is write-protected.

Main error displays

The following messages are displayed when an error has occurred in the camera or the SD Memory Card. If the problem is not solved by switching the power off and back on again, either change the card in accordance with the instructions displayed, or consult the place of purchase.

C

CANNOT RECORD

Displayed when an error has occurred during recording.

N

*** * *NG**

Displayed when an error has occurred with the camera itself. Start the recording again.
FOCUS NG (error with focus operation)
ZOOM NG (error with zoom operation)

R

REC WARNING

Displayed when an error has occurred during recording. Start the recording again. If the message appears again, please consult the place of purchase.

- Please switch the power off if the message continues to appear.
- Please try inserting a different card if the message appears again after restarting recording.

S

SYSTEM ERROR

TURN POWER OFF

Displayed when an error has occurred in the system. Switch the power off and back on again.

- If this error is displayed when accessing the SD Memory Card, such as when deleting a clip, the SD Memory Card may be damaged. Please replace it with a new SD Memory Card.

Screen displays (continued)

Setting the DISPLAY items

Display the following items on the viewfinder and LCD monitor by pressing the DISP/MODE CHK button or by configuring OTHER DISPLAY of the DISPLAY SETUP screen of the setup menus. (Page 82)

Displays	MODE CHK (Hold down DISP/ MODE CHK button)	DISPLAY	OTHER DISPLAY settings	
			ON	OFF
1 Time code display	✓	—	—	—
2 Media capacity display	✓	✓	—	—
3 Media information display	✓	✓	—	—
4 Recording format display	✓	✓	✓	x
5 System frequency display	✓	✓	✓	x
6 Information display	✓	—	—	—
7 Shutter speed display	✓	✓	✓	x
8 Microphone level automatic control display	✓	✓	✓	x
9 Frame rate display	✓	✓	✓	x
10 Audio level meter display	✓	✓	—	—
11 Focus bar display	✓	✓	—	—
12 Safety zone	—	—	—	—
13 3D guide display	—	✓	—	—
14 Iris display	✓	✓	✓	x
15 Convergence display	✓	✓	—	—
16 Zoom position display	✓	✓	—	—
17 Focus control information display	✓	✓	—	—
18 Date and time display	✓	✓	—	—
19 Shot mark recording display	—	—	—	—
20 Gain display	✓	✓	✓	x
21 White balance information display	✓	✓	✓	x
22 Screen mode display	✓	✓	—	—
23 Remaining battery capacity display	✓	✓	—	—
24 Operation status display	—	—	—	—
25 Monitor audio level meter	—	—	—	—

- ✓: Displayed
- x: Not displayed
- : Displayed depending on other settings

The item in ✓ in the MODE CHK space appears when you press and hold the DISP/MODE CHK button.

The item in ✓ in the DISPLAY space disappears when you press the DISP/MODE CHK button.

Using the setup menus

Use the setup menus to change the settings to suit the scenes you are shooting or what you are recording.

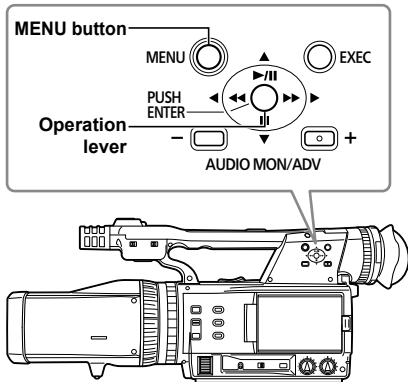

Using the menus

- The menu items indicated in the gray characters cannot be changed its settings.
- Only the CARD FUNCTIONS screen can be changed when the left and right SD Memory Cards are inserted in reverse order or unformatted SD Memory cards are inserted.

1 When the unit is in other than playback or recording mode, press the MENU button. The following is displayed on the viewfinder and LCD monitor.

CAMERA mode (Example)

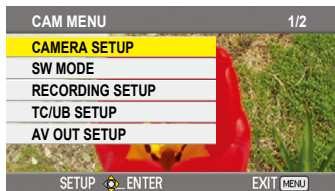

PB mode (Example)

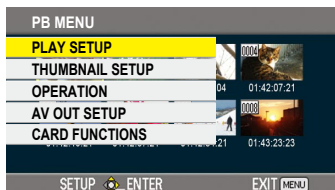

2 Tilt the Operation lever in the ▲▼ directions to move the yellow cursor to the function you wish to set.

Example:



3 Push the Operation lever (or tilt in the ► direction) to display the setting items.

Example:

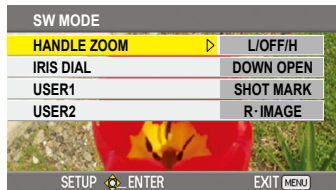

4 Tilt the Operation lever in the ▲▼ directions to move the yellow cursor to the item you wish to set.

Example:

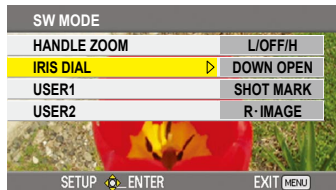

5 Push the Operation lever (or tilt in the ► direction) to set the item.

To change values or other parameters, tilt the Operation lever in the ▲▼ directions.

Example:

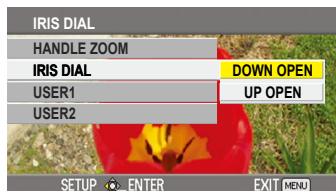

- Tilt the Operation lever in the ◀ direction to return to the previous menu.

(Continued on the next page)

6 Repeat steps 4 - 5 to change any other items.

Press the MENU button to complete settings and return to the normal screen.

7 Repeat steps 2 - 5 to change any other settings.

Press the MENU button to complete settings and return to the normal screen.

Initializing the menu settings

You can initialize the menu settings to their factory default ones by selecting YES for the MENU INIT item on the OTHER FUNCTIONS screen. (Page 83)

- The TIME ZONE setting will not return to the factory setting.

Setup menu structure

Camera mode menu

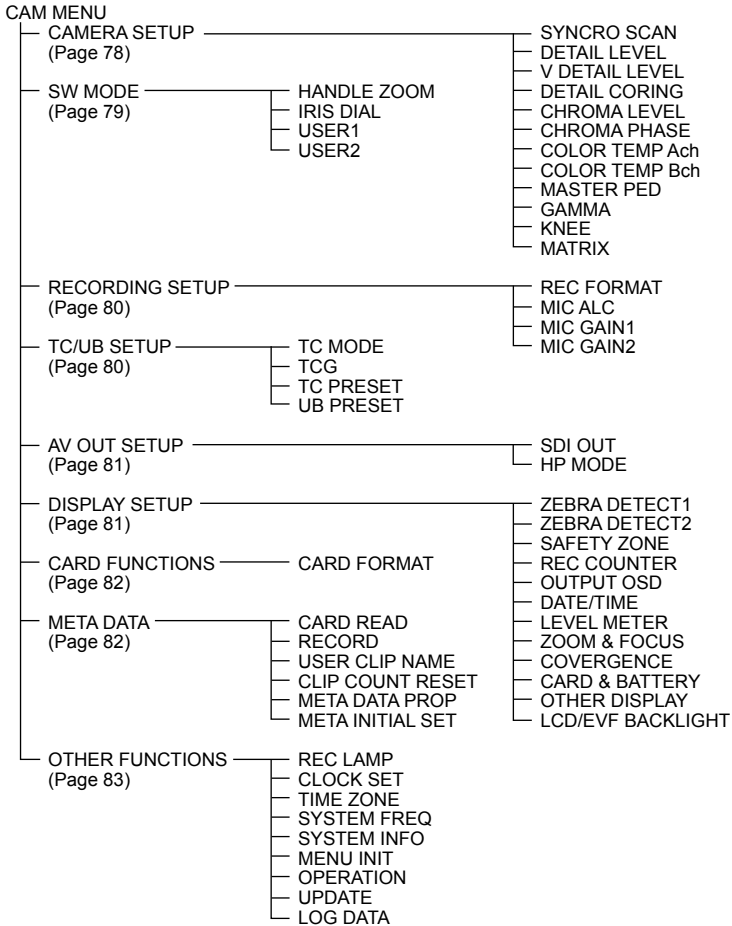

Playback mode menu

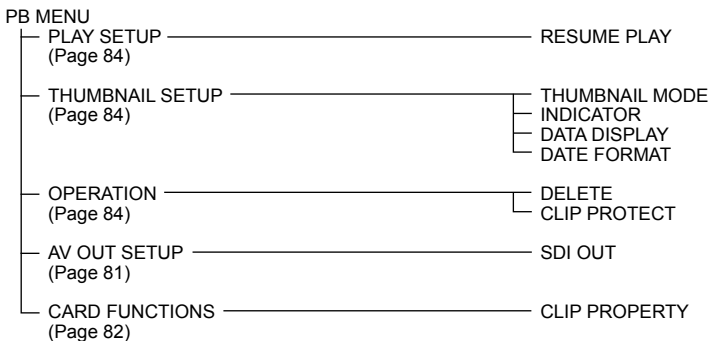

Setup menu list

CAMERA SETUP screen

Item	Display mode	Description of settings
SYNCHRO SCAN	(Camera)	<p>Adjusts the synchro scan shutter speed used for shooting images on a TV screen, etc.</p> <p>Holding the Operation lever toward the ◀ or ▶ direction will cause the values to change at a faster rate.</p> <p>Available shutter speeds with SYSTEM FREQ 59.9 Hz</p> <ul style="list-style-type: none"> • 60P/60i: 1/60.0...1/250.0 • 30P: 1/30.0...1/48.0...1/250.0 • 24P: 1/24.0...1/48.0...1/250.0 <p>Available shutter speeds with SYSTEM FREQ 50 Hz</p> <ul style="list-style-type: none"> • 50P/50i: 1/50.0 ... 1/250.0 • 25P: 1/25.0 ... 1/48.0 ... 1/250.0
DETAIL LEVEL	(Camera)	<p>Adjusts the level of the image outline correction (in the horizontal and vertical directions).</p> <p>- 7...0...+ 7</p>
V DETAIL LEVEL	(Camera)	<p>Adjusts the level of outline correction in the vertical direction.</p> <p>- 7...0...+ 7</p>
DETAIL CORING	(Camera)	<p>Adjusts the level of noise reduction of the detail signal.</p> <p>- 7...0...+ 7</p> <p>Set to - for a clearer image. Noise increases slightly.</p> <p>Set to + to reduce noise.</p>
CHROMA LEVEL	(Camera)	<p>Adjusts the chroma level.</p> <p>- 7...0...+ 7</p>
CHROMA PHASE	(Camera)	<p>Makes fine adjustments to the chroma phase.</p> <p>- 7...0...+ 7</p>
COLOR TEMP Ach	(Camera)	<p>Makes fine adjustments to the color temperature (after white balance Ach adjustment).</p> <p>- 7...0...+ 7</p>
COLOR TEMP Bch	(Camera)	<p>Makes fine adjustments to the color temperature (after white balance Bch adjustment).</p> <p>- 7...0...+ 7</p>
MASTER PED	(Camera)	<p>Adjusts the master pedestal (black level of the image) as the basis for images.</p> <p>- 15...0...+ 15</p>
GAMMA	(Camera)	<p>Selects the gamma curves.</p> <p>HD NORM: This gamma setting is suitable for HD shooting.</p> <p>LOW: Makes a mellow image using the gamma curve which has a gentle incline in low-brightness curve. The contrast sharpens.</p> <p>HIGH: Expands the tone of dark parts and makes a brighter image using the gamma curve which has a sharp incline in low-brightness curve. The contrast softens.</p> <p>B.PRESS: Makes the contrast shaper than LOW.</p> <p>CINE-LIKE D: Uses a gamma designed to create cinema-like images.</p> <p>CINE-LIKE V: Uses a gamma designed to create cinema-like images with emphasized contrast.</p> <ul style="list-style-type: none"> • When you select CINE-LIKE gamma, we recommend setting the lens aperture lower than normal image level (approximately 1/2) for optimal results.

_____ indicates the factory setting.

CAMERA SETUP screen (continued)

Item	Display mode	Description of settings
KNEE	(Camera)	To avoid overexposure, select the compression level (knee point) of the high intensity video signals received through MOS. LOW: Low setting (Compression starts at approx. 80 %.) MID: Medium setting (Compression starts at approx. 90 %.) HIGH: High Setting (Compression starts at approx. 100 %.) • Not available when GAMMA is set to CINE-LIKE.
MATRIX	(Camera)	Selects the MATRIX table suitable for the desired color expression during shooting. NORM1: Suitable for shooting in the open air or under a halogen lamp. NORM2: Suitable for brighter colors than the NORM1 mode. CINE-LIKE: Suitable for cinema-like image.

SW MODE screen

Item	Display mode	Description of settings
HANDLE ZOOM	(Camera)	Sets the zoom speed assigned to each setting position of the HANDLE ZOOM switch. L/OFF/H: Sets LOW (low speed)/OFF/HIGH (high speed) to the 1/2/3 position. (Zoom is disabled when set to OFF.) L/M/H: Sets LOW (low speed)/MID (medium speed)/HIGH (high speed) to the 1/2/3 position. L/OFF/M: Sets LOW (low speed)/OFF/MID (medium speed) to the 1/2/3 position. (Zoom is disabled when set to OFF.)
IRIS DIAL	(Camera)	Sets the rotation direction and the aperture control of the IRIS/CONV. dial. DOWN OPEN: The iris opens when the IRIS/CONV. dial is turned downward. UP OPEN: The iris opens when the IRIS/CONV. dial is turned upward. • This setting does not change the direction of the convergence point adjustment.
USER1	(Camera)	Selects the function assigned to the USER1 button. INH: USER1 button is disabled. No function operates by pressing the USER1 button. R-IMAGE: The image from the right lens is displayed on the viewfinder and LCD monitor. MIX: The images from the left and right lenses are superimposed and displayed on the viewfinder and LCD monitor. (Page 38) SHOT MARK: Shot mark recording (Page 44)
USER2	(Camera)	Assigns a function to the USER2 button. The setting contents are the same as USER1. INH R-IMAGE MIX SHOT MARK

___ indicates the factory setting.

Setup menu list (continued)

RECORDING SETUP screen

Item	Display mode	Description of settings
REC FORMAT	(Camera)	<p>Selects the recording format.</p> <p>When SYSTEM FREQ is set to 59.9 Hz PH 1080/60i PH 1080/30P PH 1080/24P PH 720/60P</p> <ul style="list-style-type: none"> • PH 1080/24P represents native recording. <p>When SYSTEM FREQ is set to 50 Hz PH 1080/50i PH 1080/25P PH 720/50P</p>
MIC ALC	(Camera)	<p>Sets mic level auto control to ON or OFF. ON OFF</p> <p>Set to ON to reduce distortion at high input levels. To adjust the recording level of audio signals (not related to this setting), use the AUDIO LEVEL knobs.</p>
MIC GAIN1	(Camera)	<p>Sets the input level of the external microphone connected to the INPUT 1 terminal. (Page 48) -50dB -60dB</p>
MIC GAIN2	(Camera)	<p>Sets the input level of the external microphone connected to the INPUT 2 terminal. (Page 48) -50dB -60dB</p>

TC/UB SETUP screen

Item	Display mode	Description of settings
TC MODE	(Camera)	<p>Selects the correction mode of the internal time code generator when the time code of the internal time code generator is recorded.</p> <p>DF: Uses the drop frame mode. NDF: Uses the non-drop frame mode.</p> <ul style="list-style-type: none"> • TC MODE is automatically set to NDF when you set recording frame rate of recording format to 24P. (Only when SYSTEM FREQ is set to 59.9 Hz)
TCG	(Camera)	<p>Sets the mode in which you advance the internal time code generator.</p> <p>FREE RUN: The time code is advanced regardless of the operation mode.</p> <ul style="list-style-type: none"> • A slight time error may occur when switching to PB mode if the frame rate is set to 24P. (Only when SYSTEM FREQ is set to 59.9 Hz) <p>REC RUN: The time code is advanced only when recording.</p>
TC PRESET	(Camera)	<p>Sets the initial time code. YES NO</p> <ul style="list-style-type: none"> • Set the frame value to 0 or a multiple of 4 when you set recording frame rate of recording format to 24P. If any other value is set, the recorded time code will mis-match. (Only when SYSTEM FREQ is set to 59.9 Hz)
UB PRESET	(Camera)	<p>Sets the user information. YES NO</p>

___ indicates the factory setting.

AV OUT SETUP screen

Item	Display mode	Description of settings
SDI OUT	(Camera) (PB)	Sets whether to output the signal from the HD SDI terminal. ON: The signal is output from the HD SDI terminal. It is not output from the HDMI terminal. OFF: The signal is not output from the HD SDI terminal. It is output from the HDMI terminal.
HP MODE	(Camera)	Selects the sound heard through the headphones. LIVE: The sound which has been input from the microphone is output as is. This setting is selected when delays in the sound are annoying. RECORDING: The sound in the status which is to be recorded (the sound synchronized with the images) is output.

DISPLAY SETUP screen

Item	Display mode	Description of settings
ZEBRA DETECT1	(Camera)	Selects the brightness level of the left-leaning zebra patterns on the screen. 105%, 100%, 95%, 90%, 85%, 80%, 75%, 70%, 65%, 60%, 55%, 50%
ZEBRA DETECT2	(Camera)	Selects the brightness level of the right-leaning zebra patterns on the screen. 105%, 100%, 95%, 90%, 85%, 80%, 75%, 70%, 65%, 60%, 55%, 50%
SAFETY ZONE	(Camera)	Sets whether to display the safety zone. (Page 69) ON OFF
REC COUNTER	(Camera)	Selects counter operation during recording. TOTAL: The count continues to increase until the RESET button is pressed to reset it. CLIP: Resets the counter at start of recording and counts the time of each recording session. • In PB mode, operation is always in CLIP mode.
OUTPUT OSD	(Camera)	Select ON to output the information displayed on the screen together with the video signals. ON OFF • Time code, audio level meter, and focus bar displays are not output.
DATE/TIME	(Camera)	Sets whether to display the date and time on the screen together with the video signals. TIME: The time is displayed. DATE: The date is displayed. TIME & DATE: The date and time are displayed. OFF: The date and time are not displayed.
LEVEL METER	(Camera)	Select ON to display the audio level meter. ON OFF
ZOOM & FOCUS	(Camera)	Sets whether to display the zoom and focus values. ON OFF
CONVERGENCE	(Camera)	Sets whether to display the position of the reference plane (relative value). (Page 38) ON OFF

___ indicates the factory setting.

Setup menu list (continued)

DISPLAY SETUP screen (continued)

Item	Display mode	Description of settings
CARD & BATTERY	(Camera)	Select ON to display the remaining SD Memory Card recording capacity and remaining battery charge. ON OFF
OTHER DISPLAY	(Camera)	Select how much information to display on the viewfinder and the LCD monitor. (Page 74) ON OFF
LCD/EVF BACKLIGHT	(Camera)	Adjusts the backlight of the LCD monitor and viewfinder. Select HIGH for brighter backlight. LOW, NORMAL, HIGH

CARD FUNCTIONS screen

Item	Display mode	Description of settings
CARD FORMAT	(Camera)	Formats the SD Memory Card. YES: Formats the card. NO: Returns to the last screen. • Be sure to insert the two SD Memory Cards.
CLIP PROPERTY	(PB)	Displays information about the selected clip. YES: Displays clip information. NO: Returns to the last screen.

META DATA screen

Item	Display mode	Description of settings
CARD READ	(Camera)	Loads the metadata recorded on the SD Memory Card into the unit. YES NO • Be sure to insert the two SD Memory Cards. • "NO FILE" is displayed when no metadata is recorded in the SD Memory Card.
RECORD	(Camera)	Sets whether to record the metadata to be loaded into the unit simultaneously on an SD Memory Card. ON: Records simultaneously. OFF: Does not record simultaneously.
USER CLIP NAME	(Camera)	Selects the method of USER CLIP NAME recording. TYPE1: User clip name is the same as the CLIP NAME if there is no uploaded metadata or data. TYPE2: User clip name is the same as the CLIP NAME if no combination of data and COUNT value is uploaded, or if there is no uploaded data.
CLIP COUNT RESET	(Camera)	Resets the COUNT value to 1. YES NO
META DATA PROP	(Camera)	Displays the metadata which has been recorded in the unit. YES NO
META INITIAL SET	(Camera)	Initializes the metadata which has been recorded in the unit. All the settings including the ON or OFF setting for RECORD are now cleared. YES NO

___ indicates the factory setting.

OTHER FUNCTIONS screen

Item	Display mode	Description of settings																																																																																																												
REC LAMP	(Camera)	Sets lighting of the tally lamp. FRONT: Front tally lamp (microphone side) lights. REAR: Rear tally lamp (viewfinder side) lights. BOTH: Both tally lamps light. OFF: The tally lamp does not light.																																																																																																												
CLOCK SET	(Camera)	Sets the camera's calendar. YES NO																																																																																																												
TIME ZONE	(Camera)	Adds to or deducts from GMT the time value of -12:00 to +13:00 in 30-minute steps. (Refer to the table below.) +00:00 <table border="1" style="width: 100%; border-collapse: collapse; margin-top: 5px;"> <thead> <tr> <th style="width: 15%;">Time difference</th> <th style="width: 35%;">Area</th> <th style="width: 15%;">Time difference</th> <th style="width: 35%;">Area</th> </tr> </thead> <tbody> <tr><td>+ 00:00</td><td>Greenwich</td><td>- 00:30</td><td></td></tr> <tr><td>- 01:00</td><td>Azores Islands</td><td>- 01:30</td><td></td></tr> <tr><td>- 02:00</td><td>Mid-Atlantic</td><td>- 02:30</td><td></td></tr> <tr><td>- 03:00</td><td>Buenos Aires</td><td>- 03:30</td><td>Newfoundland Island</td></tr> <tr><td>- 04:00</td><td>Halifax</td><td>- 04:30</td><td></td></tr> <tr><td>- 05:00</td><td>New York</td><td>- 05:30</td><td></td></tr> <tr><td>- 06:00</td><td>Chicago</td><td>- 06:30</td><td></td></tr> <tr><td>- 07:00</td><td>Denver</td><td>- 07:30</td><td></td></tr> <tr><td>- 08:00</td><td>Los Angeles</td><td>- 08:30</td><td></td></tr> <tr><td>- 09:00</td><td>Alaska</td><td>- 09:30</td><td>Marquesas Islands</td></tr> <tr><td>- 10:00</td><td>Hawaii</td><td>- 10:30</td><td></td></tr> <tr><td>- 11:00</td><td>Midway Island</td><td>- 11:30</td><td></td></tr> <tr><td>- 12:00</td><td>Kwajalein</td><td>+ 12:30</td><td></td></tr> <tr><td>+ 13:00</td><td></td><td>+ 11:30</td><td>Norfolk Island</td></tr> <tr><td>+ 12:00</td><td>New Zealand</td><td>+ 10:30</td><td>Lord Howe Island</td></tr> <tr><td>+ 11:00</td><td>Solomon Islands</td><td>+ 09:30</td><td>Darwin</td></tr> <tr><td>+ 10:00</td><td>Guam</td><td>+ 08:30</td><td></td></tr> <tr><td>+ 09:00</td><td>Tokyo</td><td>+ 07:30</td><td></td></tr> <tr><td>+ 08:00</td><td>Beijing</td><td>+ 06:30</td><td>Yangon</td></tr> <tr><td>+ 07:00</td><td>Bangkok</td><td>+ 05:30</td><td>Mumbai</td></tr> <tr><td>+ 06:00</td><td>Dacca</td><td>+ 04:30</td><td>Kabul</td></tr> <tr><td>+ 05:00</td><td>Islamabad</td><td>+ 03:30</td><td>Tehran</td></tr> <tr><td>+ 04:00</td><td>Abu Dhabi</td><td>+ 02:30</td><td></td></tr> <tr><td>+ 03:00</td><td>Moscow</td><td>+ 01:30</td><td></td></tr> <tr><td>+ 02:00</td><td>Eastern Europe</td><td>+ 00:30</td><td></td></tr> <tr><td>+ 01:00</td><td>Central Europe</td><td></td><td></td></tr> </tbody> </table>	Time difference	Area	Time difference	Area	+ 00:00	Greenwich	- 00:30		- 01:00	Azores Islands	- 01:30		- 02:00	Mid-Atlantic	- 02:30		- 03:00	Buenos Aires	- 03:30	Newfoundland Island	- 04:00	Halifax	- 04:30		- 05:00	New York	- 05:30		- 06:00	Chicago	- 06:30		- 07:00	Denver	- 07:30		- 08:00	Los Angeles	- 08:30		- 09:00	Alaska	- 09:30	Marquesas Islands	- 10:00	Hawaii	- 10:30		- 11:00	Midway Island	- 11:30		- 12:00	Kwajalein	+ 12:30		+ 13:00		+ 11:30	Norfolk Island	+ 12:00	New Zealand	+ 10:30	Lord Howe Island	+ 11:00	Solomon Islands	+ 09:30	Darwin	+ 10:00	Guam	+ 08:30		+ 09:00	Tokyo	+ 07:30		+ 08:00	Beijing	+ 06:30	Yangon	+ 07:00	Bangkok	+ 05:30	Mumbai	+ 06:00	Dacca	+ 04:30	Kabul	+ 05:00	Islamabad	+ 03:30	Tehran	+ 04:00	Abu Dhabi	+ 02:30		+ 03:00	Moscow	+ 01:30		+ 02:00	Eastern Europe	+ 00:30		+ 01:00	Central Europe		
Time difference	Area	Time difference	Area																																																																																																											
+ 00:00	Greenwich	- 00:30																																																																																																												
- 01:00	Azores Islands	- 01:30																																																																																																												
- 02:00	Mid-Atlantic	- 02:30																																																																																																												
- 03:00	Buenos Aires	- 03:30	Newfoundland Island																																																																																																											
- 04:00	Halifax	- 04:30																																																																																																												
- 05:00	New York	- 05:30																																																																																																												
- 06:00	Chicago	- 06:30																																																																																																												
- 07:00	Denver	- 07:30																																																																																																												
- 08:00	Los Angeles	- 08:30																																																																																																												
- 09:00	Alaska	- 09:30	Marquesas Islands																																																																																																											
- 10:00	Hawaii	- 10:30																																																																																																												
- 11:00	Midway Island	- 11:30																																																																																																												
- 12:00	Kwajalein	+ 12:30																																																																																																												
+ 13:00		+ 11:30	Norfolk Island																																																																																																											
+ 12:00	New Zealand	+ 10:30	Lord Howe Island																																																																																																											
+ 11:00	Solomon Islands	+ 09:30	Darwin																																																																																																											
+ 10:00	Guam	+ 08:30																																																																																																												
+ 09:00	Tokyo	+ 07:30																																																																																																												
+ 08:00	Beijing	+ 06:30	Yangon																																																																																																											
+ 07:00	Bangkok	+ 05:30	Mumbai																																																																																																											
+ 06:00	Dacca	+ 04:30	Kabul																																																																																																											
+ 05:00	Islamabad	+ 03:30	Tehran																																																																																																											
+ 04:00	Abu Dhabi	+ 02:30																																																																																																												
+ 03:00	Moscow	+ 01:30																																																																																																												
+ 02:00	Eastern Europe	+ 00:30																																																																																																												
+ 01:00	Central Europe																																																																																																													
SYSTEM FREQ	(Camera)	This is used to switch the system frequency. 59.9Hz: NTSC mode (59.94 Hz) 50Hz: PAL mode <ul style="list-style-type: none"> • When the system frequency has been changed, turn the unit's power off and then back on so that the setting takes effect. 																																																																																																												
SYSTEM INFO	(Camera)	Displays the version of the system in this camera. YES NO																																																																																																												
MENU INIT	(Camera)	Returns the menu settings to the factory settings. YES NO <ul style="list-style-type: none"> • TIME ZONE setting will not return to the factory setting. 																																																																																																												
OPERATION	(Camera)	Displays the power-on time of the unit (a 5-digit figure).																																																																																																												
UPDATE	(Camera)	Updates the system version of this unit. YES: Enables updating. NO: Updating is not performed. <ul style="list-style-type: none"> • For detailed information on updating, visit the following website: http://pro-av.panasonic.net/ 																																																																																																												

_____ indicates the factory setting.

Setup menu list (continued)

OTHER FUNCTIONS screen (continued)

Item	Display mode	Description of settings
LOG DATA	(Camera)	Stores the product information of this unit in the SD Memory Card. YES NO

PLAY SETUP screen

Item	Display mode	Description of settings
RESUME PLAY	(PB)	ON OFF When set to ON, playback resumes from the video position at which clip playback stopped.

THUMBNAIL SETUP screen

Item	Display mode	Description of settings
THUMBNAIL MODE	(PB)	Selects the thumbnail display method. ALL: All the clips are displayed. SAME FORMAT: The clips in the same recording format are displayed. MARKER: The clips with shot marks are displayed.
INDICATOR	(PB)	Sets whether the indicator is to be displayed or not. ON: Displayed OFF: Not displayed
DATA DISPLAY	(PB)	Selects the information displayed in the time display of clips. TC: Time code UB: User information TIME: Shooting time DATE: Shooting date DATE & TIME: Shooting date and time
DATE FORMAT	(PB)	Selects the order for displaying the recording date/time when DATE DISPLAY is set to DATE. Y-M-D: year/month/day M-D-Y: month/day/year D-M-Y: day/month/year

OPERATION screen

Item	Display mode	Description of settings
DELETE	(PB)	Deletes clips. ALL CLIPS: Deletes all clips. SELECT: Deletes only the selected clips. Press the EXEC button to delete clips. NO: Returns to the last screen. • Clips for which CLIP PROTECT is specified are not deleted.
CLIP PROTECT	(PB)	Protects clips to prevent accidental deletion. YES: Enables clip protection or cancels protection. NO: Returns to the last screen. • Executing a format of the memory card will delete all clips even if they are protected. (Page 30)

___ indicates the factory setting.

Before calling for service

Power supply

There's no power.	<ul style="list-style-type: none"> • Make sure the battery and AC adaptor are connected properly. Check the connections again. 	Page 24
Power goes off as soon as it is turned on.	<ul style="list-style-type: none"> • The battery may have run out. If the remaining battery charge display  turns red, the battery is exhausted. Either recharge the battery or replace the discharged battery with a fully charged one. 	Page 23

Battery

The battery runs down quickly.	<ul style="list-style-type: none"> • Make sure the battery is fully charged. Keep charging until the CHARGE lamp on the battery charger goes out. • Are you using the battery in a cold place? The battery is affected by the ambient temperature. Its operating time is reduced in low-temperatures. • The battery may have reached the end of its service life. The battery will become unchargeable. The battery has a certain service life which varies depending on how the battery is used. If the battery operates only for a short period even when it is charged adequately, it has reached the end of its service life. 	Page 23
The remaining battery capacity is not displayed correctly.	<ul style="list-style-type: none"> • The remaining battery capacity display is merely a guideline. To ensure that remaining battery capacity is displayed correctly, use the battery completely from a fully-charged state, and charge the battery again. (Remaining battery capacity may still not be displayed correctly if the battery has been used for long periods in high or low temperatures, or if the battery has been recharged a large number of times.) 	—

Shooting/recording

Cannot start shooting.	<ul style="list-style-type: none"> • Make sure the POWER/Mode selector switch is ON. 	Page 25
Cannot record even through the SD Memory Cards are inserted correctly.	<ul style="list-style-type: none"> • Is the write-protect switch on the SD Memory Cards in the "LOCK" position? The card cannot be recorded to if the switch is in the "LOCK" position. • Is the remaining memory available on the SD Memory Cards extremely low? Please save contents onto different media and delete unneeded data from the cards, or use new cards instead. • Have the SD Memory Cards been correctly formatted? Alternatively, are the cards of a format that is incompatible with this camera? Reformat the cards with the camera. • 8 MB - 16 MB SD Memory Cards cannot be used. 	Page 33 Page 30 Page 17
Recording stops by itself.	<ul style="list-style-type: none"> • Is your SD Memory Card compatible with use for video recording? Always use SD Memory Cards compatible with use for video recording. 	Page 17
There is a vertical misalignment between the left and right images.	<ul style="list-style-type: none"> • Adjust the images using the 3D FINE function, to minimize misalignment. If the misalignment cannot be reduced to the specified value even if adjusted with the 3D FINE function, consult your dealer. 	Page 45
There is focus misalignment between the left and right images.	<ul style="list-style-type: none"> • The focus may have been misaligned by shock applied to the camera. Turn the power off then on again. If the focus misalignment persists, consult your dealer. 	—

(Continued on the next page)

Before calling for service (continued)

Playback

<p>Cannot play even when I press the play button.</p>	<ul style="list-style-type: none"> • Is the PB lamp on? If the CAMERA lamp is on, press the POWER/Mode selector switch so that the PB lamp turns on. • Is the recording format correct? Change to a recording format for proper playback. • Are the SD Memory Cards inserted in reverse left-right order? Insert the left and right SD Memory Cards correctly. 	<p>Page 57 Page 80 Page 30</p>
<p>Mosaic-like noise appears when I cue or review a clip.</p>	<ul style="list-style-type: none"> • This noise is inherent to digital video technology. This is normal. 	<p>—</p>
<p>A black screen appears during clip changeover.</p>	<ul style="list-style-type: none"> • When playing back multiple clips in succession, a black screen appears at the changeover between clips. This is normal. 	<p>—</p>
<p>Images do not appear on the television even though I have connected the camera-recorder properly.</p>	<ul style="list-style-type: none"> • Make sure the input selector on your television is set to video input. Read the television's instructions carefully and select the correct video input connector for the camera-recorder. • Is the 3D setting correct on your television? Read the television's instructions carefully and select the correct setting. • Is the setting for the output terminal correct? Set it correctly on the AV OUT SETUP screen. 	<p>— — Page 81</p>
<p>Cannot hear any sound from the camera-recorder's speaker.</p>	<ul style="list-style-type: none"> • You may have turned down the camera-recorder's volume control too far. Adjust the volume level using the AUDIO MON/ADV button +. 	<p>Page 65</p>

Other

<p>There is a rattling sound when the camera-recorder is tilted back and forth.</p>	<ul style="list-style-type: none"> • This is the sound of the lens moving. This is not a fault. No sound should be heard when the camera's power is switched on. 	<p>—</p>
<p>A clicking sound is heard when the power is turned on.</p>	<ul style="list-style-type: none"> • This initialization operation is performed when the camera starts up. It occurs due to the construction of the camera and is not indicative of any trouble. 	<p>—</p>
<p>The SD Memory Card screen appears strange.</p>	<ul style="list-style-type: none"> • The data on the card could be corrupted. Data can be corrupted by static electricity and electromagnetic waves. Please always save important data to a computer or other storage media. 	<p>—</p>
<p>The SD Memory Card cannot be used even after formatting.</p>	<ul style="list-style-type: none"> • There could be a fault with the camera or with the SD Memory Card. Please consult the place of purchase. Always use only SD Memory Cards of 512 MB - 32 GB with this camera. 	<p>—</p>
<p>The camera does not recognize the SD Memory Card even though it is inserted correctly.</p>	<ul style="list-style-type: none"> • Was the inserted SD Memory Card originally formatted with a computer? Always use this camera to format SD Memory Cards. Please be aware that, when an SD Memory Card is formatted, all data recorded on the card will be erased and will not be restorable. 	<p>Page 30</p>
<p>The SD Memory Card is not recognized when inserted into other devices.</p>	<ul style="list-style-type: none"> • Please check that the device is compatible with the capacity or type (SD Memory Card/SDHC Memory Card) of the SD Memory Card that you are using. For details, please consult the device's own operating instructions. 	<p>Page 17</p>

Updating the firmware in the camera

Check firmware version of the unit with the SYSTEM INFO item on the setup menu OTHER FUNCTIONS screen. Then access the site listed below to check the most recent firmware information and download any firmware you require.

Download the update file to the unit by placing it on SD Memory Cards. For detailed information on the update procedure, visit the below site.

For English: <http://pro-av.panasonic.net/>

- For updating, use only SD Memory Cards that comply with the SD or SDHC specifications.
- Be sure to insert two SD Memory Cards.
- Be sure to format SD Memory Cards on this unit.

Cleaning

Cleaning the Viewfinder

If there is dust inside the viewfinder, remove the eye cup holder and get rid of the dust.

- The interior of the eye cup holder is specially finished, so do not ever wipe it. If there is dust on it, blow it off with an air blower.
- Remove the eye cup holder with the eye cup attached by rotating it counterclockwise. (It will be tightly screwed on.) When you do this, tilt the viewfinder slightly upward.
- To mount the eye cup holder, align the ridges and grooves of the eye cup holder and camera-recorder, and turn clockwise until the holder clicks into place.

When cleaning, do not use benzene or thinner.

- Using benzene or paint thinners may deform the camera-recorder and/or cause the surface finish to peel off.
- Before proceeding with maintenance, remove the battery or disconnect the AC power cable from the power outlet.
- Use a soft, clean cloth to wipe the camera-recorder. To remove stubborn dirt, wipe the camera-recorder with a cloth moistened with kitchen detergent that has been diluted with water and then use a dry cloth to take up the remaining moisture.

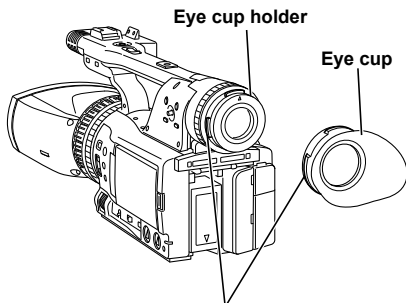

Align the ridges with the grooves.

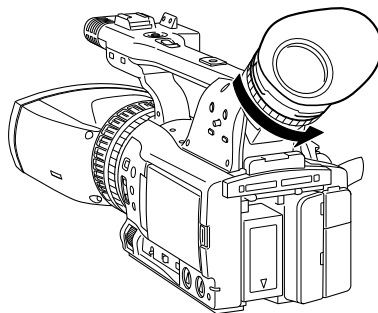

Storage Precautions

Before storing the camera-recorder, remove the SD Memory Cards and battery.

Store all of these items in a place with low humidity and relatively constant temperature.

[Recommended temperature range: 15 °C to 25 °C (59 °F to 77 °F)]

[Recommended relative humidity: 40 % to 60 %]

Camera-recorder

- Wrap the camera-recorder in a soft cloth to keep the dust off.

Battery

- The battery life is shortened in places with extreme temperatures.
- Storing the battery in a location with oily vapors or high dust concentrations may corrode the terminals or cause other damage, leading to malfunction.
- **Keep metal objects (such as necklaces and hairpins) away from the terminals. Short-circuiting may occur across the terminals, causing the battery to heat up, and you may seriously burn yourself if you touch the battery in this state.**

SD Memory Cards

- After ejecting an SD Memory Card from the unit, be absolutely sure to stow it in its own case.
- Do not leave SD Memory Cards in areas where corrosive gases, etc. are present.
- Do not leave the cards inside vehicles, in places exposed to direct sunlight or in other places where the temperature is high.
- Do not leave the cards where the humidity level is high or where there are high concentrations of dust.

Recording format

When SYSTEM FREQ is set to 59.9 Hz

Recording mode		Frame rate		
		60	30P	24P
PH	1080/60i	1080/60i	1080/30P (over 60i)	1080/24P (Native recording)
	720/60P	720/60P		

When SYSTEM FREQ is set to 50 Hz

Recording mode		Frame rate	
		50	25P
PH	1080/50i	1080/50i	1080/25P (over 50i)
	720/50P	720/50P	

- This product allows PH recording mode only.

How to handle data recorded on SD Memory Card

Data recorded in AVCHD format offers excellent compatibility with computers due to the file type, but since this format includes not only video and audio data, but also a variety of important information, the folder structure will consist of file associations as illustrated in the diagram on the right. If even part of this information is modified or deleted, the data may no longer be recognized as AVCHD data, or the memory card may not longer be able to be used with AVCHD devices.

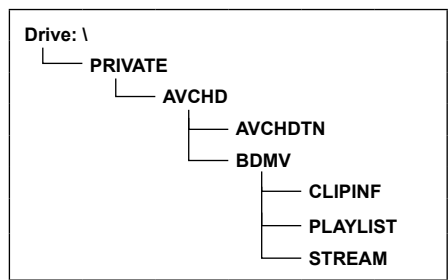

■ Concerning the handling of the camera's metadata

A special manufacturer area in the control file area under the AVCHD standard is employed for the metadata which is supported by this camera.

If files are deleted or copied, if clip protection is added or removed or if other such editing operations have been performed using editing software or a camera recorder which does not support this camera's metadata, the special area for the metadata will be erased, and the shot marks added by the camera as well as the PH mode information and other information will be lost. Therefore, before proceeding with these kinds of editing operations, check whether the camera's metadata is supported.

Specifications

[General]

Supply voltage:

DC 7.2 V (when the battery is used)

DC 7.9 V (when the AC adaptor is used)

Power consumption: 17 W (recording)

 indicates safety information.

Ambient operating temperature

0 °C to 40 °C (32 °F to 104 °F)

Ambient operating humidity

10 % to 80 % (no condensation)

Weight

Camera-recorder:

Approx. 2.4 kg (5.3 lb) (excluding battery)

Approx. 2.7 kg (6.0 lb) (with battery attached)

Dimensions (W × H × D)

158 mm × 187 mm × 474 mm (6-1/4 inches × 7-3/8 inches × 18-11/16 inches)

(excluding the projecting part)

[Camera]

Pickup devices

1/4.1-type MOS solid-state image sensing device ×3 ×2

Picture elements

Effective picture elements: Approx. 2,070,000 pixels ×3 (16:9) ×2

Lens

Motorized 5.6 x zoom,

F1.8 (WIDE) to F2.4 (TELE) (f=4.2 mm to 23.5 mm)

(35 mm equivalent: 47.1 mm to 264 mm), 16:9

Color separation optical system

Prism system

Distance between the optical axes

Approx. 60 mm (2-3/8 inches)

Minimum shooting distance

Approx. 1.2 m (47-1/4 inches) (all zoom range)

Reference plane adjustment range

Approx. 2.2 m (86-5/8 inches) to ∞

Gain settings

0 to +24 dB (variable in 1 dB steps)

Color temperature settings

3200 K/5600 K preset, Ach, Bch

Shutter speed settings

- When SYSTEM FREQ is set to 59.9 Hz

Preset

60i/60P mode: 1/60, 1/100, 1/120, 1/250 seconds

30P mode: 1/30, 1/50, 1/60, 1/120, 1/250 seconds

24P mode: 1/24, 1/50, 1/60, 1/120, 1/250 seconds

Synchro scan

60i/60P mode: 1/60.0 to 1/250.0 seconds

30P mode: 1/30.0 to 1/250.0 seconds

24P mode: 1/24.0 to 1/250.0 seconds

- When SYSTEM FREQ is set to 50 Hz

Preset

50i/50P mode: 1/50, 1/60, 1/120, 1/250 seconds

25P mode: 1/25, 1/50, 1/60, 1/120, 1/250 seconds

Synchro scan

50i/50P mode: 1/50.0 to 1/250.0 seconds

25P mode: 1/25.0 to 1/250.0 seconds

[Video recording/playback]

Recording specification

AVCHD specifications

Compression method

MPEG-4 AVC/H.264

Recording media

- Use an SD/SDHC Memory Card of class 4 or above when recording.

SD Memory Card:

512 MB, 1 GB, 2 GB (FAT12 and FAT16 formats)

SDHC Memory Card:

4 GB, 6 GB, 8 GB, 12 GB, 16 GB, 32 GB (FAT32 format)

Recording format

- When SYSTEM FREQ is set to 59.9 Hz

PH 1080/59.94i

PH 1080/29.97P (over 59.94i)

PH 1080/23.98P (native recording)

PH 720/59.94P

- When SYSTEM FREQ is set to 50 Hz

PH 1080/50i

PH 1080/25P

PH 720/50P

Transmission rate

PH mode: Approx. 21 Mbps (VBR)

Recording time (rough indication)

When a Panasonic SDHC Memory Card is used

Capacity	Recording time (Recording mode: PH, 1920×1080 or 1280×720 pixels)
4 GB	Approx. 21 min.
8 GB	Approx. 45 min.
16 GB	Approx. 90 min.
32 GB	Approx. 180 min.

SD Memory Card slot

2 slots (left/right)

Maximum number of clips to be recorded continuously in an SD Memory Card

200 clips (when formatting and recording continues without removing the card)

Maximum number of clips to be played back in an SD Memory Card

200 clips (up to 200 clips can be displayed)

Thumbnail display

8 thumbnails/page

Editing functions

Delete, protect

Formatting

Available

[Video System]

Video output

HDMI output: HDMI×1 (HDMI Type A connector), 3D compatible (Not compatible with VIERA Link)

- **When SYSTEM FREQ is set to 59.9 Hz**
1080/59.94i Frame Packing, 1080/23.98p Frame Packing, 720/59.94p Frame Packing 1080/59.94i, 720/59.94p, 480/59.94p
- **When SYSTEM FREQ is set to 50 Hz**
1080/50i Frame Packing, 720/50 Frame Packing, 1080/50i, 720/50p, 576/50p

HD SDI 1(L) output: BNC×1, 0.8 V [p-p], 75 Ω

HD SDI 2(R) output: BNC×1, 0.8 V [p-p], 75 Ω

- **When SYSTEM FREQ is set to 59.9 Hz**
1080/59.94i, 1080/23.98PsF, 720/59.94p
- **When SYSTEM FREQ is set to 50 Hz**
1080/50i, 720/50p

[Audio System]

Compression method

Recording/playback: Dolby Digital/2 ch

Sampling frequency

48 kHz

Quantization

16 bit

Compressed bit-rate

PH mode: 384 kbps

[Audio Input/Output]

Internal microphone

Stereo microphone

XLR input

XLR (3 pins) × 2 (INPUT1, INPUT2)

High impedance

LINE: 0 dBu

MIC: -50/-60 dBu (selectable in menu)

HDMI output

2 ch (linear PCM)

Headphone output

Stereo mini jack (3.5 mm diameter)×1

Internal speaker

20 mm (round)×1

[Other inputs/outputs]

Camera remote

Super mini jack (2.5 mm diameter)×1 (ZOOM S/S)

Mini jack (3.5 mm diameter)×1 (FOCUS, IRIS)

Super mini jack (2.5 mm diameter)×1 (CONV.)

[Monitor]

LCD monitor

3.2-type (16:9) LCD color monitor (approx. 921,000 pixels)

Viewfinder

0.45-type (16:9) LCD color viewfinder (approx. 1,226,000 pixels)

[AC adaptor]

Power Source:	100 V - 240 V AC, 47 Hz - 63 Hz 0.55A
Power Output:	7.9 V DC, 2.53 A

 indicates safety information.

Weight

Approx. 220 g (0.49 lb)

Dimensions (W x H x D)

42 mm × 31 mm × 104.4 mm (1-5/8 inches × 1-1/4 inches × 4-1/8 inches)

[Battery charger]

Power Source:	100 V - 240 V AC, 50/60 Hz 0.4 A
Power Output:	8.4 V DC, 1.2 A

 indicates safety information.

Weight

Approx. 160 g (0.35 lb)

Dimensions (W x H x D)

70 mm × 35 mm × 115 mm (2-3/4 inches × 1-3/8 inches × 4-1/2 inches)
(excluding the projecting part)

Inrush current, measured according to European standard EN55103-1: 6.5 A

Weight and dimensions are approximate. Specifications are subject to change without notice.

Index

Numerics

3D FINE function	45
3D guide display	69
3D guide function.....	38
3D image	11, 38

A

AC adaptor	24
Audio equipment.....	48
AVCCAM Restorer.....	33
AVCHD	18
AVCHD-compatible equipment.....	18

B

Battery	24
Black balance	41

C

Calendar	28
CAMERA mode	31
CARD FUNCTIONS	63

Charging

Battery	23
Built-in battery.....	54

Clip

Deleting.....	62
Information	63
Metadata	50
Playback	58
Protecting.....	62

Color bar	43
-----------------	----

Convergence display	38, 69
---------------------------	--------

Convergence point	11
-------------------------	----

Adjustment.....	38
What is.....	39

Counter.....	53
--------------	----

D

Date and time	65
---------------------	----

DIAL (IRIS/CONV.) selector switch.....	37, 38
--	--------

E

EXEC button.....	45
------------------	----

Eye cup.....	26
--------------	----

F

Fine adjustment between the two lenses	45
--	----

Firmware.....	87
---------------	----

FOCUS.....	45
------------	----

Focus

Auto focus.....	36
-----------------	----

Focus assist.....	36
-------------------	----

Infinity	36
----------------	----

Manual focusing.....	36
----------------------	----

Focus bar display	69
-------------------------	----

G

Gain	37
------------	----

H

Headphones	66
------------------	----

I

IRIS.....	45
-----------	----

Iris.....	37
-----------	----

IRIS/CONV. dial.....	37, 38
----------------------	--------

L

LCD monitor	27
-------------------	----

M

Menu

Initializing	76
--------------------	----

List	78
------------	----

Structure	77
-----------------	----

Using.....	75
------------	----

Metadata

Contents	50
----------------	----

Uploading.....	51
----------------	----

Microphone

Built-in microphone.....	48
--------------------------	----

External microphone.....	48, 66
--------------------------	--------

Phantom microphone.....	49
-------------------------	----

MIX image	38
-----------------	----

Monitor.....	65, 67
--------------	--------

O

OPERATION.....	62
----------------	----

P

Parallactic angle	39
-------------------------	----

Parallax.....	39
---------------	----

PB mode.....	57
--------------	----

Progressive mode.....	35
-----------------------	----

R		W	
REC CHECK	31	Warning display	71
Recording format	90	Wave form	44
Recording level	49	White balance	
Remaining battery capacity display	70	Adjustment	40
RESUME PLAY	60	Preset	40
Resume playback	60		
S		Z	
Safety zone	69	Zebra pattern	42
Screen mode display	70	Zoom	34
SD Memory Card			
Access lamp	32		
Card type	17		
Formatting	30		
Inserting	30		
Protecting	33		
Recorded data	91		
Recording time	32		
Removing	33		
Repairing	33		
Shooting	31		
Shot mark	44, 59		
Shutter speed	46		
Specifications	92		
Synchro scan	47		
T			
Tally lamp	25		
Thumbnail			
Display method	61		
Thumbnail screen	58		
THUMBNAIL SETUP	61		
Time code	54		
Time code display	68		
TV	65, 67		
U			
User information	56		
V			
VERTICAL	45		
Vertical misalignment	45		
Viewfinder	26		
Volume			
Adjusting while shooting	44		
Playback volume	65		

Information for Users on Collection and Disposal of Old Equipment and used Batteries



These symbols on the products, packaging, and/or accompanying documents mean that used electrical and electronic products and batteries should not be mixed with general household waste.

For proper treatment, recovery and recycling of old products and used batteries, please take them to applicable collection points, in accordance with your national legislation and the Directives 2002/96/EC and 2006/66/EC.

By disposing of these products and batteries correctly, you will help to save valuable resources and prevent any potential negative effects on human health and the environment which could otherwise arise from inappropriate waste handling.



For more information about collection and recycling of old products and batteries, please contact your local municipality, your waste disposal service or the point of sale where you purchased the items.

Penalties may be applicable for incorrect disposal of this waste, in accordance with national legislation.



For business users in the European Union

If you wish to discard electrical and electronic equipment, please contact your dealer or supplier for further information.

Cd

Information on Disposal in other Countries outside the European Union

These symbols are only valid in the European Union. If you wish to discard these items, please contact your local authorities or dealer and ask for the correct method of disposal.

Note for the battery symbol (bottom two symbol examples):

This symbol might be used in combination with a chemical symbol. In this case it complies with the requirement set by the Directive for the chemical involved.

Panasonic Corporation

Web Site: <http://panasonic.net>

Panasonic Solutions Company

3 Panasonic Way, Secaucus, NJ 07094 Tel: 877-803-8492
www.panasonic.com/broadcast e-mail: MediaProServices.PSC@us.panasonic.com

Panasonic Canada Inc.

5770 Ambler Drive, Mississauga, Ontario L4W 2T3 Tel: 905-624-5010

Panasonic de México S.A. De C.V.

Casa Matriz: Moras No.313 Col. Tlacoquemecatl Del Valle Del.Benito Juárez México, D.F., C.P.03200
Tel: 55-5488-1000 Fax: 55-5575-6783

Panasonic Latin America, S.A.

P.O.Box 0816-03164 Panama, Republic of Panama Tel: +507-229-2955 Fax: 507-229-5352

Panasonic do Brasil Ltda.

Rua Cubatão, 320-6º andar-Paraiso CEP 04013-001- São Paulo -SP Tel: 11-3889-4000 Fax: 11-3889-4004

Free Manuals Download Website

<http://myh66.com>

<http://usermanuals.us>

<http://www.somanuals.com>

<http://www.4manuals.cc>

<http://www.manual-lib.com>

<http://www.404manual.com>

<http://www.luxmanual.com>

<http://aubethermostatmanual.com>

Golf course search by state

<http://golfingnear.com>

Email search by domain

<http://emailbydomain.com>

Auto manuals search

<http://auto.somanuals.com>

TV manuals search

<http://tv.somanuals.com>