

MICRO-IMAGECHECKER® A210-A110 MultiChecker V2 Series

System configuration diagram

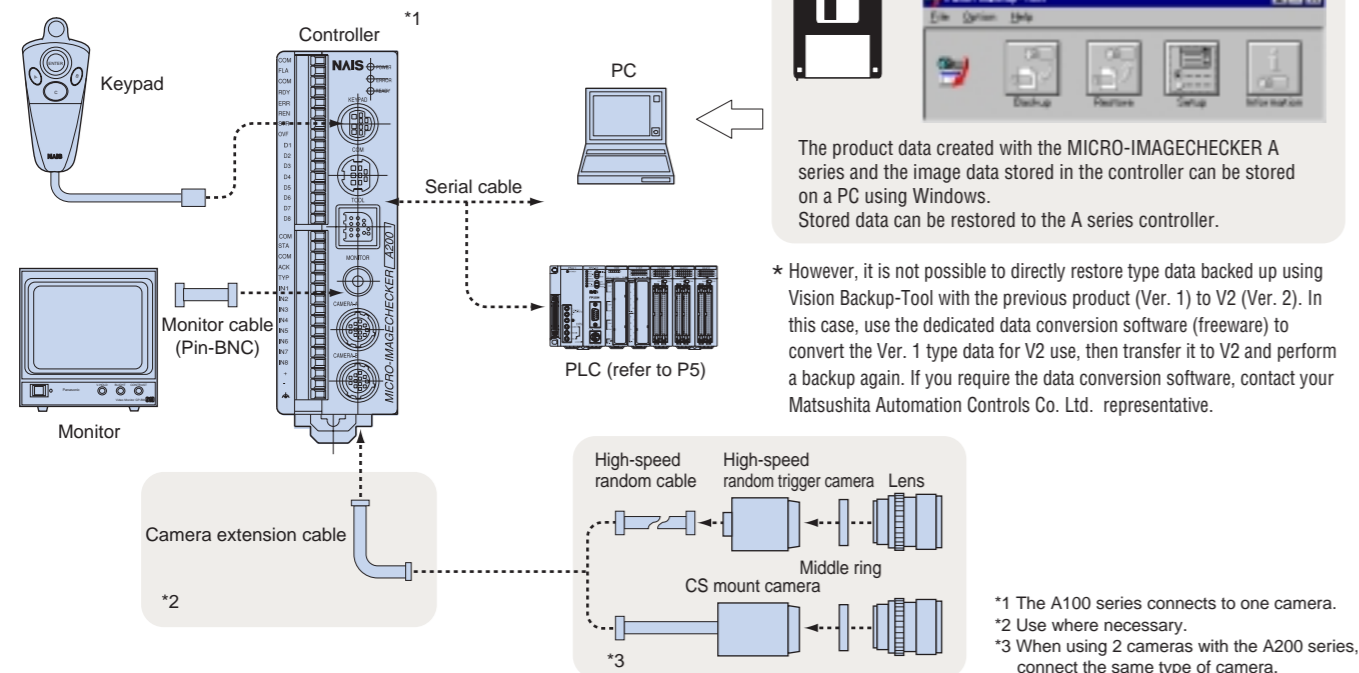

Table of Product Numbers

● MICRO-IMAGECHECKER A-Series Controller

Item	Specifications	Part No.
MICRO-IMAGECHECKER A200 Series	A210 Multi-Checker V2 : CE	NPN Output ANMA212V2 PhotoMos Output ANMA218V2
	A210 Multi-Checker : CE	NPN Output ANMA212
MICRO-IMAGECHECKER A100 Series	A110 Multi-Checker V2 : CE	NPN Output ANMA112V2 PhotoMos Output ANMA118V2
	A110 Multi-Checker : CE	NPN Output ANMA112

● Camera / Keypad / Monitor

Item	Specifications	Part No.
C mount camera	Progressive Double-speed Random: CE	ANM831
CS mount camera	support electric-shutter with 3 m cable	ANM832
	support electric-shutter with 3 m cable: CE	ANM832CE
Keypad	with 2 m cable	ANM85202
	with 3 m cable	ANM85203
	with 2 m cable: CE	ANM85202CE
	with 3 m cable: CE	ANM85203CE
Monitor	Panasonic GPBM910 (100 V AC/12 V DC)	AUGPBM910

● Camera cable

Item	Specifications	Part No.
Double-speed random camera cable	3 m	ANM84303
	3 m: CE	ANM84303CE
Camera extension cable	2 m extension: total 5 m	ANM84002
	7 m extension : total 10 m	ANM84007
	12 m extension: total 15 m	ANM84012
	17 m extension: total 20 m	ANM84017
	2 m extension : total 5 m: CE	ANM84002CE
	7 m extension: total 10 m: CE	ANM84007CE
	12 m extension: total 15 m: CE	ANM84012CE
	17 m extension: total 20 m: CE	ANM84017CE

● Serial Cable

Item	Specifications	Part No.
COM port connecting cable	COM port and PC (D-SUB : 9 pin) connection, 3 m	ANM81103
	COM port and PLC (discrete-wire cable) connection, 3 m	ANM81303
TOOL port connecting cable	COM port and PC (D-SUB : 9 pin) connection, 10 cm	ANM812001

● Lens / middle ring

Item	Specifications	Part No.
CS mount lens	f2.8 CS mount compact lens	ANM8828
	f2.8 CS mount compact lens with lock	ANM88281
	f4 CS mount compact lens	ANM8804
	f4 CS mount compact lens with lock	ANM88041
	f8 CS mount compact lens	ANM8808
	f8 CS mount compact lens with lock	ANM88081
C mount lens	f6.5 C mount lens	ANB842
	f8.5 C mount lens	ANB843
	f8.5 C mount lens with lock	ANB843L
	f16 C mount compact lens	ANB845N
	f16 C mount compact lens with lock	ANB845NL
	f25 C mount compact lens	ANB846N
	f25 C mount compact lens with lock	ANB846NL
	f50 C mount lens	ANB847
	f50 C mount lens with lock	ANB847L
	f50 C mount compact lens	ANM8850
f50 C mount compact lens with lock	ANM88501	
Middle ring	5 mm middle ring	ANB84805
	(0.5/1/5/10/20/40 mm) middle ring	ANB848

● Data backup software

Item	Specifications	Part No.
Vision Backup-Tool Ver.2	English version	ANM70131V2

Microsoft windows NT4.0/95/98/Me/2000 compatible. An operating system is not included with this software.

● Accessories

Item	Specifications	Part No.
I/O terminal block	For input: 1 piece, for output, 1 piece	ANMA8001
BNC connector	Monitor BNC jack to PIN jack adapter	ANM8606

Unless otherwise specified, estimate and delivery prices do not include technician dispatching and other related services. Therefore, for the situations given below, additional charges may be added.

- Installation and trial operation guidance
- Inspections, adjustments, and repairs
- Technical support and instruction

To USA Customer

- Products sold by seller are covered by the warranty and patent indemnification provisions in its Terms and Conditions of Sale only.

These materials are printed on ECF pulp.
These materials are printed with earth-friendly vegetable-based (soybean oil) ink.



Panasonic

ideas for life

Image Processing Device
MICRO-IMAGECHECKER®

A210·A110

MultiChecker Ver.2 Series



It won't stop advancing. The monstrously small A Series!

The MultiChecker V2 Series - more powerful than ever!

Our highly acclaimed, compact A210 and A110 MultiChecker image processing units are now even more powerful! The V2 (Ver. 2) upgrade includes new functions for even greater convenience. To meet your diverse range of inspection requirements, we have increased the number of checkers by a factor of three. In addition to making more inspection locations possible, they now come equipped with a new mode that allows two-level branch inspection using one image checker, and an extensive range of functions that allow use in a wide range of applications.

Three times the processing capacity of their predecessors!
Designed to meet a diverse variety of inspection needs!

You can now register **three times** more checkers per type!

- A210 MultiChecker: increased from 32 to **96**
- A110 MultiChecker: increased from 16 to **48**

Possible to choose from **three execution modes** to suit your inspection requirements!



MICRO-IMAGECHECKER A210 and A110 MultiChecker V2 (Photo shows A210)

Automatic Switch Mode

Branch inspection without complicated settings provides great convenience!

Example

It is possible to first make a direction judgment, and then perform a separate inspection (character appearance or mark width measurement) based on this direction.

Conventional method

- Execute all checkers and output results
 - Perform direction judgment externally and compare results
- Execution time: 65msec.**

Automatic Switch Mode

- Perform direction judgment and execute the required checker
- Execution time: 35msec!** *Execution time reduced by half!*

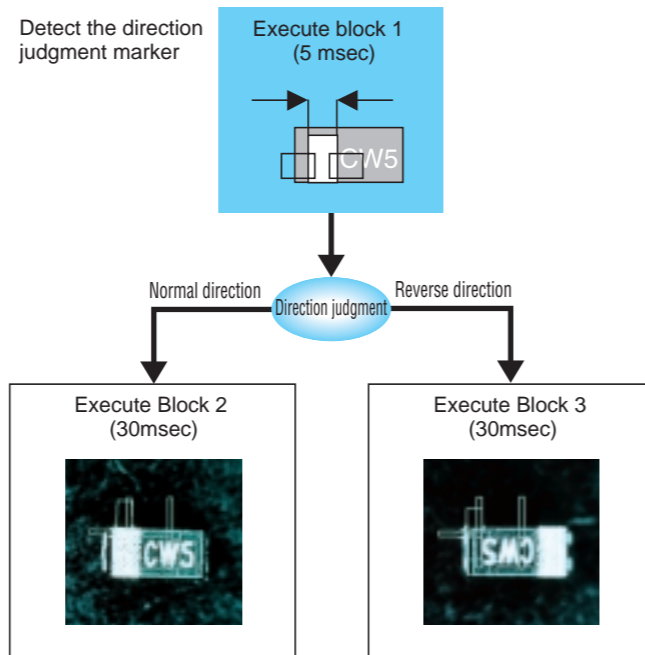

New



User-Defined Mode

Multiple inspections of up to three blocks with no switching time!

Example

When you wish to perform multiple continuous inspections because the work will not fit in the field of view of a single image capture.

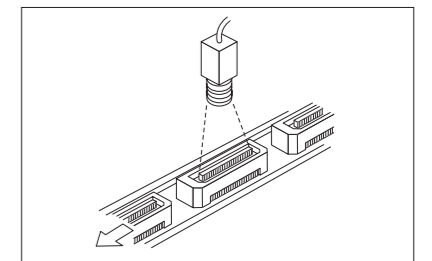

Conventional method

- Handled by type switching using an external device.
- Type switching requires time and usage restrictions apply.

Type switching not required!

Type 1 Type 2 ... Type 64

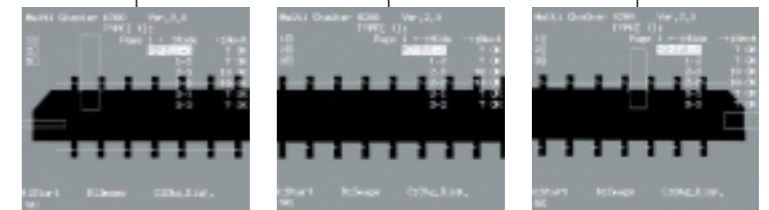

First field of vision (Block 1) → Second field of vision (Block 2) → Third field of vision (Block 3)

User-Defined Mode

- Internally switches to the process block via an external signal.
 - External device is not used, so inspection time is greatly reduced!
- * Can be executed from the keypad as well.

Execute All Mode

Three times the number of checkers can now be registered per type, so you can inspect many points at one time!

Example

Multiple simultaneous point inspection possible for applications such as inspecting LED lighting.

Plenty of external outputs for judgment results (96 points for the A210 and 48 points for the A110) allow simultaneous output of judgment results for multiple inspection points.

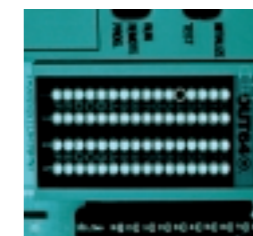

As always, the A Series is packed with easy-to-use features.

In addition to the ease-of-use and reliability that you expect from the No. 1 manufacturer in the field, we also provide convenient new functions for a diverse range of solutions.



Convenient new display function

Data Monitor Function

Titles and results of numerical calculations and judgment outputs can be displayed on the inspection screen. You can register your own text for display, and change the maximum and minimum limits for numerical calculations directly from the menu.

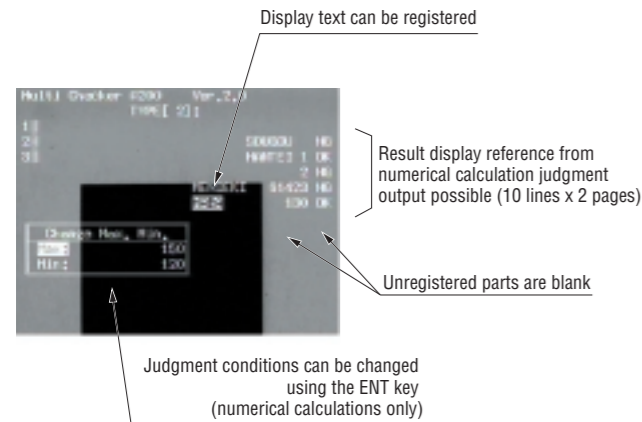

Marker Function

Up to eight graphics (circles, ellipses, rectangles and lines) can be displayed on the inspection screen. This is very convenient when performing manual positioning for camera adjustment with production equipment.



Two-image switch/split function (A210 only)

When using two cameras simultaneously for an operation such as measuring the distance between two points, you can use an external signal to switch the display. It is also possible to split images captured by two cameras for display as one image on the screen. You can select either vertical or horizontal for the image split direction.

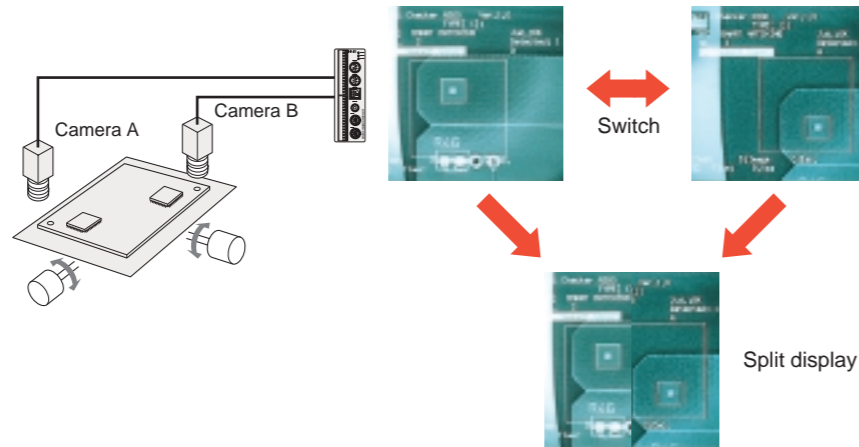

Extensive array of image capture functions

Double-speed random camera (progressive rectangular-lattice CCD element)

With the A series, we introduced a progressive double-speed random camera that provides 3 times the maximum ratio of conventional units with 1/60 second for a high-quality picture and no image degradation. In field mode, it reaches 4 times for 1/120 second. The result is fast inspection without having to worry about inspection time or image quality.

Internal synchronous signal inspection

Compatible with the internal synchronous signal of NTSC, video scopes and special cameras can also be used. However, depending on the model, some may not be able to be connected. Consult your Matsushita Electric Works representative (there is one connection port).

(Fastest images in its class)

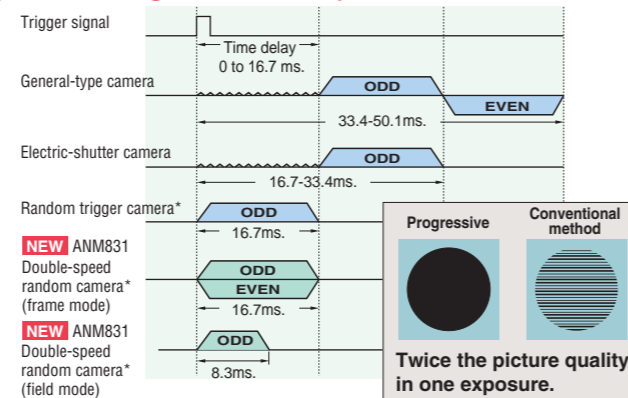

*The shutter speed on the random camera, before exposure, needs to be set to 1/120 to 1/20000 seconds.

Connects to a variety of PLCs

The A Series can connect to a range of PLCs without a communication program. In addition to the Matsushita Electric Works PLC-FP Series, it can be used with PLC products from Mitsubishi, Omron, and Allen-Bradley (Ver. 2.2 or later).

The A Series can perform type switching data communication and read and write measurement data and inspection results to and from PLCs without requiring that you create a communication program.

Compatible PLC products

- Matsushita Electric Works FP Series
- Mitsubishi MELSEC A series/FX Series
- Omron SYSMAC-C Series
- Allen-Bradley SLC500 (Ver. 2.2 or later)

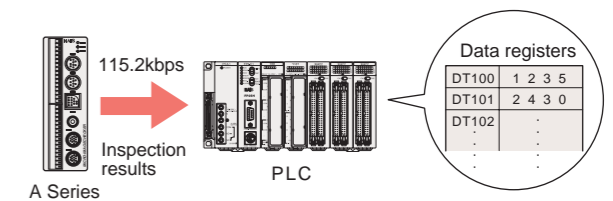

Inspection conditions can also be modified from the PLC!

Speed and precision (Strongest in its class)

The A series comes equipped with a 32-bit RISC, 200 MHz CPU with pipeline processing. It attains 360 MIPS and 1.4 GFLOPS for astronomically high-speed processing. With the super-quick CPU, increased floating point operation speed, pipeline processing, specially designed algorithms, and a large memory capacity, it achieves not only extremely high-speed inspection, but also the ultimate in precision as well.

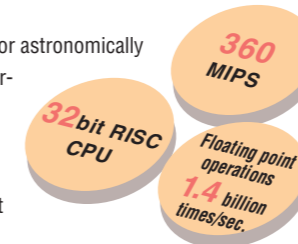

Reduced size (Smallest in its class)

With a small 120 × 40mm footprint, installation is simple. Tight installation with checkers next to each other is also possible. With considerations for wiring, connectors, and removable terminal blocks, installation with all units facing one direction is possible for no wasted space. Installation on DIN rails is also possible.



Two types available to suit your application

A210 with two camera connections and high-end functions



A110 with one camera connection and good cost performance

We offer true cost performance and wipe away the concept that image processing is expensive.



Further refined inspection functions.

The A Series is loaded with inspection know how that we have distilled over our years in this industry. With a single unit you can perform fast and accurate detection, dimension measurement and coordinate detection!



1 Smart matching (A210) / Matching (A110).

A High-speed, high-precision sub-pixel detection (Fastest level in its class).

With a high-speed CPU, vast memory, and original algorithm, even with a 64 × 64-pixel template, 256 × 256-pixel search area, and sub-pixel precision detection, you still get a processing time of **about 10 ms**. As you can see, this is the ultimate in speed and precision for position detection.



B Smart matching (A210).

Sub-pixel position detection takes place with gray-scale matching and the gray-scale differential function gives even more detailed work inspection. This gives you accurate inspection even in cases where matching processing alone would fail.

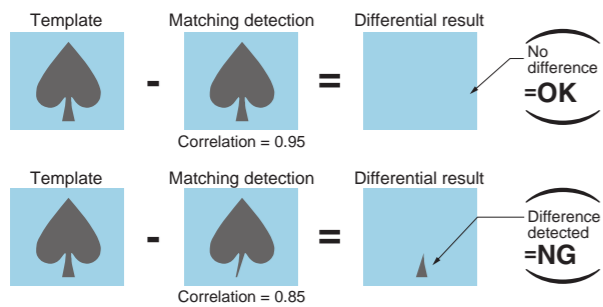

C Smart template (A210).

Just by showing multiple examples of the correct products, correct product images can be automatically composed. This allows simple inspection without setting complex parameters.

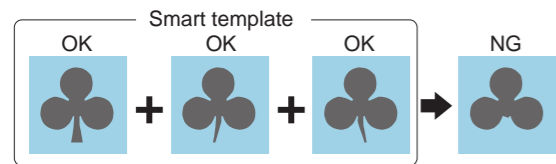

2 Sub-pixel gray-scale edge

Edge positions are measured accurately at the sub-pixel level. Also supports an edge counting function. Also equipped with the projection scanning formula so that the required edge position is detected even with products with a poor surface. With rotational correction, diagonal scanning performs sub-pixel edge detection with the gray-scale inter-pixel compensating function.

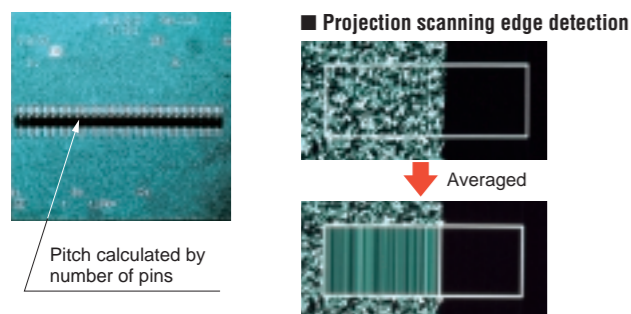

D Smart matching rotational correction (A210)

With the rotational correction function and the A210, a search is conducted by tilting the matching and smart matching search areas and templates. Therefore, even if the work has been tilted, a more precise position inspection is obtained.

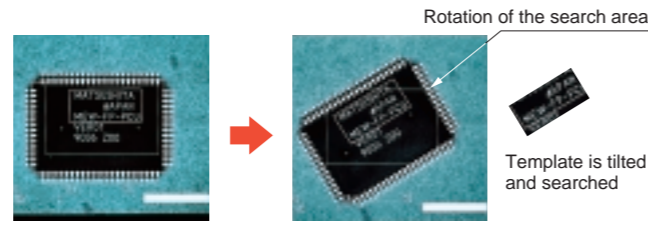

E Rotation position/tilt detection.

With the rotation search function (±30 degrees), no matter how much the detection image is tilted, the position and angle of tilt are accurately ascertained.

F Multiple position detection

Supports the multiple detection function with matching to allow the separate detection of multiple objects of the same pattern in the search area. It is an efficient function when loading is performed by robot or the like.

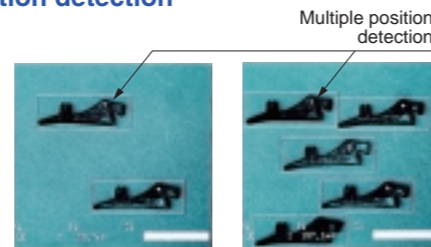

G Teaching function.

Teaching allows changes to be made to the template for matching even from an external signal. Registering the change can be done simply by showing the object for detection. Teaching also supports positional corrections so that even when work is displaced, teaching can occur.

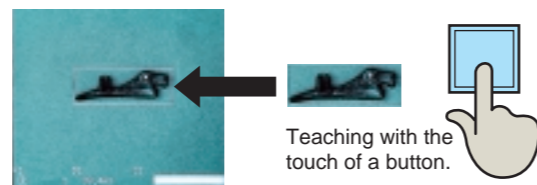

3 Gray-scale window

Since the average value for brightness within the area is quickly calculated, directional distinction can still occur even when binary distinction is difficult due to the small differences in the gray-scale levels. You can set mask processing with free shapes (rectangular, oval, polygonal) set to match the inspected object.



4 Rotational* position adjustment function

Automatic adjustment and precise inspection takes place even if the work is tilted or displaced. Adjustments can be made using the gray-scale data so that differences in brightness can allow accurate corrections. With multiple and priority functions, complex adjustments are also greatly simplified.

*A210 = rotational position adjustment function (X/Y/θ)
A110 = position adjustment function (X/Y)

Rotational adjustment (A210)

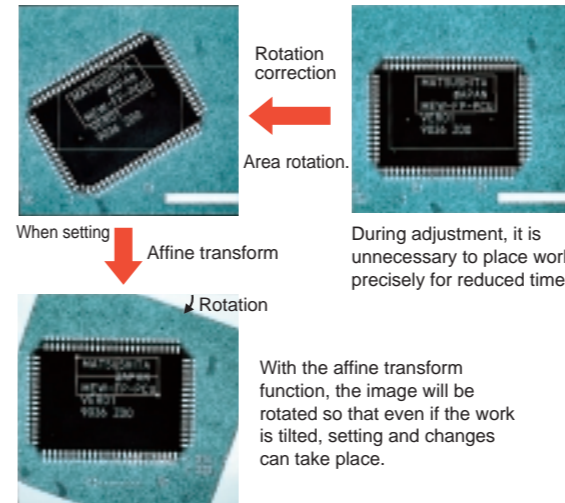

Accurate position correction (A210/A110)

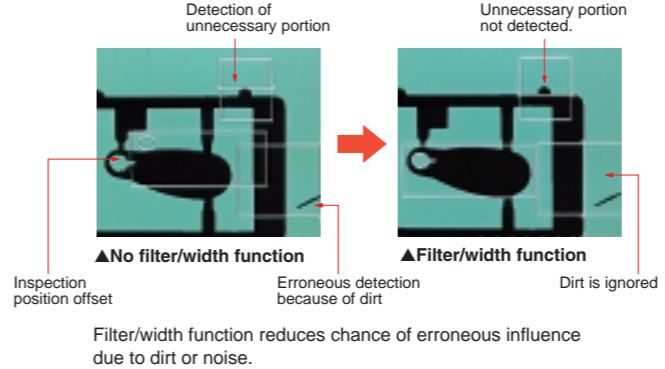

5 Improved binary processing function

A A wide range of inspection functions

- Position/size/attitude/size detection with optimum feature extraction labeling.
- Presence/size/orientation inspection with optimum binary window functions.
- High-speed dimension measurements with optimum edge detection functions.
- High-speed length/number/presence inspections with optimum line functions.

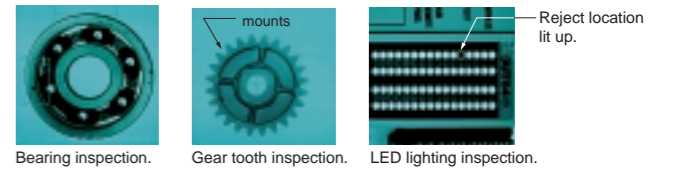

B Free shape

The shape of the inspection area can be freely adjusted between rectangular, oval, or polygonal to match the inspection object. Moreover the mask area (where no inspection takes place) can also be adjusted freely as desired.

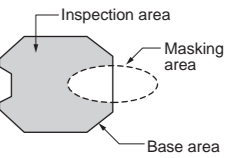

C Image filter function.

Even with binary images containing substantial noise, stable image processing is possible using filter processing such as [image erosion] → [image dilation]. The filter functions will differ depending on the inspection processing.

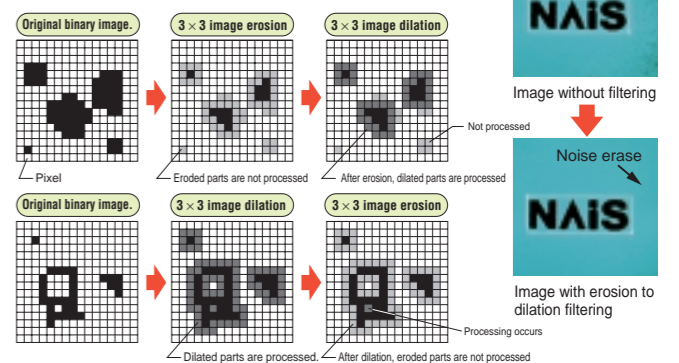

6 More numerical calculation and judgement output functions.

A Supports 96 numerical calculation formulas (48 on the A110)

Includes sine, cos, square root, arctan absolute differential and projection distance functions in addition to addition, subtraction, multiplication and division, and you can set up to 96 formulas (48 for the A110). You can also reference up to 16 items per formula for complex calculations.



Calculating distances and angles

New calculation formula copy function
(also compatible with judgment formulas)

B Leeway in judgement calculations

Even for complex pass/fail judgement outputs, internal judgment formulae can be made without using the external PLC. Depending on the application, Judgement output can be set for individual and general judgement for each inspection area freely as desired.

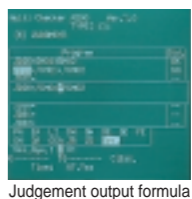

Judgement output formula

	Internal judgement calculations	External judgement calculations	Total
A210	96 formulae	96 formulae	192 formulae
A110	48 formulae	48 formulae	96 formulae

C Programless data transfer to the PLC

Using the Matsushita Electric Works. FP-series PLC, the Mitsubishi MELSEC A/FX series PLC, the Omron SYSMAC C series PLC, or the Allen-Bradley SLC 500 PLC (Ver. 2.2 or later), numerical calculation result data and judgement output results can be automatically written to the data register of the PLC at a maximum baud rate of 115200 bps. The image processing data can be used with the I/O sensitivity of the PLC.

Excellent maintenance characteristics and global compatibility.

Powerful support for startup and maintenance and designed for worldwide use.

Image storage function (A210, A110)

The A Series can store up to 30 defect images, and with the dedicated software tools you analyze the cause of defects at remote locations using e-mail.

Storing up to 30 pictures* of fault occurrences in its memory, it possible for analyzing error causes and making adjustments. When setting up the equipment, inspection images are stored and can be used when making new adjustments and changes. Moreover, the stored images can be used for testing. Also, using special software, image data and inspection conditions can be stored, and then faults can be analyzed and adjustments made at any location using e-mail. Furthermore, the location of all errors are clearly displayed and illuminated so that they can be seen at a glance.

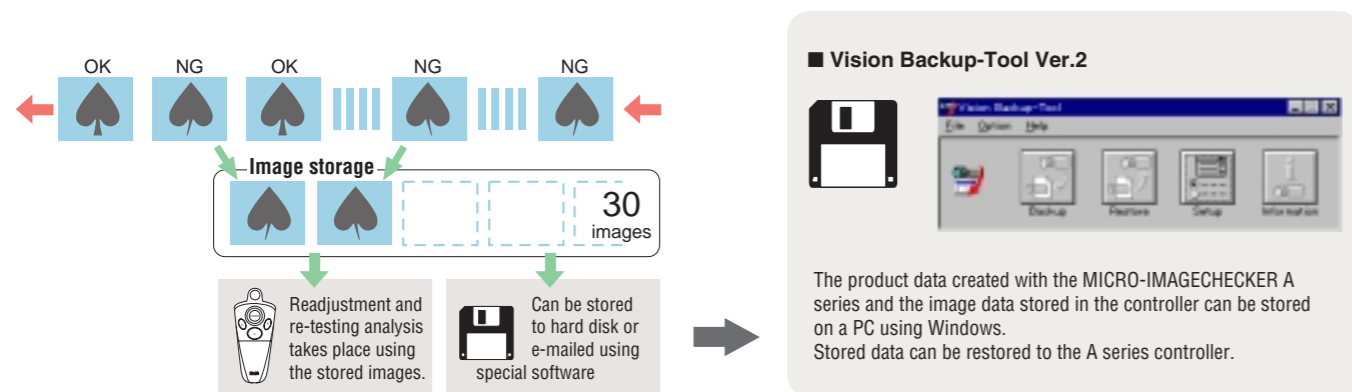

*A210 = 30 image, A110 = 8 images

* However, it is not possible to directly restore type data backed up using Vision Backup-Tool with the previous product (Ver. 1) to V2 (Ver. 2). In this case, use the dedicated data conversion software (freeware) to convert the Ver. 1 type data for V2 use, then transfer it to V2 and perform a backup again. If you require the data conversion software, contact your Matsushita Automation Controls Co. Ltd. representative.

Setup help function

Quantitative support for settings that once relied on intuition.

With the setup help function, focusing, brightness adjustment, exposure adjustment, binary level settings, and other adjustments that used to be performed by the operator's professional experience, these adjustments can now be performed quantitatively. Equipped with an input monitor and test output functions, connections to external equipment are also greatly simplified. Great savings can be made in debugging and adjustment by the combination of the trap function, which halts inspection when an error is found, and the image storage and spreadsheet functions.

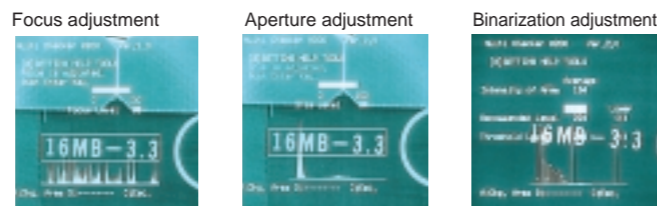

Global application

English-Japanese interchange and CE certification

Displays for the one controller can be set to either English or Japanese to allow use in a great number of countries around the globe. The controller and high-speed random trigger camera are standard products and are certified with CE markings.



MICRO-IMAGECHECKER® A210-A110 MultiChecker V2 Series

■ Dimensions (unit: mm)

- A110/A210 Controller
ANMA212V2/ANMA212
ANMA112V2/ANMA112

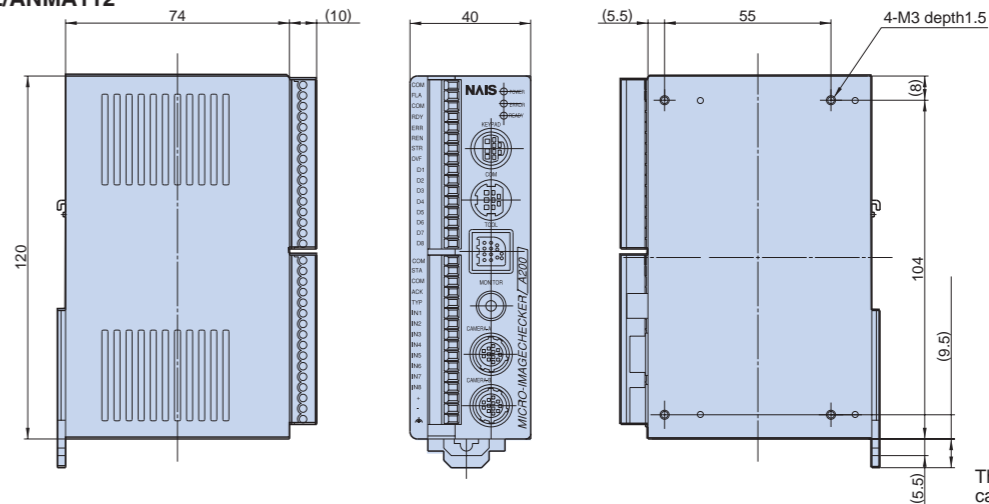

- Double-speed random camera: C mount
ANM831

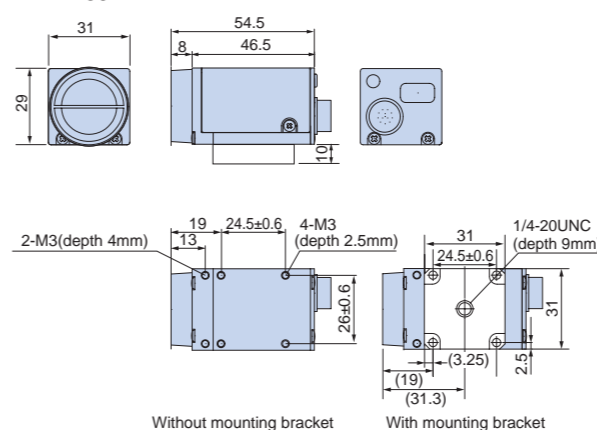

- CS mount camera: CS mount
ANM832/ANM832CE/ANM83203

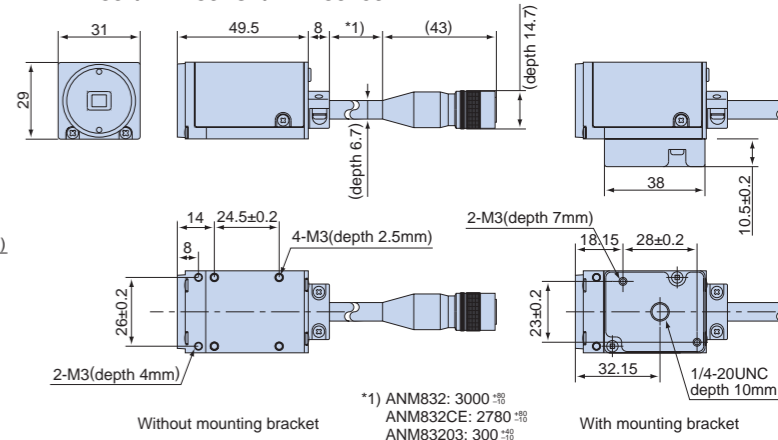

- Operating key pad
ANM8520
ANM8520□CE
□: Length of cable

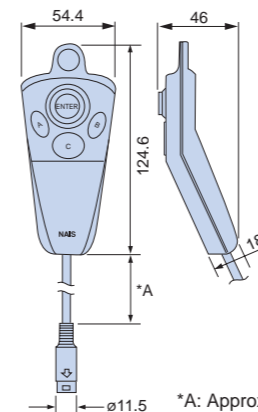

*A: Approximated length of cable for keypad used
The cable is slightly shorter on keypads with CE marking.

- Monitor (Panasonic: GPBM910)
AUGPBM910 (100 V AC)

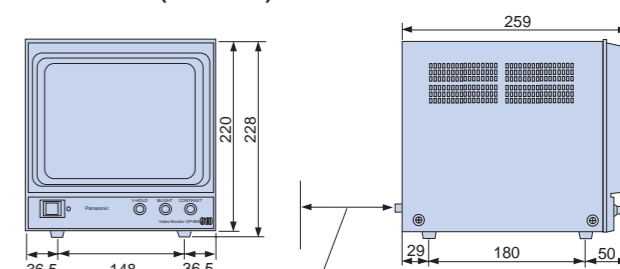

Note: Allow 80 mm behind the monitor for wiring and heat radiation.
Monitor input/output uses a BNC terminal.

- Lens

C Mount lens		
	A	B
ANB842	f=6.5	φ=48 42
ANB843(L)	f=8.5	φ=42 40
ANB845N(L)	f=16	φ=30 33
ANB846N(L)	f=25	φ=30 37.3
ANB88161	f=16	φ=30.5 25
ANB88251	f=25	φ=30.5 25.5
ANB847(L)	f=50	φ=48 48
ANM8850	f=50	φ=27.5 38.5
ANM88501	f=50	φ=30.5 38.5
CS Mount lens		
	A	B
ANM8808	f=8	φ=34 35
ANM88081	f=8	φ=31 35
ANM8804	f=4	φ=34 41
ANM88041	f=4	φ=31 40
ANM8828	f=2.8	φ=34 38
ANM88281	f=2.8	φ=31 37.5

- Camera cable
ANM84303/ANM84303CE
ANM840□□A
ANM840□□ACE
□: Length of cable

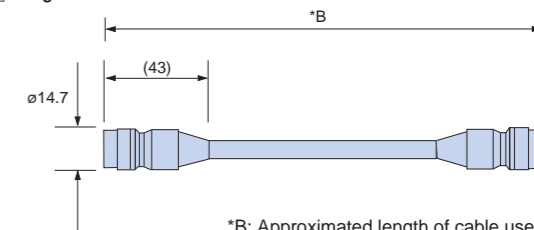

*B: Approximated length of cable used
The cable is slightly shorter on keypads with CE marking.

MICRO-IMAGECHECKER® A210-A110 MultiChecker V2 Series

■ A210 • A110 Multi-checker V2 specifications

		A210 Multi-checker V2	A110 Multi-checker V2
CPU		32-bit RISC CPU (high-speed processing version)	32-bit RISC CPU
Frame memory		512 × 480 (pixels) × 256 gradations	
Operator interface		Menu selection using the key emulation function (ver. 2.2 or later).	
Monitor display		Change between gray-scale memory/gray-scale through/binary memory (A/B/C/D/E/F)/binary through (A/B/C/D/E/F)/gray-scale NG/binary NG (A/B/C/D/E/F)	
Processing	Gray-scale	8 bit 256 gradations	
	Binarization	6 groups of binary processing from the gray-scale memory (upper and lower threshold settings)	
Number of product types		64	32
Execution modes		Execute All mode: Execute all set checkers Automatic Switch mode: Change the checker to be executed in accordance with the judgment output result User-Defined mode: Specify the checker for execution when the start signal is input	
Inspection	Position/rotation position adjustment function	Max. 96 per product type	Max. 48 per product type
		Rotation position adjustment function X-Y position adjustment function Priority adjustment multi-stage adjustment sequence setting by matching/gray-scale edge/binary edge or feature detection.	
	Exposure adjustment	Max. 96 per product type	Max. 48 per product type
		Shape: rectangular Binarization adjusts according to changes in the gray-scale data Gray-scale mean value detection/judgement	
	Smart matching/matching (sub-pixel processing)	Smart matching = Max. 96 pcs.; Equipped with post-detection differential processing function	Matching = 48 per product type
		Sub-pixel accurate multiple detection matching by gray-scale correlation processing Rotation by raster detection and raster detection position (±30 degrees) Output = number of detected items/correlation numbers/position/angle teaching registered changes can be imported from external source smart teaching (A210) = judgement learning function by the smart template	
	Gray-scale edge detection (sub-pixel processing)	Max. 96 per product type	Max. 48 per product type
		Scanning method = individual/projection gray-scale filter/width function detection by sub-pixel unit Detection position = forepoint/forepoint and afterpoint/largest differential/multiple edge	
	Gray-scale window	Max. 96 per product type	Max. 48 per product type
		Shape: rectangular/polygonal or oval mask Shape: rectangular/polygonal or oval Gray-scale mean value detection/judgement	
	Feature extraction	Max. 96 per product type	Max. 48 per product type
		Shape = rectangular/polygonal or oval mask Shape = rectangular/polygonal or oval Image filtering Labeling Output values: counter/center of gravity (to one decimal place)/area/shading/width/principle axis angle	
	Binary window	Max. 96 per product type	Max. 48 per product type
		Shape = rectangular/polygonal or oval mas Shape = rectangular/polygonal or oval Image filtering White/black pixel number count/judgement	
	Binary edge detection	Max. 96 per product type	Max. 48 per product type
		Shape = line/mask filter/width functions forepoint edge detection	
Line	Max. 96 per product type	Max. 48 per product type	
	Shape = straight line/polygonal line/circle or arc Image filters White/black pixel number count/judgement		
Conversion data	4 registers, Can quote to numerical conversion, Can convert numerical conversion result to actual distance, Standard distance, No. of pixels, Coefficient		
Numerical calculations	Max. 96 per product type	Max. 48 per product type	
	Sine, cos, absolute differential and projection distance functions four data calculations, arctangent, root, the distance-between-points special substitutions reference to previous data output control		
Judgement output	External output (D) register = Max. 96 per product type Internal judgement (R) register = Max. 96 per product type External output (D) register = Max. 48 per product type Internal judgement (R) register = Max. 48 per product type		
External interface	Serial	RS232C = 2ch (max.115200bps) Compatible with Matsushita Electric Works PLC FP series Compatible with Mitsubishi MELSEC A Series/FX Series, Omron C Series PLCs, and Allen-Bradley SLC 500 PLCs (Ver. 2.2 or later)	
	Parallel	Input = 11points Output = 14 points Removable screw-down terminal block	
Inspection start		Image trigger (timing sensor unnecessary) external sensor timing repeat start	
Other specifications	Display functions	Display item suppressing function (menu display hide function) Image suppress function when setting checkers, Image rotation function when setting checkers (A210) Clearly display reject location, Rotational adjustment angle display (A210), Data Monitor function Display of image processed with image filter, simple spreadsheet, checker list display	
	Marker function	Maximum of 8 graphics/type (line, rectangle or circle), and registered images are displayed on the main screen	
Setup tools	Image storage function	30 screens	8 screens
		Save/load function for inspection image (all screens/problem screens) Store images for reinspection/resetting Windows-PC image save/load function	
	Debugging	Trap function Image storage function	
Setup help	Focus setup, aperture setup, lighting adjustment, image profile monitor, recommended threshold level, I/O monitor, enforce output		
Moving object inspection		Double-speed random camera (progressive)/flash/electronic shutter used	
Camera support		High-speed random trigger camera (progressive) = ANM831 Standard camera = ANM830A, Composite video (NTSC) input used (however the connection requires one port)	
Number of support cameras		2	1
Operating voltage		24 V DC less than 0.9 A	24 V DC less than 0.7 A
Setup data backup		Image data and setup data can be saved to a Windows PC using vision Backup Tool Ver.	

* Type data saved in the previous controller of the MICRO-IMAGECHECKER A Series (Ver. 1) cannot be directly restored to V2 using the Vision Backup-Tool. In this case, you will need the dedicated data conversion software (freeware) to convert the Ver. 1 type data for V2 use. If you require the data conversion software or information about how to use it, contact your Matsushita Automatic Controls Co. Ltd. representative. You can also download the data converter software from the following Web page. <http://www.naisvision.com/j>

MICRO-IMAGECHECKER® A210-A110 MultiChecker V2 Series

■ A210 • A110 Multi-checker specifications

		A210 Multi-checker	A110 Multi-checker
CPU		32-bit RISC CPU (high-speed processing version)	32-bit RISC CPU
Frame memory		512 × 480 (pixels) × 256 gradations	
Operator interface		Menu selection by specialized keypad	
Monitor display		Change between gray-scale memory/gray-scale through/binary memory (A/B/C/D)/binary through (A/B/C/D)/gray-scale NG/binary NG (A/B/C/D)	
Processing	Gray-scale	8 bit 256 gradations	
	Binarization	4 groups of binary processing from the gray-scale memory (upper and lower threshold settings)	
Number of product types		64	32
Execution modes		—	
Inspection	Position/rotation position adjustment function	Max. 32 per product type	Max. 4 per product type
		Rotation position adjustment function X-Y position adjustment function Priority adjustment multi-stage adjustment sequence setting by matching/gray-scale edge/binary edge or feature detection.	
	Exposure adjustment	Max. 8 per product type	Max. 4 per product type
		Shape: rectangular Binarization adjusts according to changes in the gray-scale data Gray-scale mean value detection/judgement	
	Smart matching/matching (sub-pixel processing)	Smart matching = 32 pcs.; Equipped with post-detection differential processing function	Matching = 4 per product type
		Sub-pixel accurate multiple detection matching by gray-scale correlation processing Rotation by raster detection and raster detection position (±30 degrees) Output = number of detected items/correlation numbers/position/angle teaching registered changes can be imported from external source smart teaching (A210) = judgement learning function by the smart template	
	Gray-scale edge detection (sub-pixel processing)	Max. 32 per product type	Max. 16 per product type
		Scanning method = individual/projection gray-scale filter/width function detection by sub-pixel unit Detection position = forepoint/forepoint and afterpoint/largest differential/multiple edge	
	Gray-scale window	Max. 32 per product type	Max. 16 per product type
		Shape: rectangular/polygonal or oval mask Shape: rectangular/polygonal or oval Gray-scale mean value detection/judgement	
	Feature extraction	Max. 32 per product type	Max. 16 per product type
		Shape = rectangular/polygonal or oval mask Shape = rectangular/polygonal or oval Image filtering Labeling Output values: counter/center of gravity (to one decimal place)/area/shading/width/principle axis angle	
	Binary window	Max. 32 per product type	Max. 16 per product type
		Shape = rectangular/polygonal or oval mas Shape = rectangular/polygonal or oval Image filtering White/black pixel number count/judgement	
	Binary edge detection	Max. 64 per product type	Max. 32 per product type
		Shape = line/mask filter/width functions forepoint edge detection	
Line	Max. 32 per product type	Max. 16 per product type	
	Shape = straight line/polygonal line/circle or arc Image filters White/black pixel number count/judgement		
Conversion data	4 registers, Can quote to numerical conversion, Can convert numerical conversion result to actual distance, Standard distance, No. of pixels, Coefficient		
Numerical calculations	32 per product type	32 per product type	
	4 arithmetic calculations, arctangent, root, the distance-between-points special substitutions reference to previous data output control		
Judgement output	External output (D) register = Max. 32 per product type Internal judgement (R) register = Max. 32 per product type External output (D) register = Max. 8 per product type Internal judgement (R) register = Max. 8 per product type		
External interface	Serial	RS232C = 2ch (max.115200bps) Matsushita Electric Works PLC compatible with FP series	
	Parallel	Input = 11points Output = 14 points Removable screw-down terminal block	
Inspection start		Image trigger (timing sensor unnecessary) external sensor timing repeat start	
Other specifications	Display functions	Display item suppressing function (menu display hide function) Image suppress function when setting checkers, Image rotation function when setting checkers (A210) Clearly display reject location, Rotational adjustment angle display (A210) Numerical calculations results display, Image filtering display function, Accumulated data display, Display list of checkers	
	Marker function	—	
Setup tools	Image storage function	32 screens	8 screens
		Save/load function for inspection image (all screens/problem screens) Store images for reinspection/resetting Windows-PC image save/load function	
	Debugging	Trap function Image storage function	
Setup help	Focus setup, aperture setup, lighting adjustment, image profile monitor, recommended threshold level, I/O monitor, enforce output		
Moving object inspection		High-speed random trigger camera (progressive)/flash/electronic shutter used	
Camera support		Double-speed random camera (progressive) = ANM831 Standard camera = ANM830A, Composite video (NTSC) input used (however the connection requires one port)	
Number of support cameras		2	1
Operating voltage		24 V DC less than 0.9 A	24 V DC less than 0.7 A
Setup data backup		Setup data can be saved to a Windows PC using the Vision Backup-Tool Ver. 2	

* Type data saved in the previous controller of the MICRO-IMAGECHECKER A Series (Ver. 1) cannot be directly restored to V2 using the Vision Backup-Tool. In this case, you will need the dedicated data conversion software (freeware) to convert the Ver. 1 type data for V2 use. If you require the data conversion software or information about how to use it, contact your Matsushita Automatic Controls Co. Ltd. representative.

Free Manuals Download Website

<http://myh66.com>

<http://usermanuals.us>

<http://www.somanuals.com>

<http://www.4manuals.cc>

<http://www.manual-lib.com>

<http://www.404manual.com>

<http://www.luxmanual.com>

<http://aubethermostatmanual.com>

Golf course search by state

<http://golfingnear.com>

Email search by domain

<http://emailbydomain.com>

Auto manuals search

<http://auto.somanuals.com>

TV manuals search

<http://tv.somanuals.com>