

Panasonic®

Heavy Duty Cassette/ Weather Band Receiver with Changer Control

CQ-4500U/CQ-4300U Operating Instructions



Please read these instructions carefully before using this product and save this manual for future use.

Panasonic welcomes you to our ever growing family of electronic product owners. We know that this product will bring you many hours of enjoyment. Our reputation is built on precise electronic and mechanical engineering, manufactured with carefully selected components and assembled by people who take pride in their work. Once you discover the quality, reliability, and value we have built into this product, you too will be proud to be a member of our family.

Use This Equipment Safely

When Driving

Keep the volume level low enough to be aware of road and traffic conditions.

When Washing Vehicle

Do not expose the equipment, including the speakers and tapes, to water or excessive moisture. This could cause electrical shorts, fire, or other damage.

When Parked

Parking in direct sunlight can produce very high temperatures inside your vehicle. Give the interior a chance to cool down before switching the unit on.

Use the Proper Power Supply

This equipment is designed to operate off a 12 volt, negative ground battery system (the normal system in a North American vehicle.)

Protect the Tape Mechanism

Keep magnets, screwdrivers, or other metallic objects away from the tape mechanism and tape head to prevent poor performance or malfunctions.

Use Authorized Service Centers

Do not attempt to disassemble or adjust this precision equipment. Please refer to the Servicenter list included with this product for service assistance.

Notes:

- The two units can be connected to an optional CD changer (CX-DP801EUC, etc.), CQ-4500U can be connected to an optional wired remote control unit (CA-RC300U).
- For connection and operation of CD changer (CX-DP801EUC, etc.) and wired remote control unit (CA-RC300U), refer to the operating instructions of that unit.
- A wireless remote control unit (CA-RC500U) is optional for CQ-4500U.
- Optional wired remote control unit CA-RC300U can be connected to CQ-4500U.

Note: This operating instruction manual is for two models CQ-4500U and CQ-4300U.

The differences between these models are mentioned below. All illustrations throughout this manual represent model CQ-4500U unless otherwise specified.

Model	CQ-4500U	CQ-4300U
Features		
Wired remote control	Yes	None
Wireless remote control	Yes	None
AUX-IN	Yes	None
Temperature readout	Yes	None
S.HDB/LOUD	S•HDB	LOUD
preamp-out	Yes	None

Find the model number and serial number on either the back or bottom of the unit. Please record them in the space below and retain this booklet as a permanent record of your purchase to aid in identification in case of theft.

MODEL NUMBER **CQ-4500U/CQ-4300U** SERIAL NUMBER _____

DATE PURCHASED _____ FROM _____

Contents

Use This Equipment SafelyPage 2

Power and Sound Controls4
How to adjust the volume, mute, balance, and tone for best listening



Radio Basics.....6
Mode selection, manual and automatic tuning, band selection, preset stations

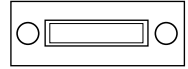

Cassette Tape Player Basics.....9
How to load, wind, play, and eject a cassette tape

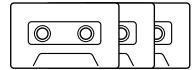

CD Changer Basics.....13
Play, repeat, random and scan, error messages.
Note: CD changer controls are applicable to units with optional CD changer unit (sold separately).



Clock Basics15
Setting the time, selecting the clock display, alarm operation

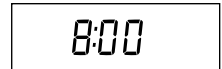

Temperature Reading17
 Cassette Head Cleaning Warning17

In Case of Malfunction.....18

Installation Guide19
Step-by-step procedures, electrical connections

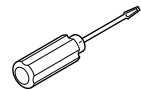

Troubleshooting28
Troubleshooting tips, where to get service help

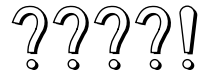

Specifications30
Part 15 of the FCC Rules30

Power and Sound Controls

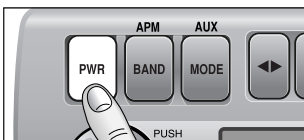
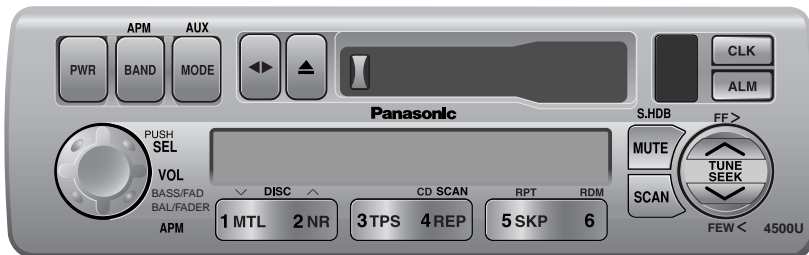

Power

If the vehicle is not running yet, turn the key in the ignition until the accessory indicator lights. Press **[PWR]** to switch on the power.

Volume

- Press the knob to select the volume mode and then turn it clockwise or counterclockwise to adjust the volume level.

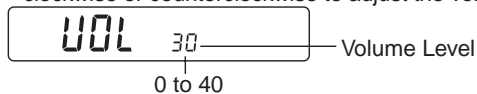

Anti-Volume-Blast Circuit

At power on, the volume returns to the previous level slowly if the level was at 20 or higher.

Changing Audio Modes

Press this knob **[SEL]** to change the audio mode as follows.



Bass and Treble

Press the knob to select the BASS or TREBLE mode and then turn it clockwise or counterclockwise to increase or decrease the bass/treble level.

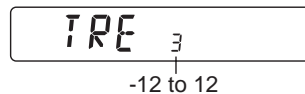
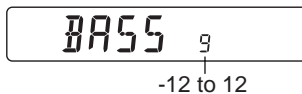

Balance

Press the knob to select the BALANCE mode and then turn it clockwise or counterclockwise to shift the sound volume to the right or left speakers.

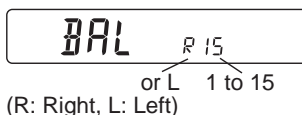

Fader

Press the knob to select the FADER mode and then turn it clockwise or counterclockwise to shift the sound volume to the front or rear speakers.

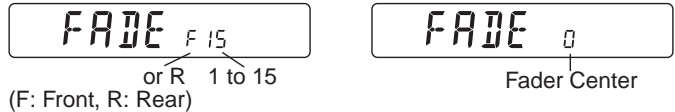

Note: In the audio mode (BASS/TRE/BAL/FADE), the display will return to regular operation mode when there is no input for more than 5 seconds (2 seconds in the VOL mode).

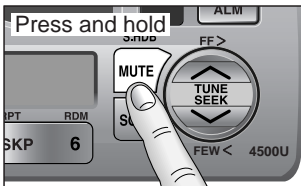

S•HDB (Super High Definition Bass)

(Only for CQ-4500U)

This feature enhances bass definition.

- Press and hold **[MUTE]** (S•HDB) for more than 2 seconds to activate high-definition bass.



- Press and hold **[MUTE]** (S•HDB) for more than 2 seconds to cancel.

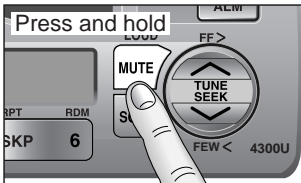

Tone Enhancement (Loudness)

(Only for CQ-4300U)

- Press and hold **[MUTE]** (LOUD) for more than 2 seconds to enhance bass and treble tones when listening at low or medium volume.



- Press and hold **[MUTE]** (LOUD) for more than 2 seconds again to deactivate when listening at higher volumes.

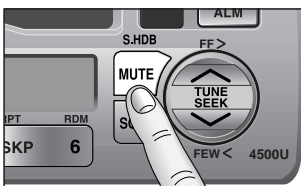

Mute

- Press **[MUTE]** to mute the sound completely.

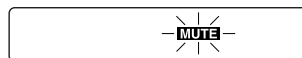

- Press **[MUTE]** again to cancel.

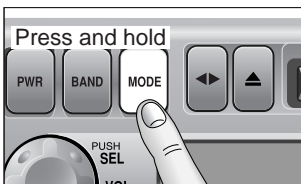

Selecting Auxiliary Source

(Only for CQ-4500U)

- ① Press and hold **[MODE]** (AUX) for more than 2 seconds to select AUX Input mode.

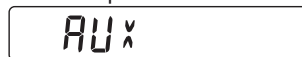

- ② Connect the auxiliary equipment (any other appropriate equipment) to the AUX IN Connector.

Canceling AUX Input mode

Press **[MODE]** (AUX) to resume the previous mode.

Radio Basics

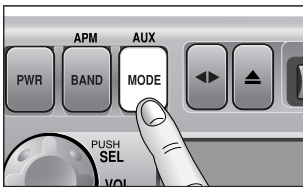
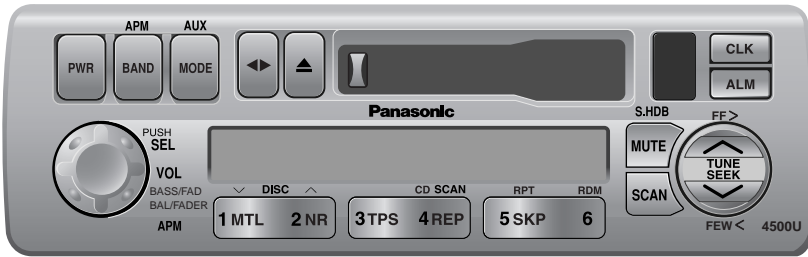

Mode Selection

Press **[MODE]** to change the operation mode as follows.

Radio → Cassette → CD Changer (when connected)



↑ ↓ Press and hold **[MODE]** for more than 2 seconds.

AUX (AUX is only for CQ-4500U)

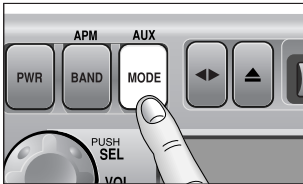

To change to the tuner mode

In case of CD changer mode or Tape mode, press **[MODE]**.

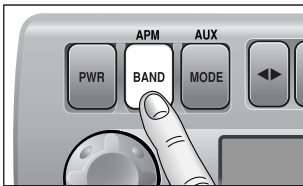

Selecting a Band

Press **[BAND]** to change the band setting as follows.

FM1 → FM2 → W/B → AM

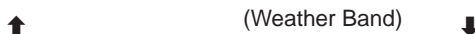

"ST" indicator lights when FM stereo broadcast is available.

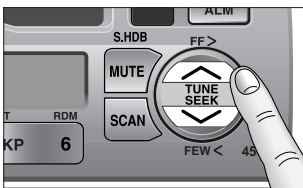
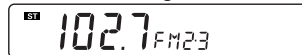

Manual Tuning

Press **[TUNE ^]** or **[TUNE v]** to tune in a higher or lower frequency.

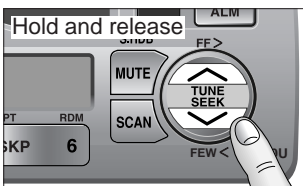

Seek Tuning

Press and hold **[SEEK ^]** or **[SEEK v]** for more than 0.5 seconds, then release it.

Seek tuning will automatically stop when a signal of the next broadcast station is received.

Station Preset

FM1, FM2, and AM can save maximum 6 stations each in their preset station memories.

Caution: To ensure safety, never attempt to preset stations while you are driving.

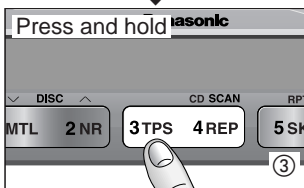
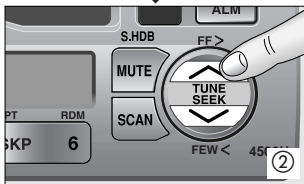
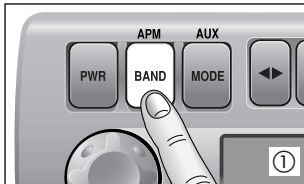

Manual Station Preset

- ① Press **[BAND]** to select a desired band.
- ② Use manual or seek tuning to find a station to be stored in the preset memory.
- ③ Press and hold one of the preset buttons **[1]** to **[6]** until the display blinks once.

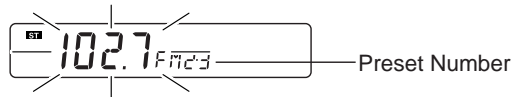

Note: You can change the memory setting by repeating the above procedure.

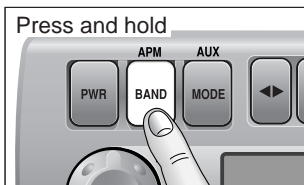

Auto Station Preset

Select a band and press and hold **[BAND]** (APM: Auto Preset Memory) for more than 2 seconds.

- The 6 strongest available stations will be automatically saved in the memory on preset buttons **[1]** to **[6]**.
- Once set, the preset stations are sequentially scanned for 5 seconds each.

Note: Any stations preset previously on the selected band will be erased.

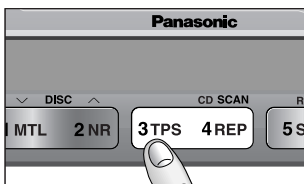

Tuning in a Preset Station

Press any of the buttons **[1]** to **[6]** to tune in the station preset by the above.

Radio Basics (continued)

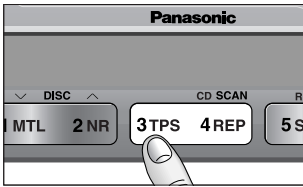

Tuning in a Weather Band Station

Press any of the buttons [1] to [6] to monitor the preset station.

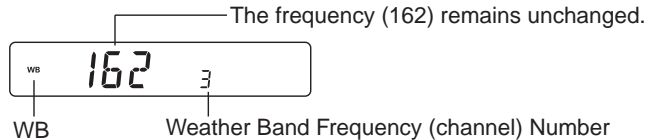

Note: The weather band (CH1-6) has been preset. CH7 is selected by pressing [^] or [v].

Weather Band Stations

National Weather Radio Broadcasts from over 380 locations throughout the U.S. on seven VHF/FM frequencies.

Tune to weather band to receive continuous weather information 24 hours a day on one of the following frequencies.

1. 162.550 MHz
2. 162.400 MHz
3. 162.475 MHz
4. 162.425 MHz
5. 162.450 MHz
6. 162.500 MHz
7. 162.525 MHz

Occasionally the frequency of an existing or planned station must be changed because of unexpected radio frequency interference with adjacent NOAA Weather Radio Stations and/or with other Government or Commercial Operations within the area. If you have a question concerning NOAA Weather Radio, please contact your nearest National Weather Service Office.

Cassette Tape Player Basics

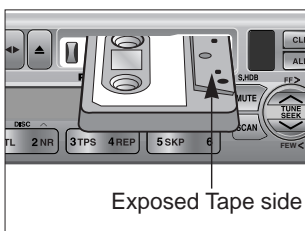
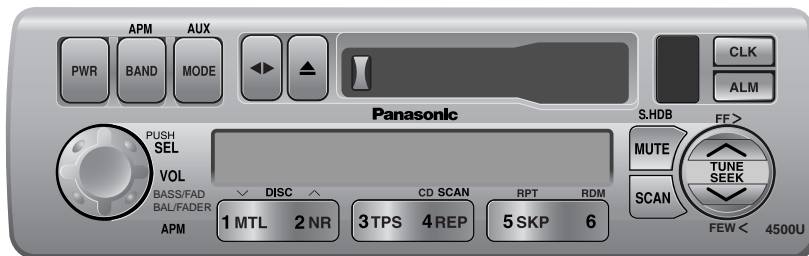

Playing a Cassette

Insert the cassette with the exposed tape side facing to the right. Play will start automatically.

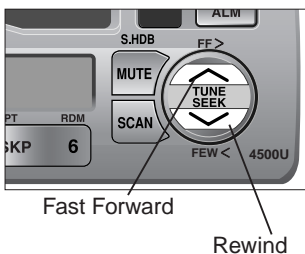

Rewind and Fast Forward

Press [V] (REW) or [^] (FF) to rewind or fast forward the tape.



Press [◀▶] to stop. The tape will resume playing from that position.

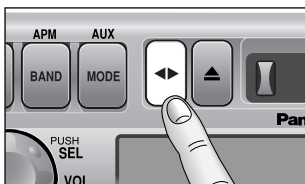

Changing Sides

Press [◀▶] to reverse.

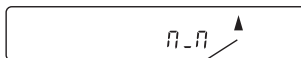

Top Side Playing

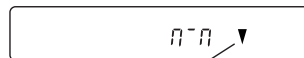

Bottom Side Playing

Cassette Tape Player Basics (continued)

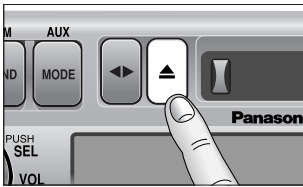

Tape Eject

Press [▲] to eject the tape, and the previous mode of operation will be resumed.

Notes:

- Always remove the cassette tape from the unit when the cassette tape player is not being used.
- If power is switched off before [▲] is pressed, the cassette will not be ejected. Switch on the power again and press [▲] to eject the cassette.



Metal Tape Mode

- Press [1 MTL] when playing metal or chromium dioxide (CrO₂) position tapes.



- Press [1 MTL] again to cancel.

Note: Playing non-metal position tapes in MTL mode causes high frequency imbalance, which affects tone quality.

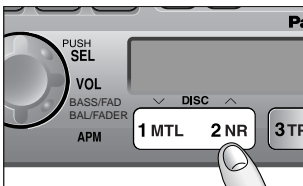

Dolby Noise Reduction

- Press [2 NR] to set the Dolby B NR mode.



- Press [2 NR] again to cancel.

Note: Set the Dolby B NR mode when playing back a tape recorded with Dolby B Noise Reduction.

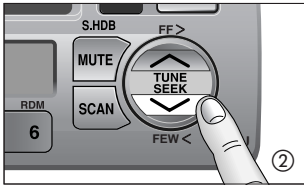
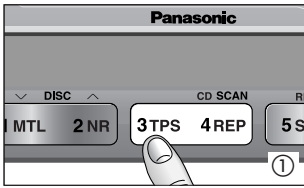

OR

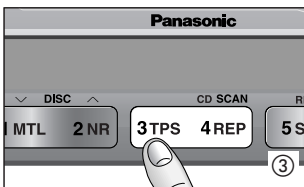
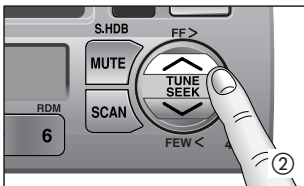

TPS Operation (Tape Program Search)

① Press [3 TPS] to activate the tape program search mode.

② To select a desired program, press [V] or [^] corresponding times to go backward (up to 8) or forward (up to 9).



Ex1. To select the current program again, press [3 TPS], and press [V].

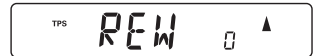

Ex2. To select the previous program, press [3 TPS], and press [V] twice.

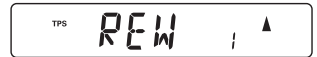

Ex3. To select the next program, press [3 TPS] and press [^].



Ex4. To select the 3rd next program, press [3 TPS], and press [^] three times.



③ Press [3 TPS] again to cancel.

Notes: The TPS mode may not work correctly in the following cases. This, however, does not mean that the unit is defective.

- There is an interval of less than 4 seconds or having a high level of noise or hum between programs.
- There is particularly low-level passage during the program.

Notes:

- To maintain your cassette player in top condition, avoid using tapes that are longer than 90 minutes (C-90).
- If you insert into the unit a cassette with a loose tape caused by forcing it into cassette with a finger or the like, the cassette may not be properly reproduced. In such a case, eject the cassette, make the tape tight, then insert it back into the deck.

Cassette Tape Player Basics (continued)

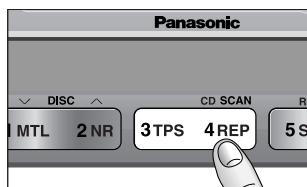

Repeat Play

- Press [4 REP] to repeat the current program.



- Press [4 REP] again to cancel.

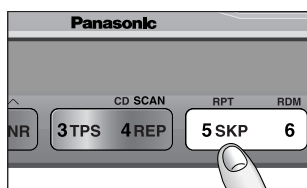

Blank Skip

- Press [5 SKP] to skip unrecorded portions on the tape.



- Press [5 SKP] again to cancel.

Notes:

- When repeat is on, the blank skip does not work because the repeat has priority over the blank skip.
- The blank skip does not work when the unrecorded portion of the tape is less than 15 seconds.

CD Changer Basics

Note: CD changer functions are designed for an optional CD changer unit.

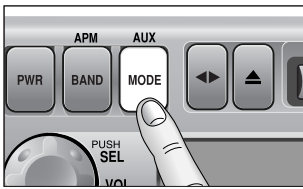
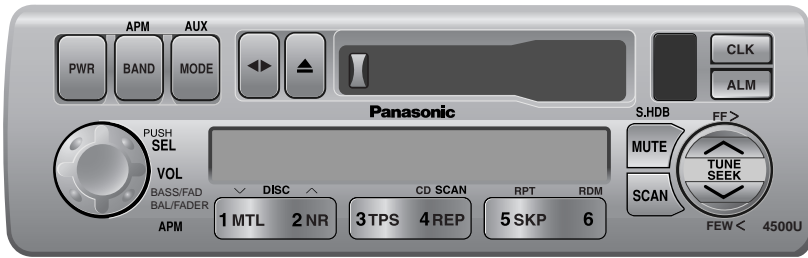

To Start the CD Changer

Once the CD changer has been connected, press **[MODE]** to change to the CD changer mode. When a disc magazine is inserted, CD play starts automatically.

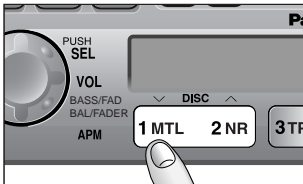
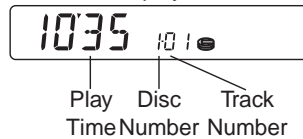

Selecting a Disc

Press **[1]** (∇ DISC) or **[2]** (DISC \wedge) to select a disc in descending or ascending order.

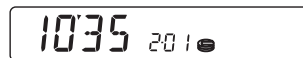

Then, the selected disc will start to play from the first track.

Note: The number of discs you can load the CD changer with is specific to each model.

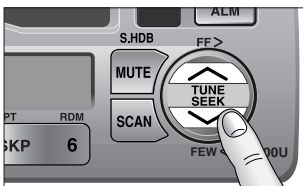

Selecting a Track

- Press [\wedge] to advance to the next track.
- Press [∇] to start play from the beginning of the current track.
- Press [∇] or [\wedge] repeatedly to skip the desired number of tracks.

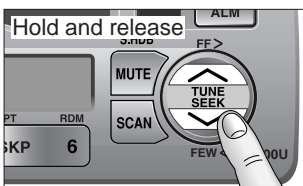

Searching a Track

- Press and hold [\wedge] or [∇] for more than 0.5 seconds to activate fast forward or reverse.
- Release [\wedge] or [∇] to resume regular CD changer play.

CD Changer Basics (continued)

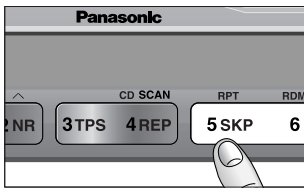

Repeat a Track

- Press [5] (RPT: REPEAT) to repeat the current selection. "REPEAT" indicator lights.



- Press [5] (RPT: REPEAT) again to cancel.

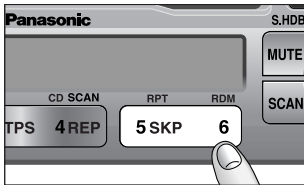

Random Selection

- Press [6] (RDM: RANDOM). All the available tracks on all discs in the magazine will be played in a random sequence.



- Press [6] (RDM: RANDOM) again to cancel.

Note: The Random mode will stop and the disc select function will operate once the [1] (∨ DISC) or [2] (DISC ∧) is pressed.

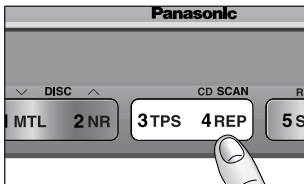

Scanning Track

- Press [4] (CD SCAN). The display blinks and the first 10 seconds of each track on the discs play in sequence.

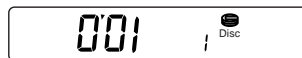

- Press [4] (CD SCAN) again to cancel.

❑ Error Display Messages

<i>E 1</i>	Appears on the display when the compact disc is dirty or inverted. Selects the next available compact disc.	<i>E 3</i>	Appears on the display when the CD changer stops operating for some reason. Please turn off the vehicle engine (ACC off), disconnect radio harness for 1 minute then reconnect.
<i>E 2</i>	Appears on the display when compact disc is scratched. Selects the next available compact disc.	<i>0000</i>	Appears on the display when there is no disc in the magazine.

Clock Basics (The clock system is 12-hours.)

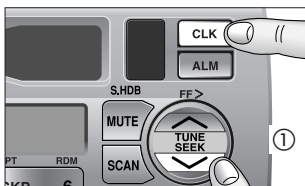
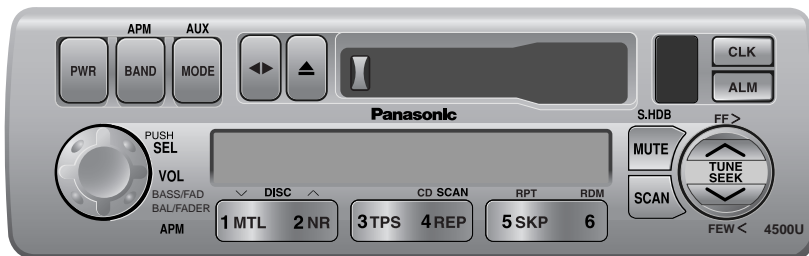

OR

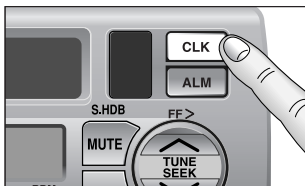
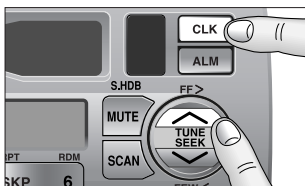

Initial Time

① Press and hold [CLK] to set time display. "AM 12:00" blinks, and the time setting mode is activated.
Press [V] to set the hour.
Press [^] to set the minute.
(Hold [V] or [^] to change numbers rapidly.)

② Once the time has been set, release [CLK].

Note: When the clock is not set yet, "SET" is displayed.

Resetting the Time

When you want to reset the time, repeat step ① and ② above.

Selecting the Clock Display

Press [CLK] to display the current time.
Press [CLK] again to returns display.

Note: The current time will be displayed at all the time even the power of the radio is turned off.

Clock Basics (continued)

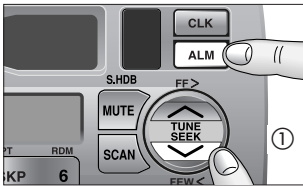
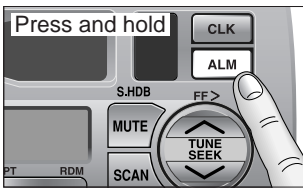

OR

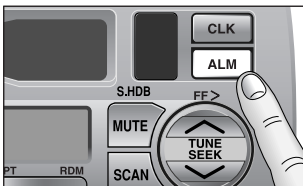
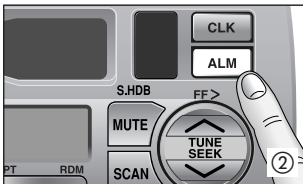

Alarm Time Setting

- ① Press and hold **[ALM]** to set alarm time. Display blinks, and the alarm time setting mode is activated.
Press **[V]** to set the hour.
Press **[^]** to set the minutes.
(Hold **[V]** or **[^]** to change numbers rapidly.)

- ② When you have set the alarm time, release **[ALM]**.

Note: When the alarm is not set yet, "AM 12:00" is displayed.

Resetting the Alarm Time

When you want to reset the alarm time, repeat steps ① and ② above.

Alarm Operation

- Alarm is switched to ON or OFF each time **[ALM]** is pressed.
- When the alarm is switched to ON, the alarm will sound at the set alarm time.

Turning off the Alarm Sound

The alarm will turn off automatically after 90 seconds. Otherwise, press **[ALM]** once.

Alarm output Volume Selection

You can select ALARM VOL 1 (or VOL 2) by pressing **[ALM]** in sequence and the display will show as follows.

ALARM TIME → ALM VOL 1 → ALM VOL 2
(display 3 seconds) (display 2 seconds) (display 2 seconds)

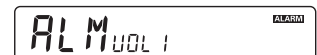

Cautions:

- Be careful not to set wrong alarm time, otherwise, the alarm may sound while driving.
- If the alarm is set, be sure to check the set alarm time by pressing and holding **[ALM]** for more than 2 seconds.
- If volume is set at "0" level, the output volume will be muted. (Even when ALARM is acting.)

Temperature Reading (Only for CQ-4500U)



- To read the temperature outside the vehicle, press and hold the knob [SEL] for more than 2 seconds. The current temperature in Fahrenheit is displayed on the display.

45 °F

- Press and hold the knob [SEL] for more than 2 seconds again to cancel the temperature reading mode.



- Press and release the knob [SEL] to shift the temperature display to the current operating mode.

Notes:

- The temperature Sensor Lead must be connected (option).
- If you switch the temperature reading mode to the other mode (EX. Tape mode → CD changer mode), the display will show that mode for 5 seconds and then resume the temperature reading.

Cassette Head Cleaning Warning

- The display will show "TAPE CLN" to warn you to clean the cassette head for maintaining its top condition after accumulated 100 hours tape playing.

TAPE CLN

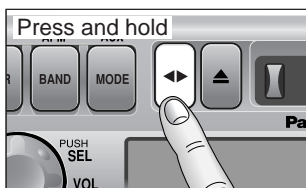

- Press and hold [◀▶] for more than 2 seconds to clear the "TAPE CLN" display and the TAPE mode display will be resumed. (It is valid only in TAPE mode.)

In Case of Malfunction

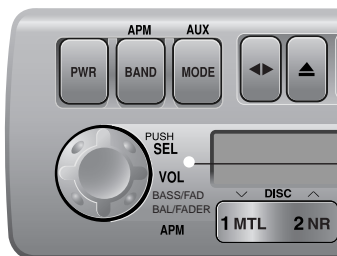

Reset Switch

If the unit does not respond when the function buttons are pressed, press the reset switch with a small pointed object, such as a pencil point. This will restore the unit to its default settings. All previously stored memory settings will be erased. Repeat the necessary steps in the previous pages to reprogram the clock and memory settings. If pressing the reset switch does not restore normal operation, please return the radio to the nearest authorized service center for service.

Installation Guide



WARNING

This installation information is designed for experienced installers and is not intended for non-technical individuals. It does not contain warnings or cautions of potential dangers in attempting to install this product.

Any attempt to install this product in a motor vehicle by anyone other than qualified installer could cause damage to the electrical system and could result in serious personal injury or death.

□ Overview

This equipment should be installed by a professional. However, if you plan to install this unit yourself, your first step is to decide where to install it. The instructions in these pages will guide you through the remaining steps: **(Please refer to "WARNING" statement above).**

- Identify and label the vehicle wires
- Connect the vehicle wires to the wires of the power connector
- Install the unit in the dash
- Check the operation of the unit

If you do encounter problems, please consult your nearest authorized dealer.

Caution: This unit will operate with a 12 volt DC negative ground auto battery system only. Do not attempt to use it in any other system. Doing so could cause serious damage.

Before you begin installation, look for the following items included in the packing with your unit.

- **Warranty Card** Fill this out promptly
- **Panasonic Servicenter for service Directory** Keep this for future reference in case the unit needs servicing
- **Installation Hardware** Needed for in-dash installation

□ Installation Hardware

No.	Item	Diagram	Qty
①	Mounting Collar		1
②	Plain Washer (5 mmφ)		2
③	Spring Washer (5 mmφ)		2
④	Hex. Nut (5 mmφ)		2
⑤	Rear Support Strap		1
⑥	Hex. Bolt (5 mmφ × 25 mm)		1
⑦	Toothed Lock Washer (5 mmφ)		1
⑧	Power Connector		1
⑨	Removal Tool (U-shaped)		2
⑩	Antenna Connector		1

Required Tools

You'll need a screwdriver, a 1.5 volt AA battery and the following:

12 V DC TEST BULB ELECTRICAL TAPE SIDE-CUT PLIERS



Dashboard Specifications

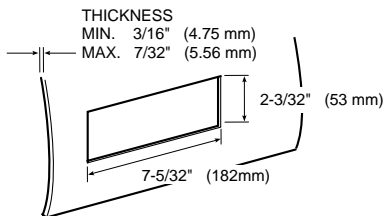

Identify All Leads

The first step in installation is to identify all the vehicle wires you'll use when hooking up your sound system.

As you identify each wire, we suggest that you label it using masking tape and a permanent marker. This will help avoid confusion when making connections later.

Note: Do not connect the power connector to the stereo unit until you have made all connections. If there are no plastic caps on the stereo hooking wires, insulate all exposed leads with electrical tape until you are ready to use them. Identify the leads in the following order.

Power Lead

If your vehicle has a radio or is pre-wired for one:

Cut the connector wires one at a time from the plug (leaving the leads as long as possible) so that you can work with individual leads.

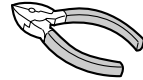

Turn the ignition on to the accessory position, and ground one lead of the test bulb to the chassis.

Touch the other lead of the test bulb to each of the exposed wires from the cut radio connector plug. Touch one wire at a time until you find the outlet that causes the test bulb to light.

Now turn the ignition off and then on. If the bulb also turns off and on, that outlet is the vehicle power lead.

If your vehicle is not wired for an audio unit: Go to the fuse block and find the fuse port for radio (RADIO), accessory (ACC), or ignition (IGN).

Battery Lead

If your stereo unit has a yellow lead, you will need to locate the vehicle's battery lead. Otherwise you may ignore this procedure. (The yellow battery lead provides continuous power to maintain a clock, memory storage or other function.)

If your vehicle has a radio or is pre-wired for one: With the ignition and headlights off, identify the vehicle battery lead by grounding one lead of the test bulb to the chassis and checking the remaining exposed wires from the cut radio connector plug.

If your vehicle is not wired for an audio unit: Go to the fuse block and find the fuse port for the battery, usually marked BAT.

Speakers

Identify the vehicle speaker leads. There will be two leads for each speaker, usually color coded.

Installation Guide (continued)

A handy way to identify the speaker leads and the speaker they connect with is to test the leads using a 1.5 volt AA battery as follows.

Hold one lead against one pole of the battery and stroke the other lead across the other pole. You will hear a scraping sound in a speaker if you are holding a speaker lead.

If not, keep testing different lead combinations until you have located all the speaker leads. When you label them, include the speaker location for each.

Antenna

The antenna lead is a thick, black wire with a metal plug at the end.

□ Connect All Leads

Now that you have identified all the wires in the vehicle, you're ready to begin connecting them to the stereo unit wires. The connection diagram on Page 26, 27 show the proper connections and color coding of the leads.

We strongly recommend that you test the unit before making a final installation.

You can set the unit on the floor and make temporary connections to test the unit. Use electrical tape to cover all exposed wires.

Important: Connect the red power lead last, after you have made and insulated all other connections.

Ground

Connect the black ground lead of the power connector to the metal vehicle chassis.

Speakers

Connect the speaker wires. See the wiring diagram below for the proper hookups. Follow the diagram carefully to avoid damaging the speakers and the stereo unit.

The speaker used must be able to handle more than 37 watts of audio power. If using an optional audio power, the speakers should be able to handle the maximum amplifier output power. Speakers with low input ratings can be damaged.

Speaker impedance should measure 4 - 8 ohms, which is typically marked on most speakers. Lower or higher impedance speakers will affect output and can cause both speaker and stereo unit damage.

Caution: Never ground the speaker cords. For example, do not use a chassis ground system or a three-wire speaker common system. Each speaker must be connected separately using parallel insulated wires. If in doubt about how your car's speakers are wired, please consult with your nearest professional installer.

CORRECT
No Common Ground

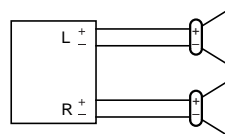

INCORRECT
Common Chassis Ground

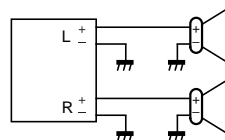

INCORRECT
Speaker Common
(common earth lead)

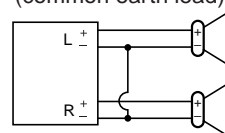

Battery

Connect the yellow battery lead to the correct radio wire or to the battery fuse port on the fuse block.

Antenna

Connect the antenna by plugging the antenna lead into the antenna receptacle.

Equipment

Connect any optional equipment such as amplifier, according to the instructions furnished with the equipment. Keep about 12 inches (30 cm) of distance between the speaker cords/amplifier unit and the antenna/antenna extension cord. Read the operating and installation instructions for any equipment you will connect to this unit.

Accessory (ACC) Power

Connect the red power lead to the correct vehicle radio wire or to the appropriate fuse port on the fuse block.

If the stereo unit functions properly with all these connections made, disconnect the wires and proceed to the final installation.

Final Installation

Lead Connections

Connect all wires, making sure that each connection is insulated and secure. Bundle all loose wires and fasten them with tape so they won't fall down later. Now insert the stereo unit into the mounting collar.

Congratulations! After making a few final checks, you're ready to enjoy your new auto stereo system.

Final Checks

1. Make sure that all wires are properly connected and insulated.
2. Make sure that the stereo unit is securely held in the mounting collar.
3. Turn on the ignition to check the unit for proper operation.

If you have difficulties, consult your nearest authorized professional installer for assistance.

Installation Guide (continued)

□ Installation Procedures

- When bending the mounting tab of the mounting collar with a screwdriver, be careful not to injure your hands and fingers.
- We strongly recommend you to wear gloves for installation work to protect yourself from injuries.

Note: Disconnect the cable from the negative (-) battery terminal.

1. Secure the Mounting Collar ①.

Insert Mounting Collar ① into the vehicle's dashboard, and bend mounting tabs out with a screwdriver.

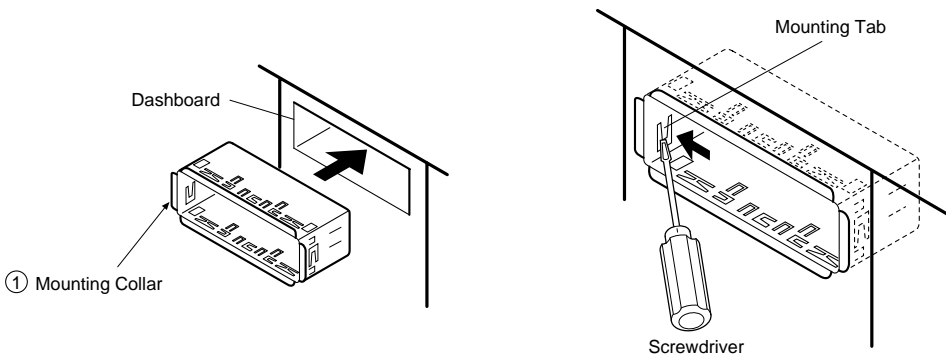

2. Secure the rear of the unit.

- Insert Power Connector ⑧ to the unit.
- Check the electrical connection by referring to this operating instructions.
- Insert the unit into Mounting Collar ① and push it in until "click" is heard.

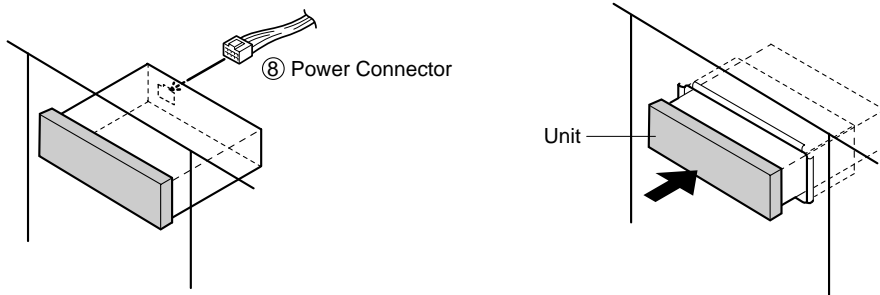

- Secure the rear of the unit to the vehicle by either of the two recommended methods on the next page.

■ Using the Rear Support Strap ⑤

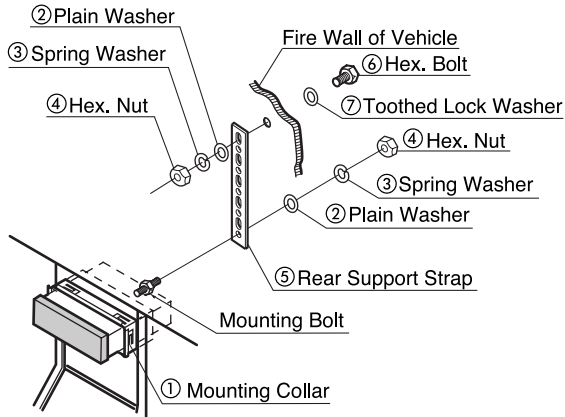

■ Using the Rubber Cushion (option)

(If there is an existing Rear Support Bracket on the fire wall of the vehicle.)

Cover Mounting Bolt on the rear of the unit with Rubber Cushion (option), and mount it into the existing Rear Support Bracket.

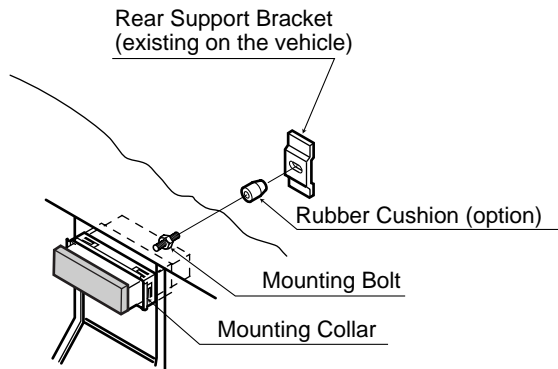

3. After installation reconnect the negative (-) battery terminal.

Installation Guide (continued)

To Remove the Unit from the vehicle's dashboard

Insert each Removal Tool and pull.

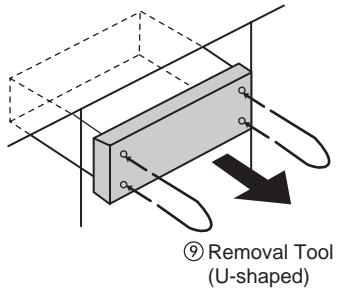

Note: Do not lose Removal Tool. They will be needed to remove the unit from the vehicle's dashboard.

Electrical Connections

(Only for CQ-4500U)

Cautions:

- This product is designed to operate with a 12-volt negative ground battery system.
- To prevent damage to the unit, be sure to follow the connection diagram below.
- Remove the covering of the leads approx. 5 mm long from their end before connecting.
- Do not insert the power connector into the unit until the wiring is completed.
- Be sure to insulate any exposed wires from a possible short-circuit from the vehicle chassis. Bundle all cables and keep cable terminals free from touching any metal parts.

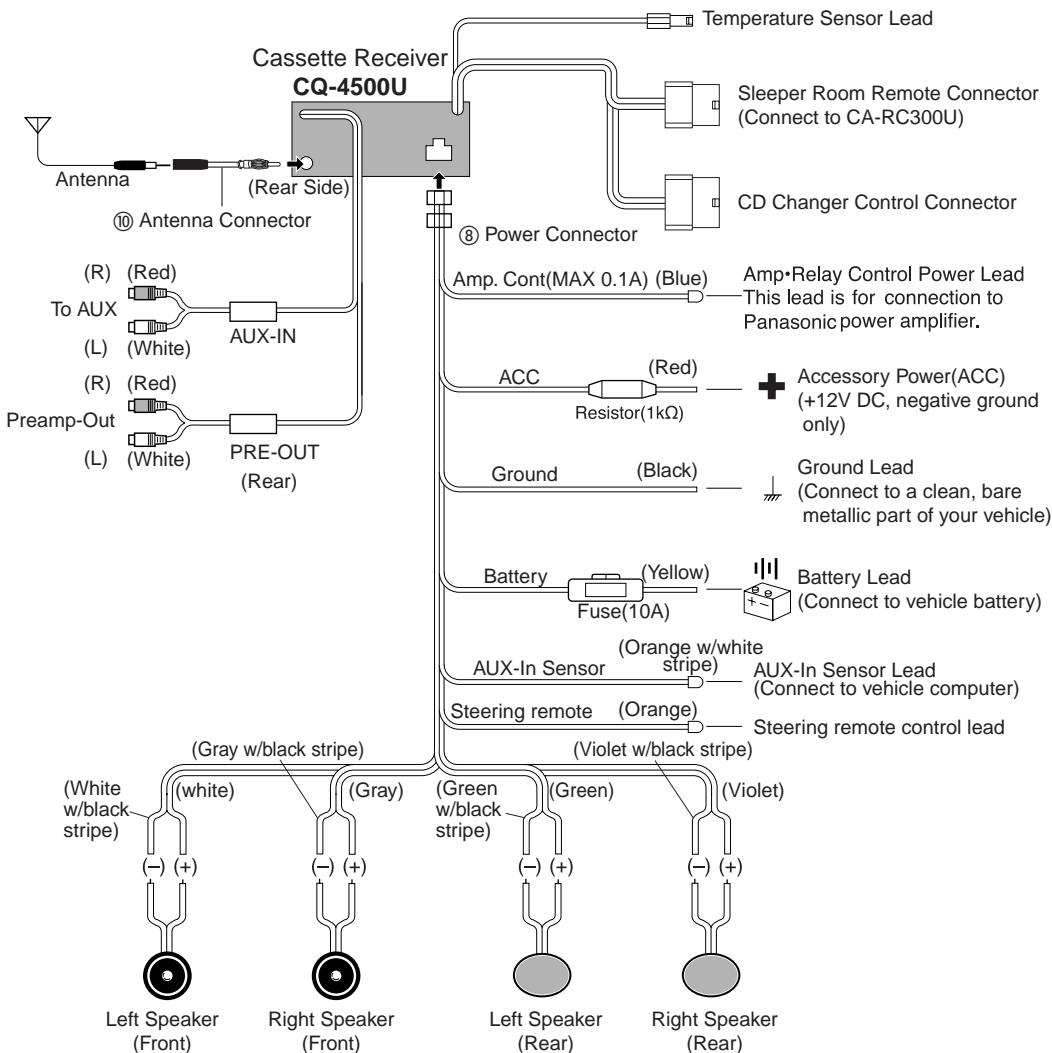

Electrical Connections (continued)

(Only for CQ-4300U)

Cautions:

- This product is designed to operate with a 12-volt negative ground battery system.
- To prevent damage to the unit, be sure to follow the connection diagram below.
- Remove the covering of the leads approx. 5 mm long from their end before connecting.
- Do not insert the power connector into the unit until the wiring is completed.
- Be sure to insulate any exposed wires from a possible short-circuit from the vehicle chassis. Bundle all cables and keep cable terminals free from touching any metal parts.

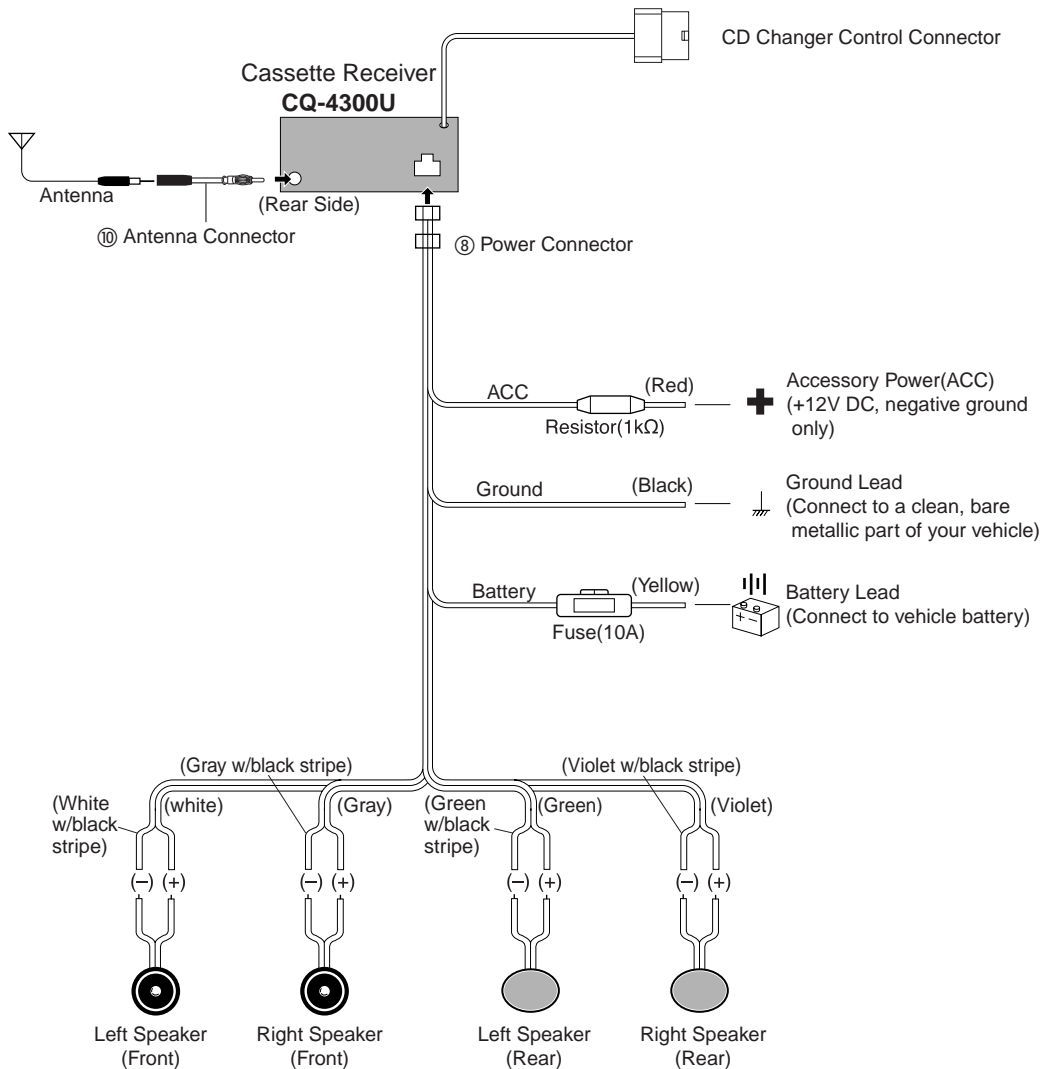

Troubleshooting

□ Maintenance

Your product is designed and manufactured to ensure a minimum of maintenance. Use a soft cloth for routine exterior cleaning. Never use benzine, thinner, or other solvent.

□ When Something Doesn't Work

Check the charts on page 29 for possible causes and solutions to any problem you might be experiencing. Some simple checks or minor adjustments may eliminate the problem.

□ Product Servicing

If the suggestions in the charts don't solve the problem, we recommend that you take it to your nearest authorized dealer. Panasonic Servicenter. The unit should be serviced only by a qualified technician.

□ Replacing the Fuse

Use fuses of the same specified rating (10 amps). Using different substitutes or fuses with higher ratings, or connecting the unit directly without a fuse, could cause fire or damage to the stereo unit.

If the replacement fuse fails, contact your nearest Panasonic Servicenter for service.

□ Notes on Cassette Tapes

Tape Slack:

Use a pencil or similar object to take up the slack as shown. If a loose tape is used, this may result in the tape becoming tangled in the rotating parts of the unit.

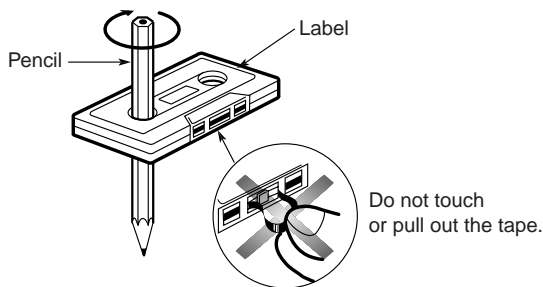

Troubleshooting (continued)

□ Troubleshooting Tips

PROBLEM	POSSIBLE CAUSE	PROBABLE SOLUTION
Unit does not turn on.	Dead vehicle battery Ignition or ACC is not on.	Charge vehicle battery. Turn ignition to On or ACC.
	Bad power line connection Fuse is blown.	Check connections. Replace fuse.(consult your dealer)
Radio has static.	Antenna not hooked up	Hook up antenna.
	Close to high power lines	Move away from high power lines.
Radio memory buttons do not work.	Not holding buttons down long enough	Press and hold buttons for more than 2 seconds.
Tape sound quality is poor.	Heads are dirty.	Clean heads. (Ask a service representative for advice.)
	Poor quality tape.	Use better quality tape.
Inverted Sound (Left/Right Connections.)	The speaker cords are inverted.	Check the speaker cords.
No sound from front or rear speakers	The fader control is set on the wrong position.	Adjust the fader control of the unit correctly.

Specifications

General

Power Supply	: 12 V DC (11V-16V) Test Voltage 14.4V, Negative ground
Maximum Power Output	: 37 W × 4 channels at 400 Hz, Volume Control maximum
Power Output	: 18 W per channel into 4 ohms, 40 to 30,000Hz at 3% THD.
Tone Action	: Bass; ± 12 dB at 100 Hz Treble; ± 12 dB at 10 kHz
Current Consumption	: Less than 2.5 A (tape mode, 0.5 W 4-speaker)
Speaker Impedance	: 4 Ω (4-8 Ω acceptable)
Dimensions (W × H × D)	: 7" × 1-15/16" × 5-7/8" (178 × 50 × 150 mm)
Weight	: 3 lbs. (1.4 kg)

AM Radio

Frequency Range	: 530-1,710 kHz
Useable Sensitivity	: 28 dB/μV (25 μV/ S/N 20 dB)

FM Stereo Radio

Frequency Range	: 87.9-107.9 MHz
Useable Sensitivity	: 12 dBf. (1.1 μV / 75Ω, S/N 30 dB)
50 dB Quieting Sensitivity	: 17 dBf. (1.8 μV / 75Ω)
Frequency Response	: 30-15,000 Hz ± 3 dB
Alternate Channel Selectivity	: 75 dB
Stereo Separation	: 35 dB at 1,000 Hz
Signal/Noise Ratio	: 70 dB (Mono)

Weather Band Radio

Frequency Range	: 162.40-162.55 MHz
Useable Sensitivity	: 3 dB/μV (S/N 20 dB)
Signal/Noise Ratio (40 dB/μV)	: 50 dB

Tape Player

Reproduction System	: 4-track, 2-program stereo
Tape Speed	: 1-7/8"/sec (4.76 cm/sec)
FF/REW Time	: Less than 110 SEC (C-60)
Frequency Response	: 35 - 14,000 Hz ± 3 dB
Wow and Flutter	: 0.09% (WRMS)
Signal/Noise Ratio	: 52 dB (Dolby NR on: 62 dB)

*Above specifications comply with EIA standards.

Note: Specifications and design are subject to modification without notice due to improvements in technology.

Dolby noise reduction manufactured under license from Dolby Laboratories Licensing Corporation.
"DOLBY" and the double-D symbol  are trademarks of Dolby Laboratories Licensing Corporation.

Part 15 of the FCC Rules

This unit has been manufactured under the Part 15 of the FCC Rules.
Do not attempt to make any changes or modifications to this unit.

**Panasonic Consumer Electronics
Company, Division of Matsushita
Electric Corporation of America**
One Panasonic Way, Secaucus,
New Jersey 07094

YFM284C331ZA TAMACO0200-0 Printed in Taiwan

Free Manuals Download Website

<http://myh66.com>

<http://usermanuals.us>

<http://www.somanuals.com>

<http://www.4manuals.cc>

<http://www.manual-lib.com>

<http://www.404manual.com>

<http://www.luxmanual.com>

<http://aubethermostatmanual.com>

Golf course search by state

<http://golfingnear.com>

Email search by domain

<http://emailbydomain.com>

Auto manuals search

<http://auto.somanuals.com>

TV manuals search

<http://tv.somanuals.com>