

Heavy Duty CD player/weather Band Receiver with CD changer Control

CQ-5335U



Operating Instructions



- Please read these instructions carefully before using this product and keep this manual for future reference.

Safety Information

WARNING:

TO REDUCE THE RISK OF FIRE OR ELECTRIC SHOCK OR PRODUCT DAMAGE, DO NOT EXPOSE THIS APPLIANCE TO RAIN, SPLASHING, DRIPPING OR MOISTURE.

CAUTION:

PLEASE FOLLOW THE LAWS AND REGULATIONS OF YOUR STATE, PROVINCE OR COUNTRY FOR INSTALLATION OF THE UNIT.

Laser Products:

Wave length: 780 nm

Laser power: No hazardous radiation is emitted with safety protection.

TO REDUCE THE RISK OF FIRE OR ELECTRIC SHOCK, AND ANNOYING INTERFERENCE, USE ONLY THE INCLUDED COMPONENTS.

The following applies only in the U.S.A.

Part 15 of the FCC Rules**FCC Warning:**

Any unauthorized changes or modifications to this equipment would void the user's authority to operate this device.

NOTICE:

This product contains lead in some components. Disposal of these materials may be regulated in your community due to environmental considerations.

For disposal or recycling information please contact your local authorities, or the Electronics Industries Alliance: <<http://www.eiae.org>.>

Find the model number and serial number on either the back or bottom of the unit. Please record them in the space below and retain this booklet as a permanent record of your purchase to help with identification in case of theft.

MODEL NUMBER **CQ-5335U** SERIAL NUMBER _____
DATE PURCHASED _____ FROM _____

We welcomes you to our ever growing family of electronic product owners. We know that this product will bring you many hours of enjoyment. Our reputation is built on precise electronic and mechanical engineering, manufactured with carefully selected components and assembled by people who take pride in their work. Once you discover the quality, reliability, and value we have built into this product, you too will be proud to be a member of our family.

☐ Use this product safely

When Driving

Keep the volume level low enough to be aware of road and traffic conditions.

When Washing Your Car

Do not expose the product, including the speakers and CDs, to water or excessive moisture. This could cause electrical shorts, fire, or other damage.

When Parked

Parking in direct sunlight can produce very high temperatures inside your car. Give the interior a chance to cool down before switching the unit on.

Use the Proper Power Supply

This product is designed to operate with a 12 V DC, negative ground battery system.

Disc Mechanism

Do not insert coins or any small objects. Keep screwdrivers and other metallic objects away from the disc mechanism and disc.

Use Authorized Service centers

Do not attempt to disassemble or adjust this precision product. Please refer to the Service center list included with this product for service assistance.







For Installation

The product should be installed in a horizontal position with the front end up at a convenient angle, but not more than 30°.

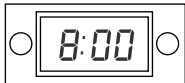
Accessories

1. Operating Instructions	1
2. Supplied Hardware.....	1 set (⇒ page 23)
3. Warranty Card.....	1

Contents

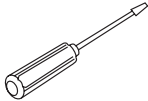
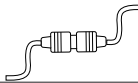
Safety Information(Part 15 of the FCC Rules)	Page 2	
Use this product safely	3	
Accessories	3	
<input type="checkbox"/> Power and Sound Controls	5	
Power, volume, mute, loudness, Illumination switching, audio mode (Bass/Treble/Balance/Fader)		
<input type="checkbox"/> Clock Setting	7	
Initial time, time resetting		
<input type="checkbox"/> Alarm Time Setting	8	
Initial alarm time, alarm time setting and reset, alarm operation, alarm output volume selection		
<input type="checkbox"/> Radio	9	
Radio mode, band, manual tuning, seek tuning, preset station setting, preset station calling, Weather Band Stations		
<input type="checkbox"/> CD Player	12	
Disc insert and playback, stop and disc eject, listening to a CD, track selection, track search, repeat play, random play, scan play		
<input type="checkbox"/> CD changer control	14	
CD Changer mode, Disc Selection, Track Selection, Track Search, scan play, repeat play, random play Note: CD changer controls are applicable to units with optional CD changer unit (sold separately)		
<input type="checkbox"/> Remote control	15	
Note: Remote controls are available to an optional Remote control unit CA-RC500U (sold separately)		
<input type="checkbox"/> Troubleshooting	16	
Troubleshooting tips, Error Display Messages		
<input type="checkbox"/> Maintenance	20	
Care of the unit, notes on discs, notes on CD-Rs/RWs		
<input type="checkbox"/> Speaker Connections	21	
<input type="checkbox"/> Installation Guide	22	
Installation hardware, overview, required tools dashboard specifications, preparation, to remove the unit		
<input type="checkbox"/> Electrical Connections	26	
Cautions, wiring diagram		
<input type="checkbox"/> Specifications	28	

Power and Sound Controls

Power

Turn the key in the ignition until the accessory indicator lights.

Power on: Press [PWR] (power).

Power off: Press [PWR] (power) again.

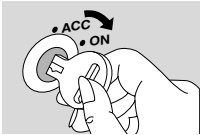

Remote Control Signal Sensor

Point the remote control unit (CA-RC 500U, option) toward the unit's sensor.



Volume

Turn the knob clockwise to increase volume, and counterclockwise to decrease volume.



Volume level (0 to 40)
(default: 18)

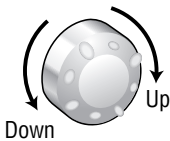

Loudness

Press and hold [MUTE] (LOUD) for more than 2 seconds to enhance bass and treble tones when listening at low or medium volume.



Press and hold [MUTE] (LOUD) for more than 2 seconds again to deactivate when listening at higher volumes.

Mute

Press [MUTE] to mute the sound completely.



Press [MUTE] again to cancel.

Power and Sound Controls (Continued)

Audio Modes (Bass/Treble/Balance/Fader)

Note: If no operation takes place for more than 5 seconds in audio mode (2 seconds in volume mode), the display returns to the regular mode.

1 Push [SEL] to select the audio mode.

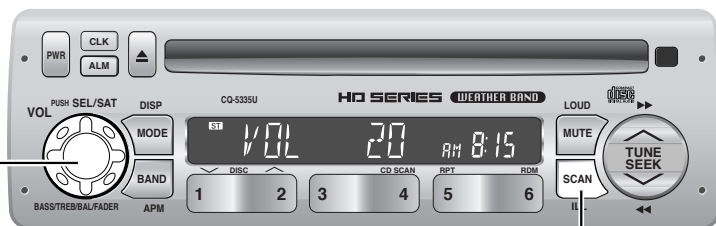
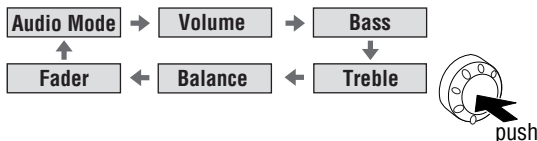

2 Turn [VOL] (volume) clockwise or counterclockwise to change each level.

Illumination Switching

Press [SCAN] (ILL) for more than 2 seconds to switch the illumination color (green/amber).

Bass:



Treble:

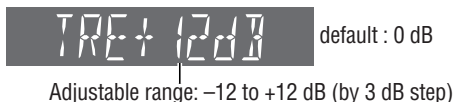

Balance:

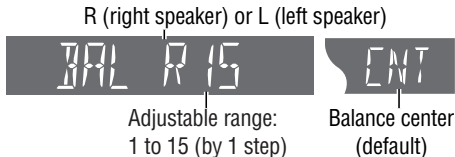

Fader:

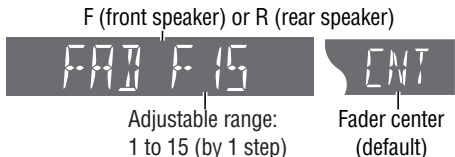

Clock Setting

Selecting the Clock Display

Press [CLK] (clock) to switch clock and alarm time display both.



Note: if no operation takes place for more than 5 seconds in alarm time, the display returns to the clock display.

The 12-hour system is used for the clock.

Initial Time



"SET" is displayed when the clock is not adjusted.



[V TUNE], [^ TUNE]
(Hours, Minutes)

Time Setting

① Press and hold [CLK] (clock) and do not release to set time. Display blinks and the time setting mode is activated.

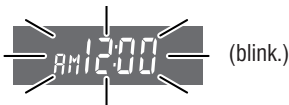

Hours

② Press [V] to set the hour.



Minutes

③ Press [^] to set the minute.



④ Once the time has been set, release [CLK].



Note: Press and hold [V] or [^] to change numbers rapidly.

Time Reset

When you want to reset the time, repeat steps ① to ④.

Note: the current time will be displayed at all the time even the power of the radio is turned off.

Alarm Time Setting

The 12-hour system is used for the clock.

Initial Alarm Time

Press and hold [ALM] (Alarm)



"AM 12:00" is displayed when the alarm is not adjusted.



Alarm Time Setting

- 1 Press and hold [ALM] (Alarm) and do not release to set alarm time. Display blinks and the alarm time setting mode is activated.



Hours

- 2 Press [V] to set the hour.



Minutes

- 3 Press [^] to set the minute.



- 4 Once the alarm time has been set, release [ALM].

Note: Press and hold [V] or [^] to change numbers rapidly.

Alarm Time Reset

When you want to reset the alarm time, repeat steps 1 to 4.

Alarm Operation

- Alarm is switched to ON or OFF each time [ALM] is pressed.
- When the alarm is switched to ON, the alarm will sound at the set alarm time.

Turning off the Alarm Sound

The alarm will turn off automatically after 90 seconds. Otherwise, press [ALM] once.

Alarm output Volume Selection

You can select ALARM VOL 1 (or VOL 2) by pressing [ALM] in sequence and the display will show as follows.

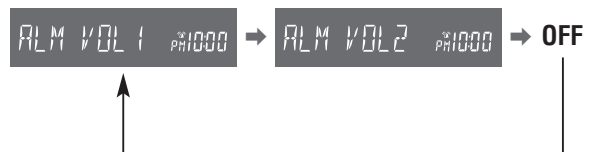

Cautions:

- Be careful not to set wrong alarm time, otherwise, the alarm may sound while driving.
- If the alarm is set, be sure to check the set alarm time by pressing [CLK].
- If volume is set at "0" level, the output volume will be muted. (Even when ALARM is acting.)

Radio

① Radio Mode

Press **[MODE]** to change to the radio mode.

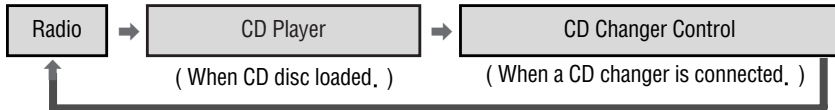

② Band

Press **[BAND]** to change the band.

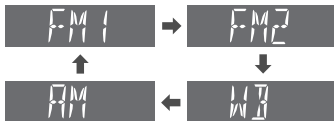

③ Scan

- Press **[SCAN]**, each station will be scanned sequentially and the display will blink for 5 seconds.
- Press **[SCAN]** again to stop scanning and the last station will continue to broadcast.

④ Manual Tuning

[^TUNE]: Higher frequency

[vTUNE]: Lower frequency

Seek Tuning

Press and hold for more than 0.5 seconds and release it.

[^TUNE]: Higher frequency

[vTUNE]: Lower frequency

Tuning will automatically stop when the next broadcast station is received.

Radio (Continued)

Preset Station Setting

Up to 6 stations can be saved in each of the FM1, FM2 and AM preset station memories.

Note: Existing saved stations are overwritten with new stations after following this procedure.

1 Band

Press **[BAND]** to select a desired band.
(⇒ page 9)

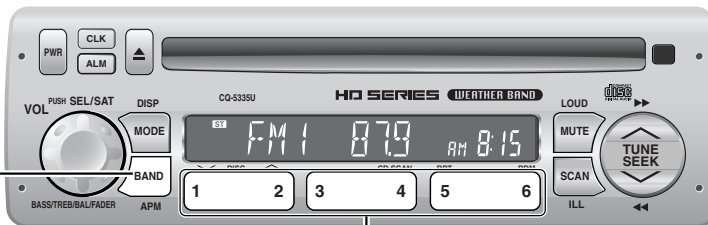

Preset buttons from [1] to [6]

2 Auto Preset Memory (APM)

Press and hold **[BAND]** (APM: auto preset memory) for more than 2 seconds.

- The 6 stations with good reception will be automatically saved in the memory under preset buttons from [1] to [6].
- Once set, the preset stations are sequentially scanned for 5 seconds each.
- Press **[BAND]** again to stop sequential scan.

Manual Preset Memory

- 1 Use manual or seek tuning to find a station. (⇒ page 9)
- 2 Press and hold one of the preset buttons from [1] to [6] until the display blinks once.

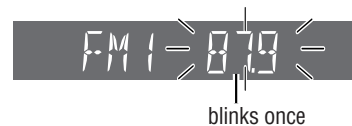

Preset Station Calling

Press the corresponding preset button from [1] to [6] to tune in a preset station.

Caution: To ensure safety, never attempt to preset stations while you are driving.



Tuning in a Weather Band Station

- Press **[BAND]** to select WB (Weather Band). (⇒ page 9)
- Press any of the buttons **[1]** to **[6]** to monitor the preset station.



WB

Weather Band Frequency (channel) Number

Note: The weather band (CH1-6) has been preset. CH7 is selected by pressing [\wedge] or [\vee].

Weather Band Stations

National Weather Radio Broadcasts from over 380 locations throughout the U.S. on seven VHF/FM frequencies.

Tune to weather band to receive continuous weather information 24 hours a day on one of the following frequencies.

1. 162.550 MHz
2. 162.400 MHz
3. 162.475 MHz
4. 162.425 MHz
5. 165.450 MHz
6. 162.500 MHz
7. 162.525 MHz

Occasionally the frequency of an existing or planned station must be changed because of unexpected radio frequency interfere with adjacent NOAA weather Radio Stations and/or with other Government or commercial Operations within the area. If you have a question concerning NOAA Weather Radio, please contact your nearest National Weather Service Office.

CD Player

Disc Insert and Playback

Disc insert

Playback will start automatically after the player recognized the loaded disc as an ordinary music CD. (When a CD-R or CD-RW which has CD-DA formatted data as the same as an ordinary music CD is loaded, this player recognizes it as an ordinary music CD.)

“LOAD” will be displayed until the disc is loaded.



Notes:

- Do not insert a disc when “DISC” indicator lights.
- The power will be turned on automatically when a disc is loading.

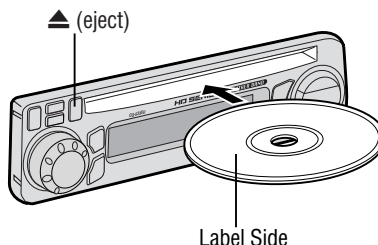

Stop and Disc Eject

Press [▲] (eject) to stop CD play and eject the disc. During disc ejection, “CD EJECT” will be displayed.

Listening to a CD

Press [MODE] to change to the CD player mode. Playback will start automatically when a disc is loaded.

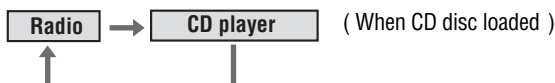

Cautions:

- Only 5" (12 cm) CD, CD-DA data recorded CD-R and CD-RW discs are available for this unit.
- This unit does not support CD text display.
- This unit does not support MP3 and WMA disc playback.
- Refer to page 20 about notes on CD-Rs/RWs.
- This unit is not designed for any 3" (8 cm) disc.
- If you insert an 3" (8 cm) disc and can not eject it, turn ACC of your car off once and turn it on again, then press [▲] (eject).
- Do not use irregular shaped discs.
- Do not use discs that have a seal or label attached.
- Do not insert foreign matter into the disc slot.



Track Selection

- Press [▶▶ TRACK]: Advance to the next track.
Press [◀◀ TRACK]: Back to the beginning of the current track.
Back to the previous track. (Press twice.)

Track Search

- Press and hold...
[▶▶ TRACK]: Fast forward
[◀◀ TRACK]: Fast reverse
Release to resume the regular play.

Repeat play

- Press [5] (RPT).
The current track is repeated.
- Press [5] (RPT) again to cancel.

REP

Random play

- Press [6] (RDM).
All the tracks are played in random order.
- Press [6] (RDM) again to cancel.

R▶

Scan play[※]

- Press [4] (CD SCAN).
The first 10 seconds of each track on the disc are played in sequence.
- Press [4] (CD SCAN) again to cancel.



CD Changer Control

1 CD Changer mode

While a disc magazine is inserted in the CD changer, press **[MODE]** to select CD changer mode.
Play starts from the first track.

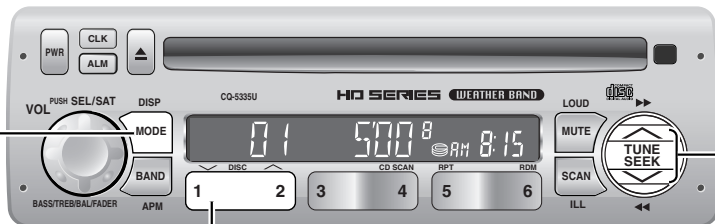

2 Disc Selection

[1] (∨ DISC): Previous disc.
[2] (∧ DISC): Next disc.

3 Track Selection

Press **[TRACK ►►]** once to go to the next track. Press repeatedly to step forward through all the tracks.
Press **[TRACK ◄◄]** once to play from the beginning of the current track, Press twice to play the previous track. Press repeatedly to step backward through all the tracks.

Track Search

Press and hold **[TRACK ►►]** or **[TRACK ◄◄]** for more than 0.5 seconds to activate fast forward or reverse through a track. Release it to resume the normal CD play from that position.

Note:

CD changer functions are applicable to units with optional CD changer unit.
(sold separately)

**Scan Play
(Tracks)**

- Press **[4] (CD SCAN)**. The track number blinks and the first 10 seconds of each track on the discs play in sequence.
- Press **[4] (CD SCAN)** again to cancel and continue with the current track.

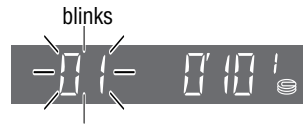

**Scan Play
(Discs)**

- Press and hold **[4] (CD SCAN)** for more than 2 seconds. The first track of all the discs in the magazine is played for 10 seconds each and Disc Number blinks.
- Press and hold **[4] (CD SCAN)** for more than 2 seconds again to cancel.



**Repeat Play
(Tracks)**

- Press **[5] (RPT)** to repeat the current track.
- Press **[5] (RPT)** again to cancel.



**Repeat Play
(Discs)**

- Press and hold **[5] (RPT)** for more than 2 seconds to repeat the current disc.
- Press and hold **[5] (RPT)** for more than 2 seconds again to cancel.



**Random Play
(Tracks)**

- Press **[6] (RDM)** to random selection. Music is played from all available CDs.
- Press **[6] (RDM)** again to cancel.



**Random Play
(Discs)**

- Press and hold **[6] (RDM)** for more than 2 seconds all the available tracks on the current disc play in a random sequence.
- Press and hold **[6] (RDM)** for more than 2 seconds again to cancel



Remote Control

CA-RC500U (option)

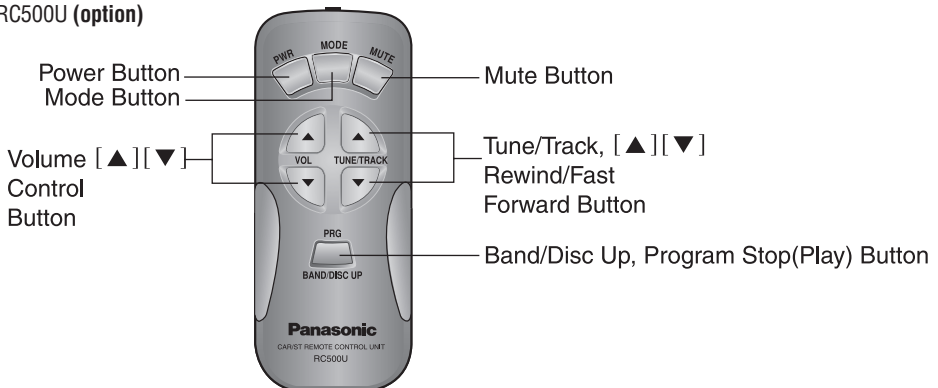

Troubleshooting

Preliminary Steps

Check and take steps as described in the tables below.

If You Suspect Something Wrong

Immediately switch the power off.

Disconnect the power connector and check that there is neither smoke nor heat from the unit before asking for repairs. Never try to repair the unit by yourself because it is dangerous to do so.

Cautions:

- Do not use the unit if it malfunctions or if there is something wrong.
- Do not use the unit in irregular condition, for example, without sound, or with smoke or foul smell, which can cause ignition or electric shock. Immediately stop using it and call the store where you purchased it.

Troubleshooting Tips

□ Common

Trouble	Cause/Step
No power.	Vehicle's ignition switch is not on. → Turn your vehicle's ignition switch to ACC or ON.
	Cables are not correctly connected. → Connect cables correctly.
	Power connector is not correctly connected. → Connect the power connector to the terminal that is always active.
	Power connector is not correctly connected. → Connect the power connector to your vehicle's ACC source.
	Grounding wire is not correctly connected. → Connect the grounding wire to a metal part of the vehicle.
No sound.	Mute is set to ON. → Set it to OFF.
	Cables are not correctly connected. → Connect cables correctly.
Noise.	The ground lead is not connected properly. → Connect the ground lead properly.

Troubleshooting (Continued)

❑ Radio

Trouble	Cause/Step
Much noise in FM stereo and monaural broadcasts.	Station is too far, or signals are too weak. ➔ Select other stations of higher signal level.
	The radio antenna is not extended enough. ➔ Extend fully the radio antenna.
Preset station is reset.	Battery cable is not correctly connected. ➔ Connect the battery cable to the terminal that is always active.

❑ CD

Trouble	Cause/Step
Disc is in the CD compartment but no sound is made, or disc is ejected automatically.	Disc is upside down. ➔ Place disc in the correct direction with the label side up.
	<ul style="list-style-type: none">• Disc is dirty.• Disc has scratches. ➔ Clean disc, referring to the section on “Notes on Discs”.
	A disc that has data other than CD-DA type is loaded. ➔ Discs that have CD-DA type data should be used.
Sound skips, bad sound quality. (e.g. caused by noise)	➔ The unit may not successfully playback a CD-R/RW that is made in combination of writing software, a CD recorder (CD-R/RW drive) and a disc which are incompatible one another. Refer to instructions for the concerned devices for details.
	<ul style="list-style-type: none">• Disc is dirty.• Disc has scratches. ➔ Clean disc, referring to the section on “Notes on Discs”.
	➔ The unit may not successfully playback a CD-R/RW that is made in combination of writing software, a CD recorder (CD-R/RW drive) and a disc which are incompatible one another. Refer to instructions for the concerned devices for details.

□ CD (Continued)

Trouble	Cause/Step
Sound skips due to vibration.	Mounting angle is over 30°. → Adjust mounting angle to less than 30°.
Disc is not ejected.	Instable mounting. → Mount the unit securely with the mounting parts, referring to the section on installation. • Disc is defective. • Mechanical trouble. → Press [▲] (eject). If normal operation is not restored, call the store where you purchased the unit or the nearest Service center to ask for repairs.
Time is counted but no sound comes out.	The first track of a mix mode disc was reproduced. (Mix mode is a format in which data except music is recorded on the first track and music data is recorded on other than the first track in a session.) → Playback music data recorded on other than the first track.



□ Sound Setting

Trouble	Cause/Step
No sound from left, right, front, or rear speaker.	Left and right balance, or front and rear balance is off on one side. → Adjust BAL/FAD as appropriate. Cables are not correctly connected. → Connect the cables correctly.
Left and right sounds are reversed in stereo listening.	The right speaker wire is connected to the left speaker and the left speaker wire to the right speaker. → Connect the speaker wires to the correct ones.





Troubleshooting (Continued)

Error Display Messages

❑ CD

Trouble	Cause/Step
	Disc is dirty, or is upside down. A disc that has data other than CD-DA type is loaded. → Check the disc.
	Disc has scratches. → Check the disc.
	No operation by some cause. → If normal operation is not restored, call the store where you purchased the unit or the nearest Service center to ask for repairs.

❑ CD changer

	Disc is dirty, or is upside down. → Select the next available compact disc. Check the disc.
	Disc has scratches. → Select the next available compact disc. Check the disc.
	No operation by some cause. → Eject the magazine. If failure persists, press the reset switch on the CD changer. If normal operation is not restored yet, call the store where you purchased the unit to the nearest panasonic service center to ask for repairs.
	No disc in the changer (magazine) → Insert discs into the changer (magazine).

Maintenance

Care of the Unit

Cleaning this Unit

Use a dry, soft cloth to wipe.

Caution on Cleaning

Never use solvents such as benzene, thinner as they may mar the surface of the unit.

Notes on Discs

Do not play any ordinary music CDs with labels other than this one.



How to hold the disc

- Do not touch the underside of the disc.
- Do not scratch the discs.
- Do not bend disc.
- When not in use, keep the disc in the case.

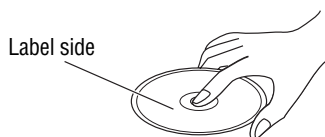

Do not use irregular shaped discs.

- Transparency discs maybe can not be played back

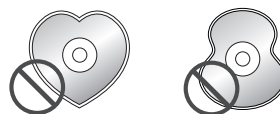

Do not use irregular shaped discs.

Do not leave discs on the following places:

- Direct sunlight
- Near car heaters
- Dirty, dusty and damp areas
- Seats and dashboards

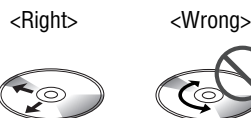

Disc cleaning

Use a dry, soft cloth to wipe from the center outward.

Do not attach any seals or labels to your discs.

Do not write on the disc label in a heavy pen or ballpoint pen stroke.

Notes on CD-Rs/RWs

- You may have trouble playing back some CD-R/RW discs recorded on CD recorders (CD-R/RW drives), either due to their recording characteristics or dirt, fingerprints, scratches, etc. on the disc surface.
- CD-R/RW discs are less resistant to high temperatures and high humidity than ordinary music CDs. Leaving them inside a vehicle for extended periods may damage them and make playback impossible.
- The unit may not successfully play back a CD-R/RW that was made by the combination of writing software, a CD recorder (CD-R/RW drive) and a disc if they are incompatible one another.
- This player cannot play the CD-R/RW discs if the session is not closed.
- This player cannot play the CD-R/RW discs which contains other than CD-DA data.
- Be sure to observe the instructions of CD-R/RW disc for handling it.

Speaker Connections

Caution: Please follow the instructions given below. Failure to do so will cause damage to the unit and speakers.

<Right>

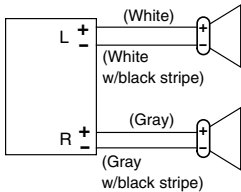

- Use ungrounded speaker only.
- The maximum speaker input should be 37 W or more. (If used with the optional power amplifier, the speaker input should be higher than the maximum amplifier output.)
- The speaker impedance should be 4 - 8 Ω .
- This unit uses the BTCL circuit, so each speaker should be connected separately using parallel vinyl insulated cords.
- The speaker cords and the power amplifier unit should be kept away (about 30 cm apart) from the antenna and antenna extension cord.

<Wrong>

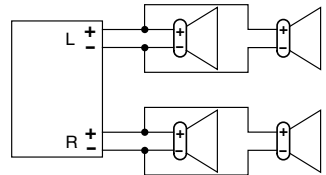
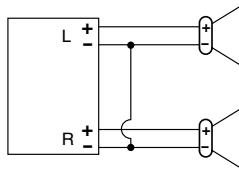
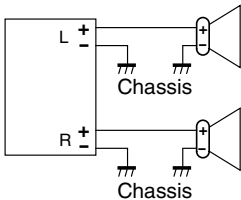

- Never connect the speaker cord to the body of the car.
- Do not use a 3-wire type speaker system having a common earth lead.
- Do not connect more than one speaker to one set of speaker leads.

Product Servicing

If the suggestions in the charts do not solve the problem, we recommend that you take it to your nearest authorized Panasonic Service center. The product should be serviced only by a qualified technician.

Maintenance

Your product is designed and manufactured to ensure the minimum of maintenance. Use a soft cloth for routine exterior cleaning. Never use benzine, thinner, or other solvents.

Caution

This product is designed without a fuse inside due to fuses already exist in your vehicle. We would recommend to use fuses of the specified rating (10 A). Using fuses that exceed the prescribed capacity could cause this product to start smoking, ignite or other malfunction.

If your vehicle is without the fuse or a circuit breaker to protect this unit, please your dealer add the specified fuse 10 A or a circuit breaker at the BATTERY lead of your vehicle's harness. please see page 26 to find out where "BATTERY + 12 V" is for your dealer adding the fuse or the circuit breaker.

Installation Guide



WARNING

❑ This installation information is designed for experienced installers and is not intended for non-technical individuals. It does not contain warnings or cautions of potential dangers involved in attempting to install this product.

Any attempt to install this product in a vehicle by anyone other than a qualified installer could cause damage to the electrical system and could result in serious personal injury or death.

❑ If your vehicle is equipped with air bag and/or anti-theft systems, specific procedures may be required for connection and disconnection of the battery to install this product.

Before attempting installation of this electronic component, contact your vehicle dealer or manufacturer to determine the required procedure and strictly follow their instructions.

FAILURE TO FOLLOW THE PROCEDURE MAY RESULT IN THE UNINTENDED DEPLOYMENT OF AIR BAGS OR ACTIVATION OF THE ANTI-THEFT SYSTEM RESULTING IN DAMAGE TO THE VEHICLE AND PERSONAL INJURY.

❑ Overview

This product should be installed by a professional. However, if you plan to install this product yourself, your first step is to decide where to install it. The instructions in these pages will guide you through the remaining steps: (Please refer to the “WARNING” statement above.)

- Identify and label the car wires.
- Connect the vehicle wires to the wires of the power connector.
- Install the unit in the dashboard.
- Check the operation of the unit.

If you encounter problems, please consult your nearest professional installer.

Caution: This unit operates with a 12 V DC negative ground auto battery system only. Do not attempt to use it in any other system. Doing so could cause serious damage.

Before you begin installation, look for the items which are packed with your unit.

- **Warranty Card**...Fill this out promptly.
- **Panasonic Servicenter List for Service Directory**

...Keep for future reference in case the product needs servicing.

- **Installation Hardware**...Needed for in-dash installation.

❑ Dashboard Specifications

Thickness Min. $\frac{3}{16}$ " (4.75 mm)
Max. $\frac{7}{32}$ " (5.56 mm)

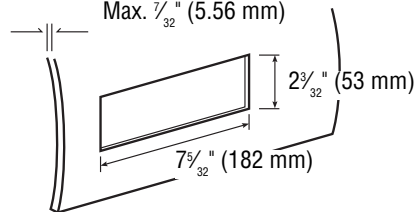

Installation (Continued)

□ Preparation

Warning: If your vehicle is equipped with air bag and/or anti-theft systems, specific procedures may be required for connection and disconnection of the battery to install this product.

Before attempting installation of this electronic component, contact your vehicle dealer or manufacturer to determine the required procedure and strictly follow their instructions.

FAILURE TO FOLLOW THE PROCEDURE MAY RESULT IN THE UNINTENDED DEPLOYMENT OF AIR BAGS OR ACTIVATION OF THE ANTI-THEFT SYSTEM RESULTING IN DAMAGE TO THE VEHICLE AND PERSONAL INJURY.

- Disconnect the cable from the negative ⊖ battery terminal (see warning and caution below).
- Remove Mounting Collar ① from the main unit temporarily, which are already mounted at shipment.*

Caution: Various settings that have been stored in the memory in other on-board equipment (vehicle navigation etc.) may be lost if the battery terminals are disconnected.

Therefore, we recommend to make a record of or to back up the settings before disconnecting the terminals.

After completing installation of the main unit, set the equipment again according to the record.

- Unit should be installed in a horizontal position with the front end up at a convenient angle, but not more than 30°.

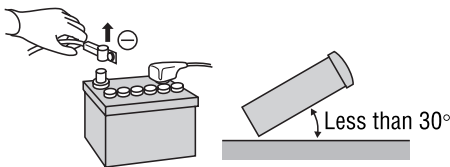

□ Dashboard Installation

Installation Opening

This unit can be installed in any dashboard having an opening as shown below. The dashboard should be 3/16" (4.75 mm) – 7/32" (5.56 mm) thick in order to be able to support the unit.

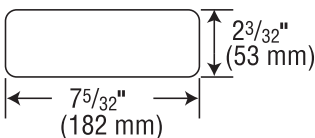

□ Installation Hardware

No.	Item	Diagram	Q'ty
①	Mounting Collar*		1
②	Plain washer (5mmø)		2
③	Spring Washer (5mmø)		2
④	Hex. Nut (5mmø)		2
⑤	Rear Support Strap		1
⑥	Hex. Bolt (5mmø × 25 mm)		1
⑦	Toothed Lock Washer (5mmø)		1
⑧	Removal Tool (U-shaped)		2
⑨	Antenna Connector		1

(a) Using the rear support strap ⑤

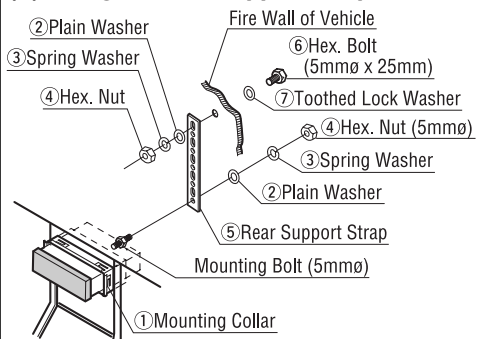

(b) Using the rubber cushion (option)

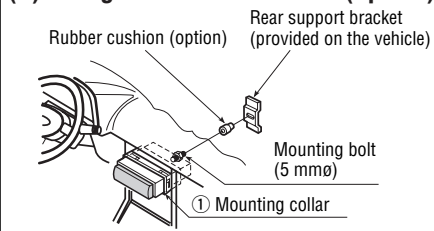

Cautions:

- We strongly recommend that you wear gloves for installation work to protect yourself from injuries.
- When bending the mounting tab of the mounting collar with a screwdriver, be careful not to injure your hands and fingers.

First complete the electrical connections, and then check them for correctness. (→ page 26)

The included Mounting Collar ① is designed specially for this unit. Do not use it to attach any other model.

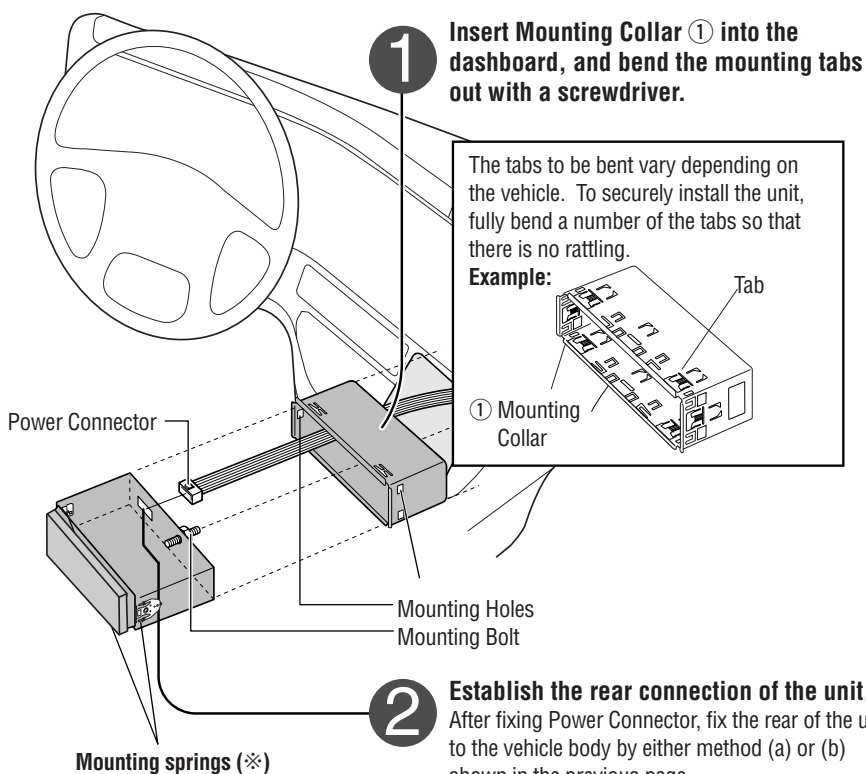

2 Establish the rear connection of the unit.
After fixing Power Connector, fix the rear of the unit to the vehicle body by either method (a) or (b) shown in the previous page.

3 After installation reconnect the negative (-) battery terminal.

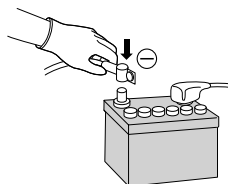
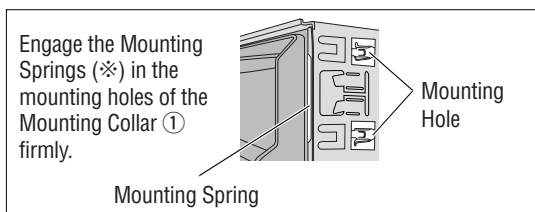

Installation (Continued)

To Remove the Unit from the vehicle's dashboard

Insert each Removal Tool ⑧ and pull.

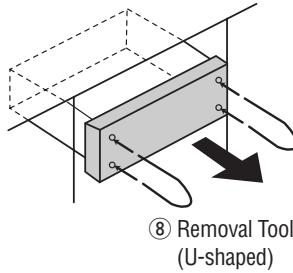

Note: Do not lose Removal Tools. They will be needed to remove the unit from the vehicle's dashboard.

Electrical Connections

Cautions:

- This wiring information is for experienced technical individual, for safety reason, please your dealer wire this connection.
- This product is designed to operate with a 12 V DC, negative ground battery system.
- To prevent damage to the unit, be sure to follow the connection diagram below.
- Do not insert the power connector into the unit until the wiring is completed.
- Be sure to insulate any exposed wires from a possible short-circuit from the vehicle chassis. Bundle all cables and keep cable terminals free from touching any metal parts.
- Remember, if your vehicle has a drive computer or a navigation computer, the data of its memory maybe erased when the battery terminals are disconnected.

Wiring Diagram

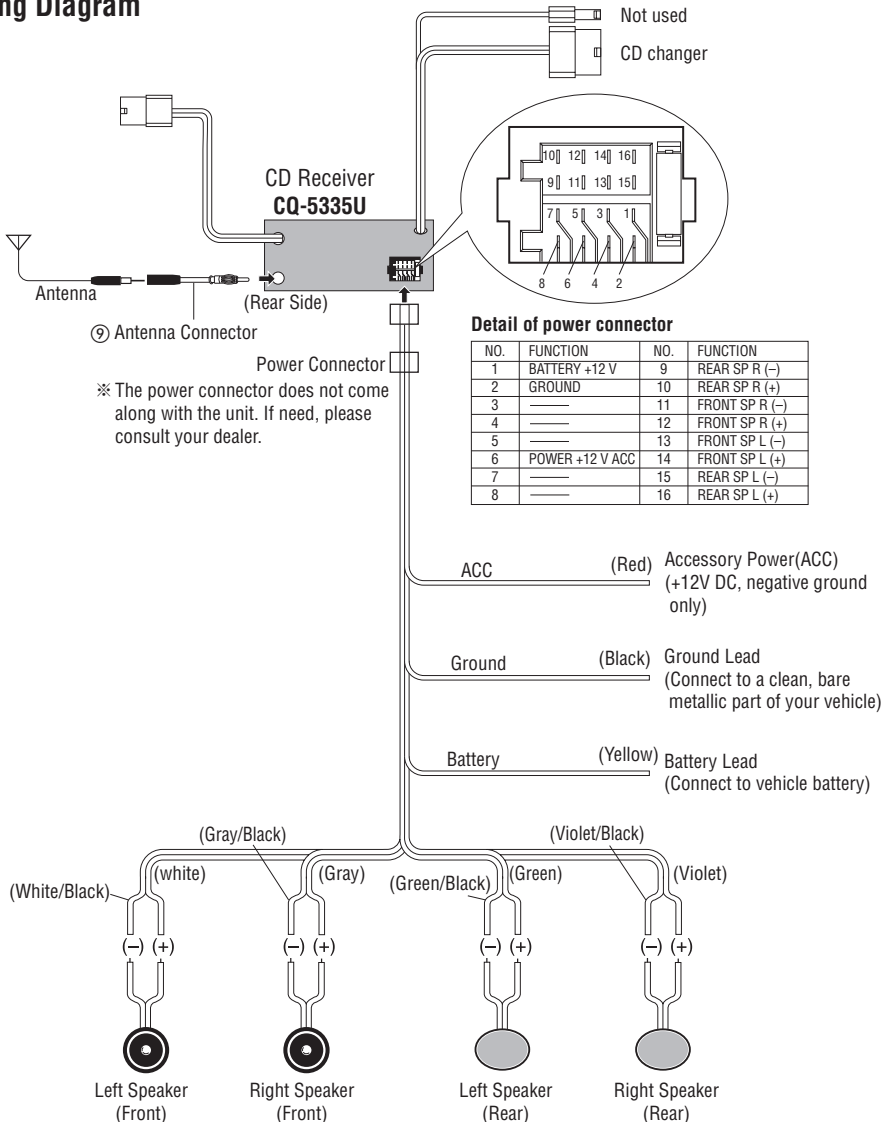

❑ Upgrading the system (connect a CD changer and the wired remote.)

Note:

For wiring, carefully read the operation instructions for the devices connected.

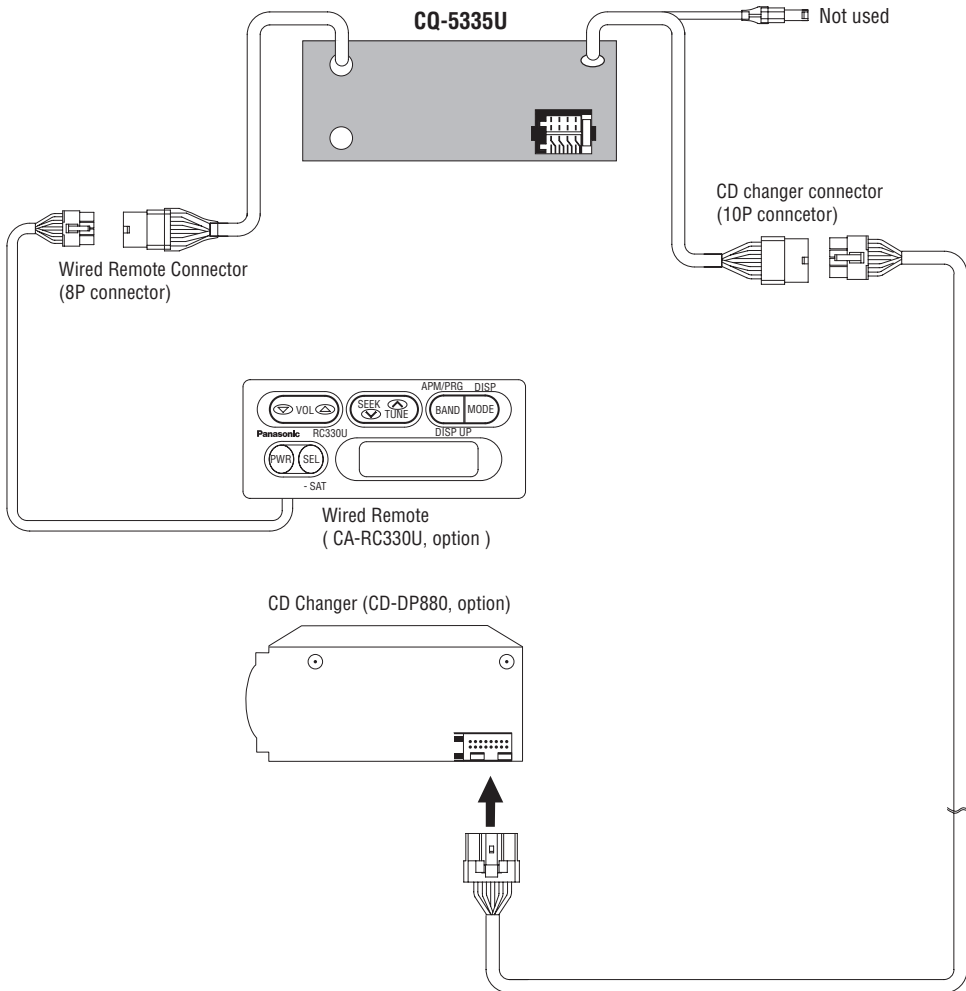

Extension Cable for connecting the unit and CD changer.

※The Extension cable does not come along with the unit, if need, please consult your dealer.

Specifications

□ General

Power Supply:	12 V DC (11 V-16 V) test Voltage 14.4 V, Negative ground
Current consumption:	Less than 2.5 A (CD mode, 0.5 W 4-speaker)
Maximum Power Output:	37 W × 4 channels at 400 Hz, Volume Control maximum
Tone adjustment range:	
Bass:	± 12 dB at 100 Hz
Treble:	± 12 dB at 10 kHz
Power Output:	18 W per channel into 4 ohms, 40 to 30 000 Hz at 3 % THD
Suitable Speaker Impedance:	4-8 Ω
Dimensions (W × H × D):	7" × 1-15/16" × 6-1/10" (178 × 50 × 160 mm)
Weight:	3 lbs. 12 oz (1.7kg)

□ FM Stereo Radio

Frequency Range:	87.9-107.9 MHz
Useable Sensitivity:	12 dBf. (1.1 μV/ 75 Ω, S/N 30 dB)
50 dB Quieting Sensitivity:	17 dBf. (1.8 μV/ 75 Ω)
Frequency Response:	30-15 000 Hz ±3 dB
Alternate Channel Selectivity:	75 dB
Stereo Separation:	35 dB at 1 kHz
Signal/Noise Ratio:	70 dB (Mono)

□ AM Radio

Frequency range:	530 kHz–1 710 kHz
Usable sensitivity:	28 dB/μV (25 μV, S/N 20 dB)

□ Weather Band Radio

Frequency range:	162.40 –162.55 MHz
Usable sensitivity:	3 dB/μV (S/N 20 dB)
Signal/Noise Ratio (40 dB/μV):	50 dB

□ CD Player

Sampling Frequency:	32 times over sampling
DA Converter:	MASH•1 bit/4 DAC System
Error Correction System:	Panasonic Super Decoding Algorithm
Pick-Up Type:	1-beam
Light Source:	Semiconductor laser
Wavelength:	780 nm
Frequency Response:	20 - 20,000 Hz (±1 dB)
Signal to Noise Ratio:	85 dB
Total Harmonic Distortion:	0.01 % (1 kHz)
Wow and Flutter:	Below measurable limits
Channel Separation:	75 dB

Above specifications comply with EIA standards.

Note: Specifications and the design are subject to modification without notice due to improvements in technology.

MEMO

YFM284C482ZA TAMAC00405-0 Printed in Taiwan

Free Manuals Download Website

<http://myh66.com>

<http://usermanuals.us>

<http://www.somanuals.com>

<http://www.4manuals.cc>

<http://www.manual-lib.com>

<http://www.404manual.com>

<http://www.luxmanual.com>

<http://aubethermostatmanual.com>

Golf course search by state

<http://golfingnear.com>

Email search by domain

<http://emailbydomain.com>

Auto manuals search

<http://auto.somanuals.com>

TV manuals search

<http://tv.somanuals.com>