

Panasonic®

Removable Front Panel CD Player/Receiver
Récepteur/lecteur CD avec panneau avant amovible
Reproductor de CD/Receptor y Panel Frontal Removable

CQ-C1200U/C1120U CQ-C1110U/C1100U

Operating Instructions Manuel d'instructions Manual de instrucciones



(CQ-C1200U)



**Panasonic Consumer
Electronics Company, Division
of Matsushita Electric
Corporation of America**
One Panasonic Way, Secaucus,
New Jersey 07094
<http://www.panasonic.com>

**Panasonic Sales Company,
Division of Matsushita Electric
of Puerto Rico, Inc. ("PSC")**
Ave. 65 de Infanteria, Km. 9.5
San Gabriel Industrial Park,
Carolina, Puerto Rico 00985
<http://www.panasonic.com>

Panasonic Canada Inc.
5770 Ambler Drive,
Mississauga, Ontario
L4W 2T3
<http://www.panasonic.ca>

YFM284C404ZA TAMACO1103-0

Printed in China
Imprimé en Chine
Impreso en China

Download from [Www.Somanuals.com](http://www.Somanuals.com). All Manuals Search And Download.

COMPACT
disc
DIGITAL AUDIO

- Please read these instructions carefully before using this product and keep this manual for future reference.
- Prière de lire ces instructions attentivement avant d'utiliser le produit et garder ce manuel pour l'utilisation ultérieure.
- Lea con atención estas instrucciones antes de utilizar el producto y guarde este manual para poderlo consultar en el futuro.

Safety Information

WARNING:

TO REDUCE THE RISK OF FIRE OR ELECTRIC SHOCK OR PRODUCT DAMAGE, DO NOT EXPOSE THIS APPLIANCE TO RAIN, SPLASHING, DRIPPING OR MOISTURE.

CAUTION!

THIS PRODUCT UTILIZES A CLASS I LASER. USE OF CONTROLS OR ADJUSTMENTS OR PERFORMANCE OF PROCEDURES OTHER THAN THOSE SPECIFIED HEREIN MAY RESULT IN HAZARDOUS RADIATION EXPOSURE. DO NOT OPEN COVERS AND DO NOT REPAIR YOURSELF. REFER SERVICING TO QUALIFIED PERSONNEL.

Laser products:

Wave length: 780 nm

Laser power: No hazardous radiation is emitted with safety protection.

CAUTION:

PLEASE FOLLOW THE LAWS AND REGULATIONS OF YOUR STATE, PROVINCE OR COUNTRY FOR INSTALLATION OF THE UNIT.

The following applies only in the U.S.A.

Part 15 of the FCC Rules
FCC Warning:

Any unauthorized changes or modifications to this equipment would void the user's authority to operate this device.

NOTICE:

This product contains lead in some components. Disposal of these materials may be regulated in your community due to environmental considerations.

For disposal or recycling information please contact your local authorities, or the Electronics Industries Alliance: <<http://www.eiae.org>>

Find the model number and serial number on either the back or bottom of the unit. Please record them in the space below and retain this booklet as a permanent record of your purchase to help with identification in case of theft.

MODEL NUMBER CQ-C1200U/C1120U/C1110U/C1100U SERIAL NUMBER _____
DATE PURCHASED _____ FROM _____

Consignes de sécurité

AVERTISSEMENT:

AFIN DE LIMITER LES RISQUES D'INCENDIE OU D'ÉLECTROCUTION OU ENCORE D'ENDOMMAGEMENT DE L'APPAREIL, N'EXPOSEZ PAS CET APPAREIL À LA PLUIE, AUX ÉCLABOUSSURES D'EAU OU À L'HUMIDITÉ.

ATTENTION!

CET APPAREIL EST UN PRODUIT LASER DE LA CLASSE I. L'UTILISATION DE COMMANDES OU RÉGLAGES OU L'EXÉCUTION D'OPÉRATIONS AUTRES QUE CELLES QUI SONT INDIQUÉES DANS CE DOCUMENT PEUVENT RÉULTER EN UNE EXPOSITION À UN RAYONNEMENT DANGEREUX. N'OUVREZ PAS LES COUVERCLES ET N'ESSAYEZ PAS D'EFFECTUER VOUS-MÊME DES RÉPARATIONS. ADRESSEZ-VOUS À UN PERSONNEL QUALIFIÉ POUR TOUTE RÉPARATION.

Produits laser:

Longueur d'onde: 780 nm

Puissance du laser: Aucune radiation dangereuse n'est émise avec la protection de sécurité.

ATTENTION:

OBSERVEZ LES LOIS ET RÉGLEMENTS DE VOTRE PROVINCE OU PAYS POUR L'INSTALLATION DE L'APPAREIL.

Il est recommandé de noter, dans l'espace prévu ci-dessous, les numéros de modèle et de série inscrits soit à l'arrière soit sous le fond de l'appareil, et de conserver ce manuel comme mémorandum de l'achat afin de permettre l'identification de l'appareil en cas de vol.

NUMÉRO DE MODÈLE CQ-C1200U/C1120U
CQ-C1110U/C1100U

NUMÉRO DE SÉRIE _____
DATE DE L'ACHAT _____
VENDEUR _____

Información para su seguridad

ADVERTENCIA:

PARA REDUCIR EL PELIGRO DE INCENDIOS Y DE DESCARGAS ELÉCTRICAS ASÍ COMO DE DAÑOS DEL PRODUCTO, NO LO EXPONGA A LA LLUVIA, A SALPICADURAS, CONDENSACIÓN DE AGUA NI HUMEDAD.

¡PRECAUCIÓN!

ÉSTE ES UN PRODUCTO LÁSER DE LA CLASE I. LA UTILIZACIÓN DE CONTROLES, EL HACER AJUSTES O EL SEGUIR PROCEDIMIENTOS DISTINTOS DE LOS ESPECIFICADOS EN ESTE MANUAL PODRÍA CAUSAR UNA EXPOSICIÓN PELIGROSA A LA RADIACIÓN. NO ABRA LAS CUBIERTAS NI HAGA REPARACIONES USTED MISMO. SOLICITE LOS TRABAJOS DE SERVICIO AL PERSONAL CALIFICADO.

Productos láser:

Longitud de onda: 780 nm

Potencia láser: Con protección de seguridad no se emite radiación peligrosa.

PRECAUCIÓN:

RESPETE LAS LEYES Y REGULACIONES DE SU ESTADO, PROVINCIA O PAÍS PARA LA INSTALACIÓN DEL APARATO.

Lo siguiente se aplica solamente a los EE.UU.

Parte 15 de los Reglamentos FCC
Advertencia FCC:

Cualesquier cambios o modificaciones sin autorización a este equipo puede anular la autoridad del usuario para operar este dispositivo.

AVISO:

Este producto contiene plomo en algunos componentes. La eliminación de estos materiales puede estar reglamentado en su comunidad debido a las consideraciones ambientales. Para informarse acerca de la eliminación o reciclaje comuníquese con las autoridades locales, o la Alianza de Industrias Electrónicas: <<http://www.eiae.org>>

Busque el número del modelo y el número de serie ya sea en la parte trasera o en el fondo de la unidad. Sírvase anotar dichos números en el espacio siguiente, y mantenga este manual como una anotación permanente de su compra para ayudar a la identificación en el caso de robo.

NÚMERO DEL MODELO CQ-C1200U/C1120U
CQ-C1110U/C1100U

NÚMERO DE SERIE _____
FECHA DE COMPRA _____
NOMBRE DE LA TIENDA _____

Panasonic welcomes you to our ever growing family of electronic product owners. We know that this product will bring you many hours of enjoyment. Our reputation is built on precise electronic and mechanical engineering, manufactured with carefully selected components and assembled by people who take pride in their work. Once you discover the quality, reliability, and value we have built into this product, you too will be proud to be a member of our family.

Use this Product Safely

When Driving

Keep the volume level low enough to be aware of road and traffic conditions.

When Washing Your Car

Do not expose the product, including the speakers and CDs, to water or excessive moisture. This could cause electrical shorts, fire, or other damage.

When Parked

Parking in direct sunlight can produce very high temperatures inside your car. Give the interior a chance to cool down before switching the unit on.

Use the Proper Power Supply

This product is designed to operate with a 12 DC, negative ground battery system (the normal system in a North American car).

Disc Mechanism

Do not insert coins or any small objects. Keep screwdrivers and other metallic objects away from the disc mechanism and disc.

Use Authorized Servicenters

Do not attempt to disassemble or adjust this precision product. Please refer to the Servicenter list included with this product for service assistance.

For Installation

The product should be installed in a horizontal position with the front end up at a convenient angle, but not more than 30°.

Accessories

The numbers in parentheses indicate order numbers. In case that any of these parts is/are missing, please inform your dealer of the number(s) and its name(s).

- Operating Instructions (YFM284C404ZA) 1
- Removable face plate case (YFC054C061ZA)..... 1
- Installation Hardware 1 set (⇒ page 28)
- Remote Control Unit **Only for CQ-C1200U/C1120U/C1110U** (YEFX9992013B)..... 1
- CR2025 Lithium Battery **Only for CQ-C1200U/C1120U/C1110U** 1
- Warranty Card 1

Features

- CD-R/CD-RW playable
- New simple-setting tone control "SQ" (Sound Quality) (⇒ page 12)
- 4-channel high power amplifier
(50 W x 4 max. for CQ-C1200U/C1120U, 45 W x 4 max. for CQ-C1110U/C1100U)
- 2.5 V preamplifier outputs (front (excluding CQ-C1100U), rear)
- 2.5 V Sub-woofer output (only for CQ-C1200U)
- 18 FM and 6 AM presets with preset scan (⇒ page 14)
- Anti-theft system provided by the removable faceplate (⇒ page 19)

*Panasonic est heureuse de vous compter parmi les utilisateurs de ses appareils électroniques. Nous pouvons vous assurer que cet appareil vous procurera de longues heures d'agrément. Notre réputation est fondée sur une ingénierie électronique et mécanique de haute précision, laquelle préside à la fabrication d'appareils ne comportant que des composants de choix assemblés par un personnel soucieux de la bonne réputation acquise par la qualité de son travail. Après avoir découvert la qualité, la valeur et la fiabilité de cet appareil, vous aussi serez fier d'être un client **Panasonic**.*

Précautions à prendre

Au volant

Réglez le volume à un niveau qui ne risque pas de masquer les bruits ambiants.

Lavage de la voiture

Afin de prévenir tout risque de court-circuit ou d'incendie, n'exposez pas l'équipement, y compris les haut-parleurs et les disques, à l'eau ou à une humidité excessive.

Voiture stationnée

L'habitacle d'une voiture immobile exposée au soleil toutes vitres fermées devient rapidement très chaud. Laissez rafraîchir l'intérieur du véhicule avant d'utiliser l'appareil.

Source d'alimentation

Cet appareil est conçu pour fonctionner sur un système d'alimentation avec batterie de 12 V c.c. à masse négative (système standard sur les voitures de construction nord-américaine).

Accessoires

Les caractères entre parenthèses représentent le code à spécifier d'une commande. Au cas où l'une de ces pièces serait manquante, veuillez informer votre revendeur de ce code et du nom de pièce.

- Manuel d'instructions (YFM284C404ZA) 1
- Étui de rangement du panneau avant amovible (YFC054C061ZA) 1
- Matériel d'installation..... 1 ensemble (⇒ page 50)
- Télécommande **Uniquement pour les modèles CQ-C1200U/C1120U/C1110U** (YEFX9992013B) 1
- Pile au lithium CR2025 **Uniquement pour les modèles CQ-C1200U/C1120U/C1110U** 1
- Carte de garantie 1

Caractéristiques

- Lecture des CD-R/CD-RW
- Nouvelle commande de tonalité à réglage simple "SQ" (⇒ page 34)
- Amplificateur de puissance élevée à 4 canaux
(50 W x 4 max. pour modèles CQ-C1200U/C1120U, 45 W x 4 max. pour modèles CQ-C1110U/C1100U)
- Sortie du préamplificateur de 2,5 V (avant (sauf CQ-C1100U), arrière)
- Sortie d'extrêmes-graves de 2,5 V (uniquement pour le CQ-C1200U)
- 18 canaux FM prédéfinis et 6 canaux AM prédéfinis avec balayage des canaux prédéfinis (⇒ page 36)
- Système antivol prévu par un panneau avant amovible (⇒ page 41)

Panasonic le da la bienvenida a la familia constantemente en aumento de poseedores de productos electrónicos. Nos esforzamos en proporcionarle las ventajas de la ingeniería mecánica y electrónica de precisión, de una fabricación con componentes cuidadosamente seleccionados, y de un montaje realizado por personas orgullosas de la reputación que su trabajo ha cimentado para nuestra empresa. Estamos seguros de que este producto le proporcionará muchas horas de distracción y, una vez comprobada la calidad, el valor y la fiabilidad incorporados, usted también se sentirá orgulloso de pertenecer a nuestra familia.

❑ Uso de este equipo con seguridad

Quando conduzca

Mantenga el nivel del volumen suficientemente bajo para estar atento a la carretera y a las condiciones del tráfico.

Quando lave el automóvil

No exponga el equipo, incluyendo los altavoces y los CDs, al agua o a una humedad excesiva. Esto puede causar cortocircuitos eléctricos, incendios u otros daños.

Quando esté estacionado

El estacionamiento a la luz solar directa puede producir temperaturas muy altas en el interior de su vehículo. Procure enfriar el interior antes de encender la unidad.

Uso de la alimentación apropiada

Este equipo ha sido diseñado para funcionar con un sistema de batería de 12 V CC con negativo a masa (el sistema normal en un vehículo norteamericano).

❑ Accesorios

• Los números entre paréntesis indican los números de pedido. En caso de faltar alguna de estas partes, informe el número y el nombre correspondientes a su distribuidor.

- Manual de Instrucciones (YFM284C404ZA).....1
- Estuche de la placa frontal extraíble (YFC054C061ZA).....1
- Accesorios suministrados1 juego (⇒ página 72)
- Unidad del controlador remote **Sólo para CQ-C1200U/C1120U/C1110U** (YEFX9992013B).....1
- CR2025 Pila de litio **Sólo para CQ-C1200U/C1120U/C1110U**1
- Tarjeta de garantía.....1

❑ Características

- Reproducción CD-R/CD-RW
- Control de tono de ajuste simple "SQ" (Sound Quality) (⇒ página 56)
- Amplificador de alta potencia de 4 canales
(50 W x 4 máx. para CQ-C1200U/C1120U, 45 W x 4 máx. para CQ-C1110U/C1100U)
- Salida de preamplificador 2,5 V (delantero (excluyendo el modelo CQ-C1100U), trasero)
- Salida de altavoz de graves secundario 2,5 V (solamente para el modelo CQ-C1200U)
- 18 FM y 6 FM preajustes con exploración de preajuste (⇒ página 58)
- Sistema antirrobo provisto por el panel frontal extraíble (⇒ página 63)

Mecanismo de disco

No inserte monedas ni ningún objeto pequeño. Mantenga los destornilladores u otros objetos metálicos apartados del mecanismo de disco y del disco.

Uso de los centros de servicio autorizados

No intente desmontar ni ajustar este equipo de precisión. Consulte la lista de centros de servicio incluidos con este producto para acudir a ellos cuando sea necesario.

Instalación

La unidad deberá instalarse en posición horizontal, con el extremo delantero hacia arriba formando un ángulo conveniente, pero con no más de 30°.

Differences among 4 models

Note: This operating instruction manual is for 4 models CQ-C1200U, CQ-C1120U, CQ-C1110U and CQ-C1100U. All illustrations throughout this manual represent model CQ-C1200U unless otherwise specified. The following table describes the differences among 4 models.

Features				
Models	CQ-C1200U	CQ-C1120U	CQ-C1110U	CQ-C1100U
Maximum power output	50 W	50 W	45 W	45 W
Preamp output connector	Rear/Front	Rear/Front	Rear/Front	Rear
Remote control unit	Included	Included	Included	Not applicable
Sub-Woofer output	Yes	No	No	No
Illumination color for D-M /REP/◀◀/▶▶	Blue	Blue	Red	Red

Différences entre les 4 modèles

Remarque: Ce mode d'emploi a été rédigé pour les trois modèles suivants: CQ-C1200U, CQ-C1120U, CQ-C1110U et CQ-C1100U. Toutes les illustrations qui apparaissent tout au long de ce manuel représentent le modèle CQ-C1200U sauf indication contraire. Le tableau ci-dessous mentionne les différences qui existent entre les 4 modèles.

Caractéristiques				
Modèles	CQ-C1200U	CQ-C1120U	CQ-C1110U	CQ-C1100U
Puissance de sortie maximum	50 W	50 W	45 W	45 W
Connecteur de sortie de préamplificateur	Arrière/avant	Arrière/avant	Arrière/avant	Arrière
Télécommande	Incluse	Incluse	Incluse	Non applicable
Sortie d'extrêmes-graves	Oui	Non	Non	Non
Couleur d'éclairage pour D-M /REP/◀◀/▶▶	Bleu	Bleu	Rouge	Rouge

Diferencia entre los 4 modelos

Nota: Este manual de instrucciones está preparado para 4 modelos: CQ-C1200U, CQ-C1120U, CQ-C1110U y CQ-C1100U. Todas las ilustraciones de este manual representan el modelo CQ-C1200U a menos que se indique lo contrario. La tabla siguiente indica las diferencias entre los 4 modelos.

Características				
Modelos	CQ-C1200U	CQ-C1120U	CQ-C1110U	CQ-C1100U
Potencia de alimentación máxima	50 W	50 W	45 W	45 W
Conector de salida de preamplificador	Trasero/Delantero	Trasero/Delantero	Trasero/Delantero	Trasero
Unidad de control remoto	Incluido	Incluido	Incluido	No es aplicable
Salida de altavoz de graves secundario	Sí	No	No	No
Color de iluminación para D-M /REP/◀◀/▶▶	Azul	Azul	Rojo	Rojo

Recommended optional systems

How to build the optimal audio system for you ...

It is the shortcut for getting the best quality sound to use the Panasonic audio component system. For details, please contact your local dealer or nearest Panasonic servicer.

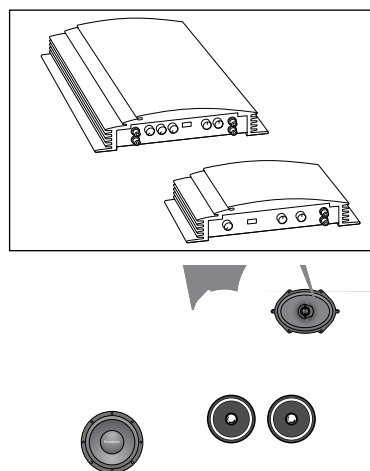

Contents







Safety Information (Part 15 of the fcc Rules)	Page 2	
Use this product safely	4	
Accessories	4	
Features	4	
Differences among 4 models	7	
Recommended optional systems	8	
<hr/>		
<input type="checkbox"/> Power and Sound Controls	12	
Power, volume, mute, display change, SQ (sound quality), audio mode (bass/treble/balance/fader/sub woofer)		
<hr/>		
<input type="checkbox"/> Clock Setting	13	
Initial time, time reset		
<hr/>		
<input type="checkbox"/> Radio	14	
Radio mode, band, manual tuning, seek tuning, direct memory, preset station setting, preset station calling, display change		
<hr/>		
<input type="checkbox"/> CD Player	16	
Disc insert and playback, stop and disc eject, listening to a CD, CD player mode, display change, pause, track selection, track search, direct track selection, repeat play, random play, scan play		
<hr/>		
<input type="checkbox"/> Remote Control Unit	18	
Only for CQ-C1200U/C1120U/C1110U		
Battery installation, battery notes, control reference guide		
<hr/>		
<input type="checkbox"/> Anti-Theft System	19	
Remove the removable face plate, place the removable face plate into case, install removable face plate		
<hr/>		
<input type="checkbox"/> Troubleshooting	20	
Preliminary steps, if you suspect something wrong, troubleshooting tips, error display messages, product servicing, replace the fuse		
<hr/>		
<input type="checkbox"/> Maintenance	24	
Care of the unit, notes on discs, notes on CD-Rs/RWs		
<hr/>		
<input type="checkbox"/> Installation	25	
Overview, required tools, dashboard specifications, identify all leads, connect all leads, final installation, final checks, preparation, dashboard installation, installation hardware		
<hr/>		
<input type="checkbox"/> Electrical Connections	30	
<hr/>		
<input type="checkbox"/> To Remove the Unit	32	
<hr/>		
<input type="checkbox"/> Specifications	33	

Table des matières

Consignes de sécurité	Page 3
Précautions à prendre	5
Accessoires	5
Caractéristiques	5
Différences entre les 4 modèles	7
Chaînes optionnelles recommandées	8

<input type="checkbox"/> Commandes d'alimentation et de son	34
Alimentation, volume, coupure du son, SQ, changement d'affichage, mode audio (graves/aigus/balance/équilibre/extrêmes-graves)	

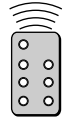

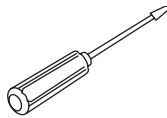
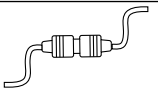
<input type="checkbox"/> Réglage de l'horloge	35
Heure initiale, pour ajuster l'heure à nouveau	

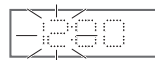

<input type="checkbox"/> Radio	36
Mode radio, bande, syntonisation manuelle, syntonisation par recherche, mémoire directe, réglage des stations présyntonisées, appel de station présyntonisée, changement d'affichage	



<input type="checkbox"/> Lecteur CD	38
Insertion de disque et lecture, arrêt et éjection de disque, écoute d'un disque CD, mode de lecteur de CD, changement d'affichage, pause, sélection de plages, sélection directe de plages, lecture répétée, lecture aléatoire, lecture des débuts de plage	



<input type="checkbox"/> Préparatifs de la télécommande	40
Uniquement pour les modèles CQ-C1200U/C1120U/C1110U	
Installation de la pile, remarques sur la pile, guide des commandes	

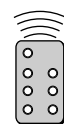

<input type="checkbox"/> Système antivol	41
Retrait du panneau avant amovible, mise en place du panneau avant amovible dans l'étui, installation du panneau avant amovible	

<input type="checkbox"/> En cas de difficulté	42
Étapes préliminaires, lorsqu'on soupçonne que quelque chose est défectueux, guide de dépannage, messages d'erreur affichés, service après-vente de l'appareil, remplacement d'un fusible	



<input type="checkbox"/> Entretien	46
Entretien de l'appareil, remarques relatives aux disques, remarques relatives aux CD-R/RW	



<input type="checkbox"/> Guide d'installation	47
Généralités, outils requis, dégagement requis dans le tableau de bord, identifiez tous les fils et câbles, raccordez tous les fils, installation finale, vérifications finales, préparation, installation sur le tableau de bord, matériel d'installation	

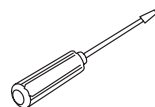

<input type="checkbox"/> Branchements électriques	52
--	----

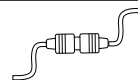

<input type="checkbox"/> Comment retirer l'appareil	54
--	----

<input type="checkbox"/> Données techniques	55
--	----

Índice

Información para su seguridad (Parte 15 de los Reglamentos FCC)	Página 3
Uso de este equipo con seguridad	6
Accesorios	6
Características	6
Diferencia entre los 4 modelos	7
Sistemas opcionales recomendados	8

<input type="checkbox"/> Controles de alimentación y sonido	56
Alimentación, volumen, silenciamiento, cambio de pantalla, SQ (sound quality), modo de audio (graves/agudos/balance derecho-izquierdo/balance delantero-trasero/altavoz de subgraves)	



<input type="checkbox"/> Ajuste del reloj	57
Hora inicial, reajuste de hora	



<input type="checkbox"/> Radio	58
Modo de la radio, banda, sintonización manual, sintonización de búsqueda, memoria directa, ajuste de emisoras presintonizadas, llamada de emisoras presintonizadas, cambio de pantalla	

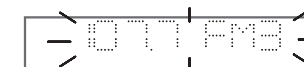

<input type="checkbox"/> Reproductor de CD	60
Insertión y reproducción del disco, parada y expulsión del disco, para escuchar un CD, Modo de reproducción de CD, cambio de pantalla, pausa, selección de pista, selección directa de pista, búsqueda de pista, repetición de reproducción, reproducción aleatoria, reproducción por exploración	



<input type="checkbox"/> Preparación del controlador remoto	62
Sólo para CQ-C1200U/C1120U/C1110U	
Sustitución de la pila, notas sobre la pila, guía de referencia de control	



<input type="checkbox"/> Sistema antirobo	63
Vuelva a ajustar el panel delantero, coloque la placa frontal extraíble en la caja, instale la placa frontal extraíble	

<input type="checkbox"/> Solución de problemas	64
Pasos preliminares, si cree que hay algo que no funciona bien, consejos para localizar y solucionar averías, mensajes de visualización de error, servicio técnico del producto, reemplazo del fusible	



<input type="checkbox"/> Mantenimiento	68
Cuidado del aparato, notas sobre los discos, notas sobre discos CD-R/RW	



<input type="checkbox"/> Guía de instalación	69
Perspectiva general, herramientas necesarias, especificaciones del salpicadero, identificación de todos los conductores, conexión de todos los conductores, instalación final, comprobaciones finales, preparación, Instalación en el tablero de instrumentos, accesorios suministrados	



<input type="checkbox"/> Conexiones eléctricas	74
---	----

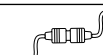

<input type="checkbox"/> Para extraer el aparato	76
---	----

<input type="checkbox"/> Especificaciones	77
--	----

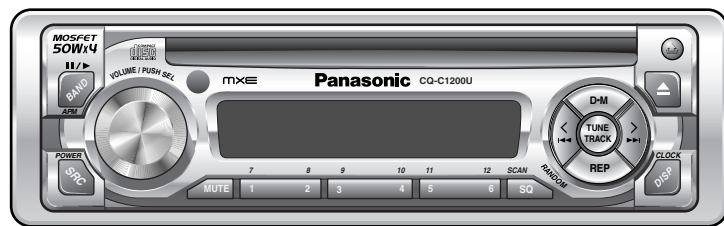

Note: If no operation takes place for more than 5 seconds in audio mode (2 seconds in volume mode), the display returns to the regular mode.

Audio Mode (Bass/Treble/Balance/Fader/Sub Woofer)

① Push [SEL] to select the audio mode.

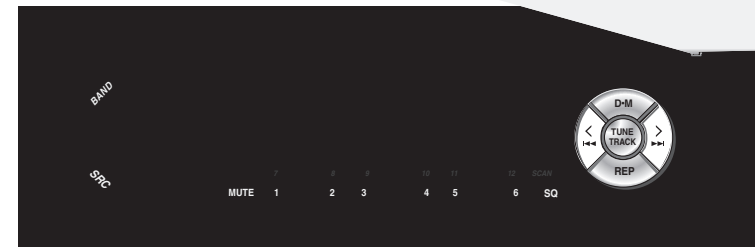
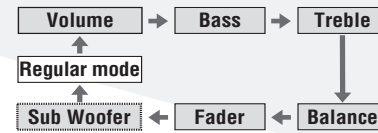

Clock Setting

The 12-hour system is used for the clock.

Initial Time

① Press [DISP] (clock).



"AdJ" is displayed when the clock is not adjusted.

Bass:



Adjustable range: -12 to +12 (by 2 dB step)

Treble:



Adjustable range: -12 to +12 (by 2 dB step)

Balance:

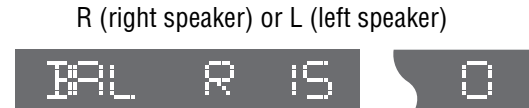

R (right speaker) or L (left speaker)

Fader:

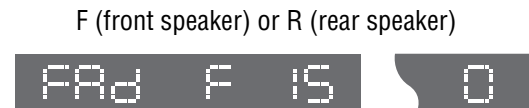

F (front speaker) or R (rear speaker)



Hours

② Press and hold [DISP] (clock) for more than 2 seconds.



③ Press [< TUNE] or [> TUNE].



Minutes

④ Press [DISP] (clock).



⑤ Press [< TUNE] or [> TUNE].



⑥ Press [DISP] (clock).



Note: Press and hold [< TUNE] or [> TUNE] to change numbers rapidly.

Time Reset

Press and hold [DISP] (clock) for mor4 0 TDonTj/F0 0

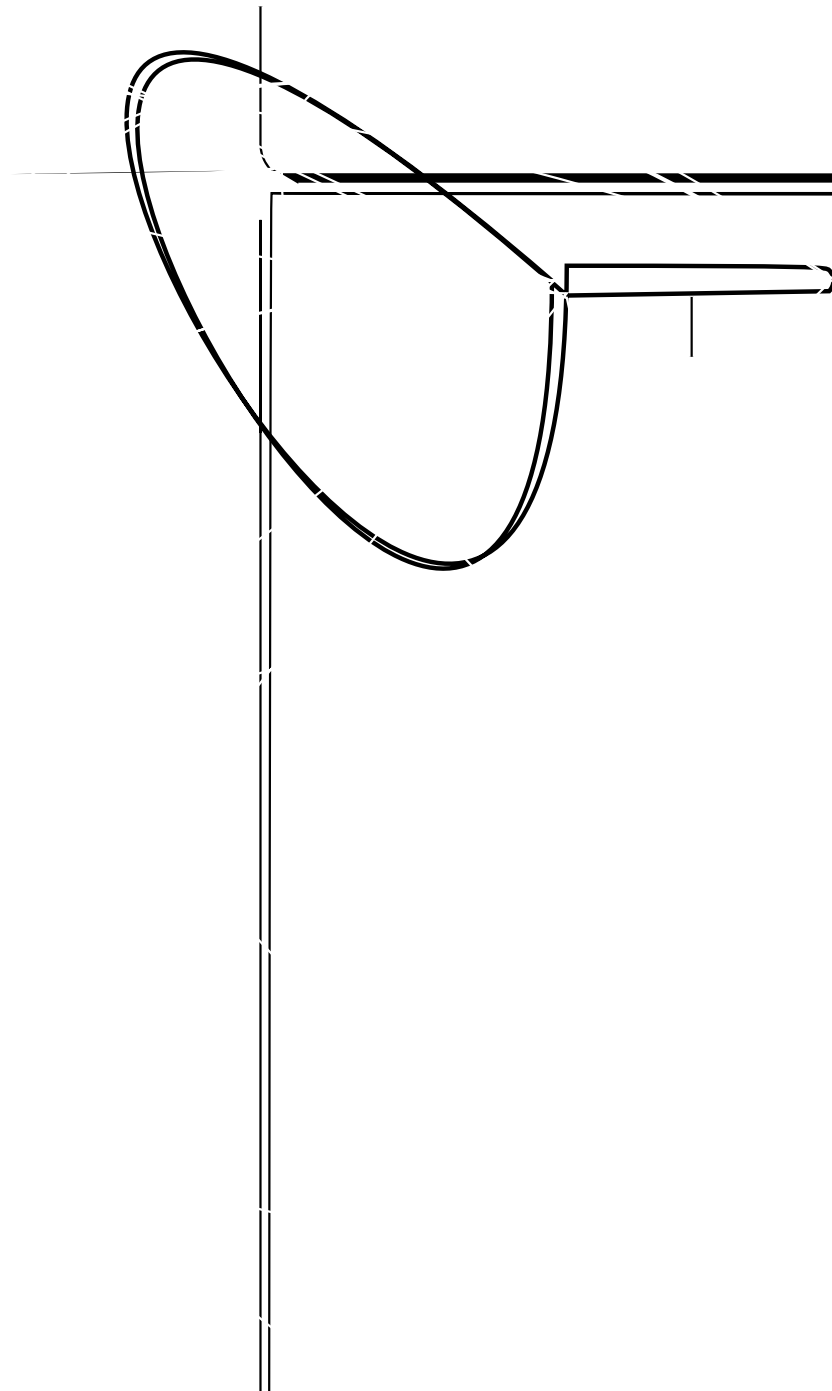
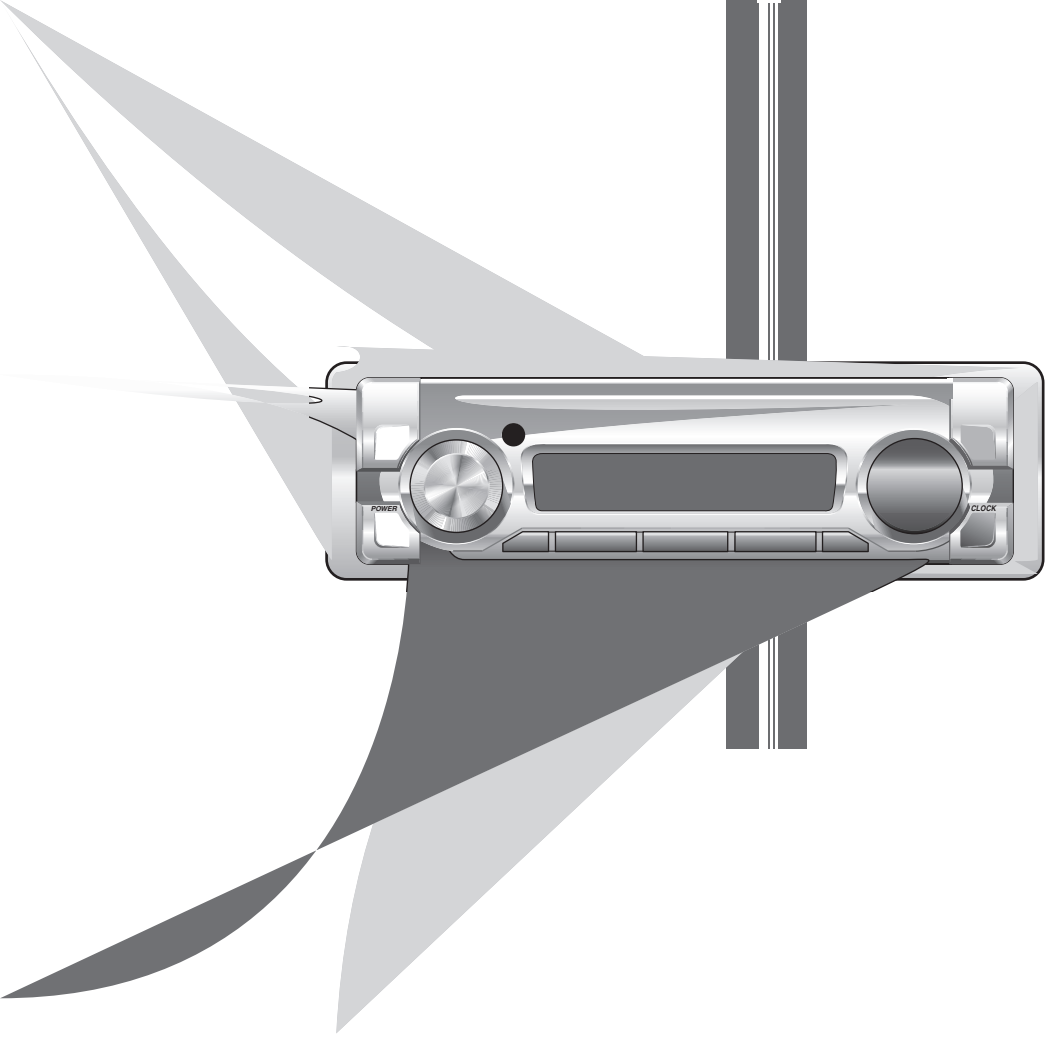

CD Player

Disc Insert and Playback

Disc insert

Playback will start automatically after the player recognized the loaded disc as an ordinary music CD. (When a CD-R or CD-RW which has CD-DA formatted data as the same as an ordinary music CD is loaded, this player recognizes it as an ordinary music CD.)

“LOAD” will be displayed until the disc is loaded.

LOAD

Notes:

- Do not insert a disc when “DISC” indicator lights.
- The power will be turned on automatically when a disc is loaded.

Stop and Disc Eject

Press [▲] (eject) to stop CD play and eject the disc. During disc ejection, “EJ” (eject) will be displayed.

Listening to a CD

CD Player Mode

Press [SRC] (source) to change to the CD play mode. Playback will start automatically when a disc is loaded.

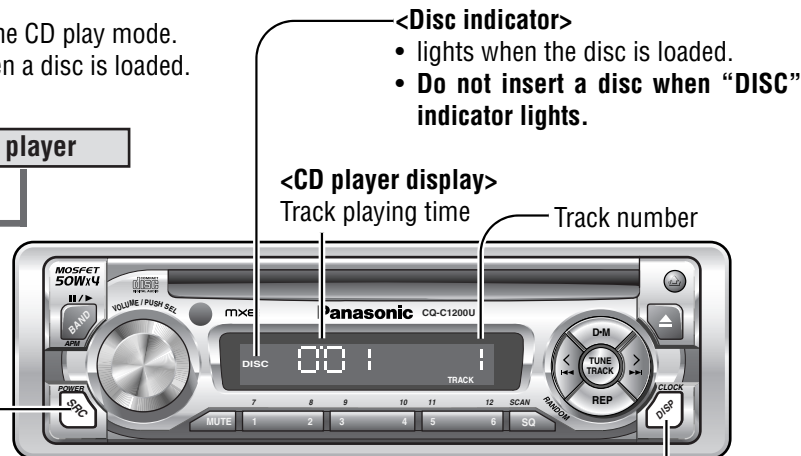
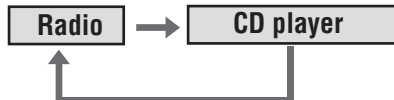

Display Change

Press [DISP] (display) to switch to the clock display.

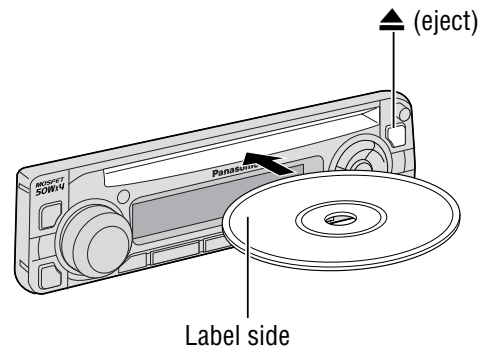
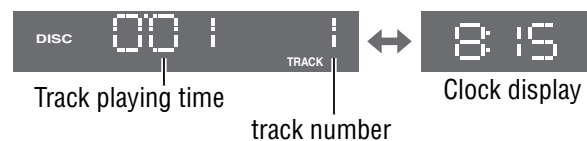

Cautions:

- Only 5" (12 cm) CD, CD-DA data recorded CD-R and CD-RW discs are available for this unit.
- This unit does not support CD text display.
- This unit does not support MP3 and WMA disc playback.
- Refer to page 24 about notes on CD-Rs/RWs.
- This unit is not designed for any 3" (8 cm) disc.
- If you insert an 3" (8 cm) disc and can not eject it, turn ACC of your car off once and turn it on again, then press [▲] (eject).
- Do not use irregularly shaped discs.
- Do not use discs that have a seal or label attached.
- Do not insert foreign matter into the disc slot.

Pause (|| / ▶)

Press [BAND] (|| / ▶) to pause. Press [BAND] (|| / ▶) again to resume the playback.

Direct Track Selection

- Press a track number button from [1] to [6]. The corresponding track starts playing.
- Press and hold a track number button from [7] to [12] ([1] to [6]) for more than 1 second. The corresponding track starts playing.

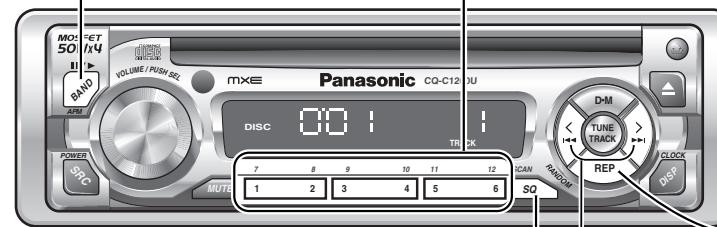

Scan Play*

Track Selection

Press [▶▶ TRACK]: Advance to the next track. Press [◀◀ TRACK]: Back to the beginning of the current track. Back to the previous track. (Press twice.)

Track Search

Press and hold ... [▶▶ TRACK]: Fast forward [◀◀ TRACK]: Fast reverse Release to resume the regular play.

Repeat play

- Press [REP]. The current track is repeated.
- Press [REP] again to cancel.



Random play

- Press and hold [REP] (RANDOM) for more than 2 seconds. All the tracks are played in random order.
- Press and hold [REP] (RANDOM) again to cancel.

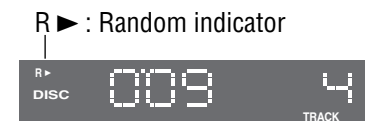

Scan play*

- Press and hold [SQ] (SCAN), for more than 2 seconds. The first 10 seconds of each track on the disc are played in sequence.
- Press and hold [SQ] (SCAN) again to cancel.



Remote Control Unit

Battery Installation

- 1 Remove the battery holder.**
Pull the battery holder by the position B while pushing position A in the direction indicated by the arrow.
- 2 Install the battery on the battery holder.**
Place a battery in the holder with its "+" side facing up as shown in the figure.
- 3 Insert the battery holder.**
Push the battery holder back into its original position.

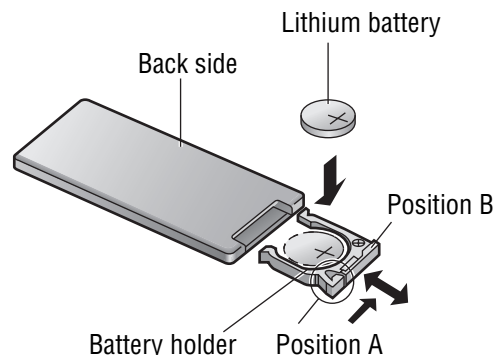

Battery Notes

Remove and dispose of an old battery immediately.

Battery Information:

- Battery type: Panasonic lithium battery (CR2025)
- Battery life: Approximately 6 months with normal use (at room temperature)

Caution: Improper use of batteries may cause overheating, an explosion or ignition, resulting in injury or a fire. Battery leakage may damage the unit.

- Do not disassemble or short the battery. Do not throw a battery into a fire.
- Keep batteries away from children to avoid the risk of accidents.
- Be careful to observe proper local disposal rules when you dispose of batteries.

Control Reference Guide

Buttons of the remote control function in the same way as the controls on the main unit of the reference page. **Point the remote control unit at the main unit's sensor.**

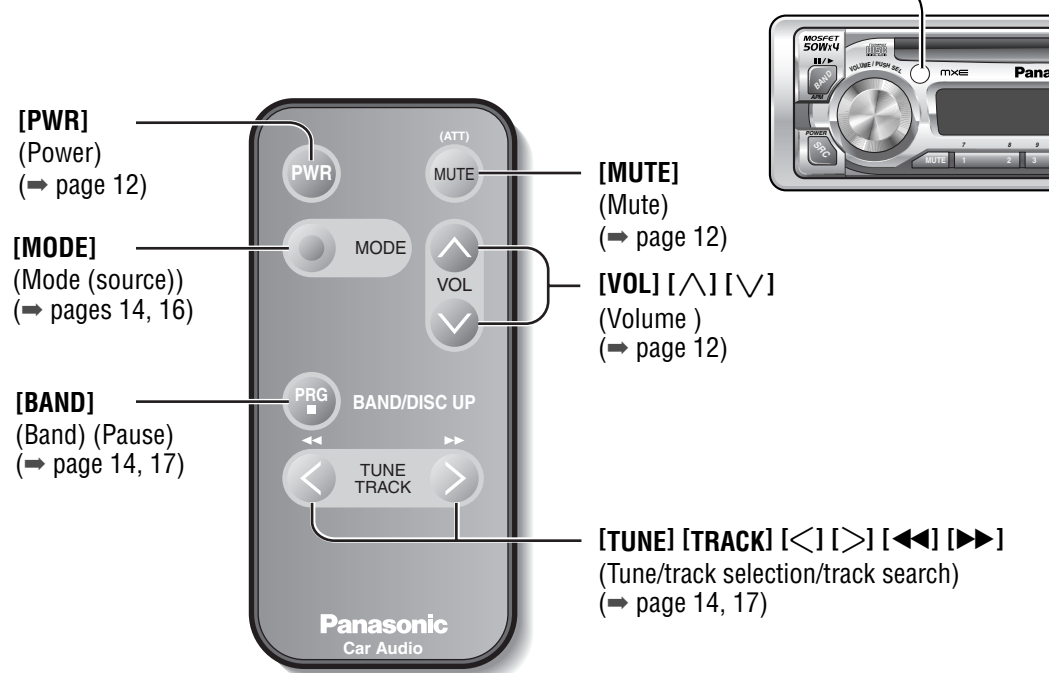

Note: CQ-C1100U has no remote control function.

Anti-Theft System

This unit is equipped with a removable face plate. Removing this face plate makes the radio totally inoperable.

1 Remove the removable face plate

Switch off the power of the unit.

Remove the removable face plate.

- 1** Press [↑]. The removable face plate will be opened.
- 2** Push the face plate to either the right or left.
- 3** Pull it out toward you.

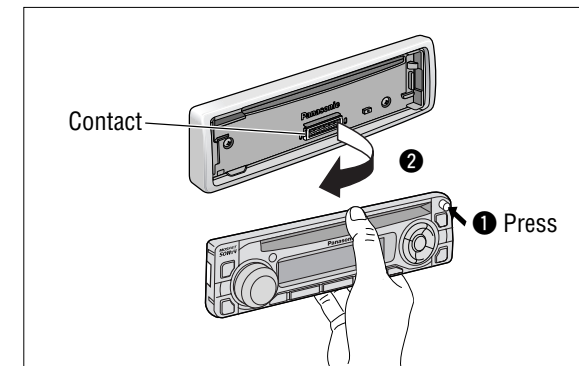

2 Place the Removable Face Plate into Case

Gently press the bottom of the case and open the cover. Place the face plate into the case and take it with you when you leave the car.

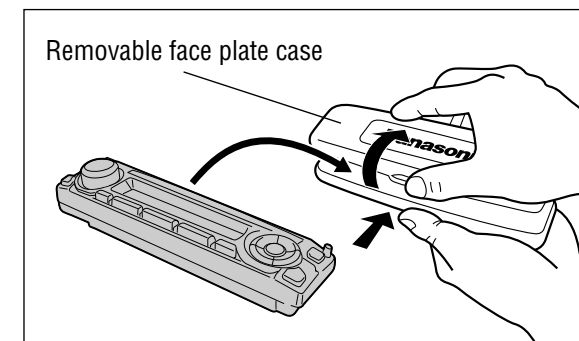

Install Removable Face Plate

- 1** Slide the left side of the removable face plate in place.
- 2** Press the right end of the removable face plate until "click" is heard.

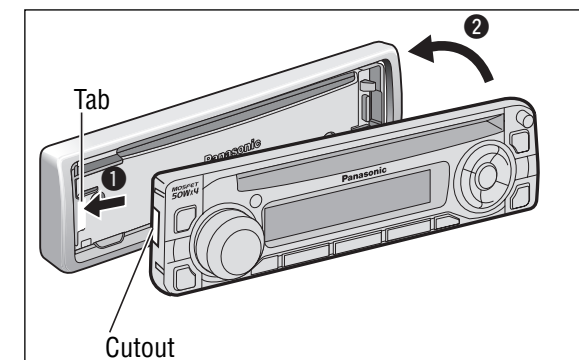

Cautions:

- This face plate is not waterproof. Do not expose it to water or excessive moisture.
- Do not remove the face plate while driving your car.
- Do not place the face plate on the dashboard or nearby areas where the temperature rises to high level.
- Do not touch the contacts on the face plate or the main unit, since this may result in poor electrical contacts.
- If dirt or other foreign substances get on the contacts, wipe them off with a clean and dry cloth.

Troubleshooting

Preliminary Steps

Check and take steps as described in the tables below.

If You Suspect Something Wrong

Immediately switch the power off.

Disconnect the power connector and check that there is neither smoke nor heat from the unit before asking for repairs. Never try to repair the unit by yourself because it is dangerous to do so.

Cautions:

- Do not use the unit if it malfunctions or if there is something wrong.
- Do not use the unit in irregular condition, for example, without sound, or with smoke or foul smell, which can cause ignition or electric shock. Immediately stop using it and call the store where you purchased it.

Troubleshooting Tips

Common

Trouble	Cause/Step
No power.	Car's ignition switch is not on. → Turn your car's ignition switch to ACC or ON.
	The power cord (battery, ACC and ground) is connected in the wrong way. → Check the wiring.
	Grounding wire is not correctly connected. → Connect the grounding wire to a metal part of the car.
No sound.	Fuse is burnt out. → Call the store where you purchased the unit, or your nearest Servicenter (see the attached sheet) and ask for fuse replacement.
	Mute is set to ON. → Set it to OFF.
	The wiring of the speaker line is not correct, or a break or poor contact arises. → Check the wiring in accordance with the wiring diagram.
Noise.	Condensation (dew). → Wait for a while before use.
	There is an electromagnetic-wave generator such as a cellular phone near the unit or its electrical lines. → Keep an electromagnetic-wave generator such as a cellular phone away from the unit and the wiring of the unit. In case that noise cannot be eliminated due to the wiring harness of the car, consult your dealer.
	Grounding wire is not correctly connected. → Connect the grounding wire to a metal part of the car.

Radio

Trouble	Cause/Step
Poor reception or noise	No power is supplied to the antenna amplifier (when using a film antenna, etc.). → Check the wiring of the antenna amplifier battery lead.
	Antenna installation or wiring of antenna cable is faulty. → Check whether the antenna mounting position and its wiring are correct. In addition, check to see whether the antenna ground is securely connected to the chassis.
The number of auto preset stations is less than 6.	The number of receivable stations is less than 6. → Move to an area where receivable stations number is maximum, and try presetting.

CD

Trouble	Cause/Step
Disc is in the CD compartment but no sound is made, or disc is ejected automatically.	The disc is inserted upside down. → Place disc in the correct direction with the label side up.
	• Disc is dirty. • Disc has scratches. → Clean disc, referring to the section on "Notes on Discs".
	A disc that has data other than CD-DA type is loaded. → Discs that have CD-DA type data should be used.
Sound skips, bad sound quality. (e.g. caused by noise)	→ The unit may not successfully play back a CD-R/RW that is made in combination of writing software, a CD recorder (CD-R/RW drive) and a disc which are incompatible one another. Refer to instructions for the concerned devices for details.
	• Disc is dirty. • Disc has scratches. → Clean disc, referring to the section on "Notes on Discs".
	→ The unit may not successfully play back a CD-R/RW that is made up of a combination of writing software, a CD recorder (CD-R/RW drive) and a disc which are incompatible with one another. Refer to instructions for the concerned devices for details.

Troubleshooting (Continued)

CD (Continued)

Trouble	Cause/Step
Sound skips due to vibration.	<p>Mounting angle is over 30°. → Adjust mounting angle to less than 30°.</p> <p>Instable mounting. → Mount the unit securely with the mounting parts, referring to the section on installation.</p>
Disc is not ejected.	<ul style="list-style-type: none"> • Disc is defective. • Mechanical trouble. → Press [▲] (eject). If normal operation is not restored, call the store where you purchased the unit or the nearest Servicenter to ask for repairs.
Time is counted but no sound comes out.	<p>The first track of a mix mode disc was reproduced. (Mix mode is a format in which data except music is recorded on the first track and music data is recorded on other than the first track in a session.)</p> → Play back music data recorded on other than the first track.

Sound Setting

Trouble	Cause/Step
No sound from left, right, front or rear speakers.	<p>Left and right balance, or front and rear balance is off on one side. → Adjust balance/fader setting as appropriate.</p> <p>Cables are not correctly connected. → Connect the cables correctly.</p>
Left and right sounds are reversed in stereo listening.	<p>The right speaker wire is connected to the left speaker and the left speaker wire to the right speaker. → Connect the speaker wires to the correct ones.</p>



Remote Control Unit

Only for CQ-C1200U/C1120U/C1110U

Trouble	Cause/Step
Buttons are invalid for operation.	<p>Battery polarities are reversed. → Insert the battery correctly.</p>
	<p>Wrong battery. → Check the battery.</p>
	<p>Battery has run down. → Replace the battery.</p>
	<p>Remote control unit is in the wrong direction. → Direct the remote control unit at sensor on the front panel.</p>

Error Display Messages

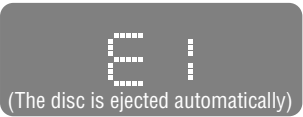
CD

Display	Cause/Step
 (The disc is ejected automatically)	<ul style="list-style-type: none"> • Disc is dirty, or is upside down. • A disc that has data other than CD-DA type is loaded. → Check the disc.
 (The disc is ejected automatically)	<p>Disc has scratches. → Check the disc.</p>
	<p>No operation by some cause. → If normal operation is not restored, call the store where you purchased the unit or the nearest Servicenter to ask for repairs.</p>

Product Servicing

If the suggestions in the charts do not solve the problem, we recommend that you take it to your nearest authorized Panasonic Servicenter. The product should be serviced only by a qualified technician.

Replace the Fuse

Use fuses of the same specified rating (15 A). Using different substitutes or fuses with higher ratings, or connecting the product directly without a fuse, could cause fire or damage to the unit.

If the replacement fuse fails, contact your nearest Panasonic Servicenter for service.

Maintenance

Care of the Unit

☐ Cleaning this Unit

Use a dry, soft cloth to wipe.

☐ Caution on Cleaning

Never use solvents such as benzine, thinner as they may mar the surface of the unit.

Notes on discs

Do not play any ordinary music CDs with labels other than this one.



How to hold the disc

- Do not touch the underside of the disc.
- Do not scratch the discs.
- Do not bend disc.
- When not in use, keep the disc in the case.

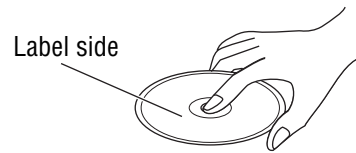

Do not use irregularly shaped discs.

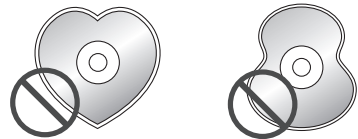

Do not use irregularly shaped discs.

<Right> <Wrong>



Do not leave discs in the following places:

- Direct sunlight
- Near car heaters
- Dirty, dusty and damp areas
- On seats and dashboards

Disc cleaning

Use a dry, soft cloth to wipe from the center outward.

Do not attach any seals or labels to your discs.

Do not write on the disc label in a heavy pen or ball-point pen stroke.

Notes on CD-Rs/RWs

- You may have trouble playing back some CD-R/RW discs recorded on CD recorders (CD-R/RW drives), either due to their recording characteristics or dirt, fingerprints, scratches, etc. on the disc surface.
- CD-R/RW discs are less resistant to high temperatures and high humidity than ordinary music CDs. Leaving them inside a car for extended periods may damage them and make playback impossible.
- The unit may not successfully play back a CD-R/RW that was made by the combination of writing software, a CD recorder (CD-R/RW drive) and a disc if they are incompatible one another.
- This player cannot play the CD-R/RW discs if the session is not closed.
- This player cannot play the CD-R/RW discs which contains other than CD-DA data.
- Be sure to observe the instructions of CD-R/RW disc for handling it.

Installation



WARNING

☐ This installation information is designed for experienced installers and is not intended for non-technical individuals. It does not contain warnings or cautions of potential dangers involved in attempting to install this product.

Any attempt to install this product in a motor car by anyone other than a qualified installer could cause damage to the electrical system and could result in serious personal injury or death.

☐ If your car is equipped with air bag and/or anti-theft systems, specific procedures may be required for connection and disconnection of the battery to install this product. Before attempting installation of this electronic component, contact your car dealer or manufacturer to determine the required procedure and strictly follow their instructions.

FAILURE TO FOLLOW THE PROCEDURE MAY RESULT IN THE UNINTENDED DEPLOYMENT OF AIR BAGS OR ACTIVATION OF THE ANTI-THEFT SYSTEM RESULTING IN DAMAGE TO THE VEHICLE AND PERSONAL INJURY.

☐ Overview

This product should be installed by a professional. However, if you plan to install this product yourself, your first step is to decide where to install it. The instructions in these pages will guide you through the remaining steps:

(Please refer to the "WARNING" statement above.)

- Identify and label the car wires.
- Connect the car wires to the wires of the power connector.
- Install the unit in the dashboard.
- Check the operation of the unit.

If you encounter problems, please consult your nearest professional installer.

Caution: This unit operates with a 12 V DC negative ground auto battery system only. Do not attempt to use it in any other system. Doing so could cause serious damage.

Before you begin installation, look for the items which are packed with your unit.

- **Warranty Card**...Fill this out promptly.
- **Panasonic Servicenter List for Service Directory**

...Keep for future reference in case the product needs servicing.

- **Installation Hardware**...Needed for in-dash installation.

☐ Required Tools

You'll need a screwdriver, a 1.5 V AA battery, and the following:

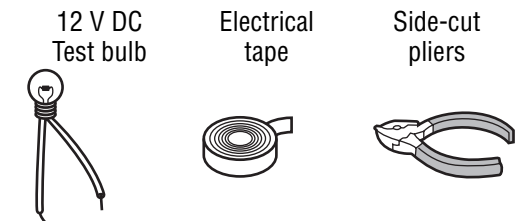

☐ Dashboard Specifications

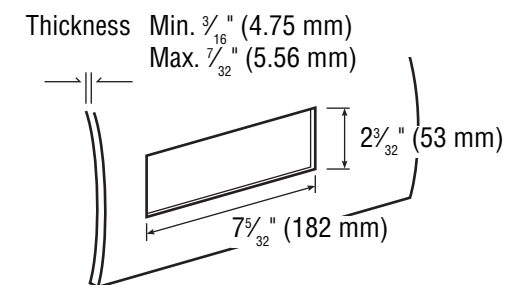

Installation (Continued)

☐ Identify All Leads

The first step in installation is to identify all the car wires you'll use when hooking up your sound system.

As you identify each wire, we suggest that you label it using masking tape and a permanent marker. This will help avoid confusion when making connections later.

Note: Do not connect the power connector to the stereo unit until you have made all connections. If there are no plastic caps on the stereo hooking wires, insulate all exposed leads with electrical tape until you are ready to use them. Identify the leads in the following order.

Power Lead

If your car has a radio or is pre-wired for one: Cut the connector wires one at a time from the plug (leaving the leads as long as possible) so that you can work with individual leads.

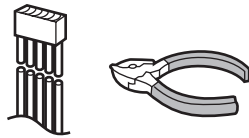

Turn the ignition on to the accessory position, and ground one lead of the test bulb to the chassis.

Touch the other lead of the test bulb to each of the exposed wires from the cut radio connector plug. Touch one wire at a time until you find the outlet that causes the test bulb to light.

Now turn the ignition off and then on. If the bulb also turns off and on, that outlet is the car power lead.

If your car is not wired for an audio unit: Go to the fuse block and find the fuse port for radio (RADIO), accessory (ACC), or ignition (IGN).

Battery Lead

If your stereo unit has a yellow lead, you will need to locate the car's battery lead. Otherwise you may ignore this procedure. (The yellow battery lead provides continuous power to maintain a clock, memory storage, or other function.)

If your car has a radio or is pre-wired for one:

With the ignition and headlights off, identify the car battery lead by grounding one lead of the test bulb to the chassis and checking the remaining exposed wires from the cut radio connector plug.

If your car is not wired for an audio unit:

Go to the fuse block and find the fuse port for the battery, usually marked BAT.

Speakers

Identify the car speaker leads. There are two leads for each speaker which are usually color coded. A handy way to identify the speaker leads and the speaker they are connected with is to test the leads using a 1.5 V AA battery as follows.

Hold one lead against one pole of the battery and stroke the other lead across the other pole. You will hear a scraping sound in one of the speakers if you are holding a speaker lead.

If not, keep testing different lead combinations until you have located all the speaker leads. When you label them, include the speaker location for each.

Antenna Motor

If your car is equipped with an automatic power antenna, identify the car motor antenna lead by connecting one bulb tester lead to the car battery lead and touching the remaining exposed wires from the cut radio connector plug one at a time. You will hear the antenna motor activate when you touch the correct wire.

Antenna

The antenna lead is a thick, black wire with a metal plug at the end.

☐ Connect All Leads

Now that you have identified all the wires in the car, you are ready to begin connecting them to the stereo unit wires. The wiring diagram (➔ page 30) shows the proper connections and color coding of the leads.

We strongly recommend that you test the unit before making a final installation.

You can set the unit on the floor and make temporary connections to test the unit. Use electrical tape to cover all exposed wires.

Caution: Connect the red power lead last, after you have made and insulated all other connections.

Ground

Connect the black ground lead of the power connector to the metal car chassis.

Speakers

Connect the speaker wires. See the wiring diagram (➔ page 30) for the proper hookups. Follow the diagram

carefully to avoid damaging the speakers and the stereo unit.

The speakers used must be able to handle more than 50 W (CQ-C1200U/C1120U)/45 W (CQ-C1110U/C1100U) of audio power. If using an optional audio amplifier, the speakers should be able to handle the maximum amplifier output power. Speakers with low input ratings can be damaged. Speaker impedance should measure 4–8 Ω, which is typically marked on most speakers. Lower or higher impedance speakers will affect output and can cause both speaker and stereo unit damage.

Motor Antenna

Connect the car motor antenna lead to the dark blue motor antenna relay control lead. (Do not confuse the antenna lead with blue/white stripe lead for a power amplifier.)

Battery

Connect the yellow battery lead to the correct radio wire or to the battery fuse port on the fuse block.

Antenna

Connect the antenna by plugging the antenna lead into the antenna receptacle.

Equipment

Connect any optional equipment such as an amplifier, according to the instructions furnished with the equipment. Leave about 12" (30 cm) of distance between the speaker leads/amplifier unit and the antenna/antenna extension cord. Read the operating and installation instructions of any equipment you will connect to this unit.

Power

Connect the red power lead to the correct car radio wire or to the appropriate fuse port on the fuse block. If the stereo unit functions properly with all these connections made, disconnect the wires and proceed to the final installation.

☐ Final Installation

Lead Connections

Connect all wires, making sure that each connection is insulated and secure. Bundle all loose wires and fasten them with tape so they will not fall down later. Now insert the stereo unit into the mounting collar. Congratulations! After making a few final checks, you're ready to enjoy your new auto stereo system.

☐ Final Checks

1. Make sure that all wires are properly connected and insulated.
2. Make sure that the stereo unit is securely held in the mounting collar.
3. Turn on the ignition to check the unit for proper operation.

If you have difficulties, consult your nearest authorized professional installer for assistance.

Installation (Continued)

Preparation

Warning: If your car is equipped with air bag and/or anti-theft systems, specific procedures may be required for connection and disconnection of the battery to install this product. Before attempting installation of this electronic component, contact your car dealer or manufacturer to determine the required procedure and strictly follow their instructions.

FAILURE TO FOLLOW THE PROCEDURE MAY RESULT IN THE UNINTENDED DEPLOYMENT OF AIR BAGS OR ACTIVATION OF THE ANTI-THEFT SYSTEM RESULTING IN DAMAGE TO THE VEHICLE AND PERSONAL INJURY.

- Disconnect the cable from the negative (-) battery terminal (see warning and caution below).
- Remove Mounting Collar ① and Trim Plate ⑦ from the main unit temporarily, which are already mounted at shipment.*

Caution: Various settings that have been stored in the memory in other on-board equipment (car navigation etc.) may be lost if the battery terminals are disconnected.

Therefore, we recommend to make a record of or to back up the settings before disconnecting the terminals. After completing installation of the main unit, set the equipment again according to the record.

- Unit should be installed in a horizontal position with the front end up at a convenient angle, but not more than 30°.

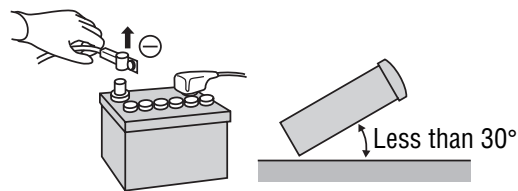

Dashboard Installation

Installation Opening

This unit can be installed in any dashboard having an opening as shown below. The dashboard should be 3/16" (4.75 mm)–7/32" (5.56 mm) thick in order to be able to support the unit.

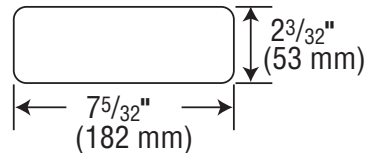

Installation Hardware

No.	Item	Diagram	Q'ty
①	Mounting Collar* (FX0214C316ZA)		1
②	Hex. nut (5 mmø) (YJN994C002ZA)		1
③	Rear support strap (YFG044C002ZA)		1
④	Tapping screw (5 mmø×16 mm) (XTT5+16AFK)		1
⑤	Mounting Bolt (5 mmø) (YEJV014C002A)		1
⑥	Power Connector (YEAJ02877)		1
⑦	Trim Plate* (YFC054C063ZA)		1
⑧	Dismounting Plate (YFX214C323ZA)		2

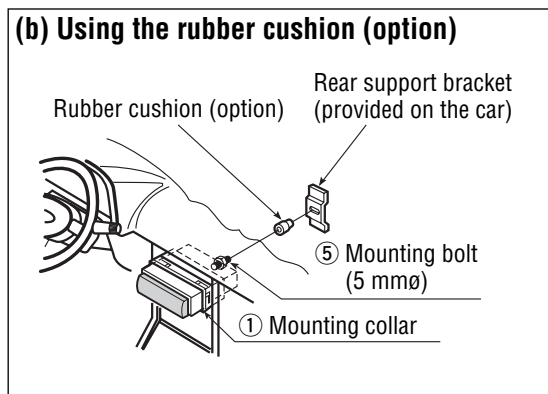
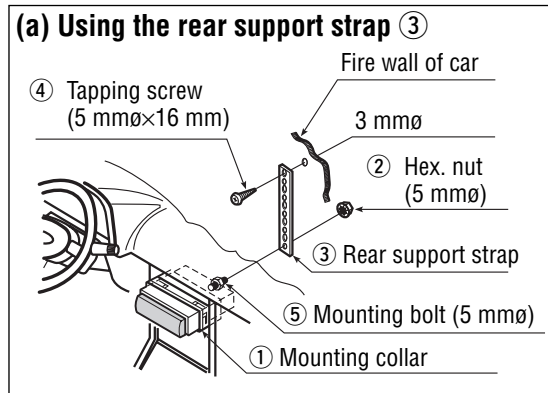

Cautions:

- We strongly recommend that you wear gloves for installation work to protect yourself from injuries.
- When bending the mounting tab of the mounting collar with a screwdriver, be careful not to injure your hands and fingers.

First complete the electrical connections, and then check them for correctness. (→ page 30)

The included Mounting Collar ① is designed specially for this unit. Do not use it to attach any other model.

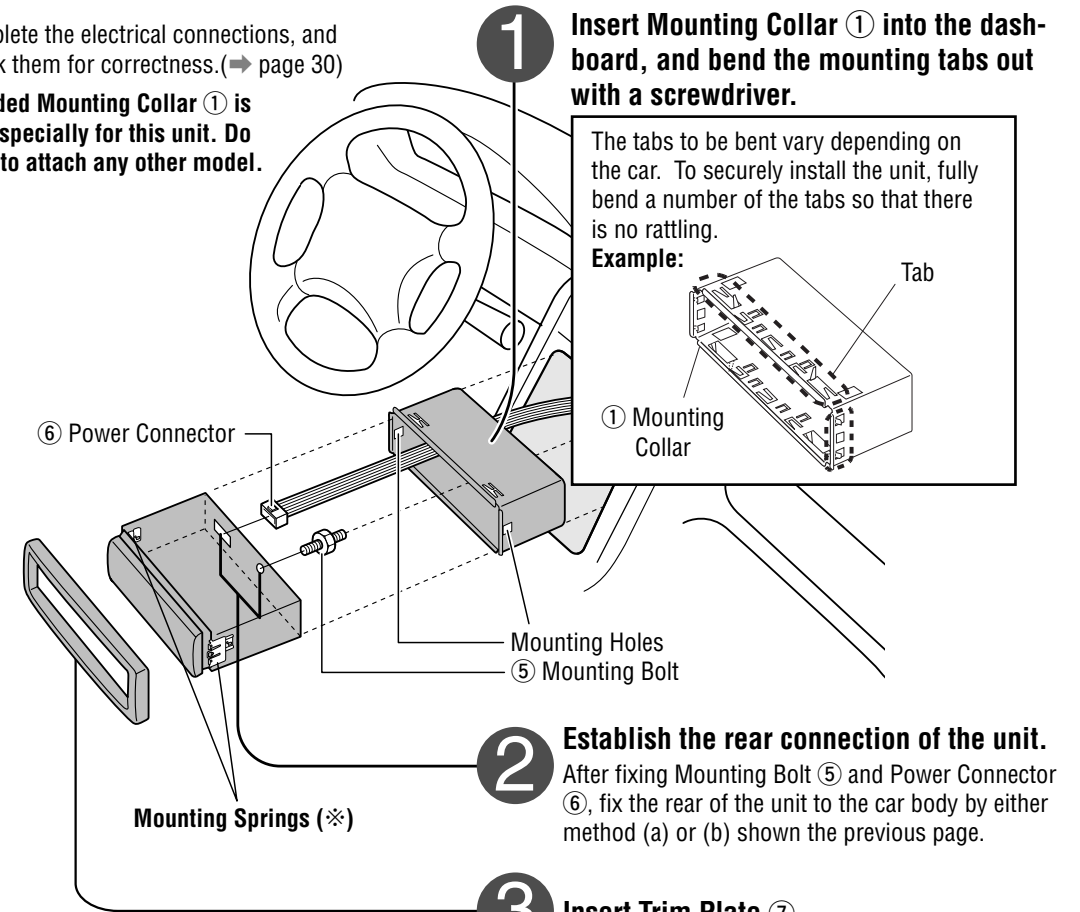

The tabs to be bent vary depending on the car. To securely install the unit, fully bend a number of the tabs so that there is no rattling.

Example:

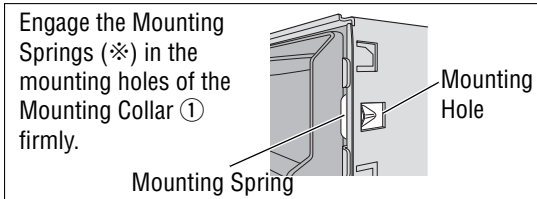
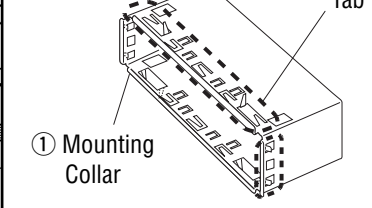

1 Switch off the power of the unit.

2 Remove the removable face plate.

- 1 Press [↑]. The removable face plate will be opened.
- 2 Push the face plate to either the right or left.
- 3 Pull it out towards you.

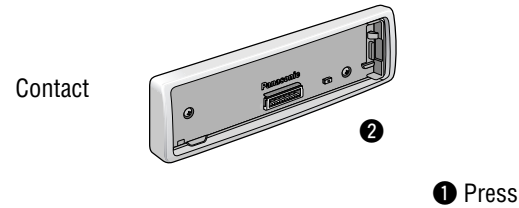

3 Remove the Trim Plate ⑦ with a screwdriver.

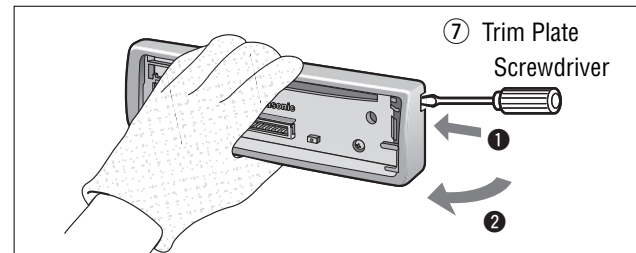

- 4
- 1 Insert the Dismounting plate ⑧ along the grooves on both sides of the main unit until "click" is heard.
 - 2 Pull out the unit while pushing the plates further inside.

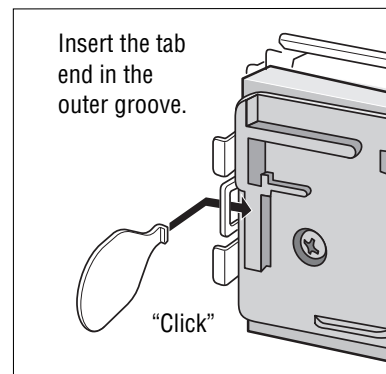

Remove the unit by pulling with both hands.

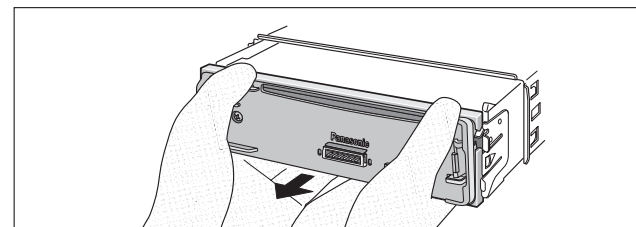
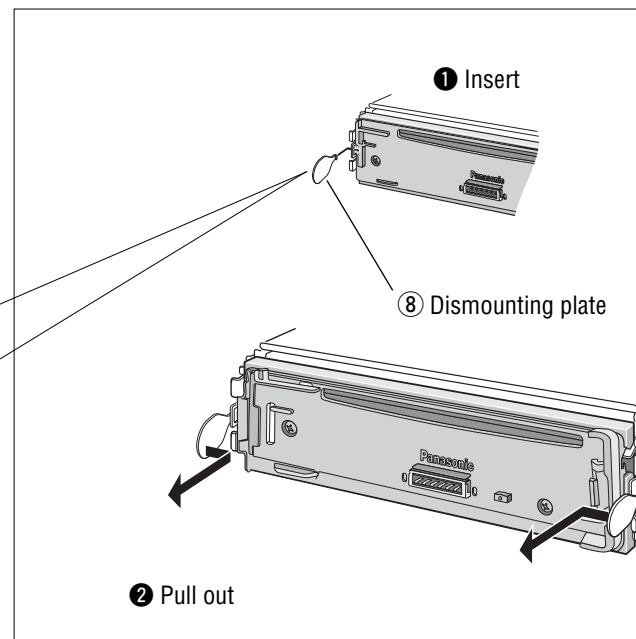

Specifications

General

Power supply:	12 V DC (11 V–16 V), test voltage 14.4 V, negative ground
Current consumption:	Less than 2.2 A (CD play mode; 0.5 W×4 channels)
Maximum power output:	50 W×4 channels at 1 kHz, volume control maximum (CQ-C1200U/C1120U) 45 W×4 channels at 1 kHz, volume control maximum (CQ-C1110U/C1100U)
Tone adjustment range:	
Bass:	±12 dB at 100 Hz
Treble:	±12 dB at 10 kHz
Suitable speaker impedance:	4–8 Ω
Preamp output voltage:	2.0 V (CD play mode; 1 kHz, 0 dB)
Output impedance:	200 Ω
Sub-Woofer output voltage:	2.0 V (CQ-C1200U)
Sub-Woofer output impedance:	200 Ω (CQ-C1200U)
Dimensions (W×H×D):	7"×1 ⁵ / ₁₆ "×5 ⁷ / ₈ " (178×50×155 mm)
Weight:	3 lbs. 1 oz (1.4 kg)

FM Stereo Radio

Frequency range:	87.9 MHz–107.9 MHz
Usable sensitivity:	11.0 dBf. (1.25 μV, 75 Ω)
50 dB quieting sensitivity:	15.2 dBf. (1.6 μV, 75 Ω)
Frequency response:	30 Hz–15 kHz (±3 dB)
Alternate channel selectivity:	75 dB
Stereo separation:	42 dB (1 kHz)
Image response ratio:	75 dB
IF response ratio:	100 dB
Signal/noise ratio:	70 dB

AM Radio

Frequency range:	530 kHz–1 710 kHz
Usable sensitivity:	28 dB/μV (25 μV, S/N 20 dB)

CD Player

Sampling frequency:	8 times oversampling
DA converter:	1 bit DAC system
Error correction system:	Panasonic super decoding algorithm
Pick-up type:	Astigma 3-beam
Light source:	Semiconductor laser
Wave length:	780 nm
Frequency response:	20 Hz–20 kHz (±1 dB)
Signal/noise ratio:	96 dB
Total harmonic distortion:	0.01 % (1 kHz)
Wow and flutter:	Below measurable limits
Channel separation:	75 dB

Above specifications comply with EIA standards.

Note: Specifications and the design are subject to modification without notice due to improvements in technology.

Free Manuals Download Website

<http://myh66.com>

<http://usermanuals.us>

<http://www.somanuals.com>

<http://www.4manuals.cc>

<http://www.manual-lib.com>

<http://www.404manual.com>

<http://www.luxmanual.com>

<http://aubethermostatmanual.com>

Golf course search by state

<http://golfingnear.com>

Email search by domain

<http://emailbydomain.com>

Auto manuals search

<http://auto.somanuals.com>

TV manuals search

<http://tv.somanuals.com>