

Panasonic

English

WMA MP3 CD Player/Receiver

Model: **CQ-C1505W**

Operating Instructions



WMA

MP3

- Please read these instructions carefully before using this product and keep this manual for future reference.

Safety Information

- Read the operating instructions for the unit and all other components of your car audio system carefully before using the system. They contain instructions about how to use the system in a safe and effective manner. Panasonic assumes no responsibility for any problems resulting from failure to observe the instructions given in this manual.



Warning

This pictograph intends to alert you to the presence of important operating instructions and installation instructions. Failure to heed the instructions may result in severe injury or death.



Caution

This pictograph intends to alert you to the presence of important operating instructions and installation instructions. Failure to heed the instructions may result in injury or material damage.

Warning

Observe the following warnings when using this unit.

- ❑ **The driver should neither watch the display nor operate the system while driving.**
Watching the display or operating the system will distract the driver from looking ahead of the vehicle and can cause accidents. Always stop the vehicle in a safe location and use the parking brake before watching the display or operating the system.
- ❑ **Use the proper power supply.**
This product is designed for operation with a negative grounded 12 V DC battery system. Never operate this product with other battery systems, especially a 24 V DC battery system.
- ❑ **Keep batteries and insulation film out of reach of infants.**
Batteries and insulation film can be ingested, so keep them out of the reach of infants. If an infant ingests a battery or insulation film, please seek immediate medical attention.
- ❑ **Protect the Deck Mechanism.**
Do not insert any foreign objects into the slot of this unit.
- ❑ **Do not disassemble or modify the unit.**
Do not disassemble, modify the unit or attempt to repair the product yourself. If the product needs to be repaired, consult your dealer or an authorized Panasonic Service Center.
- ❑ **Do not use the unit when it is out of order.**
If the unit is out of order (no power, no sound) or in an abnormal state (has foreign objects in it, is exposed to water, is smoking, or smells), turn it off immediately and consult your dealer.
- ❑ **The remote control unit should not lie about in the car.**
If the remote control unit lies about, it could fall on the floor while driving, get wedged under the brake pedal, and lead to a traffic accident.
- ❑ **Refer fuse replacement to qualified service personnel.**
When the fuse blows out, eliminate the cause and have it replaced with the fuse prescribed for this unit by a qualified service engineer. Incorrect replacement of the fuse may lead to smoke, fire, and damage to the product.

Observe the following warnings when installing.

- ❑ **Disconnect the lead from the negative (–) battery terminal before installation.**
Wiring and installation with the negative (–) battery terminal connected may cause electrical shock and injury due to a short circuit. Some cars equipped with the electrical safety system have specific procedures of battery terminal disconnection.
FAILURE TO FOLLOW THE PROCEDURE MAY LEAD TO THE UNINTENDED ACTIVATION OF THE ELECTRICAL SAFETY SYSTEM RESULTING IN DAMAGE TO THE VEHICLE AND PERSONAL INJURY OR DEATH.
- ❑ **Never use safety-related components for installation, grounding, and other such functions.**
Do not use safety-related vehicle components (fuel tank, brake, suspension, steering wheel, pedals, airbag, etc.) for wiring or fixing the product or its accessories.
- ❑ **Installing the product on the air bag cover or in a location where it interferes with airbag operation is prohibited.**
- ❑ **Check for piping, gasoline tank, electric wiring, and other items before installing the product.**
If you need to open a hole in the vehicle chassis to attach or wire the product, first check where the wire harness, gasoline tank, and electric wiring are located. Then open the hole from outside if possible.
- ❑ **Never install the product in a location where it interferes with your field of vision.**
- ❑ **Never have the power cord branched to supply other equipment with power.**
- ❑ **After installation and wiring, you should check the normal operation of other electrical equipment.**
The continuation of their using in abnormal conditions may cause fire, electrical shock or a traffic accident.
- ❑ **In the case of installation to an airbag-equipping car, confirm warnings and cautions of the vehicle manufacturer before installation.**
- ❑ **Make sure the leads do not interfere with driving or getting in and out of the vehicle.**
- ❑ **Insulate all exposed wires to prevent short circuiting.**

Caution

Observe the following cautions when using this unit.

- Keep the sound volume at an appropriate level.**
Keep the volume level low enough to be aware of road and traffic conditions while driving.
- This unit is designed for use exclusively in automobiles.**
- Do not operate the unit for a prolonged period with the engine turned off.**
Operating the audio system for a long period of time with the engine turned off will drain the battery.
- Do not expose the unit to direct sunlight or excessive heat.**
Otherwise these will raise the interior temperature of the unit, and it may lead to smoke, fire, or other damage to the unit.
- Do not use the product where it is exposed to water, moisture, or dust.**
Exposure of the unit to water, moisture, or dust may lead to smoke, fire, or other damage to the unit. Make especially sure that the unit does not get wet in car washes or on rainy days.
- Set the volume level to low enough before the AUX connection is completed.**
Failure to observe this, the loud noise may come out and damage your speakers and your hearing. Direct connection of the speaker/headphone output of an external device without any attenuator may distort sound or damage the connected external device.

Observe the following cautions when installing.

- Refer wiring and installation to qualified service personnel.**
Installation of this unit requires special skills and experience. For maximum safety, have it installed by your dealer. Panasonic is not liable for any problems resulting from your own installation of the unit.
- Follow the instructions to install and wire the product.**
Not following the instructions to properly install and wire the product could cause an accident or fire.
- Take care not to damage the leads.**
When wiring, take care not to damage the leads. Prevent them from getting caught in the vehicle chassis, screws, and moving parts such as seat rails. Do not scratch, pull, bend or twist the leads. Do not run them near heat sources or place heavy objects on them. If leads must be run over sharp metal edges, protect the leads by winding them with vinyl tape or similar protection.

- Use the designated parts and tools for installation.**

Use the supplied or designated parts and appropriate tools to install the product. The use of parts other than those supplied or designated may result in internal damage to the unit. Faulty installation may lead to an accident, a malfunction or fire.

- Do not block the air vent or the cooling plate of the unit.**

Blocking these parts will cause the interior of the unit to overheat and will result in fire or other damage.

- Do not install the product where it is exposed to strong vibrations or is unstable.**

Avoid slanted or strongly curved surfaces for installation. If the installation is not stable, the unit may fall down while driving and this can lead to an accident or injury.

- Installation Angle**

The product should be installed in a horizontal position with the front end up at a convenient angle, but not more than 30°. The user should bear in mind that in some areas there may be restrictions on how and where this unit must be installed. Consult your dealer for further details.

- Wear gloves for safety. Make sure that wiring is completed before installation.**

- To prevent damage to the unit, do not connect the power connector until the whole wiring is completed.**

- Do not connect more than one speaker to one set of speaker leads. (except for connecting to a tweeter)**

Observe the following cautions when handling the battery for the remote control unit.

- Use only specified battery (CR2025).
- Match the polarity of the battery with the (+) and (–) marks in the battery case.
- Replace a dead battery as soon as possible.
- Remove the battery from the remote control unit when not using it for an extended period of time.
- Insulate the battery (by placing them in a plastic bag or covering them with vinyl tape) before disposal or storage.
- Dispose of the battery according to the local regulations.
- Do not disassemble, recharge, heat or short the battery. Do not throw a battery into a fire or water.

In case of battery leakage

- Thoroughly wipe the battery liquid off the battery case and insert new battery.
- If any part of your body or clothing comes into contact with battery liquid, wash it with plenty of water.
- If battery liquid comes into contact with your eyes, wash them with plenty of water and get immediate medical attention.

Caution

**THIS PRODUCT IS A CLASS I LASER PRODUCT.
USE OF CONTROLS OR ADJUSTMENTS OR PERFORMANCE OF
PROCEDURES OTHER THAN THOSE SPECIFIED HEREIN MAY
RESULT IN HAZARDOUS RADIATION EXPOSURE.
DO NOT OPEN COVERS AND DO NOT REPAIR BY YOURSELF.
REFER SERVICING TO QUALIFIED PERSONNEL.**

Before Reading These Instructions

Panasonic welcomes you to our constantly growing family of electronic products owners.

We endeavor to give you the advantages of precise electronic and mechanical engineering, manufactured with carefully selected components, and assembled by people who are proud of the reputation their work has built for our company. We know this product will bring you many hours of enjoyment, and after you discover the quality, value and reliability we have built into it, you too will be proud to be a member of our family.

Accessories

Instruction kit



Operating Instructions

(English: YEFM285920)
(Русский: YEFM285921)
(中文: YEFM285922)
(한국어: YEFM285923)

Q'ty: 1 set



Installation Instructions (YEFM294291)

Q'ty: 1

Installation kit (YEP0FZ5698) Q'ty: 1



Lock Cancel Plate



Mounting Bolt (5 mm ϕ)



Rubber Bushing



Mounting Collar (YEFX0217263A)

Q'ty: 1



Trim Plate (YEFX051020)

Q'ty: 1



Power Connector (YGAJ021009)

Q'ty: 1



Remote Control Unit (includes a battery)

(EUR7641010) **Q'ty: 1**



Removable Face Plate Case (YEFA131839A)

Q'ty: 1

Notes:

- The number in parentheses underneath each accessory part name is the part number for maintenance and service.
- Accessories and their part numbers are subject to modification without prior notice due to improvements.
- Mounting Collar and Trim Plate are mounted on the main unit at shipment.

Specifications

General

Power supply	: DC 12 V (11 V – 16 V DC), test voltage 14.4 V, negative ground
Current consumption	: Less than 2.1 A (CD mode; 0.5 W x 4 channels)
Maximum power output	: 50 W x 4 channels (at 1 kHz), volume control maximum
Power output	: 18 W x 4 CH (1 kHz, 1 %, 4 Ω)
Tone adjustment range	: Bass: ± 12 dB at 100 Hz, Treble: ± 12 dB at 10 kHz
Speaker impedance	: 4 – 8 Ω
Pre-amp output voltage	: 2.5 V (CD mode, 1 kHz, 0 dB)
Pre-amp output impedance	: 200 Ω
Dimensions (W x H x D)	: 178 x 50 x 160 mm
Weight	: 1.3 kg
Front AUX input	
Input impedance	: 10 k Ω
Allowable external input	: 2.0 V
Connector	: 3.5 mm ϕ Stereo mini-pin

Disc Player

Sampling frequency	: 8 times oversampling
DA converter	: 1 bit DAC System
Pick-up type	: Astigma 3-beam
Light source	: Semiconductor laser
Wave length	: 790 nm
Frequency response	: 20 Hz – 20 kHz (± 1 dB)
Signal to noise ratio	: 96 dB
Total harmonic distortion	: 0.01 % (1 kHz)
Wow and flutter	: Below measurable limits
Channel separation	: 75 dB

FM Stereo Radio

Frequency range	: 87.50 MHz – 108.00 MHz
Usable sensitivity	: 6 dB/ μ V (S/N 30 dB)
Frequency response	: 30 Hz – 15 kHz (± 3 dB)
Alternate channel selectivity	: 75 dB
Stereo separation	: 35 dB (1 kHz)
Image rejection ratio	: 70 dB
IF rejection ratio	: 100 dB
Signal/noise ratio	: 62 dB

AM Radio

Frequency range	: 531 kHz – 1 602 kHz
Usable sensitivity	: 28 dB/ μ V (S/N 20 dB)

Notes:

- Specifications and design are subject to modification without notice due to improvements.
- Some figures and illustrations in this manual may be different from your product.

Matsushita Electric Industrial Co., Ltd.

Web Site: <http://panasonic.net>

Preparation

First Time Power On

- 1 Set your car's ignition switch to the ACC or ON position.



- 2 Press [SOURCE] (PWR: Power).

Battery Installation

Pull the insulation film out from the backside of the remote control gently.

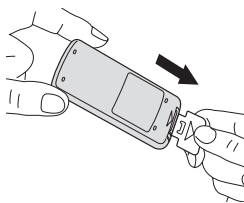

Note: Battery Information:

Battery Type: Panasonic lithium battery (CR2025) (Included in the remote control)

Battery Life: Approximately 6 months under normal use (at room temperature)

Clock Setting

The 24-hour system is used for the clock.

- 1 Press [DISP].
 (clock display)
- 2 Hold down [DISP] for more than 2 seconds.

 Hour blinks

- 3 Adjust the hour.

 Hour entered

[▶▶]: sets the hour ahead.

[◀◀]: sets the hour back.

- 4 Press [DISP].

 Minute blinks

- 5 Adjust the minute.

 Minute entered

[▶▶]: sets the minute ahead.

[◀◀]: sets the minute back.

- 6 Press [DISP].

 Completed

Notes:

- "ADJUST" is displayed before adjusting the clock.
- Hold down [◀◀] or [▶▶] to change numbers rapidly.

Clock Display at Power Off

Press [DISP] to change the display.

Display off



Clock display

Maintenance/Fuse

Cleaning the Unit

Your product is designed and manufactured to ensure the minimum of maintenance. Use a dry, soft cloth for routine exterior cleaning. Never use benzene, thinner, or other solvents.

Fuse

If the fuse blows out, consult your dealer, or your nearest authorized Panasonic Service Center.

⚠ Warning

- Use fuses of the same specified rating (**15 A**). Using substitutes or fuses with higher ratings, or connecting the unit directly without a fuse could cause fire or damage to the unit. **If the replaced fuse fails, contact your nearest authorized Panasonic Service Center.**

Anti-Theft System

This unit is equipped with a removable face plate. Removing this face plate makes the unit totally inoperable.

⚠ Caution

- This face plate is not waterproof. Do not expose it to water or excessive moisture.
- Do not remove the face plate while driving your car.
- Do not place the face plate on the dashboard or nearby areas where the temperature rises high.
- Do not touch the contacts on the face plate and the main unit, since this may result in poor electrical contact.
- If dirt or other foreign substances get on the contacts, wipe them off with a clean and dry cloth.

Removing

- 1 Turn off the power.
- 2 Press [**▲**]. The face plate will open.
- 3 Pull it out toward you.

Mounting

- 1 Slide the left side of the face plate in place.
- 2 Press the right end of face plate until a “click” is heard.

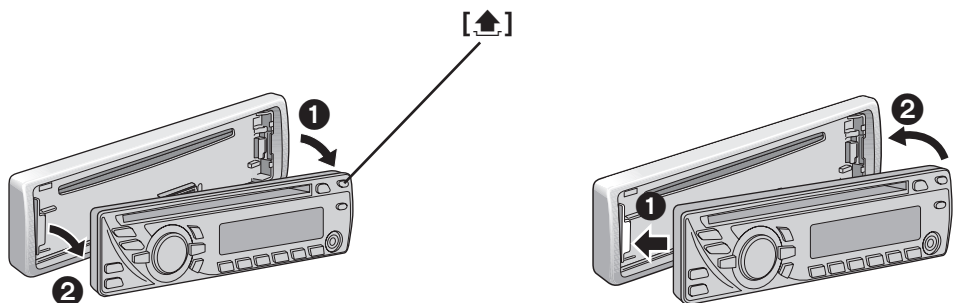

Face Plate Removing/Mounting (Anti-Theft System)

Notes on Discs

If you use commercial CDs, they must have either of these labels shown at right.

Some copy-protected music CDs are not playable.



How to hold the disc

- Do not touch the underside of the disc.
- Do not scratch on the disc.
- Do not bend the disc.
- When not in use, keep disc in the case.

Do not leave discs in the following places:

- In direct sunlight
- Near car heaters
- Dirty, dusty and damp areas
- On seats and dashboards

Disc cleaning

Use a dry, soft cloth to wipe from the center outward.



<Correct>



<Wrong>

Do not write on the disc label with a ballpoint pen or other hard-point pens.

Printed side



Labels created by a printer,
Protective films or sheets



Irregularly shaped discs



Disc with adhered
stickers or tape

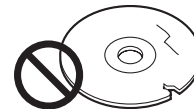

Discs with cracks, scratches
or parts missing

- You may have trouble playing back some CD-R/RW discs recorded using CD recorders (CD-R/RW drives), either due to their recording characteristics or dirt, fingerprints, scratches, etc. on the disc surface.
- CD-R/RW discs are less resistant to high temperatures and high humidity than ordinary music CDs. Leaving them inside a car for extended periods may damage and make playback impossible.
- Some CD-R/RWs cannot be played back successfully due to incompatibility among writing software, a CD recorder (CD-R/RW drive) and the discs.
- This player cannot play the CD-R/RW discs if the session is not closed.
- This player cannot play the CD-R/RW discs which contain other than CD-DA or MP3/WMA data (Video CD, etc.).
- Be sure to observe the instructions of the CD-R/RW disc for handling it.

Recording MP3/WMA files on a CD-media

- You are recommended to minimize the chances of making a disc that contains both CD-DA files and MP3/WMA files.
- If CD-DA files are on the same disc as MP3 or WMA files, the songs may not play in the intended order, or some songs may not play at all.
- When storing MP3 data and WMA data on the same disc, use different folders for each data.
- Do not record files other than MP3/WMA files and unnecessary folder on a disc.
- The name of MP3/WMA file should be added by rules as shown in the following descriptions and also comply with the rules of each file system.

- You may encounter trouble in playing MP3/WMA files or displaying the information of MP3/WMA files recorded with certain writing software or CD recorders.
- The file extension “.mp3” or “.wma” should be assigned to each file depending on the file format.
- This unit does not have the play list function.
- Although Multi-session recording is supported, the use of Disc-at-Once is recommended.

Supported file systems

ISO 9660 Level 1/Level 2, Apple Extension to ISO 9660, Joliet, Romeo

Note: Apple HFS, UDF 1.50, MIX mode CD, CD Extra is not supported.

Compression formats

(**Recommendation:** “Points to remember when making MP3/WMA files” on the right.)

- | | |
|---|---|
| • MPEG 1 audio layer 3
Bit rate: 32 k–320 kbps
VBR: Yes
Sampling frequency:
32, 44.1, 48 kHz | • MPEG 2 audio layer 3
Bit rate: 8 k–160 kbps
VBR: Yes
Sampling frequency:
16, 22.05, 24 kHz |
|---|---|
- **Windows Media Audio Ver. 7, 8, 9***
Bit rate: 32 k–192 kbps
VBR: Yes
Sampling frequency:
32, 44.1, 48 kHz

* WMA 9 Professional/LossLess/Voice are not supported.

Notes on MP3/WMA

Note: MP3/WMA encoding and writing software is not supplied with this unit.

Points to remember when making MP3/WMA files

Common

- High bit rate and high sampling frequency are recommended for high quality sounds.
- Selecting VBR (Variable Bit Rate) is not recommended because playing time is not displayed properly and sound may be skipped.
- The playback sound quality differs depending on the encoding circumstances. For details, refer to the user manual of your own encoding software and writing software.

MP3*

- It is recommended to set the bit rate to “128 kbps or more” and “fixed”.
- * MPEG Layer-3 audio coding technology licensed from Fraunhofer IIS and Thomson.

WMA

- It is recommended to set the bit rate to “64 kbps or more” and “fixed”.
- Do not set the copy protect attribute on the WMA file to enable this unit to play back.

⚠ Caution

- **Never assign the “.mp3”, or “.wma” file name extension to a file that is not in the MP3/WMA format. This may not only produce noise from the speaker damage, but also damage your hearing.**

Display Information

Displayed items

- | | |
|---|--|
| • CD-TEXT
Disc title
Track title | • MP3 (ID3 tag)
Album name
Title name/Artist name |
| • MP3/WMA
Folder name
File name | • WMA (WMA tag)
Album name
Title name/Artist name |

Displayable characters

- Displayable length of file name/folder name: within 32 characters. (Unicode file and folder names are reduced by half in the number of displayable characters.)
- Name files and folders in accordance with the standard of each file system. Refer to the instructions of writing software for details.
- ASCII character set and special characters in each language can be displayed.

Notes:

- With some software in which MP3/WMA format files have been encoded, the character information may not be displayed properly.
- Undisplayable characters and symbols will be converted into an asterisk (*).

Folder selection order/file playback order

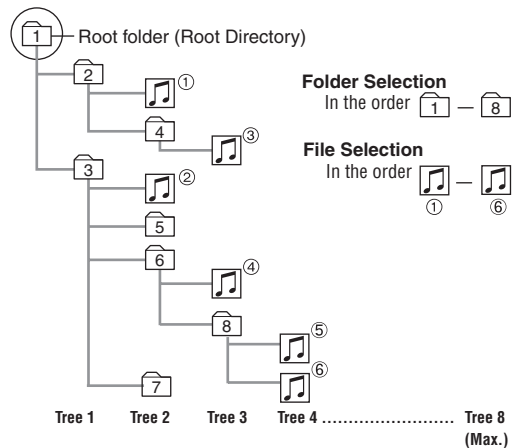

Maximum number of files/folders

- Maximum number of files: 999
- Maximum number of files in one folder: 255
- Maximum depth of trees: 8
- Maximum number of folders: 255 (Root folder is included.)

Notes:

- This unit counts the number of folders irrespective of the presence or absence of MP3/WMA file.
- If the selected folder does not contain any MP3/WMA files, the nearest MP3/WMA files in the order of playback will be played.
- Playback order may be different from other MP3/WMA players even if the same disc is used.
- “ROOT” appears when displaying the root folder name.

Windows Media, and the Windows logo are trademarks, or registered trademarks of Microsoft Corporation in the United States and/or other countries/regions.



Copyright

It is prohibited by copyright laws to copy, distribute and deliver copyrighted materials such as music without the approval of copyright holder except enjoying yourself personally.

No warranty

Above description complies with our investigations as of September 2006. It has no warranty for reproducibility and displayability of MP3/WMA.

Remote Control Unit

Notes:

- This instruction manual explains operations for use with the buttons on the main unit. (Different operations excluded)
- Aim the remote control at the remote sensor and operate it.

[0] to [9]

selects a preset station (1 to 6), presets the current station (Hold it down for more than 2 seconds.),

inputs the number in direct selection.

[#] (NUMBER)

executes the direct selection.

[RANDOM] [SCAN] [REPEAT]

toggles on/off each play mode.

[<] [>]

down/up the frequency (Hold it down for more than 0.5 seconds and release it for seek tuning.)

[∨] [∧]

skip to the previous/next folder in player mode.

[◀▶] [▶▶]

skip to the previous/next track/file in player mode. Hold it down for fast reverse/fast forward.

[BAND]

selects a band in the tuner source, toggles pause/play in player source, executes the APM (Auto Preset Memory) in tuner source (Hold it down for more than 2 seconds).

[SRC] (SOURCE)

selects a source.

(POWER)

toggles power on/off.

[MENU] (SEL: Select)

selects the items in the audio menu.

[VOL] (volume)

adjusts the volume, and selects the value in the audio menu, etc.

[MUTE]

toggles mute on/off.

[DISP] (Display)

switches the information on display, and exits the audio menu.



Direct Access

A track (CD mode), file, folder (MP3/WMA mode) can be directly selected.

Example: Track number 5

1 Press [#] (NUMBER).

2 Press [5].

3 Press [BAND] (SET).

Notes:

- To suspend direct selection, press [DISP].
- For folder selection, enter a number after pressing [#] (NUMBER) twice.

Functions only on Main unit

The following functions are not available on remote control unit.

- SQ selection
- Scroll
- Disc eject

Battery Replacement

1 Remove the battery holder with the remote control unit placed on a flat surface.

1 Stick your thumbnail into the groove, and push the holder in the direction of the arrow, and at the same time.

2 Pull it out in the direction of the arrow using a tough pointed object.

Tough pointed object

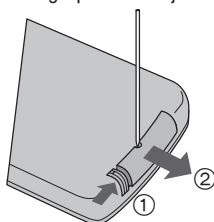

Back side

2 Put a battery in the case with (+) side facing up.

3 Put the case back.

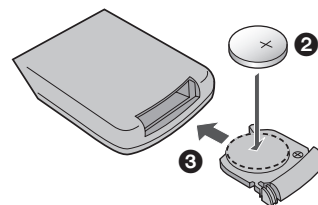

Warning

- Keep batteries away from children to avoid the risk of accidents. If an infant ingests a battery, please seek immediate medical attention.

Caution

- Remove and dispose of an old battery immediately.
- Do not disassemble, heat or short a battery. Do not throw a battery into a fire or water.
- Follow local regulations when disposing of a battery.
- Improper use of batteries may cause overheating, an explosion or ignition, resulting in injury or a fire.

Notes: Battery Information:

Battery Type: Panasonic lithium battery (CR2025) (Included in the remote control)

Battery Life: Approximately 6 months under normal use (at room temperature)

General

[SOURCE] (Source)
selects a source.
[PWR] (Power)
toggles power on/off.

[VOL] (Volume)



[SQ] (Sound Quality)
selects a sound type (SQ).

[MUTE]
toggles mute on/off.

Remote Control Sensor

Caution

• Set the volume level to low enough before the AUX connection is completed. Failure to observe this, the loud noise may come out and damage your speakers and your hearing.

***[AUX] (AUX IN)** (3.5 mm ϕ stereo)
From line output of external sound/audio device (ex. Silicon-audio player, HDD player, etc.)

***AUX IN:**

<AUX IN>

Power On/Off

Set your car's ignition switch to the ACC or ON position.

Power on: Press **[SOURCE]** (**PWR**).

Power off: Hold down **[SOURCE]** (**PWR**) for more than 1 second.

Source Selection

Press **[SOURCE]** to change the source.

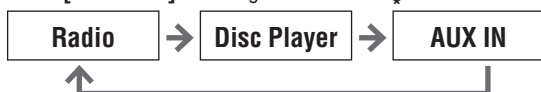

Volume Adjustment

(Setting Range: 0 to 40, Default: 18)

Turn **[VOL]**.

Mute

ON: Press **[MUTE]**. (**[MUTE]** lights.)

OFF: Press **[MUTE]** again.

SQ (Sound Quality)

SQ is a function that can call up various sound types at the touch of button in accordance with your listening music type. Press **[SQ]** to select the sound type (SQ) as follows:



(FLAT) flat frequency response: does not emphasize any part. (Default)



(ROCK) speedy and heavy sound: exaggerates bass and treble.



(POP) wide-ranged and deep sound: slightly emphasizes bass and treble.



(VOCAL) clear sound: emphasizes middle tone and slightly emphasizes treble.

Notes:

- If no operation takes place for more than 5 seconds in the SQ selection mode, the display returns to the regular mode.
- Settings of SQ, bass and treble are influenced one another. If such an influence causes distortion to the audio signal, readjust bass/treble or volume.
- For further information on Bass, Treble, Balance and Fader settings, refer to Audio Settings.

Radio (AM/FM)

[SOURCE] (Source)
selects a source.

[BAND]
selects a band in the radio source.

[APM] (Auto Preset Memory)
executes APM in the radio source. (Hold it down for more than 2 seconds.)

[DISP] (Display)
switches the information on the display.

[TUNE <<<] [TUNE >>>]
down/up the frequency. (Hold it down for more than 0.5 seconds and release it for seek tuning.)

Preset buttons [1] to [6]
selects a preset station in the radio source, and presets the current station. (Hold it down for more than 2 seconds.)



1 Press **[SOURCE]** to select the radio source.

2 Press **[BAND]** to select a band.

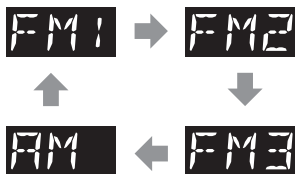

3 Select a station.

Frequency adjustment

[TUNE <<<]: Lower
[TUNE >>>]: Higher

Note: Hold down for 0.5 sec. or more and release for station search.

Preset station selection

Press the corresponding preset button from **[1]** to **[6]** to tune in a preset station.

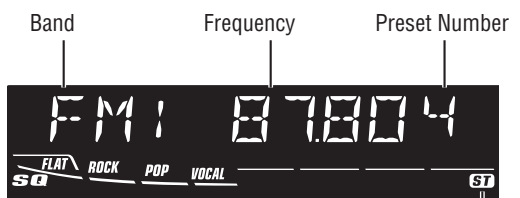

lights while receiving an FM stereo signal.

Display change

Press **[DISP]** to change the display.

Radio mode display (Default)



Clock display

Up to 6 stations can be preset in AM, FM1, FM2, and FM3 respectively. Preset stations can be simply called up by pressing **[1]** to **[6]**.

Auto Preset Memory (APM)

With this operation, stations with good receiving conditions can be automatically stored in the preset memory.

- 1 Select a band.
- 2 Hold down **[BAND]** (**APM**) for more than 2 seconds.

The preset stations under best receiving conditions are received for 5 seconds each after presetting the stations (SCAN). To stop scanning, press one of the buttons from **[1]** to **[6]**.

Note: New stations overwrite existing saved stations.

Manual station preset

- 1 Tune into a station.
- 2 Hold down one of the preset buttons from **[1]** to **[6]** for more than 2 seconds.



(blinks once)

Note: New stations overwrite existing saved stations.

Audio Settings

[VOL] — selects a value in the audio menu.
(PUSH SEL) (Push to select) — selects items in the audio menu.

[DISP] (Display) — exits from the audio menu.



- 1 Press **[VOL]** (**PUSH SEL**) to display the audio menu display.
Note: If no operation takes place for more than 5 seconds in the audio menu (2 seconds in Main volume adjustment), the display returns to the regular mode.
- 2 Press **[VOL]** (**PUSH SEL**) to select a mode to be adjusted.
- 3 Turn **[VOL]** clockwise or counterclockwise to adjust.

VOL 18 Volume
 (Setting Range: 0 to 40, Default: 18)

BASS Bass
 (Setting Range: -12 dB to +12 dB by 2 dB, Default: 0 dB)

TREBLE Treble
 (Setting Range: -12 dB to +12 dB by 2 dB, Default: 0 dB)

BALANCE Balance
 (Setting Range: 15 levels each, Default CNT (center))

FADER Fader
 (Setting Range: 15 levels each, Default CNT (center))

VOL 18

①: Up
 ②: Down

BASS+ 6dB

①: Increased
 ②: Decreased

TRE+ 6dB

①: Increased
 ②: Decreased

BAL L 15

①: Right enhanced
 ②: Left enhanced

FAD F 15

①: Front enhanced
 ②: Rear enhanced

Notes:

- If the fader is set to front, the pre-amp. output (rear) is decreased.
- For further information on SQ (Sound Quality) settings, refer to General.
- Settings of SQ, bass and treble are influenced one another. If such an influence causes distortion to the audio signal, readjust bass/treble or volume.

Audio menu

Player (Disc Player)

Disc slot

takes a disc in with the printed side facing up.

Notes:

- The power will be turned on automatically when a disc is loaded.
- A disc which has both CD-DA data and MP3/WMA data on it may not be reproduced normally.

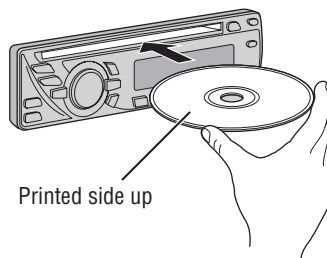

Printed side up

[▲] (Eject)
ejects the disc.

[SOURCE] (Source)

selects a source.

[▶||] (Play/Pause)

toggles pause/play in the player source.

[DISP] (Display)

switches the information on the display.

[◀◀] [▶▶]

skip to the previous/next track/file in the player mode. Hold down either of them for fast reverse/fast forward.

[∨] [∧]

skip to the previous/next folder.

[4] (RANDOM)/[5] (SCAN)/[6] (REPEAT)

toggles on/off each play mode.

[3] (SCROLL)

scrolls the information on display.

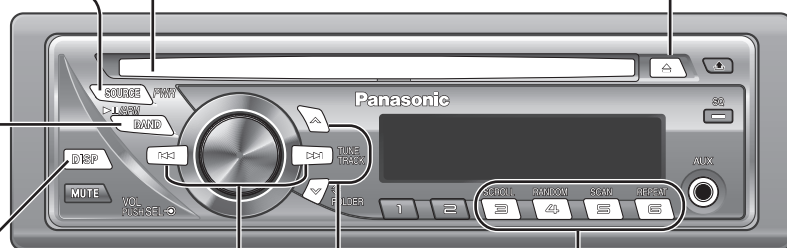

⚠ Caution

- Do not insert a disc when the **DISC** indicator lights.
- Refer to the section of "Notes on Discs" and "Notes on MP3/WMA".
- This unit does not support 8 cm discs.
- If you insert an 8 cm disc and cannot eject it, turn ACC of your car off once and turn it on again, then press [▲] (Eject).

- Do not insert foreign matter into the disc slot.

Operation Flow

1 Press [SOURCE] to select the Disc Player source.

2 Select a desired portion.

Track/file selection

Press [◀◀] / [▶▶].

Note: To perform fast forward/reverse, hold down either of them.

Disc Player (CD-DA disc):

Previous/next track

Disc Player (MP3/WMA disc):

Previous/next file

Folder selection (MP3/WMA)

Press [∨] / [∧].

Pause

Press [BAND] (▶||).

Press again to cancel.

CD-DA mode display

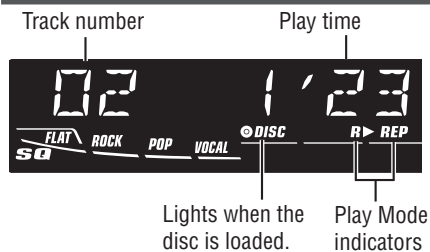

MP3/WMA mode display

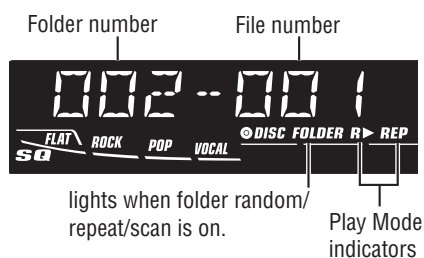

Display change

Press **[DISP]** to change the display.

Disc Player (CD-DA disc):

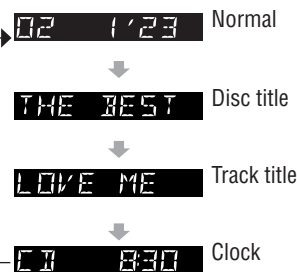

Disc Player (MP3/WMA disc):



*ID3/WMA Tag On/Off

Hold down **[3]** for more than 2 seconds.

TAG ON

↕ album title and song title/artist name are displayed.

TAG OFF (Default)

folder name/file name are displayed.

Notes:

- For scrolling text, press **[3]** (**SCROLL**).
- "NO TEXT" is displayed when there is no information on the disc.

Random play

All the available songs (tracks/files) are played in a random sequence.

Press **[4]** (**RANDOM**).

Press again to cancel.

Folder random play (MP3/WMA)

All the available files in current folder are played in a random sequence.

Hold down **[4]** (**RANDOM**) for more than 2 seconds.

Hold down again to cancel.

Repeat play

The current song (track/file) is repeated.

Press **[6]** (**REPEAT**).

Press again to cancel.

Folder repeat play (MP3/WMA)

The current folder is repeated.

Hold down **[6]** (**REPEAT**) for more than 2 seconds.

Hold down again to cancel.

Scan play

The first 10 seconds of each songs (tracks/files) is played in sequence.

Press **[5]** (**SCAN**).

Press again to cancel.

Folder scan play (MP3/WMA)

From the next folder, the first 10 seconds of the first file in each folder is played in sequence.

Hold down **[5]** (**SCAN**) for more than 2 seconds.

Hold down again to cancel.

Troubleshooting

If You Suspect Something Wrong

Check and take steps as described below.

If the described suggestions do not solve the problem, it is recommended to take the unit to your nearest authorized Panasonic Service Center. The product should be serviced only by qualified personnel. Please refer the checking and the repair to professionals. Panasonic shall not be liable for any accidents arising out of neglect of checking the unit or your own repair after your checking.

Never take measures especially those other than indicated by *italic* letters in "Possible Solution" described below because those are too dangerous for users to handle themselves.

Trouble	Possible Solution
Common	
No power	<ul style="list-style-type: none"> • <i>Start the engine. (Or turn the ignition switch to the ACC position.)</i> • Verify the wiring. (battery lead, power lead, ground lead, etc.) • Fuse blown (Contact the nearest Panasonic Service Center.) • Ask a professional for fuse replacement. • Be sure to use the same rated fuse.
No sound	<ul style="list-style-type: none"> • <i>Disable the mute function.</i> • Verify the wiring. • <i>Wait until the dew disappears before turning on the unit.</i>
Noise	<ul style="list-style-type: none"> • Make sure that grounding is established properly.
No sound from left, right, front, or rear speaker	<ul style="list-style-type: none"> • <i>Adjust the balance and fader.</i> • Verify the wiring.
Left and right sounds are reversed	<ul style="list-style-type: none"> • Connect the speaker lead correctly.

Disc Player

No sound, or disc is automatically ejected	<ul style="list-style-type: none"> • <i>Load the disc correctly.</i> • <i>Clean the disc.</i>
Sound skip, poor sound quality	<ul style="list-style-type: none"> • <i>Clean the disc.</i>
Sound skip due to vibration	<ul style="list-style-type: none"> • The maximum permissible tilt angle is 30°. • <i>Secure the unit.</i>
Disc not ejectable	<ul style="list-style-type: none"> • <i>Press [▲]. If the disc is still not ejected, contact the nearest Panasonic Service Center.</i>

Warning

- Do not use the unit in an irregular condition, for example, without sound, or with smoke or a foul smell, which can cause ignition or electric shock. Immediately stop using the unit and consult your dealer.
- Never try to repair the unit by yourself because it is dangerous to do so.

Trouble	Possible Solution
Radio	
Frequent noise	<ul style="list-style-type: none"> • <i>Tune in to another station of high-intensity waves.</i> • Make sure that the antenna mounted point is grounded properly.
Preset data deleted	<ul style="list-style-type: none"> • <i>The preset memory is cleared to return to the original factory setting when the power connector or battery is disconnected.</i>

Error Display Messages

--E1--	<p>(The disc is ejected automatically.) The disc is dirty or upside down.</p> <ul style="list-style-type: none"> • Check the disc.
--E2--	<p>(The disc is ejected automatically.) The disc has scratches.</p> <ul style="list-style-type: none"> • Check the disc.
--E3--	<p>No operation by some cause.</p> <ul style="list-style-type: none"> • If normal operation is not restored, consult your dealer or the nearest Service Center to ask for repairs.
--E4--	<p>Cannot read the file</p> <ul style="list-style-type: none"> • Check the disc.
--E5--	<p>A WMA file can be copyrighted.</p> <ul style="list-style-type: none"> • The file protected by copyright is not playable.

Memorandum

A series of horizontal dotted lines for writing.

Memorandum

A series of horizontal dotted lines for writing the memorandum content.

Free Manuals Download Website

<http://myh66.com>

<http://usermanuals.us>

<http://www.somanuals.com>

<http://www.4manuals.cc>

<http://www.manual-lib.com>

<http://www.404manual.com>

<http://www.luxmanual.com>

<http://aubethermostatmanual.com>

Golf course search by state

<http://golfingnear.com>

Email search by domain

<http://emailbydomain.com>

Auto manuals search

<http://auto.somanuals.com>

TV manuals search

<http://tv.somanuals.com>