

Panasonic

WMA MP3 CD Player/Receiver

Model: **CQ-C7703N/C7303N**



(CQ-C7703N)



ATEST
8 SD
2131

Tento výrobek je shodný s typem schváleným Ministerstvem dopravy a spojů České republiky pod číslem 2131 č.j.20926/99-112.



- Please read these instructions carefully before using this product and keep this manual for future reference.
- Bitte lesen Sie diese Bedienungsanleitung vor der Verwendung dieses Produktes aufmerksam durch und bewahren Sie sie danach für spätere Nachschlagzwecke sorgfältig auf.
- Prière de lire ces instructions attentivement avant d'utiliser le produit et garder ce manuel pour l'utilisation ultérieure.
- Leest u deze instructie alstublieft zorgvuldig door voor u dit product in gebruik neemt en bewaar deze handleiding voor later gebruik.
- Läs igenom denna bruksanvisning noga innan produkten tas i bruk. Spara bruksanvisningen för framtida behov.
- Si prega di leggere attentamente queste istruzioni prima di usare questo prodotto e di conservare questo manuale per usi futuri.
- Lea con atención estas instrucciones antes de utilizar el producto y guarde este manual para poderlo consultar en el futuro.
- Læs venligst denne brugsvejledning grundigt, inden dette produkt tages i brug og gem den til senere konsultation.
- Przeczytaj uważnie instrukcję obsługi przed rozpoczęciem używania urządzenia i zachowaj ją do użytku w przyszłości.
- Před použitím přístroje si pozorně přečtěte tento návod a uschovejte si ho pro budoucí potřebu.
- Mielőtt használna a terméket kérjük, hogy gondosan olvassa el ezeket az előírásokat és a későbbiekben felmerülő kérdések miatt kérjük tartsa meg a használati utasítást.
- Перед началом эксплуатации просим прочитать настоящую инструкцию внимательно и хранить ее на пользование на будущее.

Safety Information

■ Read the operating instructions for the unit and all other components of your car audio system carefully before using the system. They contain instructions about how to use the system in a safe and effective manner. Panasonic assumes no responsibility for any problems resulting from failure to observe the instructions given in this manual.

■ This manual uses pictographs to show you how to use the product safely and to alert you to potential dangers resulting from improper connections and operations. The meanings of the pictographs are explained below. It is important that you fully understand the meanings of the pictographs in order to use this manual and the system properly.



This pictograph intends to alert you to the presence of important operating instructions and installation instructions. Failure to heed the instructions may result in severe injury or death.



This pictograph intends to alert you to the presence of important operating instructions and installation instructions. Failure to heed the instructions may result in injury or material damage.

Warning

Observe the following warnings when using this unit.

- The driver should neither watch the display nor operate the system while driving.**

Watching the display or operating the system will distract the driver from looking ahead of the vehicle and can cause accidents. Always stop the vehicle in a safe location and use the parking brake before watching the display or operating the system.
- Use the proper power supply.**

This product is designed for operation with a negative grounded 12 V DC battery system. Never operate this product with other battery systems, especially a 24 V DC battery system.
- Keep batteries and insulation film out of reach of infants.**

Batteries and insulation film can be ingested, so keep them out of the reach of infants. If an infant ingests a battery or insulation film, please seek immediate medical attention.
- Protect the Deck Mechanism.**

Do not insert any foreign objects into the slot of this unit.
- Do not disassemble or modify the unit.**

Do not disassemble, modify the unit or attempt to repair the product yourself. If the product needs to be repaired, consult your dealer or an authorized Panasonic Service Centre.
- Do not use the unit when it is out of order.**

If the unit is out of order (no power, no sound) or in an abnormal state (has foreign objects in it, is exposed to water, is smoking, or smells), turn it off immediately and consult your dealer.
- The remote control unit should not lie about in the car.**

If the remote control unit lies about, it could fall on the floor while driving, get wedged under the brake pedal, and lead to a traffic accident.
- Refer fuse replacement to qualified service personnel.**

When the fuse blows out, eliminate the cause and have it replaced with the fuse prescribed for this unit by a qualified service engineer. Incorrect replacement of the fuse may lead to smoke, fire, and damage to the product.

Observe the following warnings when installing.

- Disconnect the lead from the negative (–) battery terminal before installation.**

Wiring and installation with the negative (–) battery terminal connected may cause electrical shock and injury due to a short circuit.
Some cars equipped with the electrical safety system have specific procedures of battery terminal disconnection.
FAILURE TO FOLLOW THE PROCEDURE MAY LEAD TO THE UNINTENDED ACTIVATION OF THE ELECTRICAL SAFETY SYSTEM RESULTING IN DAMAGE TO THE VEHICLE AND PERSONAL INJURY OR DEATH.
- Never use safety-related components for installation, grounding, and other such functions.**

Do not use safety-related vehicle components (fuel tank, brake, suspension, steering wheel, pedals, airbag, etc.) for wiring or fixing the product or its accessories.
- Installing the product on the air bag cover or in a location where it interferes with airbag operation is prohibited.**
- Check for piping, gasoline tank, electric wiring, and other items before installing the product.**

If you need to open a hole in the vehicle chassis to attach or wire the product, first check where the wire harness, gasoline tank, and electric wiring are located. Then open the hole from outside if possible.
- Never install the product in a location where it interferes with your field of vision.**
- Never have the power cord branched to supply other equipment with power.**
- After installation and wiring, you should check the normal operation of other electrical equipment.**

The continuation of their using in abnormal conditions may cause fire, electrical shock or a traffic accident.
- In the case of installation to an airbag-equipping car, confirm warnings and cautions of the vehicle manufacturer before installation.**
- Make sure the leads do not interfere with driving or getting in and out of the vehicle.**
- Insulate all exposed wires to prevent short circuiting.**

Caution

Observe the following cautions when using this unit.

- ❑ **Keep the sound volume at an appropriate level.**
Keep the volume level low enough to be aware of road and traffic conditions while driving.
- ❑ **Do not insert or allow your hand or fingers to be caught in the unit.**
To prevent injury, do not get your hand or fingers caught in moving parts or in the disc slot. Especially watch out for infants.
- ❑ **This unit is designed for use exclusively in automobiles.**
- ❑ **Do not operate the unit for a prolonged period with the engine turned off.**
Operating the audio system for a long period of time with the engine turned off will drain the battery.
- ❑ **Do not expose the unit to direct sunlight or excessive heat.**
Otherwise these will raise the interior temperature of the unit, and it may lead to smoke, fire, or other damage to the unit.
- ❑ **Do not use the product where it is exposed to water, moisture, or dust.**
Exposure of the unit to water, moisture, or dust may lead to smoke, fire, or other damage to the unit. Make especially sure that the unit does not get wet in car washes or on rainy days.

Observe the following cautions when installing.

- ❑ **Refer wiring and installation to qualified service personnel.**
Installation of this unit requires special skills and experience. For maximum safety, have it installed by your dealer. Panasonic is not liable for any problems resulting from your own installation of the unit.
- ❑ **Follow the instructions to install and wire the product.**
Not following the instructions to properly install and wire the product could cause an accident or fire.
- ❑ **Take care not to damage the leads.**
When wiring, take care not to damage the leads. Prevent them from getting caught in the vehicle chassis, screws, and moving parts such as seat rails. Do not scratch, pull, bend or twist the leads. Do not run them near heat sources or place heavy objects on them. If leads must be run over sharp metal edges, protect the leads by winding them with vinyl tape or similar protection.
- ❑ **Use the designated parts and tools for installation.**
Use the supplied or designated parts and appropriate tools to install the product. The use of parts other than those supplied or designated may result in internal damage to the unit. Faulty installation may lead to an accident, a malfunction or fire.
- ❑ **Do not block the air vent or the cooling plate of the unit.**
Blocking these parts will cause the interior of the unit to overheat and will result in fire or other damage.

- ❑ **Do not install the product where it is exposed to strong vibrations or is unstable.**
Avoid slanted or strongly curved surfaces for installation. If the installation is not stable, the unit may fall down while driving and this can lead to an accident or injury.
- ❑ **Installation Angle**
The product should be installed in a horizontal position with the front end up at a convenient angle, but not more than 30°.
The user should bear in mind that in some areas there may be restrictions on how and where this unit must be installed. Consult your dealer for further details.
- ❑ **Wear gloves for safety. Make sure that wiring is completed before installation.**
- ❑ **To prevent damage to the unit, do not connect the power connector until the whole wiring is completed.**
- ❑ **Do not connect more than one speaker to one set of speaker leads. (except for connecting to a tweeter)**

Observe the following cautions when handling the battery for the remote control unit.

- Use only specified battery (CR2025).
- Match the polarity of the battery with the (+) and (-) marks in the battery case.
- Replace dead battery as soon as possible.
- Remove the battery from the remote control unit when not using it for an extended period of time.
- Insulate the battery (by placing them in a plastic bag or covering them with vinyl tape) before disposal or storage.
- Dispose of the battery according to the local regulations.
- Do not disassemble, recharge, heat or short the battery. Do not throw a battery into a fire or water.

In case of battery leakage

- Thoroughly wipe the battery liquid off the battery case and insert new battery.
- If any part of your body or clothing comes into contact with battery liquid, wash it with plenty of water.
- If battery liquid comes into contact with your eyes, wash them with plenty of water and get immediate medical attention.

Safety Information (continued)

Laser Product

Label Indications and Their Locations

CAUTION
LASER RADIATION WHEN OPEN. DO NOT STARE INTO BEAM.

Caution

THIS PRODUCT IS A CLASS 1 LASER PRODUCT. USE OF CONTROLS OR ADJUSTMENTS OR PERFORMANCE OF PROCEDURES OTHER THAN THOSE SPECIFIED HEREIN MAY RESULT IN HAZARDOUS RADIATION EXPOSURE.

DO NOT OPEN COVERS AND DO NOT REPAIR BY YOURSELF. REFER SERVICING TO QUALIFIED PERSONNEL.

Do not take apart this unit or attempt to make any changes yourself.

This unit is a very intricate device that uses a laser pickup to retrieve information from the surface of compact discs. The laser is carefully shielded so that its rays remain inside the cabinet.

Therefore, never try to disassemble the player or alter any of its parts since you may be exposed to laser rays and dangerous voltages.

CLASS 1 LASER PRODUCT

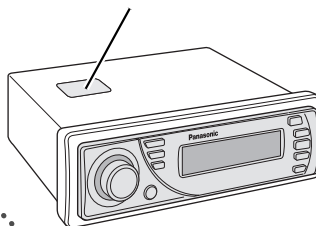

CAUTION - LASER RADIATION WHEN OPEN. AVOID EXPOSURE TO BEAM.	VAROITUS - LASER-SÄTEILYVAARA AVATTAESSA. VARO ALITUMISTA SÄTEELLE.
VORSICHT - LASERSTRAHLUNG. WENN GEÖFFNET, VERMEIDEN SIE EIN AUSSETZEN GEGENÜBER DEM LASERSTRAHL.	FÖRSIKTIGHET - LASERSTRÅLNING I ÖPPNAT LÄGE. UNDVIK ATT UTSÄTTAS FÖR STRÅLEN.
ATTENTION - RAYONNEMENT LASER SI OUVREZ, ÉVITER TOUTE EXPOSITION AU FAISCEAU.	ADVASEL - LASERSTRÅLNING. UNNGÅ EKSPONERING FÖR STRÅLEN VED ÖPNING.
ADVASEL - LASER UDSENDES NAR DER ER ÅBNET. UNDGÅ UDSÆTTELSE FOR STRÅLER.	ВНИМАНИЕ - ЛАЗЕРНОЕ ИЗЛУЧЕНИЕ ПРИ ОТКРЫТИИ. ИЗБЕЖАТЬ ВОЗДЕЙСТВИЯ ЛАЗЕРНОГО ИЗЛУЧЕНИЯ.

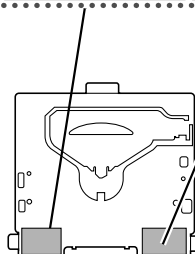

Deck Ass'y (Upper Side)

Before Reading These Instructions

Panasonic welcomes you to our constantly growing family of electronic products owners. We endeavor to give you the advantages of precise electronic and mechanical engineering, manufactured with carefully selected components, and assembled by people who are proud of the reputation their work has built for our company. We know this product will bring you many hours of enjoyment, and after you discover the quality, value and reliability we have built into it, you too will be proud to be a member of our family.

Differences Among 2 Models

This operating instruction manual is for 2 models CQ-C7703N and CQ-C7303N.

The difference among these models' are mentioned below.

All screens and main body illustrations in this book represent CQ-C7703N unless otherwise specified.

Features	Models	CQ-C7703N	CQ-C7303N
Amplifier		Digital	Analog
Max. output		70 W	50 W
Power Output		40 W	23 W
AUX Setting (→ page 34)		Yes	No

The instruction manual consists of 2 books. One is "Operating Instructions" describing the operations of the main unit. The other is "System Upgrade Guidebook" describing the optional devices such as CD changer.

Before Reading These Instructions



Operating Instructions

(YEFM285769)

Q'ty: 1



System Upgrade Guidebook

(YEFM262697)

Q'ty: 1



Installation Instructions

(YEFM294135)
(YEFM294136)
(YEFM294137)

Q'ty: 1 set



PAN EUROPEAN GARANTEE (Warranty Card)

Q'ty: 1



Remote Control Unit (including a battery) (CR2025)

(EUR7641010)

Q'ty: 1

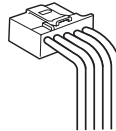

Power Connector

(YGAJ021010)

Q'ty: 1

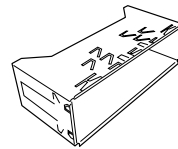

Mounting Collar

(YEFX0217222)

Q'ty: 1

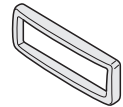

Trim Plate

(YEFM051013)

Q'ty: 1

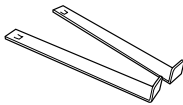

Lock Cancel Plate



Mounting Bolt (5 mmø)



ISO Antenna Adapter

(YEP0FZ5711)

Q'ty: 1 set



Removable Face Plate Case

(YEFM134150)

Q'ty: 1

Notes:

- The number in parenthesis underneath each accessory part name is the part number for maintenance and service.
- Accessories and their parts numbers are subject to modification without prior notice due to improvements.
- Mounting Collar and Trim Plate are mounted on the main unit at shipment.

Features

CQ-C7703N/C7303N

WMA MP3 CD Player/Receiver

Hands-Free Phone System

Connection of the optional Bluetooth Hands-Free Kit (Hands-Free Kit featuring *Bluetooth*® technology: CY-BT100N) allows users to talk on a handsfree cellular phone if the phone supports Bluetooth.

Note: This unit is designed **only for receiving calls**. It cannot send calls.

Bluetooth®

The Bluetooth word mark and logo are owned by the Bluetooth SIG, Inc. and any use of such marks by Matsushita Electric Industrial Co., Ltd. is under license. Other trademarks and trade name are those of their respective owners.

Expansion Module (hub unit)

Connection of the Expansion Module (hub unit, CY-EM100N) allows users to connect up to 4 optional devices shown below.

Wide array of components for system upgrade

Various optional components allow users to obtain availability of wide range of system upgrade. Upgrading the system delivers relaxed AV space in a car. For further information, refer to the separate **System Upgrade Guidebook**.

• DVD Changer

The optional adapter (Conversion Cable for DVD/CD Changer: CA-CC30N) allows you to connect the optional Panasonic DVD changer unit (CX-DH801N).

• CD Changer

The optional adapter (Conversion Cable for DVD/CD Changer: CA-CC30N) allows you to connect the optional Panasonic CD changer unit (CX-DP880).

• iPod®

The optional adapter (Direct Cable for iPod: CA-DC300N) allows you to connect the optional iPod series.

iPod is a trademark of Apple Computer, Inc., registered in the U.S. and other countries.

Sound Control

SQ (Sound Quality)

You have six preset modes (FLAT, ROCK, POP, VOCAL, JAZZ, CLUB). You can customize your settings for these and save them for instant recall.

SQ7

This is 7-band equalizer with 60, 160, 400, 1 k, 3 k, 6 k, and 16 kHz. Each band is adjustable between -12 dB and 12 dB in steps of 2 dB.

Customize

Initially stored moving images and still images are editable to taste. IMAGE STUDIO* allows you to process images from a digital camera or other devices without difficulty. (→ page 35)

* This software is downloadable from Panasonic Web site (<http://panasonic.co.jp/pas/en/software/customize/index.html>)



Information on Disposal for Users of Waste Electrical & Electronic Equipment (private households)

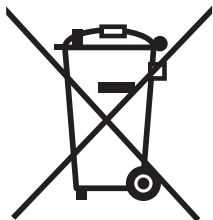

This symbol on the products and/or accompanying documents means that used electrical and electronic products should not be mixed with general household waste.

For proper treatment, recovery and recycling, please take these products to designated collection points, where they will be accepted on a free of charge basis. Alternatively, in some countries you may be able to return your products to your local retailer upon the purchase of an equivalent new product. Disposing of this product correctly will help to save valuable resources and prevent any potential negative effects on human health and the environment which could otherwise arise from inappropriate waste handling. Please contact your local authority for further details of your nearest designated collection point.

Penalties may be applicable for incorrect disposal of this waste, in accordance with national legislation.

For business users in the European Union

If you wish to discard electrical and electronic equipment, please contact your dealer or supplier for further information.

Information on Disposal in other Countries outside the European Union

This symbol is only valid in the European Union.

If you wish to discard this product, please contact your local authorities or dealer and ask for the correct method of disposal.

Contents

English

2

Deutsch	44
Français	86
Nederlands	128
Svenska	170
Italiano	212
Español	254
Dansk	296
Polska	338
Čeština	380
Magyar	422
Русский	464

Common

● Safety Information	2
● Before Reading These Instructions	4
● Features	6
● Controls Layout	8
● Preparation (ACC Setting etc.)	10
● General	12
● Sound Control	16

Each Source

● Radio	18
● Radio Data System (RDS) in FM Broadcasting	20
● CD Player	24
● MP3/WMA Player	26

As Needed

● Audio Setting	30
● Function Setting (Security Function Setting etc.)	31
● Display Setting	32
● AUX Setting	34
● Customize the Display (Customize Function)	35
● Troubleshooting	37
● Error Display Messages	41
● Notes on Discs	42
● Maintenance	42
● Specifications	43

Controls Layout

Note: This instruction manual explains operations for use with the buttons on the main unit. (Different operations excluded)

Main Unit

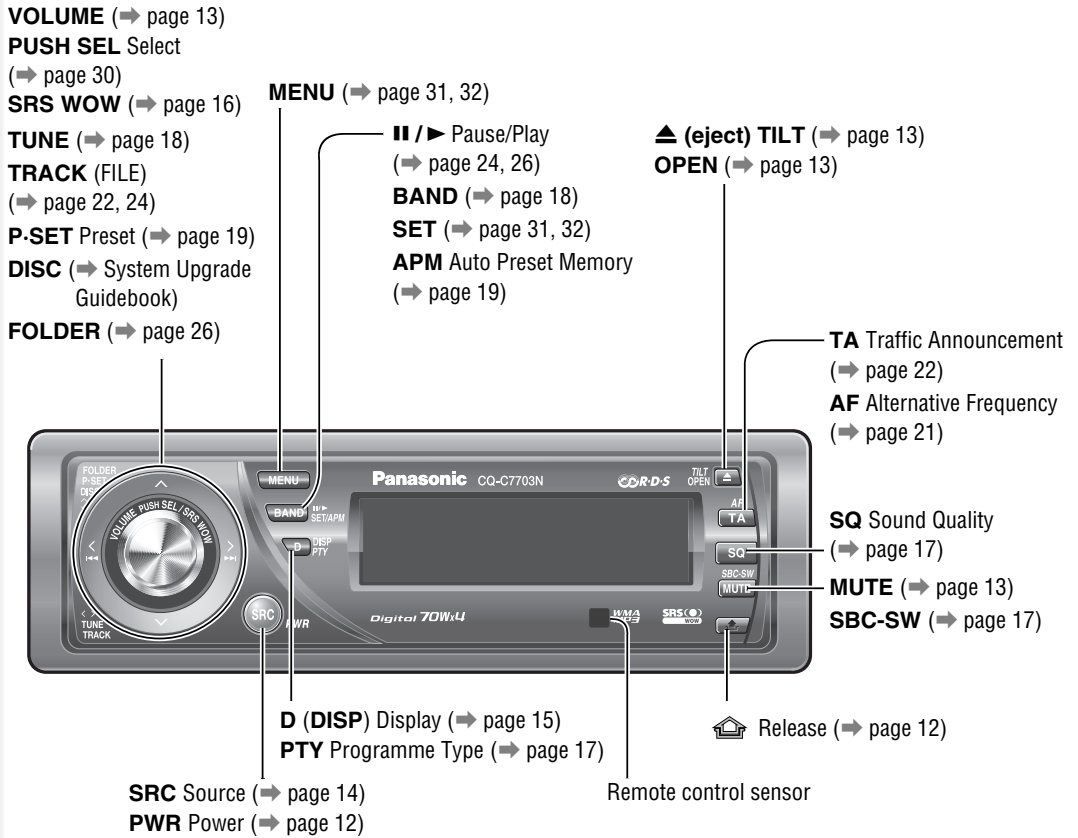

When Face Plate Opens

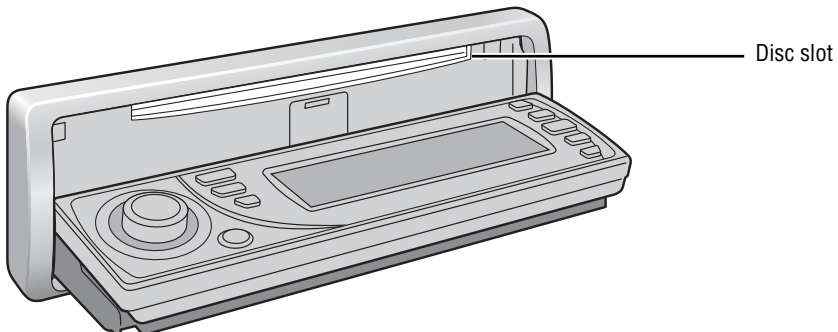

Remote Control Unit

Number Buttons

0 — 9 > 0 to 9

NUMBER Number

RANDOM 4 RANDOM

SCAN 5 SCAN

REPEAT 6 REPEAT

< 7 9 >

TUNE TRACK (FILE)

8 0

P-SET (Preset)
DISC (FOLDER)

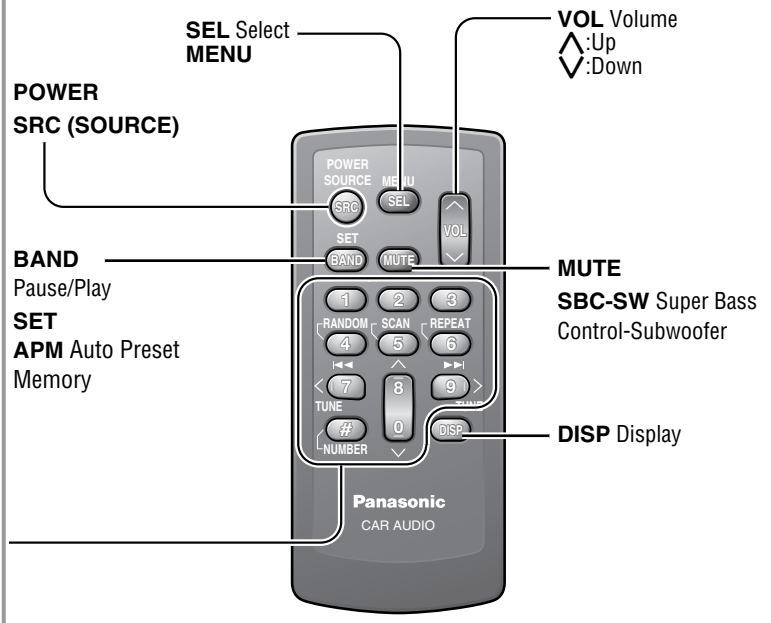

Operations executable only with main unit/
operations executable only with remote control

Although most of the functions of this unit are executable with both the main unit and remote control, the following functions are excluded.

Operations executable only with main unit

- Face panel's opening, closing, tilting, and removal actions (⇒ page 13)
- Disc ejection (⇒ page 13)
- SRS WOW on, off, and adjustment (⇒ page 16)
- SQ on, off, and adjustment (⇒ page 17)
- AF ON/OFF (⇒ page 21)
- TA ON/OFF (⇒ page 22)

Operations executable only with remote control

- Preset station calling with one-touch operation (⇒ page 19)
- Direct access to tracks on CDs (⇒ page 25, 27)
- Random and repeat play with one-touch operation (⇒ page 25, 27)
- Scan playback (⇒ page 25, 27)
- PI seek (⇒ page 21)

Preparation

Cancellation of demonstration screen

For the first use, the following screen may appear repeatedly.

1 Set your car's ignition switch to the ACC or On position.

2 Press [SRC] (PWR: POWER).
The demonstration screen appears.



3 Press [MENU] to display the menu display.

For using the remote control, hold down [SEL] (MENU) for 2 sec. or more.

4 Press [<] or [>] to display the DISPLAY menu.

5 Press [V] or [^] to select "DEMONSTRATION".

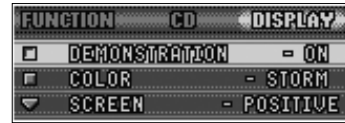

6 Press [BAND] (SET) to select "OFF"

7 Press [MENU].

For using the remote control, hold down [SEL] (MENU) for 2 sec. or more.

Note: This unit is operable as usual even if the demonstration screen is activated. The demonstration screen automatically appears if no operation is executed for 1 minute.

Preparation Before Initial Use

Pull the insulation film out from the backside of remote control gently.

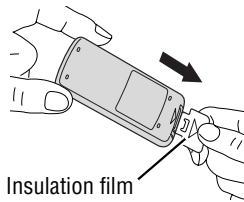

Insulation film

Warning

Keep batteries and insulation film out of reach of infants. If an infant ingests a battery, please seek immediate medical attention.

Cautions

- Remove and dispose of an old battery immediately.
- Do not disassemble, heat or short a battery. Do not throw a battery into a fire or water.
- Follow local regulations when disposing of a battery.
- Improper use of a battery may cause overheating, an explosion or ignition, resulting in injury or a fire.

Battery Replacement

1 Remove the battery holder with the remote control unit placed on a flat surface.

1 Stick your thumbnail into the groove, and push the holder in the direction of the arrow, and at the same time.

2 Pull it out in the direction of the arrow using a tough pointed object.

Tough pointed object

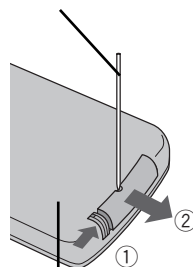

Back side

2 Put a battery in the case with (+) side facing up.

3 Put the case back.

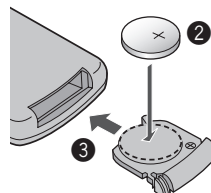

Note: Battery Information:

Battery Type: Panasonic lithium battery (CR2025)
(Included in the remote control)

Battery Life: Approximately 6 months under normal use
(at room temperature)

Remote Control Preparation

ACC Setting

Caution
 Be sure to select OFF when your car has no ACC position in the ignition switch. Failure to do this could cause the battery to go dead.

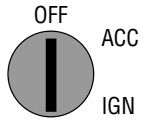

For a ACC-equipped car, select ON. (→ page 31) The following functions are available. (default: off)

- The power is turned on automatically when inserting a disc.
- The clock can be displayed even if the power is off. (→ page 15)

Security Function Setting

The following functions are activated when the Security Function is ON. (→ page 31)

- The security indicator lights up when removing the face plate.

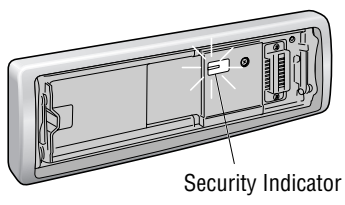

- The alarm sounds and the message appears on the screen to warn you to remove the face plate at ACC off. (The above phenomenon occurs when the ACC setting of the unit is set to ON at the ignition key is at the ACC off position or when the ACC setting of the unit is set to OFF at the power of the unit is off)



Other Settings

You may need to set the following depending on the devices to be connected.

Using Subwoofer

- Subwoofer level adjustment (→ page 30)
- Subwoofer low pass filter (→ page 30)

Connecting an AV device (TV, VTR)

Only for CQ-C7703N
 If you connect TV to AUX1 terminal, set the AUX setting to TV. (→ page 34)

Clock adjustment

Notes:

- Adjust the clock when "NO CT" appears on the display.
- When a broadcast of FM Radio Data System is received, the clock is put right automatically by the Clock Time service. (→ page 20)

- 1 Press [MENU] to display the menu display.
 For using the remote control, hold down [SEL] (MENU) for 2 sec. or more.
- 2 Press [<] or [>] to display the DISPLAY menu.
- 3 Press [V] to select "CLOCK ADJ".
- 4 Press [BAND] (SET) to confirm the display.

5 Adjust the setting value.



- [>]: Adjusting minutes
- [<]: Adjusting hours
- [^]: Forward
- [v]: Backward



- 6 Press [BAND] (SET) to confirm the adjustment.
- 7 Press [MENU].
 For using the remote control, hold down [SEL] (MENU) for 2 sec. or more.

General

This chapter explains how to turn on or off the power, how to adjust the volume, etc.

Power On/off (PWR: POWER)

Power on

Press **[SRC]** (**PWR: POWER**).

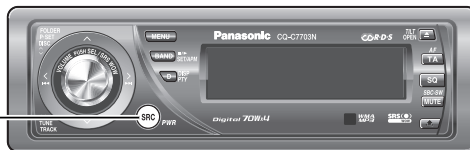

Power off

Hold down **[SRC]** (**PWR: POWER**) until you hear a beep, then release it.

You can remove the face plate to prevent it from being stolen.



Removing

- 1 Turn off the power (→ page 12)
- 2 Press **[⏏]** (Release).
(The face plate disengages with a click when it is removed.)



The face plate automatically closes after a lapse of 5 seconds while it is open.

The power is automatically turned off while the unit is active.

- 3 Put the face plate in the case.

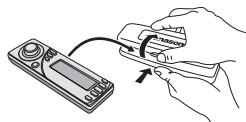

Mounting

- 1 Slide the left side of the face plate in place.

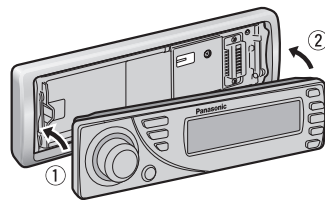

- 2 Press the right end of the face plate until "click" is heard.

Face Plate Removing/Mounting (ANTI-THEFT SYSTEM)

⚠ Cautions:

- It is recommended to remove or mount the face plate when the plate is at the closed position. Do not remove or mount the face plate when the plate is in motion.
- This face plate is not waterproof. Do not expose it to water or excessive moisture.
- Do not remove the face plate while driving your car.
- Do not place the face plate on the dashboard or nearby areas where the temperature rises to high levels.
- Do not touch the contacts on the face plate or on the main unit, since this may result in poor electrical contacts.
- If dirt or other foreign substances get on the contacts, wipe them off with clean and dry cloth.
- To avoid damaging the face plate, do not push it down or place objects on it while it is open.

Face Plate Motion (Open/Close, Tilt)

(OPEN/CLOSE, TILT)

Open/Eject

Press [▲] (OPEN).

When a disc is already loaded, the disc will automatically be ejected.

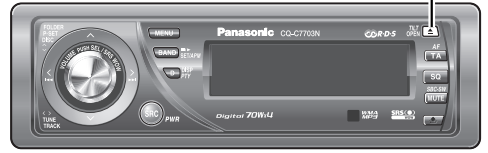
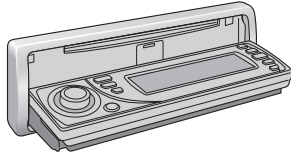

⚠ Cautions:

- To avoid damaging the face plate, do not push it down or place objects on it while it is open.
- Do not pinch your finger or hand in the face plate.
- Do not insert foreign objects into the disc slots.
- For the following cases, the face plate automatically closes. Use caution not to catch your finger.
 - After a lapse of 20 seconds
 - When a disc is inserted
 - When the face plate is removed (→ page 12)
 - When the power is set to off (at ACC-off)

Close

Press [▲] (OPEN).

Tilt

The display angle changes among 4 levels as follows every time you hold down [▲] (TILT) for 1 sec. or more and release.

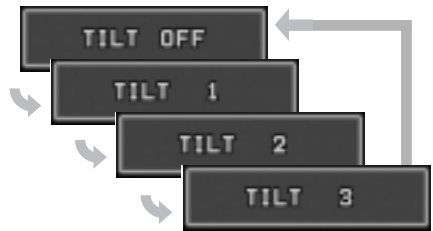

Note: The last selected angle is memorized even after turning off the power.

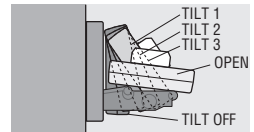

Volume Adjustment

(VOLUME)

- ① Up
- ② Down

Setting Range: 0 to 40
Default: 18

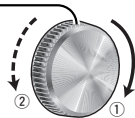

Notes:

- The volume level can be set independently for each source. (For radio, one volume setting for AM (LW/MW), one volume setting for all FMs)
- The volume is not adjustable while an error display is on the monitor. (→ page 41)
- This unit memorizes individual volume levels for each source. Make volume adjustments of each source appropriately to prevent large volume fluctuation when the source is changed.

Temporary Volume Off (Down)

MUTE (ATT: ATTENUATION)

Volume off (down)

Press [MUTE].



Cancel

Press [MUTE] again.

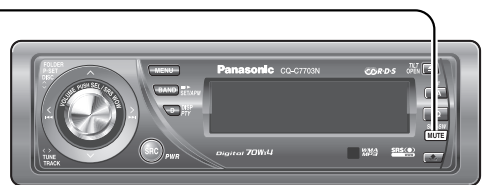

Note: Volume-down range can be specified. (→ page 31)

The source changes as follows every time [SRC] (SOURCE) is pressed.

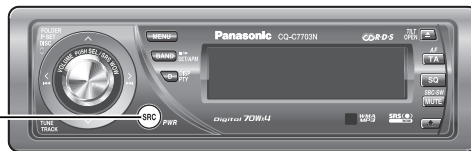

Radio

FM1, FM2, FM3, AM (LW/MW) (⇒ page 18)

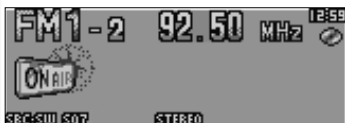

Player

When loading CD (⇒ page 24)



When loading MP3/WMA disc (⇒ page 26)



AUX 1

Device connected to the AUX terminal of the this unit

At connecting to other than a TV



At connecting to a TV
(only for CQ-C7703N ⇒ page 34)

System-up Connector

Device connected to the System-up Connector of this unit

When optional devices are connected:

Shift to connected devices

When an expansion module is connected:

The devices connected to the ports 1 to 4 are activated in sequence after shifting to AUX2 (devices connected to the AUX terminal of the expansion module).



When connecting DVD Changer



When connecting CD Changer

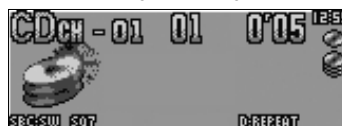

When connecting iPod

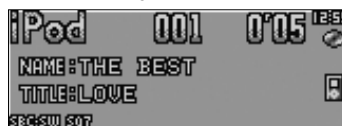

When connecting Expansion Module



Note: For information about connectable devices, refer to the **System Upgrade Guidebook** or the instruction manual for each device.

Display Change
(DISP.: DISPLAY)

The display changes as follows every time [D] (DISP.: DISPLAY) is pressed.
Note: The graphic pattern and still image are selectable. (→ page 32)

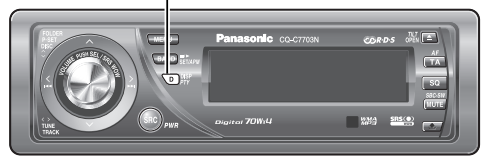

At power-on:

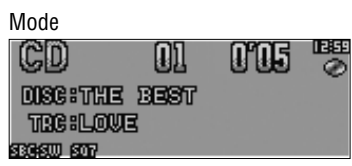

Display Off
All displays disappear in 5 seconds.



Folder hierarchy (MP3/WMA mode only.)

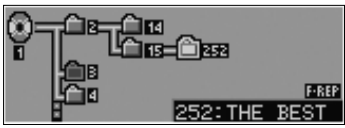

Ordinary display + clock



Ordinary display + graphic pattern



Only still image



Only graphic pattern

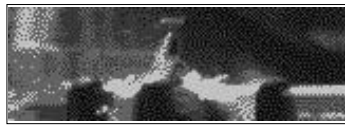

Ordinary display + still image



Note: The Spectrum Analyzer equalizer of 19 bands (S.A.) is selectable when selecting a graphic pattern.

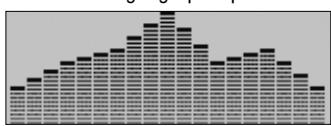

At power-off:

Note: The clock appears only at ACC on setting.

Clock display (default)



Off

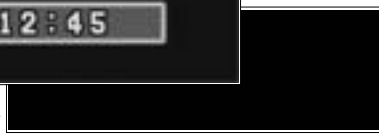

Sound Control

SRS WOW

SRS WOW™ is 3-D sound technology based on the HRTF (Head Related Transfer Function) theory. Unlike conventional audio systems, “natural 3-D sound field”, “rich bass”, and “crisp and clear sound” can be obtained at the same time in a wide area in front of speakers.

Holding down **[VOLUME] (SRS WOW)** for 2 sec. or more toggles SRS WOW on and off.

Note: If you enable SRS WOW, the following functions are automatically disabled:

SQ, BASS/TREBLE, BALANCE/FADER, HPF, SBC-SW

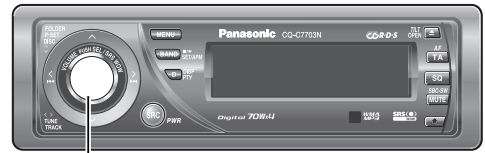

Lights when SRS WOW is activated.

You can make a fine adjustment to SRS WOW.

- 1 Set the SRS WOW mode to on.
- 2 Hold down **[SQ]** for 2 sec. or more to display the audio menu display.

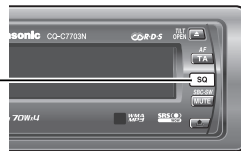

- 3 Press **[^]** or **[v]** to select a function to be adjusted.

- 4 Press **[BAND] (SET)** to adjust.

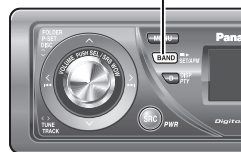

- 5 Press **[D] (DISP: DISPLAY)** to confirm the adjustment.

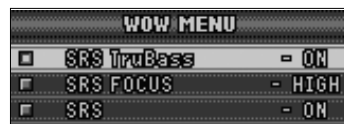

SRS TruBass®

ON : Deep bass enhancement by application of the bass reproduction technique of a pipe organ (default)

OFF : No enhancement

SRS FOCUS®

Sound image movement in a vertical direction to make sound crisp

HIGH : high (default)

LOW : low

OFF : off

SRS®

ON : Surround function on (default)

OFF : Surround function off

SRS WOW is a trademark of SRS Labs, Inc.

WOW technology is incorporated under license from SRS Labs, Inc..

SRS WOW Setting (SRS WOW Menu Display)

SQ Selection Based on Genre
(SQ: SOUND QUALITY)

The equalizer curve is selectable from among preset 6 types (FLAT, ROCK, POP, VOCAL, JAZZ, and CLUB) depending on your listening category.

Note: SQ is not changeable when SRS WOW is enabled. (→ page 18)

SQ changeover

The SQ category is changed every time [SQ] (SOUND QUALITY) is pressed.

Note: Setting of SQ, bass/treble and volume are influenced one another. If the influence mentioned above causes distortion to the audio signal, readjust bass/treble or volume. (→ page 30)



Lights when SQ is activated.

SQ adjustment
(USER)

SQ is adjustable in accordance with your taste.

- 1 Hold down [SQ] (SOUND QUALITY) for 2 sec. or more when SRS WOW is disabled.
- 2 Press [BAND].
The targeted SQ preset appears.
- 3 Adjust each band.

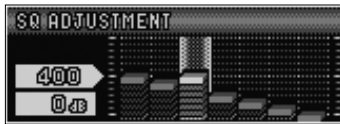

Band: 60, 160, 400, 1 k, 3 k, 6 k, 16 k (Hz)

[<|>]: Band selection
[^|v]: Level up/down



- 4 Press [BAND] to determine the adjustment.
The screen of Step 1 appears again.



- 5 Press [D] (DISP: DISPLAY).

The regular screen appears again. "USER" appears in the category name after adjustment.

Note: If you hold down [BAND] for 2 sec. or more on the SQ call-up screen, the presetting that is called up can be turned into the default.

Substitutional Subwoofer
(SBC-SW: SUPER BASS CONTROL-SUBWOOFER)

The rear speaker can be used as a substitutional subwoofer when a subwoofer is not connected.

Holding down [MUTE] (SBC-SW) for 2 sec. or more toggles SBC-SW on and off.

Off (default)



On



Lights when SBC-SW is activated.

Notes:

- If ON is selected, the settings of subwoofer level adjustment and subwoofer low pass filter are activated. (→ page 30)
- SBC-SW is not changeable when SRS WOW is enabled. (→ page 16)

Radio

This chapter explains how to listen to the radio.

Operation Flow

1 Press [**SRC**] (SOURCE) to select the radio mode.

2 Press [**BAND**] to select a band.



Notes:

- For tuning in on only stations whose receiving conditions are good in the station search, set LOCAL to ON. (⇒ page 19)
- For reducing noise when a receiving FM stereo wave is weak, set MONO to ON. (⇒ page 19)



3 Select a station.

Frequency adjustment

[<] (TUNE): Lower

[>] (TUNE): Higher

Note: Hold down for 0.5 sec. or more and release for station search.

Preset station selection

[V] (P-SET: Preset): Lower preset number

[^] (P-SET: Preset): Higher preset number

Note: Direct selection can be executed with [1] to [6] buttons on remote control.

Radio Mode Display

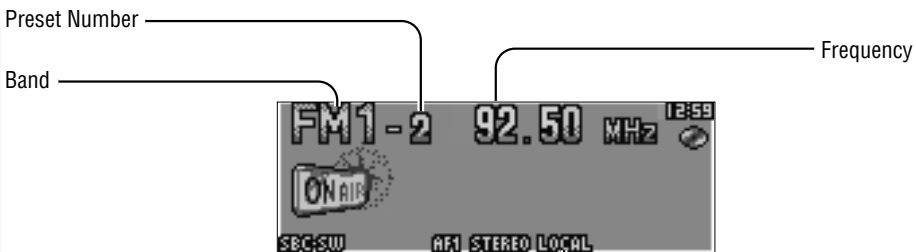

STEREO Lights while receiving an FM stereo signal.

MONO Lights when **MONO** is activated. (⇒ page 19)

Lights when **LOCAL** is activated. (⇒ page 19)

Up to 6 stations can be preset in AM (LW/MW), FM1, FM2, and FM3 respectively.

Preset stations can be simply called up by pressing [**^**] (**P.SET**) or [**v**] (**P.SET**).

Notes:

- Direct selection can be executed with [**1**] to [**6**] buttons on remote control.
- You can switch between 6 and 18 for FM presetting stations. (EACH BAND/ALL BAND)

Auto Preset Memory (APM)

Stations with good receiving conditions automatically preset.

- 1 Select a band.
- 2 Hold down [**BAND**] (**APM**) for 2 sec. or more.



The preset stations under best receiving conditions are received for 5 sec. each after presetting the stations (SCAN). To stop scanning, press [**^**] or [**v**].

Notes:

- New stations overwrite existing saved stations.
- Only RDS stations will be saved at default setting (AF ON). To select non RDS stations too, set AF OFF. (→ page 21)

Manual station preset

- 1 Tune in to a station.
 - 2 Hold down [**^**] or [**v**] for 2 sec. or more.
 - 3 Select a preset number by pressing [**^**] or [**v**].
- Note:** If [**BAND**] is pressed while receiving an FM station, FM broadcasting is changeable among FM 1 to FM 3.
- 4 Hold down [**BAND**] (**SET**) for 2 sec. or more to determine the selection.

Notes:

- In step 2, a station can be registered by holding down the numeric button [**1**] to [**6**] for 2 sec. or more.
- To stop presetting stations, press [**D**] (**DISP: DISPLAY**).
- The operation above allows users to replace the current station with the station preset in the selected number while selecting a preset station.

Only LOCAL is available while receiving an AM station.

- 1 Press [**MENU**] to display the menu display.

For using the remote control, hold down [**SEL**](**MENU**) for 2 sec. or more.

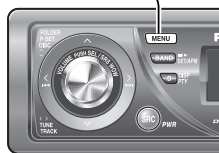

- 2 Press [**^**] or [**v**] to select a mode to be adjusted.

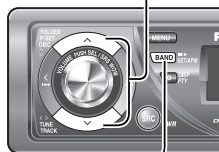

- 3 Press [**BAND**] (**SET**) to adjust.

- 4 Press [**MENU**] to confirm the adjustment.

For using the remote control, hold down [**SEL**](**MENU**) for 2 sec. or more.



MONO (Monaural)

Noise reduction when the signal strength decreases

OFF: Receiving in stereo (default)

ON: Receiving in mono and reducing the noise level

LOCAL

Setting when searching for a station

OFF: Searching even for a relatively low-intensity radio wave station (default)

ON: Searching only for a high-intensity radio wave station

PRESET

Preset range for FM bands

ALL BAND: Setting of FM1-3 together (default)

EACH BAND: Individual setting for FM1-3 each

Radio Data System (RDS) in FM Broadcasting

Useful functions such as **AF**, **TA**, **PTY**, etc. are available in the RDS (Radio Data System)-ready areas.

Some FM stations are broadcasting added data compatible with RDS. This radio set offers convenient functions using such data.

RDS service availability varies with areas. Please understand if RDS service is not available in your area, the following service is not available, either.

The following functions are available when receiving RDS stations.

AF (Alternative Frequency)

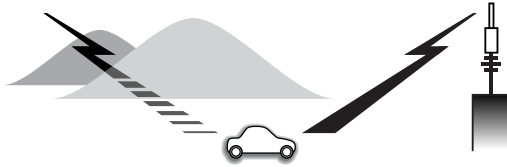

The following functions are available when the AF mode is active (→ page 21).

- When receiving conditions become bad, a station with better receiving conditions is automatically tuned in to.
- When executing APM, only RDS stations are selected.
- When calling up a preset station, a best receiving station is selected automatically. (**BSR** Best Stations Research)

Notes:

- The AF sensitivity can be adjusted. (→ page 22)
- The AF available range can be adjusted. (→ page 22)

TA (Traffic Announcement)

The following functions are available when the TA mode is active. (→ page 22)

- A TP (Traffic program) station is automatically searched for and received at the instant of toggling the TA mode on if you are receiving a non-TP station.
- When executing station search or APM, only TP stations are selected.
- Setting to TA on with the unit in another mode, it will automatically switch to radio mode and output the traffic announcement when the traffic announcement begins. The traffic announcement having finished, the unit will return to the previous mode. (TA Standby Mode)



PTY (Program Type)



The following functions are available when the PTY mode is active (→ page 23).

- The PTY of receiving station appears.
- Programs can be searched for by PTY.

Note: PTY language can be selected (→ page 23).

Other functions of RDS

CT (Clock Time)

The clock is automatically adjusted.

PS (Program Service Name)

As well as the frequency, the name of the broadcast station appears.

EON (Enhanced Other Network)

RDS information is updated constantly in response to the current position.



Lights while receiving the EON signal.

EON-TA

Traffic information from the current and other network stations can be received.

Emergency Announcement Reception

Emergency announcement automatically appears on the display when it is received.



RDS mode display

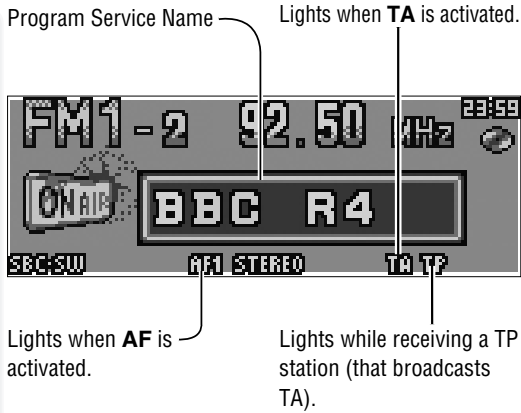

PTY on display

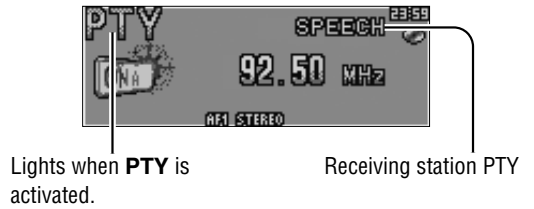

TA receiving display

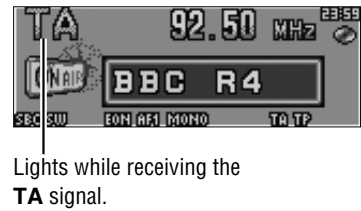

AF ON/OFF

Holding down [TA] (AF) for 2 sec. or more toggles AF on and off. Set AF to off for presetting a non-RDS station or other cases.

Note: This operation is not adjustable by the remote control.



PI Seek (Program Identification Seek)

(only by remote control unit)
If reception becomes poor when tuning in a preset station, press the same preset number button. The same station with better reception will be searched for. Press the same preset number button again to cancel.



Note: For PI Seek, cancel the TA mode first, then execute PI Seek.

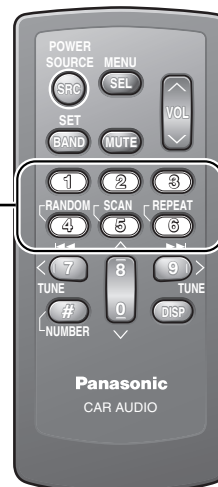

AF
(AF: ALTERNATIVE FREQUENCY)

Radio Data System (RDS) in FM Broadcasting

TA

(TA: TRAFFIC ANNOUNCEMENT)

TA ON/OFF

Pressing **[TA]** toggles TA on and off.

Notes:

- This operation is not adjustable by the remote control.
- Traffic information is available in monaural.
- Adjust the TA volume only while receiving a TA.



Lights when **TA** is activated.

AF/Region Setting (FM Menu Display)

(AF: ALTERNATIVE FREQUENCY/REGION)

- 1 Press **[MENU]** to display the menu display.

For using the remote control, hold down **[SEL] (MENU)** for 2 sec. or more.

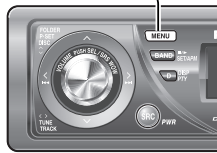

- 2 Press **[^]** or **[v]** to select a mode to be adjusted.

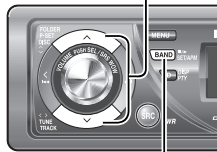

- 3 Press **[BAND] (SET)** to adjust.

- 4 Press **[MENU]** to confirm the adjustment.

For using the remote control, hold down **[SEL] (MENU)** for 2 sec. or more.



AF

Adjusting the AF sensitivity

AF 1 : Switching immediately after the receiving sensitivity becomes low (for a suburban area with a fine view) (default) (**AF1** lights.)

AF 2 : No switching even after the receiving sensitivity temporarily becomes low (for an area with a obstructed view) (**AF2** lights.)

REGION

Setting the AF range

OFF : The frequency is changed also for programs outside the region. (default)

ON : The frequency is changed only for programs within the region.

PTY ON/OFF

Holding down **[D]** (PTY) for 2 sec. or more toggles PTY mode on and off.



Program Search by PTY

Programs can be searched for by use of PTY that has been originally preset.

Press **[^]** or **[v]** to select PTY in the PTY mode.

	Program Type	Contents
1	NEWS	NEWS
2	SPEECH	AFFAIRS, INFO, EDUCATE, DRAMA, CULTURE, SCIENCE, VARIED, WEATHER, FINANCE, CHILDREN, SOCIAL, RELIGION, PHONE IN, TRAVEL, LEISURE, DOCUMENT
3	SPORT	SPORT
4	POP M	POP M
5	CLASSICS	CLASSICS
6	MUSIC	ROCK M, EASY M, LIGHT M, OTHER M, JAZZ, COUNTRY, NATION M, OLDIES, FOLK M

Another station in the same PTY is searched for by pressing **[BAND]** (SET).



Notes:

- Direct Access can be executed with **[1]** to **[6]** buttons on remote control.
- When there is no corresponding program type station, "NONE" is displayed.
- A desired PTY appears for 5 seconds.
- Preset contents are changeable.

Detailed PTY Selection

1 Press **[<]** or **[>]** to select PTY.

→ SPEECH ↔	MUSIC ↔	NEWS ↔	AFFAIRS ↔
INFO ↔	SPORT ↔	EDUCATE ↔	DRAMA ↔
CULTURE ↔	SCIENCE ↔	VARIED ↔	POP M ↔
ROCK M ↔	EASY M ↔	LIGHT M ↔	CLASSICS ↔
OTHER M ↔	WEATHER ↔	FINANCE ↔	CHILDREN ↔
SOCIAL ↔	RELIGION ↔	PHONE IN ↔	TRAVEL ↔
LEISURE ↔	JAZZ ↔	COUNTRY ↔	NATION M ↔
OLDIES ↔	FOLK M ↔	DOCUMENT ←	

2 Press **[BAND]** (SET).



Search starts.

Notes:

- To stop searching, press **[BAND]** (SET).
- When there is no corresponding program type station, "NONE" is displayed.

PTY Preset Change

Original PTY presets can be changed as you like.

- 1** Select a PTY that you would like to pre-set.
- 2** Follow the procedure of ordinary presetting. (→ page 18)

PTY language selection

Note: PTY language is selectable only when PTY appears.

1 Press **[MENU]** to display the menu display.

For using the remote control, hold down **[SEL]** (MENU) for 2 sec. or more.



2 Press **[BAND]** (SET) to adjust.

- | | | |
|---------------------|---|--------------------|
| ENGLISH :English | → | DEUTSCH :German |
| → ESPAÑOL :Spanish | → | → SWENSKA :Swedish |
| → ITALIANO :Italian | → | → FRANÇAIS :French |
| → NEDERLANDS :Dutch | → | (Back to ENGLISH) |

3 Press **[MENU]** to confirm the adjustment.

For using the remote control, hold down **[SEL]** (MENU) for 2 sec. or more.

PTY
(PTY: PROGRAM TYPE)

CD Player

Operation Flow

When a disc is already loaded, press **[SRC]** (SOURCE) to select the CD mode.

1 Press **[▲]** (**OPEN**) to open the face plate.

When a disc is already loaded (● lights), the disc will automatically be ejected.

2 Load a disc with the printed side facing up.

The face plate closes automatically, and the unit recognizes the disc and starts playing automatically, too.

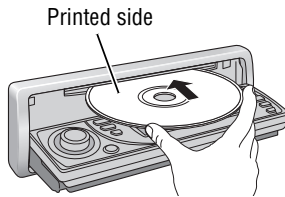

Note: The panel automatically closes after 20 seconds.

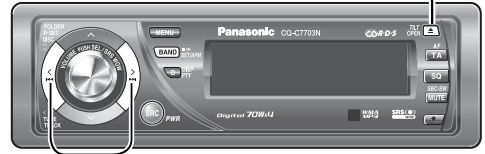

3 Select a desired portion.

Track selection

[▶▶] (**TRACK**): Next track

[◀◀] (**TRACK**): Preceding track (press twice)

Note: Hold down for fast forward/reverse.

Pause

Press **[BAND]** (**|| / ▶**).

Press again to cancel.

4 Press **[▲]** (**OPEN**) to eject the disc.

CD Mode Display

Track number

Time



CD-TEXT display

Notes:

- For scrolling text, hold down **[D]** (**DISP: DISPLAY**) for 2 sec. or more.
- "NO TEXT" is displayed when there is no information on the disc.

Play Mode indicators

Lights when each mode is activated.

RANDOM

REPEAT

SCAN

Lights when the disc is loaded.

⚠ Cautions:

- This unit does not support 8 cm discs.
- Do not use irregularly shaped discs. (➔ page 42)
- Do not use discs that have a seal or label attached.
- To avoid damaging the face plate, do not push it down or place objects on it while it is open.
- Do not pinch your finger or hand in the face plate when the face plate is in motion.
- Do not insert foreign matter into the disc slots.
- Refer to the section on "Notes on CD/CD Media (CD-ROM, CD-R, CD-RW)" (➔ page 42).
- This unit does not support a MIX mode CD (a CD containing both CD-DA and MP3/WMA data). In case of using such a CD, problems may occur such as anacoustic playback.

Random, Repeat Play (CD Menu Display)

(RANDOM, REPEAT)

Random and Repeat play can be set.

1 Press [MENU] to display the menu display.

For using the remote control, hold down [SEL] (MENU) for 2 sec. or more.

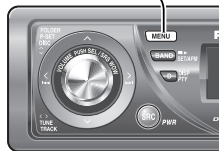

2 Press [▲] or [▼] to select a mode to be adjusted.

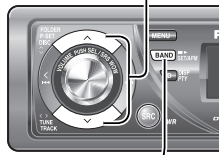

3 Press [BAND] (SET) to adjust.

4 Press [MENU] to confirm the adjustment.

For using the remote control, hold down [SEL] (MENU) for 2 sec. or more.



RANDOM

OFF: Off (default)

ON: Random playback

REPEAT

OFF: Off (default)

ON: Playing the current track repeatedly

TEXT (CD-TEXT)

ON: Enabled (default)

OFF: Disabled

Play Mode Selection

One-touch operation is available for selecting a track playing style by use of [RANDOM] or [REPEAT].

RANDOM

Press [RANDOM].

Press again to cancel.

REPEAT

Press [REPEAT].

Press again to cancel.

SCAN play

You can find your favorite file by playing first 10-sec. of each track.

Press [SCAN].

Press again to cancel.

Direct Access

A track can be directly selected.

Example: track number 5

1 Press [#] (NUMBER).

2 Press [5].

3 Press [SET].



Note: To suspend direct selection, press [DISP] (DISPLAY).

Functions Only by Remote Control Unit

MP3/WMA Player

Operation Flow

When a disc is already loaded, press **[SRC]** (SOURCE) to select the MP3/WMA mode.

- 1 Press **[▲]** (**OPEN**) to open the face plate.

When a disc is already loaded (● lights), the disc will automatically be ejected.

- 2 Load a disc with the printed side facing up.

The face plate closes automatically, and the unit recognizes the disc and starts playing automatically, too. (It may take several minutes to start for a disc that has a lot of files.)

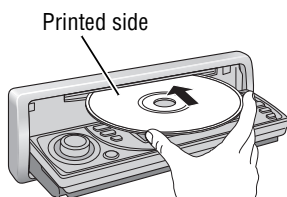

Note: The panel automatically closes after 20 seconds.

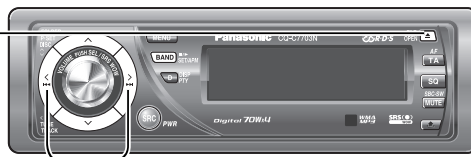

- 3 Select a desired portion.

Folder selection

[^] (**FOLDER**): Next folder

[v] (**FOLDER**): Preceding folder

File selection

[▶▶] (**TRACK**): Next file

[◀◀] (**TRACK**): Preceding file (press twice)

Note: Hold down for fast forward/reverse.

Pause

Press **[BAND]** (**||▶**).

Press again to cancel.

- 4 Press **[▲]** (**OPEN**) to eject the disc.

MP3/WMA Mode Display

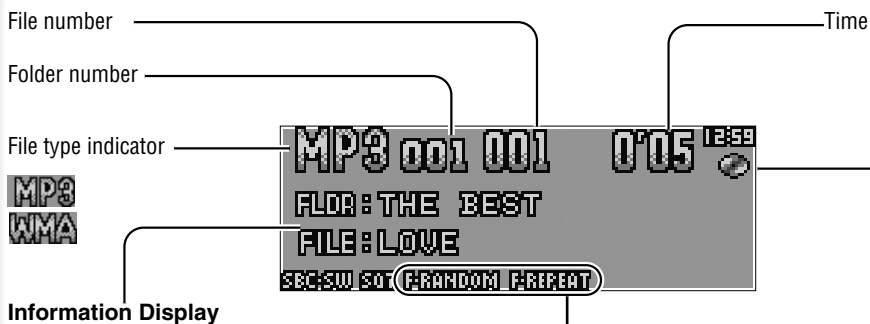

Notes:

- For scrolling text, hold down **[D]** (**DISP: DISPLAY**) for 2 sec. or more.
- "NO TEXT" is displayed when there is no information on the disc.
- ID3/WMA tag information is displayed for the album name and title/artist name.

Play Mode indicators

Lights when each mode is activated.

RANDOM

REPEAT

SCAN

F-RANDOM (Folder Random)

F-REPEAT (Folder Repeat)

F-SCAN (Folder Scan)

Lights when the disc is loaded.

Notes:

- Refer to the section on “Notes on MP3/WMA” (→ page 28)
- This unit does not support a MIX mode CD (a CD containing both CD-DA and MP3/WMA data). In case of using such a CD, problems may occur such as anacoustic playback.

Random, Repeat Play (MP3/WMA Menu Display)

(RANDOM, REPEAT)

Random and Repeat play can be set.

- 1 Press **[MENU]** to display the menu display.

For using the remote control, hold down **[SEL] (MENU)** for 2 sec. or more.



- 2 Press **[^]** or **[v]** to select a mode to be adjusted.

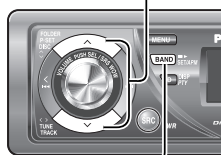

- 3 Press **[BAND]** (**SET**) to adjust.

- 4 Press **[MENU]** to confirm the adjustment.

For using the remote control, hold down **[SEL] (MENU)** for 2 sec. or more.

**RANDOM**

OFF : Off (default)

ON : Random playback (disc)

FOLDER RANDOM

OFF : Off (default)

ON : Random playback (folder)

REPEAT

OFF : Off (default)

ON : Playing the current file repeatedly

FOLDER REPEAT

OFF : Off (default)

ON : Playing the current folder repeatedly.

TEXT

FOLDER/FILE : Folder name/File name (default)

ALBUM/TITLE : Album/Title (tag information)

OFF : No display

Play Mode Selection

One-touch operation is available for selecting a track playing style by use of **[RANDOM]** or **[REPEAT]**.

RANDOM, REPEAT

Press the button. Press again to cancel.

FOLDER RANDOM, FOLDER REPEAT

Hold down the button for 2 sec. or more. Hold down again to cancel.

SCAN play

You can find your favorite file by playing first 10-sec. of each file.

SCAN (All files)

Press **[SCAN]**. Press again to cancel.

FOLDER SCAN (1st file in each folder)

Hold down **[SCAN]** for 2 sec. or more. Hold down again to cancel.

Direct Access

A file in the current folder can be directly selected.

Example: file number 5

- 1 Press **[#] (NUMBER)**.

- 2 Press **[5]**.

- 3 Press **[SET]**.

**Notes:**

- For folder selection, enter a number after pressing **[#] (NUMBER)** twice.
- To suspend direct selection, press **[DISP]** (DISPLAY).

Functions Only by Remote Control Unit

What is MP3/WMA?

MP3 (MPEG Audio Layer-3) and WMA (Windows Media™ Audio) are the compression formats of digital audio. The former is developed by MPEG (Motion Picture Experts Group), and the latter is developed by Microsoft Corporation. Using these compression formats, you can record the contents of about 10 music CDs on a single CD media (This figures refer to data recorded on a 650 MB CD-R or CD-RW at a fixed bit rate of 128 kbps and a sampling frequency of 44.1 kHz).

Note: MP3/WMA encoding and writing software is not supplied with this unit.

Points to remember when making MP3/WMA files

Common

- High bit rate and high sampling frequency are recommended for high quality sounds.
- Selecting VBR (Variable Bit Rate) is not recommended because playing time is not displayed properly and sound may be skipped.
- The playback sound quality differs depending on the encoding circumstances. For details, refer to the user manual of your own encoding software and writing software.

MP3

- It is recommended to set the bit rate to “128 kbps or more” and “fixed”.

WMA

- It is recommended to set the bit rate to “64 kbps or more” and “fixed”.
- Do not set the copy protect attribute on the WMA file to enable this unit to play back.



Caution:

Never assign the “.mp3”, or “.wma” file name extension to a file that is not in the MP3/WMA format. This may not only produce noise from the speaker damage, but also damage your hearing.

Display Information

Displayed items

- | | |
|------------------|------------------------|
| • CD-TEXT | • MP3 (ID3 tag) |
| Disc title | Album name |
| Track title | Title name/artist name |
| • MP3/WMA | • WMA (WMA tag) |
| Folder name | Album name |
| File name | Title name/artist name |

Displayable characters

- Displayable length of file name/folder name: within 64 characters (Unicode file and folder names are reduced by half in the number of displayable characters.)
- Name files and folders in accordance with the standard of each file system. Refer to the instructions of writing software for details.
- ASCII character set and special characters in each language can be displayed.

ASCII character set

A to Z, a to z, digits 0 to 9, and the following symbols:

(space) ! " # \$ % & ' () * + , - . / : ; < = > ? @ [\] ^ _ ` { | } ~

Notes:

- With some software in which MP3/WMA format files have been encoded, the character information may not be displayed properly.
- Undisplayable characters and symbols will be converted into an asterisk (*).

Recording MP3/WMA files on a CD-media

- You are recommended to minimize the chances of making a disc that contains both CD-DA files and MP3/WMA files.
- If CD-DA files are on the same disc as MP3 or WMA files, the songs may not play in the intended order, or some songs may not play at all.
- When storing MP3 data and WMA data on the same disc, use different folders for each data.
- Do not record files other than MP3/WMA files and unnecessary folder on a disc.
- The name of an MP3/WMA file should be added by rules as shown in the following descriptions and also comply with the rules of each file system.
- You may encounter trouble in playing MP3/WMA files or displaying the information of MP3/WMA files recorded with certain writing software or CD recorders.
- The file extension “.mp3” or “.wma” should be assigned to each file depending on the file format.
- This unit does not have a play list function.
- Although Multi-session recording is supported, the use of Disc-at-Once is recommended.

Supported file systems

ISO 9660 Level 1/Level 2, Apple Extension to ISO 9660, Joliet, Romeo

Note: Apple HFS, UDF 1.50, Mix CD and CD Extra are not supported.

Compression formats

(Recommendation: “Points to remember when making MP3/WMA files” on the previous page)

Compression method	Bit rate	VBR	Sampling frequency
MPEG 1 audio layer 3 (MP3)	32 k – 320 kbps	Yes	32, 44.1, 48 kHz
MPEG 2 audio layer 3 (MP3)	8 k – 160 kbps	Yes	16, 22.05, 24 kHz
Windows Media Audio Ver. 2, 7, 8, 9*	32 k – 192 kbps	Yes	32, 44.1, 48 kHz

* WMA 9 Professional/LossLess/Voice are not supported.

Folder selection order/file playback order

Maximum number of files/folders

- Maximum number of files: 511 (files + folders)
- Maximum number of files in one folder: 255
- Maximum depth of trees: 8
- Maximum number of folders: 255 (Root folder is included.)

Notes:

- You can shorten the duration between data read and playback by decreasing the quantity of files or folders, or the depth of the hierarchy.
- This unit counts the number of folders irrespective of the presence or absence of an MP3/WMA file.
- If the selected folder does not contain any MP3/WMA files, the nearest MP3/WMA files in the order of playback will be played.
- Playback order may be different from other MP3/WMA players even if the same disc is used.
- “ROOT” appears when displaying the root folder name.

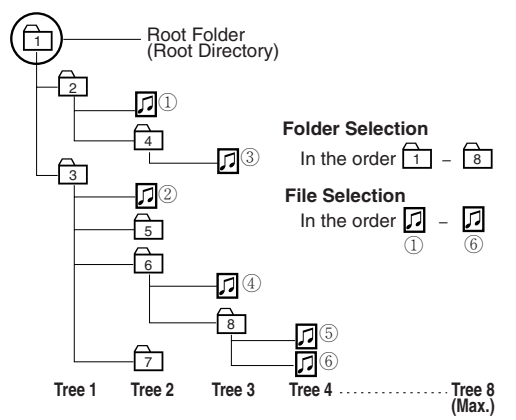

Copyright

It is prohibited by copyright laws to copy, distribute and deliver copyrighted materials such as music without the approval of copyright holder except enjoying yourself personally.

No warranty

Above description complies with our investigations as of December 2005. It has no warranty for reproducibility and displayability of MP3/WMA.

Audio Setting

Adjustment to each speaker and an optional subwoofer

- 1 Press [VOLUME] (PUSH SEL: SELECT) to display the AUDIO menu display.



- 2 Press [VOLUME] (PUSH SEL: SELECT) to select a mode to be adjusted.

- 3 Turn [VOLUME] clockwise or counterclockwise to adjust.

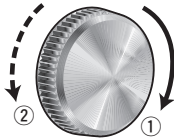

Notes:

- If no operation takes place for more than 10 seconds in the audio menu (2 sec. in Main volume adjustment), the display returns to the regular mode.
- Only the main volume, subwoofer level, subwoofer low pass filter, and rear level are adjustable when SRS WOW is enabled. (→ page 16)

Main volume adjustment

(Setting range: 0 to 40, Default: 18)

- ① : Up
- ② : Down

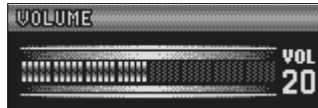

Bass adjustment

(Setting range: -12 dB to +12 dB, 2 dB Step, Default: Bass 0 dB)

- ① : Up
- ② : Down



Treble adjustment

(Setting range: -12 dB to +12 dB, 2 dB Step, Default: Treble 0 dB)

- ① : Up
- ② : Down



Note: Do not activate SQ and Bass/Treble at same time to avoid causing sound distortion.

Balance adjustment

(Setting range: L (left) 15 to R (right) 15 and Centre, Default: Centre)

- ① : Right enhanced
- ② : Left enhanced



Fader adjustment

(Setting range: R (rear) 15 to F (front) 15 and Centre, Default: Centre)

- ① : Front enhanced
- ② : Rear enhanced



Subwoofer level adjustment

(Setting range : mute (-∞), -6 dB to +6 dB, 2 dB Step, Default: 0 dB)

- ① : Up
- ② : Down



Subwoofer Low Pass Filter

(Setting range: 80 Hz, 120 Hz, 160 Hz, Default: 80 Hz)

- ① : Up
- ② : Down



Subwoofer output range
Other speakers output ranges

High Pass Filter

(Setting range: Filter OFF, 90 Hz, 135 Hz, 180 Hz, 225 Hz, Default: Filter OFF)

- ① : Up
- ② : Down



Rear Level Adjustment (SRS WOW)

(Setting range: 0 to -15, Default: -10)

- ① : Up
- ② : Down



Note: The rear level is adjustable only when SRS WOW is enabled. (→ page 16)

Function Setting

Adjustment to display on the FUNCTION menu

- 1 Press **[MENU]** to display the menu display.

For using the remote control, hold down **[SEL] (MENU)** for 2 sec. or more.

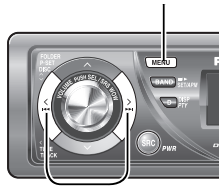

- 2 Press **[<]** or **[>]** to display the FUNCTION menu.



- 3 Press **[^]** or **[v]** to select a function to be adjusted.

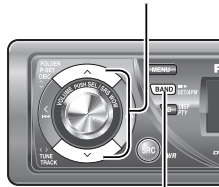

- 4 Press **[BAND] (SET)** to adjust.

- 5 Press **[MENU]** to confirm the adjustment.

For using the remote control, hold down **[SEL] (MENU)** for 2 sec. or more.

MUTE KEY

Setting **[MUTE]** buttons' functions

MUTE : Volume off (default)

MUTE LV 1 : Volume down by 10 steps

MUTE LV 2 : Volume down by 5 steps

EXT.MUTE (External Mute)

Volume adjustment when an interruption such as car navigation signal occurs

LEVEL 0 : Volume off (default)

LEVEL 1 : Volume down by 10 steps

LEVEL 2 : Volume down by 5 steps

OFF : No change in volume

(External muting display)



SECURITY

Setting the security function (→ page 11)

ON : ON (default)

OFF : OFF

ACC

Setting depending on your car

OFF : ACC not equipped (default)

ON : ACC equipped

! Caution

Be sure to select **OFF** when your car has no **ACC** position in the ignition switch. Failure to do this could cause the battery to go dead.

BUILT-IN AMP

You can toggle the integrated amplifier on and off.

ON : Amplifier on (default)

OFF : Amplifier off (when the external amplifier is used)

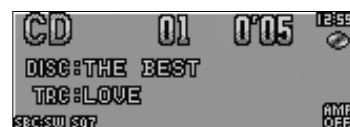

Lights when disactivated.

Display Setting

Adjustment to display on the DISPLAY menu

- 1 Press **[MENU]** to display the menu display.

For using the remote control, hold down **[SEL] (MENU)** for 2 sec. or more.

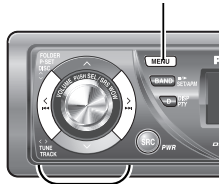

- 2 Press **[<]** or **[>]** to display the DISPLAY menu.

- 3 Press **[^]** or **[v]** to select a function to be adjusted.

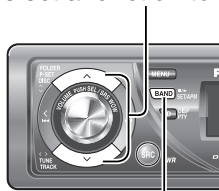

- 4 Press **[BAND] (SET)** to confirm the display.

- 5 Adjust the setting value.

- 6 Press **[BAND] (SET)**.

- 7 Press **[MENU]** to confirm the adjustment.

For using the remote control, hold down **[SEL] (MENU)** for 2 sec. or more.



DEMONSTRATION

Switching by **[BAND]**.

- ON:** Demonstration screen at no operation (default)
- OFF:** Regular screen

COLOR

(Setting range: 10 types, default: STORM)
The illumination color changes as follows.

Switching by **[^]** or **[v]**

STORM: The color varies in conjunction with time.

LEVEL: The peripheral color decoration lights up and goes out according to the bass volume.

FIRE: Red

ORANGE: Amber

SKY: Blue

OCEAN: Aquablue

FOREST: Green

SUN: Yellow

SNOW: White

CUSTOM: You can create your favorite color.



LEVEL ADJ

[<][>]: Function selection

[^][v]: Item selection

Color selection

The illumination color changes.

(Setting range: FIRE, ORANGE, SKY, OCEAN, FOREST, SUN, default: FIRE)

Volume setting according to lighting

(Setting range: LEVEL1, LEVEL2, LEVEL3, default: LEVEL 1)

If the peripheral color decoration keeps lighting because the bass part is contained abundantly, select LEVEL 1, and for the opposite case, select LEVEL 3.



CUSTOM ADJ

(Setting range: 0 to 100, default: R50, G50, B50)
You can adjust each color.



[<|>]: RGB selection
[^|v]: Adjustment (0 to 100)

SCREEN

Press [BAND] to select.

POSITIVE: white background (default)

NEGATIVE: black background

GRAPHIC PATTERN

(Setting range: 5 types, Default: All)

Switching by [<] or [>]

All: Sequential display from pattern A to C.

Pattern A-C

S.A.: 19-band display (Spectrum analyzer)



STILL IMAGE

(Setting range: 11types, Default: All)

Switching by [<] or [>]

All: Sequential display from pattern 1 to 10

No.1-10



CONTRAST

(Setting range: 1 to 5, Default: Contrast 3)

[>]: Tilting up view angle

[<]: Tilting down view angle



CLOCK ADJ

Note: Adjust the clock when "NO CT" appears on the display.

[>]: Adjusting minutes

[<]: Adjusting hours

[^]: Forward

[v]: Backward



Notes:

- The graphic pattern and still image are changeable. (→ page 35)
- If corrupted data is selected, "DISPLAY FILE INCOMPLETE" appears. (→ page 36)

AUX Setting

When a TV is connected to the AUX 1 terminal on the main unit, follow the steps below to change the setting.

Only for CQ-C7703N

- 1 Press **[SRC]** (SOURCE) and select the AUX mode.

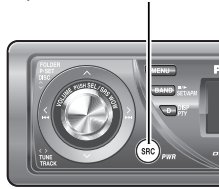

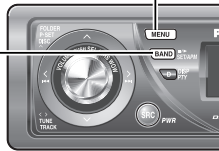

- 2 Press **[MENU]** to call up the menu display.

- 3 Press **[BAND]** (SET) to adjust.



AUX

 : For connection of other than a TV (default)

 : For connection of a TV

Customize the Display (Customize Function)

You can edit the moving images and still images that are initially stored in the unit. You also can use the data that is downloaded from the Panasonic Web site and the data that is stored with a digital camera or other devices and processed with exclusive software, IMAGE STUDIO. See "Notes on Customize function" (→ page 36) as well.

Note: Visit Panasonic Web site (<http://panasonic.co.jp/pas/en/software/customize/index.html>) for details.

Preparation:

Put the CD-R/RW that contains data to be customized in hand.

1 If there is a disc inside, take out the disc.

2 Press [SRC] (PWR) to select the CD mode.



3 Hold down [PUSH SEL] for 4 sec. or more to display the menu screen.



4 Load a CD-R/RW that contains data.

Notes:

- It may take time for the unit to identify the CD-R/RW.
- Discs recorded by the packet writing software are not supported.

5 Select an item to be customized.



[Δ]/[∇]: Select

[BAND] (SET): Confirm

Note: To exit the customize menu, hold down [PUSH SEL] 4 sec. or more.

GRAPHIC PATTERN

Moving image (graphic pattern) data (→ page 32)

STILL IMAGE

Still image data (→ page 32)

OPENING MESSAGE

Moving image at power on

CLOSING MESSAGE

Moving image at power off

6 Select a file.

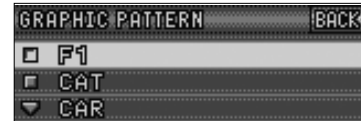

[Δ]/[∇]/[<]/[>]: Select

[BAND] (SET): Confirm

Notes:

- Files are automatically identified by their extensions, and target files are displayed.
- If "BACK" is selected, the screen of step 5 appears.

7 For a moving image file or still image file, select where to save the file.



[Δ]/[∇]/[<]/[>]: Select

[BAND] (SET): Confirm

Notes:

- New data overwrites existing data.
- If "BACK" is selected, the screen of step 6 appears.

8 Confirm the changed item.

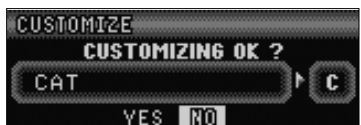

[<]/[>]: Select

[BAND] (SET): Confirm



Customization is performed. Do not turn off the power in mid-operation. (It takes approx. 1 minutes to complete this operation for a 168 kB moving image.) After completion of this operation, the screen of step 5 appears.

Note: If "NO" is selected, the screen of step 5 appears.

9 Press [OPEN] to eject the disc.

10 Hold down [PUSH SEL] for 4 sec. or more.

The CD mode comes back.

Customize the Display (Customize Function)

Note on Download Service

The download service may be suspended or stopped without advance notice. The download service is not available in some areas. Please visit the site below for further information.

Panasonic Web site:
(<http://www.panasonic.co.jp/global/>)

Notes on IMAGE STUDIO

- This download service is not available in some areas. For details, please access the Panasonic website.
- IMAGE STUDIO is available only by downloading from the address below. It is not bundled with this unit.
- Refer to the downloaded operating manual for how to use IMAGE STUDIO.

Notes on File

- The customize-specific file is downloadable from the URL below. You can create exclusive files stored with a digital camera or other devices by using exclusive software, IMAGE STUDIO that can be accessed from the same URL.
- Do not change the extension. Otherwise, the data cannot be recognized.

At Disc Making

- Save only customize-specific data.
- Save all data in the root directory. Files contained in a folder cannot be recognized.
- Follow the table below with regard to the number of files that are saved to a disc. Files beyond the specified capacity are not readable.
- Discs recorded by the packet writing software are not supported.

Type	Extension	Max. number
GRAPHIC PATTERN	.pfm	10
STILL IMAGE	.pfs	15
OPENING MESSAGE	.pfo	5
CLOSING MESSAGE	.pfe	5

At Customizing

- If customizing is interrupted on account of turning off the power, stopping the engine, removing the face plate or other reasons, you may lose the data. In such a case, try customizing again.
- The default image exists on the Panasonic Web site. If you would like to restore it, download the image from the site.

Download site:

<http://panasonic.co.jp/pas/en/software/customize/index.html>

Error Display Messages

NO FILES DETECTED

No customize-specific data on the disc

- ➔ **Load a disc that contains customize-specific data.**

CUSTOMIZING FAILED

Customize failed

- ➔ **Check to see whether or not the extension is correct and file contents are appropriate.**

DISPLAY FILE INCOMPLETE

Intended moving image or still image is damaged.

- ➔ **Customize it again and overwrite the file with new one.**

Troubleshooting

If You Suspect Something Wrong

Check and take steps as described below.

If the described suggestions do not solve the problem, it is recommended to take the unit to your nearest authorized Panasonic Service Centre. The product should be serviced only by qualified personnel. Please refer the checking and the repair to professionals. Panasonic shall not be liable for any accidents arising out of neglect of checking the unit or your own repair after your checking.

Never take measures especially those other than indicated by *italic* letters in "Possible Solution" described below because those are too dangerous for users to handle themselves.

Warning

- Do not use the unit in an irregular condition, for example, without sound, or with smoke or a foul smell, which can cause ignition or electric shock. Immediately stop using the unit and consult your dealer.
- Never try to repair the unit by yourself because it is dangerous to do so.

Problem	Possible cause → Possible solution
No power to the unit	The power cord (battery, power and ground) is connected in the wrong way. → Check the wiring.
	Fuse blows out. → Eliminate the cause of fuse blowout and replace the fuse with new one. Consult your dealer.
Sound is not generated.	MUTE is set to ON. → Set MUTE to OFF.
	There is contact between the external mute lead and the chassis. → Connect the external mute lead correctly. If the lead is unused, insulate it.
	The wiring of speaker lines are not correct, or a break or poor contact arises. → Check the wiring in accordance with the wiring diagram. (Installation Instructions)
Noise	There is an electromagnetic-wave generator such as a cellular phone near the unit or its electrical lines. → Keep an electromagnetic-wave generator such as a cellular phone away from the unit and the wiring of the unit. In case that noise cannot be eliminated due to the wiring harness of the car, consult your dealer.
	The contact of the ground lead is poor. → Make sure that the ground lead is connected to an unpainted part of the chassis securely.
Noise is made in step with engine revolutions.	Alternator noise comes from the car. → Change the wiring position of the ground lead. → Mount a noise filter on the power supply.

Common

English

Customize the Display (Customize Function), Troubleshooting

Common (continued)

Problem	Possible cause → Possible solution
Some operations are not executable.	Some operations are not executable in particular modes such as menu mode. → Read the operating instructions carefully and cancel the mode. If the unit is still out of order, consult your dealer.
No sound from speaker(s)	BALANCE/FADER setting is not appropriate. → Readjust BALANCE/FADER. There is a break, a short circuit, poor contact or wrong wiring regarding the speaker wiring. → Check the speaker wiring.
The speaker channels are reversed between right and left.	The speaker wiring is confused between right and left. → Perform the speaker wiring in accordance with the wiring diagram.
The sound field is not clear in the stereo mode. Central sound does not settled.	The plus and minus terminals at right and left channels of speakers are connected reversely. → Perform the speaker wiring in accordance with the wiring diagram.
The power fails unintentionally.	The safety device works. → Consult your dealer, or your nearest Panasonic Service Centre.

Radio

Poor reception or noise	Antenna installation or wiring of antenna cable is faulty. → Check whether the antenna mounting position and its wiring are correct. In addition, check to see whether the antenna ground is securely connected to the chassis. No power is supplied to the antenna amplifier (when using a film antenna, etc.). → Check the wiring of the antenna battery lead.
FM Stereo broadcast is received only in mono.	The MONO mode is active. → Cancel the MONO mode.
Only strong signal stations can be received.	The LOCAL mode is active. → Cancel the LOCAL mode.

Radio (continued)

Problem	Possible cause → Possible solution
<p>The number of auto preset stations is less than 6.</p>	<p>The number of receivable stations is less than 6. → Move to an area where receivable stations number is maximum, and try pre-setting.</p>
<p>Preset stations cannot be stored.</p>	<p>The contact of the battery lead is poor, or the battery lead is not always powered. → Make sure that the battery lead is connected securely, and preset stations again.</p>

RDS

<p>PS does not appear even if an RDS station is tuned in to. ("NO PS" appears.)</p>	<p>A PS code cannot be received for the reason of bad receiving conditions, etc. → A PS code appears if it is received. Wait for a while until conditions change.</p>
<p>Receiving programs differs from PTY that was already set up.</p>	<p>When the station changed between programs, the unit could not receive the PTY code. → An appropriate programme is searched for and tuned in to after receiving a corresponding PTY code. Therefore, wait for a while.</p>
<p>"NONE" appears when selecting PTY.</p>	<p>Any specified PTY programs cannot be received. There is no desired programme being broadcast in your area. → Select another PTY, or wait until a desired programme starts.</p>
<p>The clock time (CT) is not accurate.</p>	<p>The unit received a station broadcasting time that is not appropriate for you, or the unit is receiving a station that does not broadcast time. → Receive a station broadcasting time that is appropriate for your area, or adjust CT manually.</p>
<p>An AF station cannot be received even if AF indicator lights.</p>	<p>There is little difference in receiving conditions between the current station and AF stations. Update of the AF list ended in failure. → Wait until the AF list is successfully updated. For unstable reception, tune in to a stable station by the hand.</p>

CD

Problem	Possible cause → Possible solution
No playback or disc ejected	The disc is inserted upside down. → Insert a disc correctly.
	There is a flaw or foreign material on the disc. → Remove the foreign material, or use a flawless disc.
Sound skipping or noise	There is a flaw or foreign material on the disc. → Remove the foreign material, or use a flawless disc.
Sound skipping due to vibration	The unit is not sufficiently secured. → Secure the unit to the console box.
	The unit is tilted at over 30° in the front-to-end direction. → Make the angle 30° or less.
Disc unejectable	Something such as a peeled label obstructs the disc coming out. → Press and hold the [▲] (OPEN) for more than 2 seconds when the face plate is open (disc forced ejection). In case that the disc forced ejection does not work, consult your dealer.
	The microcontroller in the unit operates abnormally due to noise or other factors. → Unplug the power cord and plug it again. In case the unit is still out of order, consult your dealer.

MP3/WMA







No playback or disc ejected	The disc has unplayable formatted data. → Refer to the description about MP3/WMA for playable sound data except CD-DA (i.e. music CD).
The CD-R/RWs that are playable on other devices are not playable on this unit.	The playability of some CD-R/RWs may depend on the combination of media, recording software and recorder to be used even if these CD-R/RWs are playable on other devices such as a PC. → Make CD-R/RWs in different combination of media, recording software and recorder after referring to the description about MP3/WMA.
Sound skipping or noise	There is a flaw or foreign material on the disc. → Remove the foreign material, or use a flawless disc. For MP3/WMA, refer to the description about MP3/WMA.
	Playing VBR (Variable Bit Rate) files may cause sound skipping. → Play Non-VBR files.

Remote control unit

Problem	Possible cause → Possible solution
No response to pressing buttons	The battery is inserted in the wrong direction. A wrong battery is inserted. → Insert a correct battery in the correct direction.
	The battery is weak. → Replace the battery with new one.
	The aiming direction of the remote control unit is wrong. → Aim the remote control unit at the sensor of the unit and press buttons.
	The sensor is exposed to direct sunlight. (The remote control unit may not be operable when the sensor is exposed to direct sunlight. In such a case, the system is not faulty.) → Block off sunlight to the sensor.

Error Display Messages

CD/MP3/WMA

Display	Possible cause → Possible solution
	The disc is dirty, or is upside down. → Check the disc. The disc has scratches. → Check the disc. No operation by some cause. → Unplug the power cord and plug it again. In case the unit is still out of order, consult your dealer. (→ Installation Instructions)
	
	
	The player for some reason cannot read the file you are trying to play. (File recorded in an unsupported file system, compression scheme, data format, file name extension, damaged data, etc.) → Select a file that the player can read. Check the type of data recorded on the disc. Create a new disc if necessary.
 (After 5 seconds) ↓ To next file automatically	A WMA file can be copyrighted. → The file protected by copyright is not playable.
	No disc.

Note: Refer to the **System Upgrade Guidebook** for error messages regarding optional products.

Notes on Discs

Notes on CD/CD Media (CD-ROM, CD-R, CD-RW, CD-R, CD-RW)

If you use commercial CDs, they must have either of these labels shown at right. Some copy-protected music CDs are not playable.



How to hold the disc

- Do not touch the underside of the disc.
- Do not scratch on the disc.
- Do not bend the disc.
- When not in use, keep disc in the case.

Printed side



Do not use irregularly shaped discs.

Do not leave discs in the following places:

- In direct sunlight
- Near car heaters
- Dirty, dusty and damp areas
- On seats and dashboards

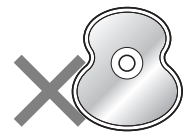

Labels created by a printer Irregularly shaped discs

Disc cleaning

Use a dry, soft cloth to wipe from the center outward.

Do not attach any seals or labels to your discs.

Do not write on the disc label with a ballpoint pen or other hard-point pens.

<Correct>



<Wrong>



Notes on CD-Rs/RWs

- You may have trouble playing back some CD-R/RW discs recorded on CD recorders (CD-R/RW drives), either due to their recording characteristics or dirt, fingerprints, scratches, etc. on the disc surface.
- CD-R/RW discs are less resistant to high temperatures and high humidity than ordinary music CDs. Leaving them inside a car for extended periods may damage and make playback impossible.
- Some CD-R/RWs can not be played back successfully thanks to incompatibility among writing software, a CD recorder (CD-R/RW drive) and the discs.
- This player cannot play the CD-R/RW discs if the session is not closed.
- This player cannot play the CD-R/RW discs which contains other than CD-DA or MP3/WMA data.
- Be sure to observe the instructions of CD-R/RW disc for handling it.

Maintenance

Cleaning the Unit

Your product is designed and manufactured to ensure the minimum of maintenance. Use a soft cloth for routine exterior cleaning. Never use benzine, thinner, or other solvents.

Fuse

If the fuse blows out, consult your dealer, or your nearest authorized Panasonic Service Centre.

Warning

- Use fuses of the same specified rating (**15 A**). Using substitutes or fuses with higher ratings, or connecting the unit directly without a fuse could cause fire or damage to the unit. **If the replaced fuse fails, contact your nearest authorized Panasonic Service Centre.**

Specifications

General

Power Supply	DC 12 V (11 V – 16 V), Test Voltage 14.4 V, Negative Ground
Tone Controls (Bass/Treble)	Bass; ± 12 dB at 60 Hz, Treble; ± 12 dB at 16 kHz
Equalizer Center Frequency	60, 160, 400, 1 k, 3 k, 6 k, 16 k Hz
Variable Range of Equalizer	-12 dB to 12 dB (2 dB step)
Current Consumption	Less than 2.2 A (CD mode, 0.5 W 4-Speaker)
Maximum Power Output	70 W x 4 (CQ-C7703N, at 1 kHz), 50 W x 4 (CQ-C7303N, at 1 kHz)
Power Output	40 W x 4 (CQ-C7703N, DIN 45 324, at 4 Ω), 23 W x 4 (CQ-C7303N, DIN 45 324, at 4 Ω)
Speaker Impedance	4 – 8 Ω
Pre-amp output voltage	2.5 V (CD mode, 1 kHz, 0 dB)
Subwoofer-output voltage	2.5 V (CD mode, 1 kHz, 0 dB)
Pre-amp output impedance	200 Ω
Subwoofer-output impedance	200 Ω
Dimensions (Main Unit)	178(W) x 50(H) x 155(D) mm
Weight (Main Unit)	1.7 kg (CQ-C7703N), 1.6 kg (CQ-C7303N)

CD Player

Sampling Frequency	8 times oversampling
DA Converter	4 DAC System
Pick-Up Type	Astigma 3-beam
Light Source	Semiconductor laser
Wavelength	790 nm
Frequency Response	20 Hz – 20 kHz (± 1 dB)
Signal to Noise Ratio	96 dB
Total Harmonic Distortion	0.01 % (1 kHz)
Wow and Flutter	Below measurable limits
Channel Separation	85 dB

Radio

FM Stereo Radio	
Frequency range	87.5 MHz – 108 MHz
Usable sensitivity	6 dB/ μ V (S/N 30 dB)
Stereo separation	35 dB (at 1 kHz)
AM (MW) Radio	
Frequency Range	531 kHz – 1 602 kHz
Usable Sensitivity	28 dB/ μ V (S/N 20 dB)
AM (LW) Radio	
Frequency Range	153 kHz – 279 kHz
Usable Sensitivity	32 dB/ μ V (S/N 20 dB)

Notes:

- Specifications and design are subject to modification without notice due to improvements.
- Some figures and illustrations in this manual may be different from your product.

Sales and Support Information

For UK and Ireland customers only.

Customer Care Centre

- For customers within the UK: 08705 357357
- For customers within the Republic of Ireland: 01 289 8333
- Visit our website for product information
- E-mail: customer.care@panasonic.co.uk

Direct Sales at Panasonic UK

- Order accessories and consumable items for your product with ease and confidence by phoning our Customer Care Centre Monday - Thursday 9:00am - 5:30pm, Friday 9:30am - 5:30pm. (Excluding public holidays).
- Or go on line through our Internet Accessory ordering application at www.panasonic.co.uk.
- Most major credit and debit cards accepted.
- All enquiries, transactions and distribution facilities are provided directly by Panasonic UK Ltd.
- It couldn't be simpler!
- Also available through our Internet is direct shopping for a wide range of finished products, so take a browse on our website for further details.

Matsushita Electric Industrial Co., Ltd.
Web Site : <http://www.panasonic.co.jp/global/>

YEFM285769A

ND0106-1125

Printed in China

**Before Installation/Vor dem Einbau/
Avant l'installation/Voor de installatie**

Consult a professional for installation.
●Verify the radio using the antenna and speakers before installation.
Wenden Sie sich zum Einbau an einen Fachmann.
●Probieren Sie den Radiobetrieb vor dem Einbau mit Antenne und Lautsprechern aus.
Prenez contact avec un spécialiste pour le montage.
●Vérifiez l'autoradio avant de procéder au montage.
Vraag een vakman voor de installatie.
●Controleer voor de installatie of de radio werkt met de antenne en de luidsprekers.

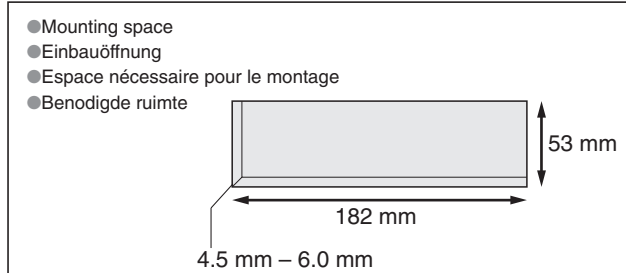
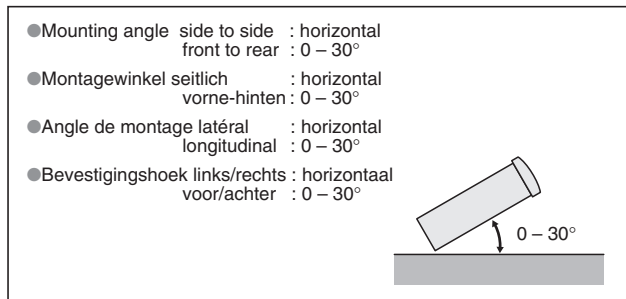

Remove Mounting Collar ① and Trim Plate ④ from the main unit temporarily, which are already mounted at shipment.
Die bei der Lieferung montierte Einbauhalterung ① und Abdeckplatte ④ vorübergehend vom Gerät abmontieren.
Démontez provisoirement le cadre de montage ① et la plaque de garniture ④ de l'appareil principal, qui sont déjà mis en place lors de l'expédition.
Verwijder de Bevestigingskraag ① en de Afwerkingsrand ④, die bij het verlaten van de fabriek gemonteerd zijn, tijdelijk van het hoofdtoestel.

**Before Wiring/Vor der Verdrahtung/
Avant le câblage/Voor het aansluiten van de bedrading**

Exclusively operated with 12 V battery with negative (-) ground.
Connect the power lead (red) very last. (for non-ISO connector)
Connect the battery lead (yellow) to the positive (+) terminal of the battery or fuse block terminal (BAT). (for non-ISO connector)
Strip about 5 mm of the lead ends for connection. (for non-ISO connector)
Apply insulating tape to bare leads.
Secure loosened leads.

Dieses Gerät ist ausschließlich für den Anschluss an Bordnetze mit 12 V Batterie und negativer (-) Klemme an Masse bestimmt.
Schließen Sie den Versorgungsleiter (rot) zum Schluss an. (wenn kein ISO-Stecker verwendet wird)
Schließen Sie das Batteriekabel (gelb) an die positive (+) Klemme der Batterie oder an die (BAT) Klemme des Sicherungsblocks an. (wenn kein ISO-Stecker verwendet wird)
Entfernen Sie etwa 5 mm der Isolierung von den Kabelenden für den Anschluss. (wenn kein ISO-Stecker verwendet wird)
Isolieren Sie alle freiliegenden Leiter.
Sichern Sie alle losen Leiter.

Alimentez l'appareil absolument par la batterie de 12 V avec sa polarité négative (-) mise à la masse.
Raccorder le fil d'alimentation (rouge) en dernier. (pour un connecteur non-ISO)
Connectez le fil (jaune) à la borne positive (+) de la batterie ou à la borne (BAT) de la boîte à fusibles. (pour un connecteur non-ISO)
Dénudez les extrémités de fil de 5 mm environ pour la connexion. (pour un connecteur non-ISO)
Recouvrez les fils nus d'un ruban isolant.
Resserrez les connexions de fils.

Uitsluitend voor gebruik met een 12 V accusysteem met negatieve (-) aarding.
Sluit de stroomdraad (rood) pas het allerlaatst aan. (voor een niet-ISO aansluiting)
Sluit de accudraad (geel) aan op de positieve (+) aansluiting van de accu of van het zekeringenblok (BAT). (voor een niet-ISO aansluiting)
Strip ongeveer 5 mm van de uiteinden van de draden om de verbinding tot stand te kunnen brengen. (voor een niet-ISO aansluiting)
Isoleer blote draadeinden met isolatieband.
Zet loshangende draden vast.

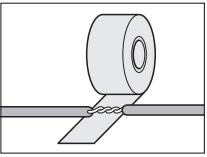

Panasonic

WMA MP3 CD Player/Receiver

Model: **CQ-C7703N/C7303N**



(CQ-C7703N)

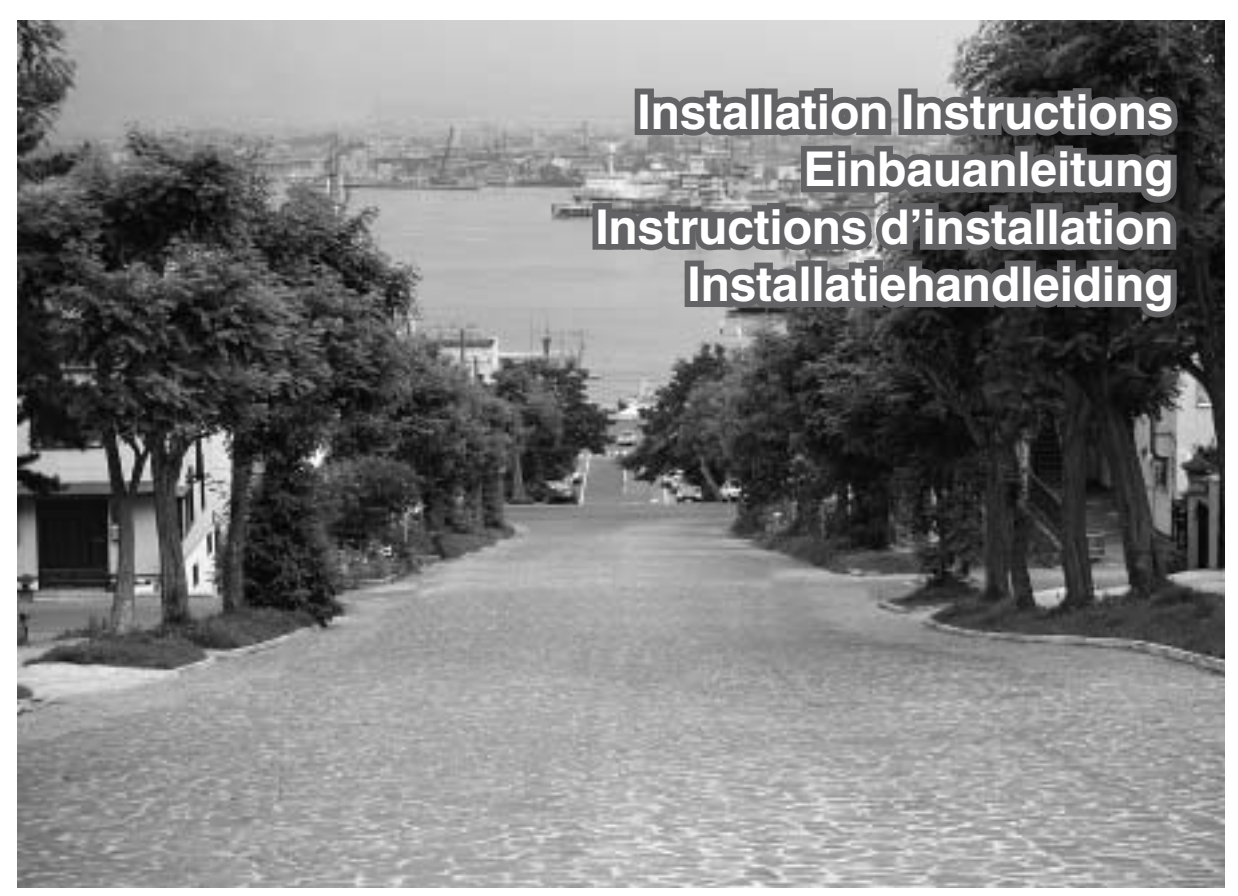

Supplied Hardware/Mitgelieferte Hardware/Matériel d'installation/Meegeleverde onderdelen

No.	Item	Diagram	Q'ty	No.	Item	Diagram	Q'ty
①	Mounting Collar Einbauhalterung Cadre de montage Bevestigingskraag YEFX0217222		1	④	Trim Plate Abdeckplatte Plaque de garniture Afwerkingsrand YEFX051013		1
②	Mounting Bolt (5 mm) Befestigungsschraube (5 mm) Boulon de fixation (5 mm) Bevestigingsbout (5 mm) *		1	⑤	ISO Antenna Adapter ISO-Antennenadapter Adaptateur d'antenne ISO ISO antenne-adapter *		1
③	Power Connector Versorgungsstecker Connecteur d'alimentation Stroomstekker YGAJ021010		1	⑥	Lock Cancel Plate Verriegelungsfreigabeplatte Plaque anti-blocage Ontgrendelingsplaat *		2

* ②, ⑤ and ⑥ consist of a set. (YEP0FZ5711) * ②, ⑤ und ⑥ bestehen als Satz. (YEP0FZ5711)
* ②, ⑤ et ⑥ constituent un jeu. (YEP0FZ5711) * ②, ⑤ en ⑥ bestaan uit een set. (YEP0FZ5711)



●Please read these instructions carefully before using this product and keep this manual for future reference.
●Bitte lesen Sie diese Bedienungsanleitung vor der Verwendung dieses Produktes aufmerksam durch und bewahren Sie sie danach für spätere Nachschlagzwecke sorgfältig auf.
●Prière de lire ces instructions attentivement avant d'utiliser le produit et garder ce manuel pour l'utilisation ultérieure.
●Leest u deze instructie alstublieft zorgvuldig door voor u dit product in gebruik neemt en bewaar deze handleiding voor later gebruik.

Matsushita Electric Industrial Co., Ltd.
Web Site : <http://www.panasonic.co.jp/global/>

YEFM294135A ND0106-1125 Printed in China

Installation/Einbau/Montage/Installatie

How to install the unit/Einbau des Gerätes/Mode de montage de l'appareil/Installeren van het toestel

Caution
●Wear gloves for safety.
●Make sure that wiring is completed before installation.
Vorsicht
●Tragen Sie Handschuhe, um sich vor Verletzungen zu schützen.
●Achten Sie vor dem Einbau darauf, dass die Verdrahtung fertiggestellt ist.
Attention
●Porter des gants à des fins de sécurité.
●S'assurer que le câblage est terminé avant l'installation.
Let op
●Draag handschoenen voor uw veiligheid.
●Controleer of de bedrading correct is aangelegd voor u gaat installeren.

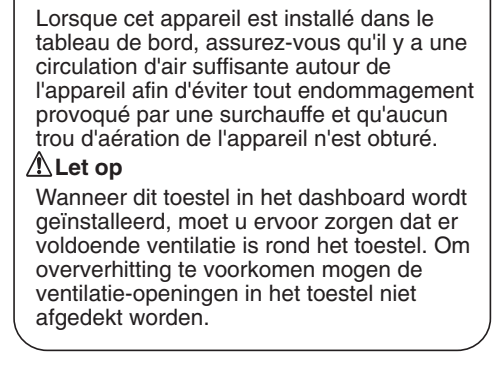
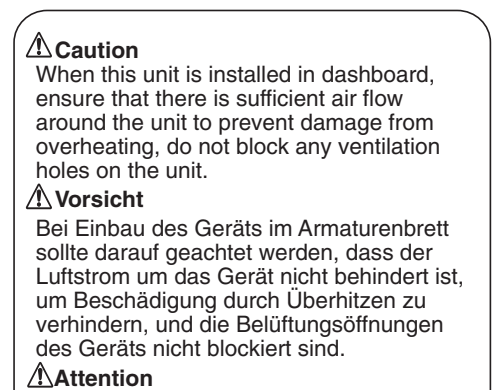
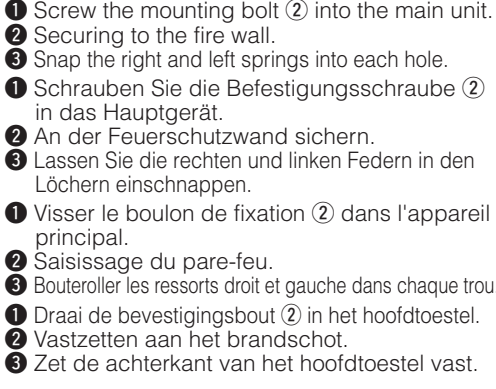
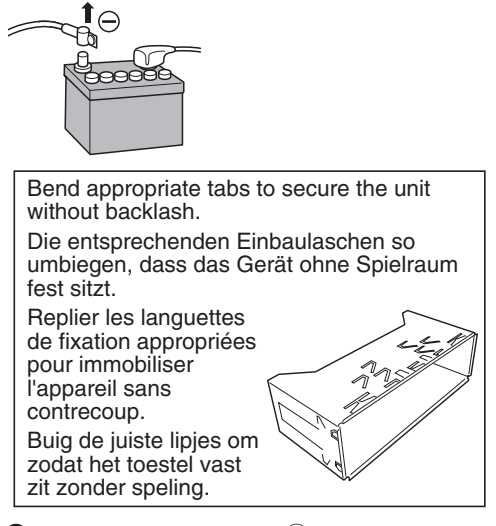
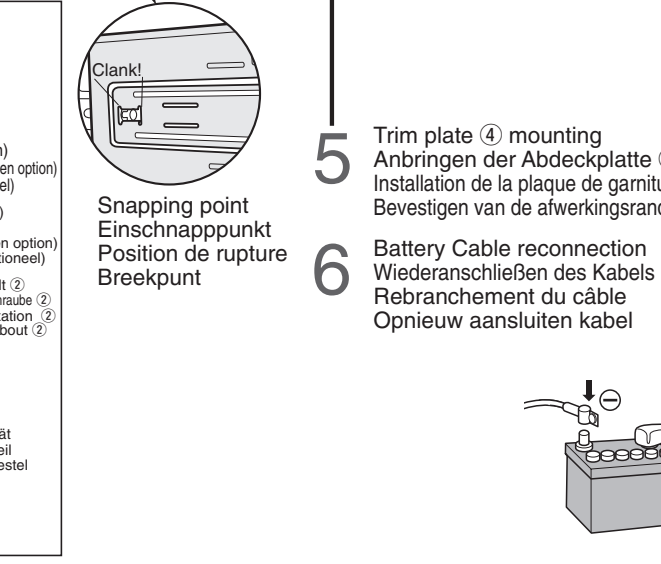
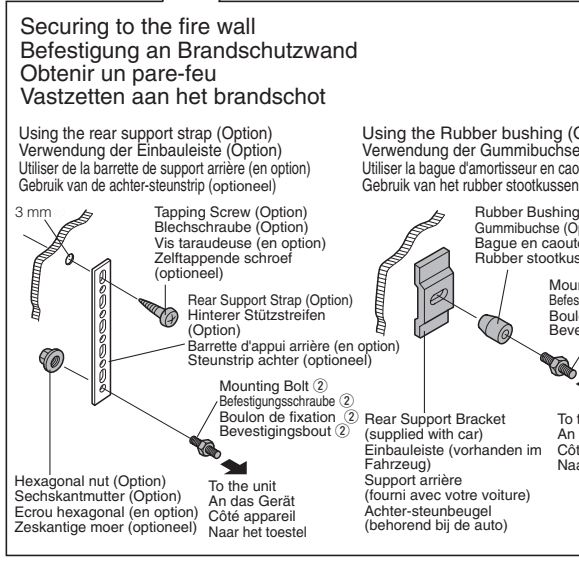
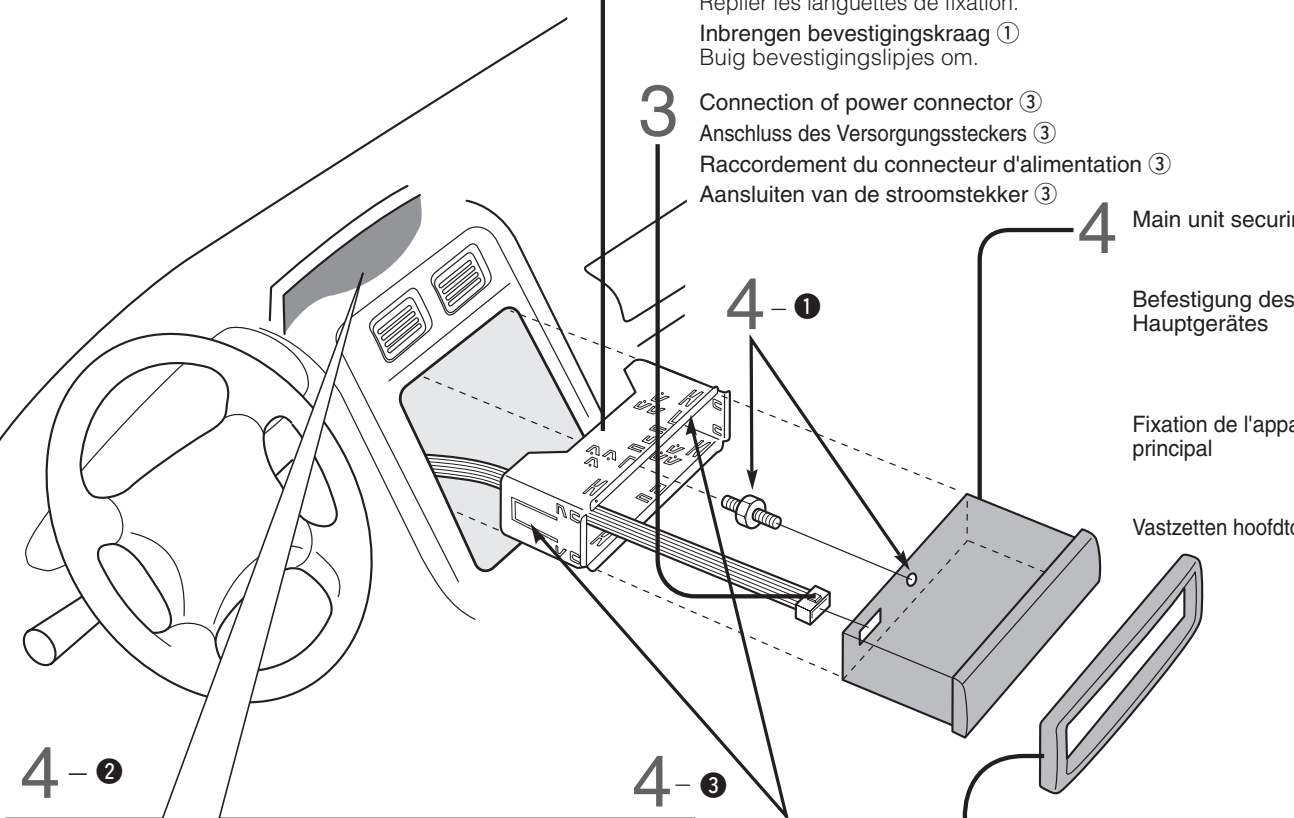

**How to remove the unit/Ausbau des Gerätes/
Dépose de l'appareil/Verwijderen van het toestel**

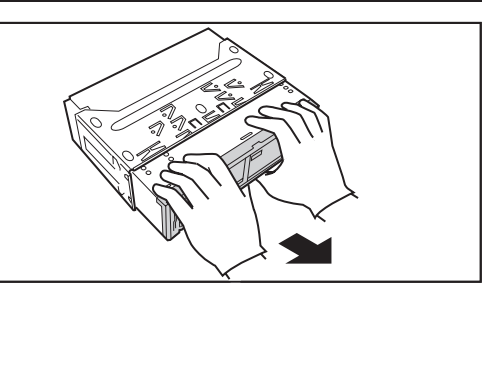
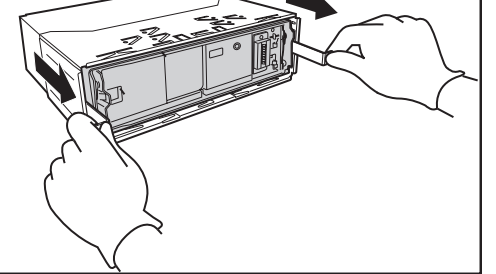
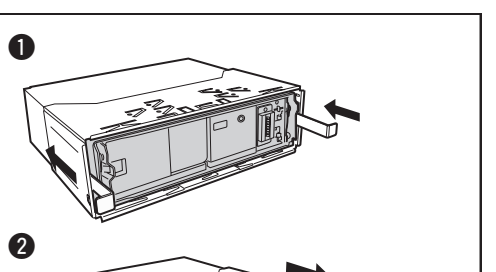
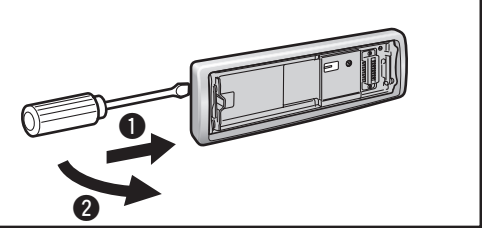
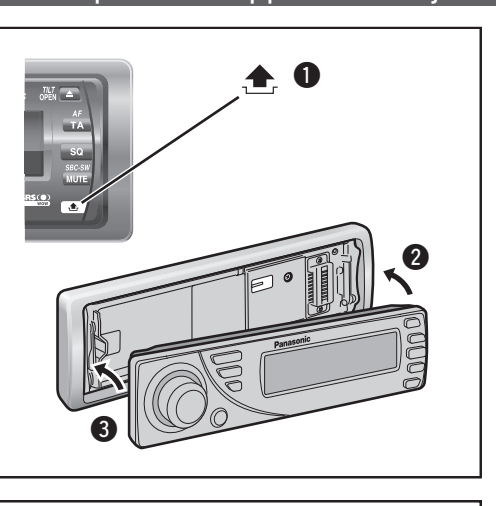

1 Remove the face plate.
Nehmen Sie das Bedienteil ab.
Retirer la plaque de façade.
Verwijder de voorplaat.

2 Remove the trim plate ④.
Entfernen Sie die Abdeckplatte ④.
Enlevez la plaque de garniture ④.
Verwijder de afwerkingsrand ④.

3 Lock release
① Insert the lock cancel plate ⑥ until you hear a click.
② Pull the main unit.
Verriegelungsfreigabe
① Setzen Sie die Verriegelungsfreigabeplatte ⑥ ein, bis Sie ein Klickgeräusch vernehmen können.
② Ziehen Sie an dem Hauptgerät.
Libération du verrouillage
① Introduisez la plaque anti-blocage ⑥ jusqu'à entendre un clic.
② Dégagez l'appareil principal.

4 Pull out the unit with both hands.
Ziehen Sie das Gerät mit beiden Händen heraus.
Retirez l'appareil à deux mains.
Trek het toestel met beide handen naar buiten.

Wiring/Verdrahtung/Câblage/Bedrading

DC/DC Converter (Only for CQ-C7703N)
Gleichspannungswandler (Nur für CQ-C7703N)
Convertisseur CC/CC (Uniquement pour le modèle CQ-C7703N)
DC-DC convertereenheid (Alleen voor de CQ-C7703N)

Secure the converter with screws and so forth. Keep some distance between RCA Cords and the antenna lead.
Den Wandler mit Schrauben usw. befestigen. Etwas Abstand zwischen den RCA-Leitungen und der Antennenleitung vorsehen.
Fixez le convertisseur avec des vis ou un autre moyen approprié. Gardez une certaine distance entre les cordons RCA et le fil d'antenne.
Zet de converter vast met schroeven en wat dies meer zij. Houd de RCA (tulpstekker) snoeren en de antenne draad bij elkaar uit de buurt.

Caution
To prevent damage to the unit, do not connect the power connector until the whole wiring is completed.
Vorsicht
Um Beschädigung des Gerätes zu vermeiden, schließen Sie den Versorgungsstecker erst an, nachdem die gesamte Verdrahtung vollständig beendet wurde.
Attention
Ne pas introduire la prise d'alimentation secteur dans l'appareil tant que le câblage n'est pas complètement terminé afin de ne pas risquer d'endommager l'appareil.
Let op
Om schade aan het toestel te voorkomen mag u de stroomstekker pas aansluiten wanneer de bedrading volledig is aangesloten.

Antenna
Antenne
Antenne

System-up Connector
System-Upgrade-Stecker
Connecteur de mise à niveau de système
Systeemuitbreidingsaansluiting

Subwoofer Output Connector
The RCA cord of an external power amplifier should be connected.
Subwoofer-Ausgangsstecker
Hier das RCA-Kabel eines externen Leistungsverstärkers anschließen.
Connecteur de sortie des extrêmes-graves.
Le cordon RCA d'un amplificateur de puissance extérieur doit être raccordé.

AUX Input Connector
AUX-Eingangsstecker
Connecteur d'entrée AUX
AUX-ingangsansluiting

Preamp Out Connector (Rear)
Vorverstärker-Ausgang (Rückseite)
Connecteur de sortie de préamplificateur (arrière)
Uitgangsaansluiting voorversterker (achter)

Preamp Out Connector (Front)
Vorverstärker-Ausgang (Vorderseite)
Connecteur de sortie de préamplificateur (avant)
Uitgangsaansluiting voorversterker (voor)

C3 : (Brown w/black stripe)/(Braun mit schwarzem Streifen)/(Brun à rayures noires)/(Bruin met zwarte streep)
External Remote Control Lead
When using a non-Panasonic external remote control, refer to the manufacture for their product before connecting.
Leitungsdraht für externe Fernbedienung
Wenn Sie eine externe Fernbedienung verwenden, die nicht von Panasonic hergestellt wurde, wenden Sie sich vor dem Anschluss an den Hersteller des Produktes.
Fil de la télécommande extérieure
En cas d'utilisation d'une télécommande extérieure non-Panasonic, se référer aux conseils du fabricant concerné pour les connexions électriques.

C4 : (Blue w/white stripe)/(Blau mit weißem Streifen)/(Bleu à rayures blanches)/(Blauw met witte streep)
Amp-Relay Control Power Lead To Panasonic power amplifier. (Max. 100 mA) (synchronized with the power on/off of amplifier)
Stromversorgungskabel für Verstärkerrelaissteuerung an den Panasonic Leistungsverstärker. (Max. 100 mA) (synchronisiert mit dem Ein/Ausschalten der Stromversorgung des Verstärkers)
Fil d'alimentation de commande de relais d'amplificateur à amplificateur de puissance Panasonic. (Max. 100 mA) (synchronisé à l'application ou la coupure d'alimentation de l'amplificateur)
Verstärker-relais Stuurstroomdraad naar Panasonic eindversterker. (Max. 100 mA) (gesynchroniseerd met de eindversterker aan/uit)

A5 : (Blue)/(Blau)/(Bleu)/(Blauw)
Motor Antenna Relay Control Lead To Motor Antenna. (Max. 100 mA) (This lead is not intended for use with a switch actuated power antenna)
Stuurkabel für Relais der motorbetriebenen Antenne Zu motorbetriebenen Antenne (max. 100 mA) (Dieses Kabel dient nicht für die Verwendung mit einer über einen Schalter aktivierten motorbetriebenen Antenne.)
Fil de commande de relais d'antenne motorisée A l'antenne motorisée (100 mA maxi.) (Ce fil n'est pas conçu pour l'usage avec l'antenne commandée par interrupteur.)
Stuurdraad relais gemotoriseerde antenne Naar de gemotoriseerde antenne. (Max. 100 mA) (Deze draad is niet bedoeld voor een gemotoriseerde antenne die met een schakelaar wordt ingeschakeld.)

A7 : (Red)/(Rot)/(Rouge)/(Rood)
Power Lead (ACC or IGN) To ACC power, +12 V DC.
Versorgungskabel (ACC oder IGN) An die ACC-Stromklemme, +12 V Gleichspannung.
Fil d'alimentation (ACC ou IGN) A l'alimentation ACC, +12 V CC.
Stroomdraad (ACC of IGN) Naar ACC stroomvoorziening, +12 V gelijkstroom.

A8 : (Black)/(Schwarz)/(Noir)/(Zwart)
Ground Lead To a clean, bare metallic part of the car chassis.
Massekabel An ein sauberes, metallisches Teil des Fahrzeugchassis.
Fil de mise à la masse A une partie métallique propre découverte du châssis de voiture.
Aarding Naar een schoon, bloot metalen onderdeel van het chassis.

A4 : (Yellow)/(Gelb)/(Jaune)/(Geel)
Battery Lead To the car battery, continuous +12 V DC.
Batteriekabel An die Batterie des Fahrzeuges, kontinuierlich +12 V Gleichspannung.
Fil de batterie A la batterie de voiture, alimentation continue de +12 V CC.
Accudraad Naar de accu van de auto, doorlopende stroomvoorziening +12 V gelijkstroom.

System Upgrade Example: Connecting with the CD changer/Beispiel für ein System-Upgrade: Anschluss an den CD-Wechsler
/Exemple de mise à niveau de système: Raccordement à un changeur de disque CD/Voorbeeld systeemuitbreiding: Aansluiten van een CD-wisselaar

CQ-C7703N/C7303N System-up Connector
CX-DP880N (Optional) Ground Lead
System-Upgrade-Stecker
System-Upgrade-Stecker
Connecteur de mise à niveau de système
Systeemuitbreidingsaansluiting
Massekabel
Massekabel
Fil de mise à la masse
Aarding

CA-CC30N (Optional) Conversion Cable for DVD/CD Changer
Umwandlungskabel für DVD/CD-Wechsler
Câble de conversion de changeur DVD/CD
Conversiekabel voor DVD/CD-wisselaar

B7 : Rear Left + (Green) / Hinten Links + (Grün) / Arrière gauche + (Vert) / Links achter + (Groen)

B5 : Front Left + (White) / Vorne Links + (Weiß) / Avant gauche + (Blanc) / Links voor + (Wit)

B3 : Front Right + (Gray) / Vorne Rechts + (Grau) / Avant droit + (Gris) / Rechts voor + (Grijs)

B1 : Rear Right + (Violet) / Hinten Rechts + (Violett) / Arrière droit + (Violet) / Rechts achter + (Paars)

B8 : Rear Left - (Green w/black stripe) / Hinten Links - (Grün mit schwarzem Streifen) / Arrière gauche - (Vert à rayures noires) / Links achter - (Groen met zwarte streep)

B6 : Front Left - (White w/black stripe) / Vorne Links - (Weiß mit schwarzem Streifen) / Avant gauche - (Blanc à rayures noires) / Links voor - (Wit met zwarte streep)

B4 : Front Right - (Gray w/black stripe) / Vorne Rechts - (Grau mit schwarzem Streifen) / Avant droit - (Gris à rayures noires) / Rechts voor - (Grijs met zwarte streep)

B2 : Rear Right - (Violet w/black stripe) / Hinten Rechts - (Violett mit schwarzem Streifen) / Arrière droit - (Violet à rayures noires) / Rechts achter - (Paars met zwarte streep)

Power connector/Versorgungsstecker/Connecteur d'alimentation/Stroomstekker

ISO Standard ISO/ISO-Standard/Normes ISO/Standaard ISO

A7 IGN or ACC 12 V supply
12 V-Versorgung (IGN/ACC)
Alimentation 12 V en IGN ou ACC
IGN of ACC 12 V stroomvoorziening

A4 12 V Batteries (Continuous supply)
12 V-Batterie (Dauerversorgung)
Batterie de 12 V (alimentation continue)
12 V accu (doorlopende stroomvoorziening)

Car-side connector
Steckverbinder am Fahrzeug
Connecteur côté voiture
Stekker aan autozijde

Car Type A/Kraftfahrzeug des Typs A/Type de voiture A/Autotype A

A4 IGN or ACC 12 V supply
12 V-Versorgung (IGN/ACC)
Alimentation 12 V en IGN ou ACC
IGN of ACC 12 V stroomvoorziening

A7 12 V Batteries (Continuous supply)
12 V-Batterie (Dauerversorgung)
Batterie de 12 V (alimentation continue)
12 V accu (doorlopende stroomvoorziening)

Car-side connector
Steckverbinder am Fahrzeug
Connecteur côté voiture
Stekker aan autozijde

Car Type B/Kraftfahrzeug des Typs B/Type de voiture B/Autotype B

A4 No connection
Kein Anschluss
Aucune connexion
Geen aansluiting

A7 12 V Batteries (Continuous supply)
12 V-Batterie (Dauerversorgung)
Batterie de 12 V (alimentation continue)
12 V accu (doorlopende stroomvoorziening)

Car-side connector
Steckverbinder am Fahrzeug
Connecteur côté voiture
Stekker aan autozijde

Precautions (ISO Connector)

- The pin arrangement of the power connector conforms to ISO standard.
- Please check that the pin arrangement of the connector in your car conforms to ISO standard.
- For car types A and B, change the wiring of the red and yellow leads as shown at below.
- After connection, insulate the portions marked (#) with insulating tape.

Note: For cars other than types A and B, please consult your local car shop.

Vorsichtsmaßnahmen (ISO-Stecker)

- Die Stiftbelegung des Versorgungssteckers entspricht dem ISO-Standard.
- Bitte stellen Sie sicher, dass die Stiftbelegung des Steckers in Ihrem Fahrzeug dem ISO-Standard entspricht.
- Für Fahrzeuge der Typen A und B, ändern Sie die Verdrahtung der roten und gelben Leiter gemäß Abbildung.
- Nach dem Anschluss isolieren Sie die mit (#) markierten Abschnitte mit Isolierband.

Hinweis: Für andere Fahrzeuge als Typ A und B, wenden Sie sich bitte an eine örtliche Pkw-Werkstatt.

Précautions (Connecteur ISO)

- La disposition des broches du connecteur d'alimentation est conforme à la norme ISO.
- Veuillez vérifier si que la disposition des broches du connecteur d'alimentation dans votre voiture est conforme à la norme ISO.
- Pour les types de voiture A et B, changer le câblage des fils rouge et jaune comme indiqué ci-dessous.
- Après avoir fait les connexions, isoler les sections marquées (#) avec de la bande isolante.

Remarque: Pour les voitures autres que des types A et B, veuillez consulter votre magasin de matériel automobile local.

Voorzorgen (ISO stekker)

- De pin-configuratie van de stroomstekker voldoet aan de ISO standaard.
- Controleer of de pin-configuratie van de stekker in uw auto eveneens voldoet aan de ISO standaard.
- Voor auto's van type A en B, dient u de bedrading voor de rode en gele draden te wijzigen zoals hieronder staat aangegeven.
- Na het aansluiten dient u de gedeelten die met (#) gemarkeerd zijn met isolatieband af te plakken.

Opmerking: Voor andere auto's dan die van type A en B dient u uw garage te raadplegen.

Speaker Connection/Anschluss der Lautsprecher/Branchement avec les haut-parleurs/Aansluiten van de luidsprekers

Connect as follows.
Nehmen Sie den Anschluss wie folgt vor.
Branchez les haut-parleurs comme suit.
Sluit de luidsprekers als volgt aan.

Caution

- Do not connect more than one speaker to one set of speaker leads. (except for connecting to a tweeter)
- Do not use a 3-wire type speaker system having a common earth lead.

Vorsicht

- Schließen Sie niemals mehr als einen Lautsprecher an einen Satz Lautsprecherleiter an. (außer bei Anschluss eines Hochtonlautsprechers)

Attention

- Ne raccorder pas plus d'un haut-parleur à un ensemble de fils de haut-parleur. (Sauf lors du raccordement à un tweeter)

Let op

- Sluit niet meer dan één luidspreker aan op één paar luidsprekerdraden. (Behalve bij aansluiting op een tweeter.)

Use ungrounded speakers only.
Allowable input : 70 W or more (CQ-C7703N)
50 W or more (CQ-C7303N)

Impedance : 4 - 8 Ω

- Distance between speaker and amplifier: 30 cm or more
- Verwenden Sie nicht geerdete Lautsprecher. Zulässige Belastbarkeit: 70 W oder mehr (CQ-C7703N) 50 W oder mehr (CQ-C7303N)
- Utilisez uniquement des haut-parleurs non reliés à la masse. Puissance d'entrée admissible: 70 W ou davantage (CQ-C7703N) 50 W ou davantage (CQ-C7303N)
- Impedantie : 4 - 8 Ω
- Distance entre le haut-parleur et l'amplificateur: 30 cm ou davantage
- Gebruik uitsluitend ongeaarde luidsprekers. Toegestaan ingangsvormogen: 70 W of hoger (CQ-C7703N) 50 W of hoger (CQ-C7303N)
- Impedantie: 4 - 8 Ω
- Afstand tussen luidspreker en versterker: 30 cm of meer

Panasonic

System Upgrade Guidebook System-Upgrade-Handbuch Guide pratique de mise à niveau de système Systeemitbreidingsgids Guidebok om systemuppgradering Guida per il potenziamento del sistema Guía de mejora del sistema Systemopgraderingsvejledning Przewodnik rozbudowy systemu Návod k modernizaci systému Rendszerfejlesztési kézikönyv Инструкция по расширению системы

Model: **CQ-C7703N/C7303N**

- For upgrading your system, read this manual carefully before use. This manual should be retained for future reference after read.
- Lesen Sie dieses Handbuch sorgfältig durch, bevor Sie ein System-Upgrade vornehmen. Bewahren Sie dieses Handbuch für späteres Nachschlagen auf.
- Veuillez lire attentivement ce mode d'emploi avant toute utilisation pour faire la mise à niveau du système. Conserver ce manuel dans un endroit sûr pour toute consultation ultérieure.
- Lees deze handleiding zorgvuldig door voor u uw systeem gaat uitbreiden. Bewaar deze handleiding na gebruik zodat u er later nog eens iets in op kunt zoeken.
- Vid uppgradering av systemet, läs igenom denna manual innan det tas i bruk. Spara denna manual för framtida referens efter genomläsning.
- Per potenziare il proprio sistema, leggere attentamente questo manuale prima dell'utilizzo. Questo manuale deve essere conservato per poterlo consultare in futuro dopo la lettura.
- Para efectuar la mejora de su sistema, lea detenidamente este manual antes de la utilización. Después de su lectura, deberá guardar este manual para poderlo consultar en el futuro.
- Læs denne brugsvejledning grundigt inden brugen angående opgradering af dit system. Behold denne brugsvejledning, så den kan anvendes til fremtidig reference.
- Zanim zaczniesz rozbudowę systemu, przeczytaj dokładnie tę instrukcję. Instrukcja ta powinna po przeczytaniu zostać zachowana do dalszego użytku w przyszłości.
- Předtím, než budete systém modernizovat, si pozorně přečtěte tento návod. Návod si uschovejte pro budoucí potřebu.
- Rendszerének fejlesztéséhez, alaposan olvassa át ezt a kézikönyvet. Átolvasás után őrizze meg ezt a kézikönyvet a jövőbeli információért.

Safety Information

- Read the operating instructions for the unit and all other components of your car audio system carefully before using the system. They contain instructions about how to use the system in a safe and effective manner. Panasonic assumes no responsibility for any problems resulting from failure to observe the instructions given in this manual.

- This manual uses pictographs to show you how to use the product safely and to alert you to potential dangers resulting from improper connections and operations. The meanings of the pictographs are explained below. It is important that you fully understand the meanings of the pictographs in order to use this manual and the system properly.



This pictograph intends to alert you to the presence of important operating instructions and installation instructions. Failure to heed the instructions may result in severe injury or death.



This pictograph intends to alert you to the presence of important operating instructions and installation instructions. Failure to heed the instructions may result in injury or material damage.

Warning

Observe the following warnings when using this unit.

- The driver should neither watch the display nor operate the system while driving.**
Watching the display or operating the system will distract the driver from looking ahead of the vehicle and can cause accidents. Always stop the vehicle in a safe location and use the parking brake before watching the display or operating the system.
- Use the proper power supply.**
This product is designed for operation with a negative grounded 12 V DC battery system. Never operate this product with other battery systems, especially a 24 V DC battery system.
- Keep batteries and insulation film out of reach of infants.**
Batteries and insulation film can be ingested, so keep them out of the reach of infants. If an infant ingests a battery or insulation film, please seek immediate medical attention.
- Protect the Deck Mechanism.**
Do not insert any foreign objects into the slot of this unit.
- Do not disassemble or modify the unit.**
Do not disassemble, modify the unit or attempt to repair the product yourself. If the product needs to be repaired, consult your dealer or an authorized Panasonic Service Centre.
- Do not use the unit when it is out of order.**
If the unit is out of order (no power, no sound) or in an abnormal state (has foreign objects in it, is exposed to water, is smoking, or smells), turn it off immediately and consult your dealer.
- The remote control unit should not lie about in the car.**
If the remote control unit lies about, it could fall on the floor while driving, get wedged under the brake pedal, and lead to a traffic accident.
- Refer fuse replacement to qualified service personnel.**
When the fuse blows out, eliminate the cause and have it replaced with the fuse prescribed for this unit by a qualified service engineer. Incorrect replacement of the fuse may lead to smoke, fire, and damage to the product.

Observe the following warnings when installing.

- Disconnect the lead from the negative (–) battery terminal before installation.**
Wiring and installation with the negative (–) battery terminal connected may cause electrical shock and injury due to a short circuit.
Some cars equipped with the electrical safety system have specific procedures of battery terminal disconnection.
FAILURE TO FOLLOW THE PROCEDURE MAY LEAD TO THE UNINTENDED ACTIVATION OF THE ELECTRICAL SAFETY SYSTEM RESULTING IN DAMAGE TO THE VEHICLE AND PERSONAL INJURY OR DEATH.
- Never use safety-related components for installation, grounding, and other such functions.**
Do not use safety-related vehicle components (fuel tank, brake, suspension, steering wheel, pedals, airbag, etc.) for wiring or fixing the product or its accessories.
- Installing the product on the air bag cover or in a location where it interferes with airbag operation is prohibited.**
- Check for piping, gasoline tank, electric wiring, and other items before installing the product.**
If you need to open a hole in the vehicle chassis to attach or wire the product, first check where the wire harness, gasoline tank, and electric wiring are located. Then open the hole from outside if possible.
- Never install the product in a location where it interferes with your field of vision.**
- Never have the power cord branched to supply other equipment with power.**
- After installation and wiring, you should check the normal operation of other electrical equipment.**
The continuation of their using in abnormal conditions may cause fire, electrical shock or a traffic accident.
- In the case of installation to an airbag-equipping car, confirm warnings and cautions of the vehicle manufacturer before installation.**
- Make sure the leads do not interfere with driving or getting in and out of the vehicle.**
- Insulate all exposed wires to prevent short circuiting.**

Caution

Observe the following cautions when using this unit.

- ❑ **Keep the sound volume at an appropriate level.**
Keep the volume level low enough to be aware of road and traffic conditions while driving.
- ❑ **Do not insert or allow your hand or fingers to be caught in the unit.**
To prevent injury, do not get your hand or fingers caught in moving parts or in the disc slot. Especially watch out for infants.
- ❑ **This unit is designed for use exclusively in automobiles.**
- ❑ **Do not operate the unit for a prolonged period with the engine turned off.**
Operating the audio system for a long period of time with the engine turned off will drain the battery.
- ❑ **Do not expose the unit to direct sunlight or excessive heat.**
Otherwise these will raise the interior temperature of the unit, and it may lead to smoke, fire, or other damage to the unit.
- ❑ **Do not use the product where it is exposed to water, moisture, or dust.**
Exposure of the unit to water, moisture, or dust may lead to smoke, fire, or other damage to the unit. Make especially sure that the unit does not get wet in car washes or on rainy days.

Observe the following cautions when installing.

- ❑ **Refer wiring and installation to qualified service personnel.**
Installation of this unit requires special skills and experience. For maximum safety, have it installed by your dealer. Panasonic is not liable for any problems resulting from your own installation of the unit.
- ❑ **Follow the instructions to install and wire the product.**
Not following the instructions to properly install and wire the product could cause an accident or fire.
- ❑ **Take care not to damage the leads.**
When wiring, take care not to damage the leads. Prevent them from getting caught in the vehicle chassis, screws, and moving parts such as seat rails. Do not scratch, pull, bend or twist the leads. Do not run them near heat sources or place heavy objects on them. If leads must be run over sharp metal edges, protect the leads by winding them with vinyl tape or similar protection.
- ❑ **Use the designated parts and tools for installation.**
Use the supplied or designated parts and appropriate tools to install the product. The use of parts other than those supplied or designated may result in internal damage to the unit. Faulty installation may lead to an accident, a malfunction or fire.

- ❑ **Do not block the air vent or the cooling plate of the unit.**

Blocking these parts will cause the interior of the unit to overheat and will result in fire or other damage.

- ❑ **Do not install the product where it is exposed to strong vibrations or is unstable.**
Avoid slanted or strongly curved surfaces for installation. If the installation is not stable, the unit may fall down while driving and this can lead to an accident or injury.
- ❑ **Installation Angle**
The product should be installed in a horizontal position with the front end up at a convenient angle, but not more than 30°. The user should bear in mind that in some areas there may be restrictions on how and where this unit can be installed. Consult your dealer for further details.
- ❑ **Wear gloves for safety. Make sure that wiring is completed before installation.**
- ❑ **To prevent damage to the unit, do not connect the power connector until the whole wiring is completed.**
- ❑ **Do not connect more than one speaker to one set of speaker leads. (except for connecting to a tweeter)**

Observe the following cautions when handling the battery for the remote control unit.

- Use only specified battery (CR2025).
- Match the polarity of the battery with the (+) and (-) marks in the battery case.
- Replace dead battery as soon as possible.
- Remove the battery from the remote control unit when not using it for an extended period of time.
- Insulate the battery (by placing them in a plastic bag or covering them with vinyl tape) before disposal or storage.
- Dispose of the battery according to the local regulations.
- Do not disassemble, recharge, heat or short the battery. Do not throw a battery into a fire or water.

In case of battery leakage

- Thoroughly wipe the battery liquid off the battery case and insert new battery.
- If any part of your body or clothing comes into contact with battery liquid, wash it with plenty of water.
- If battery liquid comes into contact with your eyes, wash them with plenty of water and get immediate medical attention.

Refer to safety information of optional devices as well.

Before Reading These Instructions

About this Book

This book is an instruction manual that explains how to operate your purchased head unit and its remote control as an accessory when the head unit is connected to optional devices.

Head units to be targeted

- CQ-C7703N/C7303N

All illustrations throughout this manual represent model CQ-C7703N unless otherwise specified.

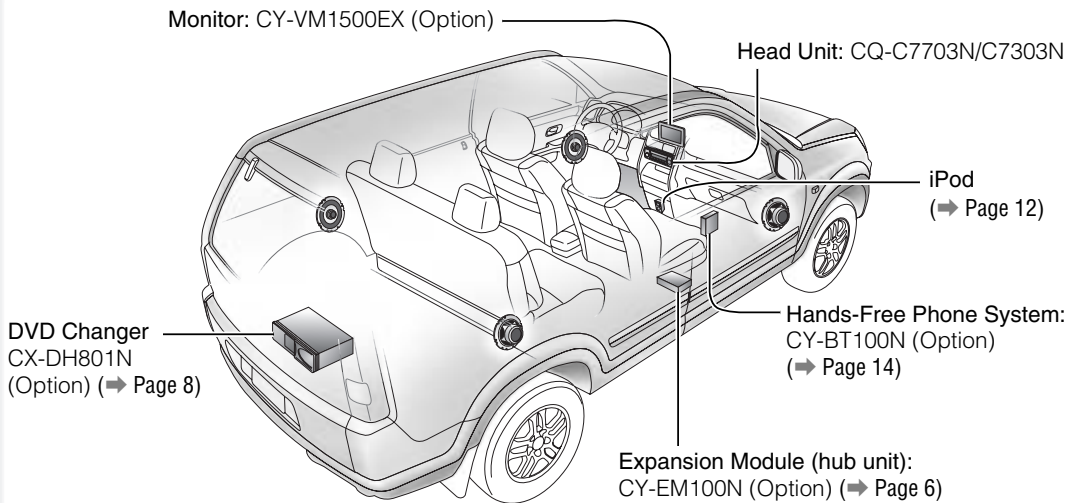

System Upgrade Sample

Head Unit

CQ-C7703N/C7303N

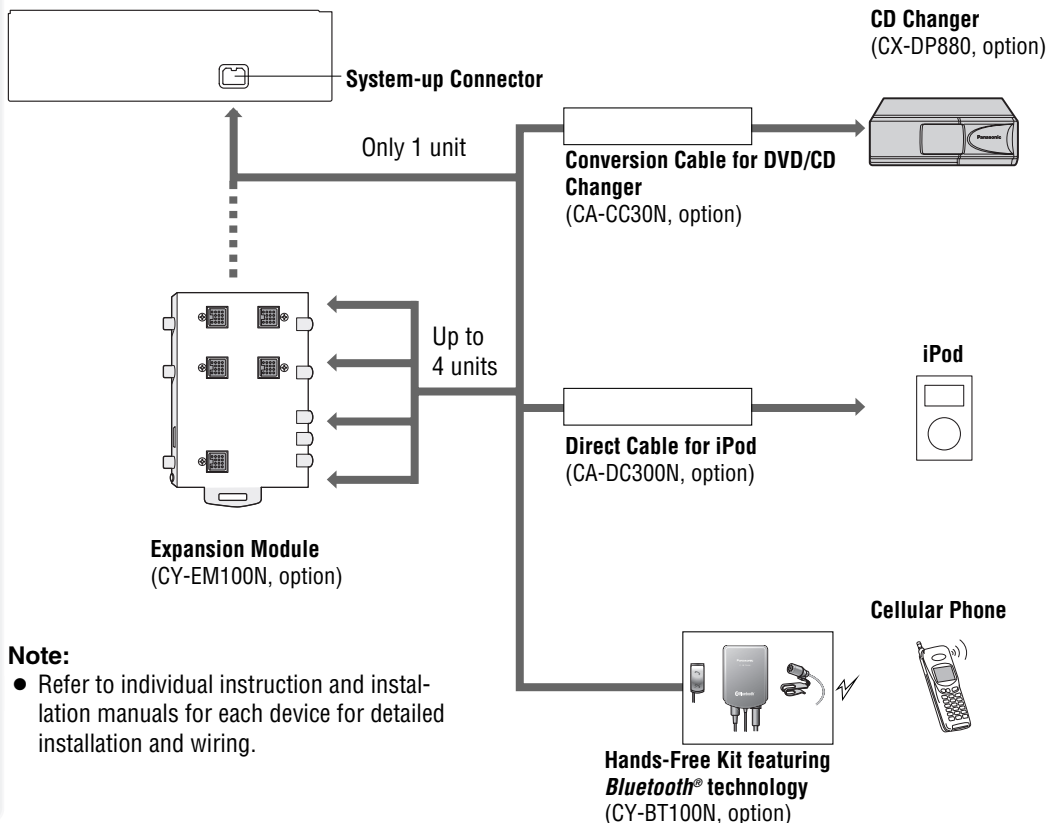

Note:

- Refer to individual instruction and installation manuals for each device for detailed installation and wiring.

Contents

English

2

Deutsch	18
Français	33
Nederlands	48
Svenska	63
Italiano	78
Español	93
Dansk	108
Polska	123
Čeština	138
Magyar	153
Русский	168

Common

● Safety Information	2
● Before Reading These Instructions	4

Each Source

● General	6
● Disc Changer	8
● iPod Control	12
● Hands-Free Phone System	14

As Needed

● Troubleshooting	16
--------------------------	-----------

DVD Changer

The optional adapter (Conversion Cable for DVD/CD Changer: CA-CC30N) allows you to connect the optional Panasonic DVD changer unit (CX-DH801N). For details, refer to the operating instructions for the DVD changer unit. (⇒ page 8, 10)

CD Changer

The optional adapter (Conversion Cable for DVD/CD Changer: CA-CC30N) allows you to connect the optional Panasonic CD changer unit (CX-DP880). For details, refer to the operating instructions for the CD changer unit. (⇒ page 8)

iPod®

The optional adapter (Direct Cable for iPod: CA-DC300N) allows you to connect the optional iPod series. (⇒ page 12)

The iPod equipped with a dock connector is exclusively connectable. Further information about the controllable iPod is described below.

Controllable iPod/software version

- 3rd generation iPod/ver. 2.3
- 4th generation iPod/ver. 3.1
- iPod Photo/ver. 1.2
- iPod mini/ver. 1.4
- iPod nano/ver. 1.0

* Operation check has been completed with software available at the end of October, 2005. We do not guarantee the operation with our future products or upgraded software.

iPod is a trademark of Apple Computer, Inc., registered in the U.S. and other countries.

Hands-Free Phone System

You can connect the optional Hands-Free Phone System (Hands-Free Kit featuring *Bluetooth*® technology: CY-BT100N). For details, refer to the operating instructions for the Hands-Free Phone System. (⇒ page 14)

Note: This unit is designed **only for receiving calls**. It cannot send calls.

Bluetooth®

The Bluetooth word mark and logo are owned by the Bluetooth SIG, Inc. and any use of such marks by Matsushita Electric Industrial Co.,Ltd. is under license. Other trademarks and trade name are those of their respective owners.

Expansion Module (hub unit)

You can connect the optional Expansion Module (hub unit) (CY-EM100N). Connection of the Expansion Module allows you to simultaneously connect optional devices mentioned before as well as other AV devices. For details, refer to the operating instructions for the Expansion Module.

Connectable devices

- CD changer (max. 1)
- iPod (max. 2)
- Hands-Free Phone System (max. 1)

Note: Market conditions regarding optional devices vary with countries and regions. For further information, consult your dealer.

The source changes as follows every time [SRC] (SOURCE) is pressed.

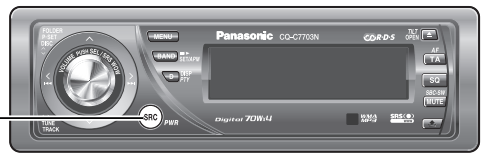

Radio

FM1, FM2, FM3, AM (⇒ Operating Instructions)



Player

When loading CD (⇒ Operating Instructions)



When loading MP3/WMA disc (⇒ Operating Instructions)



AUX 1

Device connected to the AUX terminal of the this unit



System-up Connector

Device connected to the System-up Connector of this unit

When optional devices are connected:

Shift to connected devices

When an expansion module is connected:

The devices connected to the ports 1 to 4 are activated in sequence after shifting to AUX2 (devices connected to the AUX terminal of the expansion module).



When connecting DVD Changer (⇒ page 8, 10)



When connecting CD Changer (⇒ page 8)



When connecting iPod (⇒ page 12)



When connecting Expansion Module



Disc Changer (When CDs or MP3 discs are loaded)

Connected an optional CD changer or an optional DVD changer can be controlled by this unit.

Operation Flow

1 Load a magazine (discs).

When a magazine is already loaded, press **[SRC]** (SOURCE) to select the CD changer mode.

The unit recognizes the magazine and starts playing automatically.



2 Select a desired portion.

Disc selection

[^]: Next disc

[v]: Preceding disc

Folder up/Down

Only for DVD Changer

Hold down for 2 sec. or more.

[^] (**FOLDER**): Next folder

[v] (**FOLDER**): Preceding folder

Track/File selection

[▶▶]: Next track/file

[◀◀]: Preceding track/file (press twice)

Note: Hold down for fast forward/reverse.

Pause

Press **[BAND]** (**||▶**).

Press again to cancel.

CD Changer Mode Display

Track/file ————— Time

Disc number —————

Changer indicator —————

CDch (CD changer)

DVDch (DVD changer)



Play Mode indicators
lights when each mode is activated.

RANDOM

REPEAT

SCAN

D-RANDOM (Disc Random, Only for CD changer)

D-REPEAT (Disc Repeat)

D-SCAN (Disc Scan, Only for CD changer)

lights when the changer is connected.

Notes:

- When CX-DP880 or CX-DH801N is connected, a CD-RW disc is playable.
- Trouble may occur while playing CD-Rs. Refer to the section on "Notes on CD/CD Media (CD-ROM, CD-R, CD-RW)". (→ Operating Instructions)
- This unit does not support the following through the CD changer.
 - **MP3 playback.**

Random, Repeat Play (Disc Changer Menu Display)

(RANDOM, REPEAT)

Random and Repeat play can be set.

1 Press [MENU] to display the menu display.

For using the remote control, hold down [SEL] (MENU) for 2 sec. or more.

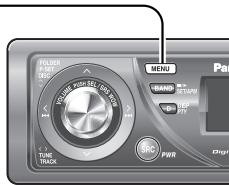

2 Press [^] or [V] to select a mode to be adjusted.

3 Press [BAND] (SET) to adjust.

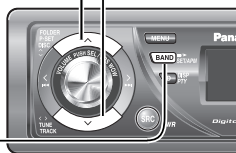

4 Press [MENU] to confirm the adjustment.

For using the remote control, hold down [SEL] (MENU) for 2 sec. or more.



RANDOM

- **CD-DA**
RANDOM playback of the selected disc (DVD changer)
RANDOM playback of all discs in the magazine (CD changer)
- **MP3 disc**
RANDOM playback of the selected folders

OFF: Off (default)

ON: Random playback

DISC RANDOM (Only for CD changer)

OFF: Off (default)

ON: Random playback (from selected disc)

REPEAT

OFF: Off (default)

ON: Playing the current track/file repeatedly

DISC REPEAT (Only for CD-DA disc)

OFF: Off (default)

ON: Playing the current disc repeatedly

FOLDER REPEAT (Only for MP3 disc)

OFF: Off (default)

ON: Playing the current folder repeatedly

Play Mode Selection

One-touch operation is available for selecting a track playing style by use of [RANDOM] or [REPEAT].

RANDOM, REPEAT

Press the button. Press again to cancel.

DISC RANDOM, DISC REPEAT, FOLDER REPEAT

Hold down the button for 2 sec. or more. Hold down again to cancel.

SCAN play

You can find your favorite file by playing first 10-sec. of each file.

SCAN (CD changer: All tracks, DVD changer: from selected disc)

Press [SCAN]. Press again to cancel.

DISC SCAN (1st file in each disc, only for CD changer)

Hold down [SCAN] for 2 sec. or more. Hold down again to cancel.

Direct Access

A disc can be directly selected.

Example: disc number 5

- 1 Press [#] (NUMBER).
- 2 Press [5].
- 3 Press [SET].

Note: To suspend direct selection, press [DISP] (DISPLAY).



Functions Only by Remote Control Unit

Disc Changer (when DVDs or VCDs are loaded)

Connected an optional DVD changer (CX-DH801N) can be controlled by this unit.

1 Load a magazine (discs).

When a magazine is already loaded, press **[SRC]** (SOURCE) to select the DVD changer mode.

The unit recognizes the magazine and starts playing automatically.

Notes:

- For DVD operations other than the above (i.e. DVD menu, closed caption, etc.), use the remote control unit supplied with the DVD changer.
- The remote control unit supplied with the DVD changer does not work properly when you aim it at this unit.
- When using the remote control unit supplied with the DVD changer, aim it at the monitor display (CY-VM1500EX).



2 Select a desired portion.

Disc selection

[^]: Next disc

[v]: Preceding disc

Chapter/Track selection

[>>>]: Next chapter/Next track

[<<<]: Preceding chapter/ Preceding track (press twice)

Note: Hold down for fast forward/reverse.

Pause

Press **[BAND]** (**|| >**).

Press again to cancel.

Chapter number —
Disc number —
Changer indicator —



Disc type

Time

Play Mode indicators

lights when each mode is activated.

REPEAT

D:REPEAT (Disc Repeat)

C:REPEAT (Chapter Repeat)

T:REPEAT (Title Repeat)

lights when the changer is connected.

Repeat play can be set.

- 1 Press **[MENU]** to display the menu display.

For using the remote control, hold down **[SEL] (MENU)** for 2 sec. or more.

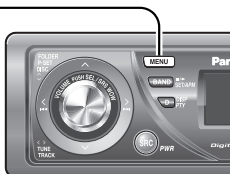

- 2 Press **[^]** or **[v]** to select a mode to be adjusted.

- 3 Press **[BAND] (SET)** to adjust.

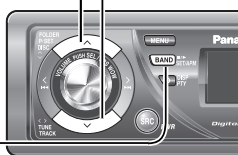

- 4 Press **[MENU]** to confirm the adjustment.

For using the remote control, hold down **[SEL] (MENU)** for 2 sec. or more.

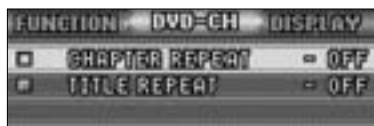

- For a DVD insertion

CHAPTER REPEAT

OFF: Off (default)

ON: Playing the current chapter repeatedly.

TITLE REPEAT

OFF: Off (default)

ON: Playing the current title repeatedly.

Note: The unit may not operate for some DVDs.

- For a VCD insertion

REPEAT

OFF: Off (default)

ON: Playing the current track repeatedly

DISC REPEAT

OFF: Off (default)

ON: Playing the current disc repeatedly

Notes:

- The unit may not operate for some VCDs.
- The unit may not operate for a disc with the play back function activated.

Play Mode Selection

One-touch operation is available for selecting a chapter playing style by use of or **[REPEAT]**.

CHAPTER REPEAT, REPEAT

Press the button. Press again to cancel.

TITLE REPEAT, DISC REPEAT

Hold down the button for 2 sec. or more. Hold down again to cancel.

Direct Access

A disc can be directly selected.

Example: disc number 5

- 1 Press **[#] (NUMBER)**.
- 2 Press **[5]**.
- 3 Press **[SET]**.



Note: To suspend direct selection, press **[DISP] (DISPLAY)**.

iPod Control

Connection of the optional iPod adapter (Direct cable for iPod) (CA-DC300N) allows users to operate the iPod including file selection and file sequence change with the buttons on this unit.

Operation Flow

- 1 Connect the iPod.
 - 2 Press [**SRC**] (SOURCE) to select the iPod mode. Playback starts.
- Note:** If playback does not start, press [**BAND**] (II / ►).
- 3 Select a desired portion.

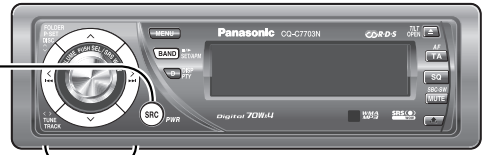

File Selection

- [►►]: Next file
- [◄◄]: Beginning of the current file
For the previous file, press twice.

Pause

- Press [**BAND**] (II / ►).
- Press again to cancel.

Playing Mode selection

The type with which playback data is classified is selectable.

- 1 Press the [▲] or [▼] button to call up the play mode selection screen.
- 2 Press the [▲] or [▼] button to select the play mode.

- PLAYLIST**: Playback by playlist
- ARTIST**: Playback by artist
- ALBUM**: Playback by album

Note: When the [◀] button is pressed, the regular screen appears.

- 3 Press the [**BAND**] button to determine the selection.
- 4 Press the [▲] or [▼] button to select a portion to be played.

Notes:

- For selecting ARTIST, the ALBUM selection screen appears after selecting an artist name.
- When the [◀] button is pressed, the previous screen appears.



- 5 Press the [**BAND**] button to determine the selection.

Notes: Files without an album name or an artist name are not playable in the playing mode of the album or artist display respectively.

iPod Mode Display

Current file

- iPod number
- iPod1 (iPod 1)
- iPod2 (iPod 2)



Time

lights when the direct cable for iPod (CA-DC300N) is connected.

Play Mode indicators

lights when each mode is activated.

- RANDOM** (Random)
- A-RANDOM** (Album Random)
- REPEAT** (Repeat)

Notes:

Files without an album name or an artist name are not playable in the playing mode of the album or artist display respectively.

- Controllable iPod/software version
 - 3rd generation iPod/ver. 2.3
 - 4th generation iPod/ver. 3.1
 - iPod Photo/ver. 1.2
 - iPod mini/ver. 1.4
 - iPod nano/ver. 1.0

* Operation check has been completed with software available at the end of October, 2005. We do not guarantee the operation with our future products or upgraded software.

- The shuffle function of iPod corresponds to the RANDOM function of this unit.
- Connect this unit after turning down the volume of the iPod.
- "NO iPod" appears until the iPod is recognized after connecting the iPod, turning on the power of the main unit, or performing source selection on the main unit side. This indicates there is nothing wrong with the main unit.
- We do not guarantee all the operations of connectable devices.

Random, Repeat Play (iPod Menu Display)
(RANDOM, REPEAT)

Random and Repeat play can be set.

1 Press **[MENU]** to display the menu display.

For using the remote control, hold down **[SEL]** (**MENU**) for 2 sec. or more.

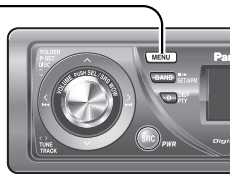

2 Press **[^]** or **[v]** to select a mode to be adjusted.

3 Press **[BAND]** (**SET**) to adjust.

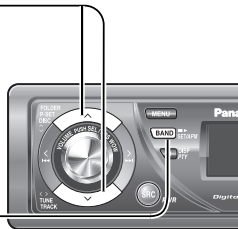

4 Press **[MENU]** to confirm the adjustment.

For using the remote control, hold down **[SEL]** (**MENU**) for 2 sec. or more.



RANDOM (Shuffle)

OFF: Off (default)

ON: From all available files

ALBUM RANDOM

OFF: Off (default)

ON: From files in the selected album

REPEAT

OFF: Off (default)

ON: Playing the current file repeatedly

Note: All files are played back even at REPEAT-off setting. (ALL REPEAT)

TEXT

Text display

NAME/TITLE: Name/Title (default)

ALBUM/TITLE: Album/Title

OFF: Disabled

Functions Only by Remote Control Unit

Play Mode Selection

One-touch operation is available for selecting a track playing style by use of **[RANDOM]** or **[REPEAT]**.

RANDOM, REPEAT

Press the button. Press again to cancel.

ALBUM RANDOM

Hold down the button for 2 sec. or more. Hold down again to cancel.

Hands-Free Phone System

Be sure to read "Safety Information" in the Operating Instructions for the Hands-Free Phone System before use.

Preparation

Connecting Hands-Free Phone System

Connect the Hands-Free Phone System (CY-BT100N) and establish the pairing. Refer to the operating instructions for the Hands-Free Phone System for further information.

Note: This unit is designed **only for receiving calls**. It cannot send calls.

Switch unit

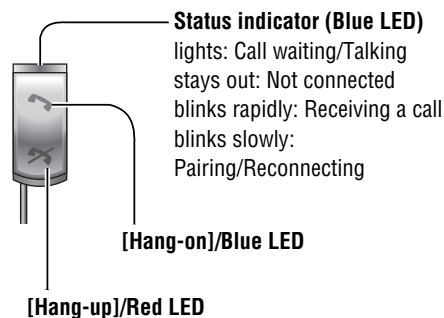

Operation Flow

- 1 Press **[Hang-on]** on the Hands-Free Phone System and pick up the phone.
The phone is in the incoming state.

- 2 Adjust the volume if necessary.

- 3 Press **[Hang-up]** on the Hands-Free Phone System and hung up the phone.



Adjust the ring volume

The ring volume is adjustable from this unit.
(Setting range: OFF/LOW/MID/HIGH, Default: MID)

[^]: up

[v]: down

Notes:

- The ring volume is adjustable only when receiving calls.
- The ring volume is adjustable only when the phone ring comes out of the main unit.

Reject calls

Pressing **[Hang-up]** allows users to reject a call when the call is coming in.

Bluetooth disconnection/reconnection

Pressing **[Hang-up]** allows users to temporarily disconnect when the phone is in the waiting state.
Pressing **[Hang-up]** allows users to reconnect when the Bluetooth unit is temporarily disconnected.

Notes:

- This item is not selectable by pressing [SRC] (PWR: POWER), but activated by receiving an incoming call.
- Only outline is described here. Refer to the operating instructions for the Hands-Free Phone System for further information.
- The mute function is automatically canceled when receiving a call even at mute-on setting.
- This unit is not operable when receiving a call at power-off setting.
- We do not guarantee all the operations of connectable devices.

Note: Speaker output is adjustable only when receiving calls.

- 1** Press [VOLUME] (PUSH SEL: SELECT) to display the AUDIO menu display.



Speaker selection

- BOTH** : Sound from both speakers (default)
- LEFT** : Sound from left speaker
- RIGHT** : Sound from right speaker

- 2** Press [VOLUME] (PUSH SEL: SELECT) to select a mode to be adjusted.

Note: Sound comes only from the front speakers.

- 3** Turn [VOLUME] clockwise or counterclockwise to adjust.

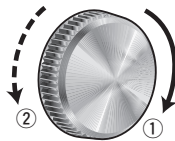

Note: If no operation takes place for more than 10 seconds in the audio menu (2 sec. in Main volume adjustment), the display returns to the regular mode.

Speaker Setting

(Hands-Free Phone System Menu Display)

Troubleshooting

If You Suspect Something Wrong

Check and take steps as described below.

If the described suggestions do not solve the problem, it is recommended to take the unit to your nearest authorized Panasonic Service Centre. The product should be serviced only by qualified personnel. Please refer the checking and the repair to professionals. Panasonic shall not be liable for any accidents arising out of neglect of checking the unit or your own repair after your checking.

Never take measures especially those other than indicated by *italic* letters in "Possible Solution" described below because those are too dangerous for users to handle themselves.

Warning

- Do not use the unit in an irregular condition, for example, without sound, or with smoke or a foul smell, which can cause ignition or electric shock. Immediately stop using the unit and consult your dealer.
- Never try to repair the unit by yourself because it is dangerous to do so.

Display	Possible cause → Possible solution
DISC Changer 	<p>The disc is dirty, or is upside down.</p>
	<p>The disc has scratches. → Eject the magazine.</p> <ul style="list-style-type: none"> Check the disc. Load the disc again.
	<p>No operation by some cause. → Eject the magazine. If failure persists, press the reset switch on the disc changer. If normal operation is not restored, consult your dealer or the nearest Panasonic Service Centre to ask for repairs.</p>
	<p>An error arises in the DVD changer. → Check the DVD changer. ("REGION ERROR" etc.)</p>
	<p>No disc is in the CD Changer (magazine). → Insert discs into the changer (magazine).</p>
<p>The changer has become disconnected from the unit in the changer mode. → Verify the wiring.</p>	

Note: Messages in the action and display sections of the error chart vary with changers. Refer to the operating instructions for the Disc changer for details.

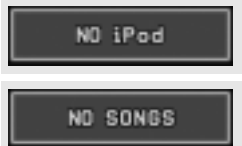
iPod Control 	<p>The iPod cable was disconnected in the iPod mode. → Reconnect the iPod cable.</p>
	<p>Your iPod has no playable music. → Download playable music to your iPod.</p>

Hands-Free Phone System

Display

HF UNIT ERROR

Possible cause → Possible solution

Failure to communicate with the Hands-Free Phone System

- **Check the connection to the Hands-Free Phone System. (→ page 14)**
- **Make sure that the pairing is successfully completed. (→ Operating Instructions)**

Matsushita Electric Industrial Co., Ltd.
Web Site : <http://www.panasonic.co.jp/global/>

Free Manuals Download Website

<http://myh66.com>

<http://usermanuals.us>

<http://www.somanuals.com>

<http://www.4manuals.cc>

<http://www.manual-lib.com>

<http://www.404manual.com>

<http://www.luxmanual.com>

<http://aubethermostatmanual.com>

Golf course search by state

<http://golfingnear.com>

Email search by domain

<http://emailbydomain.com>

Auto manuals search

<http://auto.somanuals.com>

TV manuals search

<http://tv.somanuals.com>