

# Panasonic®

Heavy Duty CD Player / Weather Band Receiver

## CQ-3700EU

### Operating Instructions



Please read these instructions completely before operating this unit.

*Panasonic welcomes you to our ever growing family of electronic product owners. We know that this product will bring you many hours of enjoyment. Our reputation is built on precise electronic and mechanical engineering, manufactured with carefully selected components and assembled by people who take pride in their work. Once you discover the quality, reliability, and value we have built into this product, you too will be proud to be a member of our family.*

---

## **□ Use This Equipment Safely**

### **When Driving**

Keep the volume level low enough to be aware of road and traffic conditions.

### **When Vehicle Washing**

Do not expose the equipment, including the speakers to water or excessive moisture. This could cause electrical shorts, fire, or other damage.

### **When Parked**

Parking in direct sunlight can produce very high temperatures inside your vehicle. Give the interior a chance to cool down before switching the unit on.

### **Use the Proper Power Supply**

This equipment is designed to operate off a 12 volt, negative ground battery system (the normal system in a North American vehicle.)

### **Protect the Compact Disc Mechanism**

Avoid inserting any foreign matters to the slot of the compact disc.

Failure to observe this may cause malfunction due to precise mechanism of this unit.

### **Use Authorized Servicenters**

Do not attempt to disassemble or adjust this precision equipment. Please refer to the Servicenter list included with this product for service assistance.

**Note:**

- This unit can be connected to an optional Wired remote control unit (CA-RC3000EU).
- For connecting to a Wired remote control unit, refer to the operating instructions of that units.

---

Find the model number and serial number on either the back or bottom of the unit. Please record them in the space below and retain this booklet as a permanent record of your purchase to aid in identification in case of theft.

MODEL NUMBER     **CQ-3700EU**     SERIAL NUMBER \_\_\_\_\_

DATE PURCHASED \_\_\_\_\_ FROM \_\_\_\_\_

# Contents

Use This Equipment Safely .....Page 2

Laser Products.....Page 4

---

**Power and Sound Controls**.....5  
How to adjust the volume, balance, and tone for best listening



---

**Radio Basics** .....7  
Mode selection, manual and automatic tuning, band selection, preset stations

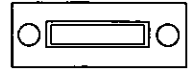

---

**Compact Disc Player Basics** .....10  
Play, repeat, random and scan

---

**Clock Basics**.....12  
Setting the time, selecting the clock display, Alarm Operation



---

**Installation Guide** .....14  
Step-by-step procedures, electrical connections

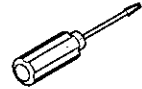

---

**Troubleshooting** .....23  
Troubleshooting tips, where to get service help

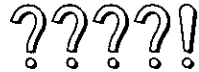

---

**Specifications**.....26

## ☐ Laser Products (This page describes the standard in the United States only.)

### Caution:

This product utilizes a laser.  
Use of controls or adjustments or performance of procedures other than those specified herein may result in hazardous radiation exposure.

### Laser products:

Wave Length 780 nm

Laser Power No hazardous radiation is emitted with safety protection.

### ● Label indications and their locations

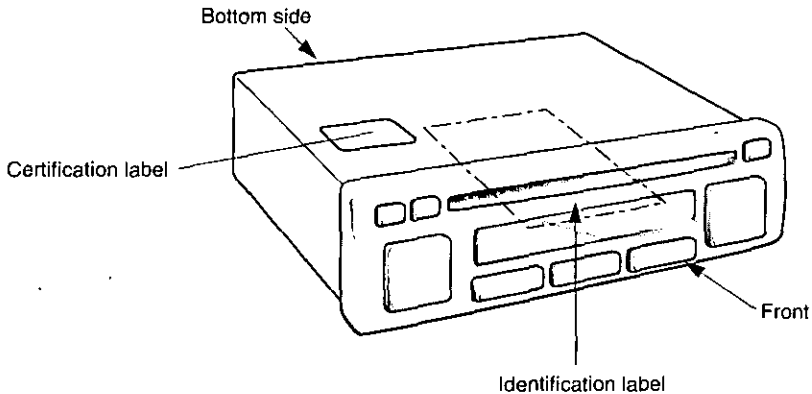

#### Certification Label

Product complies with DHHS Rules 21 CFR, Subchapter J in effect as of date of manufacture.  
Matsushita Electric (Taiwan) Co., Ltd.  
Taipei, Taiwan

MANUFACTURED



#### Identification Label

Model No. **CQ-3700EU**

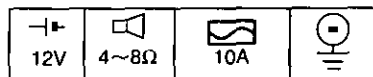

Manufactured by Matsushita Electric (Taiwan)  
Co., Ltd. Taipei Taiwan  
Made in Taiwan

# Power and Sound Controls

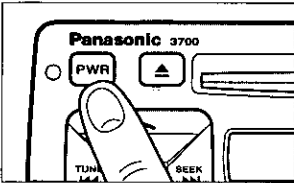
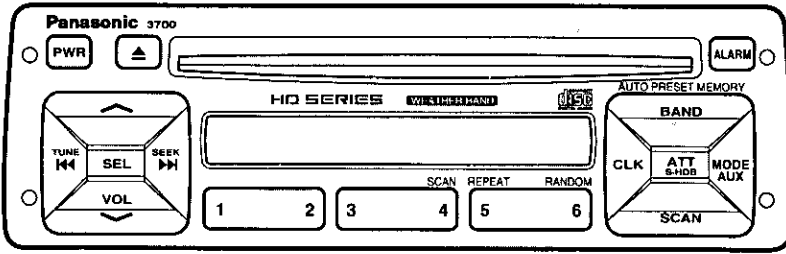

## Power

If the vehicle is not already running, turn the key in the ignition until the accessory indicator lights.

Press PWR to switch on the power.

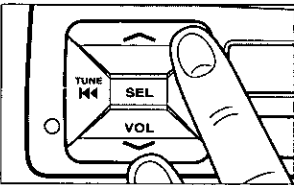

## Volume

- Press "VOL ^" or "VOL v" to increase or decrease volume.

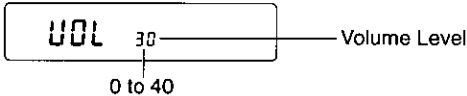

- Press "VOL ^" or "VOL v" for more than a half second to change numeric levels on the display rapidly.

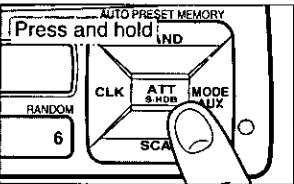

## S•HDB (Super High Definition Bass)

Especially for rock music, the bass-sound will be more powerful.

- Press and hold ATT (S•HDB) for more than 2 seconds to be able to listen to high-definition bass.

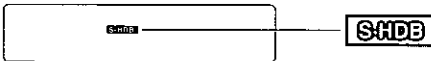

- Press and hold ATT (S•HDB) for more than 2 seconds to return to the normal tone.

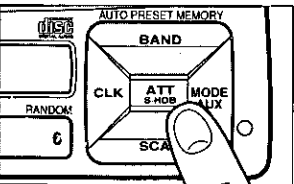

## Attenuator

- Press ATT. Volume will decrease to about 1/10 of its previous level.

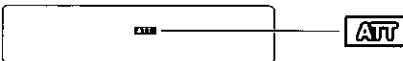

- Press ATT again to deactivate when listening at normal volume.

**Note:** This unit is equipped with anti-volume-blast circuit which serves as an automatic volume level adjuster so that you will not be deafened with sudden loud volume.

This system operates as below. When PWR is first pressed to switch on, the volume level is low. After that, the volume level gradually returns to the level when the switch is turned off.

Anti-volume-blast circuit is not effective when volume level is lower than position 20 on the display.

# Power and Sound Controls continued

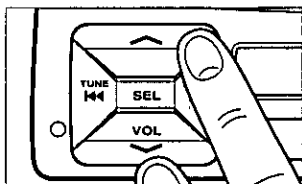
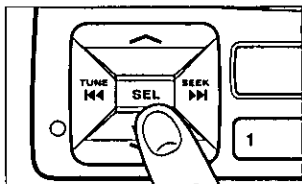
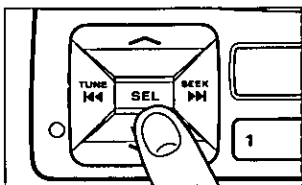

## Changing Audio Modes

Press SEL to switch the audio mode in the following order.



## Bass and Treble

Press SEL to select the BASS (TREBLE) mode. Press "VOL^" or "VOL V" to increase or decrease the bass/treble response.

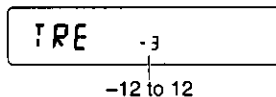
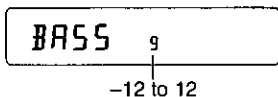

## Balance

Press SEL to select the BALANCE mode. Press "VOL^" or "VOL V" to shift the sound volume to the right or left speakers.

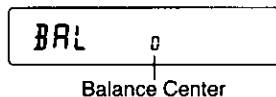
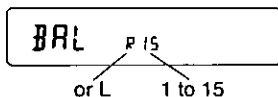

## Fader

Press SEL to select the FADER mode. Press "VOL^" or "VOL V" to shift the sound volume to the front or rear speakers.

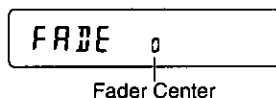
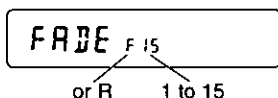

### CAUTION:

When changing sound volume level for the rear side speakers by using FADER button of the wired remote control unit (CA-RC3000EU), it may occur that a sudden change in volume from the front side speakers. So, pay attention when you adjust the volume.

### Note:

When a control mode (BASS/TRE/BAL/FADE) is selected but no operation is made within 5 seconds (2 seconds at volume mode), the display will return to the normal operation (Radio, Tape) mode. In such a case, press SEL again to select the next control mode.

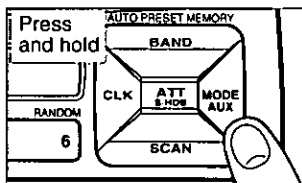

## Selecting Auxiliary Source

- Press and hold MODE (AUX) for more than 2 seconds to select AUX Input mode.

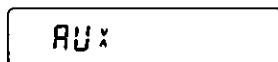

- Connect the auxiliary equipment (any other appropriate equipment) to the AUX IN Connector.

### Canceling AUX Input mode

Press MODE (AUX) to resume the previous mode.

# Radio Basics

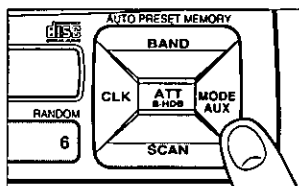
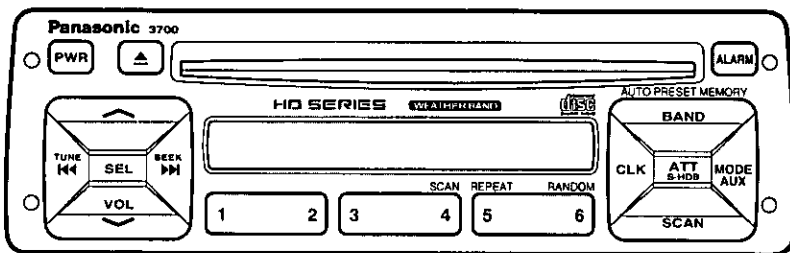

## Mode Selection

Press MODE to switch the operation mode in the following order.

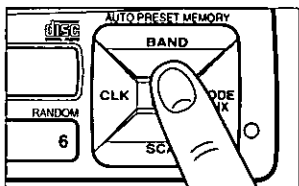

## Selecting a Band

Press BAND to select the bands in the following order.

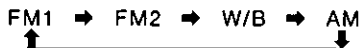

"ST" indicator lights if the station is FM broadcasting in stereo.

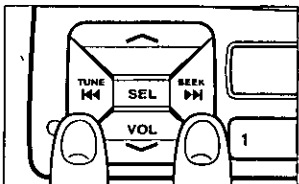
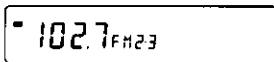

## Manual Tuning

Press "▶▶" or "◀◀" to move to a higher or lower frequency.

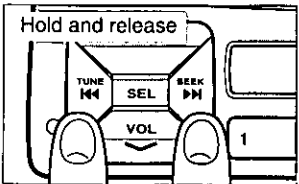

## Seek Tuning

Press and hold "▶▶" or "◀◀" for more than a half second, then release. The radio automatically stops on the next station.

# Radio Basics continued

## Preset Station Setting

Up to 18 stations can be preset in the station memory as follows;

FM1	FM2	AM
6 stations	6 stations	6 stations

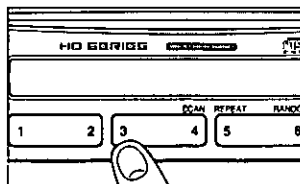
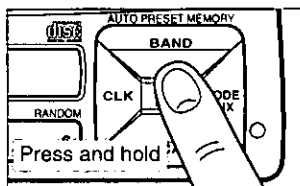
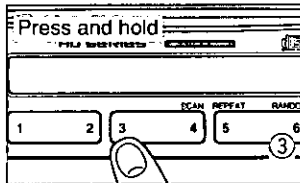
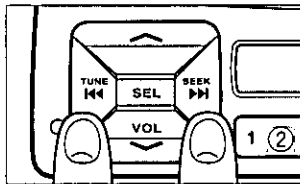
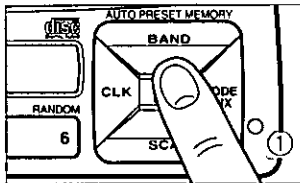

## Manual Station Preset

- 1 Press BAND to select a desired band.
  - 2 Use manual or seek tuning to find a station that you want to program into memory.
  - 3 Press and hold one of the station selector buttons 1 through 6 until the display blinks. The memory is now set for that button on the band you have selected.
- Repeat the process to set other stations for the FM1 to AM bands.

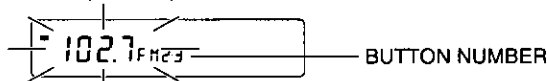

**Note:** You can change the memory setting by repeating the above procedure.

## Tuning in a Preset Station

Press any of the buttons 1 through 6 to tune in the station preset by the above steps 1 to 3.

## Auto Station Preset

Select a band and press and hold BAND (AUTO PRESET MEMORY) for more than 2 seconds.

- The six strongest available stations will be automatically set in memory on preset buttons 1 through 6.
- Once set, the preset stations are sequentially scanned for 5 seconds.
- Press the appropriate preset button for the station you want to hear.

**Note:**

- In the case of Auto Station Preset, only FM2 is available for FM stations. (FM1 is not available.)
- Auto Station Preset is not activated in a Weather Band.

**CAUTION:** For safety reasons, do not attempt to program while driving.



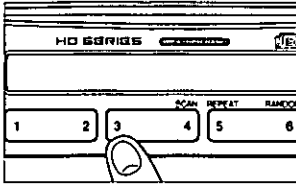

## Tuning in a Weather Band Station

Press any of the buttons 1 through 6 to tune in the station preset by the before page.

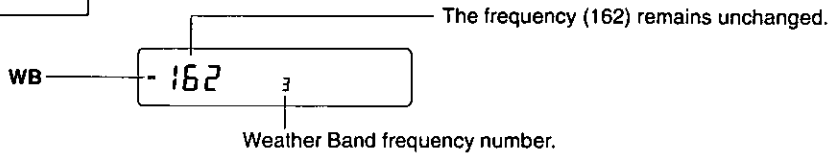

**Note:**

The weather band (CH1-6) has been preset in advance. CH7 is selected by pressing "▶▶" or "◀◀".

## Weather Band Stations

National Weather Radio Broadcasts from over 380 locations throughout the U.S. on seven VHF/FM frequencies.

Tune to weather band to receive continuous weather information 24 hours a day on one of the following frequencies.

1. 162.550 MHz
2. 162.400 MHz
3. 162.475 MHz
4. 162.425 MHz
5. 162.450 MHz
6. 162.500 MHz
7. 162.525 MHz

Occasionally the frequency of an existing or planned station must be changed because of unexpected radio frequency interference with adjacent NOAA Weather Radio Stations, and with other Government or Commercial Operations within the area. If you have a question concerning NOAA Weather Radio please contact your nearest National Weather Service Office.

# Compact Disc Player Basics

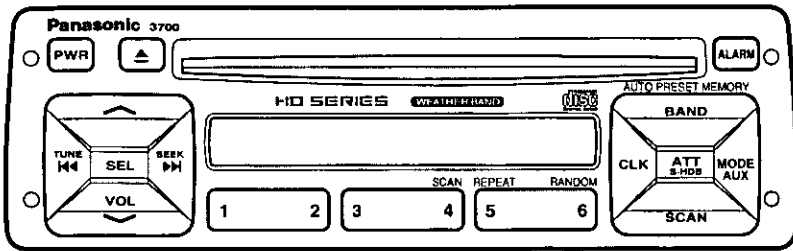

## To start the CD Player

Insert the disc and playback starts automatically.

"LOAD" will be displayed until the disc is loaded. Play starts from the first track.

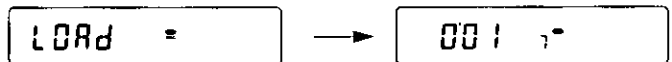

Note: While the disc is inserted, "  " indicator will light.

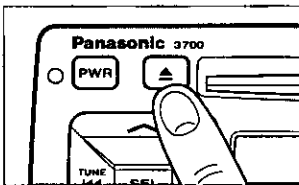

## Stopping and Ejecting a Disc

Press "▲" to stop CD play, and the disc will quietly eject from the CD slot. (During disc ejection, "EJ" will be displayed.)

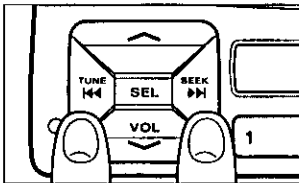

## Selecting a Track

- Press "▶▶" once to go to the next track.
- Press "◀◀" once to play from the beginning of the track you are listening to. Press twice to play the previous track.
- Press repeatedly to skip the desired number of tracks.

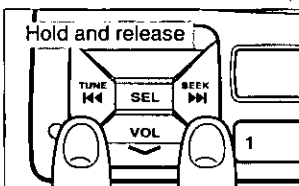

## Searching a Track

- Press and hold "▶▶" or "◀◀" for more than a half second to activate fast forward or reverse through a track.
- Release "▶▶" or "◀◀" to resume the normal CD play.

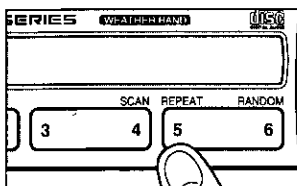

## Repeating a Track

- Press 5(REPEAT) to repeat the current selection.



- Press 5 (REPEAT) again to cancel.

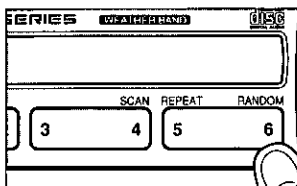

## Random Selection

- Press 6 (RANDOM). A random selection of music is played from all available tracks.

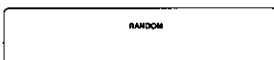

- Press 6 (RANDOM) again to cancel.

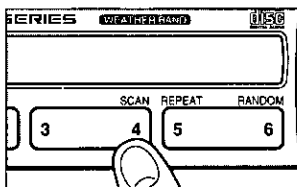

## Scanning a Disc

- Press 4 (SCAN). The display will blink and the first 10 seconds of each track on the disc play in order.

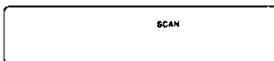

- Press 4 (SCAN) again to cancel.

# Clock Basics (The clock system is 12-hours.)

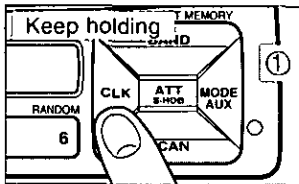
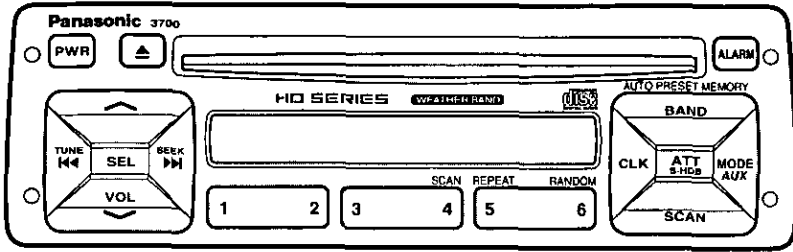

## Initial Time Setting

- ① Keep holding CLK until you have set the time, "AM12:00" blinks indicating the time setting mode is activated.

To set hours, press "◀◀".

To set minutes, press "▶▶".

(Hold "◀◀" or "▶▶" to change numbers rapidly.)

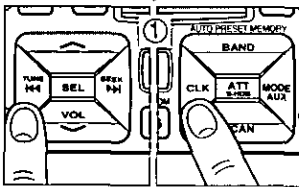

- ② When you have set the time, release CLK.

Note: When the clock is not set yet, "AdJ" is displayed.

OR

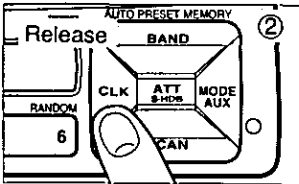
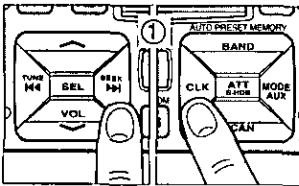

## Resetting the Time

When you want to reset the time, repeat step ① to ② above.

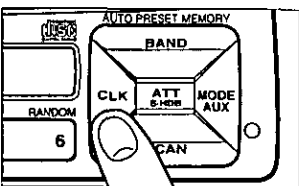

## Selecting the Clock Display

Press CLK to display alarm time.

After a few seconds, current time returns on display.

Note: The current time will display at all the time even the power of the radio is turned off.

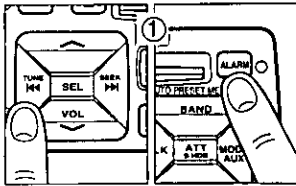
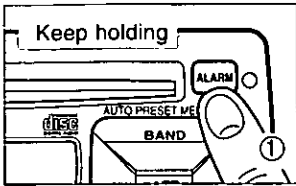

or

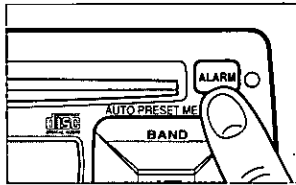
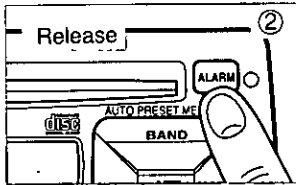
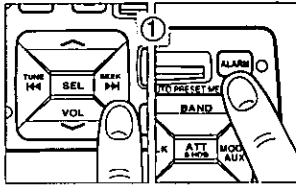

## Alarm Time Setting

- ① Keep holding ALARM until you have set the alarm time, "AM12:00" blinks indicating the time setting mode is activated.  
To set hours, press "◀◀".  
To set minutes, press "▶▶".  
(Hold "◀◀" or "▶▶" to change numbers rapidly.)

- ② When you have set the alarm time, release ALARM.

Note: When the alarm is not set yet, "AdJ" is displayed.

## Resetting the Alarm Time

When you want to reset the alarm time, repeat step ① to ② above.

## Alarm Operation

- Ⓐ Alarm is switched to ON or OFF each time ALARM is pressed.
- Ⓑ When the Alarm is switched to ON, the alarm sound will activate at the set alarm time.

### Turning off the Alarm Sound

The alarm sound will turn off automatically after 90 seconds. Otherwise, press ALARM once.

## Alarm output Volume Select

You may select ALARM VOL 1 (or VOL 2) by pressing ALARM.

- VOL 1 is lower than VOL 2
- OFF → VOL 1 → VOL 2

ALM VOL 1

### CAUTION:

- Be careful not to set wrong alarm time, otherwise, the alarm may sound while driving.
- If the alarm is set, be sure to check the set alarm time by pressing CLK.
- If you operate the radio, etc. at the time set the alarm, the alarm sound may be muted.
- If Volume is set at "0" step, the output volume will be muted. (Even when ALARM is acting.)

# Installation Guide



## WARNING

This installation information is designed for experienced installers and is not intended for non-technical individuals. It does not contain warnings or cautions of potential dangers in attempting to install this product.

Any attempt to install this product in a motor vehicle by anyone other than qualified installer could cause damage to the electrical system and could result in serious personal injury or death.

### □ Overview

This equipment should be installed by a professional. However, if you plan to install this unit yourself, your first step is to decide where to install it. The instructions in these pages will guide you through the remaining steps: (Please refer to "WARNING" statement above).

- Identify and label the vehicle wires
- Connect the vehicle wires to the wires of the power connector
- Install the unit in the dash
- Check the operation of the unit

If you do encounter problems, please consult your nearest professional installer.

**CAUTION:** This unit will operate with a 12 volt DC negative ground auto battery system only. Do not attempt to use it in any other system. Doing so could cause serious damage.

Before you begin installation, look for the following items included in the packing with your unit.

- **Warranty Card** ..... Fill this out promptly
- **PASC Servicenter Directory** ..... Keep for future reference in case the unit needs servicing
- **Installation Hardware** ..... Needed for in-dash installation
- **Power Connector**

### □ Installation Hardware

No.	Item	Diagram	Qty
①	Mounting Collar		1
②	Plain Washer (5 mmφ)		2
③	Spring Washer (5 mmφ)		2
④	Hex. Nut (5 mmφ)		2
⑤	Rear Support Strap		1
⑥	Hex. Bolt (5 mmφ x 25 mm)		1
⑦	Toothed Lock Washer (5 mmφ)		1
⑧	Power Connector		1
⑨	Dismounting Pin (U-shaped)		2

## ❑ Required Tools

You'll need a screwdriver, a 1.5 volt AA battery, and the following:

12 V DC  
TEST BULB

ELECTRICAL  
TAPE

SIDE-CUT  
PLIERS



Cut the connector plug off (leaving the leads as long as possible) so that you can work with individual leads.



## ❑ Dashboard Specifications

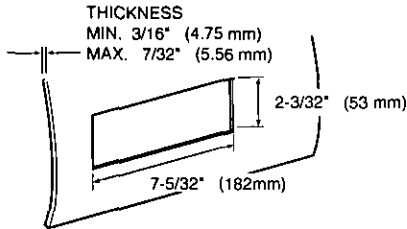

## ❑ Identify All Leads

The first step in installation is to identify all the vehicle wires you'll use when hooking up your sound system.

As you identify each wire, we suggest that you label it using masking tape and a permanent marker. This will help avoid confusion when making connections later.

**Note:** Do not connect the power connector to the stereo unit until you have made all connections. If there are no plastic caps on the stereo hooking wires, insulate all exposed leads with electrical tape until you are ready to use them. Identify the leads in the following order.

### Power Lead

If your vehicle has a radio or is pre-wired for one :

Turn the ignition on to the accessory position, and ground one lead of the test bulb to the chassis.

Touch the other lead of the test bulb to each of the exposed wires from the cut radio connector plug. Touch one wire at a time until you find the outlet that causes the test bulb to light.

Now turn the ignition off and then on. If the bulb also turns off and on, that outlet is the vehicle power lead.

If your vehicle is not wired for an audio unit :  
Go to the fuse block and find the fuse port for radio (RADIO), accessory (ACC), or ignition (IGN).

### Battery Lead

If your stereo unit has a yellow lead, you will need to locate the vehicle's battery lead. Otherwise you may ignore this procedure. (The yellow battery lead provides continuous power to maintain a clock, memory storage, or other function.)

If your vehicle has a radio or is pre-wired for one:  
With the ignition and headlights off, identify the vehicle battery lead by grounding one lead of the test bulb to the chassis and checking the remaining exposed wires from the cut radio connector plug.

If your vehicle is not wired for an audio unit :  
Go to the fuse block and find the fuse port for the battery, usually marked BAT.

### Speakers

Identify the vehicle speaker leads. There will be two leads for each speaker, usually color coded.

# Installation Guide continued

A handy way to identify the speaker leads and the speaker they connect with is to test the leads using a 1.5 volt AA battery as follows.

Hold one lead against one pole of the battery and stroke the other lead across the other pole. You will hear a scraping sound in a speaker if you are holding a speaker lead.

If not, keep testing different lead combinations until you have located all the speaker leads. When you label them, include the speaker location for each.

## Antenna

The antenna lead is a thick, black wire with a metal plug at the end.

---

## □ Connect All Leads

Now that you have identified all the wires in the vehicle, you're ready to begin connecting them to the stereo unit wires. The connection diagram on Page 21, 22 shows the proper connections and color coding of the leads.

We strongly recommend that you test the unit before making a final installation.

You can set the unit on the floor and make temporary connections to test the unit. Use electrical tape to cover all exposed wires.

---

**IMPORTANT** : Connect the red power lead last, after you have made and insulated all other connections.

---

## Ground

Connect the black ground lead of the power connector to the metal vehicle chassis.

## Speakers

Connect the speaker wires. See the wiring diagram below for the proper hookups. Follow the diagram carefully to avoid damaging the speakers and the stereo unit.

The speaker used must be able to handle more than 35 watts of audio power. If using an optional audio power, the speakers should be able to handle the maximum amplifier output power. Speakers with low input ratings can be damaged.

Speaker impedance should measure 4 - 8 ohms, which is typically marked on most speakers. Lower or higher impedance speakers will affect output and can cause both speaker and stereo unit damage.

---

**CAUTION** : Never ground the speaker cords. For example, do not use a chassis ground system or a three-wire speaker common system. Each speaker must be connected separately using parallel insulated wires. If in doubt about how your vehicle's speakers are wired, please consult with your nearest professional installer.

---

**CORRECT**  
No Common Ground

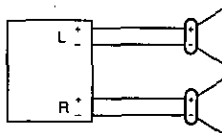

**INCORRECT**  
Common Chassis Ground

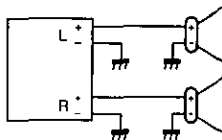

**INCORRECT**  
Speaker Common  
(common earth lead)

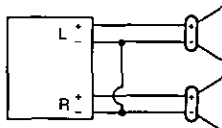



### **Battery**

Connect the yellow battery lead to the correct radio wire or to the battery fuse port on the fuse block.

### **Antenna**

Connect the antenna by plugging the antenna lead into the antenna receptacle.

### **Equipment**

Connect any optional equipment such as amplifier, according to the instructions furnished with the equipment. Keep about 12 inches (30 cm) of distance between the speaker cords/amplifier unit and the antenna/antenna extension cord. Read the operating and installation instructions for any equipment you will connect to this unit.

### **Accessory (ACC) Power**

Connect the red power lead to the correct vehicle radio wire or to the appropriate fuse port on the fuse block.

If the stereo unit functions properly with all these connections made, disconnect the wires and proceed to the final installation.

---

## **Final Installation**

### **Lead Connections**

Connect all wires, making sure that each connection is insulated and secure. Bundle all loose wires and fasten them with tape so they won't fall down later. Now insert the stereo unit into the mounting collar.

Congratulations! After making a few final checks, you're ready to enjoy your new auto stereo system.

---

## **Final Checks**

1. Make sure that all wires are properly connected and insulated.
2. Make sure that the stereo unit is securely held in the mounting collar.
3. Turn on the ignition to check the unit for proper operation.

If you have difficulties, consult your nearest authorized professional installer for assistance.

# Installation Guide continued

## □ Installation Procedures

### 1. Secure the Mounting Collar ①.

Insert Mounting Collar ① into the vehicle's dashboard, and bend mounting tabs out with a screwdriver.

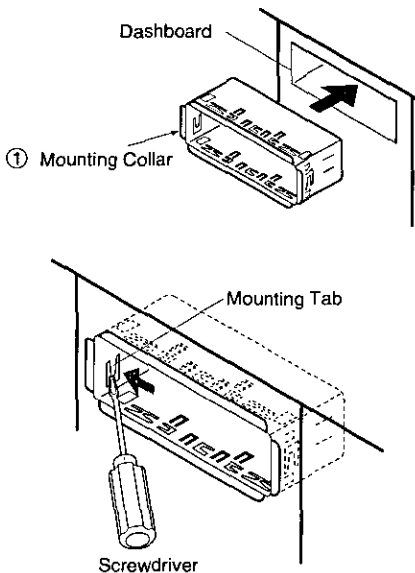

### 2. Secure the rear of the unit.

- Check the electrical connection by referring to this operating instructions.
- Insert the unit into Mounting Collar ① and push it in until "click" is heard.

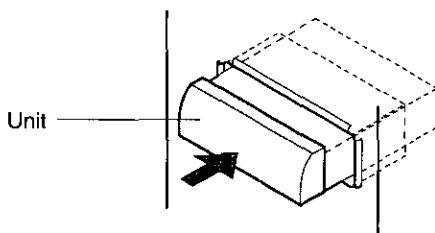

- Secure the rear of the unit to the vehicle by either of the two recommended methods on the next page.

■ Using the Rear Support Strap ⑤

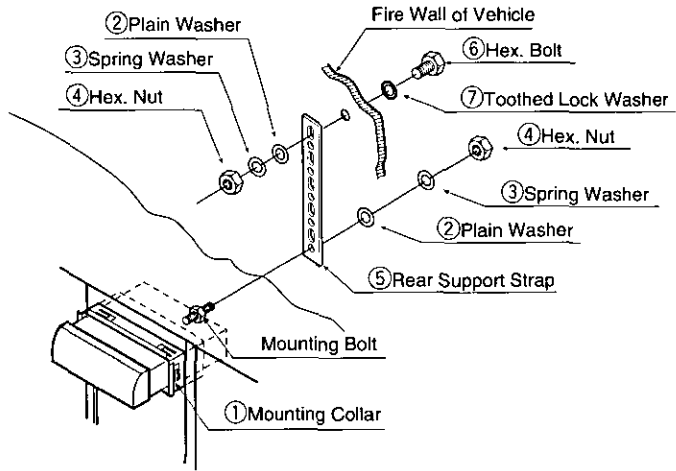

■ Using the Rubber Cushion (Optional)

(If there is an existing Rear Support Bracket on the Fire Wall of vehicle.)

Cover Mounting Bolt on the rear of the unit with Rubber Cushion (Optional), and mount it into the existing Rear Support Bracket.

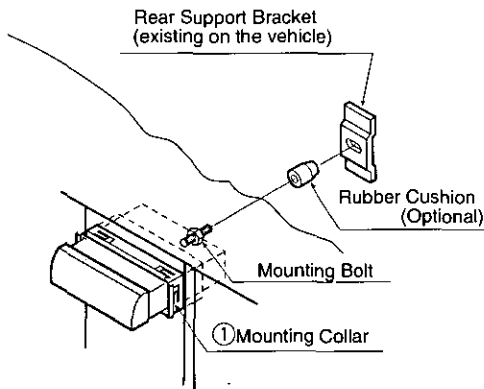

# Installation Guide continued

3. a) Plug the Power Connector ⑧.

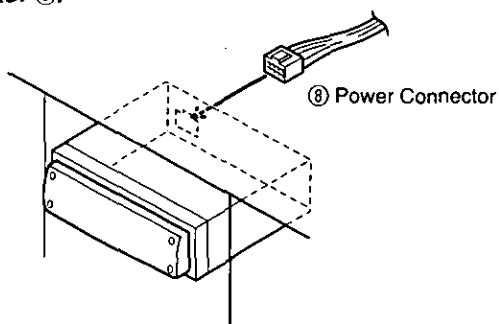

4. After installation reconnect the negative (–) battery terminal.

## To Remove the Unit from the vehicle's dashboard

Insert Dismounting Pins ⑨ and pull both pins.

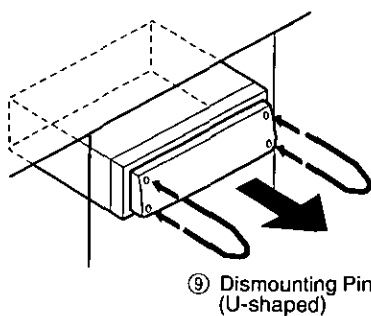

**Note:** Do not lose Dismounting Pins. They will be needed to remove the unit from the vehicle's dashboard.

**Caution:**

- To prevent damage to the unit, be sure to follow the connection diagram below.
- Remove the covering of the leads about 5 mm long from their end before connecting.
- Do not insert the power connector into the unit until the wiring is completed.
- Be sure to insulate any exposed wires from a possible short-circuit from the vehicle chassis. Bundle all cables and keep cable terminals free from touching any metal parts.

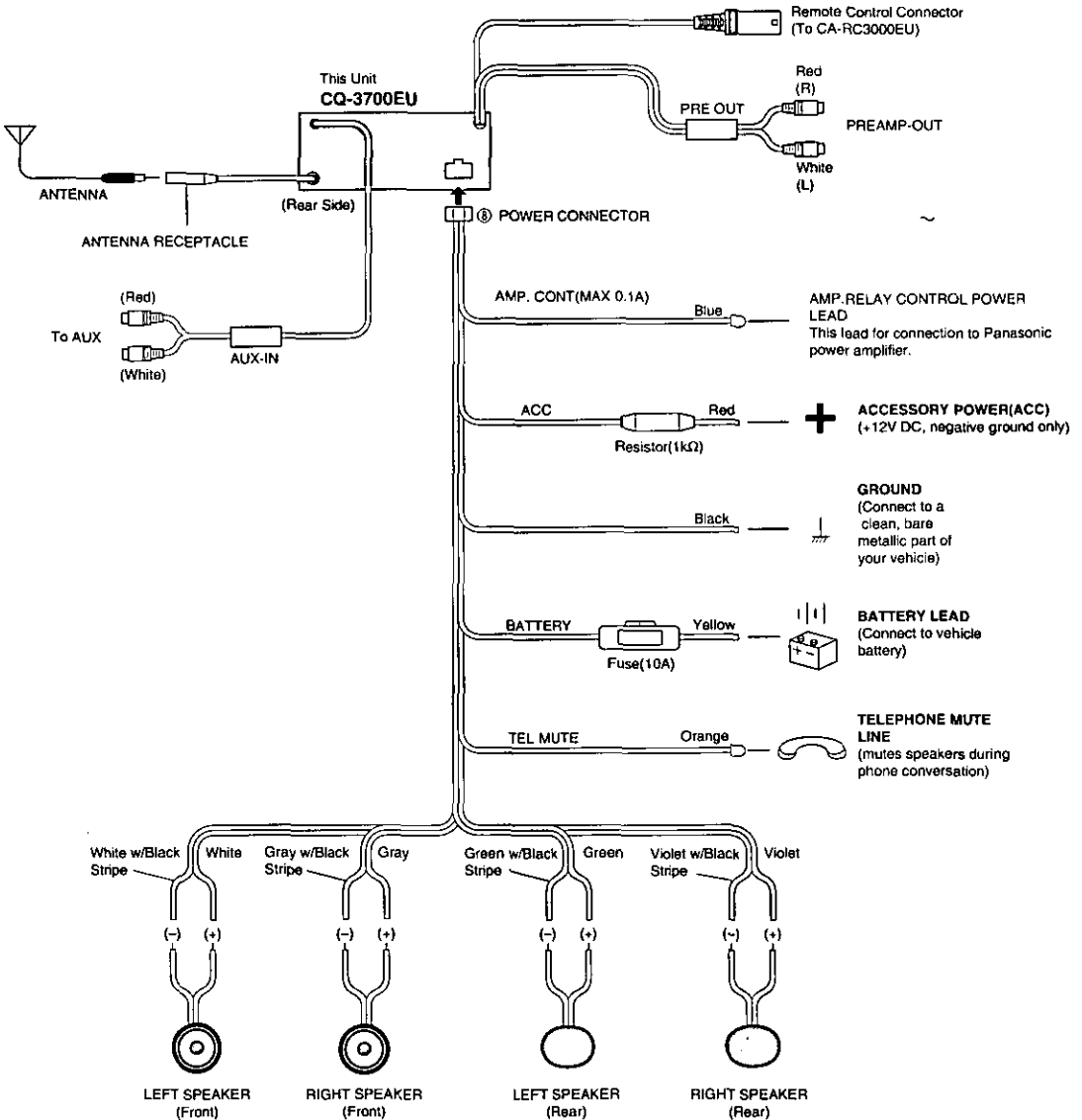

# Installation Guide continued

External Power Amplifier and Wired Remote Control Unit (CA-RC3000EU) to CQ-3700EU for upgrading the system.

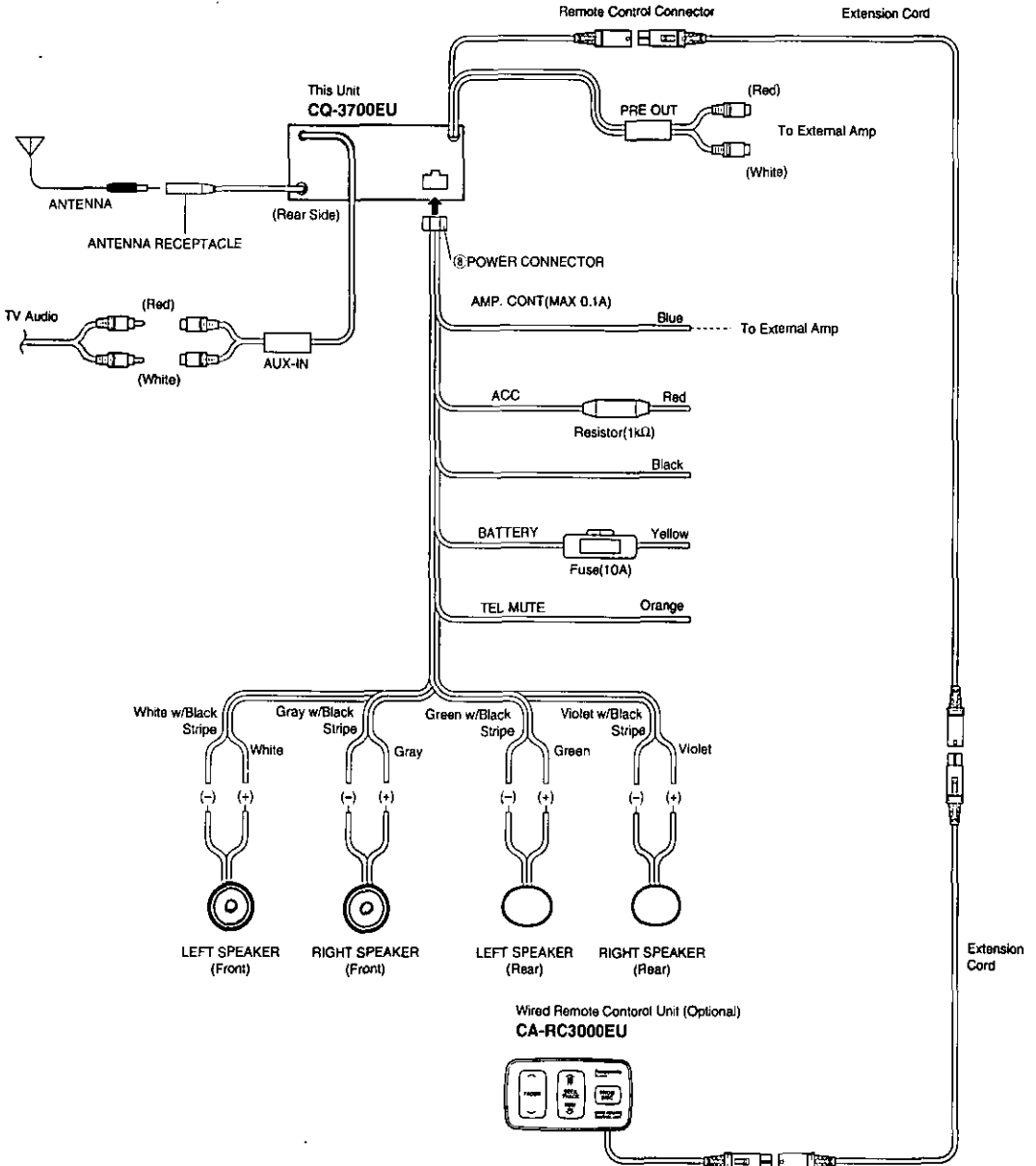

# Troubleshooting

---

## Maintenance

Your product is designed and manufactured to ensure a minimum of maintenance. Use a soft cloth for routine exterior cleaning. Never use benzene, thinner, or other solvent.

---

## When Something Doesn't Work

Check the charts on page 24 for possible causes and solutions to any problem you might be experiencing. Some simple checks or minor adjustments may eliminate the problem.

---

## Product Servicing

If the suggestions in the charts don't solve the problem, we recommend that you take it to your nearest authorized PASC Servicenter. The unit should be serviced only by a qualified technician.

---

## Replacing the Fuse

Use fuses of the same specified rating (10 amps). Using different substitutes or fuses with higher ratings, or connecting the unit directly without a fuse, could cause fire or damage to the stereo unit.

If the replacement fuse fails, contact your nearest PASC Servicenter for service.

## Error Display Messages

E 1	Displays when the compact disc is dirty or upside down. The disc eject automatically. But, the disc may eject automatically, even if this error message is not displayed.
E 2	Displays when compact disc is scratched. The disc eject automatically. But, the disc may eject automatically, even if this error message is not displayed.
E 3	Displays when the compact disc stops operating for some reason. Please turn off the vehicle engine (ACC off) and remove the fuse from yellow lead for 1 minute. Then reinstall the fuse.

# Troubleshooting continued

## ☐ Troubleshooting Tips

PROBLEM	POSSIBLE CAUSE	PROBABLE SOLUTION
Unit won't turn on.	Dead vehicle battery. Ignition not on. Bad power line connection. Fuse burned out.	Charge vehicle battery. Turn ignition to On or Accessory. Check connections. Replace fuse.
Radio has static.	Antenna not hooked up. Close to high power lines.	Hook up antenna. Move away from high power lines.
Radio memory buttons don't work.	Not holding buttons down long enough.	Press and hold buttons for more than 2 seconds.
No sound can be heard even if the disc is properly loaded.	The compact disc is inverted.	Insert the disc with label side facing up.
	The compact disc is very dirty.	Try to clean the compact disc by instructions of disc cleaning.
	The temperature inside the vehicle is more than 140°F (60°C)	Give the interior a chance to cool down before using the unit.
	Excessive moisture.	Wait for a while before using the unit.
	Wiring connection is not properly done.	Confirm all wiring connection such as power cord, speaker cords, etc.
	Volume control is at "minimum" position.	Adjust the volume control to the proper level.
	Fuse of amplifier is blown out.	Replace the fuse with the correct rating.
Sound distorted due to vibration	Installing method is bad.	Fix the unit securely.
Inverted sound (Left/Right connections).	The speaker cords are inverted.	Check the speaker cords.
No sound from front or rear speakers.	The fader control is set on the wrong position.	Adjust the fader control of the unit correctly.
Sound distorted due to vibration	The compact disc may be defective.	Try to replace the disc with another one.
	The compact disc is dirty.	Try to clean the compact disc by instructions of disc cleaning.
A compact disc is sometimes ejected. (Display shows "E1", an error message.)	The pickup lens is dirty.	Clean the lens. (Use CD lens cleaning disc.)



# Special Notes

## Notes on Compact Discs

ONLY USE DISCS CARRYING LABEL SHOWN ON THE RIGHT



- Dirt, dust, scratches and bending of disc will cause misoperation. Handle discs with care.
- Do not place stickers or make scratches on disc.
- Do not bend discs.
- Disc should always be kept in the case when not in use to prevent from damaging.
- Do not place discs in the following places:
  1. Direct sunlight;
  2. Dirty, dusty and damp areas;
  3. Near vehicle heaters;
  4. Seats and dashboard.

### Disc Cleaning

Use a dry soft cloth to wipe the surface. If the disc is quite dirty use a soft cloth slightly dampened in isopropyl (rubbing) alcohol. Never use solvents such as benzine, thinner, conventional record cleaner, or mopper as they may mar the surface of the disc.

Label

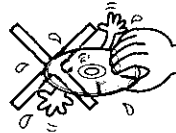

Do not touch the underside of the disc.

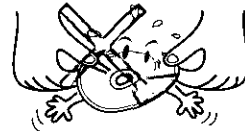

Do not bend.

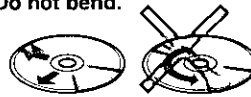

Wipe the disc from center to outside direction.

## Caution for use of a new Disc

A new disc may have rough edges on its inner and outer perimeter. If a disc with rough edges is used, proper setting will not be possible and the CD player will not play the disc. Therefore, remove the rough edges in advance by using a ball-point pen or pencil as shown on right. To remove the rough edges, press the side of the pen or pencil against the inner and outer perimeter of the disc.

Rough edges on outer perimeter

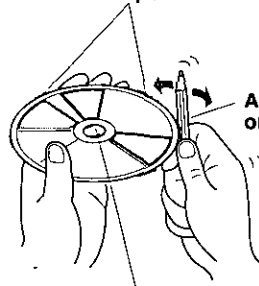

A ball-point pen or pencil

Rough edges on inner perimeter

# Specifications

## GENERAL

Power Supply	: 12 V DC (11 V - 16 V) Test Voltage 14.4 V, Negative ground
Maximum Power Output	: 35 W x 4 channels at 400 Hz, Volume Control maximum
Power Output	: 18W per channel into 4 ohms, 40 to 30,000Hz at 3% THD,
Tone Action	: Bass ; ± 10dB at 100 Hz Treble; ± 10 dB at 10 kHz
Current Consumption	: Less than 2.5 A (CD mode, 0.5 W 4-speaker)
Speaker Impedance	: 4 Ω (4 - 8 Ω acceptable)
Dimensions (W x H x D)	: 7" x 1-15/16" x 5-7/8" (178 x 50 x 150 mm)
Weight	: 3 lbs. 8 oz. (1.6 kg)

## AM RADIO

Frequency Range	: 530 - 1,710 kHz
Useable Sensitivity	: 28 dB/μV (25 μV/ S/N 20 dB)

## FM STEREO RADIO

Frequency Range	: 87.9 - 107.9 MHz
Useable Sensitivity	: 12 dBf. (1.1 μV/ 75 Ω, S/N 30 dB)
50 dB Quieting Sensitivity	: 17 dBf. (2.0 μV/ 75 Ω)
Frequency Response	: 30 - 15,000 Hz ±3 dB
Alternate Channel Selectivity	: 75 dB
Stereo Separation	: 35 dB at 1,000Hz
Signal/Noise Ratio	: 70 dB (Mono)

## WEATHER BAND RADIO

Frequency Range	: 162.40 - 162.55 MHz
Useable Sensitivity	: 3 dB/μV (S/N 20 dB)
Signal/Noise Ratio (40 dB/μV)	: 50 dB

## CD Player

Sampling Frequency	: 32 times oversampling
DA Converter	: MASH•1bit/4 DAC System
Error Correction System	: Panasonic Super Decoding Algorithm
Pick-Up Type	: 1-beam
Light Source	: Semiconductor laser
Wavelength	: 780 nm
Frequency Response	: 20 Hz - 20,000 Hz (±1 dB)
Signal to Noise Ratio	: 98 dB
Total Harmonic Distortion	: 0.01%(1 kHz)
Wow and Flutter	: Below measurable limits
Channel Separation	: 75 dB

\*Above specifications comply with EIA standards.

### Note:

Specifications and design are subject to modification without notice, due to improvements in technology.

# Memorandum

A series of horizontal dashed lines for writing the memorandum content.

**Panasonic Consumer Electronics  
Company, Division of Matsushita  
Electric Corporation of America**  
One Panasonic Way, Secaucus,  
New Jersey 07094

YFM284C274YA TAMCO0198-1 Printed in Taiwan

## Free Manuals Download Website

<http://myh66.com>

<http://usermanuals.us>

<http://www.somanuals.com>

<http://www.4manuals.cc>

<http://www.manual-lib.com>

<http://www.404manual.com>

<http://www.luxmanual.com>

<http://aubethermostatmanual.com>

Golf course search by state

<http://golfingnear.com>

Email search by domain

<http://emailbydomain.com>

Auto manuals search

<http://auto.somanuals.com>

TV manuals search

<http://tv.somanuals.com>