

# Panasonic®

Cassette Receiver with CD Changer Control

## CQ-RX65EU

### Operating Instructions



Please read these instructions completely before operating this unit.



# Contents

Use This Equipment Safely .....Page 2

**Power and Sound Controls**.....4  
How to adjust the volume, Tone Enhancement, Attenuator, balance, and tone for best listening, AUX



**Radio Basics** .....7  
Manual and automatic tuning, band selection, preset stations



**Cassette Tape Player Basics** .....9  
How to load, wind, play, and eject a cassette tape

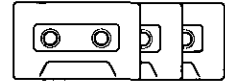

**CD Changer Basics** .....12  
Play, repeat, random and scan  
**Note :**  
CD changer controls are applicable to units with optional CD changer unit (sold separately).



**Clock Basics**.....14  
Setting the time, selecting the clock display

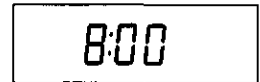

**Installation Guide** .....15  
Step-by-step procedures, anti-theft system, electrical connections

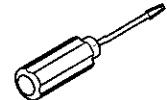

**Troubleshooting** .....25  
Error messages, troubleshooting tips, where to get service help

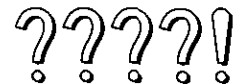

**Specifications** .....27

# Power and Sound Controls

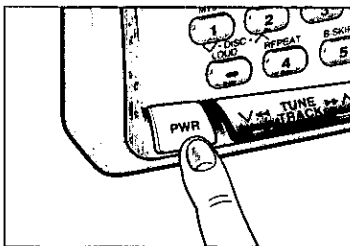
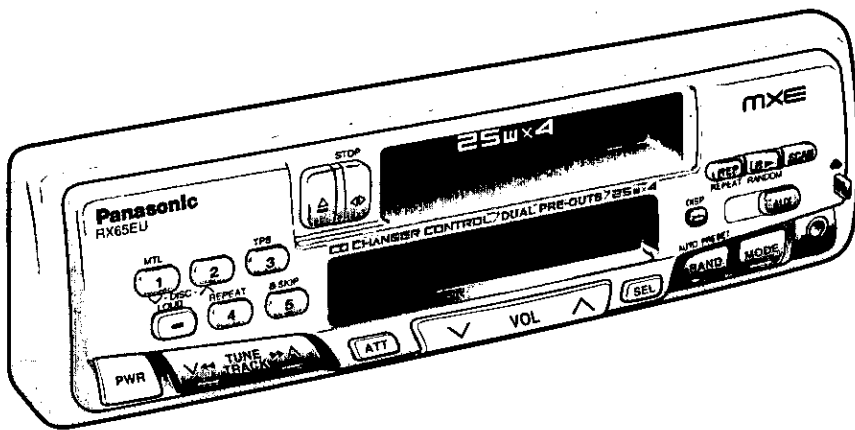

## Power

If the car is not already running, turn the key in the ignition until the accessory indicator lights.

Press PWR to switch on the power.

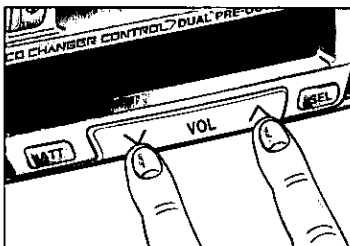

## Volume

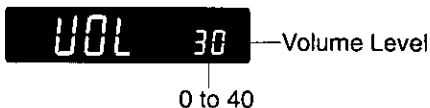

- Press “^” or “v” to increase or decrease volume.

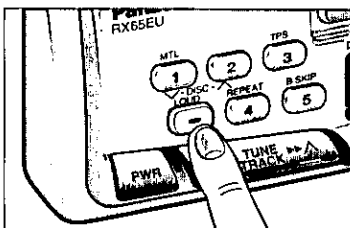

- Press “^” or “v” for more than a half second to change numeric levels on the display rapidly.



## Tone Enhancement

- Press  (LOUD) to enhance bass and treble tones when listening at low or medium volume.
- Press  (LOUD) again to deactivate.

LOUD

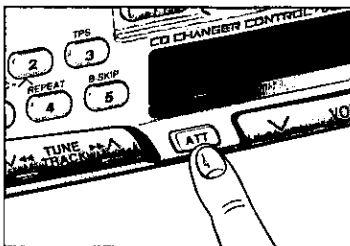

## Attenuator

- Press ATT. Volume will decrease to about 1/10 of its previous level.
- Press ATT again to deactivate when listening at normal volume.

ATT

**Note:** This unit is equipped with an anti-volume-blast circuit which serves as an automatic volume level adjuster so that you will not be deafened with sudden loud volume.

This system operates as follows. When PWR is switched on, the volume level is low. After that, the volume level gradually returns to its previous level prior to switching off the unit.

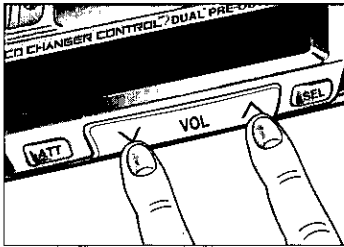
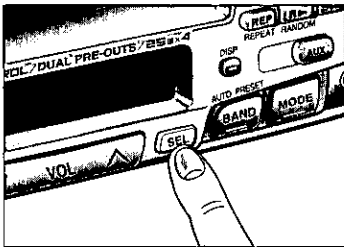
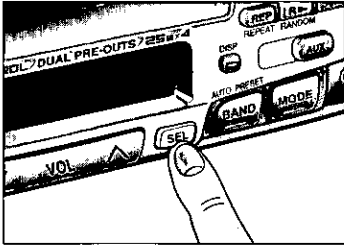

## Changing Audio Modes

Press SEL to switch the audio mode in the following order.



## Bass and Treble

- Press SEL to select the BASS (TREBLE) mode. Press “^” or “v” to increase or decrease the bass/treble response.

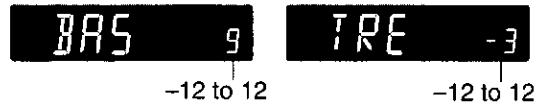

- Press “^” or “v” for more than a half second to change numeric levels on the display rapidly.

## Balance

- Press SEL to select the BALANCE mode. Press “^” or “v” to shift the sound volume to the right or left speakers.



- Press “^” or “v” for more than a half second to change numeric levels on the display rapidly.

## Fader

- Press SEL to select the FADER mode. Press “^” or “v” to shift the sound volume to the front or rear speakers.



- Press “^” or “v” for more than a half second to change numeric levels on the display rapidly.

**Note:** When a control mode (BAS/TRE/BAL/FAd) is selected but no operation is made within 5 seconds (2 seconds at volume mode), the display will return to the normal operation (volume adjustment) mode. In such a case, press SEL again to select the next control mode.

# Power and Sound Controls continued

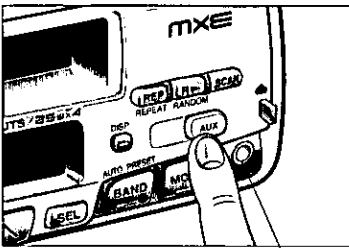
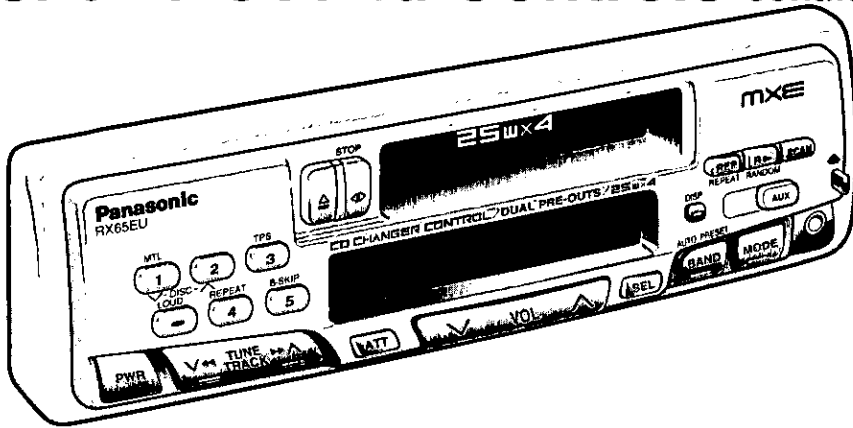

AUX Jack

## Selecting Auxiliary Source

- ① Press AUX to select AUX input mode.



- ② Connect the auxiliary equipment (an optional DCC player deck or any other appropriate equipment) to the AUX Jack.

### Canceling AUX Input mode

Press AUX or MODE again while the AUX mode is operated, the mode will return to the previous mode. Or insert a cassette tape, and the mode will change to TAPE mode.

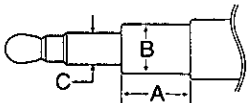

A-MIN 1/2" LONG (12mm)  
B-MAX 2/5" DIA. (10mm)  
C-MIN 1/8" DIA. (3.5mm)

### Caution:

In order to insert the plug into the "AUX" Jack properly, make sure to use the correct size of the stereo plug shown on the left.

# Radio Basics

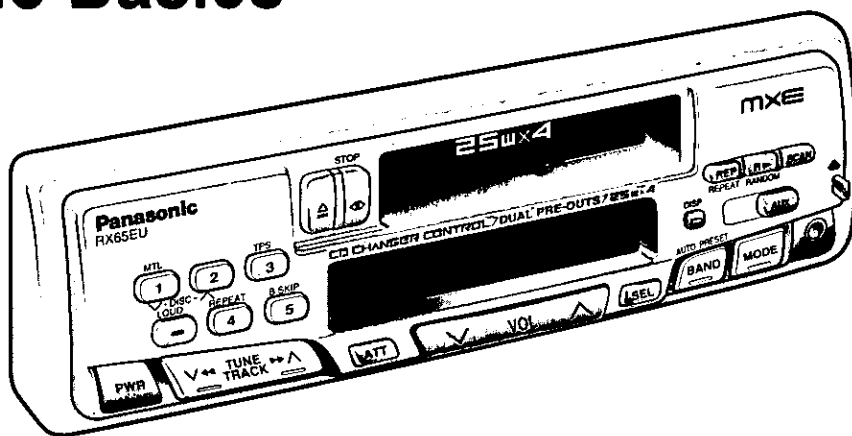

## Change to the tuner mode

Press MODE to switch the operation mode in the following order.

TUNER → TAPE → CD Changer Control (When connecting CD Changer)

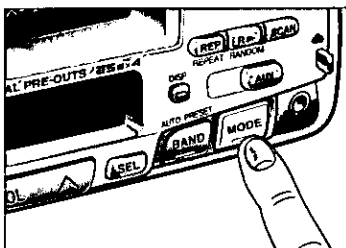

## Selecting a Band

Press BAND to select the bands in the following order.

FM1 → FM2 → FM3 → AM



“ST” indicator lights if the station is broadcasting in stereo.



## Manual Tuning

Press “^TUNE” or “vTUNE” to move to a higher or lower frequency.

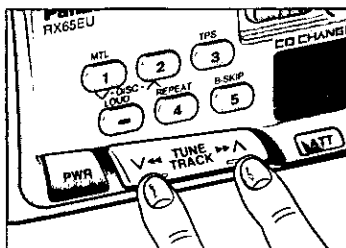

## Seek Tuning

Press and hold “^TUNE” or “vTUNE” for more than a half second, then release. The radio automatically stops on the next station.

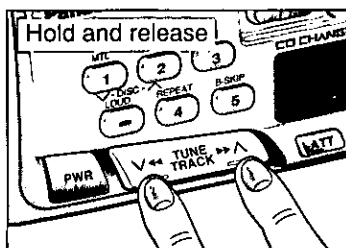

# Radio Basics continued

## Preset Station Setting

Up to 20 stations can be preset in the station memory as follows;

FM1	FM2	FM3	AM
5 stations	5 stations	5 stations	5 stations

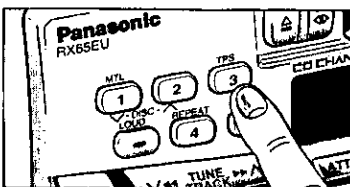
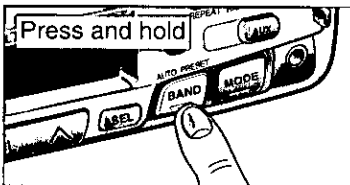
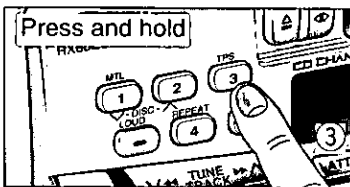
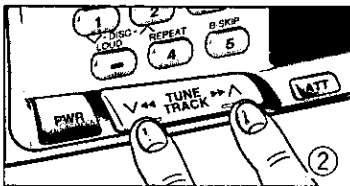
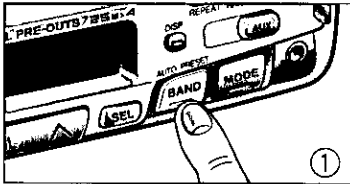

## Manual Station Preset

- ① Press BAND to select a desired band.
- ② Use manual or seek tuning to find a station that you want to program into memory.
- ③ Press and hold one of the station selector buttons 1 through 5 until the display blinks. The memory is now set for that button on the band you have selected.

Repeat the process to set other stations for the FM1 to AM bands.

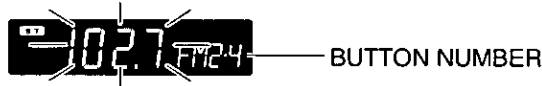

**Note:** You can change the memory setting by repeating the above procedure.

## Auto Station Preset

Select a band and press and hold BAND (AUTO PRESET) for more than 2 seconds.

- The five strongest available stations will be automatically set in memory on preset buttons 1 through 5.
- Once set, the preset stations are sequentially scanned for 5 seconds.
- Press the appropriate preset button for the station you want to hear.

**CAUTION:** For safety reasons, do not attempt to program while driving.



# Cassette Tape Player Basics

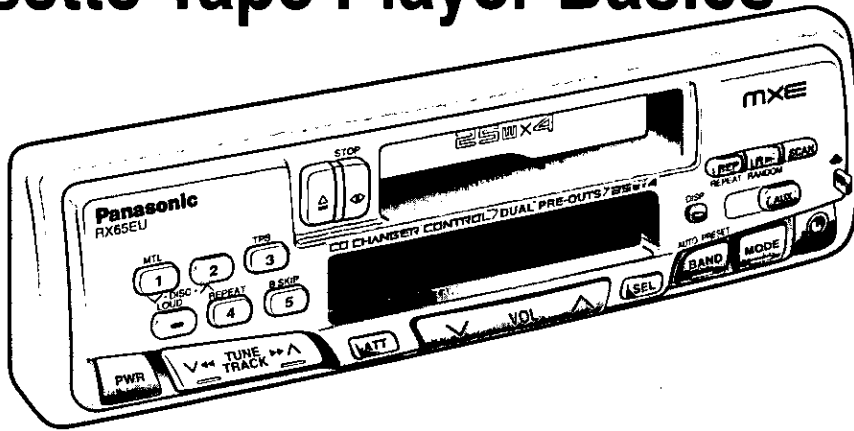

## Loading a Cassette

Insert the cassette with the exposed tape side facing to the right. Gently push the cassette in until the mechanism captures it, the cassette is loaded in place and playback starts.



PROGRAM INDICATOR

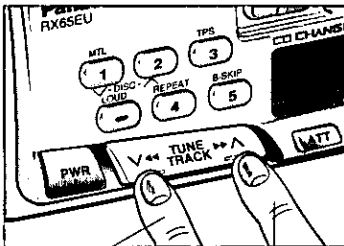

## Rewind and Fast Forward

Press either ◀◀ (REW) to rewind or ▶▶ (FF) to fast forward the tape.



REWIND FAST FORWARD

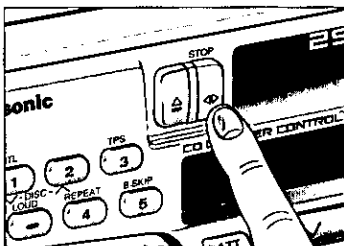

To stop rewind or fast forward, press ◀◀ (STOP).

If you rewind the tape fully, it will play on the same program side again. If you fast forward to the end, play will resume from the beginning of the other side of the tape.

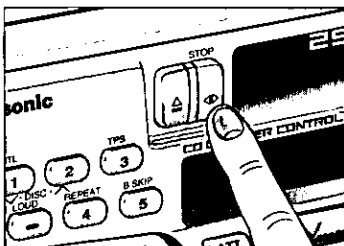

## Changing Sides

Press ◀◀ to switch to the program on the other side of the tape. The display changes to indicate which program is playing.



TOP SIDE PLAYING



BOTTOM SIDE PLAYING

# Cassette Tape Player Basics continued

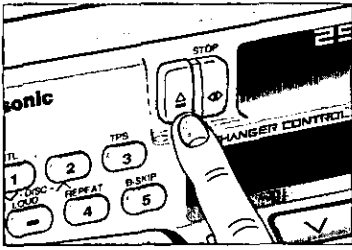

## Ejecting the Tape

Press **▲** and the cassette will eject for removal, and the previous mode of operation will be resumed.

### Notes:

- If power is switched off before **▲** is pressed, the cassette will not eject. Switch on the power again and press **▲** to eject the cassette.
- The cassette tape should always be removed from the cassette slot when not in use.

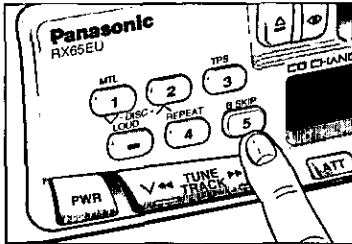

## Blank Skip

Press 5 (B-SKIP) to skip long unrecorded portions on the tape.

B-SKIP

This is most convenient if you quickly want to skip the remaining unrecorded portions at the end of the tape and fast forward to the beginning of the first music on the reverse side of the tape.

### Notes:

- "B-SKIP" indicator lights. However, the blank skip operation will not work if REPEAT is on. The repeat function has priority over that of the blank skip function.
- Also the blank skip operation will not work when the unrecorded portion of the tape is less than 15 seconds.

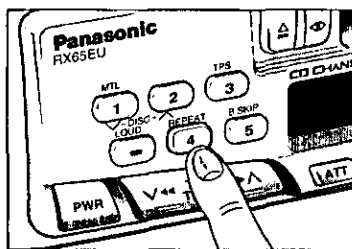

## Repeat Play

Press 4 (REPEAT) to repeat the same music you are now listening to.

REPEAT

After finishing the music just listened to, the rewind starts automatically until the beginning of music, and the same music starts playing again. To turn it off, press 4 (REPEAT) again.

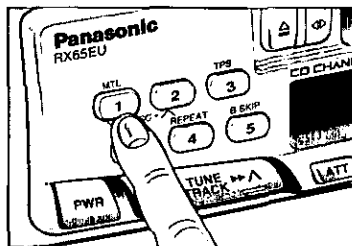

## Metal Tape Mode

Press 1 (MTL) when playing metal or chromium dioxide (CrO<sub>2</sub>) tapes. To turn it off, press MTL again.

MTL

**Note:** Playing non-metal tapes in MTL mode causes high frequency imbalance, which affects tone quality.

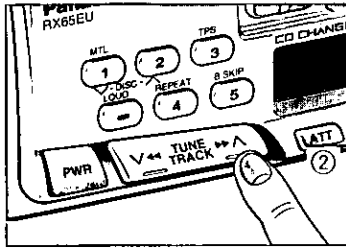
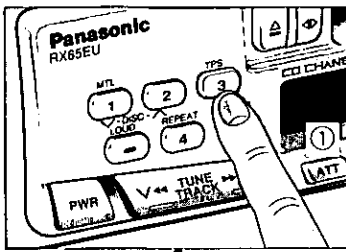

or

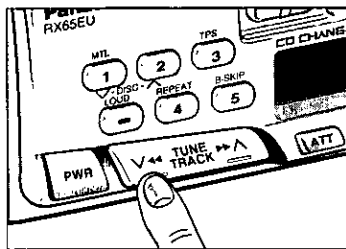

## TPS Operation (Tape Program Search)

① Press 3(TPS) to activate the tape program search mode.



② From the current selection, decide which program you want to select. Now, press "▶▶" several times forward (up to 9 programs) or press "◀◀" several times backward (up to 8 ) to select the corresponding program number.

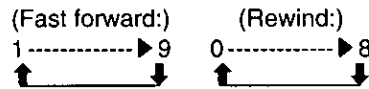

EX1. To select the current program again press 3 (TPS), and press "◀◀" once.



EX2. To select the 1st program backward of the current selection, press 3(TPS) once, and press "◀◀" two times.



EX3. To select the next program, press 3 (TPS) and press "▶▶" once.



EX4. To select the 3rd program forward of the current selection, press 3 (TPS) once, and press "▶▶" three times.



● To turn it off, press 3 (TPS) again.

### Note:

The TPS mode may not work correctly in the following cases. This, however, does not mean that the unit is defective.

- There is an interval less than 4 seconds or having a high level of noise or hum between programs.
- There is particularly low-level passage during the program.

# CD Changer Basics

## Note:

CD changer functions are applicable to units with optional CD changer unit (sold separately.)

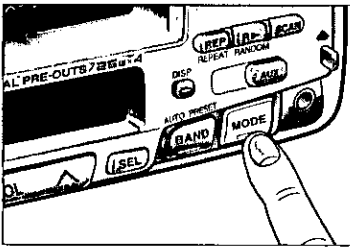
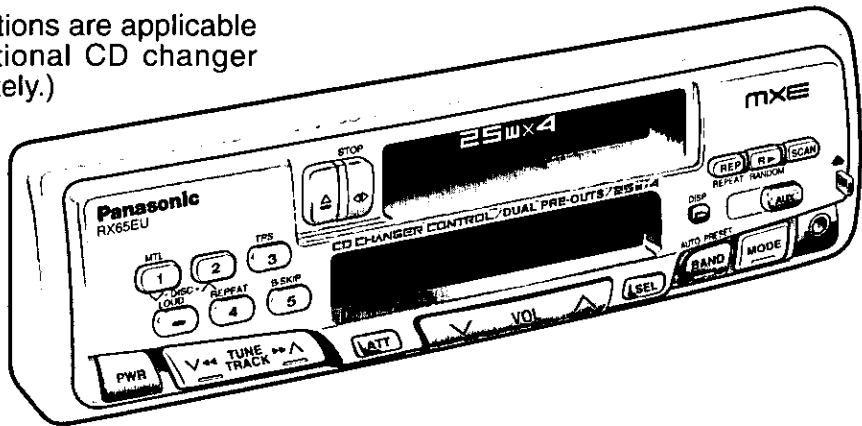

## To changer mode

While a disc magazine inserted in the CD changer, press MODE. Play starts from first track.

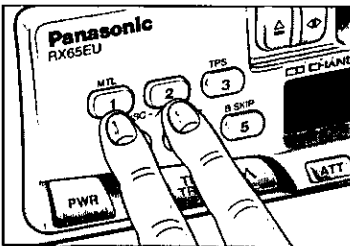

## Selecting a Disc

Press "DISC-^" or "V-DISC" to select discs in ascending or descending order.

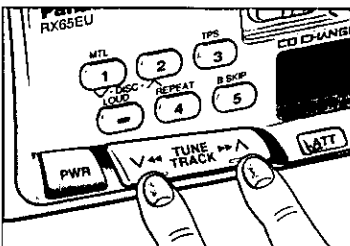

## Selecting a Track

Press "TRACK >>>" once to go to the next track. Press repeatedly to step forward through all the tracks.

Press "<<< TRACK" once to play from the beginning of the current track. Press twice to play the previous track. Press repeatedly to step backward through all the tracks.

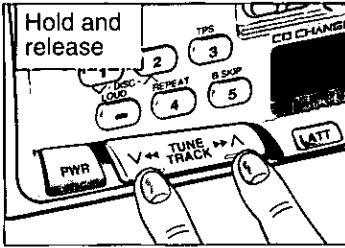

## Searching a Track

Press and hold "TRACK ►►" or "◄◄ TRACK" for more than a half second to activate fast forward or reverse through a track. Release "TRACK ►►" or "◄◄ TRACK" to resume the normal CD play from that position.

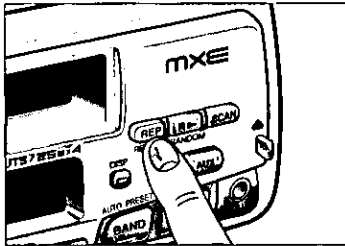

## Repeating a Track

Press REP to repeat the current selection. "REPEAT" indicator lights. The current selection continues to repeat until you press REP again.

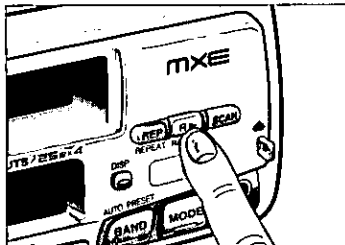

## Random Selection

Press R► to random selection of music is played from all available CDs. "RANDOM" indicator lights. To turn it off, press R► again.

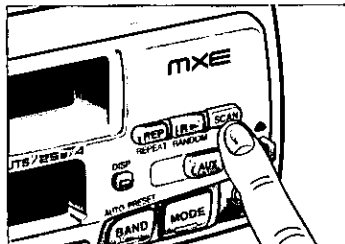

## Scanning Tracks

Press SCAN. The minutes display blinks and the first 10 seconds of each track on the discs play in sequence. To stop scanning and continue with the current track, press SCAN again.

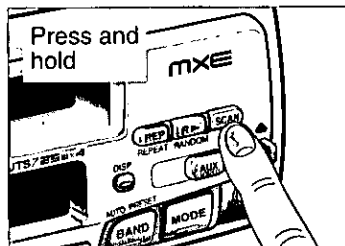

## Scanning Discs

Press and hold SCAN for more than 2 seconds. The 1st track of all the discs in the magazine is played for 10 seconds each. Also, Disc Number blinks at the same time. To stop the current play of the disc scanning, press and hold SCAN for more than 2 seconds again.

# Clock Basics (The clock system is 12-hours.)

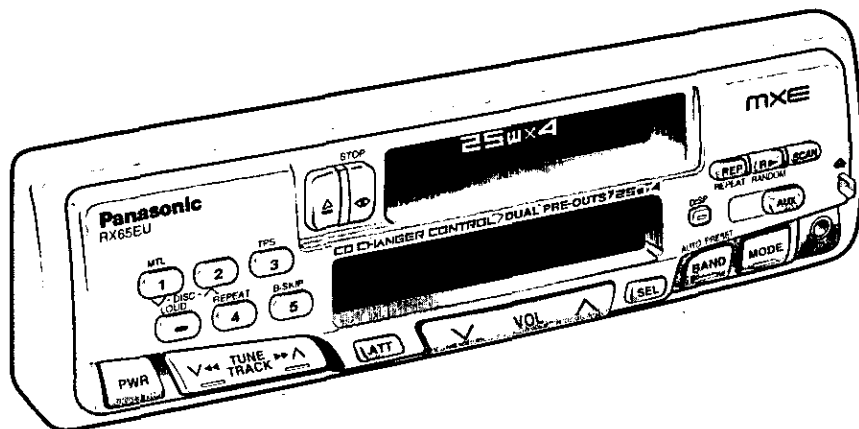

## Initial Time Setting

(A) Press DISP. "Adj" is displayed.



(B) Press and hold DISP again for more than 2 seconds. "12" blinks indicating the time setting mode is activated.



(C) To set hours, press "VTUNE" or "TUNE^".



(D) Press DISP again for minute setting.



(E) To set minutes, press "VTUNE" or "TUNE^".



Hold "^" or "V" to change numbers rapidly.

(F) When you have set the time, press DISP.

## Resetting the Time

When you want to reset the time, press and hold DISP for more than 2 seconds to activate the time setting mode. Then, repeat step (C) to (F) above.

## Selecting the Clock Display

Press DISP for clock display.

Press DISP once again, the current audio display mode resumes.

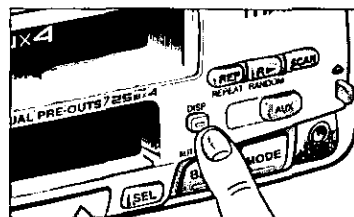
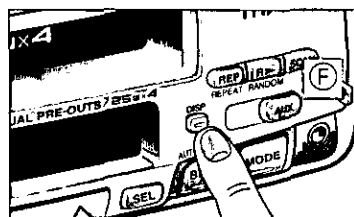
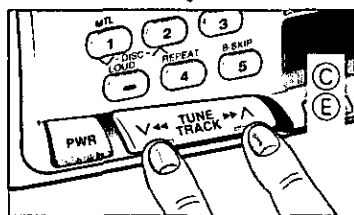
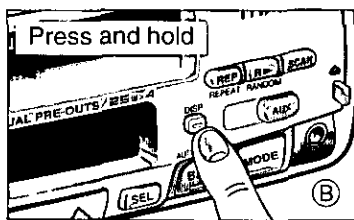
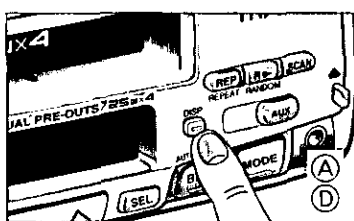

# Installation Guide



## WARNING

This installation information is designed for experienced installers and is not intended for non-technical individuals. It does not contain warnings or cautions of potential dangers in attempting to install this product.

Any attempt to install this product in a motor vehicle by anyone other than qualified installer could cause damage to the electrical system and could result in serious personal injury or death.

### □ Overview

This equipment should be installed by a professional. However, if you plan to install this unit yourself, your first step is to decide where to install it. The instructions in these pages will guide you through the remaining steps: (Please refer to "WARNING" statement above).

- Identify and label the vehicle wires
- Connect the vehicle wires to the wires of the power connector
- Install the unit in the dash
- Check the operation of the unit

If you do encounter problems, please consult your nearest professional installer.

**CAUTION:** This unit will operate with a 12 volt DC negative ground auto battery system only. Do not attempt to use it in any other system. Doing so could cause serious damage.

Before you begin installation, look for the following items included in the packing with your unit.

- **Warranty Card** ..... Fill this out promptly
- **MSC Servicenter Directory** ..... Keep for future reference in case the unit needs servicing
- **Installation Hardware** ..... Needed for in-dash installation

### □ Installation Hardware

No.	Item	Diagram	Qty
①	Mounting Collar		1
②	Plain Washer (5 mmφ)		2
③	Spring Washer (5 mmφ)		2
④	Hex. Nut (5 mmφ)		2
⑤	Rear Support Strap		1
⑥	Hex. Bolt (5 mmφ x 25 mm)		1
⑦	Toothed Lock Washer (5 mmφ)		1
⑧	Mounting Bolt (5 mmφ)		1
⑨	Power Connector		1
⑩	Removable Face Plate Case		1

# Installation Guide continued

## Required Tools

You'll need a screwdriver, a 1.5 volt AA battery, and the following:

12 V DC  
TEST BULB



ELECTRICAL  
TAPE



SIDE-CUT  
PLIERS



Cut the connector wires one at a time from the plug (leaving the leads as long as possible) so that you can work with individual leads.

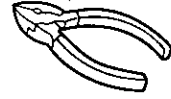

Turn the ignition on to the accessory position, and ground one lead of the test bulb to the chassis.

Touch the other lead of the test bulb to each of the exposed wires from the cut radio connector plug. Touch one wire at a time until you find the outlet that causes the test bulb to light.

Now turn the ignition off and then on. If the bulb also turns off and on, that outlet is the vehicle power lead.

If your vehicle is not wired for an audio unit :  
Go to the fuse block and find the fuse port for radio (RADIO), accessory (ACC), or ignition (IGN).

## Battery Lead

If your stereo unit has a yellow lead, you will need to locate the car's battery lead. Otherwise you may ignore this procedure. (The yellow battery lead provides continuous power to maintain a clock, memory storage, or other function.)

If your vehicle has a radio or is pre-wired for one:  
With the ignition and headlights off, identify the car battery lead by grounding one lead of the test bulb to the chassis and checking the remaining exposed wires from the cut radio connector plug.

If your vehicle is not wired for an audio unit :  
Go to the fuse block and find the fuse port for the battery, usually marked BAT.

## Speakers

Identify the car speaker leads. There will be two leads for each speaker, usually color coded.

## Dashboard Specifications

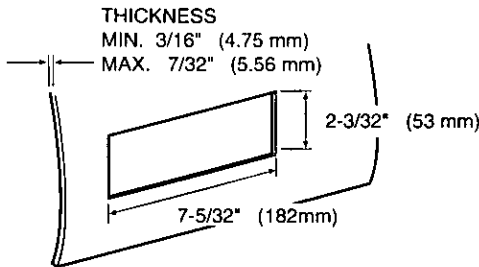

## Identify All Leads

The first step in installation is to identify all the vehicle wires you'll use when hooking up your sound system.

As you identify each wire, we suggest that you label it using masking tape and a permanent marker. This will help avoid confusion when making connections later.

**Note:** Do not connect the power connector to the stereo unit until you have made all connections. If there are no plastic caps on the stereo hooking wires, insulate all exposed leads with electrical tape until you are ready to use them. Identify the leads in the following order.

### Power Lead

If your vehicle has a radio or is pre-wired for one :



A handy way to identify the speaker leads and the speaker they connect with is to test the leads using a 1.5 volt AA battery as follows.

Hold one lead against one pole of the battery and stroke the other lead across the other pole. You will hear a scraping sound in a speaker if you are holding a speaker lead.

If not, keep testing different lead combinations until you have located all the speaker leads. When you label them, include the speaker location for each.

### Antenna Motor

If your vehicle is equipped with an automatic power antenna, identify the vehicle motor antenna lead by connecting one bulb tester lead to the vehicle battery lead and touching the remaining exposed wires from the cut radio connector plug one at a time. You will hear the antenna motor activate when you touch the correct wire.

### Antenna

The antenna lead is a thick, black wire with a metal plug at the end.

### Telephone Mute

If you have a cellular phone, refer to its operator manual to identify the telephone mute lead connection.

---

## Connect All Leads

Now that you have identified all the wires in the vehicle, you're ready to begin connecting them to the stereo unit wires. The connection diagram on Page 24 shows the proper connections and color coding of the leads.

We strongly recommend that you test the unit before making a final installation.

You can set the unit on the floor and make temporary connections to test the unit. Use electrical tape to cover all exposed wires.

---

**IMPORTANT** : Connect the red power lead last, after you have made and insulated all other connections.

---

### Ground

Connect the black ground lead of the power connector to the metal vehicle chassis.

## Speakers

Connect the speaker wires. See the wiring diagram below for the proper hookups. Follow the diagram carefully to avoid damaging the speakers and the stereo unit.

The speaker used must be able to handle more than 25 watts of audio power. If using an optional audio power, the speakers should be able to handle the maximum amplifier output power. Speakers with low input ratings can be damaged.

Speaker impedance should measure 4 - 8 ohms, which is typically marked on most speakers. Lower or higher impedance speakers will affect output and can cause both speaker and stereo unit damage.

---

**CAUTION** : Never ground the speaker cords. For example, do not use a chassis ground system or a three-wire speaker common system. Each speaker must be connected separately using parallel insulated wires. If in doubt about how your car's speakers are wired, please consult with your nearest professional installer.

---

**CORRECT**  
No Common Ground

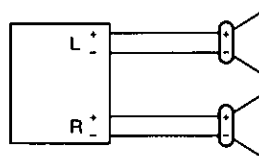

**INCORRECT**  
Common Chassis Ground

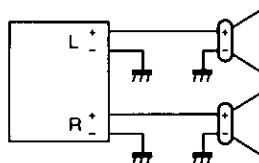

**INCORRECT**  
Speaker Common  
(common earth lead)

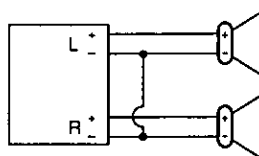

# Installation Guide continued

## Motor Antenna

Connect the vehicle motor antenna lead to the blue motor antenna relay control lead.

## Battery

Connect the yellow battery lead to the correct radio wire or to the battery fuse port on the fuse block.

## Telephone Mute

Connect the orange telephone mute lead as instructed in your cellular phone operator manual.

## Antenna

Connect the antenna by plugging the antenna lead into the antenna receptacle.

## Equipment

Connect any optional equipment such as amplifier, according to the instructions furnished with the equipment. Keep about 12 inches (30 cm) of distance between the speaker cords/amplifier unit and the antenna/antenna extension cord. Read the operating and installation instructions for any equipment you will connect to this unit.

## Power

Connect the red power lead to the correct vehicle radio wire or to the appropriate fuse port on the fuse block.

If the stereo unit functions properly with all these connections made, disconnect the wires and proceed to the final installation.

---

## Final Installation

### Lead Connections

Connect all wires, making sure that each connection is insulated and secure. Bundle all loose wires and fasten them with tape so they won't fall down later. Now insert the stereo unit into the mounting collar.

Congratulations! After making a few final checks, you're ready to enjoy your new auto stereo system.

---

## Final Checks

1. Make sure that all wires are properly connected and insulated.
2. Make sure that the stereo unit is securely held in the mounting collar.
3. Turn on the ignition to check the unit for proper operation.

If you have difficulties, consult your nearest authorized professional installer for assistance.

## ❑ Installation Procedures

### 1. Secure the Mounting Collar ①.

Insert Mounting Collar ① into the car's dashboard, and bend mounting tabs out with a screwdriver.

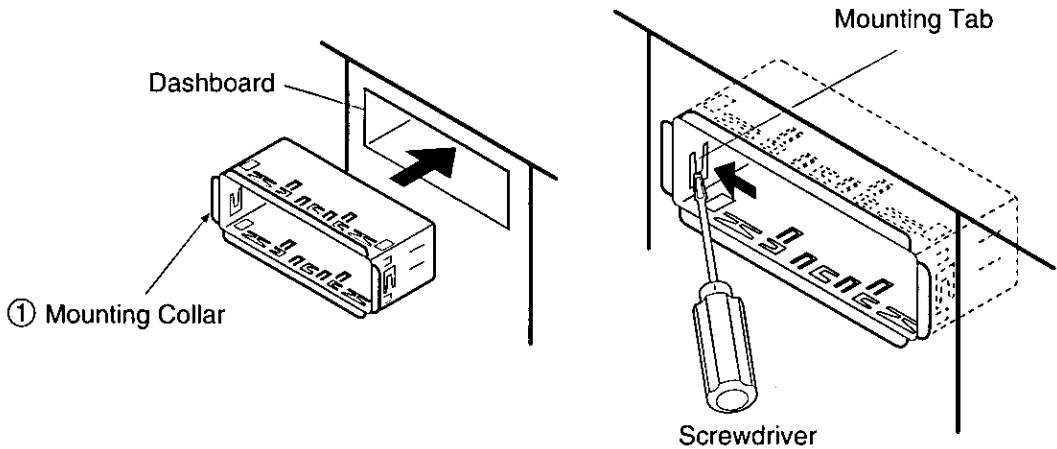

### 2. Secure the rear of the unit.

- Check the electrical connection by referring to this operating instructions.
- Connect the Mounting Bolt ⑧, using a suitable wrench.
- Insert the unit into Mounting Collar ① and push it in until "click" is heard.

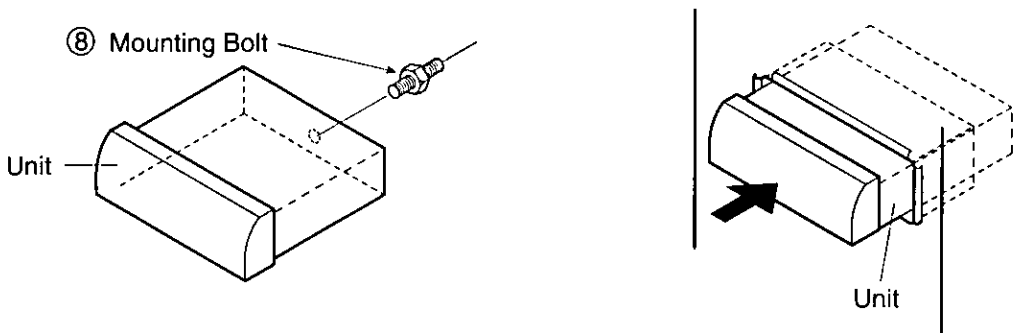

- Secure the rear of the unit to the car by either of the two recommended methods as follows.

# Installation Guide continued

## ■ Using the Rear Support Strap ⑤

Affix one end of the Rear Support Strap ⑤ to the rear of the unit, and the other end to the Fire Wall of Car, or some other metallic area.

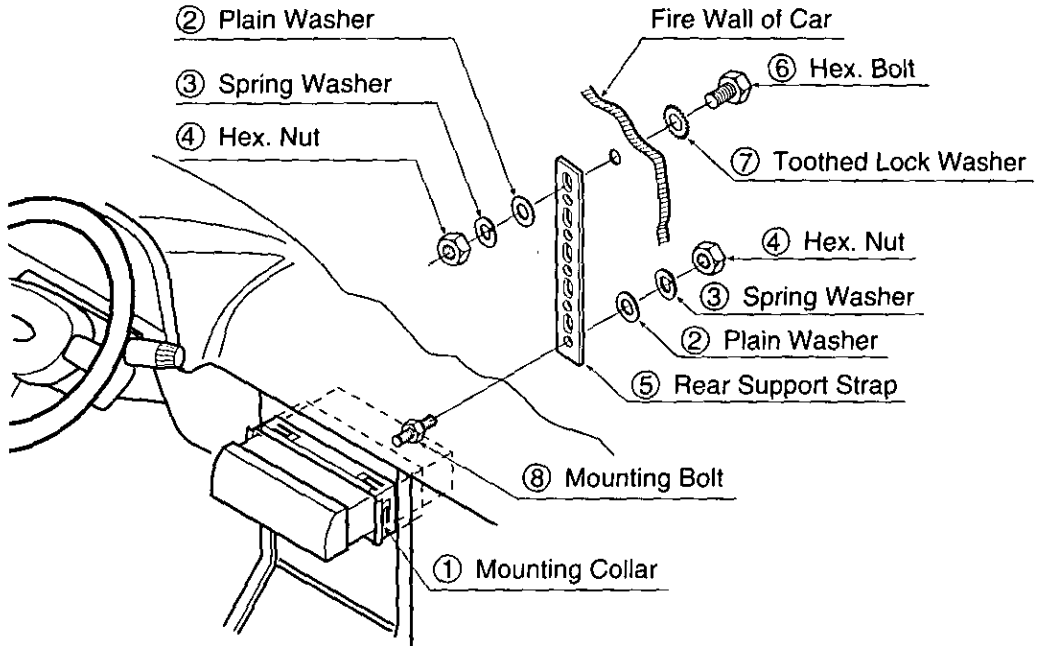

## ■ Using the Rubber Cushion (Optional)

(If there is an existing Rear Support Bracket on the Fire Wall of Car.)

Cover Mounting Bolt ③ on the rear of the unit with Rubber Cushion (Optional), and mount it into the existing Rear Support Bracket.

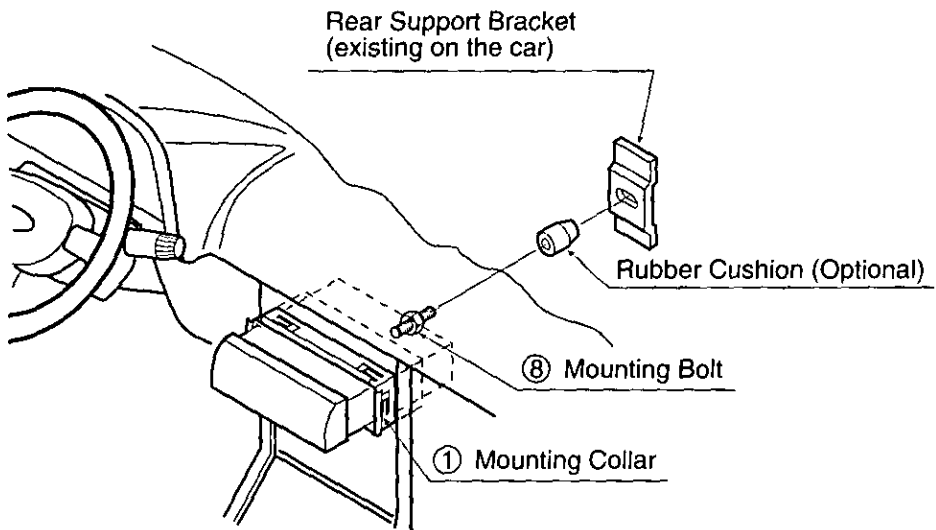

### 3. Plug the Power Connector ⑨.

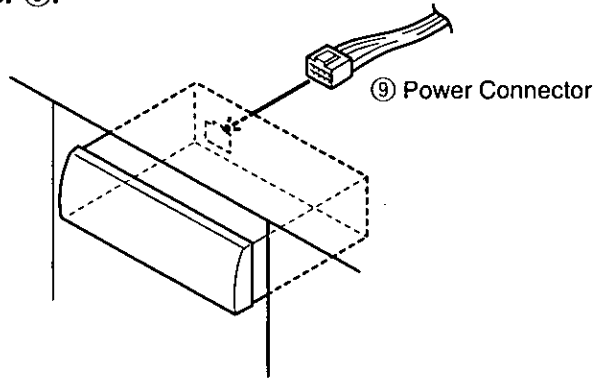

### 4. After installation reconnect the negative (-) battery terminal.

#### To Remove the Unit

- a) Remove the trim plate with a screwdriver as shown in the figure.

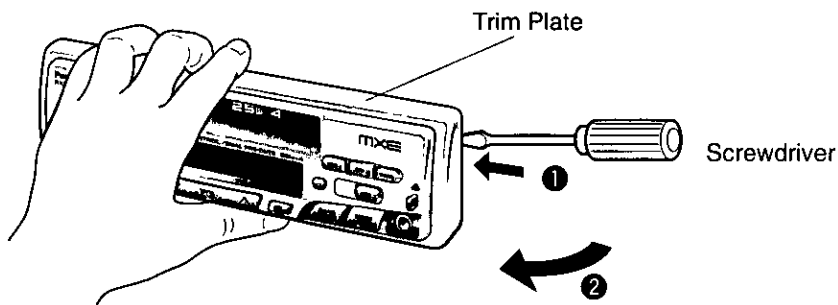

- b) Pull out the unit while pushing the lock lever using a screwdriver.  
c) Remove the unit pulling with both hands.

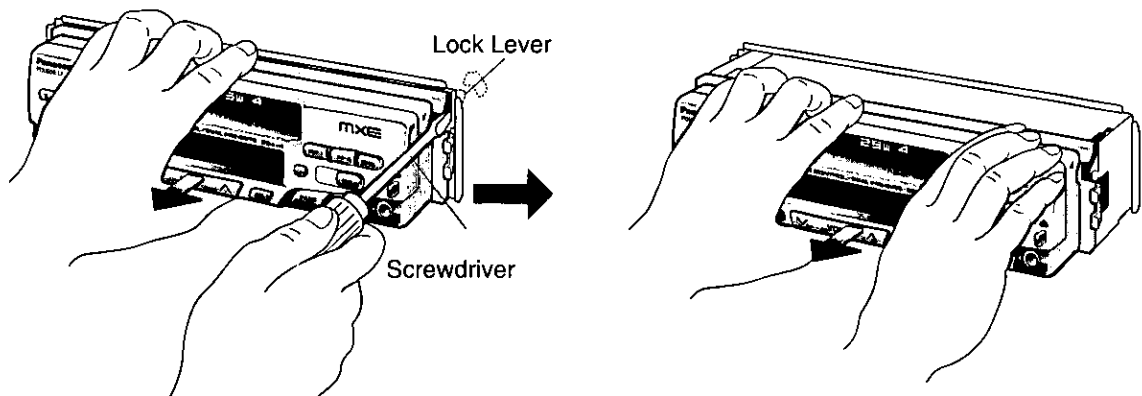

# Installation Guide continued

## Anti-Theft System

This unit is equipped with a removable face plate. By removing this face plate, the radio becomes totally inoperable. The security indicator will blink.

### To Remove the Removable Face Plate

- ① Switch off the power.
- ② Press the release button (  ). The removable face plate will be released.

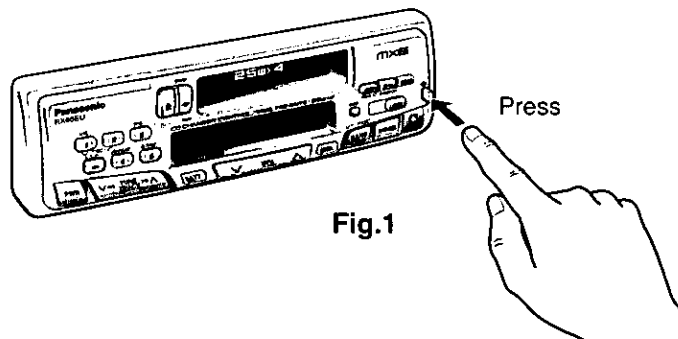

- ③ Remove the removable face plate by pulling on the right side of the unit. Place the removable face plate in a supplied case.

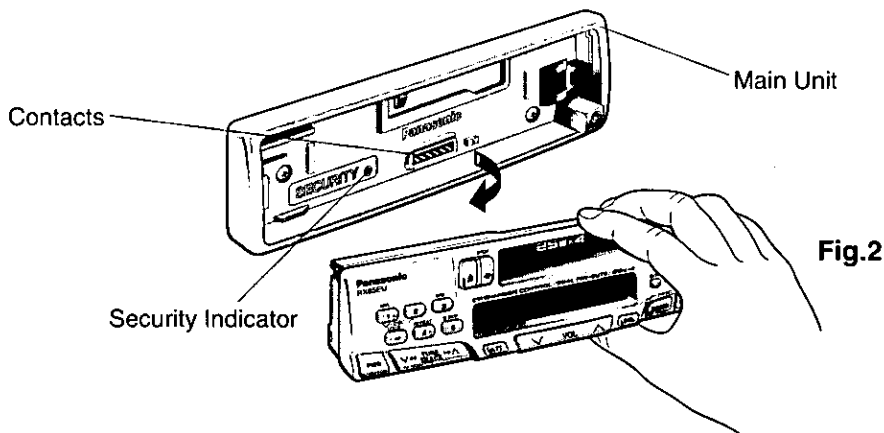

### Switching Security Indicator:

When the removable face plate is removed from the unit, the security indicator will blink. With the car turned on, press and hold SEL for more than 2 seconds repeatedly to change the display (appearing for 2 seconds) as follows, thus switching the security indicator to on/off.

Display	Security Indicator
LED → Disappears → On	Blinks
↕	
LED → Disappears → OFF	Disappears

- ④ As shown in Fig.3, insert the removable face plate with the arrow pointing toward the removable face plate case until you hear a "click". Keep the removable face plate in the case. Then, you can bring the plate safely.

⑩ Removable Face Plate Case

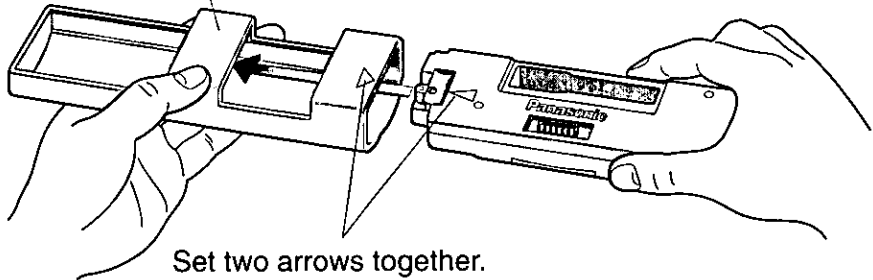

## To install the Removable Face Plate

- ① Slide the left side of the removable face plate in place.

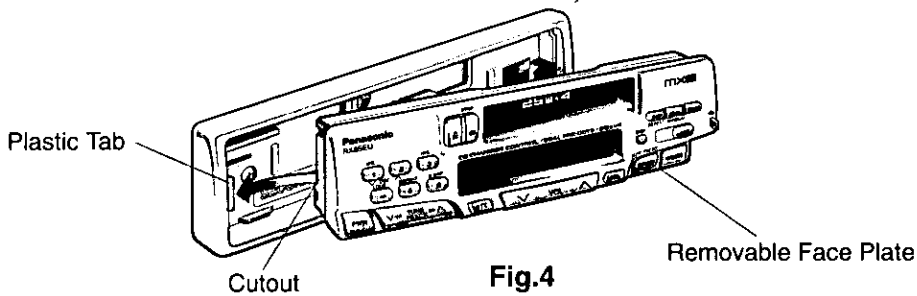

- ② Press the right end of removable face plate until "click" is heard.

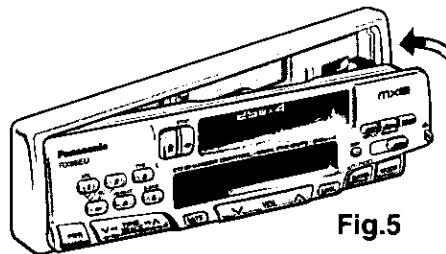

### Caution:

1. Before removing the removable face plate, make sure the power is off.
2. This removable face plate is not water-proof. Do not expose it to water or excessive moisture.
3. Do not remove the removable face plate, while driving your car.
4. Do not place the removable face plate on the dashboard or nearby areas where the temperature rises to high levels.
5. Do not touch the contacts on the removable face plate or on the main unit, since this may result in poor electrical contacts.
6. If dirt or other foreign substances get on the contacts, wipe them with a clean, dry cloth.

# Installation Guide continued

- This unit can be connected to an optional CD changer (CX-DP600EUC). For details consult your nearest Panasonic dealers.
- For connection to a CD changer, refer to the operating instructions of the CD Changer (CX-DP600EUC).

### Caution:

- To prevent damage to the unit, be sure to follow the connection diagram below.
- Remove the covering of the leads about 5 mm long from their end before connecting.
- Do not insert the power connector into the unit until the wiring is completed.
- Be sure to insulate any exposed wires from a possible short-circuit from the car chassis. Bundle all cables and keep cable terminals free from touching any metal parts.

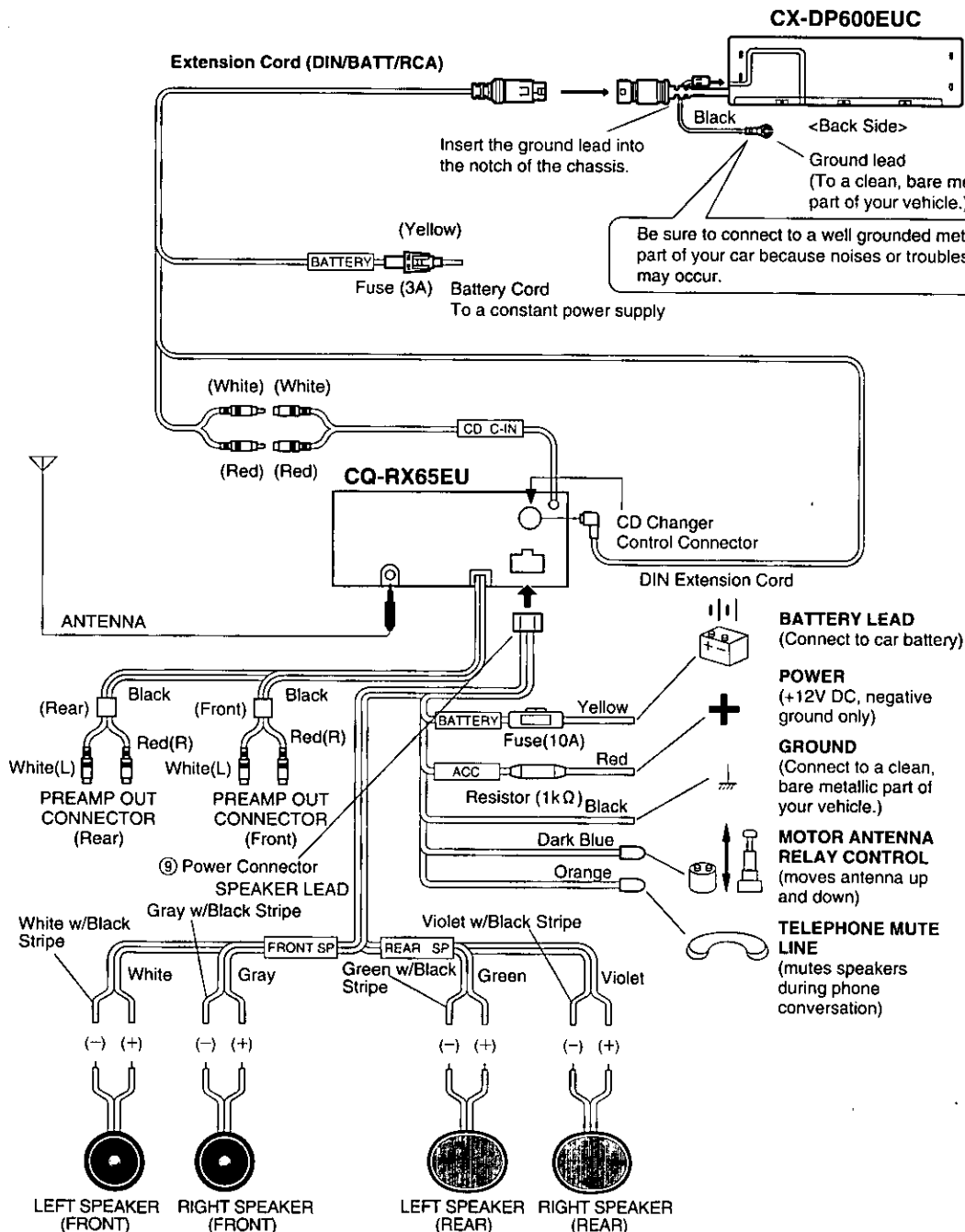



# Troubleshooting

## ❑ Maintenance

Your product is designed and manufactured to ensure a minimum of maintenance. Use a soft cloth for routine exterior cleaning. Never use benzine, thinner, or other solvent.

## ❑ When Something Doesn't Work

Check the charts on page 26 for possible causes and solutions to any problem you might be experiencing. Some simple checks or minor adjustments may eliminate the problem.

## ❑ Product Servicing





If the suggestions in the charts don't solve the problem, we recommend that you take it to your nearest authorized MSC Servicenter. The unit should be serviced only by a qualified technician.

## ❑ Replacing the Fuse

Use fuses of the same specified rating (10 amps). Using different substitutes or fuses with higher ratings, or connecting the unit directly without a fuse, could cause fire or damage to the stereo unit.

If the replacement fuse fails, contact your nearest MSC Servicenter for service.

## ❑ Error Display Messages

	Displays when the compact disc is dirty or upside down. Selects the next available compact disc.
	Displays when compact disc is scratched. Selects next available compact disc.
	Displays when the compact disc stops operating for some reason. Please turn off the car engine (ACC off) and remove the fuse from yellow lead for 1 minute. Then reinstall the fuse.
	Displays when there is no disc in the magazine.

## ❑ Notes on Cassette Tapes

### Tape Slack:

Use a pencil or similar object to take up the slack as shown. If a loose tape is used, this may result in the tape becoming tangled in the rotating parts of the unit.

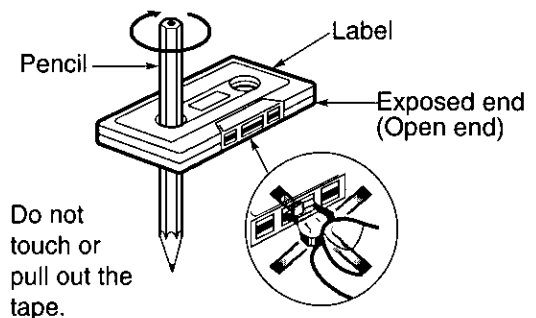

# Troubleshooting continued

## ☐ Troubleshooting Tips

PROBLEM	POSSIBLE CAUSE	PROBABLE SOLUTION
Unit won't turn on.	Dead vehicle battery. Ignition not on.	Charge vehicle battery. Turn ignition to On or Accessory.
	Bad power line connection. Fuse burned out.	Check connections. Replace fuse.
Radio has static.	Antenna not hooked up.	Hook up antenna.
	Close to high power lines.	Move away from high power lines.
Radio memory buttons don't work.	Not holding buttons down long enough.	Press and hold buttons for more than 2 seconds.
Tape sound quality is poor.	Heads are dirty. Poor quality tape.	Clean heads. (Ask a service representative for advice.) Use better quality tape.
Tape won't change programs.	Not pressing ►►(FF) and ◀◀(REW) buttons at the same time.	Press ►►(FF) and ◀◀(REW) buttons at the same time.
CD player won't operate.	Unit not properly connected. Unit not switched into CD mode. No CDs in the magazine.	Check connections. Press MODE button. Check disc magazine.
CD won't play a specific disc.	Disc loaded upside down. Disc damaged. Disc not loaded in magazine.	Reload disc properly. Check disc for scratches, chips. Check disc magazine.

# Specifications

## GENERAL

Power Supply	: 12 V DC (11 V - 16 V) Test Voltage 14.4 V, Negative ground
Maximum Power Output	: 25 W x 4 channels at 400 Hz, Volume Control maximum
Power Output	: 11 W per channel into 4 ohms, 40 to 30,000Hz, at 3% THD
Tone Action	: Bass ; $\pm 12$ dB at 100 Hz Treble; $\pm 12$ dB at 10 kHz
Current Consumption	: Less than 2 A (tape mode, 0.5 W 4-speaker)
Speaker Impedance	: 4 $\Omega$ (4 - 8 $\Omega$ acceptable)
Dimensions (W x H x D)	: 7" x 1-15/16" x 5-7/8" (178 x 50 x 150 mm)
Weight	: 3 lbs. 8 oz. (1.6 kg)

## AM RADIO

Frequency Range	: 530 - 1,710 kHz
Useable Sensitivity	: 28 dB/ $\mu$ V (25 $\mu$ V/ S/N 20 dB)

## FM STEREO RADIO

Frequency Range	: 87.9 - 107.9 MHz
Useable Sensitivity	: 13.2 dBf. (1.25 $\mu$ V/ 75 $\Omega$ )
50 dB Quieting Sensitivity	: 15.2 dBf. (1.6 $\mu$ V/ 75 $\Omega$ )
Frequency Response	: 30 - 15,000 Hz $\pm 3$ dB
Capture Ratio	: 1.5 dB
Alternate Channel Selectivity	: 75 dB
Stereo Separation	: 35 dB at 1,000Hz
Image Response Ratio	: 65 dB
IF Response Ratio	: 100 dB
Signal/Noise Ratio	: 70 dB

## TAPE PLAYER

Reproduction System	: 4-track, 2-program stereo
Tape Speed	: 1-7/8"/sec (4.76 cm/sec)
FF/REW Time	: Less than 110 sec (C-60)
Frequency Response	: 35 - 14,000 Hz $\pm 3$ dB (normal) 35 - 17,000 Hz $\pm 3$ dB (metal)
Wow and Flutter	: 0.12 % (WRMS)
Signal/Noise Ratio	: 52 dB

\*Above specifications comply with EIA standards.

### Note:

Specifications and design are subject to modification without notice due to improvements in technology.

**Matsushita Consumer Electronics  
Company, Division of Matsushita  
Electric Corporation of America**  
One Panasonic Way, Secaucus,  
New Jersey 07094

**Panasonic Sales Company.  
Division of Matsushita Electric of  
Puerto Rico, Inc. ("PSC")**  
Ave. 65 de Infanteria, Km. 9.5  
San Gabriel Industrial Park, Carolina,  
Puerto Rico 00985

## Free Manuals Download Website

<http://myh66.com>

<http://usermanuals.us>

<http://www.somanuals.com>

<http://www.4manuals.cc>

<http://www.manual-lib.com>

<http://www.404manual.com>

<http://www.luxmanual.com>

<http://aubethermostatmanual.com>

Golf course search by state

<http://golfingnear.com>

Email search by domain

<http://emailbydomain.com>

Auto manuals search

<http://auto.somanuals.com>

TV manuals search

<http://tv.somanuals.com>