

# Operating Instructions

6.5 COLOR LCD MONITOR/RECEIVER WITH CHANGER CONTROL

## CQ-VA70EU

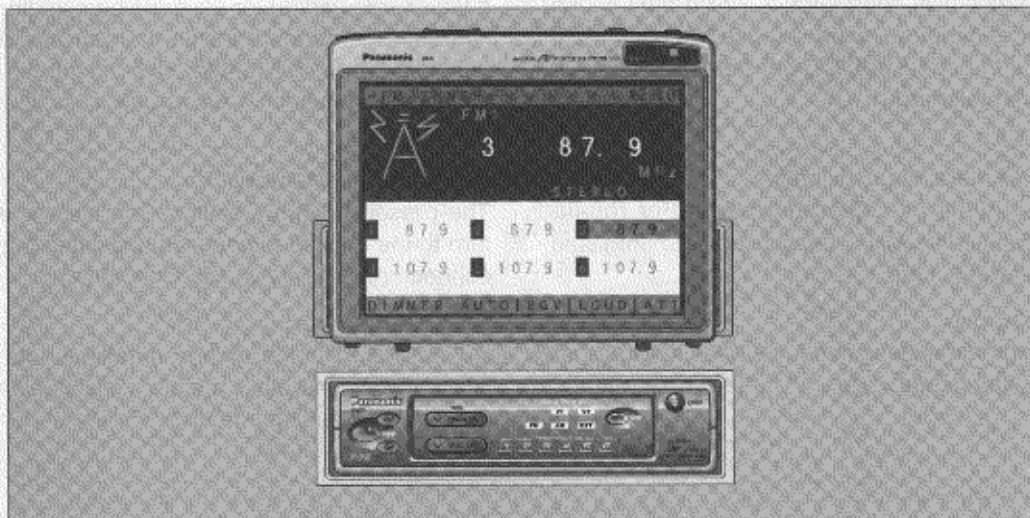

# Panasonic®

Before operating this set, please read these instructions completely.

# Contents

	Page	Page	
Precautions .....	2	Useful Features .....	27
Basic Operation (Precautions) .....	3	Setting for System Upgrading .....	29
Basic Operation (Display).....	5	Batteries for Remote Control.....	31
VTR1/VTR2 Operation (Display) .....	13	Maintenance and Care .....	31
Tuner (Radio) Display .....	14	Installation Guide.....	32
Radio Basics .....	15	Electrical Connection.....	36
CD Changer Control Display .....	18	In Case of Irregular Operation .....	42
CD Changer Control Operation .....	19	Maintenance.....	42
Clock Basics (Display).....	25	Specifications .....	43
Clock Basics (12-hour clock) .....	26		

**Panasonic** welcomes you to their constantly growing family of electronic products owners. We endeavor to give you the advantages of precise electronic and mechanical engineering, manufacturing with carefully selected components, and assembly by people who are proud of the reputation their work has produced for our company. We know this product will bring you many hours of enjoyment, and after you discover the quality, value, and reliability we have built into it, you too will be proud to be a member of our family.

## Precautions

### Car Washing

To avoid electrical short circuits which may cause fire or other damage, do not expose this equipment (including the speakers, CDs or tapes) to water or excessive moisture.

### Service

This unit is made of precision parts. Do not attempt to disassemble or adjust any parts. For repair, please consult the MITO service department listed in the Warranty card.

### Power Supply

This equipment is designed to be used in a car that has a 12-volt negative ground battery system.

### Car Ventilation

If your car is parked for several hours in direct sunlight, the temperature inside the car may become very high. It is advisable to drive the car for a while until the interior cools down before switching the unit on.

### About Preset Memory

The present memory settings are cleared and return to the original factory settings when the power connector or battery is disconnected.

### Disc Mechanism

Do not insert coins or any small objects. Keep screwdrivers and other metallic objects away from the disc mechanism and disc.

# Basic Operation (Precautions)

## How to open and close the display

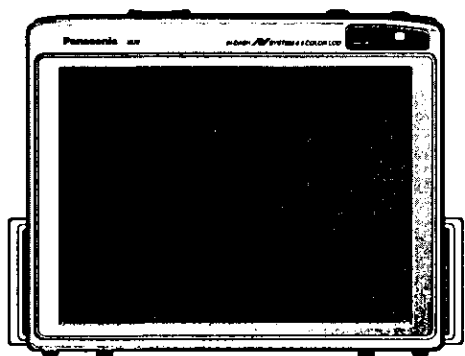

Display position	Pressing OPEN button
Fully closed	Moves display to fully open position.
Fully open	Moves display to fully closed position.

- ① When turning the ACC of the car off, the display is drawn in automatically in about 2 seconds, provided it faces downward.
- ② To draw in the display when it does not face downward, place it in downward position and press the display release button.

### ■ Drawing out the display

[1] Press OPEN button.

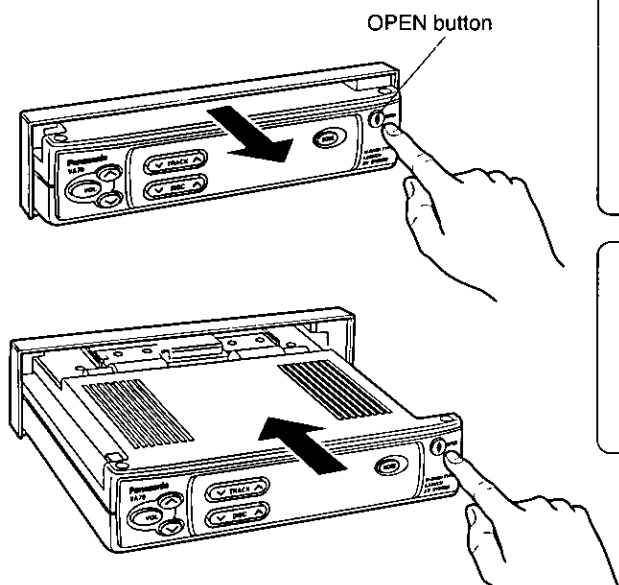

**CAUTION:**

Do not try to change the angle of the display when it is not fully drawn out as this will damage the unit. If the display is drawn out only half-way, retract it first by pressing OPEN button, and then press OPEN button again to draw it out completely.

**Note:**

If you press OPEN button with the display in drawn-out position, the display will be drawn in. If no operation takes place within approx. 10 seconds, the display will be automatically drawn in.

### ■ Angle adjustment

Adjustment range  
135°

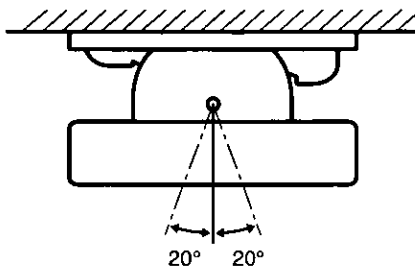
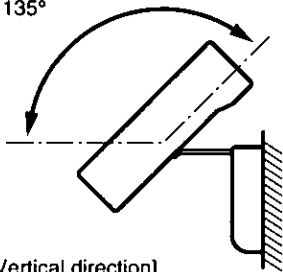

Adjustment range  
[Horizontal direction]

# Basic Operation (Precautions) (Continued)

## [2] Turning the display upward

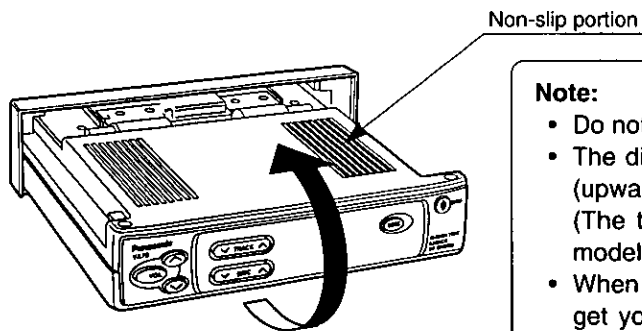

**Note:**

- Do not turn the display forcibly.
- The display can be turned 135° in vertical direction (upward and downward) and 20° to the right and left. (The turning angles may be smaller for some car models.)
- When adjusting the display angle, be careful not to get your hands or fingers caught between the display and the panel cutout.
- The display cannot be moved forward or backward in the upright position. Never push or pull it forcibly.

## [3] Adjusting the viewing angle

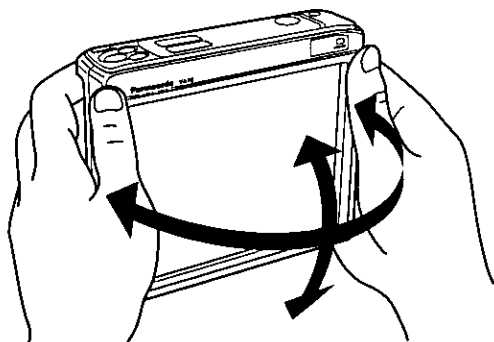

- **Adjusting the right-left angles (manual)**

Angle adjustment should be done slowly, without applying unreasonable force.

- **Before drawing in the display**

Make sure to return the display to center position before drawing it in. It cannot be drawn in with its angles adjusted.

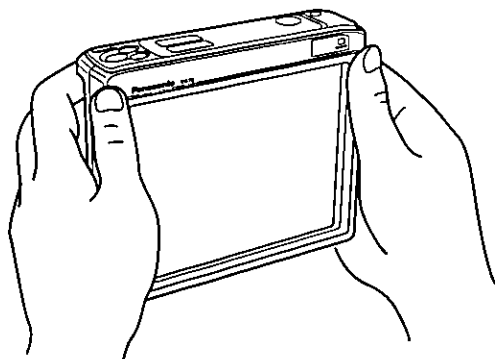

**Note:**

To move the display, always hold it by the upper half (non-slip portion provided on the rear). If you hold the lower portion, you could get your fingers caught between the display unit and the mechanical parts at the rear.

# Basic Operation (Display)

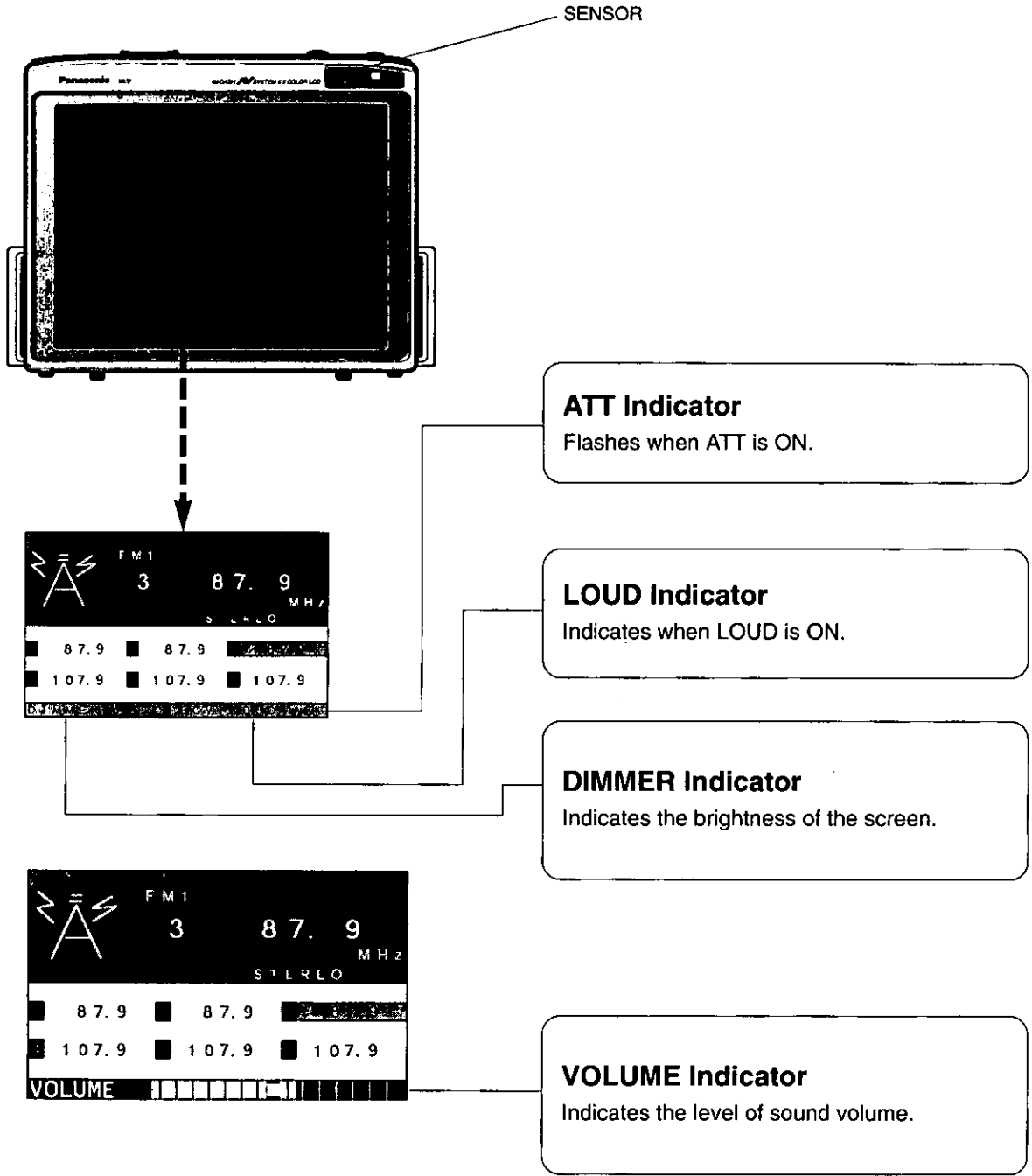

# Basic Operation (Display) (Continued)

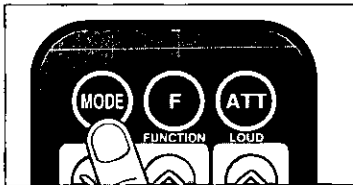
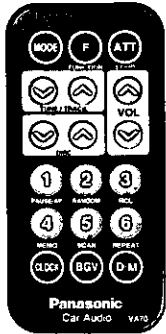

(The corresponding button on the display unit may also be used for this operation.)

## Power

- ① Turn the key in the ignition until the accessory indicator lights.
- ② • Press MODE to switch on the power.  
• Press MODE to select the operation mode as follows.

OFF → AM/FM → VTR1 → VTR2

↑ CH · C ←

(When a CD changer is connected.)

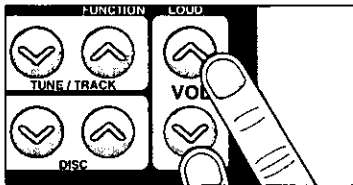

(The corresponding button on the display unit may also be used for this operation.)

## Volume

Press ^VOL^ to increase or decrease volume.

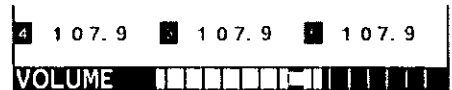

**Note:**

The volume of this set can be adjusted individually for each mode the VTR, tuner and CD changer.

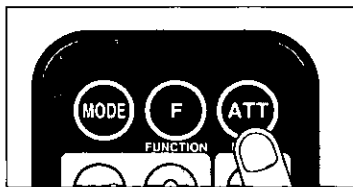

## Attenuator

- Press ATT to decrease volume to about 1/10 of the previous level.
- Press ATT again to cancel.

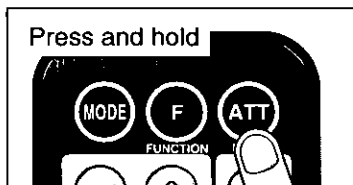

## Tone Enhancement

- Press and hold ATT (LOUD) for more than 2 seconds to enhance bass and treble tones when listening at low or medium volumes.
- Press and hold ATT (LOUD) for more than 2 seconds to cancel.

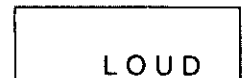

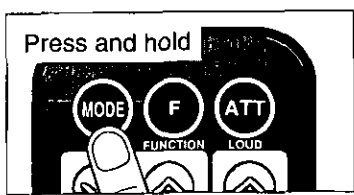

# Menu Control

Press and hold MODE for more than 2 seconds to switch the MENU CONTROL mode. Press  $\nabla$ TUNE/TRACK $\wedge$  to select the operation mode as follows.

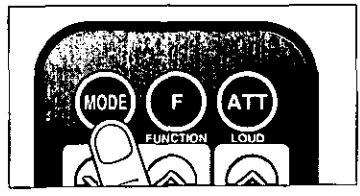
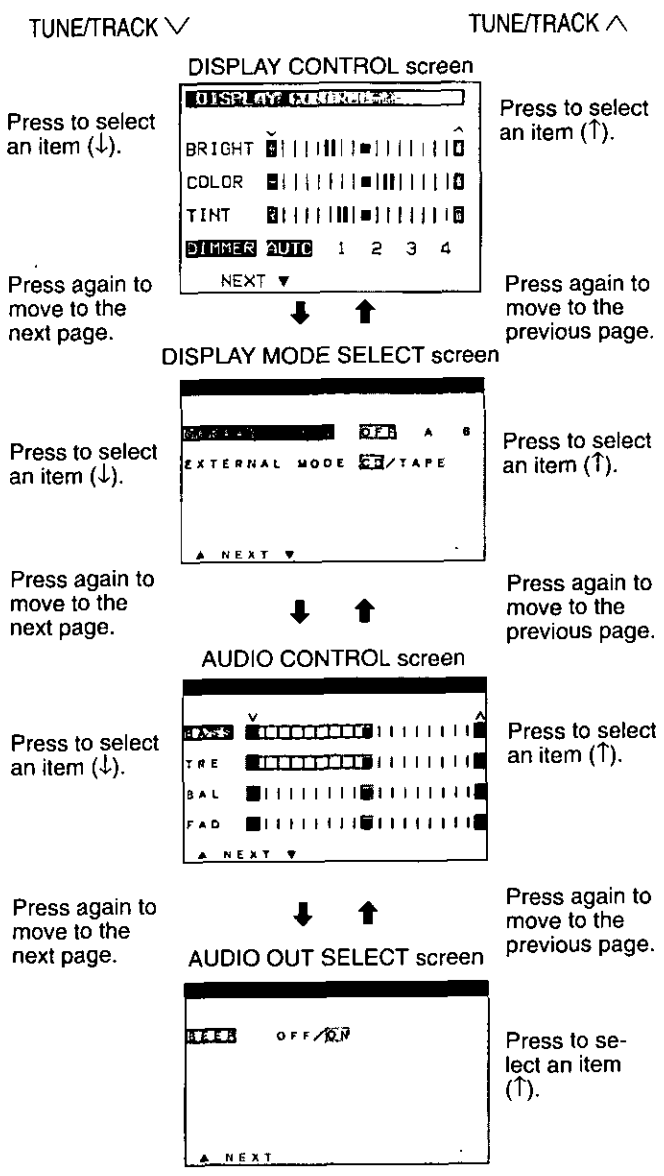

## End

Press MODE again to return to normal mode.

# Basic Operation (Display) (Continued)

## <Display Unit Control>

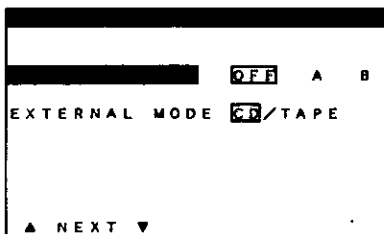
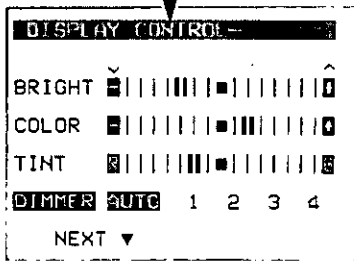
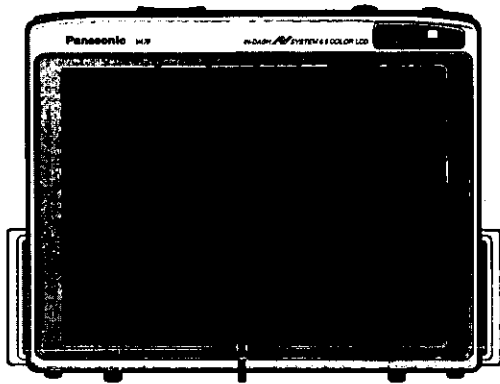

**BRIGHT CONTROL indicator**  
Lit when BRIGHT CONTROL is selected.

**COLOR CONTROL indicator**  
Lit when COLOR CONTROL is selected.

**TINT CONTROL indicator**  
Lit when TINT CONTROL is selected.

**DIMMER CONTROL indicator**  
Lit when DIMMER CONTROL is selected.

**SCREEN SAVER Indicator**  
Lit when Screen Saver is selected.

**EXTERNAL MODE Indicator**  
Lit when External Mode is selected.



## DISPLAY CONTROL

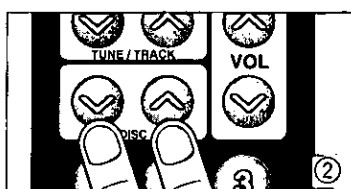
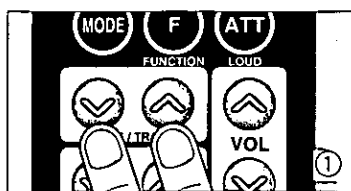

### BRIGHT (brightness) control

- ① Press  $\nabla$ TUNE/TRACK $\wedge$  on the DISPLAY CONTROL screen to select BRIGHT.
- ② Press  $\nabla$ DISC $\wedge$  to decrease or increase the screen brightness.

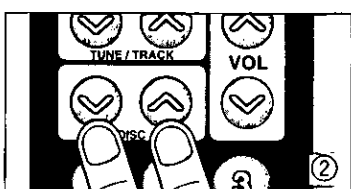
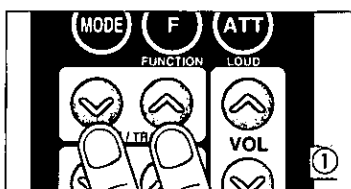

### COLOR (depth of color) control

- ① Press  $\nabla$ TUNE/TRACK $\wedge$  on the DISPLAY CONTROL screen to select COLOR.
- ② Press  $\nabla$ DISC $\wedge$  to darken or lighten the color of the color image.

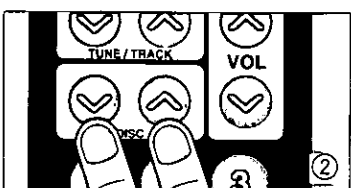
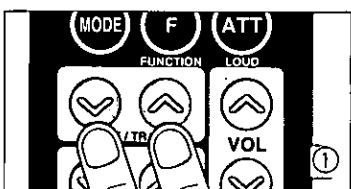

### TINT (tone of color) control

- ① Press  $\nabla$ TUNE/TRACK $\wedge$  on the DISPLAY CONTROL screen to select TINT.
- ② Press  $\nabla$ DISC $\wedge$  to emphasize red or green in the color image.



# Basic Operation (Display) (Continued)

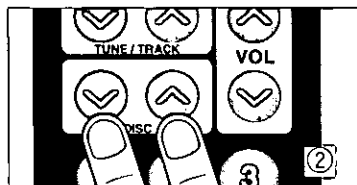
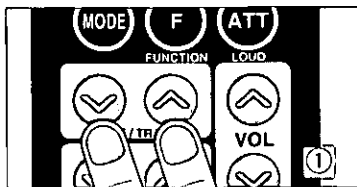

## Dimmer adjustment

- ① Press  $\nabla$ TUNE/TRACK $\wedge$  on the DISPLAY CONTROL screen to select DIMMER.
- ② Press  $\nabla$ DISC $\wedge$  to adjust the brightness level of the screen as follows:

AUTO  $\rightleftarrows$  1  $\rightleftarrows$  2  $\rightleftarrows$  3  $\rightleftarrows$  4

## DISPLAY MODE SELECT

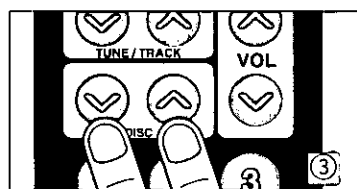
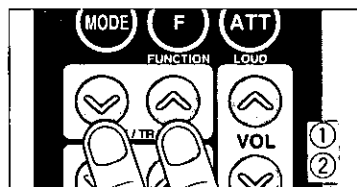

## Screen Saver

- ① Press  $\nabla$ TUNE/TRACK $\wedge$  to switch to DISPLAY MODE SELECT screen.
- ② Press  $\nabla$ TUNE/TRACK $\wedge$  again to select SCREEN SAVER.
- ③ Press  $\nabla$ DISC $\wedge$  to switch SCREEN SAVER as follows:

OFF  $\rightleftarrows$  A  $\rightleftarrows$  B

\* Screens A and B are different in patterns.

### SCREEN SAVER ON

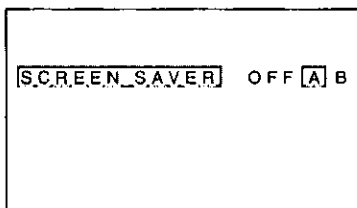

### SCREEN SAVER OFF

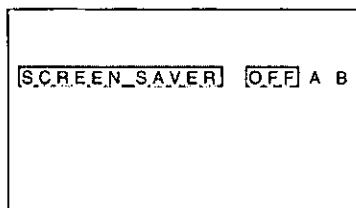

### <Operation during SCREEN SAVER Display>

Before using the function assigned to each button in each mode during SCREEN SAVER display, press each button again to return to the base mode.

The individual buttons will not function without performing the above operation.

# AUDIO CONTROL

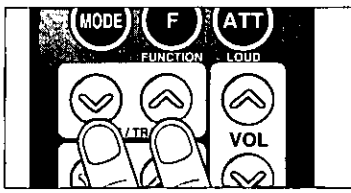

## Audio Mode Selection

Press  $\nabla$ TUNE/TRACK $\wedge$  to switch to AUDIO CONTROL screen.

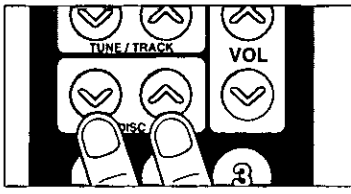

## Bass

- ① Select BASS on the AUDIO CONTROL screen. (See page 7.)
- ② Press  $\nabla$ DISC $\wedge$  to decrease or increase the bass responds.

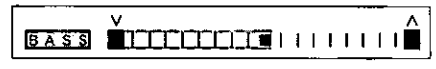

## Treble

- ① Select TRE on the AUDIO CONTROL screen. (See page 7.)
- ② Press  $\nabla$ DISC $\wedge$  to decrease or increase the treble responds.

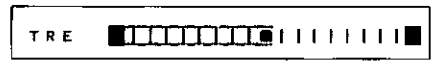

## Balance

- ① Select BAL on the AUDIO CONTROL screen. (See page 7.)
- ② Press  $\nabla$ DISC $\wedge$  to shift the sound volume to the right or left speakers.



## Fader

- ① Select FAD on the AUDIO CONTROL screen. (See page 7.)
- ② Press  $\nabla$ DISC $\wedge$  to shift the sound volume to front or rear speakers.



# Basic Operation (Display) (Continued)

## AUDIO OUT SELECT

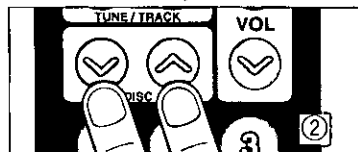
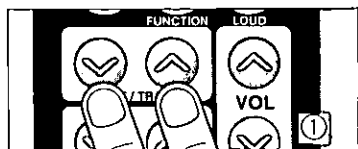

### BEEP setting

- ① PRESS  $\nabla$ TUNE/TRACK $\wedge$  to switch to AUDIO OUT SELECT screen.
- ② Press  $\nabla$ DISC $\wedge$  to select ON or OFF as desired.

#### BEEP ON

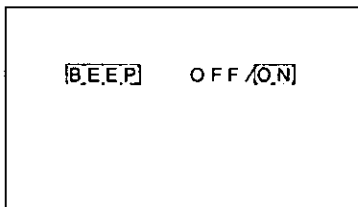

#### BEEP OFF

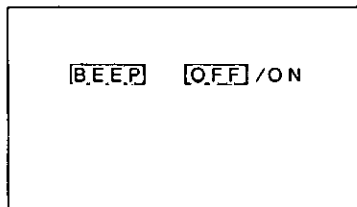

# VTR1/VTR2 Operation (Display)

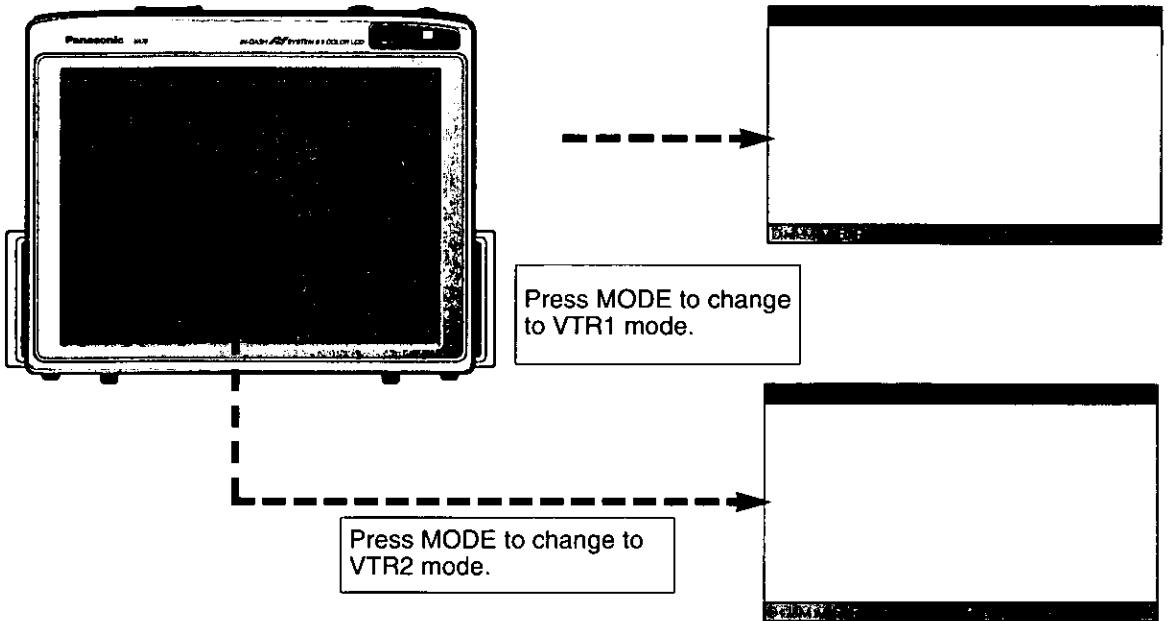

## VTR1/VTR2 Operation

For safe driving, VTR operation is available only in stopped condition with the side-brake pulled. "WARNING" will be displayed, if you try to switch to VTR mode by pressing MODE button while driving.

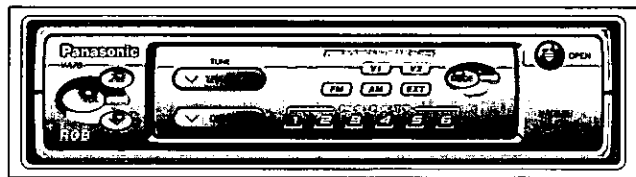

### To watch video programs

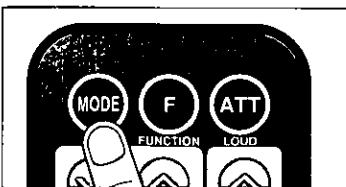

(The corresponding button on the display unit may also be used for this operation.)

### Switching to Video

Press MODE to select VTR mode.

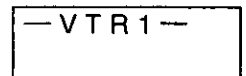

# Tuner (Radio) Display

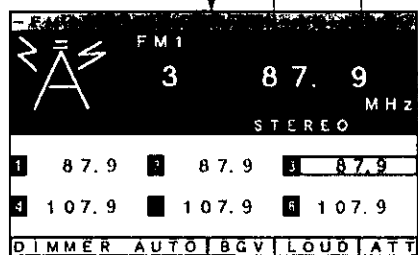
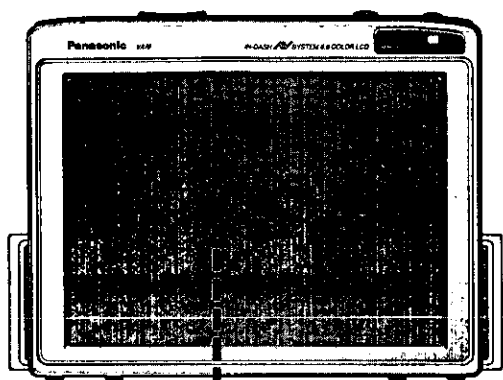

## FM1/FM2/AM1/AM2 (Band Indicator)

Indicates the band being received.

## Channel Indicator

Indicates the preset channel number.

## Frequency Indicator

Indicates the frequency on which the tuner is operating.

## FM STEREO Indicator

Indicates that a FM stereo broadcast is being received.

## Preset List Display

Shows the current channels preset.

# Radio Basics

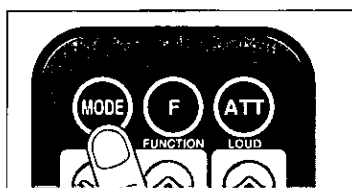
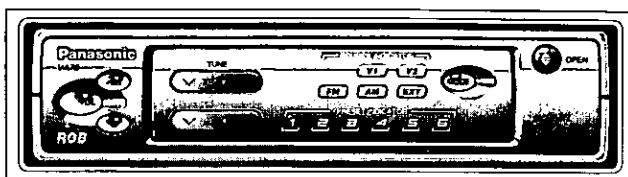
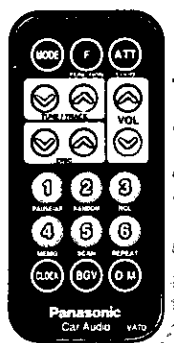

(The corresponding button on the display unit may also be used for this operation.)

## To change Tuner Mode

Press MODE to switch to tuner mode.

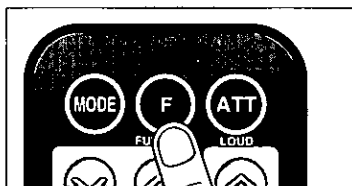

## Selecting a Band

Press F to select the bands as follows.

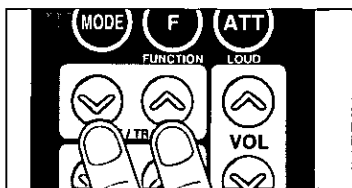
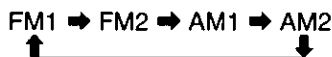

(The corresponding button on the display unit may also be used for this operation.)

## Manual Tuning

Press  $\nabla$ TUNE/TRACK $\wedge$  to move to a lower or higher frequency.

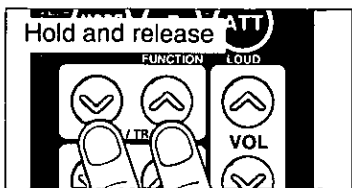

(The corresponding button on the display unit may also be used for this operation.)

## Seek Tuning

Press and hold  $\nabla$ TUNE/TRACK $\wedge$  for more than half a second, then release. The radio automatically stops on the next station.

# Radio Basics (Continued)

## Preset Station Setting

Up to 24 stations can be preset in the station memory as follows;

FM1	FM2	AM1	AM2
6 stations	6 stations	6 stations	6 stations

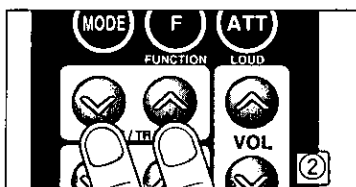
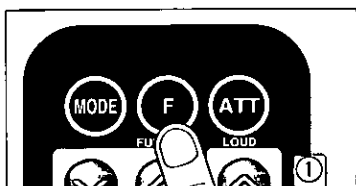

## Manual Station Preset

- ① Press F to select the desired band.
- ② Use Manual or seek tuning to find a station that you want to program into memory.
- ③ Press and hold one of the station selector buttons 1 through 6 until the display blinks.

**Note:** For safety reasons, do not attempt to program while driving.



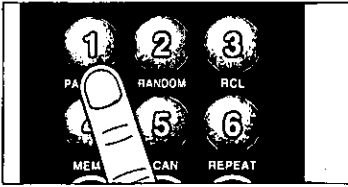

## Tuning in a Station Preset

### <Direct Tuning>

Press any of the button 1 through 6 to tune in the station preset.

### <Sequential Tuning>

Press  $\nabla$ DISC $\wedge$  to tune in to one of the stations preset to the preset buttons (1 to 6). The stations change as follows.

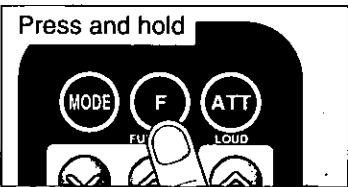
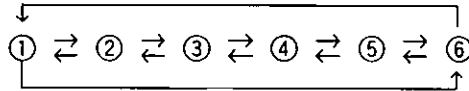
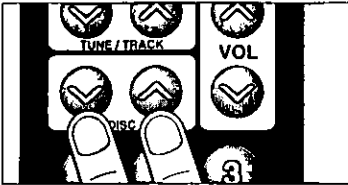

## Auto Station Preset

Select a band, press and hold F for more than 2 seconds.

- The 6 strongest available stations will be automatically set in memory on preset button 1 through 6.
- Once set, the preset stations are sequentially scanned for 5 seconds each.
- Press the appropriate preset button for the station you want to hear.

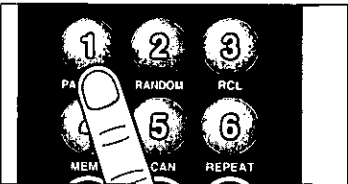

1	87.9	2	88.1	3	88.3
4	91.7	5	101.9	6	107.9

# CD Changer Control Display

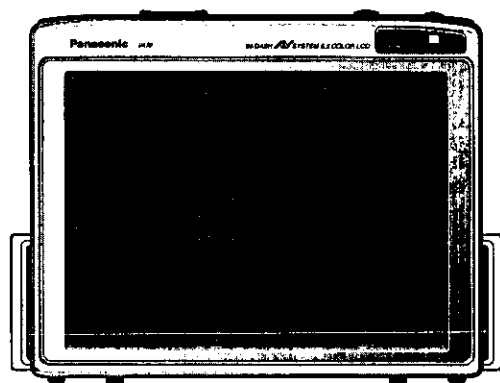
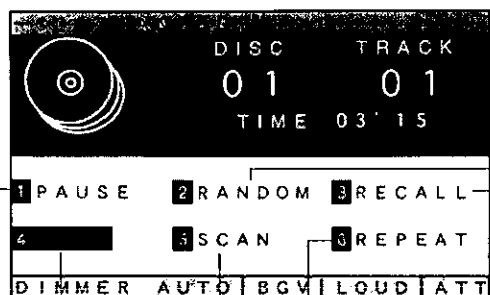

## RANDOM (Random Play) Indicator

Indicates random play.

**2** D-R▶ (Disc random)      **2** RANDOM (Track random)

## RECALL Indicator

Shows **3** RECALL when the disc content is displayed.

## REPEAT Indicator

Indicates repeated playing of a number.

**6** D-REP (Disc repeat)      **6** T-REP (Track repeat)

## SCAN Indicator

Indicates the playing of numbers by scanning.

**5** D-SCAN (Disc scan)      **5** T-SCAN (Track scan)

## MEMO (Memory) Indicator

① Shows **4** MEMO when a number is stored in the memory.

② Shows **4** M▶ in memory play mode.

## PAUSE/AP (Pause/Auto Pause) Indicator

Indicates a pause.

**1** PAUSE (Pause)      **1** AP (Auto pause)

# CD Changer Control Operation

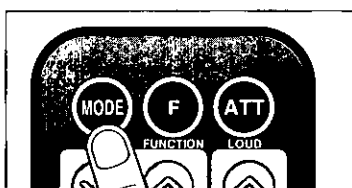
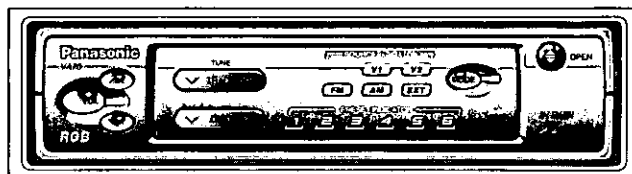
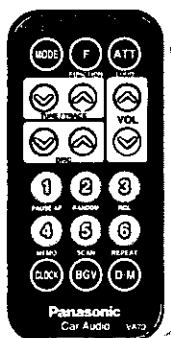

(The corresponding button on the display unit may also be used for this operation.)

## To start the CD Changer

Press MODE to change into the CD changer mode.

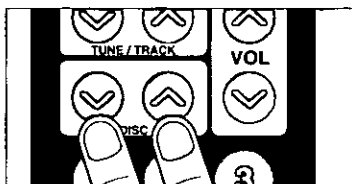
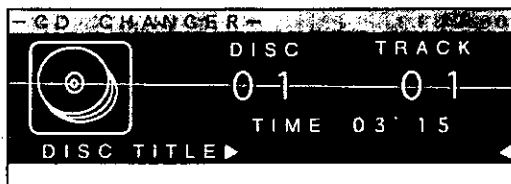

(The corresponding button on the display unit may also be used for this operation.)

## Selecting a Disc

Press  $\nabla$ DISC $\wedge$  to select discs in descending or ascending order.

### Note:

The " $\nabla$ DISC" or "DISC $\wedge$ " is operated, has priority over that of Random play mode. The Random mode will stop and the disc select function will operate once the " $\nabla$ DISC" or "DISC $\wedge$ " is pressed.

# CD Changer Control Operation (Continued)

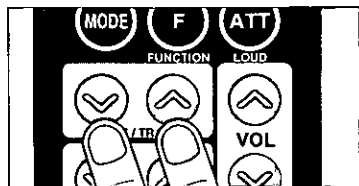

(The corresponding button on the display unit may also be used for this operation.)

## Selecting a Track

- Press "TUNE/TRACK^" once to go to the next track.
- Press "∇TUNE/TRACK" once to play from the beginning of the current track.
- Press repeatedly to skip the desired number of tracks.

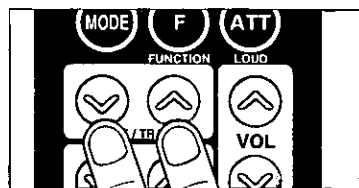

(The corresponding button on the display unit may also be used for this operation.)

## Searching a Track

Press ∇TUNE/TRACK^ for more than half a second to activate fast forward (▲) or reverse (∇) through a track. Release ∇TUNE/TRACK^ to resume the normal CD play.



## Random Selection

### ① Track Random Play

- Press 2 (RANDOM). A random selection of music is played from all available tracks.
- Press 2 (RANDOM) again to cancel.



### ② Disc Random Play

- Press and hold 2 (RANDOM) for more than 2 seconds. "R ►" indicator will light. A random selection of music is played from all available tracks.
- Press and hold 2 (RANDOM) for more than 2 seconds again to cancel.

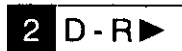

#### Note:

- The order of playing numbers is selected by the built-in computer at random.
- If a number selected for track random play is not available on the current disc (for example, if a 12th number is selected when the disc has only 10 numbers), other numbers on the disc will be automatically selected again.
- If there are only a few discs in the magazine, even empty disc trays will be selected, resulting in an interruption of play during that time. Therefore, using the track random play function is not recommended in such a case.

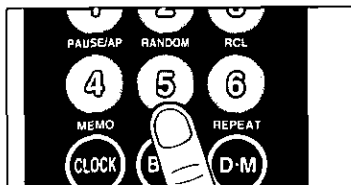

## Scanning Tracks

### ① Track Scan Play

- Press 5 (SCAN). The display blinks and the first 10 seconds of each track on the discs play in sequence.

**5 T-SCAN**

- Press 5 (SCAN) again to cancel.
- Scan mode is also released when the disc has come to the program preceding the original program.

### ② Disc Scan Play

- Press and hold 5 (SCAN) for more than 2 seconds. The first track of all the discs in the magazine is played 10 seconds each.

**5 D-SCAN**

- Press and hold 5 (SCAN) again for more than 2 seconds to cancel.
- Scan mode is also released when the disc has come to the program preceding the original program.



## Repeating a Track

### ① Track Repeat Play

- Press 6 (REPEAT) to repeat the current selection.

**6 T-REP**

- Press 6 (REPEAT) again to cancel.

### ② Disc Repeat Play

- Press and hold 6 (REPEAT) for more than 2 seconds to repeat the current disc.

**6 D-REP**

- Press and hold 6 (REPEAT) again for more than 2 seconds to cancel.

# CD Changer Control Operation (Continued)



## Pause/Auto Pause

- Press 1 (PAUSE) to temporarily stop while the disc playing.

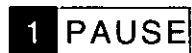

- Press 1 (PAUSE) again to cancel.
- Press and hold 1 (PAUSE) for more than 2 seconds to temporarily stop at the head of each track. (Auto Pause)  
Press 1 (PAUSE) again, the disc starts playing again.



- Press and hold 1 (PAUSE) again for more than 2 seconds to cancel.



## Storing Tracks in Memory

- ① Press 1 (PAUSE) to temporarily stop while the disc playing.



- ② Press 4 (MEMO).

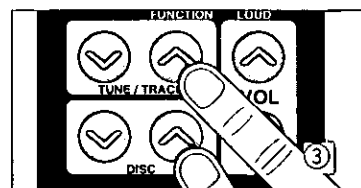

- ③ Press  $\nabla$ DISC $\wedge$  and  $\nabla$ TUNE/TRACK $\wedge$  to select a desired number.



- ④ Press 4 (MEMO) to save the selected number in memory.

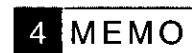

⑤ Repeat steps ③ and ④ to save one desired number after another in the memory. The word FULL appears if an attempt is made to save beyond the maximum limit.

\* The maximum of numbers that can be saved in the memory varies depending on the CD changer used.

**MEMO — FULL**

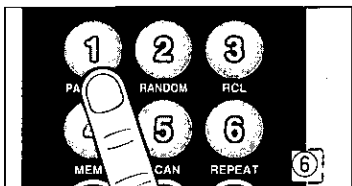

⑥ When all numbers have been saved in the memory, press 1 (PAUSE). Memory play automatically starts with the first number saved in the memory.

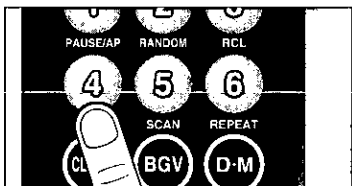

## Memory Play

- Press 4 (MEMO) to start the memory play.



- Press 4 (MEMO) again to cancel.

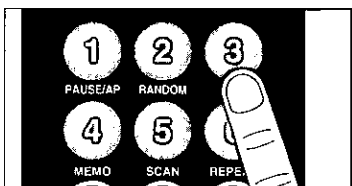

## Memory Check

Press 3 (RCL) to check the all memoried numbers on display.



## To clear the stored memories

To delete all numbers saved in the memory, press and hold 4 (MEMO) for more than 2 seconds while the disc is playing. **4 MEMO** or **4 M▶** on the memory indicator goes out, indicating that the memory has been all cleared.

# CD Changer Control Operation (Continued)

■ **Error Display** ..... Errors are displayed in basic display mode only.

Display	Description
<b>FULL</b>	This appears when the maximum limit is reached in saving numbers for memory play.
<b>E1</b>	This indicates either a dirty disc or a disc placed the wrong side out. In this case, the changer automatically proceeds to the next disc.
<b>E2</b>	This indicates a damaged disc. The changer automatically proceeds to the next disc.
<b>E3</b>	This appears if the set fails to operate due to some cause. Press the EJECT button on the changer.
<b>NO DISC</b>	This appears if no disc is in the magazine.



# Clock Basics (Display)

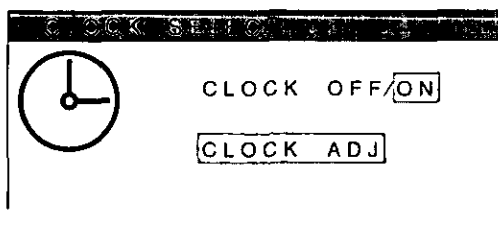
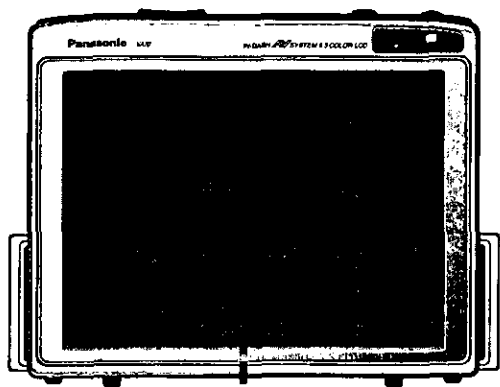

Press  
CLOCK  
button

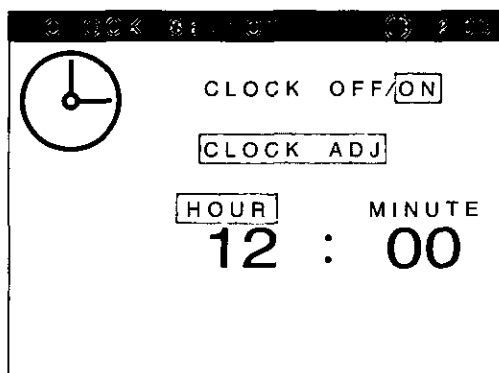

<Time Setting Mode>

# Clock Basics (12-hour clock)

The set has a 12-hour clock built in.



## To Read the Clock

- Press CLOCK to select CLOCK SELECT mode.
- Press  $\nabla$ DISC $\wedge$  to set the clock function ON or OFF.  
ON position: The present time (12-hour system) is displayed.

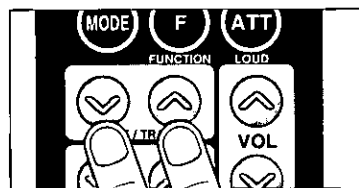

## Clock Adjustment

- ① Press  $\nabla$ TUNE/TRACK $\wedge$  to select CLOCK ADJUST.

For initial adjustment



For second or subsequent adjustment

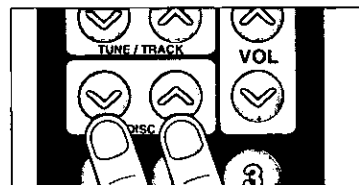

- ② To set hours, press  $\nabla$ DISC.  
To set minutes, press DISC $\wedge$ .

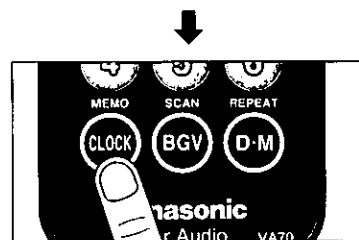

- ③ Press CLOCK again after setting to switch to normal mode.

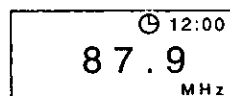

**Note:**

If  $\nabla$ DISC or DISC $\wedge$  is pressed in the middle of clock adjustment, hour or minute is continuously increased.

# Useful Features

## Direct Memory Function

The set has a direct memory function which calls back a station from the memory and receives it as you press a button in any mode. It is convenient for listening to traffic information.

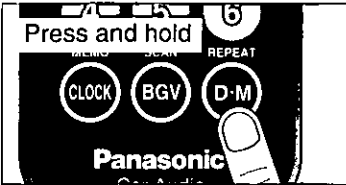

### Direct Memory (D.M)

Select a desired station to be saved in the memory in tuner mode, press and hold D.M for more than 2 seconds. This saves the selected station in the direct memory.

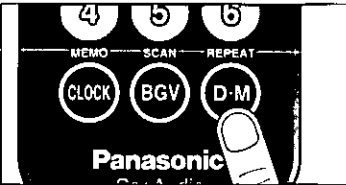

### Direct Memory Recall

Press D.M to switch to D.M mode as below to receive the station saved in the memory.

Normal mode ↔ D.M (User memory)

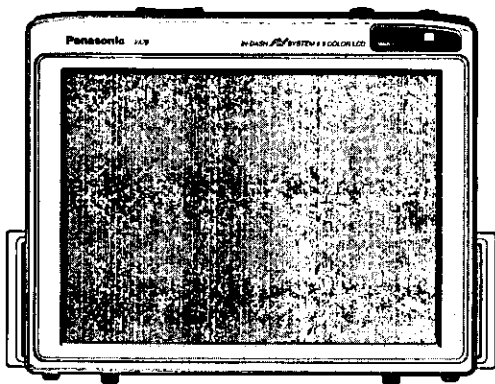

# Useful Features (Continued)

## Background Visual (BGV)

The BGV (Background Visual) function allows you to keep watching your favorite video tape program and change only the audio sound. It is available in all VTR modes.

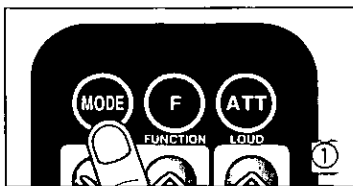

① Press MODE and select your favorite video tape program from any VTR mode.

② Press BGV to change to BGV mode. "BGV" appears in the display.

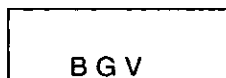

③ Press MODE and select a favorite audio program from VTR.

④ Press BGV again to cancel.

**Note:**

Any button operated in BGV mode will only affect audio operation.

## Color Selection

The colors of the function display can be modified.

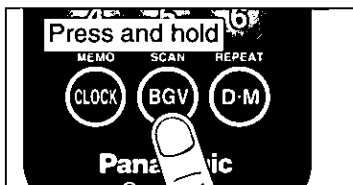

Each time press and hold BGV for more than 2 seconds, the next four different color patterns is selected.

# Setting for System Upgrading

## Setting for video output type car navigation system

To use a video output type car navigation system, connect it to the VTR2 terminal. This will bring up the navigation screen when NAVIGATION switch is turned on without the side-brake having to be pulled. (Select VTR2 with MODE button.)

- \* Set NAVIGATION switch to match the equipment connected to the VTR2 terminal as shown in the table below.

Equipment connected to VTR2	Position of NAVIGATION switch
Car navigation system	ON
Video playback equipment, such as video deck	OFF

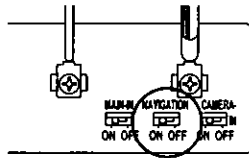

NAVIGATION Switch

(The NAVIGATION switch is originally set to OFF position when shipped from the factory.)

## Setting for connection of a car backup camera

Use the VTR1 terminal to connect the car backup camera. When the CAMERA switch is set to the ON position and the reverse cord is connected, the camera operation will be interlocked with the reverse gear of the car. In this arrangement, the display will change automatically to the car backup camera screen whenever the car goes into reverse gear.

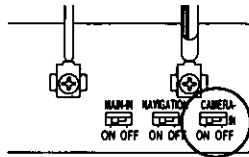

CAMERA Switch

(The CAMERA switch is originally set to OFF position when shipped from the factory.)

# Setting for System Upgrading (Continued)

## MAIN-IN Switch Setting

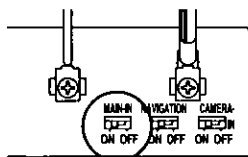

MAIN-IN Switch

If the MAIN-IN switch is in the OFF position, the signals input to the MAIN-IN input terminal will not be reproduced as sound. Keep MAIN-IN switch in the OFF position except for upgraded systems. (The MAIN-IN switch is originally set to the OFF position before product shipment from the factory.)

# Batteries for Remote Control

## Battery Replacement:

1. **Remove the battery holder.**  
Pull the holder by the Position B while pushing Position A in the direction indicated by the arrow.
2. **Replace the battery.**  
Set a new battery properly with the (+) side up as illustrated.
3. **Insert the battery holder.**  
Push in the holder to the original position.

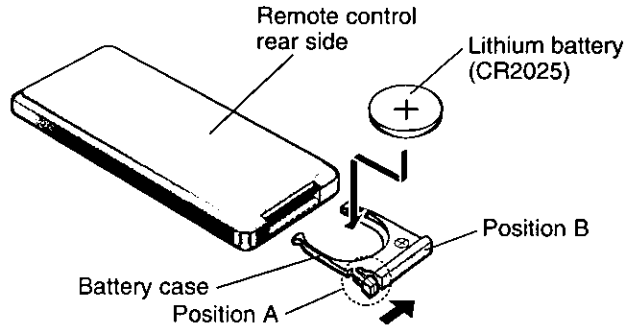

## Note on Batteries:

Old batteries must immediately be removed and disposed.

Battery Information:

- Designated Battery: Panasonic Lithium Battery (CR2025)
- Battery Life: 6 months with normal use (in normal room temperature)

**Caution:**

Improper use of batteries may cause overheating, explosion or ignition, resulting in injury or fire. Battery leakage may cause damage to the unit.

- Do not disassemble or short the batteries. Do not throw the batteries into the fire.
- To avoid the risk of accident, keep the batteries out of reach of children.

# Maintenance and Care

## Maintenance

Your product is designed and manufactured to ensure a minimum of maintenance. To clean the exterior of this unit, use a soft cloth to wipe the surface. Do not use benzine, thinner, or any other type of solvent.

## Product Service

- This unit should only be serviced by qualified technicians. Service information is not provided for customers.
- Should your units ever require service, refer to the MITO service department listed in the Warranty card for detail instructions.

## Replacing the Fuse

Be sure to use a fuse of the specified rating (3A, 10A) when replacing a blown fuse. Fuses with higher capacity ratings, use of any substitute, or connection without a fuse may result in a fire hazard or damage to the unit. If the replacement fuse fails, consult the MITO service department for detail instructions.

# Installation Guide

## ■ Precautions

If possible, this equipment should be professionally installed. In case of difficulty, please consult with your nearest professional installer.

1. This unit only operates in a 12-volt DC negative ground system.
2. Before performing installation and wiring, remove the negative (-) terminal of the battery. (See Note below.)

**Note:**

Do not disconnect the negative battery terminal in vehicles equipped with trip or navigational computers. All electronic memory settings previously registered will be lost. Take extra care to avoid causing short-circuits when installing the unit.

3. Follow the wiring connection diagram carefully to avoid causing damage to the unit.
4. Insulate all exposed wires to prevent short-circuits.
5. Secure all loose wires after installing the unit.
6. Please carefully read the operating and installation instructions of any equipment connected to this unit.

## ■ Transportation bracket removal

Be sure to remove the transportation brackets before use (installation).  
Use screws (M5 x 6 mm) with washers for installation.  
Be careful not to lose any of these parts.

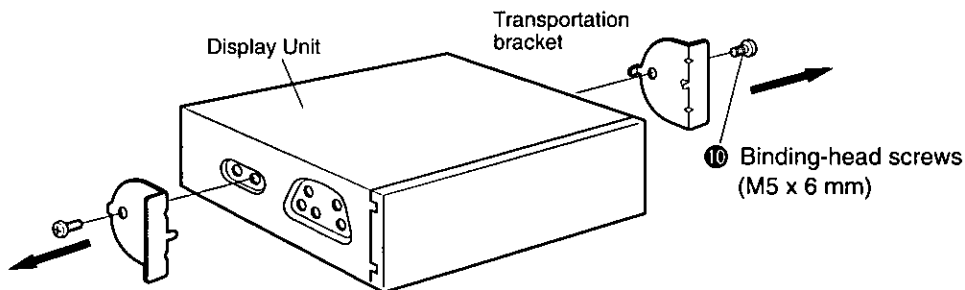

## ■ Installation Hardware

(The supplied package contains the following installation hardware.)

No.	Description	Qty.	No.	Description	Qty.
①	Trim plate	1	⑧	Washer assembling hex bolt (M6 x 20mm)	1
②	Mounting frame	1	⑨	Stay	1
③	Mounting spring	2	⑩	Binding-head screw (M5 x 6 mm)	2
④	Rubber pad	1	⑪	Flat-head screw (M5 x 6 mm)	4
⑤	Mounting bolt (M5)	1	⑫	Spacer	2
⑥	Flange nut (M6)	1	⑬	Double-Faced adhesive tape	2
⑦	Washer assembling hex bolt (M5 x 10mm)	1	⑭	Magic tape	2



## ■ Installation

1. Insert the mounting frame into the dashboard or console of the car.

2. Bend the tabs on the mounting frame with a screwdriver or the like (at least at 6 points.)

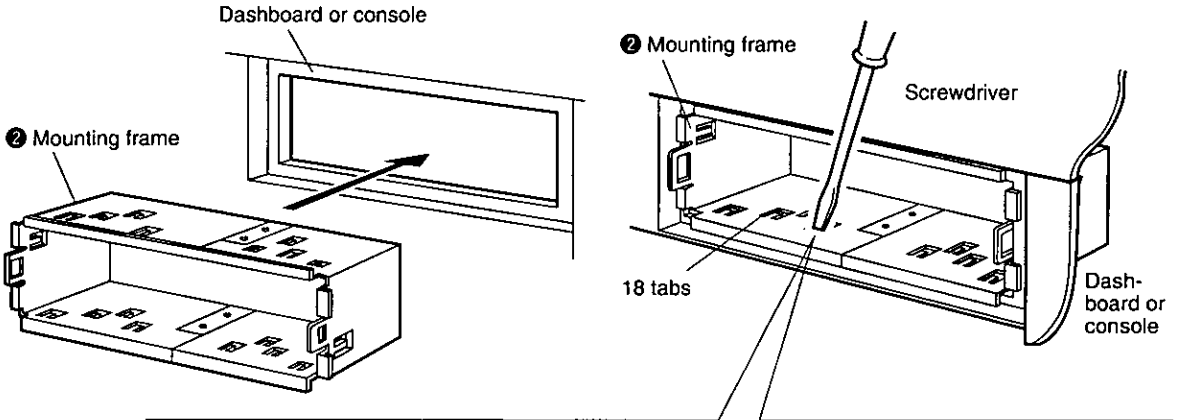

### Fastening the Mounting Frame

The tabs to be bent vary depending on the car. Bend them with a screwdriver to fasten the mounting frame securely in the dashboard or console.

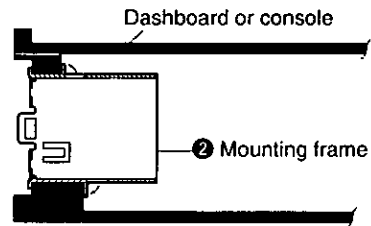

3. Attach the mounting springs to the car audio set.

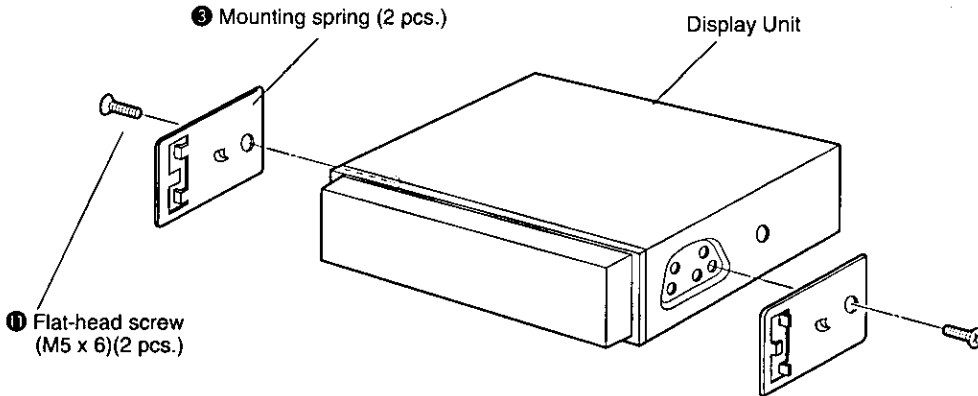

# Installation Guide (Continued)

4. Install the car audio set and trim plate in the mounting frame fastened to the car.

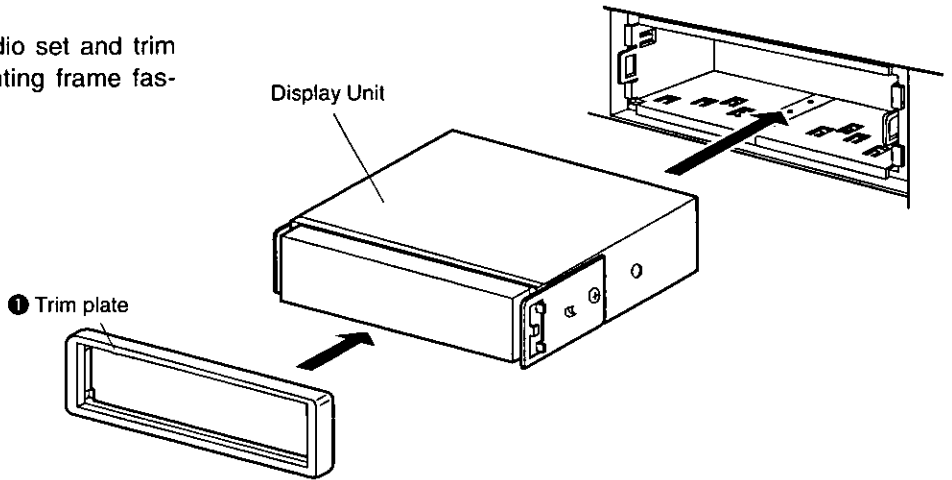

■ There are two ways of fastening the rear of the car audio set.

• Fastening it to bracket on the car

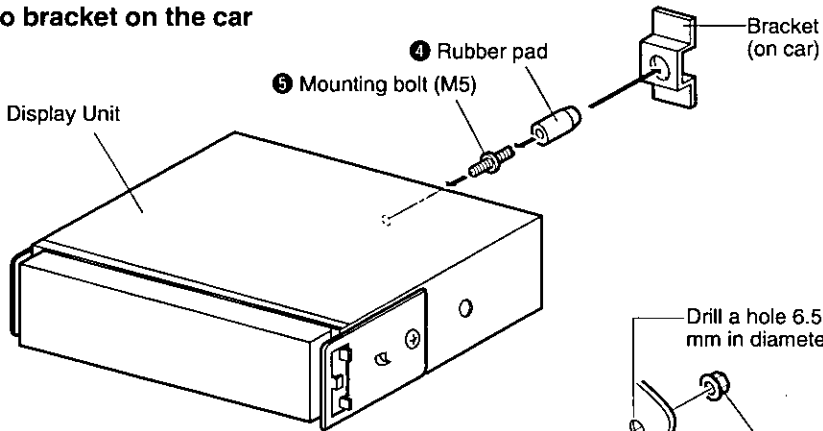

• Fastening to iron plate on the car

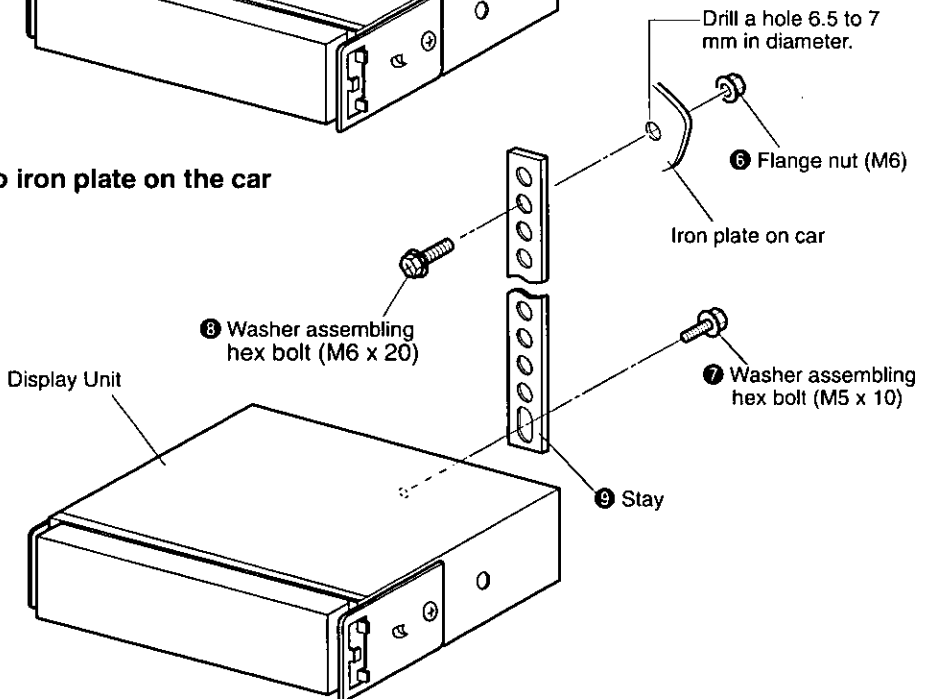

- When mounting the unit in a Toyota car, use the lateral side screw holes marked "T".
- Use the brackets on the car for installation.
- An exclusive kit (optional) may be needed according to the year, model, and grade. Please consult a nearby sales agent. An exclusive relay cord (optional) is also available. It facilitates wiring toward the car side.

To maximize performance of this unit, mount it at an angle of within 30 degrees against the horizontal plane.

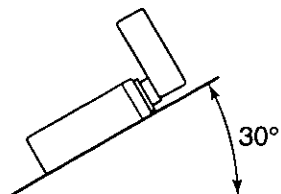

## <Mounting the Tuner Unit>

### Mounting Example

Stick Magic tape ⑭ on the L-type mounting brackets and mount the tuner on the car carpet.

**Note:**

Some carpet materials may not be suitable for this mounting method.

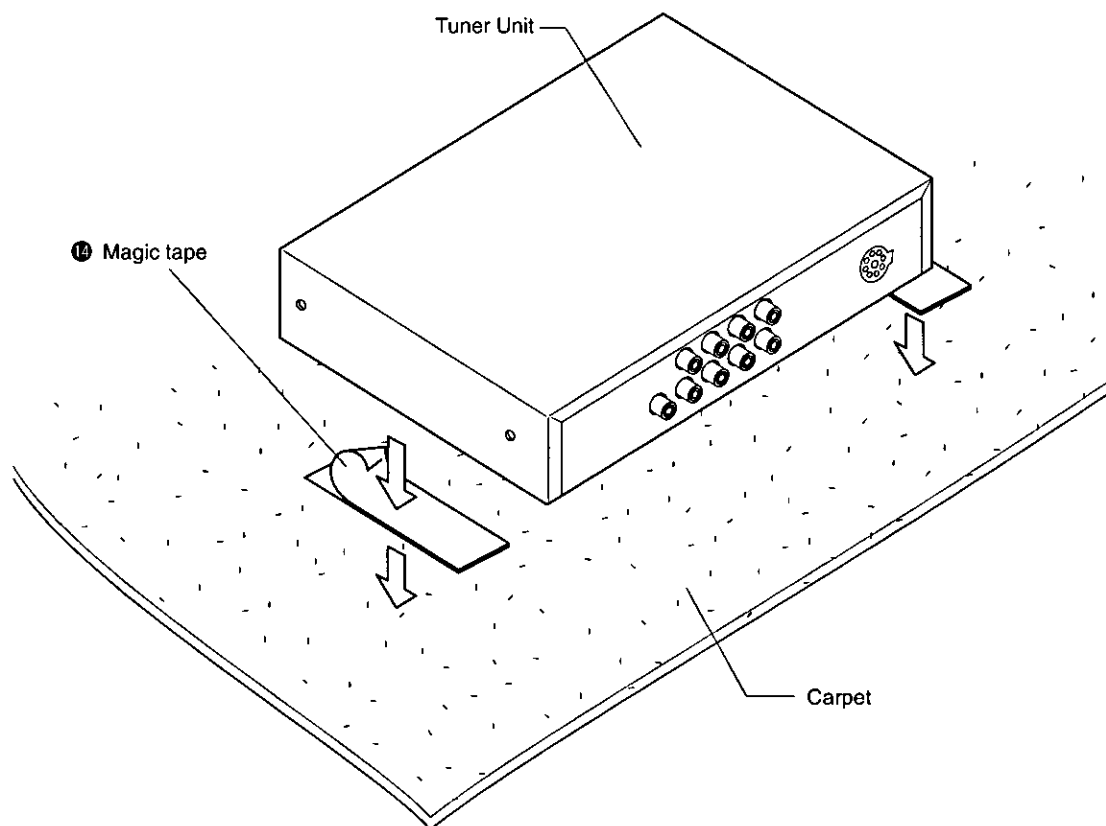

**Note:**

- Never mount the tuner in any of the following locations to avoid damage due to overheating:
  1. Near the heater port
  2. Places like the dashboard or rear tray, where it may be exposed to direct sunlight.
- Do not mount the tuner near the door, where it could be exposed to rain.

# Electrical Connection

## Before Wiring

- To prevent damage to the unit, be sure to follow the connection diagram below.
- Be sure to insulate any exposed wires against possible short-circuit from the car chassis. Bundle all cables and should not be disconnected. Therefore, extra care should be taken to prevent short-circuits.
- Do not insert the power connector into the unit until the wiring is completed.

**Note:**

For installation in cars with trip or navigational computers, all electronic memory settings previously registered in the computer will be lost when the battery terminal is disconnected. Do not disconnect the battery in vehicles equipped with these units. Therefore, extra care should be taken to prevent short-circuits.

## <Basic Wiring>

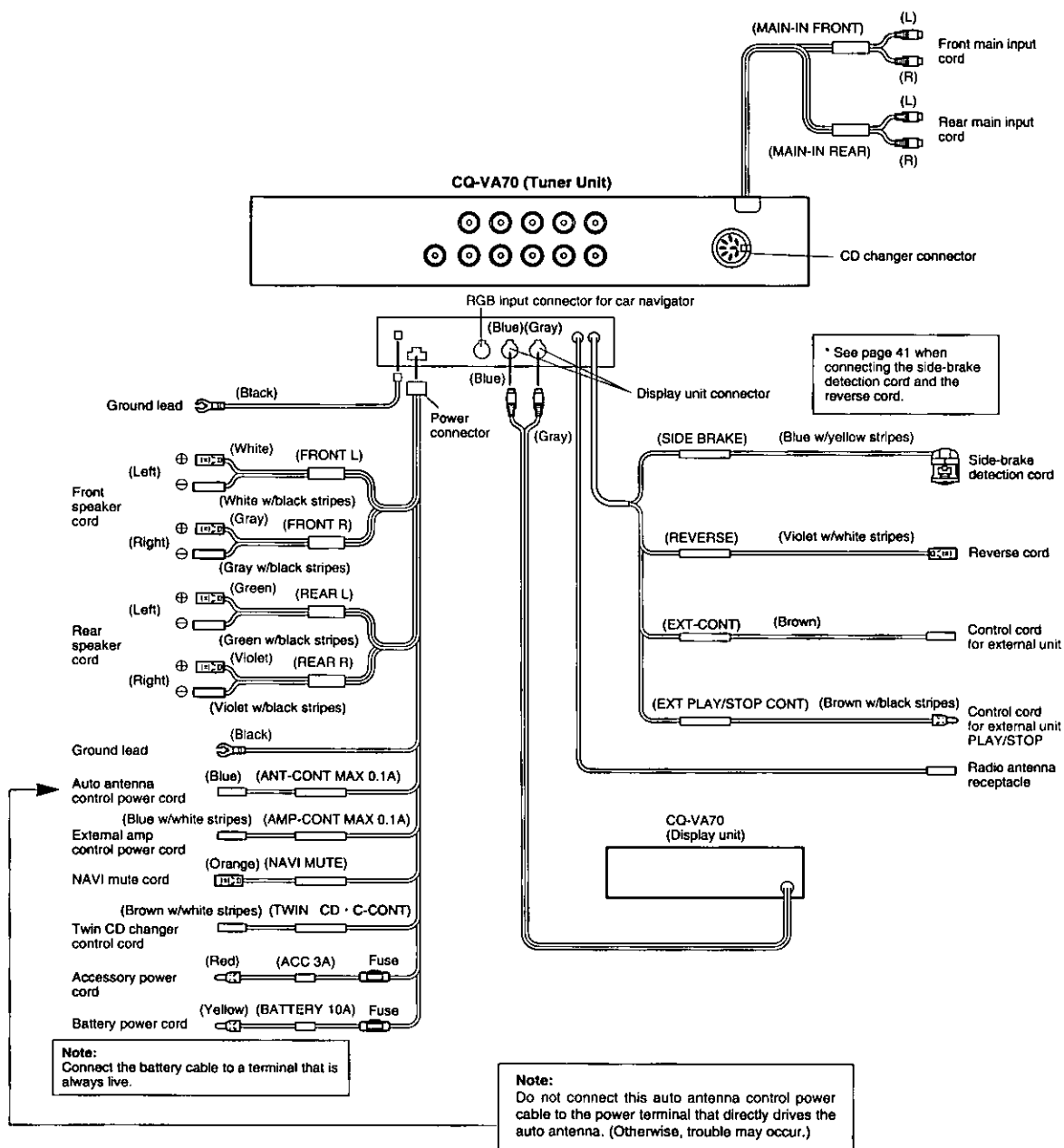

## <System Upgrading Example 1>

Connecting VTR1 (or a car backup camera) and VTR2 (or a general car navigator) to the CQ-VA70EU

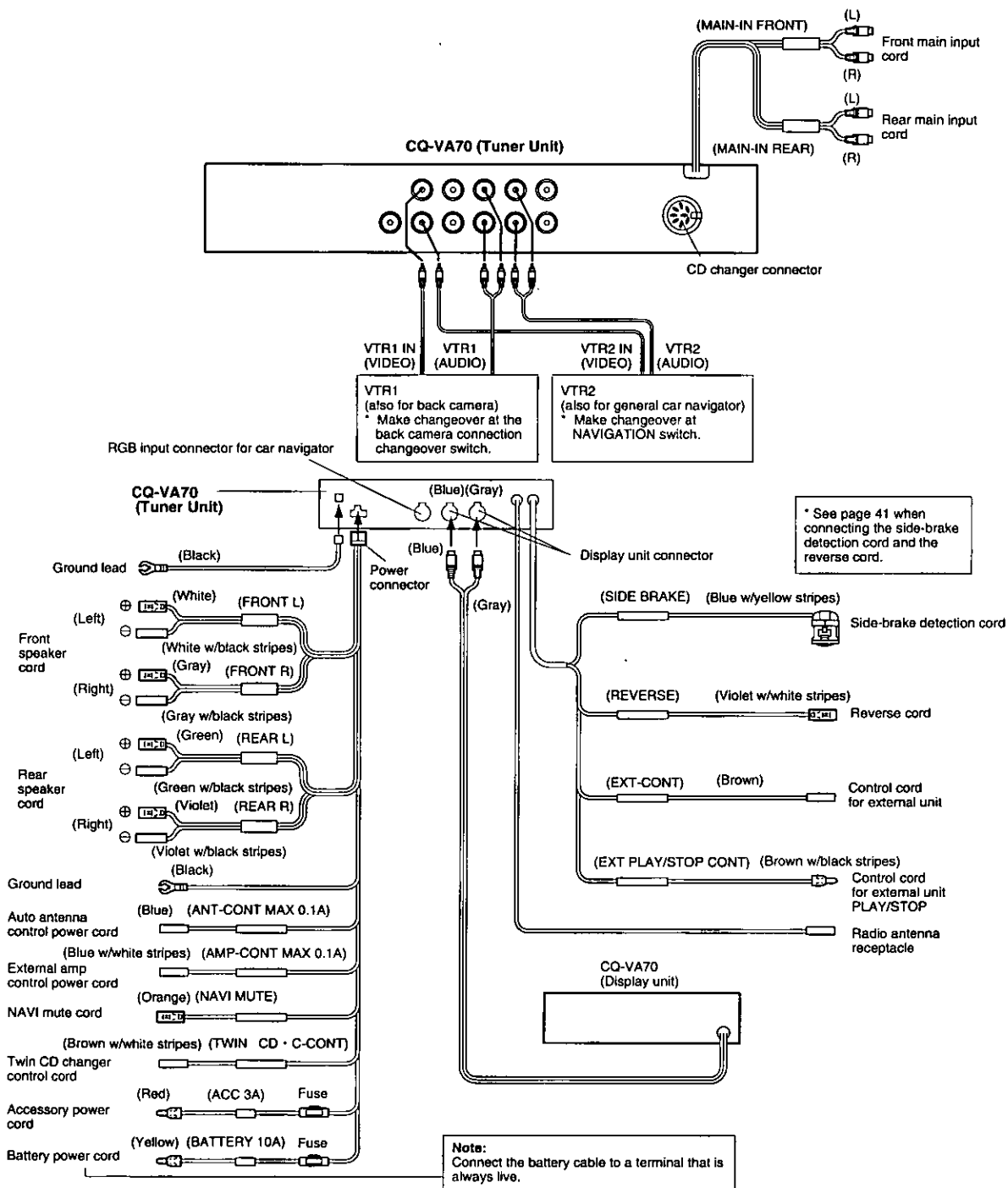

# Electrical Connection (Continued)

## <System Upgrading Example 2>

System upgrading by combining CQ-VA70 with CX-DP801EUC

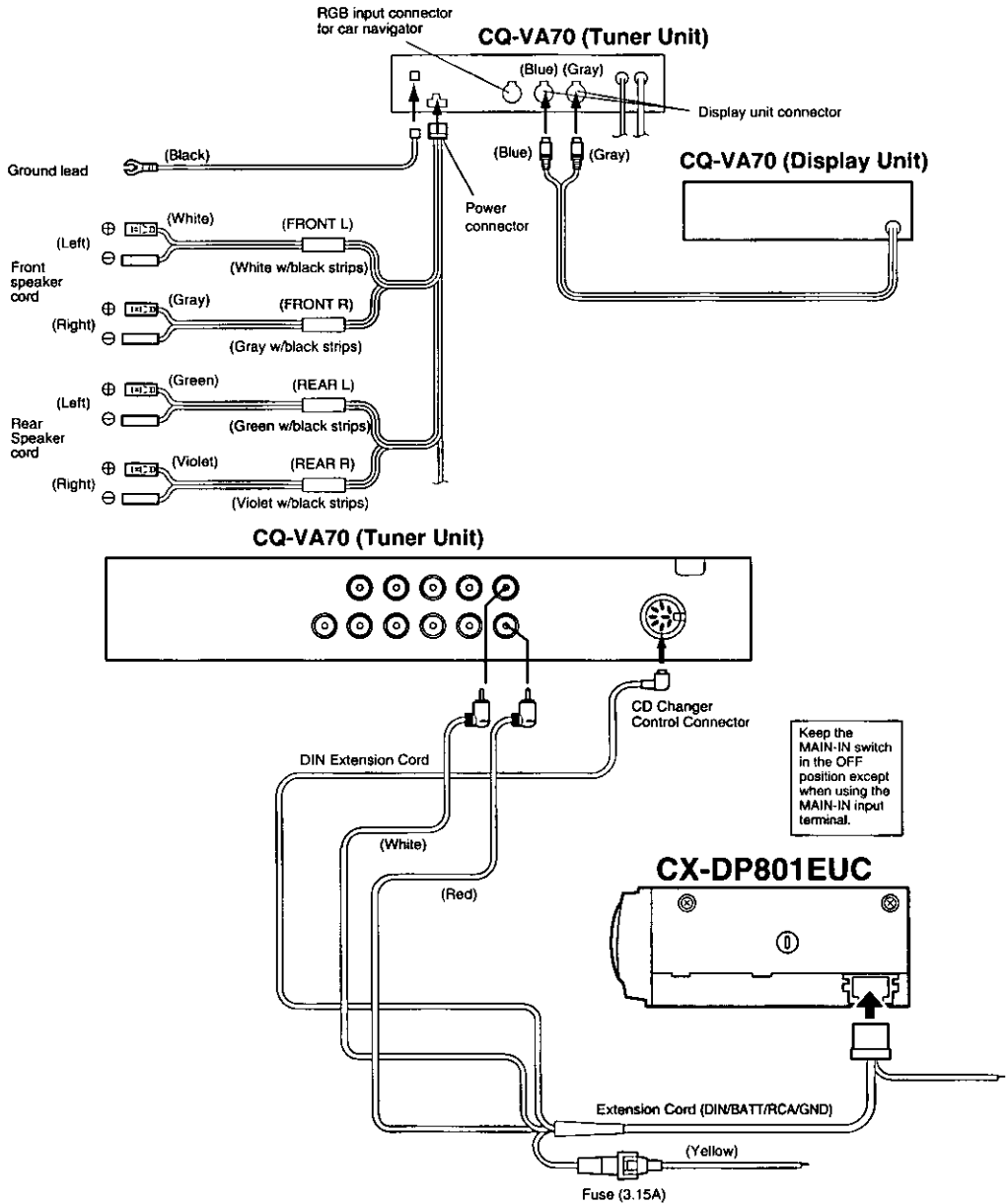

## Description of Tuner Unit Connectors and Switches

- These are connectors and switches used to upgrade the system by connecting various units.
- Refer to the system upgrading examples on pages 37, 38 for connections.

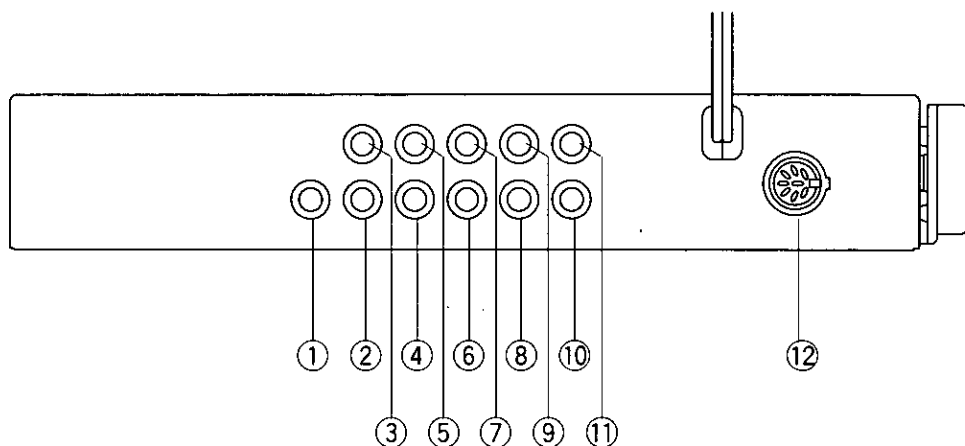

- |   |   |
|---|---|
| <p>① <b>VIDEO-OUT</b><br/>Outputs a video signal for an external monitor.</p> <p>② <b>VTR2-IN</b><br/>Accepts the video input from VTR2.</p> <p>③ <b>VTR1-IN</b><br/>Accepts the video input from VTR1.</p> <p>④ <b>PRE OUT (R)</b><br/>Supplies the right channel audio output.</p> <p>⑤ <b>PRE OUT (L)</b><br/>Supplies the left channel audio output.</p> <p>⑥ <b>VTR1 (R)</b><br/>Accepts the right channel audio input from VTR1.</p> <p>⑦ <b>VTR1 (L)</b><br/>Accepts the left channel audio input from VTR1.</p> | <p>⑧ <b>VTR2 (R)</b><br/>Accepts the right channel audio input from VTR2.</p> <p>⑨ <b>VTR2 (L)</b><br/>Accepts the left channel audio input from VTR2.</p> <p>⑩ <b>EXT (R)</b><br/>Accepts external audio input for the right channel.</p> <p>⑪ <b>EXT (L)</b><br/>Accepts external audio input for the left channel.</p> <p>⑫ <b>CH • C</b><br/>For connecting a CD changer.</p> |
|---|---|

# Electrical Connection (Continued)

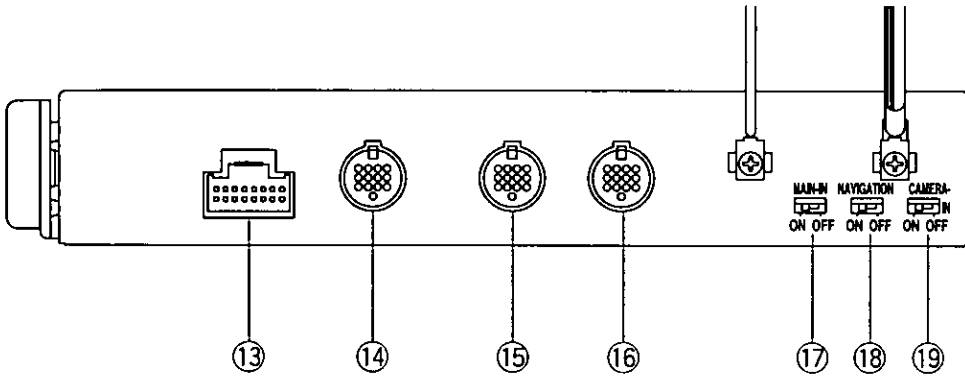

- ⑬ **Power Terminal**  
For connecting the power connector of the CQ-VA70.
- ⑭ **NAVI-RGB**  
For connecting a navigation system.
- ⑮ **DISPLAY UNIT-A**  
For connecting an exclusive display unit.
- ⑯ **DISPLAY UNIT-B**  
For connecting an exclusive display unit.

- ⑰ **MAIN-IN Switch**  
Set this switch to the ON position when using the MAIN-IN terminal.
- ⑱ **NAVIGATION CHANGEOVER Switch**  
Set this switch to the ON position when using a navigation system.
- ⑲ **CAMERA CHANGEOVER Switch**  
Set this switch to the ON position when using a rear-view camera.



## Connecting the Side-brake Detection Cord

**Note:**  
Make sure to connect the side-brake cord to ensure safety and prevent accidents.

- \* Out of the two cords coming from the side-brake switch, connect the cord that is normally not earthed on the chassis (when the side-brake is released.)

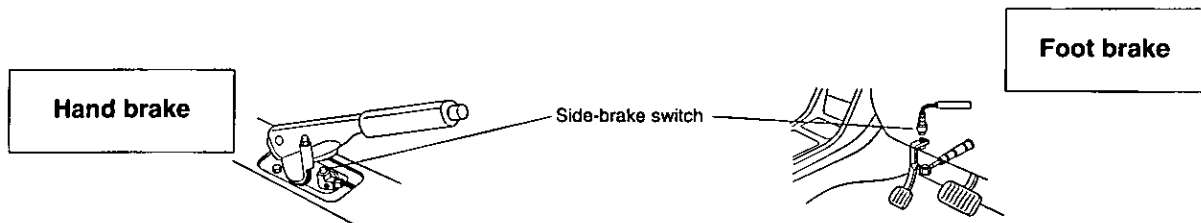

- \* Make sure to connect the side-brake cord (blue/yellow) to the wiring of the side-brake switch.
- \* The position of the side-brake switch can differ according to the car model. An example is shown below. Detailed information is obtainable from the car dealer.

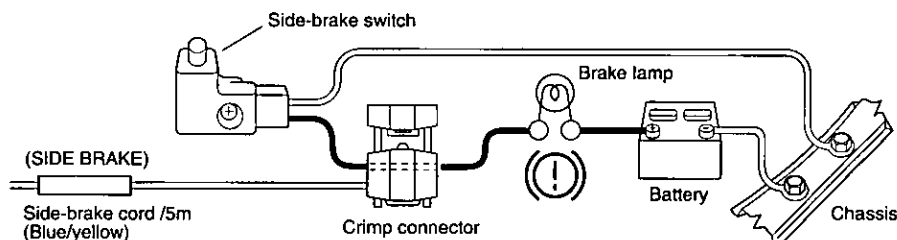

## Connecting the Reverse Cord

- \* Connect the reverse cord (violet/white) to the plus wire of the backup light. The backup light (with a clear lens) is located at the rear of the car and lights when the gear lever is put into reverse (R).

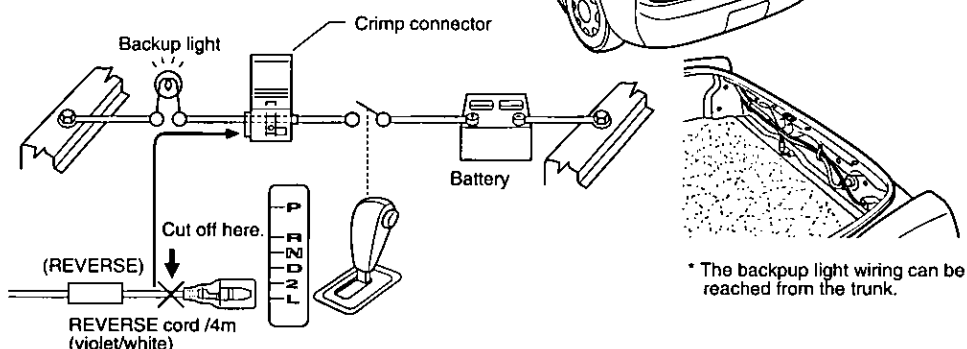
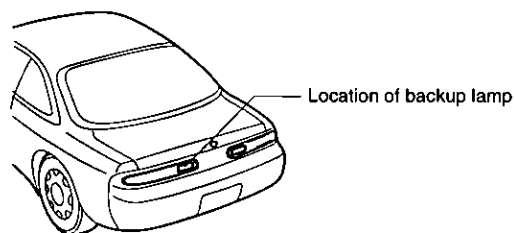

# In Case of Irregular Operation

Tuner unit

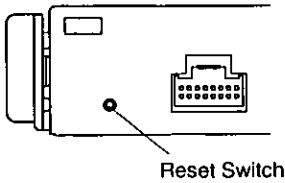

## <Reset switch>

Pressing this switch after recovery from an irregularity resets the circuit to its initial condition. Use a fine but strong enough tool like a thin bar to press the switch. Note, however, that resetting will clear all memory contents.

# Maintenance

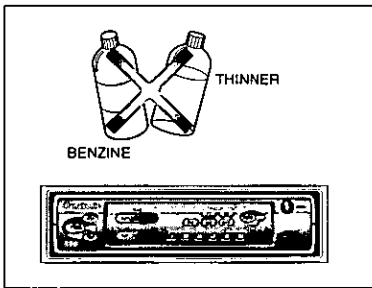

## <Cleaning the unit casing>

- Wipe the unit casing clean with a dry soft cloth. Do not use benzine or thinner because the casing and coating may deteriorate.
- If you use a chemical cleaning cloth, follow its usage instructions.

# Specifications

## General

Power supply		: DC 12V (11V - 16V); test voltage, 14.4V; negative ground
Current consumption		: 7.8A (at rated VTR operation output)
Bass adjustment		: $\pm 12$ dB (100 Hz)
Treble adjustment		: $\pm 12$ dB (10,000 Hz)
Rated output power		: 12W x 4CH (1,000 Hz, 1%, 4 $\Omega$ )
Maximum output power		: 30W x 4CH
Suitable speaker impedance		: 4 $\Omega$
Audio input impedance		: 10k $\Omega$
Audio input sensitivity		: 600 mV
PRE-OUT output voltage		: 600 mV
PRE-OUT output impedance		: 600 $\Omega$
Video input signal		: Composite video signal, 1.0 V[p-p], 75 $\Omega$
Video output signal		: Composite video signal, 1.0 V[p-p], 75 $\Omega$
External dimensions	Display Unit	: 178(W) x 50(H) x 160(D) mm
	Tuner Unit	: 260(W) x 40(H) x 160(D) mm
Weight	Display Unit	: 2.3 kg
	Tuner Unit	: 1.7 kg

## Tuner Block

### FM tuner block

Frequency Range	: 87.9 - 107.9 MHz
Practical sensitivity	: 12 dB
S/N 50 dB quieting sensitivity	: 15.2 dBf
Total harmonic distortion (monaural)	: 0.3% (1 kHz)
Auditory correction S/N ratio	: 70 dB
Frequency response	: 20 - 15,000 Hz $\pm 3$ dB
Stereo Separation	: 42 dB (1 kHz)
Effective selectivity	: 75 dB

### AM tuner block

Frequency Range	: 530 - 1,710 kHz
Practical sensitivity	: 33 dB/ $\mu$ V (S/N 20 dB)
Image rejection ratio	: 65 dB

## Display Block

Display	: 6.5 type (17cm)
No. of pixels	: 224,640 (Vertical 234 x Horizontal 960) Effective pixel rate 99.99% or more
Driving system	: TFT (thin-film transistor) active matrix system
Light source	: Internal light (small FL incorporated)

**Panasonic Consumer Electronics  
Company, Division of Matsushita  
Electric Corporation of America**  
One Panasonic Way, Secaucus,  
New Jersey 07094

**Panasonic Sales Company  
Division of Matsushita Electric of  
Puerto Rico, Inc. ("PSC")**  
Ave. 65 de Infanteria, Km. 9.5  
San Gabriel Industrial Park,  
Carolina,  
Puerto Rico 00985

## Free Manuals Download Website

<http://myh66.com>

<http://usermanuals.us>

<http://www.somanuals.com>

<http://www.4manuals.cc>

<http://www.manual-lib.com>

<http://www.404manual.com>

<http://www.luxmanual.com>

<http://aubethermostatmanual.com>

Golf course search by state

<http://golfingnear.com>

Email search by domain

<http://emailbydomain.com>

Auto manuals search

<http://auto.somanuals.com>

TV manuals search

<http://tv.somanuals.com>