



Cat. No. 14-1120
OWNER'S MANUAL

Please read before using this equipment.

CTR-114

**Auto Reverse
Voice-Activated
Cassette Recorder
with Two-Speed
Recording**

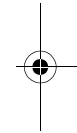
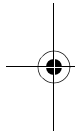

OPTIMUS®

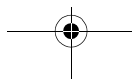



FEATURES



Your Optimus CTR-114 Auto-Reverse Voice-Activated Cassette Recorder offers the greatest convenience in recording technology. You can have recording begin and end according to the sound level in a room, which gives you hands-free operation while recording. The CTR-114's microphone is sensitive enough for the boardroom, a seminar, or a lecture hall. And it's small enough to fit in your briefcase or purse, so it can go wherever you go.

The CTR-114's other features include:

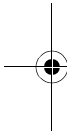

Two-Speed Recording — lets you record at normal or extended speed to maximize your recording time.



Automatic Reverse — automatically changes the tape direction at the end of a tape side so you can continuously play or record both sides of a cassette tape.

Voice Activated Recording — lets you choose hands-free operation which saves tape.

Voice Zoom Switch — lets you record voice sounds clearly and reduce noises outside the voice range.

© 1998 Tandy Corporation.
All Rights Reserved.
Optimus and RadioShack are registered
trademarks used by Tandy Corporation.





Playback Speed Control — lets you adjust the playback speed of your tape.

Built-in Microphone — lets you make quality recordings without having to use an external microphone.

External Microphone Jack — lets you connect an optional external microphone for unidirectional recording, reducing background noise.

One-Touch Recording — lets you start recording with the press of a button.

Cue/Review — lets you listen to recordings at high speed to help you find a particular section and stop there.

Mic Sensitivity Switch — lets you select low or high microphone sensitivity for recording specific sounds, like a one-on-one interview, or for recording broader sounds, as in a lecture hall.

Tape Direction Control — lets you change the tape's direction at any time without having to eject the tape and turn it over.

Battery Check Indicators — show you the amount of power remaining in the batteries.

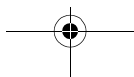
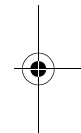
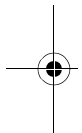



Tape Counter — helps you quickly find a specific section on the cassette. It resets with the touch of a button.

Automatic Level Control — automatically sets the correct recording level.

Three Power Sources — let you power your cassette recorder from internal batteries (not supplied), standard AC power (with an optional AC adapter), or your vehicle's battery (with an optional DC adapter).

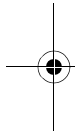

Automatic Shut-Off Mechanism — automatically shuts off the recorder at the end of the reverse side of the tape while playing or recording.

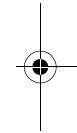

We recommend you record the CTR-114's serial number here. The number is on the label inside the cassette compartment.

Serial Number: _____

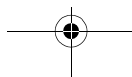



CONTENTS



Preparation	6
Connecting Power	6
Using Battery Power	6
Using AC Power	9
Using Vehicle Battery Power	11
Connecting an Earphone	13
Listening Safely	14
Traffic Safety	14
Connecting an External Microphone	15
Attaching the Wrist Strap	16
Operation	17
Loading a Cassette Tape	17
Recording	18
Playing a Cassette Tape	23
Using Fast Forward and Rewind	27
Using the Tape Counter	28
Tape Tips	29
Erasing Tapes	29
Preventing Accidental Erasure	29
Restoring Tape Tension and Sound Quality	30
Care and Maintenance	31
Cleaning the Tape-Handling Parts	32
Specifications	34





PREPARATION



CONNECTING POWER

You can power your CTR-114 from:

- internal batteries
- AC power (with an optional AC adapter)
- vehicle battery power (with an optional DC adapter)

Note: Connecting an adapter automatically disconnects internal batteries.



Using Battery Power



You can power the CTR-114 with two AA batteries (not supplied). For the best performance and longest life, we recommend alkaline batteries, such as RadioShack Cat. No. 23-557.

You can also use rechargeable nickel-cadmium batteries (Cat. No. 23-125). These batteries and a battery charger (Cat. No. 23-133) are available at your local RadioShack store.

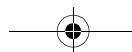

Cautions:

- Use only fresh batteries of the required size and recommended type.
- Do not mix old and new batteries, different types of batteries (standard, alkaline, or rechargeable), or rechargeable batteries of different capacities.

Follow these steps to install batteries.

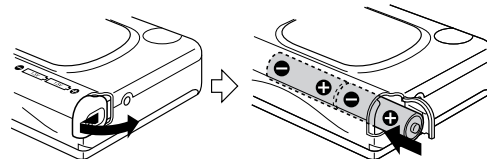

1. Press down and slide the battery compartment cover in the direction of the arrow, then lift open the cover.
2. Put the batteries in the compartment as indicated by the polarity symbols (+ and -) marked outside the compartment.
3. Close the cover.

The CTR-114 has three colored battery indicators which show how much power is left in the batteries. The battery indicators light when you press **STOP**, **PLAY**, **RECORD**, **◀◀** or **▶▶**.

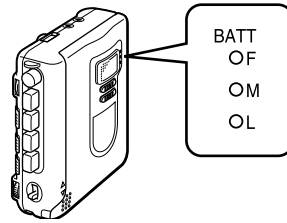

BATTERY Indicators	Green → F (full)	Orange → M (medium)	Red L (low)
---------------------------	---------------------	------------------------	----------------

When the red (L) battery indicator lights, replace both batteries.

Caution: Always dispose of old batteries promptly and properly. Do not burn or bury them.



Important: This product is capable of using rechargeable nickel-cadmium batteries. At the end of a nickel cadmium battery's useful life, it must be recycled or disposed of properly. Contact your local, county, or state hazardous waste management authorities for information on recycling or disposal programs in your area. Some options that might be available are: municipal curbside collection, drop-off boxes at retailers such as your local RadioShack store, recycling collection centers, and mail-back programs.

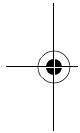

Using AC Power

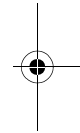

To power the cassette recorder from a standard AC outlet, you need an AC adapter such as Cat. No. 273-1663.

Cautions:

- You must use an AC adapter that supplies at least 3 volts DC power and delivers at least 400 mA. Its center tip must be set to negative, and its barrel plug must properly fit the CTR-114's **DC 3V** jack. The recommended adapter meets these specifications. Using an adapter that does not meet these specifications could damage the cassette recorder or the adapter.

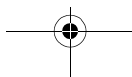

-
- Be sure you connect the adapter to the cassette recorder before you plug it into the AC outlet, and unplug the adapter from the AC outlet before you unplug it from the cassette recorder.

Follow these steps to connect the cassette recorder to AC power.

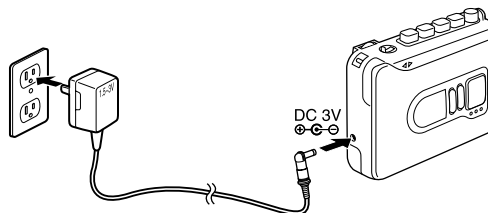

1. Set the adapter's voltage switch to 3V.
2. Insert the adapter's 3.4 mm outer diameter/1.3 mm inner diameter barrel plug into the adapter's cord, with the tip set to negative.
3. Insert the plug into the cassette recorder's **DC 3V** jack.
4. Plug the adapter into a standard AC outlet.



Using Vehicle Battery Power

To power the recorder from your vehicle's battery, you need a DC adapter, such as Cat. No. 270-1562.

Cautions:

- You must use a DC adapter that supplies at least 3 volts DC power and delivers at least 400 mA. Its center tip must be set to negative, and its barrel plug must properly fit the recorder's **DC 3V** jack. The recommended adapter meets these specifications. Using an adapter that does not meet these specifications could damage the recorder.
- Be sure you plug the adapter into the cassette recorder before you plug it into the cigarette-lighter socket, and unplug the adapter from the cigarette-lighter socket before you unplug it from the cassette recorder.

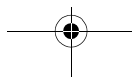
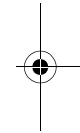
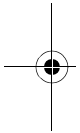

Follow these steps to power the cassette recorder from your vehicle's battery.

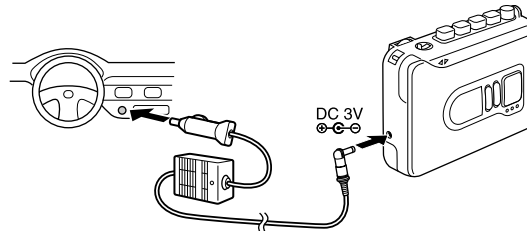

1. Set the adapter's voltage switch to 3V.
2. Insert the adapter's 3.4 mm outer diameter/1.3 mm inner diameter barrel plug into the adapter's cord, with the tip set to negative.
3. Insert the plug into the cassette recorder's **DC 3V** jack.
4. Plug the other end of the adapter into the vehicle's cigarette-lighter socket.

CONNECTING AN EARPHONE

You can use an optional earphone with a $\frac{1}{8}$ -inch (3.5-mm) plug to listen to a tape in privacy. Insert the earphone's plug into the cassette recorder's **EAR** jack.

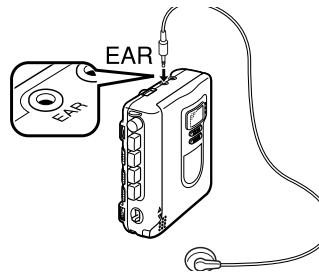

Notes:

- You can also use an earphone during recording to listen to what the recorder is picking up through the internal or an external microphone. (See "Recording" on Page 18.)
- Your local RadioShack store carries a wide selection of earphones.



Listening Safely

To protect your hearing, follow these guidelines when you use an earphone.

- Rotate the volume to the lowest setting before you begin listening. After you begin listening, adjust the volume to a comfortable level.
- Do not listen at extremely high volume levels. Extended high-volume listening can lead to permanent hearing loss.
- Once you set the volume, do not increase it. Over time, your ears adapt to the volume level, so a volume level that does not cause discomfort might still damage your hearing.

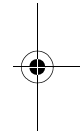
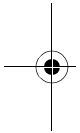

Traffic Safety

Do not wear an earphone while operating a motor vehicle or riding a bicycle. This can create a traffic hazard and could be illegal in some areas.

Even though some headphones let you hear some outside sounds when listening at normal volume levels, they still can present a traffic hazard.

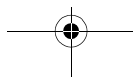

CONNECTING AN EXTERNAL MICROPHONE

You can connect an external microphone (not supplied) with a $\frac{1}{8}$ -inch (3.5-mm) plug to the recorder's **MIC** jack. Connecting an external microphone automatically disconnects the built-in microphone.

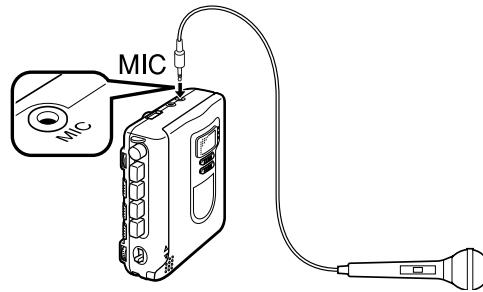

Note: Your local RadioShack store sells a variety of microphones.

ATTACHING THE WRIST STRAP

Attach the supplied wrist strap to the CTR-114 to make it easier to carry and to reduce the risk of accidentally dropping it.

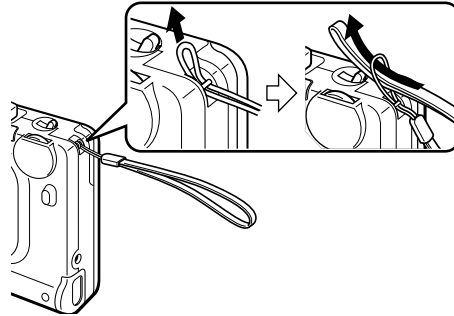

Thread the strap's small loop around the metal pin on the corner of the CTR-114. Then insert the opposite end of the strap through the slim loop and pull it until the slim loop tightens around the metal pin.

Hint: If you have difficulty threading the slim loop around the medal pin, use the end of a straightened paper clip to hook onto the loop and pull it through.

OPERATION

You can use the recorder to play normal bias, high-bias, and metal tapes. However, you should only use normal bias (Type I) tapes for recording. If you record on metal or high-bias tapes, the recorded sound will not erase properly.

LOADING A CASSETTE TAPE

1. Take up any slack in the tape by turning the cassette's hub with a pencil. Do not touch the exposed tape.

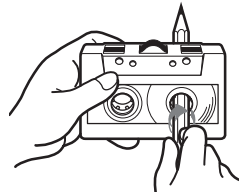

2. Lift open the cassette compartment door.

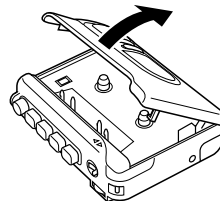



3. Insert a cassette into the door's tape guides with the cassette's open edge facing up.

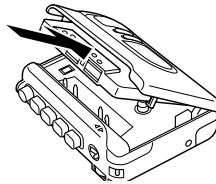

4. Close the door.

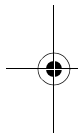

RECORDING

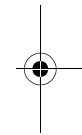

You can record using the built-in microphone or an optional external microphone. For the best performance, use any normal bias (Type I) tape up to 90 minutes long. We do not recommend 120-minute tapes because they are thin and can easily tangle.

Notes:

- The ALC (Automatic Level Control) circuit automatically sets the recording level.
- If you set **DIRECTION** to **REV**, the cassette recorder records on only the reverse side and stops at the end of that side.

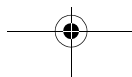

- If you want to record on only one side of a tape, load the tape so the side you want to record on faces inside the cassette compartment, set **DIRECTION** to **REV**, then start the recording.

Caution: If you load a cassette with the erase-protection tabs broken off, do not try to force down **RECORD**. This can damage the recording mechanism. (See "Preventing Accidental Erasure" on Page 29.)

Follow these steps to record.

1. Load a blank cassette tape, or one you want to record over, into the cassette compartment.
2. Slide **MIC SENSITIVITY** to **LO** or **HI**, depending on the sound source you want to record.

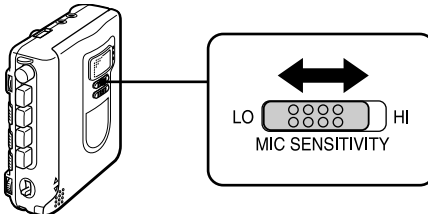

LO (Low): Select **LO** when the sound source is near the recorder.

HI (High): Select **HI** when the sound source is far from the recorder, as in a board room, a seminar, or a lecture hall.

3. To record specific voices without background interference, slide **VOICE ZOOM** to **ON**. The CTR-114 cuts off higher and lower frequency signals (background noise) and enhances the mid-range.

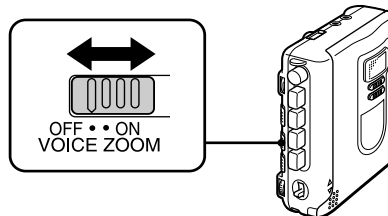

4. Slide **REC SPEED** to **NORM** for normal recording, or to **EXT** for extended recording (twice the normal recording time). At the EXT setting, the recorder puts the recording in half the space used during normal speed.

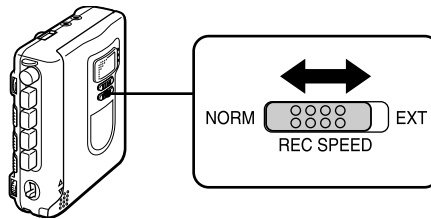

Note: Tapes recorded at the EXT setting can play only on this recorder or on another recorder that has the extended recording feature.

5. Set **VOX** to **OUT** if you want to manually start and stop recording. Or, set **VOX** to **IN** to use voice-activated recording.

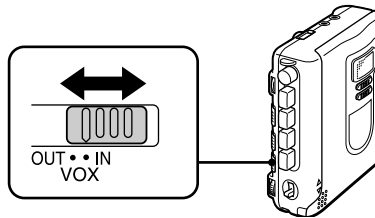

At the VOX setting, recording begins when the recorder picks up sound and stops a few seconds after the sound stops.

Hint: The voice-activated feature saves power and tape if there are long or frequent pauses in the material you are recording.

6. Press **RECORD** when you want to begin recording. **RECORD** and **PLAY** automatically lock down.

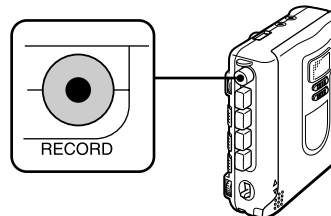

If **VOX** is set to **OUT**, recording begins immediately. If **VOX** is set to **IN**, recording begins when the recorder picks up sound.

Note: To pause recording, slide **PAUSE** in the direction of the arrow. To resume recording, slide **PAUSE** to the other position.

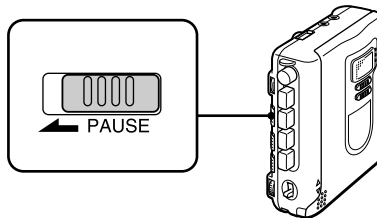

7. If you set **VOX** to **IN**, adjust **VOX SENS** to set the sound level at which recording begins. When you adjust **VOX SENS** higher, softer sounds start **VOX** recording. When you adjust **VOX SENS** lower, louder sounds start **VOX** recording.

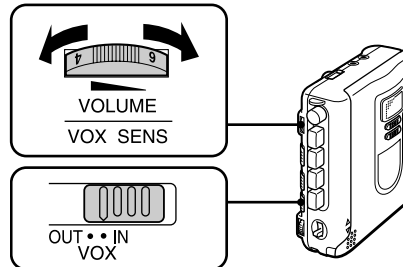

Notes:

- The CTR-114 records on one side of the tape, automatically reverses the tape's direction, records on the reverse side of the tape, then automatically stops.
 - You can use an earphone (not supplied) to monitor a recording in progress.
8. To stop recording before it automatically stops, press **STOP**.

PLAYING A CASSETTE TAPE

1. Switch **DIRECTION** to **FWD** to play the side of the cassette facing out, or to **REV** to play the side facing in.

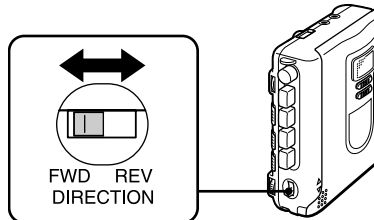

2. Set the auto reverse switch in the cassette compartment to either one-time or continuous playback.

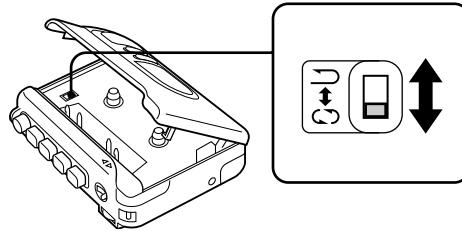

 **One-Time Playback:** plays one side of the tape to its end, then automatically reverses the tape's playback direction, plays the reverse side of the tape, then automatically stops.

Notes:

- If you set **DIRECTION** to **REV**, the cassette recorder plays only the reverse side and stops at the end of that side.
- If you move **DIRECTION** from **REV** to **FWD** during playback, the cassette recorder stops.

 **Continuous Playback:** plays both sides of the tape continuously until you press **STOP**.

3. Press **PLAY** ◀▶ . The button locks down and the tape plays.

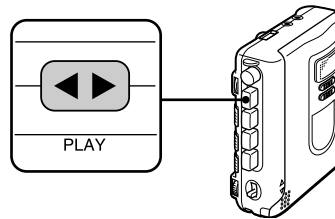

Note: Slide **REC SPEED** to **NORM** for tapes that have been prerecorded on other recorders or recorded with the normal record setting on this recorder. Or slide **REC SPEED** to **EXT** for tapes that have been recorded with the extended record setting on this recorder.

4. Turn **PLAY BACK SPEED** toward **FAST** to play the tape more quickly or toward **SLOW** to play it more slowly.

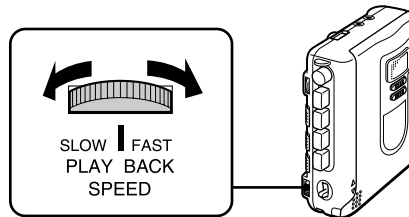

5. Adjust **VOLUME** to the desired listening level.

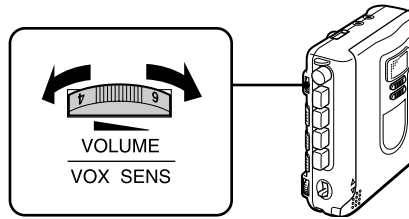

6. To stop the tape, press **STOP**.

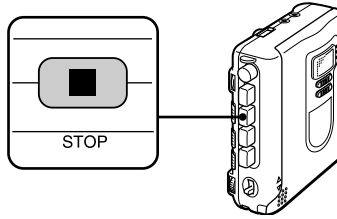

Note: To stop play momentarily, slide **PAUSE** in the direction of the arrow. Slide **PAUSE** to the other position to resume play.

Using Fast Forward and Rewind

When the tape is stopped, press ◀◀ or ▶▶ to re-
wind or fast-forward it.

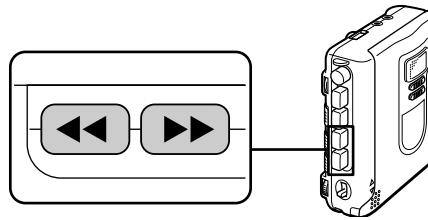

DIRECTION setting	To rewind, press	To fast-forward, press
FWD	▶▶	◀◀
REV	◀◀	▶▶

To stop the tape, press **STOP**.

Note: The CTR-114 does not automatically stop when it reaches the end of the tape. To protect the tape after the tape has fully wound to either end, press **STOP** to release fast-forward or rewind.

You can also hold down ◀◀ or ▶▶ during playback to help you locate a specific portion of the tape (for example, if you are listening for a particular speech, statement or other audio cue). While holding it down, you hear the tape at a faster speed. To return to normal playback, release the button.

USING THE TAPE COUNTER

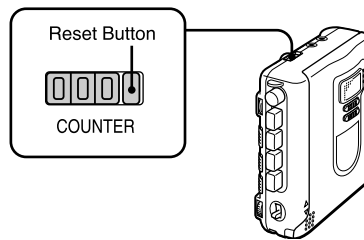

You can use the tape counter to note different positions or locations on your tape during recording or playback. Before playing a tape, press the tape counter reset button to set the counter to 000.

During play or recording, the numbers advance to show the amount of tape that has moved past the tape heads since the tape began moving. When the tape rewinds, the numbers decrease.

TAPE TIPS

Erasing Tapes

If you record on a previously recorded tape, you replace the old recording with the new one. If you need to quickly erase an entire tape, you might prefer to use a bulk eraser (available at your local RadioShack store).

Note: If you use metal or high-bias type tape, the recorded sound may not be erased properly.

Preventing Accidental Erasure

Cassettes have two erase-protection tabs — one for each side. When a tab is in place, you can record on that side.

To prevent accidental erasure of a tape recording, use a screwdriver to remove one or both of the cassette tape's erase-protection tabs. This prevents **RECORD** from being pressed.

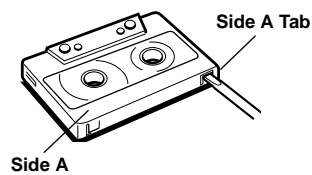



If you later decide to record on a tape side after you have removed its erase-protection tab, place a piece of strong plastic tape over that side's erase-protection hole. Be sure you cover only the hole originally covered by the erase-protection tab.

Caution: Removing the erase-protection tabs does not prevent a bulk tape eraser from erasing a cassette tape.

Restoring Tape Tension and Sound Quality

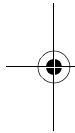

After you play a cassette tape several times, the tape might become tightly wound on the reels. This can cause playback sound quality to deteriorate.

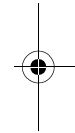

To restore the sound quality, fast-forward the tape from the beginning to the end of one side, then completely rewind it. Then loosen the tape reels by gently tapping each side of the cassette's outer shell on a flat surface.

Caution: Be careful not to damage the cassette when tapping it. Do not touch the exposed tape or allow any sharp objects near the cassette.

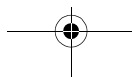



CARE AND MAINTENANCE



Your Optimus CTR-114 Auto-Reverse Voice-Activated Cassette Recorder is an example of superior design and craftsmanship. The following suggestions will help you care for the cassette recorder so you can enjoy it for years.

- Keep the recorder dry. If it gets wet, wipe it dry immediately. Liquids might contain minerals that can corrode the electronic circuits.
- Use and store the recorder only in normal temperature environments. Temperature extremes can shorten the life of electronic devices, damage batteries, and distort or melt plastic parts.
- Keep the recorder away from dust and dirt, which can cause premature wear of parts.
- Handle the recorder gently and carefully. Dropping it can cause the recorder to work improperly.
- Use only fresh batteries of the required size and recommended type. Batteries can leak chemicals that damage your recorder's electronic parts.
- Wipe the recorder with a damp cloth occasionally to keep it looking new. Do not use harsh chemicals, cleaning solvents, or strong detergents to clean the recorder.





Modifying or tampering with the recorder's internal components can cause a malfunction and might invalidate the recorder's warranty. If your recorder is not performing as it should, take it to your local RadioShack store for assistance.

CLEANING THE TAPE-HANDLING PARTS

Dirt, dust, or particles of the tape's coating can accumulate on the tape heads and other parts the tape touches. This can greatly reduce the performance of the cassette recorder. After every 20 hours of tape player operation, use a cassette deck cleaning kit or follow these steps to clean the tape-handling parts.

1. Remove the batteries and disconnect any other power source.
2. Open the cassette compartment door.
3. Press **PLAY** ◀▶ to expose the tape-handling parts.

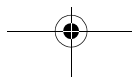
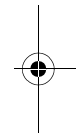
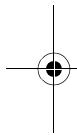

4. Use a cotton swab dipped in denatured alcohol or tape head cleaning solution to clean the record/playback head, pinch rollers, tape guides, and capstans.

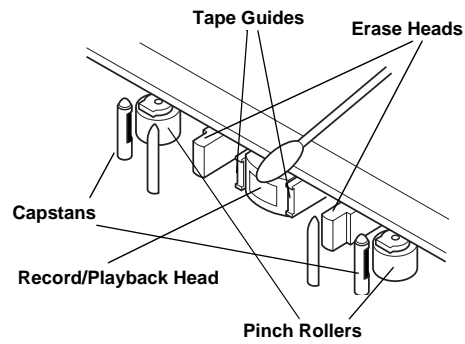

5. When you finish cleaning, press **STOP** and close the cassette compartment door. Then reconnect power.

Your local RadioShack store sells a complete line of cassette recorder cleaning supplies.



GENERAL

Power Output 15 mW/Channel at 32 ohms

Dimensions (HWD) $4\frac{1}{2} \times 3\frac{5}{8} \times 1\frac{1}{2}$ Inches
(112.4 × 89.8 × 37.6 mm)

Weight (without battery) 7.2 oz
(206 g)

Specifications are typical; individual units might vary.
Specifications are subject to change and improvement without notice.

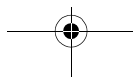
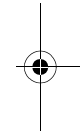
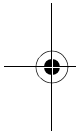



Limited Ninety-Day Warranty

This product is warranted by RadioShack against manufacturing defects in material and workmanship under normal use for ninety (90) days from the date of purchase from RadioShack company-owned stores and authorized RadioShack franchisees and dealers. EXCEPT AS PROVIDED HEREIN, RadioShack MAKES NO EXPRESS WARRANTIES AND ANY IMPLIED WARRANTIES, INCLUDING THOSE OF MERCHANTABILITY AND FITNESS FOR A PARTICULAR PURPOSE, ARE LIMITED IN DURATION TO THE DURATION OF THE WRITTEN LIMITED WARRANTIES CONTAINED HEREIN. EXCEPT AS PROVIDED HEREIN, RadioShack SHALL HAVE NO LIABILITY OR RESPONSIBILITY TO CUSTOMER OR ANY OTHER PERSON OR ENTITY WITH RESPECT TO ANY LIABILITY, LOSS OR DAMAGE CAUSED DIRECTLY OR INDIRECTLY BY USE OR PERFORMANCE OF THE PRODUCT OR ARISING OUT OF ANY BREACH OF THIS WARRANTY, INCLUDING, BUT NOT LIMITED TO, ANY DAMAGES RESULTING FROM INCONVENIENCE, LOSS OF TIME, DATA, PROPERTY, REVENUE, OR PROFIT OR ANY INDIRECT, SPECIAL, INCIDENTAL, OR CONSEQUENTIAL DAMAGES, EVEN IF RadioShack HAS BEEN ADVISED OF THE POSSIBILITY OF SUCH DAMAGES.

Some states do not allow the limitations on how long an implied warranty lasts or the exclusion of incidental or consequential damages, so the above limitations or exclusions may not apply to you.

In the event of a product defect during the warranty period, take the product and the RadioShack sales receipt as proof of purchase date to any RadioShack store. RadioShack will, at its option, unless otherwise provided by law: (a) correct the defect by product repair without charge for parts and labor; (b) replace the product with one of the same or similar design; or (c) refund the purchase price. All replaced parts and products, and products on which a refund is made, become the property of RadioShack. New or reconditioned parts and products may be used in the performance of warranty service. Repaired or replaced parts and products are warranted for the remainder of the original warranty period. You will be charged for repair or replacement of the product made after the expiration of the warranty period.

This warranty does not cover: (a) damage or failure caused by or attributable to acts of God, abuse, accident, misuse, improper or abnormal usage, failure to follow instructions, improper installation or maintenance, alteration, lightning or other incidence of excess voltage or current; (b) any repairs other than those provided by a RadioShack Authorized Service Facility; (c) consumables such as fuses or batteries; (d) cosmetic damage; (e) transportation, shipping or insurance costs; or (f) costs of product removal, installation, set-up service adjustment or reinstallation.

This warranty gives you specific legal rights, and you may also have other rights which vary from state to state.

RadioShack Customer Relations, Dept. W, 100 Throckmorton St., Suite 600, Fort Worth, TX 76102

We Service What We Sell

3/97



RadioShack
A Division of Tandy Corporation
Fort Worth, Texas 76102

87-HT6-906-01
 980620ACK-0-9
 Printed in Malaysia



8A8N



Free Manuals Download Website

<http://myh66.com>

<http://usermanuals.us>

<http://www.somanuals.com>

<http://www.4manuals.cc>

<http://www.manual-lib.com>

<http://www.404manual.com>

<http://www.luxmanual.com>

<http://aubethermostatmanual.com>

Golf course search by state

<http://golfingnear.com>

Email search by domain

<http://emailbydomain.com>

Auto manuals search

<http://auto.somanuals.com>

TV manuals search

<http://tv.somanuals.com>