



Panasonic

EB-G51E

Operating Instructions Part 1 Digital Cellular Phone

GSM

Before operating this equipment please read these instructions (parts 1 and 2) completely

Contents

Part 2 of these Operating Instructions contains important information which should be read before operating your phone. Please completely read the appropriate section of part 2 before continuing with part 1.

Getting Started	1	My Phone	16
Inserting and Removing the SIM	1	Sounds	16
Attaching and Removing the Battery	1	Display	19
Charging the Battery	2	Language	21
Operation of Battery Level Indicator	2	Alert Type.....	22
Low Battery Power Warning	2	Profiles	22
Keys & Displays	3	User Messages	24
Keys	3	Auto Answer.....	25
Display.....	4	Any Key Answer.....	25
Status Icons.....	4	Reset Defaults	25
Symbols Used in the Manual.....	5	Shortcuts	26
Menu Display.....	5	My Phonebook	26
Menu Structure.....	6	T9 Input.....	26
Shortcut from Idle Screen.....	7	Games Menu Structure	27
Phone Basics	8	Games	28
Phone ON/OFF	8	Selecting Games.....	28
Displaying Menu.....	8	Phone Book Menu Structure	29
Making Calls.....	9	Phone Book	30
Answering Calls.....	11	Storing.....	30
In-Call Options.....	12	Viewing	32
My Phone Menu Structure	15	Options in Phone Book	32

Group Settings	33	Codes.....	59
Memory Status.....	34	Network.....	61
My Numbers.....	34	CSD Setting	61
Hot Key Dial.....	35	GPRS Setting.....	62
My Phonebook.....	35	GPRS Info.....	62
Browser Menu Structure	36	Applications Menu Structure	63
Browser	37	Applications	64
Server Setting	37	Games	64
WAP Activating	38	STK (SIM Tool Kit).....	64
Bookmarks	39	Scheduler.....	65
Key Guard.....	40	Clock.....	66
Messages Menu Structure	41	Calculator.....	68
Messages.....	42	Currency	69
SMS	42	Melody Composer.....	69
Options.....	47	Sound Folder	70
Broadcast.....	48	Picture Folder.....	71
Auto Display	49	Records Menu Structure.....	72
Text Entry	50	Records	73
Shift mode.....	51	Troubleshooting	74
Tegic	51	Important Error Messages	76
Text Input	51	Glossary of Terms	79
Phone Option Menu Structure	53	Accessories	81
Phone Option	54	Personal Settings	82
Call Service.....	54	Index	84
Call Divert.....	57		
Security	58		

Getting Started

Some services detailed, are network dependent or may only be available on a subscription basis. Some functions are SIM dependent. For more information contact your service provider.

Inserting and Removing the SIM

The SIM is inserted under the battery.

Inserting the SIM

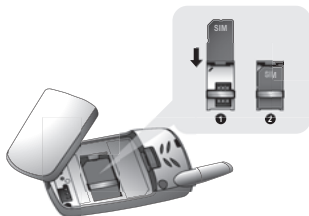

Removing the SIM

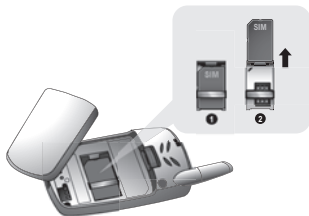

Attaching and Removing the Battery

Before removing the battery, ensure that the phone is switched off and the charger is disconnected from the phone.

Attaching the battery



Removing the battery

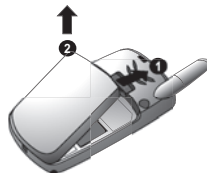

Charging the Battery

Connecting and disconnecting the Fast Travel Charger

The battery must be fitted in the phone before the charger is connected. Insert the charger into the Charging Connector and connect the travel charger to the socket-outlet. Then the Battery Level Indicator will start scrolling. It is recommended to charge the battery for a minimum of 4 hours before first use.

NOTE: DO NOT force the connector as this may damage the phone and/or the charger. If the battery has been deeply discharged it may take some time until the charge indicator is displayed.



When charging is complete disconnect the charger from the wall socket before removing the plug from the phone.



Operation of Battery Level Indicator

	While charging	Charging complete
Phone on		
Phone off		

NOTE: When the battery is deeply discharged, it may take some time (2 to 3 minutes) until charging starts.

Low Battery Power Warning

When the battery power is low, **Battery Is Low** message will be displayed. If this occurs during conversation, finish your call immediately. The power will automatically switch off after the warning tone. Fully recharge the battery. See "Charging the Battery" on this page. (Calls can be made and received while the phone is charging.)

Keys & Displays



Keys

Key	Function
	Navigation Key: Scroll or move through menus, text and contacts. In idle mode, press to enter to the Shortcuts.
	Left Softkey: Perform the functions displayed above the key. In idle, press and hold to enter to the SMS menu.
	Right Softkey/Cancel or Exit key: Perform the functions displayed above the key. Mainly used to cancel and returned to the previous menu level, or to delete text/number entries. In idle, press and hold to enter the Profiles menu.
	Numeric key pads: Enter numbers. Press and hold one of the keys from to to make a Speed Dial. In text entry mode, enter text, numbers and characters. Press and hold to enter a "+" or "P". When you need to dial an extension number, dial the phone number first and press and hold to add a "P" then enter the extension number.
	Send Key: Make a call or answer a call. In idle mode, check the last dialled list.
	Power/End Key: End/reject a call. During key operation, press to return to the previous display. In idle mode, press and hold to switch phone on/off. In Browser mode, press and hold to end Browser mode.
	Asterisk Key: In idle, press and hold to activate Browser.
	Quiet Mode Key: In idle, press and hold to switch the Mute Mode on and off.

Display



NOTE: All screen images in the manual are simulated.

Status Icons

The status icons are displayed or animated according to the currently activated functions. The Antenna, Signal and Battery icons are displayed when the handset is switched on and connected to a network. In the occasion of that network level is zero, the network icon will not be displayed.

Icon	Indication
	Registered to a non-home network - roaming
	Call divert is on
	Vibration alert is on
	Silent Mode is on
	Message area is full
	Unread message is stored
	Key Guard is enabled
	Voice memo (SIM dependent)
	Indicates it is possible to make emergency call
	SIM supports CPHS and Line1 is selected in Phone Option menu
	Signal strength
	Battery full level:
	- low battery
	Alarm is set
	GPRS is active
	New voicemail message is received

Symbols Used in the Manual



Press the Navigation key in the direction indicated by the arrow.



Press Left Soft Key.



Press Right Soft Key.



Press numeric key pads.



Press to answer a call or call a dialed number.



Press to end a call or long press to switch the phone on/off.

Menu Display



The menu system provides the means for accessing the functions which do not have their own dedicated buttons on the keypad.

Entering to the Menu Display

From **idle screen**

1  (Menu)

The main menu display has 9 menu options.
(See "Menu Structure" on page 6.)

2  required menu  (Select)

OR

pressing a numeric key will access a menu option directly.

Back to the Menu Display

 repeatedly until the display goes back to the Menu display.

Menu Structure

The 9 main menus are as follows.



My Phone

- 1 Sounds
- 2 Display
- 3 Language
- 4 Alert Type
- 5 Profiles
- 6 User Messages
- 7 Auto Answer
- 8 Any Key Answer
- 9 Reset Defaults
- 10 Shortcuts
- 11 My Phonebook
- 12 T9 Input



Games (or STK)*

- 1 Fillip
- 2 Classic rally



Phone Book

- 1 Browse
- 2 Create
- 3 Group Settings
- 4 Memory Status
- 5 My Numbers
- 6 Hot Key Dial
- 7 My Phonebook



Browser

- 1 Start Browser
- 2 Bookmarks
- 3 Settings



Key Guard



Messages

- 1 Create
- 2 Inbox
- 3 Outbox
- 4 Archive
- 5 User Messages
- 6 Memory Status
- 7 Options
- 8 Broadcast



Phone Option

- 1 Call Service
- 2 Call Divert
- 3 Security
- 4 Network
- 5 CSD Setting
- 6 GPRS Setting
- 7 GPRS Info



Applications

- 1 Games
- 2 (STK)*
- 3 Scheduler
- 4 Clock
- 5 Calculator
- 6 Currency
- 7 Melody Composer
- 8 Sound Folder
- 9 Picture Folder



Records





- 1 Last Dialed
- 2 Answered
- 3 Unanswered
- 4 Erase Records

*STK(SIM Tool Kit) is SIM dependent.

Shortcut from Idle Screen







It is possible to enter the function directly from the Idle screen by pressing a key.

Short press

Key	Function
	Menu
	Phonebook* (Names)
	Shortcuts
	Last dialled record list

*The Phone must be registered with a network.

Long press



Key	Function
	Hot key dial
	Browser*
	Silent mode
	Profile menu
	Power on/off
	Message Menu

*The Phone must be registered with a network.

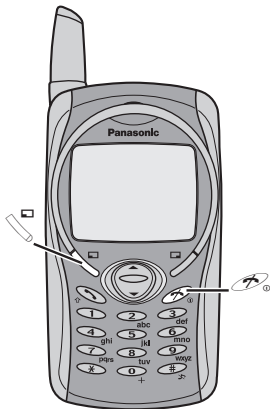
Phone Basics



Phone ON/OFF

- 1 Press and hold  for 2 to 3 seconds.
- 2 Phone will display Idle mode.
- 3 Press and hold  again to turn the power off.

Displaying Menu

From idle mode

 to access Menu

Menu will be displayed.

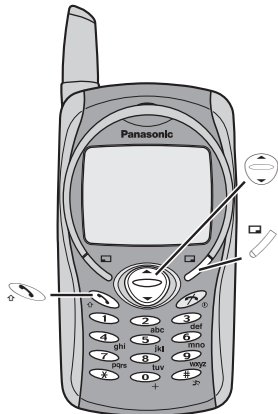

(Menu may change depending on your SIM.)



Making Calls

- To make a call, start in Idle mode.

Standard Dialling



- 1 Enter phone number 
 - The dialled number is displayed.
- 2 When the other party answers, talk into the Microphone.
- 3 To hang up, 
 - The length of the call is displayed.
 - When **Max Cost** is on, the remaining units will be displayed.

For setting the **Max Cost**, see "Setting the Maximum Cost:" on page 56.

Earpiece Volume:

During a call;  to adjust earpiece volume

Phonebook Dialling

- 1  (Names)
- 2  required contact 



Last Number Dialling

- 1
- 2 required contact

International Dialling

The international access code (+) and the destination country/region code should be entered, followed by the area code and phone number.

- 1 Press and hold until "+" is displayed then enter country/region code.
- 2 Enter area code and phone number

NOTE: Many countries/regions include an initial "0" in the area code. This should, in most cases, be omitted when dialling international numbers. If you have difficulties making international calls, contact your service provider.

Emergency Call

To make an emergency call, the antenna () must be present.

When SIM is inserted;

enter emergency number 112

When SIM is not inserted;

enter emergency number 112

OR

(SOS) > "Emergency Call" (Yes)

NOTE: Making Emergency calls without a SIM is country or network operator dependent.

Answering Calls

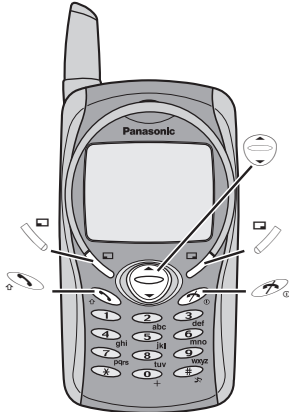

OR

When "Any Key Answer" is ON,





From Idle menu

press any key except 

(See "Setting Any Key Answer" on page 25)

Ring Volume:

From **My Phone** menu

- 1  **Sounds > Volume**  (Select)
- 2  Adjust the volume level  (OK)

Quick Touch Silent Mode:

To quickly set the ring tone off and the vibrator on, press and hold  in idle mode.

-  and  will be displayed on the idle screen.

One Click Mute on Incoming Call:

To set the ring tone and the vibrator off,

- 1  (Mute)



If you want to reply the call,



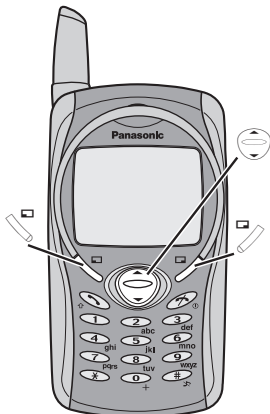



- 2  (Reply)

- If you want to reject the call,  (Reject).



In-Call Options

During a call,  (Menu) or  (Hold)



 (Menu)	Hands Free	Switch to Desktop Hands Free .
	Conference	Enable to make a conference call. You can talk with up to 5 parties.
	Call Transfer	Connect your calling party to the other party you are holding, then disconnect your line. (SIM dependent)
	Phone Book	Open SIM Phonebook or Mobile Phonebook.
	Messages	Create, check and send a message while you are talking. - see "Messages" on page 42.
 (Hold)	Call Status	 (End) to disconnect a line with the activating party.  (Hold) to put a call on hold with the activating party. To resume,  (Back) again.
	Hold	Put a call on hold. To resume,  (Back). (SIM dependent)

Desktop Handsfree

Desktop Handsfree allows you to hold a conversation without holding the phone to your ear.



NOTE: Do NOT hold the phone to your ear in Handsfree mode.

During a Handheld call:

-  (Menu)
-  **Hands Free**  (Select)

NOTE: You can also switch between Handheld and Handsfree by pressing and holding  .

To return to Handheld call:

 (Menu) >  (Select) to revert for Handheld operation

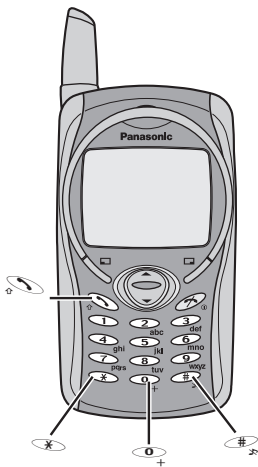

DTMF Tones

DTMF tones can be sent during conversation. These are often used to access voice mail, paging and computerised home banking. For example, you may need to input a number to access voice mail messages. A phone number may be stored in Phone Book with DTMF tones, allowing the number to be dialled upon recall and the DTMF number to be sent automatically.

Send DTMF Tones During a Call:

Enter digits (0_+ ~ 0_{wxyz} , $\#_z$, $*_z$)

Pause Dial

Using pauses allows you to send DTMF tones automatically.

- 1 Enter phone number.
- 2 Press and hold 0_+ until a **P** is displayed at the end of the phone number entered.
- 3 Enter DTMF digits after the pause, e.g. enter the number to access voice mail messages.
- 4 

When the call is connected DTMF tones will be sent after 3 seconds.



Incoming Call While in a Call

NOTE: Call waiting must be on - see "Setting Call Waiting" on page 54. Call waiting is network dependent.

During a call, you may receive another call:

- To answer another call, (First call is placed on hold.)
To disconnect another call, (Reject)
- During a conversation with a second caller, (Menu) or (Swap) and select one from the following options:

(Menu)	Hands Free	Switch to Desktop Hands Free .
	Conference	Enable to make a conference call. You can talk with up to 5 parties.
	Call Transfer	Connect your calling party to the other party you are holding, then disconnect your line. (SIM dependent)
	Phone Book	Open SIM Phonebook or Mobile Phonebook.
	Messages	Create, check and send a message while you are talking. - see "Messages" on page 42.
(Swap)	Call Status	(End) to disconnect a line with the activating party. (Hold) to put a call on hold with the activating party. To resume, (Back) again.
	Swap	Switch between two connected calls.

To end a conference call and all connections:

Making a Second Call

During a call:

Enter second phone number or recall it from Phone Book . The first call is put on hold.

NOTE: Making a second call is network dependent.

My Phone Menu Structure

My Phone

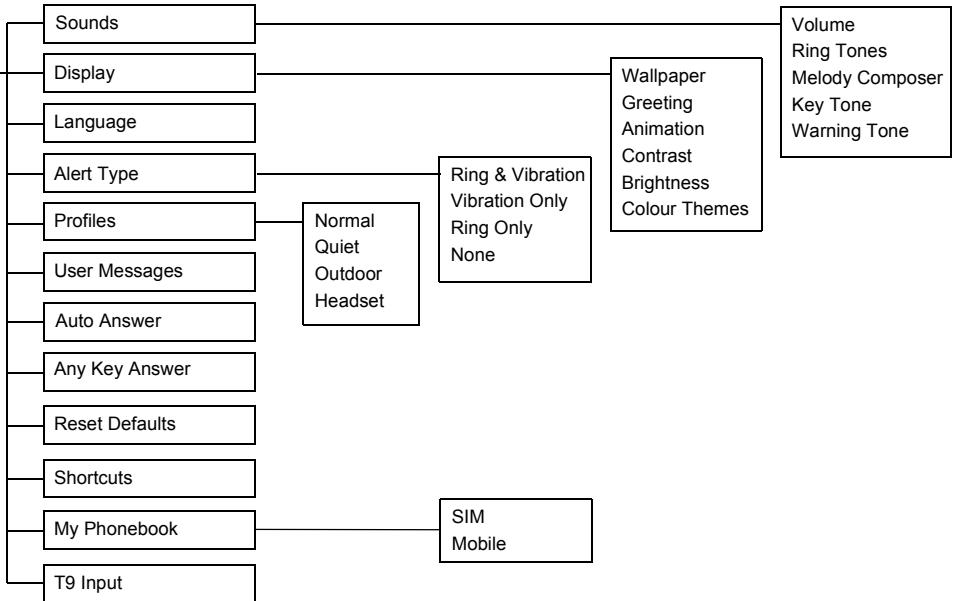







My Phone

Sounds









Changing the Volume

From **My Phone** menu

- 1  **Sounds**  (Select)
- 2  **Volume**  (Select)
- 3  Adjust the volume level  (OK)

Changing the Ring Tone

From **My Phone** menu

- 1  **Sounds**  (Select)
- 2  **Ring Tones**  (Select)
- 3  **Any Call, Group Calls, Alarm or Messages**  (Select)
- 4  required ring tone  (Select)

Composing a Melody

From **My Phone** menu

- 1 **Sounds** (Select)
- 2 **Melody Composer** (Select)
- 3 required MyMusic (Menu)
- 4 **Edit** (Select)
- 5 required track (Menu)
- 6 Compose your melody - See the notes chart below > (Menu)
- 7 **Save** (Select)

You can arrange the **Tempo** and select an instrument (**Select Instrument**) before saving.











Using the following table as reference, enter notes (from the choice of low, middle and high), rests, and duration to generate your composition.

Main Track and Sub Tracks are combined when you return to **MyMusic**.

Key	1	2 abc	3 def	4 ghi	5 jkl	6 mno	7 pqrs	8 tuv
Func	C	D	E	F	G	A	B	Rep.
Key	9 wxyz	0 +	X	# .				
Func	Dotted note	Rest	Duration	Low # Middle # High #				









Rename a melody:

From My Phone menu

- 1  **Sounds**  (Select)
- 2  **Melody Composer**  (Select)
- 3  required music  (Menu)
- 4  **Rename**  (Select)
- 5 Enter a name
 - To erase a letter,  (Clear).
 - To erase all letters, press and hold  (Clear).
- 6  (OK)









Set to Ringtone:

From My Phone menu

- 1  **Sounds**  (Select)
- 2  **Melody Composer**  (Select)
- 3  required music  (Menu)
- 4  **Set to Ringtone**  (Select)

Viewing a melody information:

From My Phone menu

- 1  **Sounds**  (Select)
- 2  **Melody Composer**  (Select)
- 3  required music  (Menu)
- 4  **Info**  (Select)

Setting Key Tone.....

From **My Phone** menu

- 1  **Sounds**  (Select)
- 2  **Key Tone**  (On/off)

Setting Warning Tone.....

From **My Phone** menu







- 1  **Sounds**  (Select)
- 2  **Warning Tone**  (On/off)

Display

You can change the wallpaper in idle mode.

Setting Wallpaper.....







From **My Phone** menu

- 1  **Display**  (Select)
- 2  **Wallpaper**  (Select)
- 3  required Wallpaper  (Select)
- 4  (On/off)

You can create a greeting message that is displayed each time the phone is powered on.

Setting Greeting







From **My Phone** menu

- 1  **Display**  (Select)
- 2  **Greeting**  (Edit)
- 3 Enter the Greeting  (OK)
- 4  (On/off)

You can change animation that comes up on the display when the phone is switch on.







Setting Display Animation

From **My Phone** menu

- 1  **Display**  (Select)
- 2  **Animation**  (Select)
- 3  required Animation  (Select)

Setting Display Contrast.....

From **My Phone** menu

- 1  **Display**  (Select)
- 2  **Contrast**  (Select)
- 3  Adjust the contrast  (OK)

Setting Brightness.....







From **My Phone** menu

- 1  **Display**  (Select)
- 2  **Brightness**  (Select)
- 3  required level  (Select)

You can change the Colour Themes on the display.

Setting Colour Themes

From **My Phone** menu





- 1  **Display**  (Select)
- 2  **Colour Themes**  (Select)
- 3  required colour  (Select)

Language

It is possible to change the language that the phone uses for display messages.

Changing the Language

From **My Phone** menu

- 1  **Language**  (Select)
- 2  required language  (Select)

When required, the phone can be set up to vibrate and/or ring when a call is received.

You can change Alert Type:

- **Ring & Vibration**
- **Vibration Only**
- **Ring Only**
- **None**

You can switch between four profiles in your phone each with a distinct combination of alert method, ring tone, etc.

Profiles are set up for use in different environments – for instance you might want to create **Normal** profile for everyday setting, **Quiet** profile with ring tone appropriate for formal occasions, **Outdoor** profile for loud environments and **Headset** profile with vibrator when it is difficult to hear the ring tone.

Alert Type

Changing Alert Type.....





From **My Phone** menu

- 1  **Alert Type**  (Select)
- 2  required Alert type  (Select)

Profiles

Activating a profile.....











From **My Phone** menu

- 1  **Profiles**  (Select)
- 2  required profile  (Menu)
- 3  **Activate**  (Select)

Editing profiles.....









Ring Volume

From **My Phone** menu

- 1  **Profiles**  (Select)
- 2  required profile  (Menu)
- 3  **Change Settings**  (Select)
- 4  **Ring Volume**  (Select)
- 5  Adjust volume level  (OK)









Key Tone

From **My Phone** menu

- 1  **Profiles**  (Select)
- 2  required profile  (Menu)
- 3  **Change Settings**  (Select)
- 4  **Key Tone**  (On/off)









Warning Tone

From **My Phone** menu

- 1  **Profiles**  (Select)
- 2  required profile  (Menu)
- 3  **Change Settings**  (Select)
- 4  **Warning Tone**  (On/off)

Vibrator

From **My Phone** menu

- 1  **Profiles**  (Select)
- 2  required profile  (Menu)
- 3  **Change Settings**  (Select)
- 4  **Vibrator**  (On/off)

BrightnessFrom **My Phone** menu

- 1 **Profiles** (Select)
- 2 required profile (Menu)
- 3 **Change Settings** (Select)
- 4 **Brightness** (Select)
- 5 **Medium, High, Maximum or Low** (Select)

User Messages**Editing User Messages**From **My Phone** menu

- 1 **User Messages** (Select)
- 2 required message or empty space (Select)
- 3 Enter your message (Menu)
 - To erase a letter, (Clear).
 - To erase all letters, press and hold (Clear).
- 4 **Save and Send** or **Save** (Select)
- 5 When **Save and Send** is selected, enter destination phone number (OK)



NOTE: If the text is wider than the screen display, the text will scroll.

There are 10 pre-set common user messages and 5 empty spaces to create your own messages. You can also set User Messages at **User Messages** in **Message** menu. - see "Editing User Messages" on page 43.

Auto Answer

Auto Answer can be set on. For use this function, Personal Handsfree Earpiece needs to be connected to the phone.



Setting Auto Answer

From **My Phone** menu
 **Auto Answer**  (On/off)

Any Key Answer

Calls can be answered by pressing any key (except ).





Setting Any Key Answer

From **My Phone** menu
 **Any Key Answer**  (On/off)

Reset Defaults

All personal settings can be returned to their factory default settings.

Reset Defaults

From **My Phone** menu
1  **Reset Defaults**  (Select)
2 **“Restore Factory Settings?”**  (No) or  (Yes)

Shortcuts can be selected from the following options:

Browser, Games, Phone Book, Language, Alert Type, Sounds, Wallpaper, Profiles, Alarm, Calculator, Scheduler, Inbox, Create, Clock Setting and Currency

Shortcuts

Setting Shortcuts

From **My Phone** menu

- 1  **Shortcuts**  (Select)
- 2  required shortcuts  (On/off)

Access to Shortcuts:

From Idle mode





-  required shortcuts  (Select)

You need to select between SIM Phonebook or Mobile Phonebook for your ordinary use. You can also set My Phonebook at **My Phonebook** in **Phonebook**.
- see "My Phonebook" on page 35.

My Phonebook

Setting SIM or Mobile Phonebook.....









From **My Phone** menu

- 1  **My Phonebook**  (Select)
- 2  **SIM or Mobile**  (Select)

T9 Input

Setting T9 Input.....

From **My Phone** menu

- 1  **T9 Input**  (Select)
- 2  Set **T9 Prefer** on  (On/off)
- 3  **Input Language**  (Select)
- 4  required language  (Select)

See "Shift mode" on page 51 for detail.

When you create a text, this function helps to dramatically reduce the number of key presses.

Games Menu Structure

Games (or STK)*

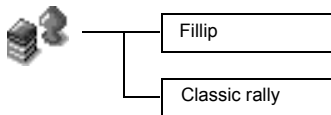

* STK (SIM Tool Kit) is SIM dependent.



Games

The parts are scattered far and wide and some are stuck in the treetops where aggressive mosquitoes and grouchy birds live, and some have fallen into the water, where they are guarded by fierce piranhas.

The car can slide in the turns if you drive too fast and behaves like a real car. Drive your car as fast as you can. When you pass all the stations, you will get a score.

Selecting Games

From **Games** menu

 required game  (Select) from **Fillip** and **Classic rally**.





NOTE: Once the power is turned off, High scores or Best scores are lost.

Fillip

Key Operation:



 (move left),  (move right), 1  (jump),  (jump left),  (jump right).

Starting Games:









Select **Start game** by using  (or  (Up) and  (Down)), then  (Select).

Classic rally

Key Operation:

 (Forward),  (Turn Left),  (Turn Right),  (Backward) to move the car.

Starting Games:

- 1 Select Start Game by pressing any numeric key except 
- 2 To choose your car,  (or  or ), then  (Select).
To choose a race course,  (or  or ), then  (Select)

NOTE: If SIM card provides SIM Tool Kit services, this menu will become the STK Menu. You can still access Games from Applications.

Phone Book Menu Structure

Phone Book

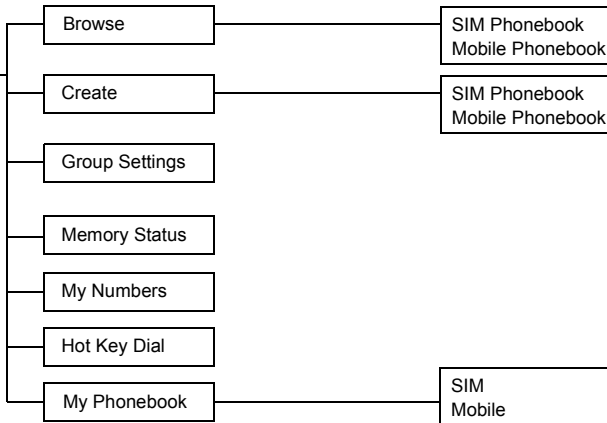

Phone Book

Storing

Phone numbers can be stored in SIM or in your phone.

In the SIM, you can store or select:

- Phone number
- Name

If you want to store a fixed dial number, see "Storing a Fixed Dial Number" on page 31.





In the phone, you can store:

- Name
- 3 Phone Numbers (Phone, office, mobile)
- Caller's ID
- Groups
- Melodies

The entries can be grouped together and these are retained even if you damage the SIM.

Storing a Number in SIM.....



















From **Phone Book** menu

- 1  **Create**  (Select)
- 2 **SIM Phonebook**  (Select)
- 3 Enter **Name**  > **Phone**
- 4  (Save)
 - "Saved in SIM" is displayed.

NOTE: The length and amount of data is SIM dependent.

Storing a Number in Mobile Phonebook.....

From **Phone Book** menu

- 1  **Create**  (Select)
- 2  **Mobile Phonebook**  (Select)
- 3 Enter **Name** 
- 4 Enter Phone number (**Phone, Tel./office, Tel./mobile**) 
- 5  (Set)  required **Caller's ID Image**  (Select) 
- 6  (Set)  required group  (Select) 
- 7  (Set)  required melody  (Select)
- 8 When entries are completed,  (Save)
 - "Saved in Mobile" is displayed.











Fixed Dial is one of the function in SIM Phonebook. Only the numbers stored in FDN can be dialled.

To activate this function, you need to set Fixed Dial on. - see "Setting Fixed Dial" on page 60.

Storing a Fixed Dial Number

To store a fixed dial number, you need to enter PIN2 code.

From **Phone Book** menu





- 1  **Create**  (Select)
- 2 **SIM Phonebook**  (Select)
- 3 Enter **Name**  > **Phone number**
- 4  **Location**  (Set)
- 5  **FDN**  (Select)
- 6  (Save)
- 7 Enter PIN2 code
- 8  (OK)

You can search Phonebook by name.

Viewing





Browsing the Phone Book.....

From **Phone Book** menu

- 1  **Browse > SIM Phonebook or Mobile Phonebook**  (Select)
- 2  Search the name you wish to browse  (View)

Options in Phone Book

From **Phone Book** menu

- 1  **Browse > SIM Phonebook or Mobile Phonebook**  (Select)
- 2  required contact  (Menu)





The following options are available by pressing  (Select)

Edit	Edit the selected Phone Book entry.
Delete	Delete the selected Phone Book entry.
Delete All	Delete all Phone Book entries.
Copy to Mobile/SIM	Copy a contact to Mobile/SIM Phonebook.
Copy All to Mobile/SIM	Copy all Phone Book to Mobile/SIM Phonebook.
Search	Search for a desired item in Mobile/SIM Phonebook by entering the name.

Group Settings

You can categorize the items stored in the Mobile Phonebook into 5 groups; **Friends, Colleagues, Family, Others** and **VIP**. You can select a particular ring tone for each group to identify the incoming call.

From **Phone Book** menu

- 1  **Group Settings**  (Select)
- 2  required **Group**  (Menu)

The following options are available by pressing  (Select).

View Group	View Phone Book entry in the selected group.
Set Ring Tone	Set required ring tone.
Remove Entries	Delete all Phone Book entries in the selected group.

After selecting required **Group** in step 2, you can view a Phone Book entries by pressing  (View).

When there is no entry has been stored in the selecting group, "List Empty" is displayed.



The following options are available by pressing  (Menu).

Edit	Edit the selected Phone Book entry.
Delete	Delete the selected Phone Book entry.
Search	Search for a desired item in the selected group by entering the name.

Memory status shows how many locations are available in the Phone Book.

Memory Status









Viewing Memory Status.....

From **Phone Book** menu
 **Memory Status**  (Select)





My Numbers

My Number is a handy phonebook where your names and phone numbers can be stored and viewed.

Setting My Numbers.....

From **Phone Book** menu
 1  **My Numbers**  (Select)
 2  required entry  (Menu)
 3  **Edit**  (Select)
 4 Enter your phone number 
 5 Enter your name  (Save)

Viewing My Numbers

From **Phone Book** menu
 1  **My Numbers**  (Select)
 2  required entry  (View)

Phone numbers stored at locations 001 - 009 in the Phonebook can be dialled quickly.

Hot Key Dial

Setting Hot Key Dial

From **Phone Book** menu

 **Hot Key Dial**  (On/off)

NOTE: This function is available only when a SIM is installed.

Making a Call by Using Hot Key Dial





From **Idle** mode

- 1 Press and hold a digit key (1~9)
- 2 Press 

My Phonebook

You need to select between SIM Phonebook or Mobile Phonebook for your ordinary use.

From **Phone Book** menu

- 1  **My Phonebook**  (Select)
- 2  **SIM** or **Mobile**  (Select)

- Please refer to “My Phonebook” on page 26.

Browser Menu Structure

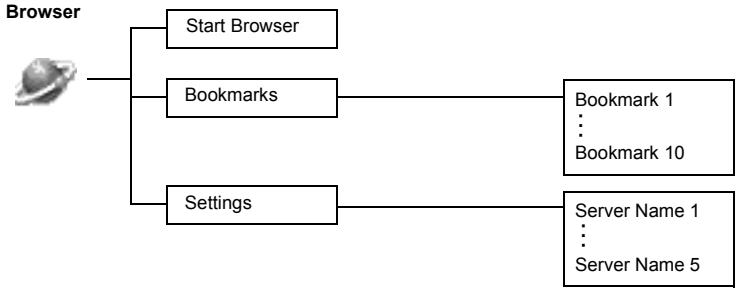

Browser





Server Setting

The phone's WAP (Wireless Application Protocol) Browser enables you to access Internet services supported by the network, such as news, weather reports, sport etc.

Before Internet services can be accessed, you need to subscribe to your network operator or Internet Service Provider (ISP) to enable the relevant configuration information. Please contact your network service provider to ensure that your network settings are correct.

NOTE: Modifying previously entered settings can cause failure of the Browser.

From **Browser** menu

- 1  **Settings**  (Select)
- 2  to select required server  (Edit)

Five server settings can be set up in the phone. If you find your server's name under the settings option, select the server and  (Edit). If no settings are present contact your Network Service Provider for these settings. (Sever Name, IP Address, IP Port, Homepage, Linger Time, Select Mode)

NOTE: You need to set **CSD Setting** or **GPRS Setting** in Phone Option before setting the server information.





Those configuration Options will be given by your network service provider.

Once completing the entry, press  (Save) then press  (Activate).

The first time that the browser is activated there will be no content stored so the Home URL content will be displayed (as defined by the network operator). The Home URL will be recalled from the cache, each time the browser is activated. (Cache is the phone's memory that stores content downloaded in the past).

WAP Activating

From **Browser** menu

- 1  **Start Browser**  (Select)
- 2 Please follow to the instructions on the display.
 - While browsing a homepage, press  and you can select the following menus.
 - To end Browser, press and hold .

Home	Jump to the homepage which is set in Settings .
Bookmarks	Select one from your setting bookmarks and jump.
Save Items	Save items in your browsing homepages.
Reload	Reload the browsing homepage.
Go To URL	Enter a URL and jump to the homepage.
Show URL	Display the URL of the browsing page.
SnapShots	Capture the screen of your browsing page.
Advanced	Inbox , Restart Browser and About are available to select.
Settings	Scroll Mode , Downloads , Security and Send Referrer are available to set.







Once you bookmark your favourite page, you can quickly jump to the page.

Bookmarks





Setting Bookmark

Entering URL from Browser menu:

From **Browser** menu

- 1  **Bookmarks**  (Select)
- 2  required empty Bookmark  (Menu)
- 3  **Edit**  (Select)
- 4 Enter Title and URL  (Save)

Setting Bookmark from Homepage:

- 1  >  **Bookmarks**
- 2 **Mark Site** 
- 3 Enter **Folder** and **URL**
- 4  (Save)

Browsing Bookmark

From **Browser** menu



- 1  **Bookmarks**  (Select)
- 2  required Bookmark  (Launch)

Key Guard

The Key Guard function is used to prevent any keys from being accidentally pressed e.g. when the phone is being carried.

Setting Key Guard

From **Key Guard** menu

 (Yes) or  (No)

- When Key Guard is enabled, **On** appears on the display.
- Emergency calls still can be made.
- When a call is received Key Guard will be disabled temporarily, then you can answer the call.

NOTE: When making emergency calls with the “Key Guard” enabled, there will be no visual indication that the number is being dialled.

Disabling Key Guard

When **On** appears on the display,

- 1  (Free)
- 2 “**Press OK to Free keypad**”  (OK)

Messages Menu Structure

Messages

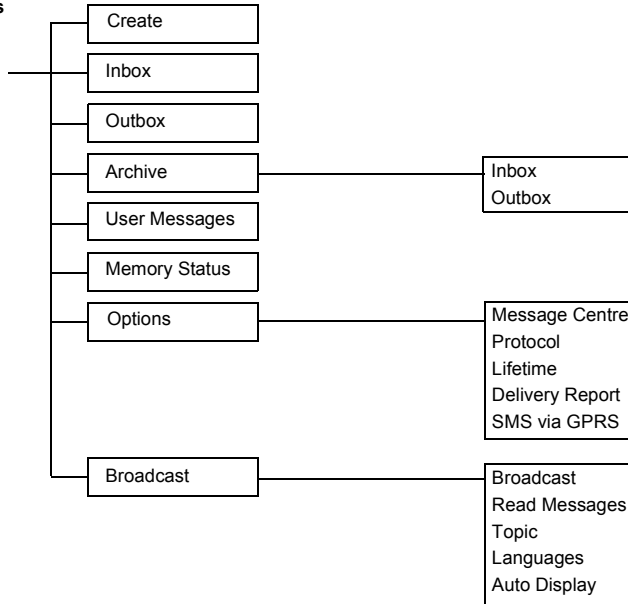



Messages

It is possible to receive, display, edit and/or send text messages of up to 1520 characters in ten messages (depending on language), to the network that has a roaming agreement (depending on the recipient's phone Options). Before sending a message, you need to enter the Message Centre number into Options.

SMS

Setting the Message Centre Number











From **Messages** menu

- 1  **Options** > **Message Centre**  (Select)
- 2 Enter message centre number in international dial format
(see "International Dialling" on page 10)  (OK)

NOTE: Your network operator may have pre-installed the number. Do not change this number as it may cause failure of SMS Messaging.

Creating a New Short Text Message

From **Messages** menu



- 1  **Create**  (Select)
- 2 Create your text message – max. 1520 characters
(see "Text Entry" on page 50)  (Menu)
- 3  **Send**  (Select)
- 4 Enter the destination phone number  (OK)
OR
Recall a number from the Phonebook  (Names) >
 required name  (Select) >  (OK)

When you create a text, these options are available by  (Menu).

Send	Send a text as Short Text message.
Save	Save a text in Outbox in SIM.
Save and Send	Save a text in the Outbox in SIM and send.
Picture & Sound	Add picture and/or sound to a text.
User Messages	Use a short message stored in the phone. For editing the User Message, see "Editing User Messages" below.

Editing User Messages

From **Messages** menu

- 1  **User Messages**  (Select)
- 2  required message  (Select)
- 3 Edit the message  (Menu)
 **Save and Send** or **Save**  (Select)

NOTE: When the text is wider than the screen display, the text will scroll.

When a Short Text Message is received, the message indicator will flash on the display and a user preset audible alert will sound. If you are in a call you will be alerted by the vibrator.

 flashes when an unread message is received in the Inbox.

When the Inbox is full,  will remain until old messages are deleted.

Reading a Received Message

From **Messages** menu

- 1  **Inbox**  (Select)
- 2  required message  (Read)

- **Inbox:** The received message will be stored in **Inbox**.

NOTE: If the message indicator is displayed constantly (does not flash), this means that the message area is full and you need to delete old messages in order to receive new messages.

While you are reading a message, the following options are available by  (Menu).





Delete	Delete a message.
Reply	Create a replying SMS.
Forward	Forward a message to another phone.
Edit	Edit a message and save and/or send to another.
Delete All	Delete all messages in Inbox.
Extract Number	Extract numbers in messages and save in Phonebook.
Move to Archive	Move a message into Inbox in Archive.
Hyper Link	Link to a URL in a received message.

Viewing Message Lists in Outbox

To view message lists that are stored in SIM.

- Outbox: The transmitted message will be stored in **Outbox**.

From **Message** menu

- 1  **Outbox**  (Select)
- 2  required message  (Read)

While you are reading a message, the following options are available by  (Menu).





Delete	Delete a message.
Edit	Edit a message and save and/or send to another.
Send	Send a SMS message after entering a recipient number.
Delete All	Delete all messages in Outbox.
Extract Number	Extract numbers in messages and save in Phonebook.
Move to Archive	Move a message from Outbox to Outbox in Archive.

Viewing Message Lists in Archive

To view message lists which are stored in Archive.

- **Inbox:** When a message in Inbox is saved, the message will be saved to **Inbox in Archive**.
- **Outbox:** When a transmitted message in Outbox is saved, the message will be saved to **Outbox in Archive**.

From **Message** menu

- 1 **Archive**  (Select)
- 2  **Inbox/Outbox**  (Select)
- 3  required message  (Select)

While you are reading a message, the following options are available by  (Menu).

Delete	Delete a message.
Edit	Edit a message and save and/or send to another.
Forward (Inbox)/ Send (Outbox)	Forward/Send a message to another phone.
Delete All	Delete all messages in Inbox.

Memory status shows how many locations are left to store messages in the Inbox.

Viewing Memory Status

From **Messages** menu

- 1  **Memory Status**  (Select)

Options

Setting Options

From **Messages** menu

 **Options**  (Select)

NOTE: In the area where GPRS is not supported, SMS may not be sent when **SMS via GPRS** is on.

The following options are available:

Message Centre	Edit Message Centre number.
Protocol	Select required Message Type from Standard Text, Fax, X.400, Paging, E-mail, ERMES, Voicemail.
Lifetime	Select maximum or choose a time limit for sending messages.
Delivery Report	Request a delivery report on the status of a sent message.
SMS via GPRS	Send a Short Text message via GPRS.

You can receive your favourite information regularly from your service provider.

You need to specify the "topic(s)" of information and the language that you wish to receive. To receive the broadcasts, "Broadcast" needs to be on.

Any topics will not appear without your registration.

Any topics will not appear without your registration.

Broadcast







Setting Broadcast.....

From **Messages** menu

- 1  **Broadcast**  (Select)
- 2  **Broadcast**  (On/off)











Setting Topic.....

From **Messages** menu

- 1  **Broadcast > Topic > Current >**  (Select)
- 2  required **Topic**  (Menu)
- 3  **Add or Delete**  (Select)

Setting User defined Topic

From **Messages** menu

- 1  **Broadcast > Topic > User Defined > <New entry>**  (Select)
- 2 **Enter Msg ID**  (OK)
- 3 **Enter Name**  (OK)
- 4  **Current**  (Select)
- 5  **<Add Topic>**  (Select)
- 6  required **Topic**  (Select)

Setting Language.....

From **Messages** menu

- 1 **Broadcast** (Select)
- 2 **Languages** (Select)
- 3 required Language (Select)
- 4 To continue to add languages;
 Insert (Select)
To complete adding language;
 Add to End (Select)

Viewing Broadcast.....

From **Messages** menu

- 1 **Broadcast > Read Messages** (Select)
- 2 To scroll to the available topics (Next)

NOTE: This function depends on your Network Service Operator.

Auto Display

Setting Auto Display

From **Messages** menu

- 1 **Broadcast** (Select)
- 2 **Auto Display** (On/off)

In idle mode, the latest Info Message is displayed on your phone automatically.

Text Entry

You can use alphanumeric characters to enter details into the Phonebook, to create text, etc.

Key	Text Mode		Numeric
	T9®(T9Abc, T9abc, T9ABC) (Input language: English)	Multi tap (Input mode indicator: Abc, abc or ABC)	(0 ~ 9)
	Punctuation 1	Space 0 . , ? ! + - = : ; ' " ' ; _	0
	Punctuation 2	1 / () < > [] { } % ~ & (1 / () < > [] { } % ~ £ &)	1
	A B C (a b c)	A B C 2 Ä (a b c 2 ä à ç)	2
	D E F (d e f)	D E F 3 É (d e f 3 é è)	3
	G H I (g h i)	G H I 4 (g h i 4 ì)	4
	J K L (j k l)	J K L 5 (j k l 5)	5
	M N O (m n o)	M N O 6 Ö Ñ (m n o 6 ö ñ ò)	6
	P Q R S (p q r s)	P Q R S 7 (p q r s 7 ß)	7
	T U V (t u v)	T U V 8 Ü (t u v 8 ü ù)	8
	W X Y Z (w x y z)	W X Y Z 9 Æ Ø Å (w x y z 9 æ ø å)	9
	Shift mode	Shift mode	Shift mode
	* Γ Δ Θ Λ Ξ Π Σ Φ Ψ Ω	* Γ Δ Θ Λ Ξ Π Σ Φ Ψ Ω	*
	Alternatives / (Hold) Space # £ \$ ¥ ¢ @ \ § ^ _	Alternatives / (Hold) Space # £ \$ ¥ ¢ @ \ § ^ _	#

Note: Displayed characters of T9® vary depending on the selected input language.

Shift mode

Shift mode change

The Shift mode changes by pressing (within 1 sec)  .

Multi tap	Tegic
Abc -> abc -> ABC ->123	T9Abc -> T9abc -> T9ABC ->123

If Input mode is changed, Shift mode is initialised.

Auto capital change.....

Auto capital affects Abc and T9Abc.

When Input mode is changed to Abc or T9Abc, the first character is input as upper case and subsequent letters as lower case.

When one of the following characters [. (Period) or ! or ?] is input before a space, the next character is input as upper case.

Tegic

User Dictionary of Tegic

When edit mode is finished, all words in the editor are registered in User Dictionary of Tegic.

Text Input

To switch On/Off T9 mode, press  .







T9® Text Input

Using this mode of text input dramatically reduces the required number of key presses.

Press a key once for any letter you require on that key. The desired letter may not be displayed. Continue pressing other keys until the end of a word is reached; then check that the word has been typed correctly before continuing on to the next word. If the combination of letters typed has produced a word which is not the one you require, press  repeatedly until the correct word is displayed. Continue to the next word.

Example of Text Input in T9 Mode

To type a new message, follow these steps:

1. At the beginning of a new message press and hold  (Clear) to delete previous text, if necessary.
2. Press  to change letter case, if necessary
3. Press     "Call" is displayed.

Note that the displayed words change as you type, always type to the end of the word before editing.

T9® Languages can be selected from T9 Input -see "Setting T9 Input" on page 26.

If the word you require is not in the internal dictionary then it should be entered using the Multi tap (ABC) mode.

Other Text Modes

Select text mode (displayed in Information area on screen).

Multi tap mode (Abc, abc or ABC):

Each time a key is pressed in quick succession it displays the next character available on that key. Releasing the key or pressing another key enters the character displayed. The cursor moves to the next position.

In T9 (Abc) or Multi tap (Abc) mode, the first entered letter in a sentence is in upper case.

Phone Option Menu Structure

Phone Option

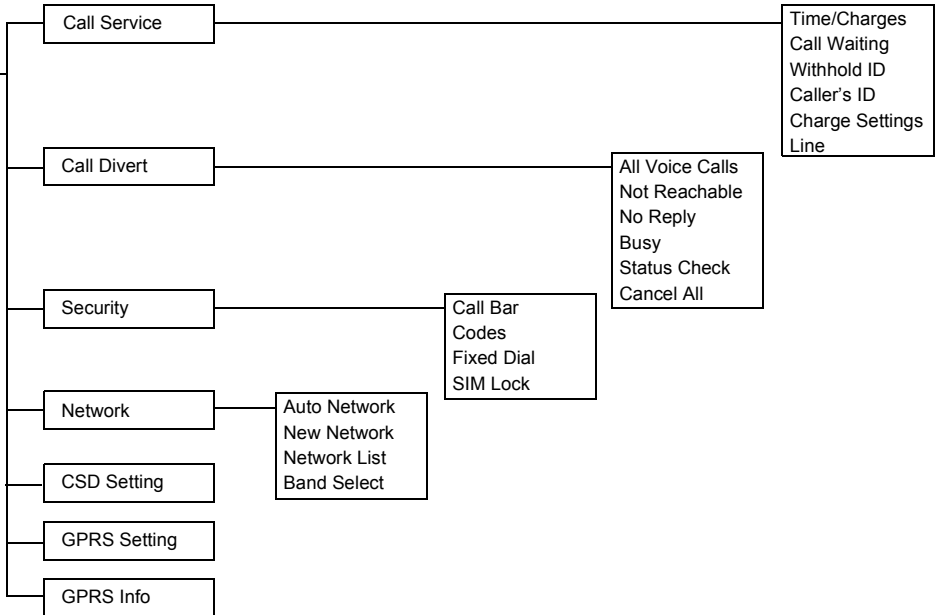

Phone Option

The duration of the **Last Call** and **All Voice Calls** will be displayed. When the **Max Cost** is on, the remaining units will be displayed.

Call Service

Viewing Time/Charges

From **Phone Option** menu



- 1  **Call Service** > **Time/Charges**  (Select)
- 2  required service **Last Call, All Voice Calls** or **Cost Left**  (Select)

Last Call	Display the duration of Last Call.
All Voice Calls	Display the sum of the duration for the all voice calls.
Cost Left	When Max Cost is on, display the remaining units. For setting the Max Cost , see "Setting the Maximum Cost:" on page 56.

When **Call Waiting** is switched on, a second call can be received.

Setting Call Waiting





From **Phone Option** menu

- 1  **Call Service** > **Call Waiting**  (Select)
- 2 **Set**  (Select)

Withhold ID allows you to prevent showing your name and/or number to your calling party. You can also select **Cancel** or **Check Status**.

Setting Withhold ID

From **Phone Option** menu



- 1  **Call Service**  (Select)
- 2  **Withhold ID**  (Select)

NOTE: When checking the status the phone must be registered with a network.

Caller's ID allows to display Caller's name and/or number on your display. You can also select **Cancel** or **Check Status**.

Setting Caller's ID

From **Phone Option** menu

- 1  **Call Service**  (Select)
- 2  **Caller's ID**  (Select)





NOTE: When checking the status the phone must be registered with a network.

Firstly, Personal rate must be entered. This is the cost that the Service Provider charges for one unit of call time.



Charge Settings

Setting Currency:

From **Phone Option** menu

- 1  **Call Service** > **Charge Settings**  (Select)
- 2  **Currency**  (Select)

Current Setting is displayed

- 3  (Set) > Enter PIN2 code  (OK)
- 4 Enter currency units (max.3 characters)  (OK)

NOTE: Charge Setting is SIM dependent.

NOTE: When you set the unit price, you will be asked to enter your PIN2.

NOTE: This function is SIM dependent.

You can set the maximum cost of calls allowed.

NOTE: The duration of one unit may vary between peak and off-peak times. Call charges can be calculated according to the calling time. However, the actual tariffs charged from your service provider may not be reflected in the calculation.

NOTE: This function is SIM dependent.

In Idle mode, the latest Incoming call is displayed on your phone automatically.











Setting Personal Rate:

From **Phone Option** menu

- 1  **Call Service** > **Charge Settings** > **Personal Rate**  (Select)
- 2  (Set)
- 3 Enter PIN2 code  (OK)
- 4 Press required personal rate  (OK)

Setting the Maximum Cost:

From **Phone Option** menu

- 1  **Call Service** > **Charge Settings**  (Select)
- 2  **Max Cost**  (Set)
 - Current setting is displayed.
- 3  (Edit) > Enter PIN2 code  (OK)
- 4  (Set) >  **On**  (Select)
- 5 Enter **Credit Limit** >  (OK)

Setting Auto Display:

From **Phone Option** menu

- 1  **Call Service** > **Charge Settings**  (Select)
- 2  **Auto Display**  (On/off)

This menu can be selected only when your SIM supports CPHS and Line 1/2.





NOTE: This function is SIM dependent.

Voice calls can be diverted using different situations and to different numbers. For example, you may wish voice calls to be diverted to voicemail box when the phone is switched off.

 appears when you have received new voice mail messages. This service depends on your service provider.

Setting Phone Line







From **Phone Option** menu

- 1  **Call Service > Line**  (Select)
- 2  **Line 1/Line 2**  (Select)

Call Divert

Setting Call Divert

From **Phone Option** menu

- 1  **Call Divert**  (Select)
- 2  Select the circumstances to initiate the divert  (Select)
- 3  required operation from **Set, Clear, or Check Status**  (Select)
- 4 Enter phone number to divert to 

- When a divert situation is enabled the divert icon (↵) is displayed.
- When updating or checking the status of **Call Divert** the phone must be registered with a network. (↑)









All Voice Calls	Divert all incoming voice calls.
Not Reachable	When phone is disconnected, divert incoming voice calls.
No Reply	If call is not answered, divert incoming voice calls.
Busy	When a call is in progress, divert incoming voice calls.
Status Check	Check the current Call Divert status.
Cancel All	Cancel all Call Divert settings.

Call Barring restricts certain outgoing and/or incoming calls using a password supplied by your service provider. When updating/checking the status of Call Bar the phone must be registered with a network.

Security

Setting Call Bar

From **Phone Option** menu

- 1  **Security > Call Bar**  (Select)
- 2  required setting from the menus showing below  (Set) or  (Select)
- 3  required operation from **Set, Clear or Check Status**  (Select)
- 4 Enter required password  (Select)

All Outgoing	All Outgoing calls are barred.
Outgo Internat	International Outgoing calls are barred.
Out.int.xhome	International Outgoing calls except home are barred.
All Incoming	All Incoming calls are barred.
When Roaming	All internal incoming calls when roaming outside the home PLMN.
Status Check	Call bar status is displayed.
Cancel All	Cancel all Call Bar settings.
Password	Change Call Bar Password.

Codes

The PIN protects your SIM against unauthorised use. If you enable the PIN, every time the phone is switched on you will be prompted to enter the PIN.

The PIN2 controls security for the Fixed Dial Store, Call Charge metering and Barred Dial.

If either PIN/PIN2 is entered incorrectly **3 times** the phone will be locked and you will need to enter the PUK/PUK2 code.

Contact the service provider for the PUK/PUK2 code.

NOTE: To enter PUK code for PIN, enter **05# you will then be prompted to enter the PUK code, then follow the on-screen instructions.

To enter PUK2 code for PIN2, enter **052# you will then be prompted to enter the PUK2 code, then follow the on-screen instructions.

Change Phonecode

From **Phone Option** menu

- 1 **Security > Codes** (Select)
- 2 **Change Phonecode** (Select) > Enter the current Phonecode, if needed (OK)
- 3 Enter New Phonecode (OK) > Repeat the entry (OK)

Enabling/Disabling the PIN

From **Phone Option** menu

- 1 **Security > Codes** (Select)
- 2 **PIN Control** (Set)
- 3 Enter PIN number (OK) > Repeat the entry (OK)

Changing the Security Code

From **Phone Option** menu









- 1 **Security > Codes** (Select)
- 2 **Change PIN or Change PIN2** (Select)
- 3 Enter the current code (OK)
- 4 Enter the new code (OK)
- 5 Enter the new code to verify (OK)

NOTE: If the PUK/PUK2 code is entered incorrectly 10 times, the phone will cease to operate permanently. All information stored in the SIM will be lost and the SIM will need to be replaced. Contact the service provider for more details.

Fixed Dial is one of the functions in SIM Phonebook. Only numbers stored in your SIM Phonebook can be selected for FDN dialling. To enter fixed dial numbers, see "Storing a Fixed Dial Number" on page 31.

Setting Fixed Dial

From **Phone Option** menu

- 1  **Security**  (Select)
- 2  **Fixed Dial**  (Select)
- 3 Enter PIN2 code  (OK)
- 4  (FDN) >  **On**
- 5  (OK)

- Any manually dialled phone numbers must be the same as the numbers in the Fixed Dial Store.
- A phone number may be stored, edited or deleted. You will be prompted for your PIN2 code.

Setting SIM Lock

From **Phone Option** menu

- 1  **Security**  (Select)
- 2  **SIM Lock**  (Select)
- 3 Enter Phonecode  (OK)

NOTE: You are advised to write down your Phonecode. In case you forget your phonecode, you will need to contact your service provider to unlock the SIM.

Network

You can select a network that is available in your current location.

NOTE: This function is AWS SIM dependent.

Network setting

From **Phone Option** menu

- 1 **Network** (Select)
- 2 required option (On/off) or (Select)

Auto Network	Set "Auto Network" On or Off.
New Network	When "Auto Network" is on; Search an available network automatically. When "Auto Network" is off; Select a network manually.
Network List	Create and edit a network list according to your preferences.
Band Select	Choose a network band: 900/1800, 900/1900, 900, 1800, 1900MHz.

CSD Setting

You need to complete CSD setting before setting your server.
- see "Server Setting" on page 37.

Connection Setting

You can set CSD setting when connecting to network.

From **Phone Option** menu

- 1 **CSD Setting** (Select)
- 2 required setting (Select)
- 3 when all the data are entered, (Save)

Server Name	Enter Server Name.
Call Type	Select ISDN or Analogue.
Dial Number	Enter the common numbers in Digital and Analogue.
Login Name	Enter Login ID.
Password	Enter Password.





You need to complete GPRS setting before setting your server.
- see "Server Setting" on page 37.

GPRS Setting

Connection Setting

You can set GPRS setting when connecting to network.

From **Phone Option** menu

- 1  **GPRS Setting**  (Select)
- 2  required setting  (Select)
- 3 when all the data are entered,  (Save)

• When GPRS setting is completed, the GPRS icon (GPRS) is displayed.

Server Name	Enter Server Name.
GPRS APN	Enter Access Point Name.
Login Name	Enter Login ID.
Password	Enter Password.
Authentication	Select Active or Deactive.

GPRS Info

Viewing GPRS Information.....

From **Phone Option** menu

- 1  **GPRS Info**  (Select)
- 2 To reset GPRS Info;
 (Reset) >  (Yes)

Applications Menu Structure

Applications

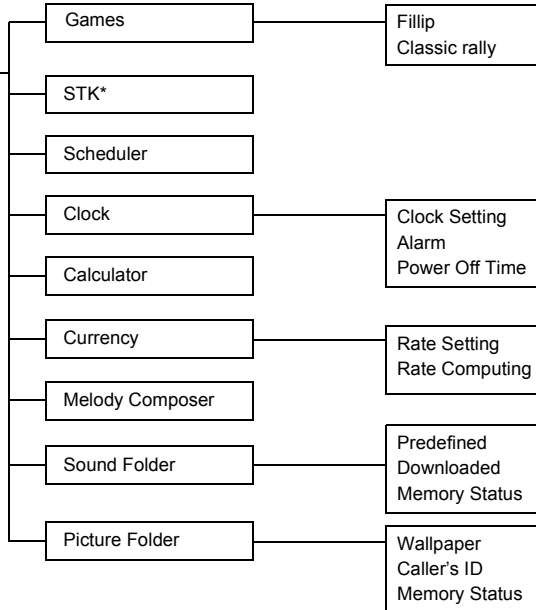





***NOTE:** STK (SIM Tool Kit) is SIM dependent.

Applications

Games

From **Applications** menu

- 1  **Games**  (Select)
- 2  required game  (Select).

• Please refer to “Games” on page 28.

STK (SIM Tool Kit)

This function is SIM dependent.

Scheduler









You can organize your schedule to remind your personal event, such as planning holiday period. You need to set clock first before entering to the scheduler. In the Scheduler, you can store:

- Type (Memo or Meeting)
- Description
- Start Date
- Start Time
- End Date
- End Time

NOTE: Ensure that the setting of the Scheduler will not contravene any regulations whereby it may automatically power on when in an aircraft or medical facility, etc. - see Important Information in Part 2.











Entering a Schedule

From **Applications** menu

- 1  **Scheduler**  (Select)
- 2  to select **Week** or **Month** format
- 3 To select a day, press numerical keys 2, 8, 4 and 6 to move the cursor \uparrow , \downarrow , \leftarrow and \rightarrow , or  to move the cursor \uparrow or \downarrow to set a day. $>$  (Agenda)
- 4  **<New Entry>**  (Select)
- 5 Enter required information
- 6  (Save)

Viewing / Editing Scheduler

From **Applications** menu









- 1  **Scheduler**  (Select)
- 2  to select **Week** or **Month** format
- 3 When Month format is selected:
Select a day marked in blue by using the numerical keys (2, 8, 4 and 6) $>$  (Agenda)
When Week format is selected:
Schedule icon(s) will be shown corresponding to a period of time selected by pressing .
(Period of time: 4=0:01-4:00, 8=4:01-8:00, 12=8:01-12:00, 16=12:01-16:00, 20=16:01-20:00, 24=20:01-0:00)
Select a day by using the numeric keys (2, 8, 4 and 6) $>$  (Agenda)
- 4  required schedule  (View)
- 5 To return to the previous display,  (OK)
To edit,  (Edit) edit required information  (Save)

Before setting Time & Date, set Time Zone of your region or the city which has same time zone as your region. When travelling abroad, your home time can be changed to your destination time.

Clock





Time Zone Setting

From **Applications** menu

- 1  **Clock > Clock Setting > Time Zone**  (Select)
- 2  required region  (Select)
- 3  (Yes) or  (No) to select **"Day Light Saving?"**
- 4 **"Set This City to Local"**  (OK)
- 5 **"Success!"**  (OK)

Time & Date Setting





From **Applications** menu

- 1  **Clock > Clock Setting > Time & Date**  (Select)
- 2  (Set) enter the digits for the time  (OK)

Time and date can be shown on the display in idle mode.

Time Display Setting

From **Applications** menu

- 1  **Clock > Clock Setting**  (Select)
- 2  **Display Time**  (On/off)

Display format for time and date can be selected.









Date Format/Time Format.....

From **Applications** menu

- 1  **Clock > Clock Setting > Date Format or Time Format**  (Select)
- 2  required format  (Select)

Alarm Setting

From **Applications** menu

- 1  **Clock > Alarm**  (Select)
- 2  (Set) > Enter the digits for the time (24 hour clock)  (OK)
- 3  Select from **Repeat Daily, Once or Disabled**  (Select)
- 4 **"Alarm Time Has Been Updated!"**  (OK)
 - Alarm set indicator  appears on idle display.
 - When the set time is reached, the alarm will sound. When in a call the phone will vibrate.

To end alarm:

Press any key or  (OFF)







OR  (Pause) to pause the alarm and start again after 5 minutes

NOTE: Ensure that the setting of the Alarm will not contravene any regulations whereby it may automatically power on when in an aircraft or medical facility etc. - see Important Information in Part 2.

The phone can be set to turn itself off automatically at a specified time using the Power Off feature. The procedure for setting/adjusting the Power Off automatically is similar to the setting of Alarm.

Power Off Time







From **Applications** menu

- 1  **Clock > Power Off Time**  (Select)
- 2 Enter the digits for the time (24 hour clock)  (OK)
- 3  Select from **Repeat Daily**, **Once** or **Disabled**  (Select)
- 4 **"Power Off Time Setting Updated!"**  (OK)

Calculator

The four function calculator will enable the user to perform simple arithmetic calculations (addition, subtraction, multiplication and division).

From **Applications** menu







- 1  **Calculator**  (Select)
- 2 Enter a number (maximum 7 digits) and it will be displayed on the upper right of the display. When a decimal point is required, press  , when a minus sign is needed press  .
- 3  to select the arithmetic operation
- 4 Enter a number (maximum 7 digits) and it will be displayed next to the operation symbol. If  is used to select another arithmetical operation to perform, an intermediate calculation will be performed and the result displayed on the top line.
- 5  (=) to calculate

Currency

The currency convertor enables you to convert from/to a home currency using a conversion rate that you enter.





Setting the currency value

From **Applications** menu

- 1  **Currency**  (Select)
- 2  **Rate Setting**  (Select)
- 3 On the right side of the screen, enter your home currency rate to the currency which you want to convert with  (OK)
- 4  (Save)

Rate Computing

From **Applications** menu

- 1  **Currency**  (Select)
- 2  **Rate Computing**  (Select)
- 3 Enter the amount of currency which you want to convert into your home currency  (Convert)

Melody Composer

Please refer to "Composing a Melody" on page 17.











The Sound Folder contains predefined sound files and any downloaded sound files. You can play the sound and set one as your Ringtone.

The memory status is dependant on file sizes stored in the Melody Composer, Picture Folder and Sound Folder.

Sound Folder





Setting Ringtone:

From **Applications** menu

- 1  **Sound Folder**  (Select)
- 2  **Predefined or Downloaded**  (Select)
- 3  required sound  (Menu)
 - To see the information of the selected Ringtone,  **Info**  (Select)
 - To return to the previous menu,  (OK)
- 4  **Set to Ringtone**  (Select)

Viewing Memory Status:

From **Applications** menu

- 1  **Sound Folder**  (Select)
- 2  **Memory Status**  (Select)
 - **Free Space** and **Total Used** are displayed.
 - To return to the previous menu,  (OK)













Picture Folder

You can find lists of predefined pictures and downloaded pictures in both Wallpaper folder and Caller ID folder. You can view those pictures, and also set one of them for the idle screen.

The memory status is dependant on file sizes stored in the Melody Composer, Picture Folder and Sound Folder.











Setting Wallpaper:

From **Applications** menu

- 1  **Picture Folder**  (Select) >  **Wallpaper**  (Select)
- 2  **Predefined or Downloaded**  (Select)
- 3  required picture  (Menu)
 - To see the large picture,  **View**  (Select)
 - To return to the previous menu,  (Back)
- 4  **Set to Wallpaper**  (Select)





Viewing Picture of Caller's ID:

From **Applications** menu

- 1  **Picture Folder**  (Select) >  **Caller's ID**  (Select)
- 2  **Predefined or Downloaded**  (Select)
- 3  required picture  (Menu)
- 4  **View or Info**  (Select)
 - To return to the previous menu,  (Back)

Viewing Memory Status:

From **Applications** menu

- 1  **Picture Folder**  (Select)
- 2  **Memory Status**  (Select)
 - **Free Space** and **Total Used** are displayed.
 - To return to the previous menu,  (OK)

Records Menu Structure

Records

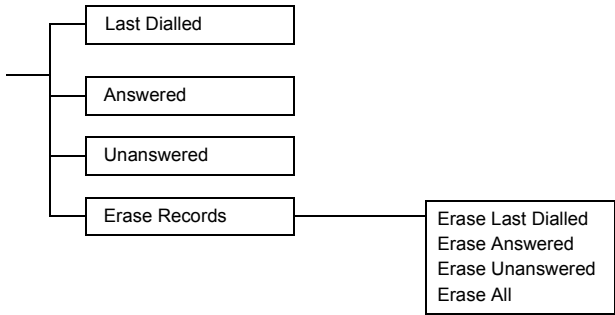

Records

Recently dialled phone numbers will be stored in **Last Dialed**. (Max 50)

If an Incoming call with Caller ID is answered the number will be stored in **Answered**. (Max 50)

If an Incoming call with Caller ID is not answered the number will be stored in **Unanswered**. (Max 20)

Calling for the Last Dialed/Answered/Unanswered number.....

From **Records** menu

- 1 Choose one menu from **Last Dialed**, **Answered** or **Unanswered** (Select)
- 2 required phone number (or name) you wish to redial .
OR
In idle, to view the last dialled numbers directly.

To save a record in Phonebook:

After selecting desired number,

- (Menu) > **Save** (Select) > **SIM Phonebook** or **Mobile Phonebook** (Select)
Enter Name and Phone number (Save).

NOTE: When the store is full the next phone number will overwrite the oldest.

Erasing Records

From **Records** menu

- 1 **Erase Records** (Select)
- 2 Choose one menu from **Erase Last Dialed**, **Erase Answered**, **Erase Unanswered** or **Erase All** (Select).
- 3 (Yes)

Troubleshooting

Should any problem persist contact your dealer.

Problem	Cause	Remedy
Phone will not switch on.	_____	Check that the battery is fully charged and correctly connected to the phone.
Extremely short battery life for a new battery.	The network you are using and the condition of the battery can affect battery life.	_____
Short battery life for an old battery.	The battery has worn out.	Replace with a new fully charged battery.
The charging indicator does not light, the battery level indicator does not appear and the phone cannot be switched on when charging.	The battery is not attached to the phone or when the battery has been deeply discharged the phone will take a short time until the indicator lights.	Leave the phone charging the battery for a few minutes before the indicator is lit and attempting to switch it on.
Battery fails to charge.	The battery is not attached to the phone.	Ensure the battery is fitted to the phone prior to commencing charging.
	Battery has been connected to the phone after the Fast Travel Charger has been switched on.	
Calls cannot be made.	The phone is locked.	Unlock the phone.
	Outgoing calls are barred.	Disable the outgoing call barring or barred dial.
	The phone is not registered to a network.	Move to a coverage area and operate your phone after it has registered with a network.

Problem	Cause	Remedy
Calls cannot be made from Fixed Dial Store.	_____	Check whether your SIM supports Fixed Dial. Check if the Fixed Dial is switched on. Check whether the phone number is stored in the Fixed Dial.
Calls cannot be received.	The phone is not switched on.	Switch the phone on.
	Incoming calls are barred.	Disable the incoming call barring.
	The phone is not registered to a network.	Move to a coverage area and operate your phone after it has registered with a network.
Emergency calls cannot be made.	You are not in a GSM coverage area.	Check that the antenna symbol T is displayed – move to a coverage area and operate your phone when the antenna symbol is displayed.
Phone numbers cannot be recalled from Phonebook.	The phone is locked.	Unlock the phone.
	Phone number has been restricted.	Switch off restriction.

Important Error Messages

These are some of the most important error messages which may be displayed:

Please Insert SIM Card	SIM card is not inserted, or is not inserted correctly. Please insert the SIM card correctly.
New Codes Not Same	When you change your password, you have to enter the new password twice to confirm. The two codes you entered are not same. Please enter same code twice.
Password Invalid!	When you change your password, you have to enter the new password twice to confirm. The two codes you entered are not same. Please enter same code twice.
Can't Access Network	The service network you selected manually is inaccessible. Please contact your service provider.
Unable to Select Network	The service network you selected manually refuse your access. Please contact your service provider.
No Service	There is no network within range or the received signal is weak. Move to an area which has stronger signal.
PIN Blocked! Please Enter PUK	You entered your PIN or PIN2 incorrectly three times in a row. To unblock the PIN, please enter PUK1 or PUK2.

PIN2 Blocked! Please Enter PUK2	You entered your PIN or PIN2 incorrectly three times in a row. To unblock the PIN, please enter PUK1 or PUK2.
New PIN Not Accepted	Your new PIN code is not accepted. Please try again.
New PIN2 Not Accepted	Your new PIN2 code is not accepted. Please try again.
Incorrect Entry!	You entered wrong PIN or PIN2. Please enter the correct one.
Entries Do Not Match!	When you change your password, you have to enter the new password twice to confirm. The two codes you entered are not same. Please enter same code twice.
SIM Card Error	Make sure the SIM card is inserted correctly. Clean the SIM card with a dry cloth or check if it is damaged. Contact your service provider.
Function Unsupported	The function you selected is not supported your service provider. Please contact your service provider.
Invalid Password	The password that you entered is not valid. Please enter the correct password.
Not Available	The function you selected is not supported by your service provider. Please contact your service provider.
Service Not Available	The function you selected is not supported by your service provider. Please contact your service provider.

Wrong PUK!	You entered wrong PUK. Please enter the correct one.
SIM Full! Please Delete Old Message!	The SIM storage area for SMS is full. Please delete old messages.
SIM Not Enough Space! Continue?	The SIM storage area is FULL. If you continue data may be lost. Please delete old records.
Not Enough Space! Continue?	The message storage area is FULL. If you continue data may be lost. Please delete old records.
SIM Service Not Support	The SIM function you selected is not supported by your service provider. Please contact your service provider.
Unregistered SIM Card	Your SIM card is not registered to your service provider. Please contact your service provider.
Authentication Failure	Your SIM card is not registered to your service provider. Please contact your service provider.
Blocked	Your SIM card is blocked. Please contact your service provider.

Glossary of Terms

APN	Access Point Name. Directs the user to the gateway or the required service.
CHAP	Challenge Handshake Authentication Protocol. A security feature for the GPRS network.
CSD	Circuit Switched Data. A communication method used to transmit data over telephone connections.
DTMF Tones	Dual Tone Multi-Frequency tones allow you to communicate with computerised phone systems, voice mailboxes, etc.
EMS	Enhanced Messaging Services. One of the mail systems which use the cellular phone, and service by which data of e-mail of the text, etc. can be transmitted and received.
GPRS	General Packet Radio Service. A GSM transmission technique that transmits and receives data in packets rather than setting up a continuous channel. It makes very efficient use of available radio spectrum and users pay only for volume of data sent and received.
GSM	Global System for Mobile communications. The name given to the advanced digital technology that your phone uses.
Network Operator	The organization responsible for operating a GSM network.
PAP	Password Authentication Protocol. A security feature in the GPRS network.
Password	Used for the control of Call Bar. Supplied by your service provider.
PIN	Personal Identification Number used for SIM security. Supplied by your service provider. If the PIN is entered incorrectly 3 times, the PIN will be blocked.
PIN2	Personal Identification Number used for the control of Fixed Dial Store and Call Charge metering. If the PIN2 is entered incorrectly 3 times, the PIN2 will be blocked.

PUK/PUK2	PIN/PIN2 Unblocking Key. Used to unblock the PIN/PIN2. Supplied by your service provider. If the PUK/ PUK2 is entered incorrectly 10 times, the PUK/PUK2 will be blocked.
Registration	The act of locking on to a GSM/GPRS network. This is usually performed automatically by your phone.
Roaming	The ability to use your phone on networks other than your Home network.
Service Provider	The organization responsible for providing access to the GSM/GPRS network.
SIM	Subscriber Identity Module. A small smart-card which stores unique subscriber and user-entered information such as Phonebook and Short Messages. Supplied by your service provider.
SMS	Short Message Service. A basic mail system used for cellular phones. This service allows sending/receiving short text messages.
WAP	Wireless Application Protocol. The communication standard which enables you to download resources from the Internet to your phone.

Accessories

Li-Ion Battery (EB-BSG50S)



Double your talk time by having a spare battery.

Fast Travel Charger (EB-CAD55UK)



Carry a lightweight portable charger wherever you go to ensure you always have power to talk.

Fast Travel Charger (EB-CAD55EU)



How to Identify a Genuine Panasonic Accessory

Panasonic produces some of the most advanced mobile phones available. So, as you'd expect from this class leader, the range of accessories are second to none. Most genuine Panasonic accessories will have a label showing an "EB-XXX00" model number.

NOTE: Accessories are subject to change without notice.

Personal Settings

Item	Provisioning Information Setting No. 1	Provisioning Information Setting No. 2	Provisioning Information Setting No. 3	Provisioning Information Setting No. 4	Provisioning Information Setting No. 5
Profile Name					
Server Name					
IP Address					
IP Port					
Homepage					
Linger Time					
Circuit Switched (GSD)					
Server Name					
Call Type					
Dial Number					
Login Name					
Password					
Packet Switched (GPRS)					
Server Name					
GPRS APN					
Login Name					
Password					
Authentication					

The Serial Number can be found on the outside of the phone under the battery. For your convenience we recommend that you note the following details as a record of your purchase.

Part Number	
Serial Number	
Dealer Name	
Purchase Date	

Index

A

Access to Shortcuts	26
Accessories	81
Activating a profile	22
Alarm Setting	67
Alert Type	22
Answering Calls	11
Any Key Answer	25
APN	79
Applications	64
Applications Menu Structure	63
Attaching and Removing the Battery	1
Auto Answer	25
Auto capital change	51
Auto Display	49

B

Back to the Menu Display	5
Battery	1
Bookmarks	39
Brightness	24
Broadcast	48
Browser	37
Browser Menu Structure	36
Browsing Bookmark	39
Browsing the Phone Book	32

C

Calculator	68
Call Divert	4, 57
Call Service	54
Changing Alert Type	22
Changing the Language	21
Changing the Ring Tone	16
Changing the Security Code	59
Changing the Volume	16
Charge Settings	55
Charger	2
Charging the Battery	2
Classic rally	28
Clock	66
Codes	59
Composing a Melody	17
Connection Setting	61, 62
Connectivity	61, 62
Creating a New Short Text Message	42
CSD Settings	61, 62

D

Date Format/Time Format	67
Disabling Key Guard	40
Display	4, 24

E	
Editing profiles	22
Editing Scheduler	65
Editing User Message	43
Editing User Messages	24
Emergency call	4
Enabling/Disabling the PIN	59
Entering to the Menu Display	5
F	
Fillip	28
Fitting and Removing the Battery	1
G	
Game Menu Structure	27
Games	28, 64
Getting Started	1
H	
Headset	22
Hot Key Dial	35
K	
Key Guard	40
Key Operation	28
Key Tone	23
Keys	3
Keys & Displays	3
L	
Long press	7
Low Battery Warning	2
M	
Making a Call by Using Hot Key Dial	35
Melody Composer	69
Memory Status	34
Menu Display	5
Menu Structure	6
Messages	42
Messages Menu Structure	41
My Numbers	34
My Phone	16
My Phone Menu Structure	15
My Phonebook	26, 35
N	
Network	61
Network setting	61
Normal	22
Numeric key pads	3
O	
Operation of Battery Level Indicator	2
Options	46
Options in Phone Book	32
Outdoor	22

P

Phone Book	30
Phone Book Menu Structure	29
Phone Menu Structure	53
Phone Option	54
Picture	71
Picture Folder	71
Power Off Time	68
Profile Setting	22

Q

Quiet	22
-------------	----

R

Rate Computing	69
Reading a Received Message	44
Reset Defaults	25
Right Softkey	3
Ring Volume	22
Roaming	4

S

Scheduler	65
Security	58
Selecting Games	28
Server Setting	37
Setting Any Key Answer	25
Setting Auto Answer	25
Setting Auto Display	49, 56
Setting Bookmark	39
Setting Brightness	21

Setting Broadcast	48
Setting Call Bar	58
Setting Call Divert	57
Setting Call Waiting	54
Setting Colour Themes	21
Setting Currency	55
Setting Display Animation	20
Setting Display Contrast	20
Setting Fixed Dial	60
Setting Greeting	20
Setting Hot Key Dial	35
Setting Key Guard	40
Setting Key Tone	19
Setting Language	49
Setting My Number	34
Setting Options	47
Setting Personal Rate	56
Setting Phone Line	57
Setting Shortcuts	26
Setting SIM Lock	60
Setting SIM or Mobile Phonebook	26
Setting T9 Text Input	26
Setting the Maximum Cost	56
Setting the Message Centre Number	42
Setting Warning Tone	19
Short press	7
Shortcut	7
Shortcut from Idle Screen	7
SIM	1
SMS	42
Sound Folder	70
Sound Setting	16

Starting Games	28
Status Icons	4
Storing	30
Storing a Number in Mobile Phonebook	30, 31
Swap	14

T

T9 Text Input	26
Time & Date Setting	66
Time Display Setting	66
Time Zone Setting	66
To end alarm	67
Topic	48

V

Vibration alert	4
Vibrator	23
Viewing	32
Viewing Broadcast	49
Viewing Memory Status	34, 46
Viewing Message Lists in Mobile	46
Viewing Message Lists in SIM	45
Viewing My Numbers	34
Viewing Time/Charges	54
Volume	22

W

WAP Activating	38
Warning Tone	23
Withhold ID /Caller's ID	55

Free Manuals Download Website

<http://myh66.com>

<http://usermanuals.us>

<http://www.somanuals.com>

<http://www.4manuals.cc>

<http://www.manual-lib.com>

<http://www.404manual.com>

<http://www.luxmanual.com>

<http://aubethermostatmanual.com>

Golf course search by state

<http://golfingnear.com>

Email search by domain

<http://emailbydomain.com>

Auto manuals search

<http://auto.somanuals.com>

TV manuals search

<http://tv.somanuals.com>