

# Panasonic

# G51U

EB-G51U  
Operating Instructions  
Digital Cellular Phone



GSM<sup>®</sup>

# Contents

<b>Safety First</b> .....	<b>1</b>	Sounds .....	23
<b>Care and Maintenance</b> .....	<b>7</b>	Display .....	26
<b>Getting Started</b> .....	<b>8</b>	Language .....	28
Inserting and Removing the SIM .....	8	Alert Type .....	29
Attaching and Removing the Battery .....	8	Profiles .....	29
Charging the Battery .....	9	User Messages .....	31
Operation of Battery Level Indicator .....	9	Auto Answer .....	32
Low Battery Power Warning .....	9	Any Key Answer .....	32
<b>Keys &amp; Displays</b> .....	<b>10</b>	Reset Defaults .....	32
Keys .....	10	Shortcuts .....	33
Display .....	11	My Phonebook .....	33
Status Icons .....	11	T9 Input .....	33
Symbols used in the Manual .....	12	<b>Games Menu Structure</b> .....	<b>34</b>
Menu Display .....	12	<b>Games</b> .....	<b>35</b>
Menu Structure .....	13	Selecting Games .....	35
Shortcuts from Idle Screen .....	14	<b>Phone Book Menu Structure</b> .....	<b>36</b>
<b>Phone Basics</b> .....	<b>15</b>	<b>Phone Book</b> .....	<b>37</b>
Phone ON/OFF .....	15	Storing .....	37
Displaying Menu .....	15	Viewing .....	39
Making Calls .....	16	Options in Phone Book .....	39
Answering Calls .....	18	Group Settings .....	40
In-Call Options .....	19	Memory Status .....	41
<b>My Phone Menu Structure</b> .....	<b>22</b>	My Numbers .....	41
<b>My Phone</b> .....	<b>23</b>	Hot Key Dial .....	42

My Phonebook .....	42	GPRS Setting .....	70
<b>Browser Menu Structure .....</b>	<b>43</b>	GPRS Info.....	70
<b>Browser .....</b>	<b>44</b>	<b>Applications Menu Structure .....</b>	<b>72</b>
Server Setting .....	44	<b>Applications .....</b>	<b>73</b>
WAP Activating .....	45	Games .....	73
Bookmarks .....	46	STK (SIM Tool Kit).....	73
<b>Key Guard .....</b>	<b>47</b>	Scheduler .....	74
<b>Messages Menu Structure .....</b>	<b>48</b>	Clock .....	75
<b>Messages .....</b>	<b>49</b>	Calculator .....	77
SMS .....	49	Currency .....	78
Options .....	54	Melody Composer .....	78
Broadcast .....	55	Sound Folder .....	79
Auto Display .....	57	Picture Folder .....	80
<b>Text Entry .....</b>	<b>58</b>	<b>Records Menu Structure.....</b>	<b>81</b>
Shift mode .....	59	<b>Records .....</b>	<b>82</b>
T9® Dictionary.....	59	<b>Troubleshooting .....</b>	<b>83</b>
Text Input .....	59	<b>Important Error Messages.....</b>	<b>85</b>
<b>Phone Option Menu Structure.....</b>	<b>61</b>	<b>Glossary of Terms .....</b>	<b>88</b>
<b>Phone Option .....</b>	<b>62</b>	<b>Consumer Update .....</b>	<b>90</b>
Call Service .....	62	<b>Specifications .....</b>	<b>93</b>
Call Divert .....	65	<b>Accessories .....</b>	<b>94</b>
Security .....	66	<b>Warranty .....</b>	<b>95</b>
Codes .....	67	<b>Personal Settings .....</b>	<b>97</b>
Network .....	69	<b>Licensing .....</b>	<b>98</b>
CSD Setting .....	69	<b>Index .....</b>	<b>99</b>

# Safety First

Your new phone is a convenient and effective communications tool, but it can be hazardous when used improperly. To avoid harming yourself or anyone else, please review the following information before using your phone.

## Batteries

Batteries can cause property damage, injury, or burns if the terminals are touched with a conductive material (for example, metal jewelry, keys, and so on). Therefore, use caution when handling a charged battery. Additional precautions and notes are listed below:

- Never throw a battery into a fire; it may explode.
- Fully recharge the battery if the battery is low or as soon as the low-battery alert beeps.
- Do not drop the battery.
- Do not allow bridging of battery contacts with metallic objects.
- Do not remove the battery from the phone while the phone is powered on. Settings you have changed may revert to their previous settings.



A recyclable lithium ion/polymer battery powers your phone. Please call 1-800-8-BATTERY for information on how to recycle the battery.

## Charging Devices

Use only Genuine Panasonic charging accessories. Use of attachments not recommended by Panasonic or your Service Provider may result in fire, electrical shock, or injury. Panasonic is not responsible for damage caused by using non-Panasonic accessories.

- Do not expose charging adapters to moisture, water, or the weather.
- Do not use an adapter with a damaged cord.
- When using a DC adapter in an automobile, a small amount of electricity flows through the adapter, even if the phone is turned off. Remove the plug from the cigarette lighter whenever the phone will be left in the vehicle for long periods of time.
- Always charge the battery in a well ventilated area, not in direct sunlight, between 41°F (5°C) and 95°F (35°C). It is not possible to recharge the battery if it is outside this temperature range.
- Do not incinerate or dispose of the battery as ordinary trash. The battery must be disposed of in accordance with local legislation and may be recycled.

**Caution:** The cigarette lighter must have a 12V negative ground socket. Do not use the adapter in a vehicle that has a positive ground system.

## General

- Do not use the phone in extreme temperature or humidity. The specified operating temperature range is -22°F to +140°F (-30°C to +60°C).
- Extreme temperatures may have a temporary effect on the operation of your phone. This is normal and does not indicate a fault.
- Do not expose the phone (particularly the display) to direct sunlight for extended periods of time or to a humid, dusty or hot area.
- Do not attempt to disassemble the phone. There are no user-serviceable parts inside.
- Do not subject the equipment to excessive vibration or shock.
- Do not expose the phone to rain or spill liquids on it. If the equipment becomes wet immediately remove the battery and charging device and contact your dealer.
- Do not carry the phone by holding the antenna.
- Do not use any accessories other than those designed for use with your phone.
- Use of attachments not recommended or sold by Panasonic or your Service Provider may result in fire, electrical shock, or injury.
- Panasonic is not responsible for damages caused by using non-Panasonic accessories.
- Pressing any of the keys may produce a loud tone. Avoid holding the phone close to the ear while pressing the keys.
- Keep metallic items that may accidentally touch the battery terminals away from the equipment. Battery damage may occur.
- When disposing of any packing materials or old equipment check with your local authorities for information on recycling.

- If connecting the phone to an external source, read the operating instructions of the equipment for the correct connection and safety precautions.
- If connecting the phone to an external source, verify that the phone is compatible with the product to which you are connecting it.

## Availability of Service

This phone, like any wireless phone, operates using radio signals, wireless and landline networks, and user-programmed functions. Because of this, connection in all conditions cannot be guaranteed. Therefore, you should never rely solely on any wireless phone for essential communications (for example, medical emergencies).

## Emergency (911) Service

If you need to make an emergency (911) call, power the phone on, dial 911, and press . Emergency calls can be made regardless of lock setting and with or without a SIM card. Remember, to make or receive any call, the phone must be switched on and in a service area that has adequate signal strength. Even if you are within the coverage area of your Service Provider, you may be in an area with insufficient signal strength to place a 911 call. Emergency calls might not be possible on all wireless phone networks or when certain network service and/or phone features are in use.

## Call Rejected

Your phone displays **Call Rejected** under the following conditions:

1. Call was not able to connect to the network (no circuits available, no signal available or out of service area).

- Battery charge level is too low (recharge battery).
- Your calling plan is expired, depleted or has reached its pre-set limit.

**Note:** Emergency (911) Service is still available.

## Safety Tips

F

a

T M P M G R R

F r E T R a W a .

Y u r a n a r a r a a c r i .

f r i u n r a f r i u c (R F) r r b U F r a

C u c a . C i n U . S . G r T i r a

a r a r c f r f r i r a u a . T i

u a r b a a a r a a b

Q r u f a u a . f c i c u . T i a a r

c u a u b a a a i r a r a u n t

a i a r r i a r i a a t a l T i

f i a u r a u S c i c A b r R a r

SAR T SAR b U FCC 1.6W/ T i r SAR

a r c u c u a a r r a . n c i f b

U FCC U n n a . n n r i f b

a c a f i u c b a A l u n U SAR

SAR f i U n n c r i r U a c u a

a u a u T b c a u U n b l U

r a a u r r a a u U

r u n c a d U r l r a U c r u a n

a n b a a a a a U r u u

B r c a n a a a b i r a U u c u u

b l a a o r i U FCC U a n c U

a f a b n b U r r u n i r

a f c u r T i r a r f i r a a

ca (C . . a U r a r U b ) a r u r

b U FCC f r a U T i n n SAR a u f r U

U r r U b a c r b U u r u r

0.77W/ (B - r a u n f i r a n

u a a a b a c c U a FCC

r u r W U n a b f i r c b U

SAR f a r u n a a a r u U a

U r r u r u n i r a f a U r

T i FCC a r a a E u A u a f r U

n U a n r SAR U a u a a

c a c U FCC R F U SAR

f i r a U n n f i U FCC a

ca b f i u u r U D a G r a c . f <http://www.fcc.gov/oet/fccid> FCC ID HFS-G51.

A a a f r a S c i c A b r R a r (SAR)

ca b f i u U C U a r T i c u ca . i u r

A ca (CTIA) b - a <http://www.wow-com.com>

**Caution:** A P a a c b r a U a c c r e a r U a

c U FCC R F u n i r u r U N -

P a a c a c c r e a c

## Antenna Care

Do not use the phone with a damaged antenna. Use only the supplied or an approved replacement antenna.

Unauthorized antennas, modifications, or attachments could damage the phone and may violate FCC regulations.

## Phone Operation

**Normal Position:** Hold the phone as you would any other telephone, with the antenna pointed up and over your shoulder.

**For Efficient Operation:** For your phone to operate most efficiently, do not touch the antenna unnecessarily when the phone is in use. Contact with the antenna affects call quality and may cause the phone to operate at a higher power level than otherwise needed.

## Driving

**Important:** Check the laws and regulations on the use of wireless telephones in the areas where you drive. Always obey them. Also, if using your phone while driving:

- Give full attention to driving – driving safely is your first responsibility;
- Use handsfree operation, if available;
- Pull off the road and park before making or answering a call if driving conditions so require.

## Electronic Devices

Most modern electronic equipment is shielded from RF signals. However, certain electronic equipment may not be shielded against the RF signals from your wireless phone.

**Pacemakers:** The Health Industry Manufacturers Association recommends that a minimum separation of 6 inches (6") or 15 centimeters (15 cm) be maintained between a handheld wireless phone and a pacemaker to avoid potential interference with the pacemaker. These

recommendations are consistent with independent research and recommendations of Wireless Technology Research. Persons with pacemakers:

- Should ALWAYS keep the phone more than six inches from their pacemaker when the phone is turned ON;
- Should not carry the phone in a breast pocket;
- Should use the ear opposite the pacemaker to minimize the potential for interference;
- If you have any reason to suspect that interference is taking place, turn your phone OFF immediately.

**Hearing Aids:** Some digital wireless phones may interfere with some hearing aids. In the event of such interference, consult your Service Provider and hearing aid manufacturer.

**Other Medical Devices:** If you use any other personal medical device, consult the manufacturer of your device to determine if it is adequately shielded from external RF energy. Your physician may be able to assist you in obtaining this information.

Turn your phone OFF in health care facilities when any regulations posted in these areas instruct you to do so. Hospitals or health care facilities may be using equipment that could be sensitive to external RF energy.

**Vehicles:** RF signals may affect improperly installed or inadequately shielded electronic systems in motor vehicles. Check with the manufacturer or its representative regarding your vehicle. You should also consult the manufacturer of any equipment that has been added to your vehicle.

**Posted Facilities:** Turn your phone OFF in any facility where posted notices so require.

## Aircraft

FCC regulations prohibit using your phone while in the air; switch off your phone before boarding an aircraft unless otherwise advised by airline personnel.

## Blasting Areas

To avoid interfering with blasting operations, turn your phone OFF when in a "blasting area" or in other areas posted: "Turn off two-way radio." Obey all signs and instructions.

## Potentially Explosive Atmospheres

Turn your phone OFF when in any area with a potentially explosive atmosphere and obey all signs and instructions. Sparks in such areas could cause an explosion or fire resulting in bodily injury or even death.

Areas with a potentially explosive atmosphere are often, but not always, clearly marked. They include fueling areas such as gas stations; below deck on boats; fuel or chemical transfer or storage facilities; vehicles using liquefied petroleum gas (such as propane or butane); areas where the air contains chemicals or particles, such as grain, dust or metal powders; and any other area where you would normally be advised to turn off your vehicle engine.

## For Vehicles Equipped with an Air Bag

An air bag inflates with great force. DO NOT place objects, including both installed or portable wireless equipment, in the area over the air bag or in the air bag deployment area. If in-vehicle wireless equipment is improperly installed and the air bag inflates, serious injury could result.

**For U.S. Customers:** Vehicles using liquefied petroleum gas (such as propane or butane) must comply with the National Fire Protection Standard (NFPA-58).

For a copy of this standard, contact:  
National Fire Protection Association One Batterymarch Park  
PO Box 9101 Quincy, MA 02269  
Phone: 1-800-344-3555  
Web site: [www.nfpa.org](http://www.nfpa.org)  
E-mail address: [Custserv@NFPA.org](mailto:Custserv@NFPA.org)  
See "Consumer Update" starting on page 89 for the FDA Consumer Update on Mobile Phones published by the U.S. Food and Drug Administration.

## Ten (10) Driver Safety Tips

Your wireless telephone gives you the powerful ability to communicate by voice-almost anywhere, anytime. But an important responsibility accompanies the benefits of wireless phones, one that every user must uphold. When driving a car, driving is your first responsibility. When using your wireless phone behind the wheel of a car, practice good common sense and remember the following tips:

1. **Get to know your wireless phone and its features such as speed dial and redial.** If available, these features help you to place your call without taking your attention off the road.
2. **When available, use a hands free device.** If possible, add an additional layer of convenience and safety to your wire-



less phone with one of the many hands free accessories available today.

3. **Position your wireless phone within easy reach.** Be able to access your wireless phone without removing your eyes from the road. If you get an incoming call at an inconvenient time, if possible, let your voice mail answer it for you.
4. **Let the person you are speaking with know you are driving; if necessary, suspend the call in heavy traffic or hazardous weather conditions.** Rain, sleet, snow, ice, and even heavy traffic can be hazardous.
5. **Do not take notes or look up phone numbers while driving.** Jotting down a "to do" list or flipping through your address book takes attention away from your primary responsibility, driving safely.
6. **Dial sensibly and assess the traffic; if possible, place calls when you are not moving or before pulling into traffic.** Try to plan calls when your car will be stationary. If you need to make a call while moving, dial only a few numbers, check the road and your mirrors, then continue.
7. **Do not engage in stressful or emotional conversations that may be distracting.** Make people you are talking with aware you are driving and suspend conversations that have the potential to divert your attention from the road.
8. **Use your wireless phone to call for help.** Dial 9-1-1 or other local emergency number in the case of fire, traffic accident or medical emergencies. Remember, it is a free call on your wireless phone!
9. **Use your wireless phone to help others in emergencies.** If you see an auto accident, crime in progress or other serious emergency where lives are in danger, call 9-1-1 or other

local emergency number, as you would want others to do for you.

10. **Call roadside assistance or a special non-emergency wireless assistance number when necessary.** If you see a broken-down vehicle posing no serious hazard, a broken traffic signal, a minor traffic accident where no one appears injured, or a vehicle you know to be stolen, call roadside assistance or other special non-emergency wireless number.

"The wireless industry reminds you to use your phone safely when driving."

For more information,  
please call 1-888-901-SAFE  
or visit [www.wow-com.com](http://www.wow-com.com)

Information on this page provided by the Cellular  
Telecommunications Industry Association.



# Care and Maintenance



Pressing any of the keys may produce a loud tone. Avoid holding the phone close to the ear while pressing the keys.



Extreme temperatures may have a temporary effect on the operation of your phone. This is normal and does not indicate a fault.

The display quality may deteriorate if the phone is used in environments over 104°F(40°C) for a long time.



Do not modify or disassemble the equipment. There are no user serviceable parts inside.



Do not subject the equipment to excessive vibration or shocks.

Do not drop the battery.



Avoid contact with liquids. If the equipment becomes wet, immediately remove the battery and contact your dealer.



Do not leave the equipment in direct sunlight or a humid, dusty or hot area.



Never throw a battery into a fire. It may explode.

Keep metallic items that may accidentally touch the terminals away from the equipment/battery.

Batteries can cause property damage, injury, or burns if terminals are touched with a conductive material (i.e. metal jewelry, keys, etc.).



Always charge the battery in a well ventilated area, not in direct sunlight, between 41°F(+5°C) and 95°F(+35°C). It is not possible to recharge the battery if it is outside this temperature range.



When connecting the phone to an external source, read the operating instructions of the equipment for the correct connection and safety precautions. Ensure the phone is compatible with the product it is being connected to.



When disposing of any packing materials or old equipment check with your local authorities for information on recycling.

# Getting Started

Some services detailed are network dependent or may only be available on a subscription basis. Some functions are SIM dependent. For more information contact your service provider.

## Inserting and Removing the SIM

The SIM is inserted under the battery.

### Inserting the SIM



### Removing the SIM



## Attaching and Removing the Battery

Before removing the battery, ensure that the phone is switched off and the charger is disconnected from the phone.

### Attaching the battery



### Removing the battery

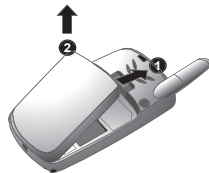

## Charging the Battery

### Connecting and disconnecting the Fast Travel Charger

The battery must be fitted in the phone before the charger is connected. Insert the charger into the Charging Connector and connect the travel charger to the socket-outlet. Then the Battery Level Indicator will start scrolling. It is recommended to charge the battery for a minimum of 4 hours before first use.

**NOTE:** DO NOT force the connector as this may damage the phone and/or the charger. If the battery has been deeply discharged it may take some time until the charge indicator is displayed.



When charging is complete disconnect the charger from the wall socket before removing the plug from the phone.



## Operation of Battery Level Indicator

	While charging	Charging complete
Phone on		
Phone off		

**NOTE:** When the battery is deeply discharged, it may take some time (2 to 3 minutes) until charging starts.

## Low Battery Power Warning

When the battery power is low, **Battery Is Low** message will be displayed. If this occurs during conversation, finish your call immediately. The power will automatically switch off after the warning tone. Fully recharge the battery. See "Charging the Battery" on this page. (Calls can be made and received while the phone is charging.)

# Keys & Displays



## Keys

### Key



### Function

**Navigation Key:** Scroll or move through menus, text and phone numbers. In idle mode, press to enter the Shortcuts.



**Left Softkey:** Perform the functions displayed above the key. In idle, press and hold to enter the SMS menu.



**Right Softkey/Cancel or Exit key:** Perform the functions displayed above the key. Mainly used to cancel functions.

## Display



**NOTE:** All screen images in the manual are simulated.

## Status Icons

The status icons are displayed or animated according to the currently activated functions. The Antenna, Signal and Battery icons are displayed when the handset is switched on and connected to a network. If the phone is not connected to a network, the network icon will not be displayed.

Icon	Indication
	Indicates it is possible to make emergency call
	SIM supports CPHS and Line1 is selected in Phone Option menu
	Signal strength
	Registered to a non-home network - <b>roaming</b>
	<b>Call divert</b> is on
	<b>Key Guard</b> is enabled
	Message area is full
	<b>Unread message</b> is stored
	(Flashing)
	New voicemail message is received
	Voice memo (SIM dependent)
	Alarm is set
	<b>Silent Mode</b> is on
	<b>Vibration alert</b> is on
	GPRS is active
	Battery full level:
	- low battery

## Symbols Used in the Manual



Press the Navigation key in the direction indicated by the arrow



Press Left Soft Key



Press Right Soft Key



Press numeric keys



Press to answer a call or call a dialed number



Press to end a call or long press to switch the phone on/off

## Menu Display

The menu system provides the means for accessing the functions which do not have their own dedicated buttons on the keypad.

### Entering the Menu Display

From **idle screen**

1 (Menu)

The main menu display has 9 menu options.  
(See "Menu Structure" on page 13.)

2 desired menu (Select)

OR

pressing a numeric key will access a menu option directly.

### Back to the Menu Display

repeatedly until the display goes back to the Menu display.

## Menu Structure

The 9 main menus are as follows.



### **My Phone**

1 Sound (1)T(02())TF1 1 Tt8 0air(0)4(s Tt8 L(Ke)1ng(Ke)197(n)3(e9(s)01(er)02()1D0 Tc0007(n)10ttrBt0e5s2 Tw Tyssi2 8106 TD(lat)97(or)T0 5 P10(d )(ssi



### **Games (or STK)\***

- 1 Classic rally



### **Browser**

- 1 Start Browser
- 2 Bookmarks
- 3 Settings

### **Key Guard**

### **Messages**

- 1 Create
- 2 Inbox
- 3 Outbox
- 4 Archive
- 5 User Messages
- 6 Memory Status
- 7 Options
- 8 Broadcast

### **Applications**





- 1 Games
- 2 (STK)\*
- 3 Scheduler
- 4 Clock
- 5 Calculator
- 6 Currency
- 7 Melody Composer
- 8 Sound Folder
- 9 Picture Folder



## Shortcuts from Idle Screen







You can go directly to a menu item by pressing the corresponding number key.

### Short press

Key	Function
	Menu
	Phonebook* (Names)
	Shortcuts
	Last dialed record list

\*The Phone must be registered to a network.

### Press and hold



Key	Function
	Hot key dial
	Browser*
	Silent mode
	Profile menu
	Power on/off
	Message Menu

\*The phone must be registered to a network.

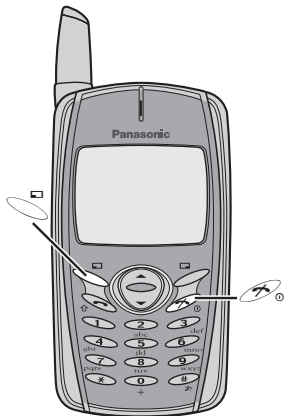
# Phone Basics



## Phone ON/OFF

- 1 Press and hold  for 2 to 3 seconds.
- 2  Phone will display Idle screen.

- 3 Press and hold  again to turn the power off.

## Displaying Main Menu

- From idle screen  
 to access Menu



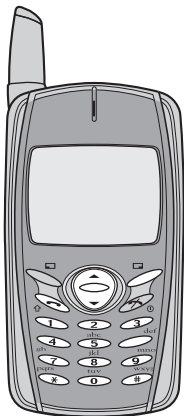

- Menu will be displayed.  
(Menu may change depending on your SIM.)



## Making Calls

- To make a call, start at idle screen.



### Standard Dialing

- 1 Enter phone number 
  - The dialed number is displayed.
- 2 When the other party answers, talk into the Microphone.
- 3 To hang up, 
  - The length of the call is displayed.
  - When **Max Cost** is on, the remaining units will be displayed.  
For setting the **Max Cost**, see "Setting the Maximum Cost:" on page 64.

#### Earpiece Volume:



During a call;  to adjust earpiece volume.

### Phonebook Dialing

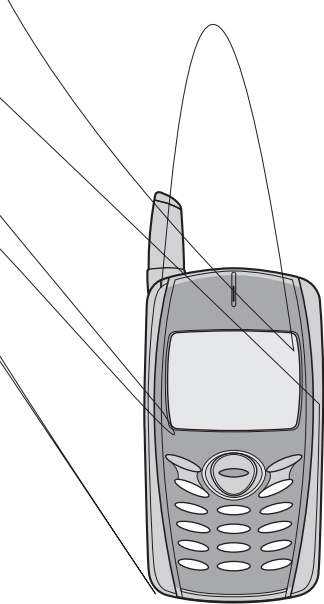
- 1  (Names)
- 2  desired phone number 





## Last Number Dialing

- 1 
- 2  desired phone number 

## International Dialing

The international access code (+) and the destination country/region code should be entered, followed by the area code and phone number.

- 1 Press and hold  until "+" is displayed then enter country/region code.
- 2 Enter area code and phone number 

**NOTE:** Many countries/regions include an initial "0" in the area code. This should, in most cases, be omitted when dialing international numbers. If you have difficulties making international calls, contact your service provider.

## Emergency Call

To make an emergency call, the antenna () must be present.

### *When SIM is inserted:*

enter emergency number 911 

### *When SIM is not inserted:*

enter emergency number 911 

OR

 (SOS) > "Emergency Call"  (Yes)

**NOTE:** Making Emergency calls without a SIM is country or network operator dependent.

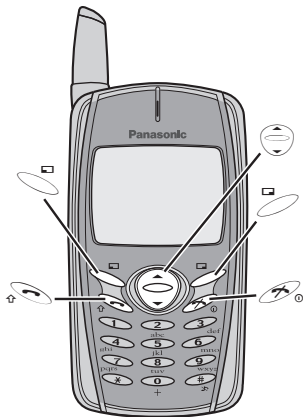

## Answering Calls



OR

When "Any Key Answer" is ON,





From Idle screen

press any key except 

(See "Setting Any Key Answer" on page 32)

### Ring Volume:

From **My Phone** menu

- 1  **Sounds > Volume**  (Select)
- 2  Adjust the volume level  (OK)

### Quick Touch Silent Mode:

To quickly turn off the ring tone and turn on vibrate, press and hold  in idle mode.

-  and  will be displayed on the idle screen.

### One Click Mute on Incoming Call:

To turn off the ring tone or vibrator,

- 1  (Mute)







If you want to reply to the call,

- 2  (Reply)

- If you want to reject the call,  (Reject).

## In-Call Options

During a call,  (Menu) or  (Hold)



 (Menu)	Hands Free	Switch to Desktop <b>Hands Free</b>
	Conference	Enable to make a conference call. You can talk with up to 5 parties.
	Call Transfer	Connect your calling party to the other party on hold, then disconnect your line. (SIM dependent)
	Phone Book	Open SIM Phonebook or Mobile Phonebook
	Messages	Create, check and send a message while you are talking. - see "Messages" on page 49.
	Call Status	 (End) to disconnect a line with the activating party.  (Hold) to put a call on hold with the activating party. To resume,  (Back) again.
 (Hold)	Hold	Put a call on hold. To resume,  (Back). (SIM dependent)

### Desktop Handsfree

Desktop Handsfree allows you to hold a conversation without holding the phone to your ear.



**NOTE:** Do NOT hold the phone to your ear in Handsfree mode.

#### During a Handheld call:

-  (Menu)
-  **Hands Free**  (Select)

**NOTE:** You can also switch between Handheld and Handsfree by pressing and holding .





#### To return to Handheld call:

 (Menu) >  (Select) to revert to Handheld operation



## Incoming Call While on a Call

During a call, you may receive another call:

- 1 To answer another call,  (First call is placed on hold.) To disconnect the second call,  (Reject)
- 2 During a conversation with a second caller,  (Menu) or  (Swap) and select one of the following options:



# My Phone Menu Structure

My Phone

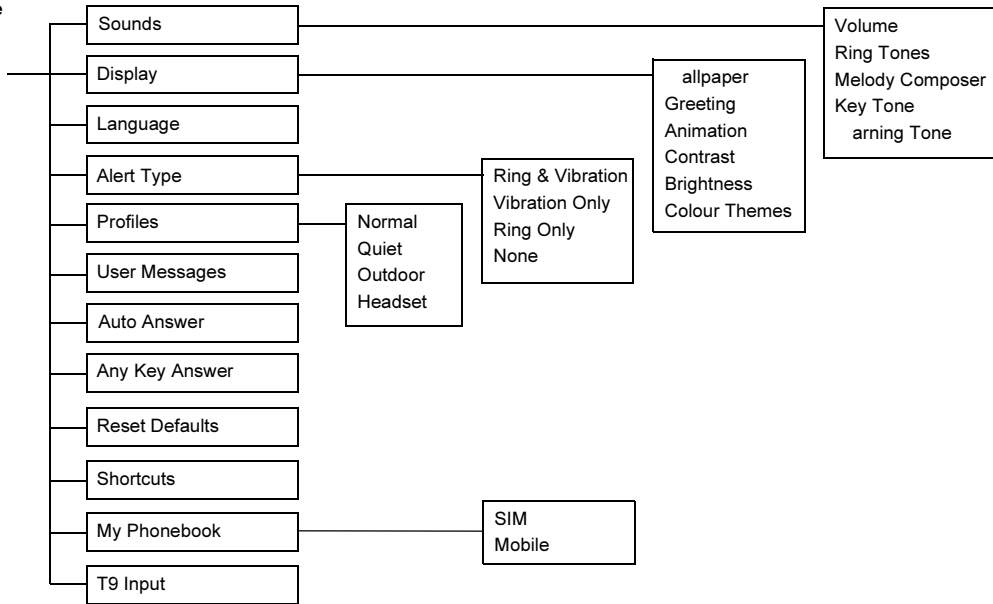







# My Phone

## Sounds









### Changing the Volume .....

From **My Phone** menu

- 1  **Sounds**  (Select)
- 2  **Volume**  (Select)
- 3  Adjust the volume level  (OK)

### Changing the Ring Tone .....

From **My Phone** menu

- 1  **Sounds**  (Select)
- 2  **Ring Tones**  (Select)
- 3  **Any Call, Group Calls, Alarm or Messages**  (Select)
- 4  desired ring tone  (Select)

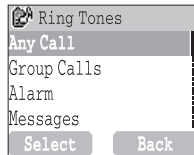

## Composing a Melody.....

From **My Phone** menu

- 1 **Sounds** (Select)
- 2 **Melody Composer** (Select)
- 3 desired MyMusic (Menu)
- 4 **Edit** (Select)
- 5 desired track (Menu)
- 6 Compose your melody - See the notes chart below > (Menu)
- 7 **Save** (Select)

You can arrange the **Tempo** and select an instrument (**Select Instrument**) before saving.











Using the following table as reference, enter notes (from the choice of low, middle and high), rests, and duration to generate your composition.

Main Track and Sub Tracks are combined when you return to **My Music**.

Key	 1	 abc	 def	 ghi	 jkl	 mno	 pqrs	 tuv
Note	C	D	E	F	G	A	B	Rep.
Key	 wxyz	 +	 *	 #				
Note	Dotted note	Rest	Duration	Low # Middle # High #				









### ***Rename a melody:***

From **My Phone** menu

- 1  **Sounds**  (Select)
- 2  **Melody Composer**  (Select)
- 3  desired music  (Menu)
- 4  **Rename**  (Select)
- 5 Enter a name
  - To erase a letter,  (Clear).
  - To erase all letters, press and hold  (Clear).
- 6  (OK)









### ***Set to Ringtone:***

From **My Phone** menu

- 1  **Sounds**  (Select)
- 2  **Melody Composer**  (Select)
- 3  desired music  (Menu)
- 4  **Set to Ringtone**  (Select)

### ***Viewing melody information:***

From **My Phone** menu

- 1  **Sounds**  (Select)
- 2  **Melody Composer**  (Select)
- 3  desired music  (Menu)
- 4  **Info**  (Select)

## Setting Key Tone .....

From **My Phone** menu

- 1  **Sounds**  (Select)
- 2  **Key Tone**  (On/off)

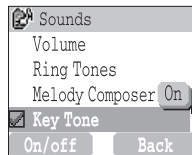

## Setting Warning Tone .....

From **My Phone** menu







- 1  **Sounds**  (Select)
- 2  **Warning Tone**  (On/off)

## Display

You can change the wallpaper that appears on the idle screen.

### Setting Wallpaper .....

From **My Phone** menu

- 1  **Display**  (Select)
- 2  **Wallpaper**  (Select)
- 3  desired wallpaper  (Select)
- 4  (On/off)

You can create a greeting message that is displayed each time the phone is powered on.

## Setting Greeting .....

From **My Phone** menu

- 1 **Display** (Select)
- 2 **Greeting** (Edit)
- 3 Enter the Greeting (OK)
- 4 (On/off)

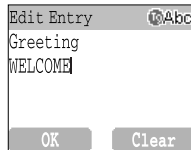

You can change animation that comes up on the display when the phone is switched on.

## Setting Display Animation .....

From **My Phone** menu

- 1 **Display** (Select)
- 2 **Animation** (Select)
- 3 desired Animation (Select)

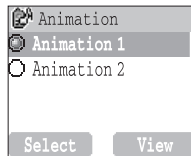

## Setting Display Contrast .....

From **My Phone** menu

- 1 **Display** (Select)
- 2 **Contrast** (Select)
- 3 Adjust the contrast (OK)

## Setting Brightness .....

From **My Phone** menu

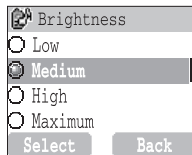

- 1  **Display**  (Select)
- 2  **Brightness**  (Select)
- 3  desired level  (Select)



You can change the Colour Themes on the display.

## Setting Colour Themes .....

From **My Phone** menu

- 1  **Display**  (Select)
- 2  **Colour Themes**  (Select)
- 3  desired colour  (Select)

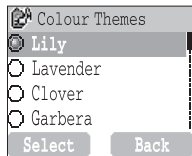

## Language

It is possible to change the language that the phone uses for display messages.

### Changing the Language .....

From **My Phone** menu

- 1  **Language**  (Select)
- 2  desired language  (Select)

## Alert Type

When required, the phone can be set up to vibrate and/or ring when a call is received.

You can change Alert Type:

- Ring & Vibration
- Vibration Only
- Ring Only
- None

### Changing Alert Type.....

From **My Phone** menu

- 1 **Alert Type** (Select)
- 2 desired Alert type (Select)

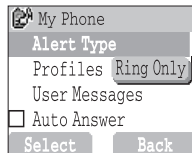

## Profiles

You can switch between four profiles in your phone each with a distinct combination of alert method, ring tone, etc. Profiles are set up for use in different environments – for instance you might want to use **Normal** profile for everyday setting, **Quiet** profile with ring tone appropriate for formal occasions, **Outdoor** profile for loud environments and **Headset** profile to vibrate when it is difficult to hear the ring tone.

### Activating a profile .....

From **My Phone** menu

- 1 **Profiles** (Select)
- 2 desired profile (Menu)
- 3 **Activate** (Select)

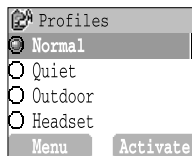

### Editing profiles.....

#### Ring Volume









From **My Phone** menu

- 1 **Profiles** (Select)
- 2 desired profile (Menu)
- 3 **Change Settings** (Select)
- 4 **Ring Volume** (Select)
- 5 Adjust volume level (OK)





**Key Tone**

From **My Phone** menu

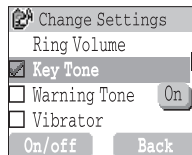
- 1  **Profiles**  (Select)
- 2  desired profile  (Menu)
- 3  **Change Settings**  (Select)
- 4  **Key Tone**  (On/off)







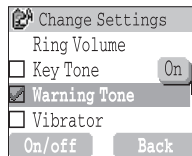

**Warning Tone**

From **My Phone** menu

- 1  **Profiles**  (Select)
- 2  desired profile  (Menu)
- 3  **Change Settings**  (Select)
- 4  **Warning Tone**  (On/off)

**Vibrator**

From **My Phone** menu

- 1  **Profiles**  (Select)
- 2  desired profile  (Menu)
- 3  **Change Settings**  (Select)
- 4  **Vibrator**  (On/off)

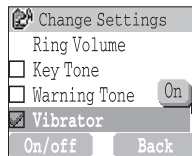

## Brightness

From **My Phone** menu

- 1 **Profiles** (Select)
- 2 desired profile (Menu)
- 3 **Change Settings** (Select)
- 4 **Brightness** (Select)
- 5 **Medium, High, Maximum or Low** (Select)

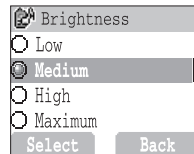

## User Messages

There are 10 pre-set common user messages and 5 empty spaces to create your own messages. You can also set User Messages at **User Messages** in **Message** menu. - see "Editing User Messages" on page 50.

### Editing User Messages .....

From **My Phone** menu

- 1 **User Messages** (Select)
- 2 desired message or empty space (Select)
- 3 Enter your message (Menu)
  - To erase a letter, (Clear).
  - To erase all letters, press and hold (Clear).
- 4 **Save and Send** or **Save** (Select)
- 5 When **Save and Send** is selected, enter destination phone number (OK)

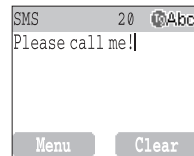



**NOTE:** If the text is wider than the screen display, the text will scroll.

Auto Answer can be set on. To use this function, Personal Handsfree Earpiece needs to be connected to the phone.

## Auto Answer



Setting Auto Answer .....

From **My Phone** menu  
 **Auto Answer**  (On/off)

## Any Key Answer





Calls can be answered by pressing any key (except ).

Setting Any Key Answer .....

From **My Phone** menu  
 **Any Key Answer**  (On/off)

## Reset Defaults

Reset Defaults .....

From **My Phone** menu  
 1  **Reset Defaults**  (Select)  
 2 **"Restore Factory Settings?"**  (No) or  (Yes)

## Shortcuts

### Setting Shortcuts.....

Shortcuts can be selected from the following options:

**Browser, Games, Phone Book, Language, Alert Type, Sounds, Wallpaper, Profiles, Alarm, Calculator, Scheduler, Inbox, Create, Clock Setting and Currency** to appear in your shortcuts menu.

From **My Phone** menu

- 1 **Shortcuts** (Select)
- 2 desired shortcuts (On/off)

#### Access to Shortcuts:

From Idle screen

- 1 desired shortcuts (Select)

## My Phonebook

### Setting SIM or Mobile Phonebook.....

You need to select between SIM Phonebook or Mobile Phonebook for your ordinary use. You can also set My Phonebook at **My Phonebook** in **Phonebook**. - see "My Phonebook" on page 42.

From **My Phone** menu

- 1 **My Phonebook** (Select)
- 2 **SIM or Mobile** (Select)

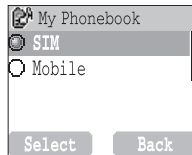

## T9 Input

### Setting T9 Input.....

When you enter text, this function dramatically reduces the number of key presses.

From **My Phone** menu

- 1 **T9 Input** (Select)
- 2 Set **T9 Prefer** on (On/off)
- 3 **Input Language** (Select)
- 4 desired language (Select)

See "Shift mode" on page 59 for detail.

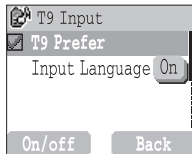



# Games

## Selecting Games

From **Games** menu

desired game (Select) from **Fillip** and **Classic rally**.

**NOTE:** Once the power is turned off, High scores or Best scores are lost.

The parts are scattered far and wide and some are stuck in the treetops where aggressive mosquitoes and grouchy birds live, and some have fallen into the water, where they are guarded by fierce piranhas.

### Fillip .....

#### Key Operation:

(move left), (move right), 1 (jump), (jump left),  
 (jump right).

#### Starting Games:

Select **Start game** by using (or (Up) and (Down)), then (Select).



The car can slide in the turns if you drive too fast and behaves like a real car. Drive your car as fast as you can. When you pass all the stations, you score.

### Classic rally .....

#### Key Operation:

(Forward), (Turn Left), (Turn Right), (Backward) to move the car.

#### Starting Games:

- 1 Select Start Game by pressing any numeric key except +
- 2 To choose your car, (or or ), then (Select).  
To choose a race course, (or or ), then (Select)

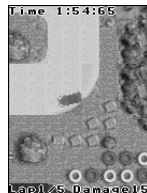

**NOTE:** If SIM card provides SIM Tool Kit services, this menu will become the STK Menu. You can still access Games from Applications.

# Phone Book Menu Structure

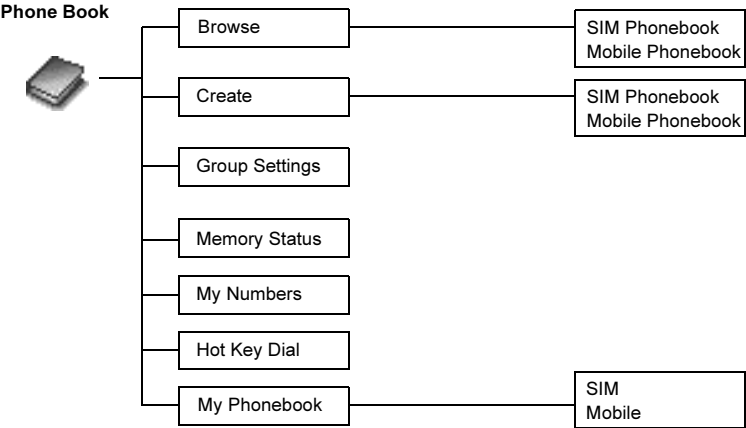

# Phone Book

## Storing

Phone numbers can be stored in SIM or in your phone.

In the SIM, you can store or select:

- Phone number
- Name

If you want to store a fixed dial number, see "Storing a Fixed Dial Number" on page 38.

### Storing a Number in SIM Phonebook .....

From **Phone Book** menu

- 1 **Create** (Select)
- 2 **SIM Phonebook** (Select)
- 3 Enter **Name** > **Phone** number
- 4 (Save)
  - "Saved in SIM" is displayed.

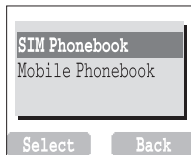

**NOTE:** The length and amount of data is SIM dependent.

In one Phonebook entry, you can store:

- Name
- 3 Phone Numbers (Phone, office, mobile)
- Caller's ID
- Groups
- Melodies

Phonebook entries can be grouped together. See Group Settings on page 40.

The entries stored in Mobile Phonebook are retained even if you damage the SIM.

### Storing a Number in Mobile Phonebook.....

From **Phone Book** menu

- 1 **Create** (Select)
- 2 **Mobile Phonebook** (Select)
- 3 Enter **Name**
- 4 Enter Phone number (**Phone, Tel./office, Tel./mobile**)
- 5 (Set) desired **Caller's ID Image** (Select)
- 6 (Set) desired group (Select)
- 7 (Set) desired melody (Select)
- 8 When entries are completed, (Save)
  - "Saved in Mobile" is displayed.

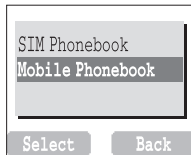



When Fixed Dial is set to On, only phone numbers in the Fixed Dial store can be dialed.

To activate this function, you need to set Fixed Dial on.  
- see "Setting Fixed Dial" on page 68.

## Storing a Fixed Dial Number .....

To store a fixed dial number, you need to enter PIN2 code.

From **Phone Book** menu

1  **Create**  (Select)

2 **SIM Phonebook**  (Select)

3 Enter **Name**  > **Phone** number

4  **Location**  (Set)

5  **FDN**  (Select)

6  (Save)

7 Enter PIN2 code





8  (OK)

## Viewing

You can search Phonebook by name.





### Browsing the Phone Book .....

From **Phone Book** menu

- 1  **Browse > SIM Phonebook or Mobile Phonebook**  (Select)
- 2  Search the name you wish to browse  (View)

## Options in Phone Book

From **Phone Book** menu

- 1  **Browse > SIM Phonebook or Mobile Phonebook**  (Select)
- 2  desired phone number  (Menu)

The following options are available by pressing  (Select)

<b>Edit</b>	Edit the selected Phone Book entry.
<b>Delete</b>	Delete the selected Phone Book entry.
<b>Delete All</b>	Delete all Phone Book entries.
<b>Copy to Mobile/SIM</b>	Copy the selected Phone Book entry to Mobile/SIM Phonebook.
<b>Copy All to Mobile/SIM</b>	Copy all Phone Book entries to Mobile/SIM Phonebook.
<b>Search</b>	Search for a desired item in Mobile/SIM Phonebook by entering the name.





## Group Settings

Your Mobile Phonebook entries can be placed into any of 5 groups;

**Friends, Colleagues, Family, Others** and **VIP**.

You can select a particular ring tone for each group to identify the incoming call.

From **Phone Book** menu

- 1  **Group Settings**  (Select)
- 2  desired Group  (Menu)

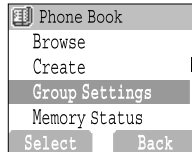

The following options are available by pressing  (Select).

<b>View Group</b>	View Phone Book entries in the selected group.
<b>Set Ring Tone</b>	Set desired ring tone for the group.
<b>Remove Entries</b>	Remove all Phone Book entries from the selected group.

After selecting desired Group in step 2, you can view a Phone Book entries by pressing  (View).

- When there is no entry stored in the selected group, "**List Empty**" is displayed.

The following options are available by pressing  (Menu).

<b>Edit</b>	Edit the selected Phone Book entry.
<b>Delete</b>	Delete the selected Phone Book entry.
<b>Search</b>	Search for an entry in the selected group by entering the name.

## Memory Status

Memory status shows how many locations are available in the Phone Book.

### Viewing Memory Status.....

From **Phone Book** menu  
☺ **Memory Status** ☺ (Select)

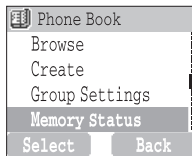

## My Numbers

My Number is a handy phonebook where your own names and phone numbers can be stored and viewed.

### Setting My Numbers.....

- From **Phone Book** menu
- 1 ☺ **My Numbers** ☺ (Select)
  - 2 ☺ desired entry ☺ (Menu)
  - 3 ☺ **Edit** ☺ (Select)
  - 4 Enter your phone number ☺
  - 5 Enter your name ☺ (Save)

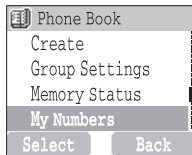



### Viewing My Numbers.....

- From **Phone Book** menu
- 1 ☺ **My Numbers** ☺ (Select)
  - 2 ☺ desired entry ☺ (View)

Phone numbers stored at locations 001 - 009 in the Phonebook can be dialed quickly.

## Hot Key Dial

### Setting Hot Key Dial.....

From **Phone Book** menu  
 **Hot Key Dial**  (On/off)

**NOTE:** This function is SIM dependent.

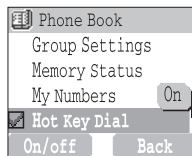





### Making a Call by Using Hot Key Dial.....

From **Idle** screen

- 1 Press and hold a digit key (1~9)
- 2 Press 

## My Phonebook

You need to select between SIM Phonebook or Mobile Phonebook for your ordinary use.

- From **Phone Book** menu
- 1  **My Phonebook**  (Select)
  - 2  **SIM or Mobile**  (Select)

- Please refer to "My Phonebook" on page 33.

# Browser Menu Structure

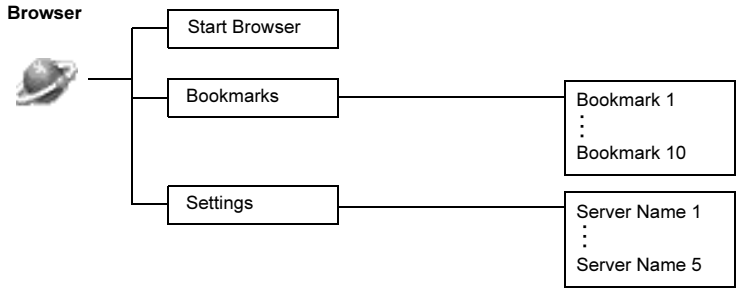

# Browser





The phone's WAP (Wireless Application Protocol) Browser enables you to access Internet services supported by the network, such as news, weather reports, sports, etc.

## Server Setting

Before Internet services can be accessed, you need to contact your network operator or Internet Service Provider (ISP) to obtain the relevant configuration information. Please contact your network service provider to ensure that your network settings are correct.

**NOTE:** Modifying the default settings may cause failure of the Browser.

From **Browser** menu

- 1  **Settings**  (Select)
- 2  to select desired server  (Edit)

Five server settings can be set up in the phone. If you find your server's name under the settings option, select the server and  (Edit). If no settings are present contact your Network Service Provider for these settings. (Server Name, IP Address, IP Port, Homepage, Linger Time, Select Mode)

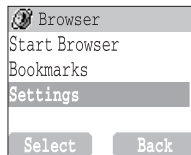

**NOTE:** You need to set **CSD Setting** or **GPRS Setting** in Phone Option before setting the server information.

Those configuration Options will be given by your network service provider.

Once completing the entry, press  (Save) then press  (Activate).

The first time that the browser is activated there will be no content stored so the Home URL content will be displayed (as defined by the network operator). The Home URL will be recalled from the cache each time the browser is activated. (Cache is the phone's memory that stores content downloaded in the past).

## WAP Activating

From **Browser** menu

1  **Start Browser**  (Select)

2 Please follow the instructions on the display.

- While browsing a homepage, press  for then the following menus.
- To end Browser, press and hold .

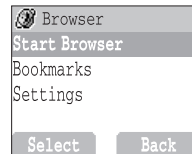

<b>Home</b>	Jump to the homepage which is set in <b>Settings</b> .
<b>Bookmarks</b>	Go to a WAP page you bookmarked. See Setting Bookmarks on page 46.
<b>Save Items</b>	Save items on current WAP page.
<b>Reload</b>	Reload the current WAP page.
<b>Go To URL</b>	Enter URL address.
<b>Show URL</b>	Display the URL address of the current WAP page.
<b>SnapShots</b>	Capture the screen of the current WAP page.
<b>Advanced</b>	<b>Inbox</b> , <b>Restart Browser</b> and <b>About</b> are available to select.
<b>Settings</b>	<b>Scroll Mode</b> , <b>Downloads</b> , <b>Security</b> and <b>Send Referrer</b> are available to set.









Once you bookmark your favorite page, you can quickly jump to the page by selecting the bookmark.

## Bookmarks





### Setting Bookmarks .....

#### *Entering URL from Browser menu:*

From **Browser** menu

- 1  **Bookmarks**  (Select)
- 2  desired Bookmark field  (Menu)
- 3  **Edit**  (Select)
- 4 Enter Title and URL  (Save)

#### *Setting Bookmark from Homepage:*

- 1  **Start Browser**  (Select)
- 2  **Bookmarks**
- 3 **Mark Site** 
- 4 Enter **Folder** and **URL**
- 5  (Save)

### Browsing Bookmark .....

From **Browser** menu

- 1  **Bookmarks**  (Select)
- 2  desired Bookmark  (Launch)

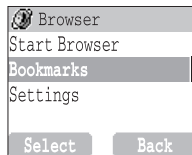



# Key Guard

Key Guard is used to prevent any keys from being accidentally pressed e.g. when the phone is being carried.

## Setting Key Guard .....

From **Key Guard** menu

 (Yes) or  (No)

- When Key Guard is enabled, **On** appears on the display.
- Emergency calls can still be made.
- When a call is received, Key Guard will be disabled temporarily, and you can answer the call.



**NOTE:** When making emergency calls with the "Key Guard" enabled, there will be no visual indication that the number is being dialed.

## Disabling Key Guard.....

When **On** appears on the display,

- 1  (Free)
- 2 "Press OK to Free keypad"  (OK)

# Messages Menu Structure

Messages

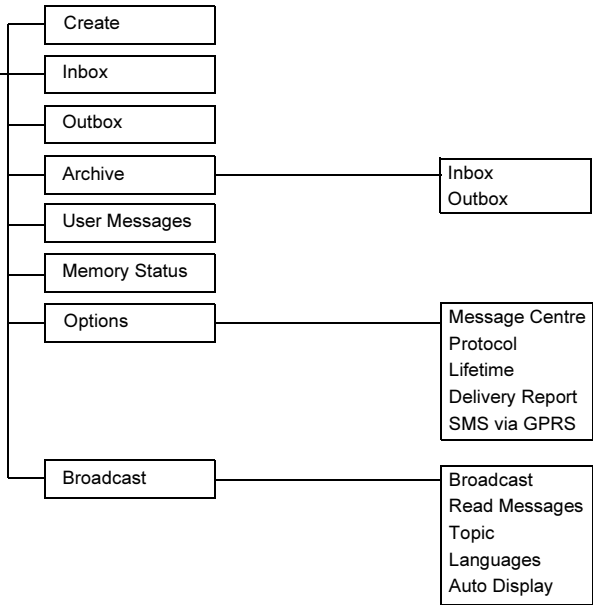

# Messages

It is possible to receive, display, edit and/or send text messages of up to 1520 characters in ten messages (depending on language), to a network that has a roaming agreement (depending on the recipient's phone Options). Before sending a message, you need to enter the Message Centre number into Options.

## SMS

### Setting the Message Centre Number.....

From **Messages** menu

- 1 **Options** > **Message Centre** (Select)
- 2 Enter message centre number in international dial format  
(see "International Dialing" on page 17) (OK)

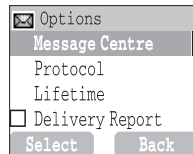



**NOTE:** Your network operator may have pre-installed the number. Do not change this number as it may cause failure of SMS Messaging.

### Creating a New Short Text Message.....

From **Messages** menu

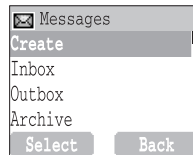
- 1 **Create** (Select)
- 2 Create your text message – max. 1520 characters  
(see "Text Entry" on page 58) (Menu)
- 3 **Send** (Select)
- 4 Enter the destination phone number (OK)  
OR  
Recall a number from the Phonebook (Names) >  
 desired name (Select) > (OK)









When you create a text message, these options are available by  (Menu).

<b>Send</b>	Send your text message.
<b>Save</b>	Save your message in Outbox in SIM.
<b>Save and Send</b>	Save your message in the Outbox in SIM and send.
<b>Picture &amp; Sound</b>	Add picture and/or sound to your message.
<b>User Messages</b>	Use a short message stored in the phone. For editing the User Message, see "Editing User Messages" below.

### Editing User Messages .....



User messages are common phrases that you can place in your message, then fill in the rest of the sentence.

From **Messages** menu

- 1  **User Messages**  (Select)
- 2  desired message  (Select)
- 3 Edit the message  (Menu)
  -  **Save and Send** or **Save**  (Select)

**NOTE:** When the text is wider than the screen display, the text will scroll.

When a Short Text Message is received, the message indicator will flash on the display and a user preset audible alert will sound. If you are on a call, the phone will vibrate.

 flashes when an unread message is received in the Inbox. When the Inbox is full,  will remain until old messages are deleted.

## Reading a Received Message .....

From **Messages** menu

- 1  **Inbox**  (Select)
- 2  desired message  (Read)

- Inbox: The received message will be stored in **Inbox**.

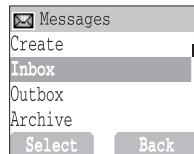

**NOTE:** If the message indicator is displayed constantly (does not flash), this means that the message area is full and you need to delete old messages in order to receive new messages.

While you are reading a message, the following options are available by  (Menu).

<b>Delete</b>	Delete a message.
<b>Reply</b>	Reply to a message.
<b>Forward</b>	Forward a message to another phone.
<b>Edit</b>	Edit a message and save and/or send to another.
<b>Delete All</b>	Delete all messages in Inbox.
<b>Extract Number</b>	Extract numbers in messages and save in Phonebook.
<b>Move to Archive</b>	Move a message into Inbox in Archive.
<b>Hyperlink</b>	Link to a URL in a received message.

## Viewing Message Lists in Outbox .....

View message lists that are stored in SIM.

- Outbox: Sent messages are stored in **Outbox**.

From **Message** menu

1  **Outbox**  (Select)

2  desired message  (Read)

While you are reading a message, the following options are available by  (Menu).





<b>Delete</b>	Delete a message.
<b>Edit</b>	Edit a message and save and/or send to another.
<b>Send</b>	Send an SMS message after entering a recipient number.
<b>Delete All</b>	Delete all messages in Outbox.
<b>Extract Number</b>	Extract numbers in messages and save in Phonebook.
<b>Move to Archive</b>	Move a message from Outbox to Outbox in Archive.

## Viewing Message Lists in Archive .....

View message lists which are stored in Archive.

- Inbox: When a message in Inbox is saved, the message will be saved to **Inbox in Archive**.
- Outbox: When a sent message in Outbox is saved, the message will be saved to **Outbox in Archive**.

From **Message** menu

- 1 **Archive**  (Select)
- 2  **Inbox/Outbox**  (Select)
- 3  desired message  (View)

While you are reading a message, the following options are available by  (Menu).

<b>Delete</b>	Delete a message.
<b>Edit</b>	Edit a message and save and/or send to another.
<b>Forward (Inbox)/ Send (Outbox)</b>	Forward/Send a message to another phone.
<b>Delete All</b>	Delete all messages in Inbox.



Memory status shows how many locations are left for storing messages in the Inbox.

## Viewing Memory Status.....

From **Messages** menu

 **Memory Status**  (Select)

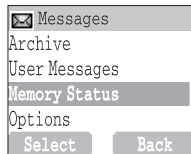

## Options

### Setting Options.....

From **Messages** menu

 **Options**  (Select)

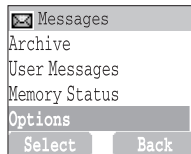

**NOTE:** In an area where GPRS is not supported, SMS may not be sent when **SMS via GPRS** is on.

The following options are available:

<b>Message Centre</b>	Edit Message Centre number.
<b>Protocol</b>	Select desired Message Type from <b>Standard Text, Fax, X.400, Paging, E-mail, ERMES, Voicemail.</b>
<b>Lifetime</b>	Select maximum or choose a time limit for sending messages.
<b>Delivery Report</b>	Request a delivery report on the status of a sent message.
<b>SMS via GPRS</b>	Send a Short Text message via GPRS.

## Broadcast

You can receive your favorite information regularly from your service provider.

First, specify which information topics, such as traffic reports, you wish to receive and which language the topics will be presented in. To receive the broadcasts, "Broadcast" needs to be on.

Add topics in which you wish to receive information.

If you know the topic names, add them here.

### Setting Broadcast.....

From **Messages** menu

- 1 **Broadcast** (Select)
- 2 **Broadcast** (On/off)

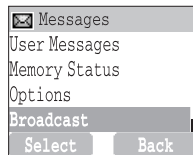

### Setting Topic .....

From **Messages** menu

- 1 **Broadcast > Topic > Current** (Select)
- 2 desired **Topic** (Menu)
- 3 **Add or Delete** (Select)

### Setting User defined Topic.....





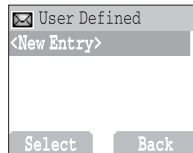





From **Messages** menu

- 1 **Broadcast > Topic > User Defined > <New entry>** (Select)
- 2 **Enter Msg ID** (OK)
- 3 **Enter Name** (OK)
- 4 **Current** (Select)
- 5 **<Add Topic>** (Select)
- 6 desired **Topic** (Select)



## Setting Language .....

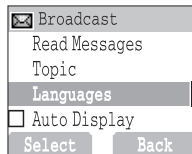

From **Messages** menu

- 1  **Broadcast**  (Select)
- 2  **Languages**  (Select)
- 3  desired Language  (Select)
- 4 To continue to add languages;
  -  **Insert**  (Select)
  - To complete adding language;
  -  **Add to End**  (Select)



## Viewing Broadcast .....

From **Messages** menu

- 1  **Broadcast > Read Messages**  (Select)
- 2 To scroll to the available topics  (Next)

**NOTE:** This function depends on your Network Service Operator.

The latest Broadcast message can be displayed on your phone automatically.

## Auto Display

### Setting Auto Display .....

From **Messages** menu





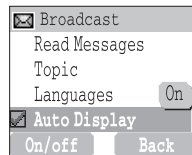







1  **Broadcast**  (Select)

2  **Auto Display**  (On/off)



# Text Entry

You can use alphanumeric characters to enter details into the Phonebook, to create text, etc.

Key	Text Mode		Numeric (0 ~ 9)
	T9®(T9Abc, T9abc, T9ABC) (Input language: English)	Multi tap (Input mode indicator: Abc, abc or ABC)	
	Punctuation 1	Space 0 . , ? ! + - = : ; ' " ' ; _	0
	Punctuation 2	1 / ( ) < > [ ] { } % ~ & (1 / ( ) < > [ ] { } % ~ € &)	1
	A B C (a b c)	A B C 2 Ä (a b c 2 ä à ç)	2
	D E F (d e f)	D E F 3 É (d e f 3 é è)	3
	G H I (g h i)	G H I 4 (g h i 4 i)	4
	J K L (j k l)	J K L 5 (j k l 5)	5
	M N O (m n o)	M N O 6 Ö Ñ (m n o 6 ö ñ ò)	6
	P Q R S (p q r s)	P Q R S 7 (p q r s 7 ß)	7
	T U V (t u v)	T U V 8 Ü (t u v 8 ü ù)	8
	X Y Z (w x y z)	W X Y Z 9 Æ Ø Å (w x y z 9 æ ø å)	9
	Shift mode	Shift mode	Shift mode
	* Γ Δ Θ Λ Ξ Π Σ Φ Ψ Ω	* Γ Δ Θ Λ Ξ Π Σ Φ Ψ Ω	*
	Alternatives / (Hold) Space # £ \$ ¥ ¤ @ \ \$ ^   _ ↓	Alternatives / (Hold) Space # £ \$ ¥ ¤ @ \ \$ ^   _ ↓	#

**Note:** Displayed characters of T9® vary depending on the selected input language.

## Shift mode

Shift mode change .....

The Shift mode changes by pressing (within 1 sec) .

<b>Multi tap</b>	<b>T9®</b>
Abc → abc → ABC	T9Abc → T9abc → T9ABC

If Input mode is changed, Shift mode is initialised.

Auto capital change .....

Auto capital affects Abc and T9Abc.

When Input mode is changed to Abc or T9Abc, the first character is input as upper case and subsequent letters as lower case.

When one of the following characters [. (Period) or ! or ?] is input before a space, the next character is input as upper case.

## T9® Dictionary

When edit mode is finished, all words in the editor are registered in the T9® dictionary.

## Text Input

To switch On/Off T9 mode, press .







## T9® Text Input .....

Using this mode of text input dramatically reduces the required number of key presses.

Press a key once for any letter you require on that key. The desired letter may not be displayed. Continue pressing other keys until the end of a word is reached; then check that the word has been typed correctly before continuing on to the next word. If the combination of letters typed has produced a word which is not the one you require, press  repeatedly until the correct word is displayed. Continue to the next word.

### Example of Text Input in T9® Mode

To type a new message, follow these steps:

- 1 At the beginning of a new message press and hold  (Clear) to delete previous text, if necessary.
- 2 Press  to change letter case, if necessary
- 3 Press     "Call" is displayed.

Note that the displayed words change as you type, always type to the end of the word before editing.

T9® Languages can be selected from T9® Input -see "Setting T9 Input" on page 33.

If the word you require is not in the internal dictionary then it should be entered using the Multi tap (ABC) mode.

## Other Text Modes .....

Select text mode (displayed in Information area on screen).

### Multi tap mode (Abc, abc or ABC):

Each time a key is pressed in quick succession it displays the next character available on that key. Releasing the key or pressing another key enters the character displayed. The cursor moves to the next position.

In T9 (Abc) or Multi tap (Abc) mode, the first entered letter in a sentence is in upper case.

# Phone Option Menu

# Structure

Phone Option

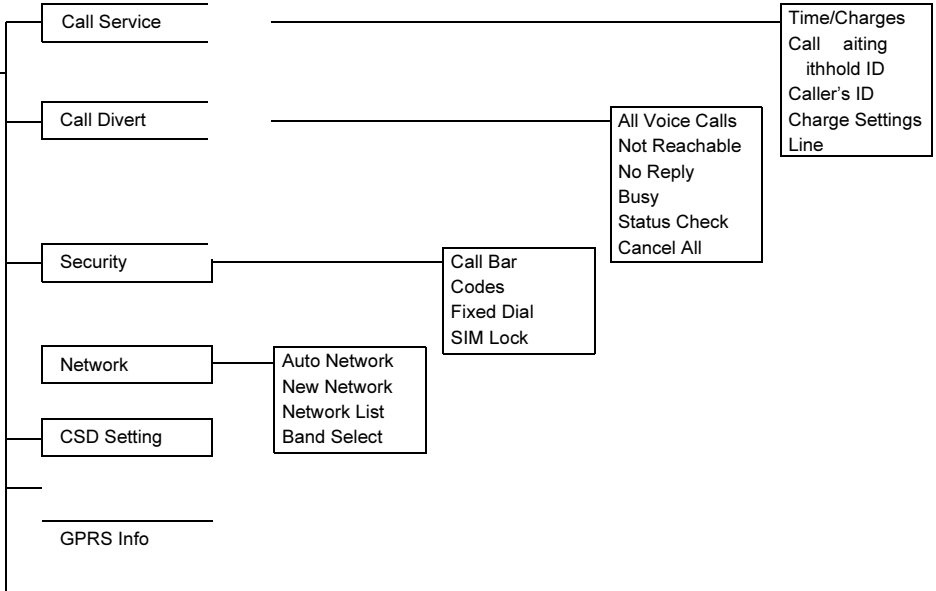



# Phone Option

## Call Service

The duration of the **Last Call** and **All Voice Calls** will be displayed. When the **Max Cost** is on, the remaining units will be displayed.

### Viewing Time/Charges .....

From **Phone Option** menu

- 1 **Call Service > Time/Charges** (Select)
- 2 desired service **Last Call, All Voice Calls or Cost Left** (Select)

<b>Last Call</b>	Display the duration of Last Call.
<b>All Voice Calls</b>	Display the sum of the duration for the all voice calls.
<b>Cost Left</b>	When <b>Max Cost</b> is on, display the remaining units. For setting the <b>Max Cost</b> , see "Setting the Maximum Cost:" on page 64.

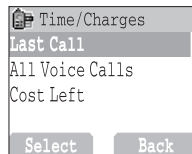

When **Call Waiting** is switched on, a second call can be received.

Turn this function on before making a multiparty call.

### Setting Call Waiting .....

From **Phone Option** menu

- 1 **Call Service > Call Waiting** (Select)
- 2 **Set** (Select)

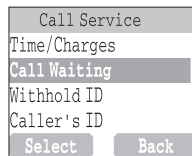

**Withhold ID** allows you to prevent showing your name and/or number to your calling party. You can also select **Cancel** or **Check Status**.

## Setting Withhold ID.....

From **Phone Option** menu

- 1 **Call Service** (Select)
- 2 **Withhold ID** (Select)

**NOTE:** When checking the status, the phone must be registered to a network.

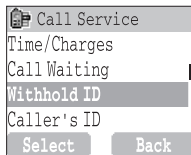

**Caller's ID** shows the Caller's name and/or number on your display. You can also select **Cancel** or **Check Status**.

The list of picture files used in Caller's ID is viewed in Viewing Picture of Caller's ID on page 80.

## Setting Caller's ID.....

From **Phone Option** menu

- 1 **Call Service** (Select)
- 2 **Caller's ID** (Select)

**NOTE:** When checking the status the phone must be registered to a network.

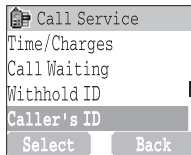

First, enter Personal rate which is the cost that the Service Provider charges for one unit of call time.

**NOTE:** Charge Setting is SIM dependent.

## Charge Settings.....

### Setting Currency:

From **Phone Option** menu

- 1 **Call Service** > **Charge Settings** (Select)
- 2 **Currency** (Select)
  - Current Setting is displayed.
- 3 (Set) > Enter PIN2 code (OK)
- 4 Enter currency units (max. 3 characters) (OK)

**NOTE:** When you set the unit price, you will be asked to enter your PIN2.

**NOTE:** This function is SIM dependent.

You can set the maximum cost of calls allowed.

**NOTE:** The duration of one unit may vary between peak and off-peak times. Call charges can be calculated according to the calling time. However, the actual tariffs charged from your service provider may not be reflected in the calculation.

**NOTE:** This function is SIM dependent.

In Idle mode, the latest Incoming call is displayed on your phone automatically.

### Setting Personal Rate:

From **Phone Option** menu

- 1 **Call Service** > **Charge Settings** > **Personal Rate** (Select)
- 2 (Set)
- 3 Enter PIN2 code (OK)
- 4 Press desired personal rate (OK)

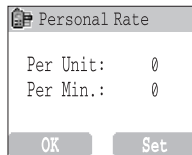

### Setting the Maximum Cost:

From **Phone Option** menu

- 1 **Call Service** > **Charge Settings** (Select)
- 2 **Max Cost** (Set)
  - Current setting is displayed.
- 3 (Edit) > Enter PIN2 code (OK)
- 4 (Set) > **On** (Select)
- 5 Enter **Credit Limit** > (OK)

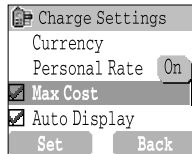

### Setting Auto Display:

From **Phone Option** menu

- 1 **Call Service** > **Charge Settings** (Select)
- 2 **Auto Display** (On/off)

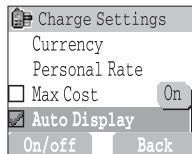

This menu can be selected only when your SIM supports CPHS and Line 1/2.

**NOTE:** This function is SIM dependent.

## Setting Phone Line.....

From **Phone Option** menu

- 1 **Call Service > Line** (Select)
- 2 **Line 1/Line 2** (Select)

## Call Divert

Voice calls can be diverted in different situations and to different numbers.

For example, you may wish voice calls to be diverted to voicemail box when the phone is switched off.

appears when you have received new voice mail messages.

This service depends on your service provider.

## Setting Call Divert.....

From **Phone Option** menu

- 1 **Call Divert** (Select)
- 2 Select the circumstances to initiate the divert (Select)
- 3 desired operation from **Set**, **Clear**, or **Check Status** (Select)
- 4 Enter phone number to divert to

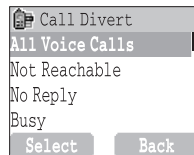

- when a divert situation is enabled the divert icon (☞) is displayed.
- when updating or checking the status of **Call Divert** the phone must be registered to a network. (T)









<b>All Voice Calls</b>	Divert all incoming voice calls.
<b>Not Reachable</b>	When phone is disconnected, divert incoming voice calls.
<b>No Reply</b>	If call is not answered, divert incoming voice calls.
<b>Busy</b>	When a call is in progress, divert incoming voice calls.
<b>Status Check</b>	Check the current Call Divert status.
<b>Cancel All</b>	Cancel all Call Divert settings.

Call Barring restricts certain outgoing and/or incoming calls using a password supplied by your service provider. When updating/checking the status of Call Bar the phone must be registered with a network.

## Security

### Setting Call Bar .....

From **Phone Option** menu

- 1  **Security > Call Bar**  (Select)
- 2  desired setting from the menus showing below  (Set) or  (Select)
- 3  desired operation from **Set, Clear** or **Check Status**  (Select)
- 4 Enter desired password  (Select)

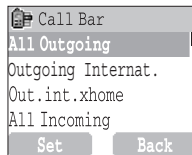

<b>All Outgoing</b>	All Outgoing calls are barred.
<b>Outgoing Internat.</b>	International Outgoing calls are barred.
<b>Out.int.xhome</b>	International Outgoing calls except home are barred.
<b>All Incoming</b>	All Incoming calls are barred.
<b>When Roaming</b>	All incoming calls when roaming outside the home network.
<b>Status Check</b>	Call bar status is displayed.
<b>Cancel All</b>	Cancel all Call Bar settings.
<b>Password</b>	Change Call Bar Password.

Setting up Phonecode enables your phone to temporarily disable SIM Lock, even if you forget your PIN number or replace your SIM with another one.

The PIN protects your SIM against unauthorised use. If you enable the PIN, every time the phone is switched on you will be prompted to enter the PIN.

The PIN2 controls security for the Fixed Dial Store, Call Charge metering and Barred Dial.

If either PIN/PIN2 is entered incorrectly **3 times** the phone will be locked and you will need to enter the PUK/PUK2 code. Contact the service provider for the PUK/PUK2 code.

**NOTE:** To enter PUK code for PIN, enter \*\*05# you will then be prompted to enter the PUK code, then follow the on-screen instructions. To enter PUK2 code for PIN2, enter \*\*052# you will then be prompted to enter the PUK2 code, then follow the on-screen instructions.

## Codes

### Change Phonecode.....

From **Phone Option** menu

- 1 **Security > Codes** (Select)
- 2 **Change Phonecode** (Select) > Enter the current Phonecode, if needed (OK)
- 3 Enter New Phonecode (OK) > Repeat the entry (OK)

### Enabling/Disabling the PIN.....

From **Phone Option** menu

- 1 **Security > Codes** (Select)
- 2 **PIN Control** (Set)
- 3 Enter PIN number (OK) > Repeat the entry (OK)

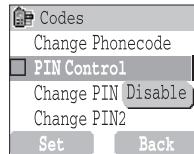

### Changing the Security Code.....

From **Phone Option** menu

- 1 **Security > Codes** (Select)
- 2 **Change PIN or Change PIN2** (Select)
- 3 Enter the current code (OK)
- 4 Enter the new code (OK)
- 5 Enter the new code to verify (OK)

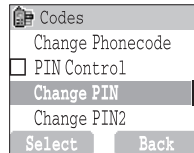









**NOTE:** If the PUK/PUK2 code is entered incorrectly 10 times, the phone will cease to operate permanently. All information stored in the SIM will be lost and the SIM will need to be replaced. Contact the service provider for more details.

Fixed Dial is one of the functions in SIM Phonebook. Only numbers stored in your SIM Phonebook can be selected for FDN dialing. To enter fixed dial numbers, see "Storing a Fixed Dial Number" on page 38.

## Setting Fixed Dial .....

From **Phone Option** menu

- 1  **Security**  (Select)
- 2  **Fixed Dial**  (Select)
- 3 Enter PIN2 code  (OK)
- 4  (FDN) >  **On**
- 5  (OK)

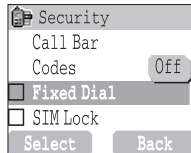

- Any manually dialed phone numbers must be the same as the numbers in the Fixed Dial Store.
- A phone number may be stored, edited or deleted. You will be prompted for your PIN2 code.

## Setting SIM Lock .....

From **Phone Option** menu

- 1  **Security**  (Select)
- 2  **SIM Lock**  (Select)
- 3 Enter Phonecode  (OK)

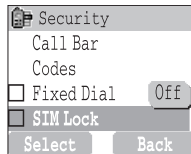

**NOTE:** You are advised to write down your Phonecode. In case you forget your phonecode, you will need to contact your service provider to unlock the SIM.

## Network

You can select a network that is available in your current location.

**NOTE:** This function is SIM dependent.

### Network setting.....

From **Phone Option** menu

- 1 **Network** (Select)
- 2 desired option (On/off) or (Select)

<b>Auto Network</b>	Set "Auto Network" On or Off.
<b>New Network</b>	When "Auto Network" is on; Search an available network automatically. When "Auto Network" is off; Select a network manually.
<b>Network List</b>	Create and edit a network list according to your preferences.
<b>Band Select</b>	Choose a network band: 1800, 1900, 850, 850/1900MHz.

## CSD Setting

Complete CSD setting before you set up your browser server.

- see "Server Setting" on page 44.

Contact your network service provider or Internet service provider for these settings.

### Connection Setting.....

You can set CSD (Circuit Switched Data) setting when connecting to network.

From **Phone Option** menu

- 1 **CSD Setting** (Select)
- 2 desired setting (Select)
- 3 when all the data are entered, (Save)

<b>Server Name</b>	Enter Server Name.
<b>Call Type</b>	Select ISDN or Analogue.
<b>Dial Number</b>	Enter the common numbers in Digital and Analogue.
<b>Login Name</b>	Enter Login ID.
<b>Password</b>	Enter Password.



Complete GPRS setting before you set up your browser server.

- see "Server Setting" on page 44.





Contact your network service provider or Internet service provider for these settings.

## GPRS Setting

### Connection Setting .....

You can set GPRS (General Packet Radio Service) setting when connecting to network.

From **Phone Option** menu

- 1  **GPRS Setting**  (Select)
- 2  desired setting  (Select)
- 3 when all the data are entered,  (Save)





- When GPRS setting is completed, the GPRS icon (  ) is displayed.

<b>Server Name</b>	Enter Server Name.
<b>GPRS APN</b>	Enter Access Point Name.
<b>Login Name</b>	Enter Login ID.
<b>Password</b>	Enter Password.
<b>Authentication</b>	Select Activate or Deactivate.

## GPRS Info

### Viewing GPRS Information .....

From **Phone Option** menu







- 1  **GPRS Info**  (Select)
- 2 To reset GPRS Info;  
 (Reset) >  (Yes)

Allows a hearing impaired person to use the phone by connecting a TTY device.

## Text Telephony

### TTY Mode .....

From **Phone Option** menu

- 1  **Text Telephony**  (Select)
- 2  **CTM Control**  (Select)
- 3  **Enable or Disabled**  (Select)

- When TTY mode is enabled, any accessory that is connected through the Headset/TTY connector is assumed to be a TTY device. TTY mode must be enabled to send and receive TTY calls. When making a TTY call, plug in the TTY device before making the call. If TTY is enabled, the TTY icon () displays.

# Applications Menu Structure

Applications

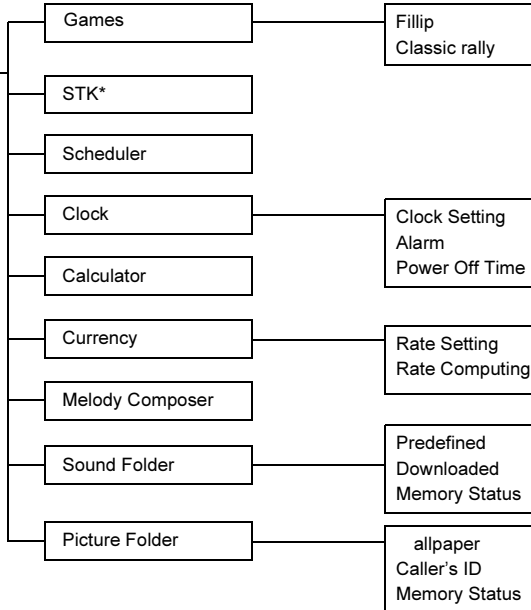





**\*NOTE:** STK (SIM Tool Kit) is SIM dependent.

# Applications

## Games

From **Applications** menu

- 1  **Games**  (Select)
- 2  desired game  (Select).

• Please refer to "Games" on page 35.



## STK (SIM Tool Kit)

This function is SIM dependent.

You can keep track of your schedule to remind you of events such as meetings or a vacation. The clock must be set first before creating a Scheduler entry.

In the Scheduler, you can store:









- Type (Memo or Meeting)
- Description
- Start Date
- Start Time
- End Date
- End Time

**NOTE:** Ensure that the setting of the Scheduler will not contravene any regulations whereby it may automatically power on when in an aircraft or medical facility, etc. - see "Important Information" on page 1.

## Scheduler











### Entering a Schedule .....

From **Applications** menu

- 1  **Scheduler**  (Select)
- 2  to select **Week** or **Month** format
- 3 To select a day, press numerical keys 2, 8, 4 and 6 to move the cursor ↑, ↓, ← and →, or  to move the cursor ↑ or ↓ to set a day. >  (Agenda)
- 4  **<New Entry>**  (Select)
- 5 Enter desired information
- 6  (Save)

### Viewing / Editing Scheduler .....

From **Applications** menu

- 1  **Scheduler**  (Select)
- 2  to select **Week** or **Month** format
- 3 When Month format is selected:  
Select a day marked in blue by using the numerical keys (2, 8, 4 and 6) >  (Agenda)  
When Week format is selected:  
Schedule icon(s) will be shown corresponding to a period of time selected by pressing .  
(Period of time: no icon =0:00-0:59, 4=1:00-4:59, 8=5:00-8:59, 12=9:00-12:59, 16=13:00-16:59, 20=17:00-20:59, 24=21:00-23:59)  
Select a day by using the numeric keys (2, 8, 4 and 6) >  (Agenda)
- 4  desired schedule  (View)
- 5 To return to the previous display,  (OK)  
To edit,  (Edit) edit desired information  (Save)

## Clock

Time and date can be shown on the idle screen.

### Time Display Setting.....









From **Applications** menu

- 1  **Clock > Clock Setting**  (Select)
- 2  **Display Time**  (On/off)

Before setting Time & Date, set Time Zone of your region or the city which has same time zone as your region. When travelling abroad, your home time can be changed to your destination time.





### Time Zone Setting.....

From **Applications** menu

- 1  **Clock > Clock Setting > Time Zone**  (Select)
- 2  required region  (Select)
- 3  (Yes) or  (No) to select "Day Light Saving?"
- 4 "Set This City to Local"  (OK)
- 5 "Success!"  (OK)

### Time & Date Setting .....





From **Applications** menu

- 1  **Clock > Clock Setting > Time & Date**  (Select)
- 2  (Set) enter the digits for the time  (OK)

Display format for time and date can be selected.

## Date Format/Time Format .....





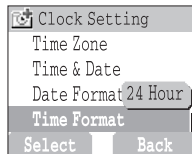

From **Applications** menu

- 1  **Clock** > **Clock Setting** > **Date Format** or **Time Format**  (Select)
- 2  desired format  (Select)



## Alarm Setting .....

From **Applications** menu

- 1  **Clock** > **Alarm**  (Select)
- 2  (Set) > Enter the digits for the time (24 hour clock)  (OK)
- 3  Select from **Repeat Daily**, **Once** or **Disabled**  (Select)
- 4 **"Alarm Time Has Been Updated!"**  (OK)

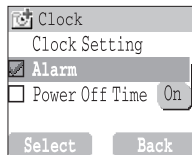

- Alarm set indicator  appears on idle display.
- When the set time is reached, the alarm will sound, or the phone will vibrate if you are on a call.

### *To end alarm:*

Press any key or  (OFF)







OR  (Pause) to pause the alarm and start again after 5 minutes

**NOTE:** Even if the phone is switched off, when the Alarm is set on, the phone will automatically power on and start the alarm. Please ensure that your Alarm setting will not contravene any regulations in an aircraft or medical facility etc. - see "Important Information" on page 1.

The phone can be set to turn itself off automatically at a specified time using the Power Off feature. The procedure for setting/adjusting the Power Off automatically is similar to the Alarm setting.

## Power Off Time .....

From **Applications** menu



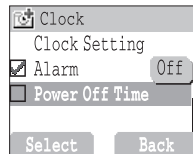



- 1  **Clock** > **Power Off Time**  (Select)
- 2 Enter the digits for the time (24 hour clock)  (OK)
- 3  Select from **Repeat Daily**, **Once** or **Disabled**  (Select)
- 4 **"Power Off Time Setting Updated!"**  (OK)



## Calculator

The four function calculator (addition, subtraction, multiplication and division) is available to make simple arithmetic calculations.

From **Applications** menu

- 1  **Calculator**  (Select)
- 2 Enter a number (maximum 7 digits) and it will be displayed on the upper right of the display. When a decimal point is required, press  , when a minus sign is needed press  .
- 3  to select the arithmetic operation
- 4 Enter a number (maximum 7 digits) and it will be displayed next to the operation symbol. If  is used to select another arithmetical operation to perform, an intermediate calculation will be performed and the result displayed on the top line.
- 5  (=) to calculate

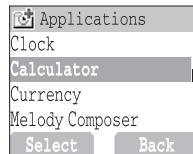









The currency convertor enables you to convert from/to a home currency using a conversion rate that you enter.

## Currency

### Setting the currency value.....



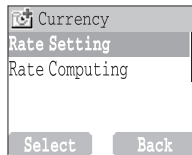

From **Applications** menu

- 1  **Currency**  (Select)
- 2  **Rate Setting**  (Select)
- 3 On the right side of the screen, enter your home currency rate to the currency which you want to convert with  (OK)
- 4  (Save)



### Rate Computing.....

From **Applications** menu

- 1  **Currency**  (Select)
- 2  **Rate Computing**  (Select)
- 3 Enter the amount of currency which you want to convert into your home currency  (Convert)

## Melody Composer

Please refer to "Composing a Melody" on page 24.











## Sound Folder

The Sound Folder contains predefined sound files and any downloaded sound files. You can play the sound and set one as your Ringtone.

The memory status is dependant on file sizes stored in the Melody Composer, Picture Folder and Sound Folder.





### *Setting Ringtone:*

From **Applications** menu

- 1  **Sound Folder**  (Select)
- 2  **Predefined or Downloaded**  (Select)
- 3  desired sound  (Menu)
  - To see the information of the selected Ringtone,  **Info**  (Select)
  - To return to the previous menu,  (OK)
- 4  **Set to Ringtone**  (Select)

### *Viewing Memory Status:*

From **Applications** menu

- 1  **Sound Folder**  (Select)
- 2  **Memory Status**  (Select)
  - **Free Space** and **Total Used** are displayed.
  - To return to the previous menu,  (OK)

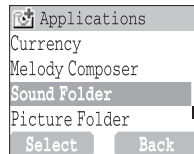

## Picture Folder

You can find lists of predefined pictures and downloaded pictures in both Wallpaper folder and Caller ID folder. You can view those pictures, and also set one of them for the idle screen.

The memory status is dependant on file sizes stored in the Melody Composer, Picture Folder and Sound Folder.

To set up Caller's ID, see Setting Caller's ID on page 63.

### *Setting Wallpaper:*

From **Applications** menu

- 1 **Picture Folder** (Select) > **Wallpaper** (Select)
- 2 **Predefined or Downloaded** (Select)
- 3 desired picture (Menu)
  - To see the large picture, **View** (Select)
  - To return to the previous menu, (Back)
- 4 **Set to Wallpaper** (Select)

### *Viewing Picture of Caller's ID:*

From **Applications** menu

- 1 **Picture Folder** (Select) > **Caller's ID** (Select)
- 2 **Predefined or Downloaded** (Select)
- 3 desired picture (Menu)
- 4 **View or Info** (Select)
  - To return to the previous menu, (Back)

### *Viewing Memory Status:*

From **Applications** menu

- 1 **Picture Folder** (Select)
- 2 **Memory Status** (Select)
  - **Free Space** and **Total Used** are displayed.
  - To return to the previous menu, (OK)

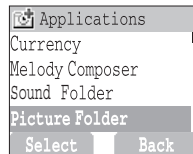

# Records Menu Structure

Records

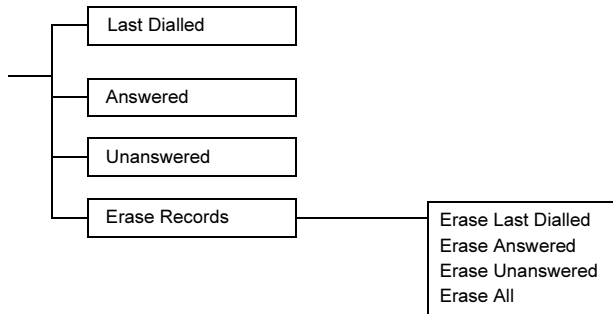

# Records

Recently dialed phone numbers will be stored in **Last Dialed**. (Max 50)

If an Incoming call with Caller ID is answered the number will be stored in **Answered**. (Max 50)

If an Incoming call with Caller ID is not answered the number will be stored in **Unanswered**. (Max 20)

## Viewing Last Dialed, Answered and Unanswered numbers .....

From **Records** menu

- 1 Choose one menu from **Last Dialed**, **Answered** or **Unanswered** (Select)
- OR
- In idle, to view the last dialed numbers list.
- 2 desired phone number (or name) you wish to redial .

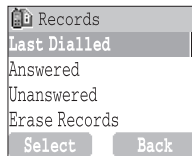

### To save a record in Phonebook:

After selecting desired number,

- (Menu) > **Save** (Select) > **SIM Phonebook** or **Mobile Phonebook** (Select)
- Enter Name and Phone number (Save).

**NOTE:** When the store is full the next phone number will overwrite the oldest.

## Erasing Records.....

From **Records** menu

- 1 **Erase Records** (Select)
- 2 Choose from **Erase Last Dialed**, **Erase Answered**, **Erase Unanswered** or **Erase All** (Select).
- 3 (Yes)

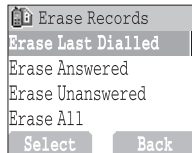

# Troubleshooting

Should any problem persist contact your dealer.

Problem	Cause	Remedy
Phone will not switch on.	_____	Check that the battery is fully charged and correctly connected to the phone.
Extremely short battery life for a new battery.	The network you are using and the condition of the battery can affect battery life.	_____
Short battery life for an old battery.	The battery has worn out.	Replace with a new fully charged battery.
The charging indicator does not light, the battery level indicator does not appear and the phone cannot be switched on when charging.	The battery is not attached to the phone or when the battery has been deeply discharged the phone will take a short time until the indicator lights.	Leave the phone charging the battery for a few minutes before the indicator is lit and attempting to switch it on.
Battery fails to charge.	The battery is not attached to the phone.	Ensure the battery is fitted to the phone prior to commencing charging.
	Battery has been connected to the phone after the Fast Travel Charger has been switched on.	
Calls cannot be made.	The phone is locked.	Unlock the phone.
	Outgoing calls are barred.	Disable the outgoing call barring or barred dial.
	The phone is not registered to a network.	Move to a coverage area and operate your phone after it has registered with a network.

Problem	Cause	Remedy
Calls cannot be made from Fixed Dial Store.		<p>Check whether your SIM supports Fixed Dial.</p> <p>Check if the Fixed Dial is switched on.</p> <p>Check whether the phone number is stored in the Fixed Dial.</p>
Calls cannot be received.	The phone is not switched on.	Switch the phone on.
	Incoming calls are barred.	Disable the incoming call barring.
	The phone is not registered to a network.	Move to a coverage area and operate your phone after it has registered with a network.
Emergency calls cannot be made.	You are not in a GSM coverage area.	Check that the antenna symbol (T) is displayed – move to a coverage area and operate your phone when the antenna symbol is displayed.
Phone numbers cannot be recalled from Phonebook.	The phone is locked.	Unlock the phone.
	Phone number has been restricted.	Switch off restriction.

# Important Error Messages

These are some of the most important error messages which may be displayed:

<b>Please Insert SIM Card</b>	<b>SIM card is not inserted, or is not inserted correctly. Please insert the SIM card correctly.</b>
<b>New Codes Not Same</b>	<b>When you change your password, you have to enter the new password twice to confirm. The codes you entered are different. Please enter same code twice.</b>
<b>Password Invalid!</b>	<b>When you change your password, you have to enter the new password twice to confirm. The codes you entered are different. Please enter same code twice.</b>
<b>Can't Access Network</b>	<b>The service network you selected manually is inaccessible. Please contact your service provider.</b>
<b>Unable to Select Network</b>	<b>The service network you selected manually is not available. Please contact your service provider.</b>
<b>No Service</b>	<b>There is no network within range or the received signal is weak. Move to an area which has stronger signal.</b>
<b>PIN Blocked! Please Enter PUK</b>	<b>You entered your PIN incorrectly three times in a row. To unblock the PIN, please enter PUK.</b>



<b>PIN2 Blocked! Please Enter PUK2</b>	You entered your PIN2 incorrectly three times in a row. To unblock the PIN, please enter PUK2.
<b>New PIN Not Accepted</b>	Your new PIN code is not accepted. Please try again.
<b>New PIN2 Not Accepted</b>	Your new PIN2 code is not accepted. Please try again.
<b>Incorrect Entry!</b>	You entered wrong PIN or PIN2. Please enter the correct one.
<b>Entries Do Not Match!</b>	When you change your password, you have to enter the new password twice to confirm. The codes you entered are different. Please enter same code twice.
<b>SIM Card Error</b>	Make sure the SIM card is inserted correctly. Clean the SIM card with a dry cloth or check if it is damaged. Contact your service provider.
<b>Function Unsupported</b>	The function you selected is not supported by your service provider. Please contact your service provider.
<b>Invalid Password</b>	The password that you entered is not valid. Please enter the correct password.
<b>Not Available</b>	The function you selected is not supported by your service provider. Please contact your service provider.
<b>Service Not Available</b>	The function you selected is not supported by your service provider. Please contact your service provider.

<b>Wrong PUK!</b>	You entered wrong PUK. Please enter the correct one.
<b>SIM Full! Please Delete Old Message!</b>	The SIM storage area for SMS is full. Please delete old messages.
<b>SIM Not Enough Space! Continue?</b>	The SIM storage area is FULL. If you continue data may be lost. Please delete old records.
<b>Not Enough Space! Continue?</b>	The message storage area is FULL. If you continue data may be lost. Please delete old records.
<b>SIM Service Not Support</b>	The SIM function you selected is not supported by your service provider. Please contact your service provider.
<b>Unregistered SIM Card</b>	Your SIM card is not registered to your service provider. Please contact your service provider.
<b>Authentication Failure</b>	Your SIM card is not registered to your service provider. Please contact your service provider.
<b>Blocked</b>	Your SIM card is blocked. Please contact your service provider.

## Glossary of Terms

<b>APN</b>	Access Point Name. Directs the user to the gateway or the required service.
<b>CHAP</b>	Challenge Handshake Authentication Protocol. A security feature for the GPRS network.
<b>CSD</b>	Circuit Switched Data. A communication method used to transmit data over telephone connections.
<b>DTMF Tones</b>	Dual Tone Multi-Frequency tones allow you to communicate with computerized phone systems, voice mailboxes, etc.
<b>GPRS</b>	General Packet Radio Service. A GSM transmission technique that transmits and receives data in packets rather than setting up a continuous channel. It makes very efficient use of available radio spectrum and users pay only for volume of data sent and received.
<b>GSM</b>	Global System for Mobile communications. The name given to the advanced digital technology that your phone uses.
<b>Network Operator</b>	The organization responsible for operating a GSM network.
<b>PAP</b>	Password Authentication Protocol. A security feature in the GPRS network.
<b>Password</b>	Used for the control of Call Bar. Supplied by your service provider.
<b>PIN</b>	Personal Identification Number used for SIM security. Supplied by your service provider. If the PIN is entered incorrectly 3 times, the PIN will be blocked.
<b>PIN2</b>	Personal Identification Number used for the control of Fixed Dial Store and Call Charge metering. If the PIN2 is entered incorrectly 3 times, the PIN2 will be blocked.
<b>PUK/PUK2</b>	PIN/PIN2 Unblocking Key. Used to unblock the PIN/PIN2. Supplied by your service provider. If the PUK/PUK2 is entered incorrectly 10 times, the PUK/PUK2 will be blocked.

<b>Registration</b>	The act of locking on to a GSM/GPRS network. This is usually performed automatically by your phone.
<b>Roaming</b>	The ability to use your phone on networks other than your Home network.
<b>Service Provider</b>	The organization responsible for providing access to the GSM/GPRS network.
<b>SIM</b>	Subscriber Identity Module. A small smart-card which stores unique subscriber and user-entered information such as Phonebook and Short Messages. Supplied by your service provider.
<b>SMS</b>	Short Message Service. A basic mail system used for cellular phones. This service allows sending/receiving short text messages.
<b>WAP</b>	Wireless Application Protocol. The communication standard which enables you to download resources from the Internet to your phone.

# Consumer Update

## Consumer Update on Mobile Phones

(Published by U.S. Food and Drug Administration, Center for Devices and Radiological Health, October 20, 1999.)

FDA has been receiving inquiries about the safety of mobile phones, including cellular phones and PCS phones. The following summarizes what is known—and what remains unknown—about whether these products can pose a hazard to health, and what can be done to minimize any potential risk. This information may be used to respond to questions.

### Why the concern?

Mobile phones emit low levels of radiofrequency energy (i.e., radiofrequency radiation) in the microwave range while being used. They also emit very low levels of radiofrequency energy (RF), considered non-significant, when in the stand-by mode. It is well known that high levels of RF can produce biological damage through heating effects (this is how your microwave oven is able to cook food). However, it is not known whether, to what extent, or through what mechanism, lower levels of RF might cause adverse health effects as well. Although some research has been done to address these questions, no clear picture of the biological effects of this type of radiation has emerged to date. Thus, the available science does not allow us to conclude that mobile phones are absolutely safe, or that they are unsafe. However, the available scientific evidence does not demonstrate any adverse health effects associated with the use of mobile phones.

### What kind of phones are in question?

Questions have been raised about hand-held mobile phones, the kind that have a built-in antenna that is positioned close to the user's head during normal telephone conversation.

These types of mobile phones are of concern because of the short distance between the phone's antenna – the primary source of the RF – and the person's head. The exposure to RF from mobile phones in which the antenna is located at greater distances from the user (on the outside of a car, for example) is drastically lower than that from hand-held phones, because a person's RF exposure decreases rapidly with distance from the source. The safety of so-called "cordless phones",

which have a base unit connected to the telephone wiring in a house and which operate at far lower power levels and frequencies, has not been questioned.

### How much evidence is there that handheld mobile phones might be harmful?

Briefly, there is not enough evidence to know for sure, either way; however, research efforts are on-going. The existing scientific evidence is conflicting and many of the studies that have been done to date have suffered from flaws in their research methods. Animal experiments investigating the effects of RF exposures characteristic of mobile phones have yielded conflicting results. A few animal studies, however, have suggested that low levels of RF could accelerate the development of cancer in laboratory animals. In one study, mice genetically altered to be predisposed to developing one type of cancer developed more than twice as many such cancers when they were exposed to RF energy compared to controls. There is much uncertainty among scientists about whether results obtained from animal studies apply to the use of mobile phones. First, it is uncertain how to apply the results obtained in rats and mice to humans. Second, many of the studies that showed increased tumor development used animals that had already been treated with cancer-causing chemicals, and other studies exposed the animals to the RF virtually continuously – up to 22 hours per day.

For the past five years in the United States, the mobile phone industry has supported research into the safety of mobile phones. This research has resulted in two findings in particular that merit additional study:

1. In a hospital-based, case-control study, researchers looked for an association between mobile phone use and either glioma (a type of brain cancer) or acoustic neuroma (a benign tumor of the nerve sheath). No statistically significant association was found between mobile phone use and acoustic neuroma. There was also no association between mobile phone use and gliomas when all types of gliomas were considered together. It should be noted that the average length of mobile phone exposure in this study was less than three years. When 20 types of glioma were considered separately, however, an

association was found between mobile phone use and one rare type of glioma, neuroepitheliomatous tumors. It is possible with multiple comparisons of the same sample that this association occurred by chance.

Moreover, the risk did not increase with how often the mobile phone was used, or the length of the calls. In fact, the risk actually decreased with cumulative hours of mobile phone use. Most cancer causing agents increase risk with increased exposure. An ongoing study of brain cancers by the National Cancer Institute is expected to bear on the accuracy and repeatability of these results.<sup>1</sup>

2. Researchers conducted a large battery of laboratory tests to assess the effect of exposure to mobile phone RF on genetic material. These included tests for several kinds of abnormalities, including mutations, chromosomal aberrations, DNA strand breaks, and structural changes in the genetic material of blood cells called lymphocytes. None of the tests showed any effect from the RF except for the micronucleus assay, which detects structural effects on the genetic material. The cells in this assay showed changes after exposure to simulated cell phone radiation, but only after 24 hours of exposure. It is possible that exposing the test cells to radiation for this long resulted in heating. Since this assay is known to be sensitive to heating, heat alone could have caused the abnormalities to occur. The data already in the literature on the response of the micronucleus assay to RF are conflicting. Thus, followup research is necessary.<sup>2</sup>

FDA is currently working with government, industry, and academic groups to ensure the proper follow-up to these industry-funded research findings. Collaboration with the Cellular Telecommunications Industry Association (CTIA) in particular is expected to lead to FDA providing research recommendations and scientific oversight of new CTIA-funded research based on such recommendations. Two other studies of interest have been reported recently in the literature:

1. Two groups of 18 people were exposed to simulated mobile phone signals under laboratory conditions while they performed cognitive function test. There were no changes in the subjects' ability to recall words, numbers, or pictures, or in their spatial memory, but they were able to make choices more quickly in one visual test when they were exposed to simulated mobile phone signals. This was the only change noted among more than 20 variables compared.<sup>3</sup>
2. In study of 209 brain tumor cases and 425 matched controls, there was no increased risk of brain tumors associated with mobile phone use. When tumors did exist in certain locations, however, they were more likely to be

on the side of the head where the mobile phone was used. Because this occurred in only a small number of cases, the increased likelihood was too small to be statistically significant.<sup>4</sup>

In summary, we do not have enough information at this point to assure the public that there are, or are not, any low incident health problems associated with use of mobile phones. FDA continues to work with all parties, including other federal agencies and industry, to assure that research is undertaken to provide the necessary answers to the outstanding questions about the safety of mobile phones.

### **What is known about cases of human cancer that have been reported in users of handheld mobile phones?**

Some people who have used mobile phones have been diagnosed with brain cancer. But it is important to understand that this type of cancer also occurs among people who have not used mobile phones. In fact, brain cancer occurs in the U.S. population at a rate of about 6 new cases per 100,000 people each year. At that rate, assuming 80 million users of mobile phones (a number increasing at a rate of about 1 million per month), about 4800 cases of brain cancer would be expected each year among those 80 million people, whether or not they used their phones. Thus it is not possible to tell whether any individual's cancer arose because of the phone, or whether it would have happened anyway. A key question is whether the risk of getting a particular form of cancer is greater among people who use mobile phones than among the rest of the population. One way to answer that question is to compare the usage of mobile phones among people with brain cancer with the use of mobile phones among appropriately matched people without brain cancer. This is called a case-control study. The current case-control study of brain cancers by the National Cancer Institute, as well as the follow-up research to be sponsored by industry, will begin to generate this type of information.

### **What is FDA's role concerning the safety of mobile phones?**

Under the law, FDA does not review the safety of radiation-emitting consumer products such as mobile phones before marketing, as it does with new drugs or medical devices. However, the agency has authority to take action if mobile phones are shown to emit radiation at a level that is hazardous to the user. In such a case, FDA could require the manufacturers of mobile phones to notify users of the health hazard and to repair, replace

or recall the phones so that the hazard no longer exists. Although the existing scientific data do not justify FDA regulatory actions at this time, FDA has urged the mobile phone industry to take a number of steps to assure public safety. The agency has recommended that the industry:

- support needed research into possible biological effects of RF of the type emitted by mobile phones;
- design mobile phones in a way that minimizes any RF exposure to the user that is not necessary for device function; and Personal Settings
- cooperate in providing mobile phone users with the best possible information on what is known about possible effects of mobile phone use on human health.

At the same time, FDA belongs to an interagency working group of the federal agencies that have responsibility for different aspects of mobile phone safety to ensure a coordinated effort at the federal level. These agencies are:

- National Institute for Occupational Safety and Health
- Environmental Protection Agency
- Federal Communications Commission
- Occupational Health and Safety Administration
- National Telecommunications and Information Administration

The National Institutes of Health also participates in this group.

### **In the absence of conclusive information about any possible risk, what can concerned individuals do?**

If there is a risk from these products and at this point we do not know that there is – it is probably very small. But if people are concerned about avoiding even potential risks, there are simple steps they can take to do so. For example, time is a key factor in how much exposure a person receives. Those persons who spend long periods of time on their hand-held mobile phones could consider holding lengthy conversations on conventional phones and reserving the hand-held models for shorter conversations or for situations when other types of phones are not available. People who must conduct extended conversations in their cars every day could switch to a type of mobile phone that places more distance between their bodies and the source of the RF, since the exposure level drops off dramatically with distance. For example, they could switch to

- a mobile phone in which the antenna is located outside the vehicle,

- a hand-held phone with a built-in antenna connected to a different antenna mounted on the outside of the car or built into a separate package, or
- a headset with a remote antenna to a mobile phone carried at the waist.

Again, the scientific data do not demonstrate that mobile phones are harmful. But if people are concerned about the radiofrequency energy from these products, taking the simple precautions outlined above can reduce any possible risk.

### **Where can I find additional information?**

For additional information, see the following websites:

- Federal Communications Commission (FCC) RF Safety Program (select "Information on Human Exposure to RF Fields from Cellular and PCD Radio Transmitters"): <http://www.fcc.gov/oet/rfsafety>
- World Health Organization (WHO) International Commission on Non-Ionizing Radiation Protection (select Qs & As): <http://www.who.int/peh-emf>
- United Kingdom, National Radiological Protection Board: <http://www.nrpb.org.uk>
- Cellular Telecommunications Industry Association (CTIA): <http://www.wowcom.com>
- U.S. Food and Drug Administration (FDA) Center for Devices and Radiological Health: <http://www.fda.gov/cdrh/consumer/>

1. Muscat et al. "Epidemiological Study of Cellular Telephone Use and Malignant Brain Tumors". In: State of the Science Symposium; 1999 June 20; Long Beach, California.
2. Tice et al. "Tests of mobile phone signals for activity in genotoxicity and other laboratory assays". In: Annual Meeting of the Environmental Mutagen Society. March 29, 1999, Washington, D.C. and personal communication, unpublished results.
3. Preece, AW, Iwi, G, Davies-Smith, A, Wesnes, K, Butler, S, Lim, E, and Varey, A. "Effect of a 915-MHz simulated mobile phone signal on cognitive function in man". Int. J. Radiat. Biol., April 8, 1999. Hardell, L, Nasman, A, Pahlson, A, Hallquist, A and Mild, KH. "Use of cellular telephones and the risk for brain tumors: a case-control study". Int. J. Oncol., 15: 113-116, 1999.

# Specifications

Bands Supported	GSM 850 Class 4 GSM1800 Class 1 GSM1900 Class 1
Standby Time (hrs)*	80 – 200
Talk Time (hrs)*	2.5 – 6
Temperature Range	
Charging	+5°C – +35°C
Storage	-20°C – +60°C
Weight	74 g (including battery)
Dimensions	
Height	80 mm
Width	43 mm
Depth	19 mm
Supply Voltage	3.7 V (780 mAh Li-ion)
Antenna	Fixed
Charge Time**	Up to 165 Min
SIM Type	3 V only
Phonebook Memory	250 entries + SIM
Animation Themes	2
User Composed Melody	5
Games	2

Backlight Colours	1 (White)
Ring Tones	Preset: 20 (Varies depending on Data Folder)
Scheduler	Up to 50 entries
Alarms	1
Graphics Formats Supported	GIF89a, BMP, WBMP, PNG, WPNG, JPEG
Maximum Graphics Size	W128 x H80 pixels (4096 CSTN colours)

**NOTE:** Specifications are subject to change without notice.

**\*NOTE:** Talk and Standby time depend on network conditions, SIM usage and battery condition.

**\*\*NOTE:** Charging time depends on usage and battery condition.

**NOTE:** PIN2 code and PUK2 code are supplied by your service provider.



## Accessories

### Li-Ion Battery (EB-BSG50USD)



Double your talk time by having a spare battery.

### Rapid Charger (EB-CAD55US)

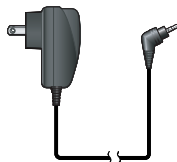

Carry a lightweight portable charger wherever you go to ensure you always have power to talk.

### How to Identify a Genuine Panasonic Accessory

Panasonic produces some of the most advanced mobile phones available. So, as you'd expect from this class leader, the range of accessories are second to none.

Most genuine Panasonic accessories will have a label showing an "EB-XXX00" model number.

**NOTE:** Accessories are subject to change without notice.

# Warranty

PANASONIC DIGITAL COMMUNICATIONS AND SECURITY  
COMPANY  
DIVISION OF MATSUSHITA ELECTRIC CORPORATION OF  
AMERICA  
2 Panasonic Way, 2H-2, Secaucus, New Jersey 07094

## CELLULAR TELEPHONE PRODUCTS Limited Warranty

Panasonic Digital Communications and Security Company (referred to as the "Warrantor") will repair or replace this product with new or refurbished parts or product, at Panasonic's sole option, free of charge, in the U.S.A. in the event of a defect in materials or workmanship from the date of original purchase as follows:

HANDHELD CELLULAR TELEPHONE (except description as follows)

- For one (1) year.

ACCESSORIES (packaged with the Handheld Kit)

- For one (1) year.

ACCESSORIES (packaged separately)

- Refer to the warranty statement printed on or included in the accessory package.

To exercise your warranty return the product and a copy of the original dated purchase receipt, pre-paid, to Panasonic at the address as follows. Please be sure to include your return address and a description of the alleged defect.

Panasonic Cellular Service Repair  
14800 FAA Blvd., Suite 100  
Fort Worth, TX 76155

Panasonic strongly recommends that the product be adequately packaged to avoid shipping damage. You may also want to insure the product. Panasonic will return the repaired product pre-paid to you at your U.S.A. address.

This warranty is extended only to the original purchaser. A valid purchase receipt or other proof of date of original purchase will be required before warranty service is rendered.

This warranty covers only failures due to defects in materials or workmanship that occur during normal use. It does not cover damage that occurs in shipment, failures that are caused by products not supplied by Panasonic, failures that result from accident, misuse, abuse, neglect, water damage, mishandling, misapplication, faulty installation, setup adjustments, improper maintenance, alteration, improper antenna, inadequate signal pickup, maladjustment of consumer controls, line power surge, lightning damage, modification or service by anyone other than a Panasonic Authorized Servicenter or damage that is attributable to acts of God. Removal and re-installation costs are not covered by this warranty nor are products on which the serial number is missing, altered or made illegible.

#### LIMITS AND EXCLUSIONS

There are no express warranties except as set forth hereinbefore. WARRANTOR SHALL NOT BE LIABLE FOR INCIDENTAL OR CONSEQUENTIAL DAMAGES RESULTING FROM THE USE OF THIS PRODUCT, OR ARISING OUT OF ANY BREACH OF THIS WARRANTY. ALL EXPRESS AND IMPLIED WARRANTIES, INCLUDING THE IMPLIED WARRANTIES OF MERCHANTABILITY AND FITNESS FOR A PARTICULAR PURPOSE, ARE LIMITED TO THE APPLICABLE WARRANTY PERIODS SET FORTH HEREINBEFORE. Some states do not allow the exclusion or limitation of incidental or consequential damages, or limitations on how long an implied warranty lasts, so the above exclusions or limitations may not apply to you.

This warranty gives you specific legal rights and you may also have other rights which vary from state to state.

If a problem is not handled to your satisfaction, then write the Consumer Affairs Division at the company address indicated hereinbefore or contact Panasonic at 1-800-414-4408 or TTY: 1-770-338-6204.

# Personal Settings

Item	Provisioning Information Setting No. 1	Provisioning Information Setting No. 2	Provisioning Information Setting No. 3	Provisioning Information Setting No. 4	Provisioning Information Setting No. 5
Profile Name					
Server Name					
IP Address					
IP Port					
Homepage					
Linger Time					
<b>Circuit Switched (CSD)</b>					
Server Name					
Call Type					
Dial Number					
Login Name					
Password					
<b>Packet Switched (GPRS)</b>					
Server Name					
GPRS APN					
Login Name					
Password					
Authentication					

# Licensing

## CP8 Patent

© Panasonic Mobile Communications Co., Ltd. 2004

Information in this document is subject to change without notice. No part of these instructions may be reproduced or transmitted in any form or by any means without obtaining express permission from Panasonic Mobile Communications Co., Ltd.



This product is licensed under one or more of the following U.S. Patents: 4,675,863, 4,777,633, 4,779,262, 4,785,450, 4,811,420, 4,817,089, 4,912,705, 5,022,024, 5,119,375, 5,121,391, 5,159,705, 5,657,358, 5,687,194, 5,734,678

This product may be protected under one or more of the following U.S. Patents: 5,842,129, 5,504,803, and 5,483,666 and other patents that are pending.

## Tegic

T9® Text Input is a registered trademark of Tegic Communications, Inc. T9® is covered by U.S. Pat. 5,818,437, U.S. Pat. 5,953,541, 5, U.S. Pat. 5,953,541, U.S. Pat. 6,011,554 and other patents pending.

## OpenWave

OpenWave is a pioneer in the mobile data transfer industry, supplying voice and data revenue to the mobile communications sector.



# Index

## A

Access to Shortcuts .....	33
Accessories .....	94
Activating a profile .....	29
Alarm Setting .....	76
Alert Type .....	29
Answering Calls .....	18
Any Key Answer .....	32
APN .....	88
Applications .....	73
Attaching and Removing the Battery .....	8
Auto Answer .....	32
Auto capital change .....	59
Auto Display .....	57

## B

Back to the Menu Display .....	12
Bookmarks .....	46
Brightness .....	31
Broadcast .....	55
Browser .....	44
Browsing Bookmark .....	46
Browsing the Phone Book .....	39

## C

Calculator .....	77
Call Divert .....	65
Call Service .....	62
Care and Maintenance .....	7

Change Phonecode .....	67
Changing Alert Type .....	29
Changing the Language .....	28
Changing the Ring Tone .....	23
Changing the Security Code .....	67
Changing the Volume .....	23
CHAP .....	88
Charge Settings .....	63
Charging the Battery .....	9
Classic rally .....	35
Clock .....	75
Codes .....	67
Composing a Melody .....	24
Connection Setting .....	70
Consumer Update .....	90
Contents .....	i
Creating a New Short Text Message .....	49
CSD Setting .....	69
CSD .....	88
Currency .....	78

## D

Date Format/Time Format .....	76
Desktop Handsfree .....	19
Disabling Key Guard .....	47
Display .....	11,26
Displaying Main Menu .....	15
DTMF Tones .....	20,88

**E**

Earpiece Volume .....	16
Editing profiles .....	29
Editing User Messages .....	31,50
Emergency Call .....	17
Enabling/Disabling the PIN .....	67
Entering a Schedule .....	74
Entering to the Menu Display .....	12
Entering URL from Browser menu .....	46
Erasing Records .....	82

**F**

Fillip .....	35
--------------	----

**G**

Games .....	35,73
Getting Started .....	8
Glossary of Terms .....	88
GPRS .....	88
GPRS Info.....	70
GPRS Setting.....	70
Group Settings .....	40
GSM .....	88

**H**

Hot Key Dial.....	42
-------------------	----

**I**

Important Error Messages .....	85
In-Call Options .....	19
Incoming Call While on a Call .....	21

Inserting and Removing the SIM .....	8
International Dialing .....	17

**K**

Key Guard.....	47
Key Operation.....	35
Key Tone .....	30
Keys .....	10
Keys & Displays .....	10

**L**

Language.....	28
Last Number Dialing .....	17
Licensing.....	98
Long Press.....	14
Low Battery Power Warning .....	9

**M**

Making a Call by Using Hot Key Dial .....	42
Making a Second Call .....	21
Making Calls .....	16
Melody Composer .....	78
Memory Status .....	41
Menu Structure .....	13
Menu Display .....	12
Messages .....	49
My Numbers .....	41
My Phone .....	23
My Phonebook .....	33,42

**N**

Network .....	69
---------------	----

Network Operator .....	88
Network setting .....	69

## O

One Click Mute on Incoming Call .....	18
Operation of Battery Level Indicator .....	9
Options .....	54
Options in Phone Book .....	39
Other Text Modes.....	60

## P

PAP .....	88
Password .....	88
Pause Dial .....	20
Personal Settings .....	97
Phone Basics .....	15
Phone Book .....	37
Phone ON/OFF .....	15
Phone Option .....	62
Phonebook Dialing .....	16
Picture Folder .....	80
PIN .....	88
PIN2 .....	88
Power Off Time .....	77
Profiles .....	29
PUK/PUK2 .....	88

## Q

Quick Touch Silent Mode .....	18
-------------------------------	----

## R

Rate Computing .....	78
----------------------	----

Reading a Received Message .....	51
Records .....	82
Registration .....	89
Rename a melody .....	25
Reset Defaults .....	32
Ring Volume.....	18,29
Roaming .....	89

## S

Safety First .....	1
Scheduler .....	74
Security .....	66
Selecting Games .....	35
Server Setting .....	44
Service Provider .....	89
Set to Ringtone.....	25
Setting Any Key Answer .....	32
Setting Auto Answer .....	32
Setting Auto Display .....	57,64
Setting Bookmarks .....	46
Setting Bookmark from Homepage .....	46
Setting Brightness .....	28
Setting Broadcast .....	55
Setting Call Bar .....	66
Setting Call Divert .....	65
Setting Call Waiting .....	62
Setting Caller's ID.....	63
Setting Colour Themes .....	28
Setting Currency.....	63
Setting Display Animation .....	27
Setting Display Contrast .....	27
Setting Fixed Dial .....	68



Setting Greeting .....	27
Setting Hot Key Dial .....	42
Setting Key Guard .....	47
Setting Key Tone .....	26
Setting Language .....	56
Setting My Numbers .....	41
Setting Options .....	54
Setting Personal Rate .....	64
Setting Phone Line .....	65
Setting Ringtone .....	79
Setting Shortcuts .....	33
Setting SIM Lock .....	68
Setting SIM or Mobile Phonebook .....	33
Setting T9 Input .....	33
Setting the currency value .....	78
Setting the Maximum Cost .....	64
Setting the Message Centre Number .....	49
Setting Topic .....	55
Setting User defined Topic.....	55
Setting Wallpaper .....	26,80
Setting Warning Tone .....	26
Setting Withhold ID .....	63
Shift mode.....	59
Shift mode change.....	59
Shortcuts .....	33
Shortcut from Idle Screen .....	14
Short press .....	14
SIM .....	89
SMS .....	49,89
Sound Folder .....	79
Sounds .....	23
Specifications .....	93
Standard Dialing .....	16
Starting Games .....	35
Status Icons .....	11
STK (SIM Tool Kit).....	73
Storing .....	37
Storing a Fixed Dial Number.....	38
Storing a Number in Mobile Phonebook .....	37
Storing a Number in SIM .....	37
Symbols Used in the Manual.....	12
<b>T</b>	
T9® Dictionary.....	59
T9 Input.....	33
T9® Text Input .....	60
Text Entry .....	58
Text Input .....	59
Time & Date Setting .....	75
Time Display Setting .....	75
Time Zone Setting .....	75
To end alarm.....	76
Troubleshooting .....	83
<b>U</b>	
User Messages .....	31
<b>V</b>	
Vibrator .....	30
Viewing .....	39
Viewing Broadcast.....	56
Viewing / Editing Scheduler .....	74
Viewing GPRS Information.....	70
Viewing melody information.....	25

Viewing Last Dialed, Answered and Unanswered numbers .....	82
Viewing Memory Status .....	41,54,79,80
Viewing Message Lists in Archive .....	53
Viewing Message Lists in Outbox .....	52
Viewing My Numbers .....	41
Viewing Picture of Caller's ID .....	80
Viewing Time/Charges .....	62

## **W**

WAP .....	89
WAP Activating .....	45
Warranty .....	95
Warning Tone .....	30

### Reference Information

For future reference, please complete the information on this page. Also, you may want to tape or staple your purchase receipt here.

Model Number: \_\_\_\_\_

IMEI Number (under battery on back of phone): \_\_\_\_\_

\_\_\_\_\_

Purchase Date: \_\_\_\_\_

Dealer's Name: \_\_\_\_\_

Dealer's Address: \_\_\_\_\_

Dealer's Phone Number: \_\_\_\_\_

Emergency Number: \_\_\_\_\_

Lock Code: \_\_\_\_\_

To order this manual in Spanish  
(part number 3TR001403AAA),  
call our toll free number **1 (800) 833-9626**.  
Si desea hacer su pedido de la versión en español  
(No. catálogo 3TR001403AAA) de este manual,  
llame sin costo al **1(800) 833-9626**.

Panasonic Mobile Communications Corporation of the Philippines  
Laguna Technopark Sta. Rosa, Laguna, Philippines.



3TR002433AAA

## Free Manuals Download Website

<http://myh66.com>

<http://usermanuals.us>

<http://www.somanuals.com>

<http://www.4manuals.cc>

<http://www.manual-lib.com>

<http://www.404manual.com>

<http://www.luxmanual.com>

<http://aubethermostatmanual.com>

Golf course search by state

<http://golfingnear.com>

Email search by domain

<http://emailbydomain.com>

Auto manuals search

<http://auto.somanuals.com>

TV manuals search

<http://tv.somanuals.com>