

Panasonic

Proprietary Telephone for
Electronic Modular Switching System

MODEL NO. **KX-T7030**

Reference Manual



Illustrated Model: White

KX-T7030 is compatible with all of the Panasonic Electronic Modular Switching Systems and can perform most functions within each system.

Please read before use.

Important Safety Instructions

When using your telephone equipment, basic safety precautions should always be followed to reduce the risk of fire, electric shock and injury to persons, including the following:

1. Read and understand all instructions.
2. Follow all warnings and instructions marked on the product.
3. Unplug this product from the wall outlet before cleaning. Do not use liquid cleaners or aerosol cleaners. Use a damp cloth for cleaning.
4. Do not use this product near water, for example, near a bath tub, wash bowl, kitchen sink, or laundry tub, in a wet basement, or near a swimming pool.
5. Do not place this product on an unstable cart, stand, or table. The product may fall, causing serious damage to the product.
6. Slots and openings in the cabinet and the back or bottom are provided for ventilation, to protect it from overheating, these openings must not be blocked or covered. The openings should never be blocked by placing the product on the bed, sofa, rug, or other similar surface. This product should never be placed near or over a radiator or heat register. This product should not be placed in a built-in installation unless proper ventilation is provided.
7. Do not allow anything to rest on the telephone cord. Do not locate this product where the cord will be abused by persons walking on it.
8. Do not overload wall outlets and extension cords as this can result in the risk of fire or electric shock.
9. Never push objects of any kind into this product through cabinet slots as they may touch dangerous voltage points or short out parts that could result in a risk of fire or electric shock. Never spill liquid of any kind on the product.
10. To reduce the risk of electric shock, do not disassemble this product, but take it to a qualified serviceman when some service or repair work is required. Opening or removing covers may expose you to dangerous voltages or other risks. Incorrect reassembly can cause electric shock when the appliance is subsequently used.

11. Unplug this product from the wall outlet and refer servicing to qualified service personnel under the following conditions:

- A. When the power supply cord or plug is damaged or frayed.
- B. If liquid has been spilled into the product.
- C. If the product has been exposed to rain or water.
- D. If the product does not operate normally by following the operating instructions. Adjust only those controls, that are covered by the operating instructions because improper adjustment of other controls may result in damage and will often require extensive work by a qualified technician to

restore the product to normal operation.

- E. If the product has been dropped or the cabinet has been damaged.
 - F. If the product exhibits a distinct change in performance.
12. Avoid using a telephone (other than a cordless type) during an electrical storm. There may be a remote risk of electric shock from lightning.
13. Do not use the telephone to report a gas leak in the vicinity of the leak.

SAVE THESE INSTRUCTIONS

Included accessories

Handset one

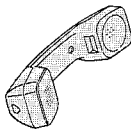

Telephone line cord one

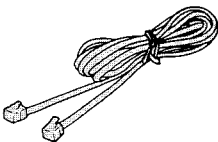

Handset cord one

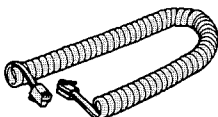

Card holder with memory station card one

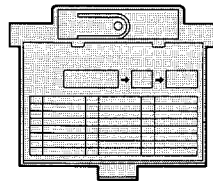

Overlay one

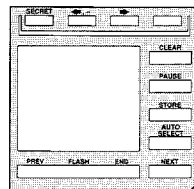

Thank you for purchasing the Panasonic Telephone.

Table of Contents

Important safety instructions	1
Connection	3
Initial setting	4
Location of controls	5
Using overlay	7
Installing the card holder	8
Wall mounting	9
Important information	10
Accessory order information	Back cover

Connection

Connect as shown.

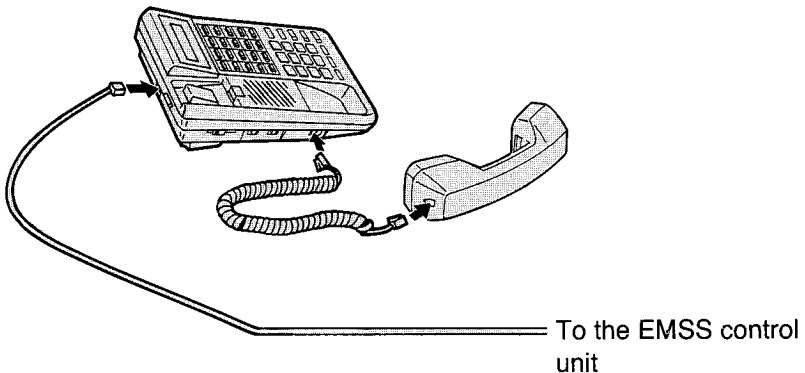

Initial setting

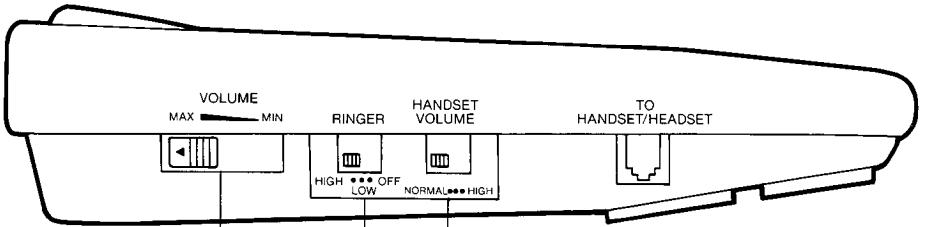

HANDSET VOLUME Selector:

To adjust the volume level of the handset.

NORMAL: Normal voice

HIGH: Loud voice

RINGER VOLUME Selector:

To adjust the volume level of the ringer.

HIGH: Loud ringer

LOW: Low ringer

OFF: No ringer

VOLUME Control:

To adjust the volume level of the speaker volume.

MAX: Loud voice

MIN: Low voice

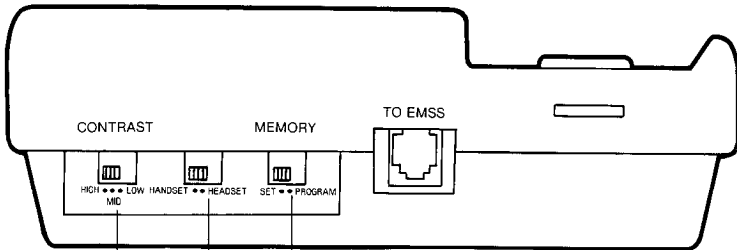

MEMORY Switch:

Set to "SET".

For station programming, set to "PROGRAM".

HANDSET/HEADSET Selector:

Set to "HANDSET".

For connecting the headset, set to "HEADSET".

CONTRAST Selector:

To adjust the contrast of the Liquid Crystal Display.

Location of controls

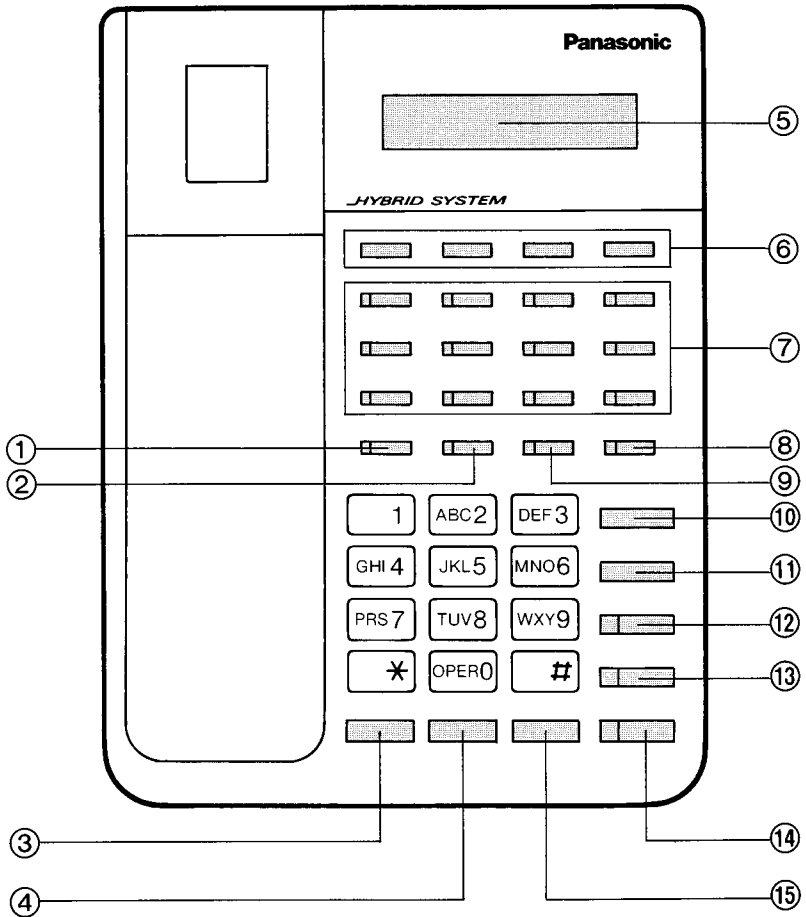

KX-T7030 is compatible with the Panasonic Electronic Modular Switching Systems and can perform most functions within each system.

- ① INTERCOM Button and Indicator:
Used for making or receiving an intercom call.
- ② CONFERENCE Button and Indicator:
Used for speaking with three parties at the same time.
- ③ REDIAL Button:
Redials the last number dialed.
- ④ FLASH Button:
Used for sending the hook flash signal to the CO line.
- ⑤ LCD (Liquid Crystal Display)
- ⑥ Programmable Feature Buttons:
Dials or accesses the system feature with one touch.
- ⑦ Flexible CO Line Buttons and Indicators*:
Used for dialing via CO line, Direct Station Selection, or Programmable Feature buttons.
- ⑧ Flexible Message Waiting Button and Indicator*:
Used for Message Waiting, Direct Station Selection, or Programmable Feature button.
- ⑨ FWD/DND Button and Indicator:
Sets or cancels the Call Forwarding/Do Not Disturb feature.
- ⑩ TRANSFER Button:
Transfers a call to any extension.
- ⑪ PAUSE Button:
Inserts a pause between the access number and the phone number.
- ⑫ AUTO DIAL/STORE Button and Indicator:
Used for dialing the system speed dialing/For storing functions into memory.
- ⑬ AUTO ANSWER/MUTE Button and Indicator:
Used for answering an intercom call automatically/ For muting your voice in hands-free mode.
- ⑭ SP-PHONE Button and Indicator:
Used for making or receiving a call without using the handset.
- ⑮ HOLD Button:
Places a call on hold.

*These functions are limited to the specified EMSS Control Units. Refer to the manual.

Using overlay

When you set the system programming data, the function of the KX-T7030 connected to your EMSS unit will change as follows.

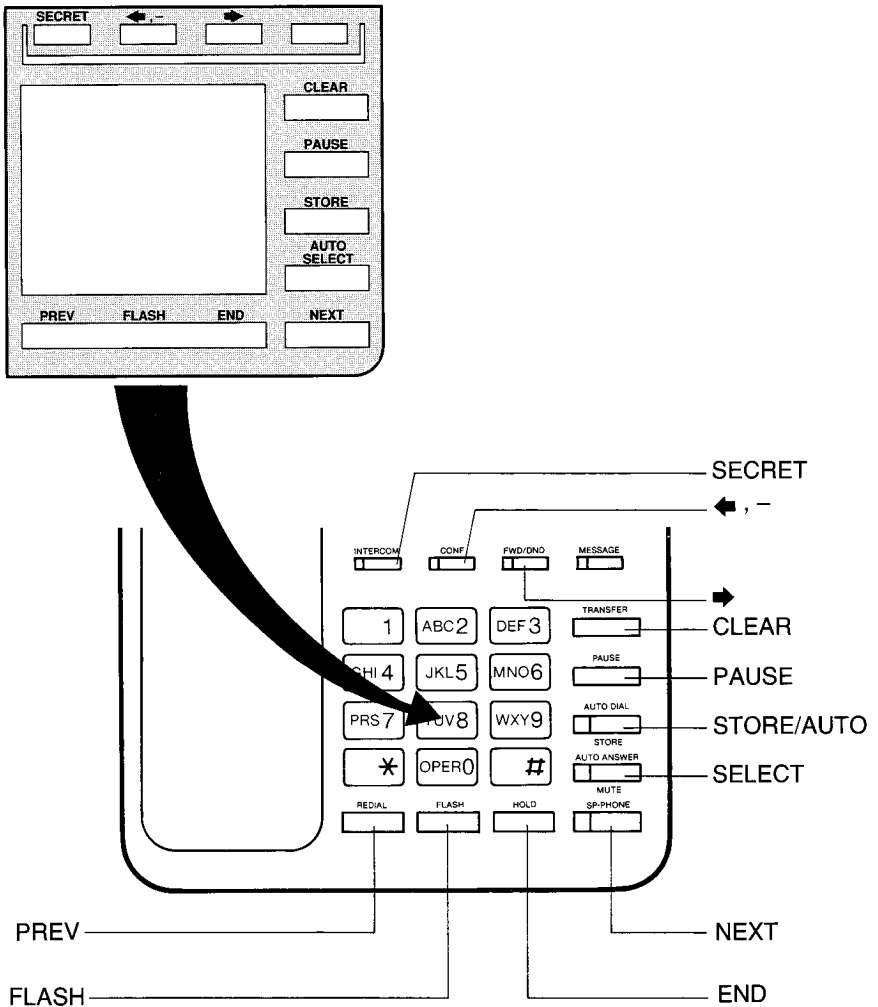

Installing the card holder

- 1 Line up the marks (▶) on the card holder and ones on the slide rails of the unit.

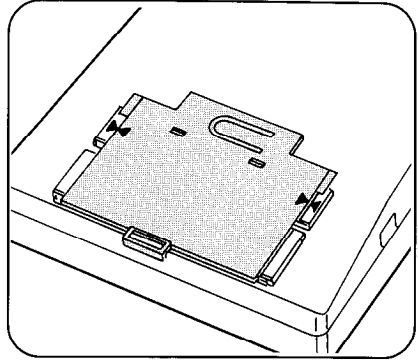

- 2 Push the two shaded portions slightly and insert the edges of the holder under the slide rails and then slide down toward arrow "A".

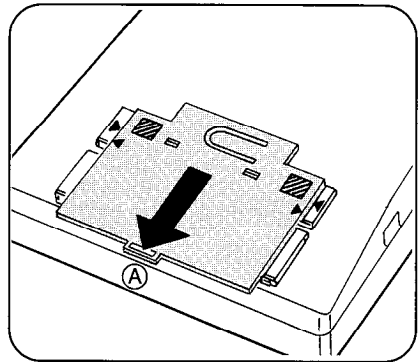

Removing the card holder:

Push the card holder toward arrow "B" while keeping the tip of the holder pulled toward arrow "C".

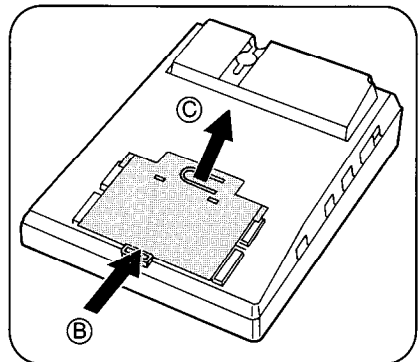

Wall mounting

This unit can be mounted on the wall phone plate.

- 1** Turn the handset hook upside down.

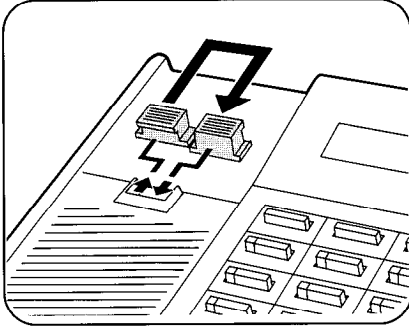

- 4** Place the stand on the center of the unit.

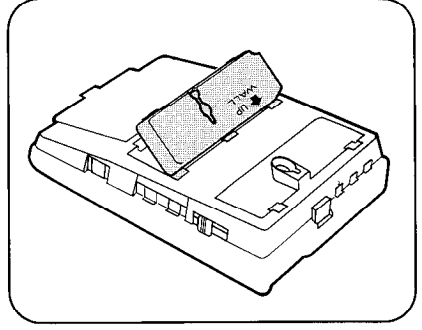

- 2** Remove the attached stand.

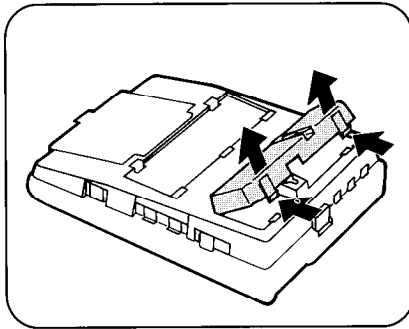

- 5** Mount the unit on the wall phone plate.

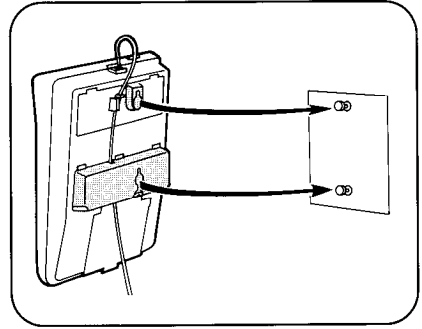

- 3** Rotate the stand 1/2 turn so that the arrow on the stand shows UP for WALL.

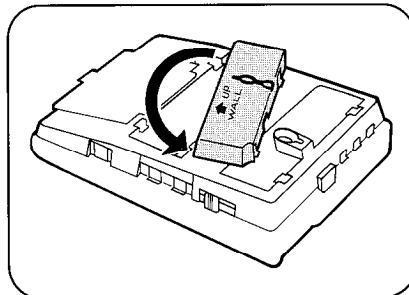

To temporarily place the handset down during a conversation, hook as shown.

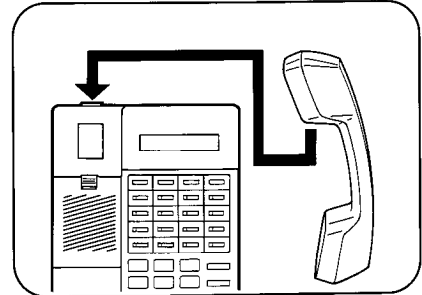

Important information

If there is any trouble, disconnect the unit from the extension line and connect a known working phone. If the known working phone operates properly, have the defective phone repaired by one of the specified Panasonic Factory Service Centers. If the known working phone does not operate properly, check the Electronic Modular Switching System and the Internal extension wiring.

WARNING:

TO PREVENT FIRE OR SHOCK HAZARD, DO NOT EXPOSE THIS PRODUCT TO RAIN OR ANY TYPE OF MOISTURE.

CAUTION:

To assure continued compliance with FCC rules, do not make any unauthorized modifications. When programming emergency numbers and/or making test calls to emergency numbers:

- 1) Remain on the line and briefly explain to the dispatcher the reason for the call before hanging up.
- 2) Perform such activities in the off-peak hours, such as early morning hours or late evenings.

INSTALLATION:

- 1) Never install telephone wiring during a lightning storm.
- 2) Never install telephone jacks in wet locations unless the jack is specifically designed for wet locations.
- 3) Never touch uninsulated telephone wires or terminals unless the telephone line has been disconnected at the network Interface.
- 4) Use caution when installing or modifying telephone lines.

NOTE:

This equipment has been tested and found to comply with the limits for a Class B digital device, pursuant to Part 15 of the FCC Rules. These limits are designed to provide reasonable protection against harmful interference in a residential installation. This equipment generates, uses, and can radiate radio frequency energy and, if not installed and used in accordance with the instructions, may cause harmful interference to radio communications. However, there is no guarantee that interference will not occur in a particular installation. If this equipment does cause harmful interference to radio or television reception, which can be determined by turning the equipment off and on, the user is encouraged to try to correct the interference by one or more of the following measures:

- Reorient or relocate the receiving antenna.
- Increase the separation between equipment and receiver.
- Connect the equipment into an outlet on a circuit different from that to which the receiver is connected.
- Consult the dealer or an experienced radio/TV technician for help.

This telephone provides magnetic coupling to hearing aids.

Important information (cont.)

- Keep the unit away from heating appliances and electrical noise generating devices such as fluorescent lamps and motors.
- The unit should be kept free of dust, moisture and vibration, and should not be exposed to direct sunlight.
- Do not use benzine, thinner, or the like, or any abrasive powder to clean the cabinet. Wipe it with a soft cloth.
- Do not use any handset other than Panasonic handset.

Accessory order information

- Replacement parts and accessories are available through your local authorized parts distributor.
- For ordering the accessory, call toll free: 1-800-332-5368

Part No.	Picture	Description	Comment
KX-J07W,B KX-J15W,B KX-J25W,B		Handset cord	7 feet 15 feet 25 feet

For your future reference

SERIAL NO. _____
(found on the bottom of the unit)

DATE OF PURCHASE _____

NAME OF DEALER _____

DEALER'S ADDRESS _____

Panasonic Company

Division of Matsushita Electric Corporation of America

One Panasonic Way, Secaucus, New Jersey 07094

Panasonic Company (West) of America

Division of Matsushita Electric Corporation of America

6550 Katella Avenue, Cypress, California. 90630

Panasonic Sales Company ("PSC")

Division of Matsushita Electric of Puerto Rico, Inc.

San Gabriel Industrial Park, 65th Infantry Avenue, KM 9.5, Carolina, P.R. 00630

Free Manuals Download Website

<http://myh66.com>

<http://usermanuals.us>

<http://www.somanuals.com>

<http://www.4manuals.cc>

<http://www.manual-lib.com>

<http://www.404manual.com>

<http://www.luxmanual.com>

<http://aubethermostatmanual.com>

Golf course search by state

<http://golfingnear.com>

Email search by domain

<http://emailbydomain.com>

Auto manuals search

<http://auto.somanuals.com>

TV manuals search

<http://tv.somanuals.com>