

**Operating Instructions
Bedienungsanleitung
Instructions d'utilisation
Istruzioni per l'uso
Gebruiksaanwijzing
Manual de instrucciones
Brugsvejledning
Driftsföreskrifter
Bruksanvisning
Käyttöohjeet**

Panasonic

Cordless Drill & Driver/Cordless Hammer Drill & Driver
Akku-Bohrschrauber/Akku-Schlagbohrschrauber
Perceuse-visseuse sans fil/Perceuse à percussion-visseuse sans fil
Trapano avvitatore cordless/Trapano avvitatore cordless a percussione
Snoerloze schroef-boormachine/Snoerloze slagschroef-boormachine
Destornillador y taladro sin cables/Destornillador y taladro percutor sin cables
Akku bor & skruetrækker/Akku hammerbor & skruetrækker
Sladdlös skruvdragare & bormaskin/slagbormaskin
Ledningløs drill og skrutrekker/Ledningløs slagdrill og skrutrekker
Ladattava pora & ruuvinväännin/ladattava vasaraporapora & ruuvinväännin

Model No: EY7441/EY7940/EY74A1

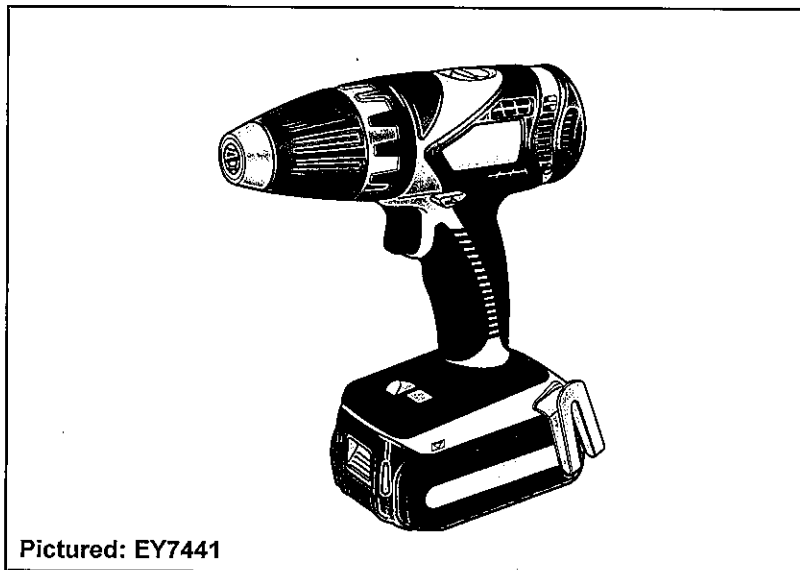

Pictured: EY7441

Before operating this unit, please read these instructions completely and save this manual for future use.

Vor Inbetriebnahme des Gerätes die Betriebsanleitung bitte gründlich durchlesen und diese Broschüre zum späteren Nachschlagen sorgfältig aufbewahren.

Lire entièrement les instructions suivantes avant de faire fonctionner l'appareil et conserver ce mode d'emploi à des fins de consultation ultérieure.

Prima di usare questa unità, leggere completamente queste istruzioni e conservare il manuale per usi futuri.

Lees deze gebruiksaanwijzing aandachtig door voor u het apparaat in gebruik neemt en bewaar de gebruiksaanwijzing voor eventuele naslag.

Antes de usar este aparato por primera vez, lea todas las instrucciones de este manual y guarde el manual para poderlo consultar en el futuro.

Gennemlæs denne betjeningsvejledning før brugen og gem den til fremtidig brug.

Läs igenom hela bruksanvisningen innan verktyget tas i bruk. Spara bruksanvisningen för senare användning.

Før enheten tas i bruk, vennligst les disse alle anvisningene og oppbevar derefter bruksanvisningen for senere bruk.

Lue ohjeet huolella ennen laitteen käyttöönottoa ja säilytä tämä käyttöohje tallessa tulevaa tarvetta varten.

Index/Index/Index/Indice/Index/Indice/Indeks/Index/Indeks/Hakemisto

English:	Page	8	Español:	Página	68
Deutsch:	Seite	20	Dansk:	Side	80
Français:	Page	32	Svenska:	Sid	92
Italiano:	Pagina	44	Norsk:	Side	103
Nederlands:	Bladzijde	56	Suomi:	Sivu	114

**FUNCTIONAL DESCRIPTION
FUNKTIONSBESCHREIBUNG
DESCRIPTION DES FONCTIONS
DESCRIZIONE DELLE FUNZIONI
FUNCTIEBESCHRIJVING
DESCRIPCIÓN FUNCIONAL
FUNKTIONSBESKRIVELSE
FUNKTIONSBESKRIVNING
FUNKSJONSBESKRIVELSE
TOIMINTAKUVAUS**

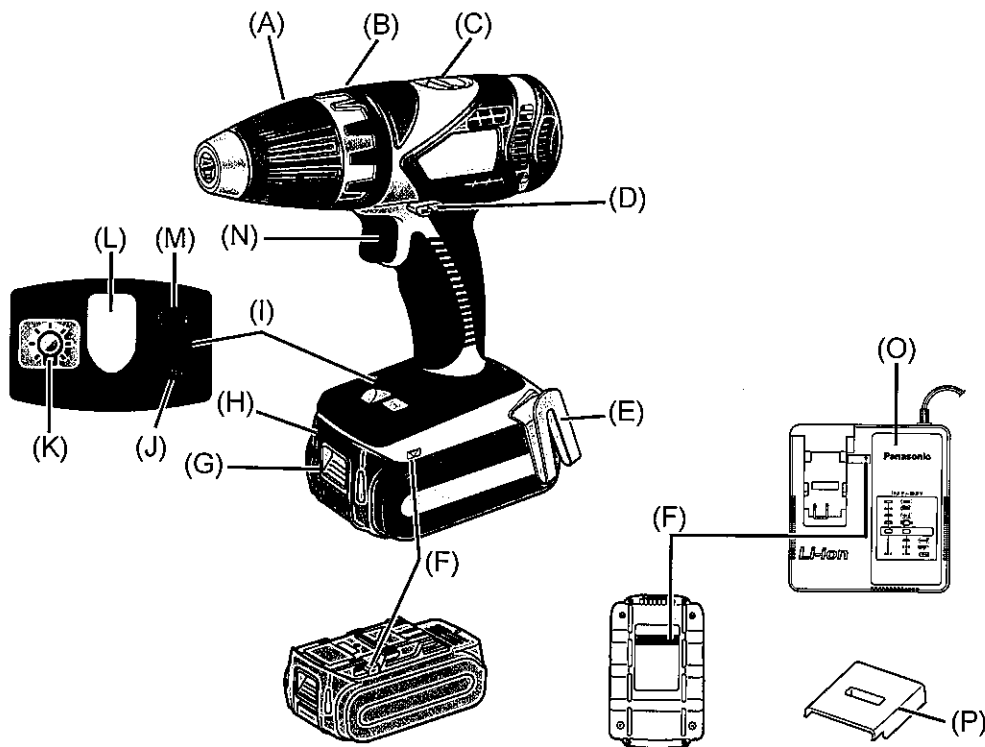

(A)	Keyless drill chuck Schlüssselfreies Bohrfutter Mandrin porte-foret sans fil Mandrino autoserrante Boorkop zonder sleutel Mandril sin llave Nøglefri borepatron Nyckellös borrchuck Nøkkelfri drillchuck Avaimeton poran kiinnityslaite	(B)	Clutch handle Kupplungsring Poignée de l'embrayage Impugnatura frizione Koppelingshandgreep Mango de embrague Koblinghåndtag Kopplingshandtag Koblingshåndtak Kytkimen kahva
(C)	Speed selector switch Bereichsschalter Interrupteur de sélection de vitesse Regolatore di velocità Snelheidskeuzeschakelaar Interruptor selector de velocidad Hastighedsvælger Hastighetsomkopplare Hastighetskontroll Nopeuden valintakytkin	(D)	Forward/Reverse lever Rechts/Linkslauf Schalter Levier d'inversion marche avant-marche arrière Leva di avanzamento/inversione Voorwaarts/achterwaarts-hendel Palanca de avance/inversión Greb til forlæns/baglæns retning Riktningssomkopplare Forover/Revers bryter Eteenpäin/taaksepäin vipu
(E)	Belt hook Riemenhaken Crochet de ceinture Gancio da cintura Riemclip Gancho del cinturón Bæltekrog Bälteskrok Beltekrok Vyölenkki	(F)	Alignment marks Ausrichtmarkierungen Marques d'alignement Marcature allineamento Uitlijntekens Marcas de alineación Flugtemærker Anpassningsmärken Opprettingsmerke Sovitusmerkit
(G)	Battery pack release button Akku-Entriegelungsknopf Bouton de libération de batterie autonome Tasto di rilascio pacco batteria Accu-ontgrendeltoets Botón de liberación de batería Udløserknop til batteripakning Frigöringsknapp för batteri Utløserknapp for batteripakke Akkupaketin irrotuspainike	(H)	Battery pack Akku Batterie autonome Pacco batteria Accu Batería Batteripakning Batteri Batteripakke Akku
(I)	Control panel Bedienfeld Panneau de commande Pannello di controllo Bedieningspaneel Panel de controle Kontrolpanel Kontrollpanel Kontrollpanel Säätöpaneeli	(J)	Overheat warning lamp (battery) Überhitzungs-Warnlampe (Akku) Témoïn d'avertissement de surchauffe (batterie) Spia avvertenza surriscaldamento (batteria) Oververhitting-waarschuwinglampje (accu) Luz de advertencia de sobrecalentamiento (batería) Advarselslamp til overophedning (batteri) Varningslampa för överhettning (batteri) Varsellampe for overoppheting (batteri) Ylikuumenemisen varoituslamppu (akku)
(K)	LED light on/off button LED-Leuchten-EIN/AUS-Taste Bouton Marche/Arrêt de la lumière DEL Tasto di accensione e spegnimento della luce LED Aan/uit-toets (ON/OFF) voor LED-lampje Botón ON/OFF de luz LED TÆND/SLUK-knap til LED-lys Strömbrytare för LED-ljus PÅ/AV-knapp for LED-lys LED-valon kytkin/katkaisupainike	(L)	LED light LED-Leuchte Lumière DEL Luce LED LED-lampje Luz indicadora LED-lys LED-ljus LED-lys LED-valo

(M)	Battery low warning lamp Akkuladungs-Warnlampe Témoins d'avertissement de batterie basse Spia avvertenza batteria scarica Waarschuwinglampje voor lage accuspanning Luz de aviso de baja carga de batería Advarselslampe batterieffekt lav Varningslampa för svagt batteri Varsellampe for at batteriet er for lavt Alhaisen akkujännitteen varoituslamppu	(N)	Variable speed control trigger Betriebsschalter Gâchette de commande de vitesse Grilletto di controllo velocità variabile Startschakelaar variabele snelheid Disparador del control de velocidad variable Kontroludløser for variabel hastighed Steglös varvtalsreglerare Hovedbryter, trinnløs Nopeudensäätökytkin
(O)	Battery charger Ladegerät Chargeur de batterie Caricabatterie Acculader Cargador de batería Batterioplader Batteriladdare Batterilader Akkulaturi	(P)	Pack cover Akkuabdeckung Couvercle de la batterie autonome Coperchio pacco Accudeksel Cubierta de batería Pakningsdæksel Batteriskydd Pakkedeksel Akkukotelon kansi

Recommendations for use / Gebrauchsempfehlungen / Recommandations concernant l'utilisation /
Precauzioni d'uso / Aanbevelingen voor gebruik / Recomendaciones par el uso / Anbefalinger for brugen /
Rekommendationer för användning / Anbefalt bruk / Käyttösuositukset

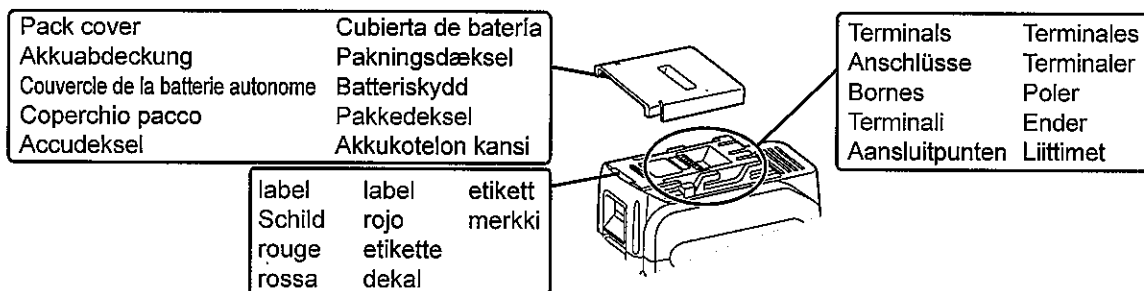

GB Be sure to use the Pack cover

- When the battery pack is not being used, store the battery in a way that foreign substances such as dust and water etc. do not contaminate the terminals. Be sure to attach the battery pack cover to protect the battery terminals.
 - When charging the battery pack, confirm that the terminals on the battery charger are free of foreign substances such as dust and water etc. Clean the terminals before charging the battery pack if any foreign substances are found on the terminals.
- The life of the battery pack terminals may be affected by foreign substances such as dust and water etc. during operation.

⚠ CAUTION: To protect the motor or battery, be sure to note the following when carrying out this operation.

- If the motor or battery becomes hot, the protection function will be activated and the motor or battery will stop operating.

The overheat warning lamp on the control panel illuminates or flashes when this feature is active.

For safe use

- The battery pack is designed to be installed by proceeding two steps for safety. Make sure the battery pack is installed properly to the main body before use.
- If the battery pack is not inserted firmly when the switch is switched on, the overheat warning lamp and the battery low warning lamp will flash to indicate that safe operation is not possible, and the bit will not rotate normally. Insert the battery pack into the body of the tool until the red label disappears.

D Unbedingt die Akkuschutzkappe verwenden

- Wenn der Akku nicht benutzt wird, bewahren Sie ihn so auf, dass die Kontakte nicht durch Fremdstoffe, wie z. B. Staub und Wasser usw., verschmutzt werden. Bringen Sie unbedingt die Akkuschutzkappe zum Schutz der Kontakte an.
 - Achten Sie beim Laden des Akkus darauf, dass die Kontakte am Ladegerät frei von Fremdstoffen, wie z. B. Staub und Wasser usw., sind. Reinigen Sie die Kontakte vor dem Laden des Akkus, falls Fremdstoffe auf den Kontakten vorhanden sind.
- Die Lebensdauer der Akkukontakte kann durch Anhaften von Fremdstoffen, wie z. B. Staub und Wasser usw., während des Betriebs beeinträchtigt werden.

- ⚠ VORSICHT:** Zum Schutz des Motors und des Akkus müssen beim Betrieb die folgenden Punkte beachtet werden.
- Bei einer Motor- oder Akkuüberhitzung spricht die Schutzschaltung an, um den Betrieb des Motors bzw. des Akkus zu unterbrechen. Die Überhitzungswarnleuchte auf dem Bedienungsfeld leuchtet oder blinkt bei aktivierter Funktion.

Für den sicheren Gebrauch

- Der Akku ist aus Sicherheitsgründen so entworfen, dass er in zwei Schritten eingesetzt werden muss. Vergewissern Sie sich vor der Inbetriebnahme der Maschine, dass der Akku ordnungsgemäß in diese eingesetzt ist.
- Wenn der Akku nicht fest eingesetzt ist, blinken die Überhitzungs-Warnlampe und die Akkuladungs-Warnlampe und das Gerät dreht den Bohrer nicht wie üblich, um darauf hinzuweisen, dass das Gerät nicht betriebs sicher arbeitet, selbst wenn ein Schalter ausgelöst wird. Schieben Sie den Akku soweit in das Gerät hinein, bis das rote Schild verschwindet.

F Veuillez à utiliser le couvercle de la batterie autonome

- Lorsque le couvercle de la batterie autonome n'est pas utilisé, rangez la batterie de façon à ce qu'aucun corps étranger comme de la poussière et de l'eau ne contamine les bornes. Veuillez à fixer le couvercle de la batterie autonome afin de protéger les bornes de la batterie.
 - Lors de la charge de la batterie autonome, assurez-vous que les bornes du chargeur de batterie sont libres de tout corps étranger comme de la poussière et de l'eau, etc. Nettoyez les bornes avant de charger la batterie autonome si des corps étrangers se trouvent sur les bornes.
- La durée de vie des bornes de la batterie autonome peut être affectée par des corps étrangers comme de la poussière et de l'eau, etc. pendant le fonctionnement.

- ⚠ MISE EN GARDE:** Pour protéger le moteur ou la batterie, veuillez à bien noter les points suivants lorsque vous effectuez cette opération.

- Si le moteur ou la batterie deviennent chauds, la fonction de protection sera activée et le moteur ou la batterie cesseront de fonctionner. Le témoin d'avertissement de surchauffe s'allume ou clignote sur le panneau de commande lorsque cette caractéristique est active.

Pour un usage sans risque

- La batterie est conçue pour être installée en procédant en deux étapes pour des raisons de sécurité. Assurez-vous que la batterie est mise en place correctement avant d'utiliser l'outil.
- Lorsque la batterie autonome n'est pas fermement insérée, le témoin d'avertissement de surchauffe et le témoin d'avertissement de batterie basse clignotent et la machine ne fait pas tourner la mèche comme habituellement pour nous signaler que la machine ne fonctionne pas en toute sécurité même si un interrupteur a été enclenché. Insérez la batterie autonome dans le corps de l'outil jusqu'à ce que l'indicateur rouge disparaisse.

I Assicursarsi di usare il coperchio del pacco batteria

- Quando il pacco batteria non viene usato, conservare la batteria in modo che sostanze estranee, quali polvere, acqua, ecc non contaminino i terminali. Assicursarsi di applicare il coperchio al pacco batteria per proteggere i terminali della batteria.
 - Quando il pacco batteria viene caricato, assicurarsi che i terminali sul caricabatteria siano privi di sostanze estranee, quali polvere, acqua, ecc. Pulire i terminali prima di caricare il pacco batteria, qualora vengano trovate sostanze estranee sui terminali.
- La durata dei terminali del pacco batteria può essere influenzata da sostanze estranee, quali polvere, acqua, ecc. durante il funzionamento.

- ⚠ PRECAUZIONE:** Per proteggere il motore o la batteria, tenere presente quanto segue nell'esecuzione del lavoro.
- Se il motore o la batteria si scurriscaldano verrà attivata la funzione di protezione, che comporta l'arresto del motore o della batteria. Quando questa funzione è attiva, sul pannello di controllo lampeggia la spia di avvertenza da surriscaldamento.

Per un utilizzo sicuro

- Il pacco batteria è stato ideato per essere installato tramite una procedura a due fasi per motivi di sicurezza. Prima dell'uso, verificare che il pacco batteria sia inserito correttamente nel corpo principale.
- Quando il pacco batteria non è ben inserito, la spia avvertenza surriscaldamento e la spia avvertenza batteria scarica lampeggiano e l'apparecchio non fa ruotare la punta come di consueto per avvertire l'utente che l'utensile non sta funzionando in modo sicuro anche se l'interruttore è bloccato. Inserire il pacco batteria nell'alloggiamento dell'utensile fino alla scomparsa dell'etichetta rossa.

NL Zorg ervoor het accudeksel te gebruiken

- Wanneer de accu niet wordt gebruikt, de accu op een zodanige manier bewaren dat vreemde bestanddelen zoals stof en water, enz. de aansluitingen niet kunnen verontreinigen.
- Kijk bij het laden van de accu of de aansluitingen op de acculader vrij zijn van vreemde bestanddelen zoals stof en water, enz. Reinig de aansluitingen als u vreemde bestanddelen op de aansluitingen aantreft. De levensduur van de accu-aansluitingen kan tijdens gebruik nadelig beïnvloed worden door vreemde bestanddelen zoals stof en water, enz.

⚠ OPGELET: Let bij het gebruik van het gereedschap op deze wijze op het volgende om de motor en de accu te beschermen.

- Als de motor of de accu oververhit raakt, wordt de beveiligingsfunctie geactiveerd en zal de motor of de accu stoppen met werken. Het oververhittingwaarschuwinglampje op het bedieningspaneel brandt of knippert wanneer deze beveiligingsfunctie is geactiveerd.

Voor een veilig gebruik

- Het aanbrengen van de accu moet om veiligheidsredenen in twee stappen worden uitgevoerd. Zorg dat de accu vóór gebruik goed op het gereedschap is bevestigd.
- Als de accuset niet goed is bevestigd, gaan het oververhitting-waarschuwinglampje (accu/motor) en het waarschuwinglampje voor lage accuspanning knipperen en draait de bit niet op het apparaat, zoals gebruikelijk. Dit is een waarschuwing dat het apparaat niet op veilige wijze kan worden gebruikt, zelfs niet als een schakelaar wordt bediend. Plaats de accu in het gereedschap totdat het rode label verdwijnt.

E Asegúrese de utilizar la cubierta de la caja de batería

- Cuando no utilice la caja de batería, guarde la batería de tal forma que las materias extrañas tales como polvo y agua, etc. ensucien los terminales. Asegúrese de colocar la cubierta de la caja de batería de tal forma de proteger los terminales de la batería.

- Cuando cargue la caja de batería, confirme que los terminales en el cargador de batería estén libres de materias extrañas tales como polvo y agua, etc. Limpie los terminales antes de cargar la caja de batería si hay materias extrañas en los terminales.

La vida de los terminales de la caja de batería puede verse afectada por materias extrañas tales como polo y agua, etc. durante su funcionamiento.

⚠ PRECAUCIÓN: Para proteger el motor o la batería, asegúrese de observar lo siguiente cuando efectúe esta operación.

- Si el motor o la batería se calienta, se activará la función de protección y el motor o la batería dejará de funcionar. La lámpara de advertencia de sobrecalentamiento en el panel de control se ilumina o destella cuando esta característica está activada.

Para un uso más seguro

- La batería está diseñada para instalarse siguiendo dos pasos por motivos de seguridad. Compruebe que la batería está instalada correctamente en el cuerpo principal antes de utilizar la herramienta.
- Si la batería no ha quedado bien introducida, la luz de advertencia de sobrecalentamiento y la luz de aviso de baja carga de batería parpadearán, y la broca no girará del modo habitual para alertar al operario de que la máquina no funcionará de manera segura si se acciona algún interruptor. Introduzca la batería en el cuerpo de la herramienta hasta que el indicador rojo desaparezca.

DK Sørg for at anvende batteripakningsdækslet

- Når batteripakningen ikke anvendes, skal batteriet opbevares således, at uvedkommende substanser, som for eksempel støv og vand etc., ikke kan komme til at forurene terminalerne. Sørg for at sætte batteripakningsdækslet på for at beskytte batteriterminalerne.

- Når du oplader batteripakningen, skal du bekræfte at terminalerne på batteriopladeren er fri for uvedkommende substanser, som for eksempel støv og vand etc. Rengør terminalerne inden du oplader batteripakningen, hvis uvedkommende substanser observeres på terminalerne.

Levetiden for batteripakningens terminaler kan påvirkes af uvedkommende substanser, som for eksempel støv og vand etc., under brugen.

⚠ FORSIGTIG: For at beskytte motoren og batteriet, skal man være opmærksom på følgende, når denne operation udføres.

- Hvis motoren eller batteriet bliver varme, vil beskyttelseskredsløbet blive aktiveret og motoren eller batteriet vil holde op med at fungere. Advarselslampen til overophedning på kontrolpanelet lyser eller blinker, når denne egenskab er aktiveret.

For sikker brug

- Batteripakken er beregnet til at blive installeret ved at følge en fremgangsmåde med to trin for sikkerheden skyld. Kontroller, at batteripakningen er korrekt installeret i hoveddelen før brug.
- Når batteripakningen ikke er isat korrekt, vil advarselslampe til overophedning og advarselslampen batterieffekt lav blinke, og maskinen vil ikke dreje boret som sædvanligt, for at lade os vide at maskinen ikke arbejder sikkert, selv om der trykkes på kontakter. Indsæt batteripakken i selve værktøjet, indtil den røde etikette forsvinder.

S Se till att använda batteriskyddet

- När batteriet inte används bör det förvaras på ett sätt som gör att främmande ämnen, såsom damm eller vatten, inte kan hamna på batteripolerna. Var noga med att skydda batteripolerna genom att sätta på batteriskyddet.
- Kontrollera vid laddning av batteriet att polerna på batteriladdaren är fria från främmande ämnen, såsom damm eller vatten. Rengör polerna innan batteriet laddas, om något främmande ämne återfinns på polerna. Batteripolernas livslängd kan vid drift påverkas av främmande ämnen, såsom damm eller vatten.
- ⚠ **VIKTIGT:** För att skydda motorn och batteriet, skall du komma ihåg följande vid denna användning.
- Om motorn eller batteriet överhettas, aktiveras skyddsfunktionen och då slutar motorn eller batteriet att fungera. Varningslampan för överhettning på kontrollpanelen lyser eller blinkar när denna funktion har aktiverats.

För säker användning

- Batteriet ska monteras genom vidta två säkerhetsåtgärder. Kontrollera att batteriet är ordentligt monterat på verktyget före användning.
- När batteriet inte är ordentligt monterat kommer varningslamporna för överhettning och svagt batteri att blinka och borrspetsen roterar inte vilket talar om att maskinen inte är säker även om en brytare aktiveras. För in batteriet i verktyget tills du inte längre kan se den röda dekalen.

N Ikke glem å bruke batteripakkedekselet

- Når batteripakken ikke er i bruk, legg batteriet på et sted der fremmedlegemer så som støv eller vann ikke forurensrer batteripolene. Ikke glem å bruke batteripakkedekselet for å beskytte batteripolene.
- Ved oppladning av batteripakken, kontroller at polene på batteriladeren er fri for fremmedlegemer så som støv eller vann. Rens polene før du lader opp batteripakken hvis du finner fremmedlegemer på polene. Batteripakkepolenes levetid kan bli påvirket av fremmedlegemer så som støv eller vann mens de er i bruk.
- ⚠ **FORSIKTIG:** For å beskytte motoren eller batteriet, pass på følgende når dette arbeidet utføres.
- Hvis motoren eller batteriet blir oppheting vil beskyttelsesfunksjonen tre i funksjon og motoren eller batteriet slutter å virke. Varsellampen for overoppheting på kontrollpanelet vil lyse eller blinke når denne funksjonen er aktiv.

For trygg og sikker bruk

- Batteripakken skal installers i henhold til en to-trinns sikkerhetsforanstaltning. Sørge for at batteripakken er korrekt installert i verktøyet før bruk.
- Når batteripakken ikke er satt inn korrekt, lyser varselampen for overoppheting (motor/batteri). Drillen roterer ikke bit-en som normalt og gjør dette for å indikere at drillen ikke fungerer på trygt og sikkert vis. Sett inn batteripakken i verktøyet inntil den røde etiketten forsvinner.

SF Käytä aina akkukantta

- Kun akkua ei käytetä, pane akku säilöön niin, että vieraat aineet kuten pöly, vesi jne. eivät liiäkiä. Muista panna akkukansi paikalleen suojaamaan akkuliittimiä.
- Kun akku ladataan, varmista, että akkulatorin liittimissä ei ole vieraita aineita kuten pölyä tai vettä. Jos liittimistä löytyy vieraita aineita, puhdista liittimet ennen akun lataamista.
- Akkuliittimissä käytön aikana olevat vieraat aineet kuten pöly ja vesi saattavat heikentää akun käyttöikä.
- ⚠ **TÄRKEÄ HUOMAUTUS:** Moottorin tai akun suojaamiseksi ota huomion seuraavat seikat, kun suoritat tätä toimenpidettä.
- Jos moottori tai akku kuumenee, suojaustoiminto käynnistyy ja moottori tai akku lakkaa toimimasta. Säätöpaneelin ylikuumentumisen varoitusvalo palaa tai vilkkuu, kun tämä toiminto on käynnissä.

Turvallisen käytön takaamiseksi

- Akku on suunniteltu asennettavaksi kahden turvallisuutta koskevan toimenpiteen jälkeen. Varmista ennen käyttöä, että akku on kiinnitetty kunnolla perusrunkoon.
- Jos akkua ei kiinnitetä kunnolla, ylikuumentumisen varoituslamppu ja alhaisen akkujännitteen varoituslamppu vilkkuvat ja kone ei pyöritä kärkeä tavalliseen tapaan osoituksena siitä, että koneen toiminta ei ole turvallista, vaikka kytkin katkaistaisiin. Työnnä akku työkalun runkoon niin, että punainen merkki katoaa näkyvistä.

Original instructions: English
Translation of the original instructions:
Other languages

This tool, as a complete unit with a battery pack, satisfies appropriate IP Degrees of Protection based on the IEC regulations.

Definition of IP code

IP5X: Ingress of dust is not totally prevented, but dust shall not penetrate in a quantity to interfere with satisfactory operation of the tool or to impair safety (In case that the talcum powder under 75 µm intrudes inside the tool)
IPX6: Water projected in powerful jets against the tool from any direction shall have no harmful effects (In case that, with a nozzle of 12.5 mm inner diameter, approximately 100 L/min of normal temperature water is injected to the tool for 3 minutes from 3 meter distance)

LIMITED WARRANTY

The rating of IP56 qualifies this tool for the minimum impact of water or dust, but not for the assurance of performance in such conditions. See Safety and Operating Instructions for further details for proper operation.

Read "the Safety Instructions" booklet and the following before using.

I. INTENDED USE

These tools can be used to tighten screws in clutch mode and to drill holes in wood and metal in drill mode. Additionally, model EY7940 can be used to drill holes in soft concrete and similar materials in hammer mode.

Read the Safety Instructions booklet and the following before using.



II. ADDITIONAL SAFETY RULES

- 1) **Wear ear protectors.**
Exposure to noise can cause hearing loss.
- 2) **Use auxiliary handle supplied with the tool.**
Loss of control can cause personal injury.

- 3) **Hold power tools by insulated gripping surfaces when performing an operation where the cutting tool may contact hidden wiring; contact with a "live" wire will make exposed metal parts of the tool "live" and shock the operator.**
- 4) **Wear a dust mask, if the work causes dust.**
- 5) **Be aware that this tool is always in an operating condition, since it does not have to be plugged into an electrical outlet.**
- 6) **When drilling or driving into walls, floors, etc., "live" electrical wires may be encountered. DO NOT TOUCH THE CHUCK OR ANY FRONT METAL PARTS OF THE TOOL! Hold the tool only by the plastic handle to prevent electric shock in case you drill or drive into a "live" wire.**
- 7) **If the bit becomes jammed, immediately turn the trigger switch off to prevent an overload, which can damage the battery pack or motor. Use reverse motion to loosen jammed bits.**
- 8) **Do NOT operate the Forward/Reverse lever when the trigger switch is on. The battery will discharge rapidly and damage to the unit may occur.**
- 9) **During charging, the charger may become slightly warm. This is normal. Do NOT charge the battery for a long period.**
- 10) **When storing or carrying the tool, set the Forward/Reverse lever to the center position (switch lock).**
- 11) **Do not strain the tool by holding the speed control trigger halfway (speed control mode) so that the motor stops.**
- 12) **Do not operate the speed selector switch (LOW-HIGH) while pulling on the speed control trigger. This can cause the rechargeable battery to wear quickly or damage the internal mechanism of the motor.**

⚠ WARNING

- Do not use other than the Panasonic battery packs that are designed for use with this rechargeable tool.
- Panasonic is not responsible for any damage or accident caused by the use of recycled or counterfeit battery pack.
- Do not dispose of the battery pack in a fire, or expose it to excessive heat.
- Do not drive the likes of nails into the battery pack, subject it to shocks, dismantle it, or attempt to modify it.
- Do not allow metal objects to touch the battery pack terminals.
- Do not carry or store the battery pack in the same container as nails or similar metal objects.
- Do not charge the battery pack in a high-temperature location, such as next to a fire or in direct sunlight. Otherwise, the battery may overheat, catch fire, or explode.
- Never use other than the dedicated charger to charge the battery pack. Otherwise, the battery may leak, overheat, or explode.
- After removing the battery pack from the tool or the charger, always reattach the pack cover. Otherwise, the battery contacts could be shorted, leading to a risk of fire.
- When the Battery Pack Has Deteriorated, Replace It with a New One. Continued use of a damaged battery pack may result in heat generation, ignition or battery rupture.

Symbol	Meaning
V	Volts
— — —	Direct current
n_0	No load speed
$\dots\text{min}^{-1}$	Revolutions or reciprocations per minutes
Ah	Electrical capacity of battery pack
	To reduce the risk of injury, user must read and understand instruction manual.
	For indoor use only.

III. ASSEMBLY

Attaching or Removing Bit

NOTE:

When attaching or removing a bit, disconnect battery pack from tool or place the switch in the center position (switch lock).

This tool is equipped with a keyless drill chuck.

1. Attachment

Insert the bit and turn the lock collar clockwise (looking from the front) to tighten firmly until it stops clicking.

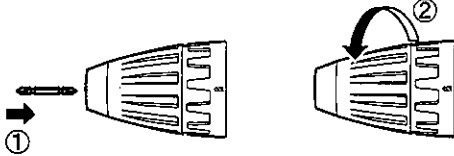

2. Removal

Turn the lock collar counterclockwise (looking from the front), then remove the bit.

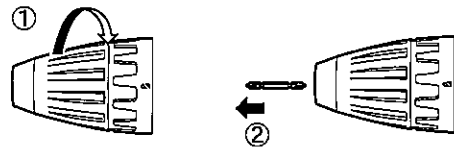

NOTE:

If excessive play occurs in the chuck, secure the drill in place and ① open the chuck jaws by turning the lock collar and ② tighten the screw (left-handed screw) with a screwdriver by turning it counterclockwise (viewed from the front).



Attaching or Removing Battery Pack

1. To connect the battery pack:

Line up the alignment marks and attach the battery pack.

- Slide the battery pack until it locks into position.

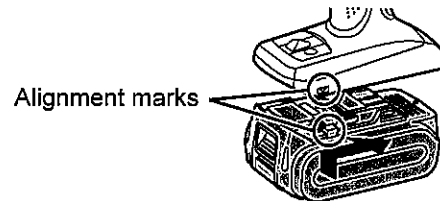

2. To remove the battery pack:

Pull the button from the front to release the battery pack.

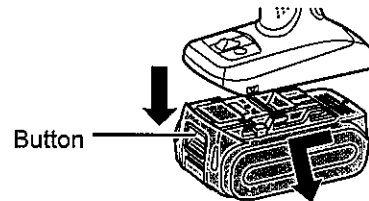

IV. OPERATION

[Main Body]

Switch Operation

1. The speed increases with the amount of depression of the trigger. When beginning work, depress the trigger slightly to start the rotation slowly.
2. A feedback electronic controller is used to give a strong torque even in low speed.
3. The brake operates when the trigger is released and the motor stops immediately.

NOTE:

When the brake operates, a braking sound may be heard. This is normal.

CAUTION:

When operating the tool by pulling the trigger, there may be a momentary lag before rotation starts. This does not signal a malfunction.

* This lag occurs as the tool's circuitry starts up when the trigger is pulled for the first time after installing a new battery pack or after the tool has not been used for at least 1 minute (or at least 5 minutes when the LED is on). Rotation will start without any lag during second and subsequent operations.

Switch and Forward/Reverse Lever Operation

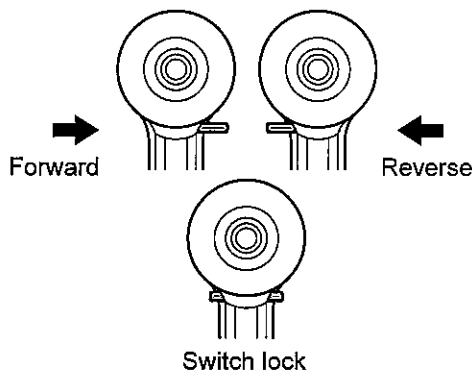

CAUTION:

To prevent damage, do not operate Forward/Reverse lever until the bit comes to a complete stop.

Forward Rotation Switch Operation

1. Push the lever for forward rotation.
2. Depress the trigger switch slightly to start the tool slowly.
3. The speed increases with the amount of depression of the trigger for efficient tightening of screws and drilling. The brake operates and the chuck stops immediately when the trigger is released.
4. After use, set the lever to its center position (switch lock).

Reverse Rotation Switch Operation

1. Push the lever for reverse rotation. Check the direction of rotation before use.
2. Depress the trigger switch slightly to start the tool slowly.

3. After use, set the lever to its center position (switch lock).

Clutch Torque Setting

Adjust the torque to one of the 18 clutch settings or "2" position (EY7441, EY74A1).

Adjust the torque to one of the 18 clutch settings or "2", "3" position (EY7940).

NOTE:

Always make sure to stop operation of the tool and disengage it from the work, when you select Hammering mode from Drilling mode or when you shift to Drilling mode from Hammering mode by rotating clutch handle.

CAUTION:

Set the clutch setting at this mark (◁) before actual operation.

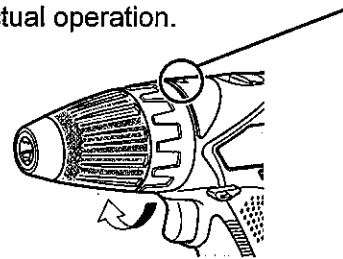

If the clutch handle cannot be set at "drilling" or "hammering" mode after driving with clutch function, set the clutch handle at position 1 and operate the clutch for a second.

Speed Selection

Choose a low or high speed to suit the use.



The more the variable speed control trigger is pulled, the higher the speed becomes.

CAUTION:

- Check the speed selector switch before use.
- Use at low speed when high torque is needed during operation. (Using at high speed when high torque is required may cause a motor breakdown.)

- Do not operate the speed selector switch (LOW-HIGH) while pulling on the speed control trigger. This can cause the rechargeable battery to wear quickly or damage the internal mechanism of the motor.
- * See specifications for "MAXIMUM RECOMMENDED CAPACITIES".

CAUTION:

- To prevent excessive temperature increase of the tool surface, do not operate the tool continuously using two or more battery packs. The tool needs cool-off time before switching to another pack.
- Do not close up vent holes on the sides of the body during operation. Otherwise, the machine function is adversely affected to cause a failure.
- Do NOT strain the tool (motor). This may cause damage to the unit.
- Use the tool in such a way as to prevent the air from the body vent holes from blowing directly onto your skin. Otherwise, you may get burned.

Bit-locking Function

1. With the trigger switch not engaged and a screwdriver bit locked in place, the tool can be used as a manual screwdriver (up to 22.6 N·m, 230 kgf-cm, 199 in-lbs). There will be a little play in the chuck, but this is not a malfunction.
2. This feature is handy for tightening screws that require more torque than the maximum torque of the driver (position 2 on the clutch), for confirming the tightness of a screw or to loosen an extremely tight screw.

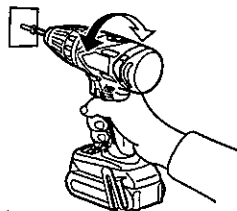

How to Use the Belt Hook

⚠ WARNING!

- Be sure to attach the belt hook securely to the main unit with the screw firmly fastened. When the belt hook is not firmly attached to the main unit, the hook may disconnect and the main unit may fall. This may result in an accident or injury.
- Periodically check screw for tightness. If found to be loose, tighten firmly.
- Be sure to attach the belt hook firmly and securely onto a waist belt or other belt. Pay attention that the unit does not slip off the belt. This may result in an accident or injury.
- When the main unit is held by the belt hook, avoid jumping or running with it. Doing so may cause the hook to slip and the main unit may fall. This may result in an accident or injury.
- When the belt hook is not used, be sure to return it to the storing position. The belt hook may catch on something. This may result in an accident or injury.
- When the unit is hooked onto the waist belt by the belt hook, do not attach driver bits to the unit. A sharp edge object, such as a drill bit, may cause injury or an accident.

To Change the Belt Hook Location Side

The belt hook can be attached to either side of the unit.

1. Removing the hook
 - (1) Remove the nut.
 - (2) Draw out the hook.

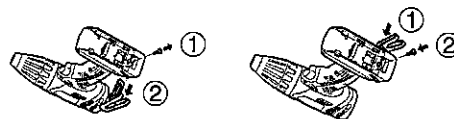

2. Attaching the hook to the other side
 - (1) Insert the hook in the other side.
 - (2) Tighten the nut fully so that it securely fastened.

Control Panel

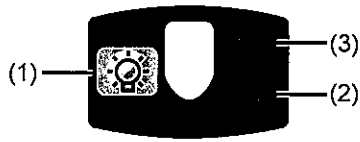

(1) LED light

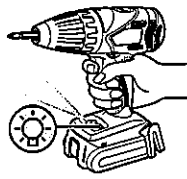

Before the use of LED light, always pull the power switch once.

Press  the LED light button.

The light illuminates with very low current, and it does not adversely affect the performance of the tool during use or its battery capacity.

CAUTION:

- The built-in LED light is designed to illuminate the small work area temporarily.
- Do not use it as a substitute for a regular flashlight, since it does not have enough brightness.
- LED light turns off when the tool has not been used for 5 minutes.

Caution: DO NOT STARE INTO BEAM. Use of controls or adjustments or performance of procedures other than those specified herein may result in hazardous radiation exposure.

(2) Overheat warning lamp

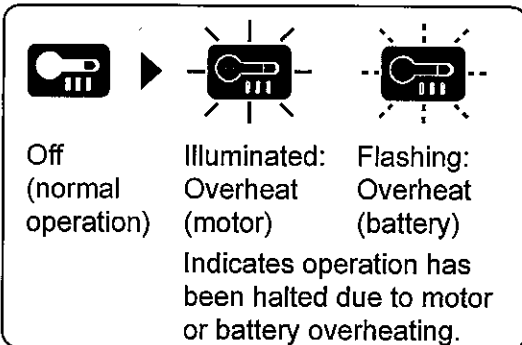

To protect the motor or battery, be sure to note the following when carrying out this operation.

- If the motor or battery becomes hot, the protection function will be activated and the motor or battery will stop operating. The overheat warning lamp on the control panel illuminates or flashes when this feature is active.
 - If the overheating protection feature activates, allow the tool to cool thoroughly (at least 30 minutes). The tool is ready for use when the overheat warning lamp goes out.
 - Avoid using the tool in a way that causes the overheating protection feature to activate repeatedly.
 - If the tool is operated continuously under high-load conditions or if it is used in hot-temperature conditions (such as during summer), the overheating protection feature may activate frequently.
 - If the tool is used in cold-temperature conditions (such as during winter) or if it is frequently stopped during use, the overheating protection feature may not activate.
 - The ambient temperature range is between 0°C (32°F) and 40°C (104°F). If the battery pack is used when the battery temperature is below 0°C (32°F), the tool may fail to function properly.
 - When charging a cool battery pack (below 0°C (32°F)) in a warm place, leave the battery pack at the place and wait for more than one hour to warm up the battery to the level of the ambient temperature.
 - If the tool is used in cold-temperature conditions (such as during winter) or if it is frequently stopped during use, the overheating protection feature may not activate.
- The performance of the EY9L42 deteriorates significantly at and below 10°C due to work conditions and other factors.

(3) Battery low warning lamp

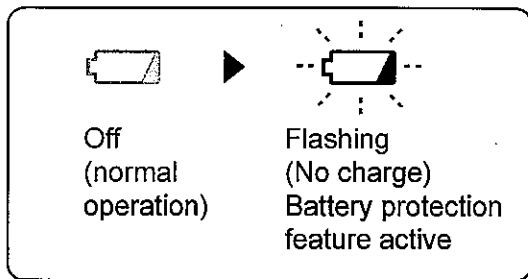

Excessive (complete) discharging of lithium ion batteries shortens their service life dramatically. The driver includes a battery protection feature designed to prevent excessive discharging of the battery pack.

- The battery protection feature activates immediately before the battery loses its charge, causing the battery low warning lamp to flash.
- If you notice the battery low warning lamp flashing, charge the battery pack immediately.
- If it is started with too little battery power remaining, the tool may stop operating without the battery low warning lamp flashing first. This indicates that there is too little battery power remaining to use the tool, and the battery pack should be charged before further use.
- If the tool is subject to a sudden load during use that causes the motor to lock up, the overdischarge prevention sensor may be triggered, and the battery low warning lamp may flash. The lamp will stop flashing once you address the cause of the motor's locking up and cycle the trigger.

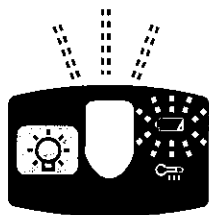

- The battery protection feature may activate when a high load is abruptly placed on the motor, even if ample battery charge remains. In this case, both the battery low warning lamp and LED light will flash (EY74A1).

- If both the battery low warning lamp and LED light flash, reduce the force with which you are pushing on the driver or, if using a drill driver, adjust the speed switch to a lower setting (EY74A1).

[Battery Pack]

For Appropriate Use of Battery Pack

Li-ion Battery Pack

- For optimum battery life, store the Li-ion battery pack following use without charging it.
- When charging the battery pack, confirm that the terminals on the battery charger are free of foreign substances such as dust and water etc. Clean the terminals before charging the battery pack if any foreign substances are found on the terminals.
The life of the battery pack terminals may be affected by foreign substances such as dust and water etc. during operation.
- When battery pack is not in use, keep it away from other metal objects like: paper clips, coins, keys, nails, screws, or other small metal objects that can make a connection from one terminal to another.
Shorting the battery terminals together may cause sparks, burns or a fire.
- When operating the battery pack, make sure the work place is well ventilated.
- When the battery pack is removed from the main body of the tool, replace the battery pack cover immediately in order to prevent dust or dirt from contaminating the battery terminals and causing a short circuit.

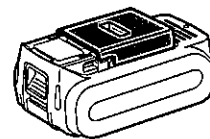

Battery Pack Life

The rechargeable batteries have a limited life. If the operation time becomes extremely short after recharging, replace the battery pack with a new one.

Battery Recycling

ATTENTION:

For environmental protection and recycling of materials, be sure that it is disposed of at an officially assigned location, if there is one in your country.

[Battery Charger]

Charging

CAUTION:

- If the temperature of the battery pack falls approximately below -10°C (14°F), charging will automatically stop to prevent degradation of the battery.
- The ambient temperature range is between 0°C (32°F) and 40°C (104°F). If the battery pack is used when the battery temperature is below 0°C (32°F), the tool may fail to function properly.
- When charging a cool battery pack (below 0°C (32°F)) in a warm place, leave the battery pack at the place and wait for more than one hour to warm up the battery to the level of the ambient temperature.
- Cool down the charger when charging more than two battery packs consecutively.
- Do not insert your fingers into contact hole, when holding charger or any other occasions.

To prevent the risk of fire or damage to the battery charger.

- Do not use power source from an engine generator.
- Do not cover vent holes on the charger and the battery pack.
- Unplug the charger when not in use.

NOTE:

Your battery pack is not fully charged at the time of purchase. Be sure to charge the battery before use.

Battery charger

1. Plug the charger into the AC outlet.
2. Insert the battery pack firmly into the charger.
 - 1) Line up the alignment marks and place the battery onto the dock on the charger.

- 2) Slide forward in the direction of the arrow.

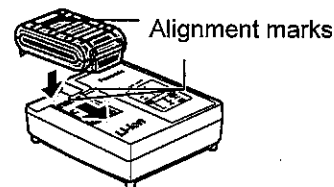

3. During charging, the charging lamp will be lit. When charging is completed, an internal electronic switch will automatically be triggered to prevent overcharging.
 - Charging will not start if the battery pack is warm (for example, immediately after heavy-duty operation). The orange standby lamp will be flashing until the battery cools down. Charging will then begin automatically.
4. The charge lamp (green) will flash slowly once the battery is approximately 80% charged.
5. When charging is completed, the charging lamp in green color will turn off.
6. If the temperature of the battery pack is 0°C or less, charging takes longer to fully charge the battery pack than the standard charging time. Even when the battery is fully charged, it will have approximately 50% of the power of a fully charged battery at normal operating temperature.
7. Consult an authorized dealer if the charging lamp (green) does not turn off.
8. If a fully charged battery pack is inserted into the charger again, the charging lamp lights up. After several minutes, the charging lamp in green color will turn off.

LAMP INDICATIONS

		Charging is completed. (Full charge.)
		Battery is approximately 80% charged.
		Now charging.
		Charger is plugged into the AC outlet. Ready to charge.
(Green) (Orange)		Charging Status Lamp. Left: green Right: orange will be displayed.
		Battery pack is cool. The battery pack is being charged slowly to reduce the load on the battery.
		Battery pack is warm. Charging will begin when temperature of battery pack drops. If the temperature of the battery pack is -10° or less, the charging status lamp (orange) will also start flashing. Charging will begin when the temperature of the battery pack goes up.
		Charging is not possible. Clogged with dust or malfunction of the battery pack.
Turn off	Lit	Flashing

Information for Users on Collection and Disposal of Old Equipment and used Batteries

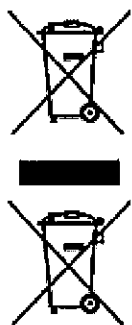

These symbols on the products, packaging, and/or accompanying documents mean that used electrical and electronic products and batteries should not be mixed with general household waste.

For proper treatment, recovery and recycling of old products and used batteries, please take them to applicable collection points, in accordance with your national legislation and the Directives 2002/96/EC and 2006/66/EC.

By disposing of these products and batteries correctly, you will help to save valuable resources and prevent any potential negative effects on human health and the environment which could otherwise arise from inappropriate waste handling.

For more information about collection and recycling of old products and batteries, please contact your local municipality, your waste disposal service or the point of sale where you purchased the items.

Penalties may be applicable for incorrect disposal of this waste, in accordance with national legislation.

For business users in the European Union

If you wish to discard electrical and electronic equipment, please contact your dealer or supplier for further information.

[Information on Disposal in other Countries outside the European Union]

These symbols are only valid in the European Union. If you wish to discard these items, please contact your local authorities or dealer and ask for the correct method of disposal.

Note for the battery symbol (bottom two symbol examples):

This symbol might be used in combination with a chemical symbol. In this case it complies with the requirement set by the Directive for the chemical involved.

V. MAINTENANCE

Use only a dry, soft cloth for wiping the unit. Do not use a damp cloth, thinner, benzene, or other Volatile solvents for cleaning.

In the event that the inside of the tool or battery pack is exposed to water, drain and allow to dry as soon as possible. Carefully remove any dust or iron filings that collect inside the tool. If you experience any problems operating the tool, consult with a repair shop.

VI. ACCESSORIES

Use only bits suitable for size of drill's chuck.

VII. APPENDIX

MAXIMUM RECOMMENDED CAPACITIES

Model		EY7441	EY7940	EY74A1
Screw driving	Machine screw	M5		
	Wood screw	ø6.8 mm		
Drilling	Self-drilling screw	ø6 mm		
	For Wood	ø35 mm		
	For Metal	ø13 mm		
	For Masonry	-	ø13 mm	-

VIII. SPECIFICATIONS

MAIN UNIT

Model		EY7441	EY7940	EY74A1	
Motor voltage		14.4 V		14.4 V	18 V
No load speed	Low	70~400 min ⁻¹		50~480min ⁻¹	80~600min ⁻¹
	High	200~1400 min ⁻¹		130~1400min ⁻¹	220~1750min ⁻¹
Blows Rate Per Minute	Low	-	1260~7200 min ⁻¹	-	-
	High	-	3600~25200 min ⁻¹	-	-
Chuck capacity		ø1.5 mm - ø13 mm			
Clutch torque		Approx 0.5N m-4.4Nm	Approx 1.0N m-4.4Nm	Approx 0.5N m-4.4Nm	
Overall length		193 mm	200 mm	203 mm	
Weight (with battery pack EY9L44)		1.75 kg	1.8 kg	1.85 kg	-
Weight (with battery pack EY9L45)		1.75 kg	1.8 kg	1.85 kg	-
Weight (with battery pack EY9L50)		-	-	-	1.95 kg
Weight (with battery pack EY9L51)		-	-	-	1.95 kg
Noise vibration		See the included sheet			

BATTERY PACK

Model No.	EY9L41	EY9L42	EY9L44	EY9L45	EY9L50	EY9L51
Storage battery	Li-ion Battery					
Motor voltage	14.4V DC (3.6V x 4 cells)		14.4V DC (3.6V x 8 cells)		18V DC (3.6V x 10 cells)	

BATTERY CHARGER

Model No.	EY0L81					
Electrical rating	See the rating plate on the bottom of the charger					
Weight	0.93 kg					
Charging time	EY9L41	EY9L42	EY9L44	EY9L45	EY9L50	EY9L51
	Usable:45min Full:60min	Usable:30min Full:35min	Usable:50min Full:65min	Usable:65min Full:80min	Usable:50min Full:65min	Usable:65min Full:80min
Model No.	EY0L82					
Electrical rating	See the rating plate on the bottom of the charger					
Weight	0.93 kg					
Charging time	EY9L41	EY9L42	EY9L44	EY9L45	EY9L50	EY9L51
	Usable:35min Full:50min	Usable:30min Full:35min	Usable:40min Full:55min	Usable:50min Full:60min	Usable:40min Full:55min	Usable:55min Full:70min

NOTE: This chart may include models that are not available in your area.

Please refer to the latest general catalogue.

NOTE: For the dealer name and address, please see the included warranty card.

ONLY FOR U. K.



IX. ELECTRICAL PLUG INFORMATION

FOR YOUR SAFETY PLEASE READ THE FOLLOWING TEXT CAREFULLY

This appliance is supplied with a moulded three pin mains plug for your safety and convenience.

A 5 amp fuse is fitted in this plug.

Should the fuse need to be replaced please ensure that the replacement fuse has a rating of 5 amp and that it is approved by ASTA or BSI to BS1362.

Check for the ASTA mark  or the BSI mark  on the body of the fuse.

If the plug contains a removable fuse cover you must ensure that it is refitted when the fuse is replaced.

If you lose the fuse cover the plug must not be used until a replacement cover is obtained.

A replacement fuse cover can be purchased from your local Panasonic Dealer.

IF THE FITTED MOULDED PLUG IS UNSUITABLE FOR THE SOCKET OUTLET IN YOUR HOME THEN THE FUSE SHOULD BE REMOVED AND THE PLUG CUT OFF AND DISPOSED OF SAFELY. THERE IS A DANGER OF SEVERE ELECTRICAL SHOCK IF THE CUT OFF PLUG IS INSERTED INTO ANY 13 AMP SOCKET.

If a new plug is to be fitted please observe the wiring code as shown below.

If in any doubt please consult a qualified electrician.

IMPORTANT:

The wires in this mains lead are coloured in accordance with the following code:

Blue: Neutral

Brown: Live

As the colours of the wire in the mains lead of this appliance may not correspond with the coloured markings identifying the terminals in your plug, proceed as follows.

The wire which is coloured BLUE must be connected to the terminal in the plug which is marked with the letter N or coloured BLACK.

The wire which is coloured BROWN must be connected to the terminal in the plug which is marked with the letter L or coloured RED. Under no circumstances should either of these wires be connected to the earth terminal of the three pin plug, marked with the letter E or the Earth Symbol .

How to replace the fuse: Open the fuse compartment with a screwdriver and replace the fuse and fuse cover if it is removable.

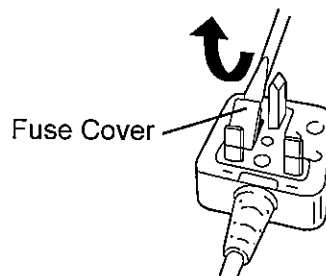

This apparatus was produced to BS800.

Free Manuals Download Website

<http://myh66.com>

<http://usermanuals.us>

<http://www.somanuals.com>

<http://www.4manuals.cc>

<http://www.manual-lib.com>

<http://www.404manual.com>

<http://www.luxmanual.com>

<http://aubethermostatmanual.com>

Golf course search by state

<http://golfingnear.com>

Email search by domain

<http://emailbydomain.com>

Auto manuals search

<http://auto.somanuals.com>

TV manuals search

<http://tv.somanuals.com>