

KX-TG1223

Panasonic

Operating Instructions

Digital Cordless Phone

Model No. **KX-TG1223BX**

Digital Cordless Answering System

Model No. **KX-TG1233BX**



This unit is Caller ID compatible. To display the caller's phone number, you must subscribe to Caller ID service.

Charge the batteries for about 7 hours before initial use.

Please read these operating instructions before using the unit and save them for future reference.



Introduction

Introduction

Thank you for purchasing a new Panasonic digital cordless phone.

For your future reference

Attach or keep original receipt to assist with any repair under warranty.

Serial No. (found on the bottom of the base unit)

Date of purchase

Name and address of dealer

Note:

- In the event of problems, you should contact your equipment supplier in the first instance.

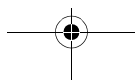
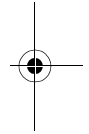
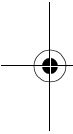

Feature highlights

Feature highlights



Phonebooks

This unit provides the handset phonebook (200 names and phone numbers; page 19) and the shared phonebook (20 names and phone numbers: KX-TG1233 only; page 22). These phonebooks allow you to make calls without having to dial manually. For handset phonebook, you can assign each handset phonebook entry to the desired category, and search for handset phonebook entries by name or category.



Handset phonebook category

If you subscribe to Caller ID service, handset phonebook categories (page 19) can help you identify who is calling by using different ringtones for different categories of callers (page 36).



Audible call for shared phonebook (KX-TG1233 only)

Audible call allows you to know who is calling without looking at the display. If you record an audible call announcement for a shared phonebook entry (page 22), the audible call recording will be announced when you receive a call from that person.

Audible call is available only after subscribing to Caller ID service (page 36).



Night mode

Night mode allows you to select a block of time during which the handset/base unit will not ring, useful if you do not want to be disturbed, for example, while sleeping.

Night mode can be set independently for the handset (page 27) and base unit (page 32).

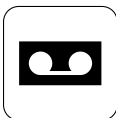

Digital answering system (KX-TG1233 only)

Digital answering system allows the unit to answer and record calls for you when you are unavailable to answer the phone (page 39).



Polyphonic ringtones

You can change the ringtone heard when the unit rings for calls. For handset, you can choose from 5 ringtones and 10 melody tones for outside calls and intercom calls (page 26). For base unit, you can choose from 6 ringtones for outside calls (page 18).

Table of Contents

Preparation

Accessory information 5
 Important information 6
 Controls and displays 7
 Connections 10
 Battery installation 10
 Battery charge 10
 Battery replacement 11
 Turning the power on/off 12
 Setting dialling mode (tone/pulse) 12
 Setting the date and time 12

Making/Answering Calls

Making calls using the handset 14
 Making calls using the base unit 16
 Answering calls using the handset 18
 Answering calls using the base unit 18

Phonebooks

Handset phonebook 19
 Shared phonebook (KX-TG1233 only) 22
 Copying phonebook entries 24

Handset Settings

Guide to handset settings 25
 Time settings 26
 Ringer setup 26
 Night mode 27
 Display setup 28
 Call options 29
 Other options 29

Base Unit Settings

Guide to base unit settings 31
 Ringer setup 32
 Call options 33
 Other options 35

Caller ID Service

Using Caller ID service 36
 Caller list 37
 Voice mail service 37

Answering System Features (KX-TG1233 only)

Answering system 39
 Turning the answering system on/off 39
 Greeting message 39
 Listening to messages 40
 Recording a voice memo using the handset 42
 Direct command operation using the handset 42
 Remote operation 43
 Guide to answering system settings 44

Multi-unit Operation

Operating additional units 46
 Registering a handset to a base unit 46
 Intercom 48
 Transferring calls, conference calls 49

Useful Information

Wall mounting 51
 Available character entries 52
 Troubleshooting 54
 Specifications 58

Index

Index 59

Preparation

Accessory information

Included accessories

AC adaptor
PQLV19BX

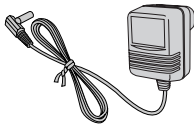

Telephone line cord

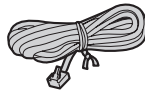

Rechargeable batteries
AAA (R03) size
HHR-4EPT



Handset cover

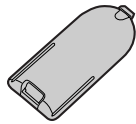

Operating instructions



Quick guide

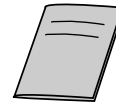

Additional/replacement accessories

| Model No. | Description |
|-------------|---|
| HHR-4EPT | 2 rechargeable nickel metal hydride (Ni-MH) batteries |
| KX-TCA121CX | Additional Digital Cordless Handset |
| KX-A272 | DECT repeater |

Preparation

Important information

General

- Use only the AC adaptor included with this product, noted on page 5.
- Do not connect the AC adaptor to any AC outlet other than a standard 220–240 V AC outlet.
- This product is unable to make calls when:
 - The portable handset battery(ies) need recharging or have failed.
 - There is a power failure.
 - The key lock feature is turned on.
 - The call bar feature is turned on (only phone numbers stored in the unit as emergency numbers can be called).
- Do not open the base unit or handset other than to replace the battery(ies).
- This product should not be used near emergency/intensive care medical equipment and should not be used by people with pacemakers.
- Care should be taken that objects do not fall onto, and liquids are not spilled into, the unit. Do not subject this product to excessive smoke, dust, mechanical vibration or shock.

Environment

- Do not use this product near water.
- This product should be kept away from heat sources such as radiators, cookers, etc. It should also not be placed in rooms where the temperature is less than 5 °C or greater than 40 °C.
- The AC adaptor is used as the main disconnect device. Ensure that the AC outlet is installed near the unit and is easily accessible.

Warning:

- To prevent the risk of electrical shock, do not expose this product to rain or any other type of moisture.
- Unplug this unit from power outlets if it emits smoke, an abnormal smell or makes unusual noise. These conditions can cause fire or electric shock. Confirm that smoke has stopped and contact an authorised service centre.

Location

- For maximum distance and noise-free operation, place your base unit:
 - Away from electrical appliances such as TVs, radios, personal computers or other phones.
 - In a convenient, high and central location.

Battery caution

- We recommend using the battery(ies) noted on page 5. **Use only rechargeable battery(ies).**
- Do not mix old and new batteries.
- Do not dispose of the battery(ies) in a fire, as they may explode. Check local waste management codes for special disposal instructions.
- Do not open or mutilate the battery(ies). Released electrolyte from the battery(ies) is corrosive and may cause burns or injury to the eyes or skin. The electrolyte may be toxic if swallowed.
- Exercise care when handling the battery(ies). Do not allow conductive materials such as rings, bracelets or keys to touch the battery(ies), otherwise a short circuit may cause the battery(ies) and/or the conductive material to overheat and cause burns.
- Charge the battery(ies) in accordance with the information provided in these operating instructions.

Preparation

- Only use the included base unit (or charger) to charge the battery(ies). Do not tamper with the base unit (or charger). Failure to follow these instructions may cause the battery(ies) to swell or explode.

Controls and displays

Controls

Handset

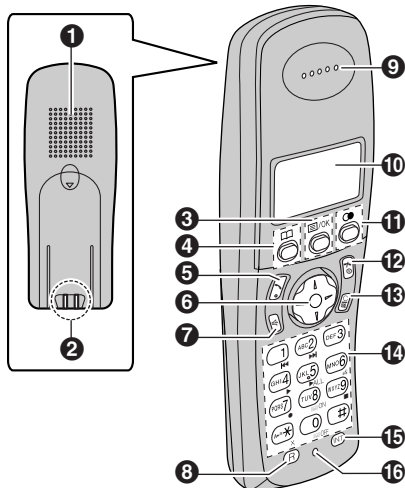

*The pictured model is KX-TG1233.

- 1 Speaker**
- 2 Charge contact**
- 3 [≡/OK] (Menu/OK)**
- 4 [☐] (Phonebook)**
- 5 [☎] (Talk)**
- 6 Navigator key**
 - [▲][▼]: To search for the desired item in menus.
 - [▶]: To select the desired item or move the cursor to the right.
 - [◀]: To return to the previous screen or move the cursor to the left.

- 7 [☎] (Speakerphone)**

- 8 [R] (Flash)**

- 9 Receiver**

- 10 Display**

- 11 [⏪] (Redial/Pause)**

- 12 [⏻] (Off/Power)**

- 13 [C/⊗] (Clear/Mute)**

- 14 Dial keypad**

- The icons printed below the dial keys shown in the illustration (▶, ⏪, ■ etc.) are found on the KX-TG1233 only. These icons indicate answering system operations.

- 15 [INT] (Intercom)**

- 16 Microphone**

Note:

- Up to 3 menu items can be displayed at a time. To select a menu item not shown on the current page, scroll up or down by pressing the navigator key, [▲] or [▼], respectively.

Preparation

Base unit (KX-TG1223)

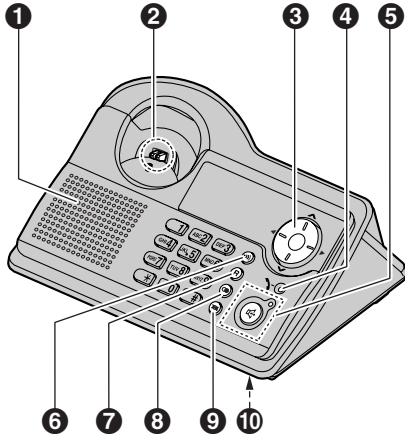

- 1 Speaker**
- 2 Charge contact**
- 3 Navigator key**
 - [∧][∨]: To adjust the ringer and speaker volumes.
 - [◀][▶]: To select the desired ringtone.
- 4 In use indicator**
 - Lights when a handset is in use (on a call, etc.).
 - Flashes when a call is being received.
- 5 [📞] (Speakerphone)/Speakerphone indicator**
- 6 [📄] (Page)**
- 7 [R] (Flash)**
- 8 [⏸] (Redial/Pause)**
- 9 [🔇] (Mute)**
- 10 Microphone**

Base unit (KX-TG1233)

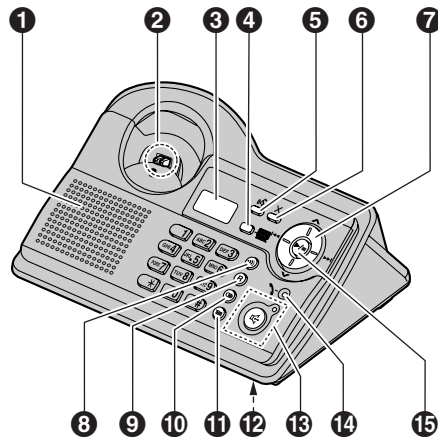







- 1 Speaker**
- 2 Charge contact**
- 3 Display**
- 4 [Answer on]/Answer on indicator**
- 5 [📞] (Greeting)**
- 6 [X] (Erase)**
- 7 Navigator key**
 - [∧][∨]: To adjust the ringer and speaker volumes.
 - [◀][▶]: To select the desired ringtone or to repeat or skip the recorded messages.
- 8 [📄] (Page)**
- 9 [R] (Flash)**
- 10 [⏸] (Redial/Pause)**
- 11 [🔇] (Mute)**
- 12 Microphone**
- 13 [📞] (Speakerphone)/Speakerphone indicator**
- 14 In use indicator**
 - Lights when a handset is in use (on a call, editing the shared phonebook, using the answering system, etc.).
 - Flashes when a call is being received or when the answering system is answering a call.
- 15 [▶■] (Play/Stop)**

Preparation

Displays



Handset display icons

Various icons appear on the handset display to indicate the current status of the unit.

| Display icon | Meaning |
|---|--|
|  | Within range of a base unit <ul style="list-style-type: none"> When flashing: Handset is searching for base unit. (out of range of base unit, handset is not registered to base unit, no power on base unit) |
|  | Handset is accessing base unit. (intercom, paging, changing base unit settings, etc.) |
|  | Handset is on an outside call. |
|  | Call bar is on. (page 29) |
|  | Answering system is on. (KX-TG1233 only; page 39) |
|  | Battery strength |
| [VE] | Voice enhancer is set to high or low tone. (page 15) |
| [N] | Night mode is on. (page 27) |
| [X] | Key lock is on. (page 15) |
| [2] | Handset number: The left icon shows handset 2 example. (page 28) |
| -2- | Base unit number: The left icon shows base unit 2 example. (page 28) |
| [IN USE] | KX-TG1223 users: The base unit or another handset is on a call. KX-TG1233 users: The base unit is on a call. Another handset is on a call or is using the answering system. |

Base unit display icons (KX-TG1233 only)

Following icons appear on the base unit display to indicate the current status of the unit.

| Display icon | Meaning |
|---|---|
|  | Answering system will answer calls with a greeting message and caller message will not be recorded. (page 45) |
|  | Ringer volume is off. (page 18) |

Preparation

Connections

When the AC adaptor is connected, a short beep will be heard. If it is not heard, check the connections.

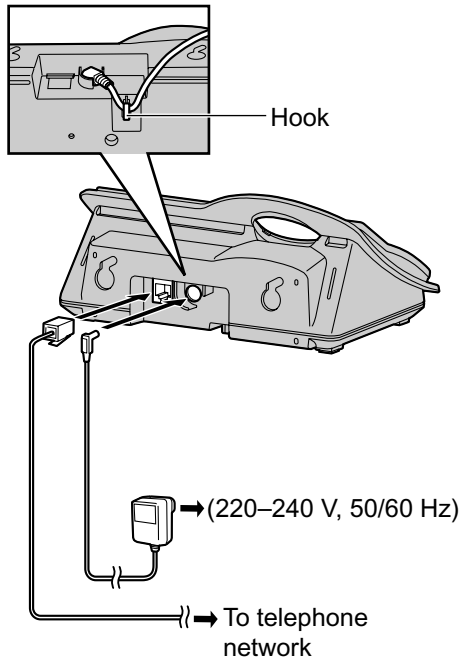

Important:

- Use only the AC adaptor and telephone line cord supplied with this unit.

Note:

- After connection, you must charge the batteries to make or answer calls with the handset (page 10).
- Never install telephone wiring during a lightning storm.
- The AC adaptor must remain connected at all times. (It is normal for the adaptor to feel warm during use.)
- The AC adaptor should be connected to a vertically oriented or floor-mounted AC outlet. Do not connect the AC adaptor to a ceiling-mounted AC outlet, as the weight

of the adaptor may cause it to become disconnected.

Battery installation

Important:

- Use only rechargeable batteries (page 5).
- Wipe the battery ends (+, -) with a dry cloth.
- When installing the batteries, avoid touching the battery ends (+, -) or the unit contacts.

- 1 Insert the batteries negative (-) end first.

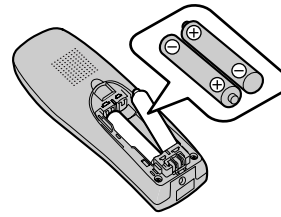

- 2 Close the handset cover.

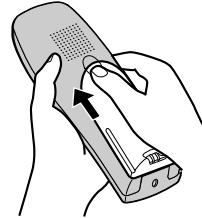

Battery charge

Place the handset on the base unit for about 7 hours before initial use.

When charging, the battery icon is shown as follows.

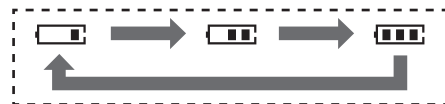

Preparation

When the batteries are fully charged,  remains on the display.

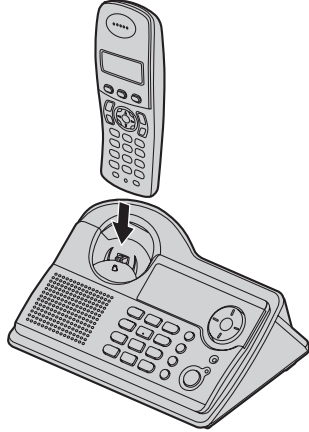



*The pictured model is KX-TG1223.



Note:

- It is normal for the handset to feel warm during charging.
- It takes 7 hours to fully charge the batteries, however, you can use the handset before the batteries are fully charged.
- Clean the charge contacts (page 7) of the handset and base unit with a soft, dry cloth once a month, otherwise the batteries may not charge properly. Clean more often if the unit is exposed to grease, dust or high humidity.

Battery strength

| Battery icon | Battery strength |
|---|--|
|  | High |
|  | Medium |
|  | Low When flashing: Needs to be charged. |

Note:

- When  flashes, recharge the handset batteries.  will continue to flash until

the batteries have been charged for at least 15 minutes.

- If the handset is turned off, it will be turned on automatically when it is placed on the base unit.

Battery life

After your Panasonic batteries are fully charged, you can expect the following performance:

Ni-MH batteries (700 mAh)

| Operation | Operating time |
|----------------------------|----------------|
| While in use (talking) | 20 hours max. |
| While not in use (standby) | 170 hours max. |

Note:

- Actual battery performance depends on a combination of how often the handset is in use (talking) and how often it is not in use (standby).
- Battery operating time may be shortened over time depending on usage conditions and ambient temperature.

Battery replacement

If  flashes even after the handset batteries have been charged for 7 hours, the batteries must be replaced.

Important:

- We recommend the use of Panasonic rechargeable batteries noted on page 5. If you install non-rechargeable batteries and start charging, the batteries may leak electrolyte.
- Do not mix old and new batteries.
- Wipe the battery ends (+, -) with a dry cloth.
- When installing the batteries, avoid touching the battery ends (+, -) or the unit contacts.

Preparation

- 1 Press the notch on the handset cover firmly and slide it in the direction of the arrow.

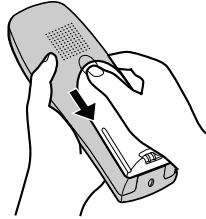

- 2 Remove the old batteries positive (+) end first and install the new ones. See page 10 for battery installation.

Turning the power on/off

Power on

Press [**⏻**] for about 1 second.

- The display will change to the standby mode.

Power off

Press [**⏻**] for about 2 seconds.

- The display will go blank.

Setting dialling mode (tone/pulse)

Change the dialling mode depending on your telephone line service.

“**Tone**”: Select when you have a touch tone service.

“**Pulse**”: Select when you have rotary or pulse service.

- 1 Press [**⏻**].
- 2 Select “**Base Unit Setup**”, then press [**▶**].
- 3 Enter “0000” (default base unit PIN).

- If you changed the PIN, enter it (page 35).

- 4 Select “**Call Options**”, then press [**▶**].
- 5 Select “**Dial Mode**”, then press [**▶**].
- 6 Select the desired setting, then press [**▶**].
- 7 Press [**⏻**].

Setting the date and time

Important:

- Confirm that the AC adaptor is connected.
- Ensure that **⏻** is not flashing.

- 1 Press [**⏻**].
- 2 Select “**Handset Setup**”, then press [**▶**].
- 3 Select “**Time Settings**”, then press [**▶**].
- 4 Select “**Set Date & Time**”, then press [**▶**].
- 5 Enter the current day, month and year by selecting 2 digits for each.
Example: 17 May, 2006
Press [**1**][**7**] [**0**][**5**] [**0**][**6**].
- 6 Enter the current hour and minute by selecting 2 digits for each.
• You can select “**AM**”, “**PM**” or 24-hour time entry by pressing [*****] repeatedly.
Example: 3:30 PM
Press [**0**][**3**] [**3**][**0**], then press [*****] repeatedly until “**03:30 PM**” is displayed.
- 7 Press [**⏻**].
- 8 Press [**⏻**].

Note:

- To correct a digit, press [**◀**] or [**▶**] to move the cursor, then make the correction.



Preparation

- The date and time may be incorrect after a power failure. In this case, set the date and time again.

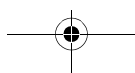
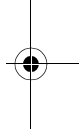
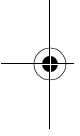

Making/Answering Calls

Making calls using the handset

- 1 Lift the handset and dial the phone number.
 - To correct a digit, press [C/✕], then enter the correct number.
- 2 Press [↶].
- 3 When finished talking, press [📞] or place the handset on the base unit.

Speakerphone

The handset features a digital speakerphone, which allows you to have hands-free conversations.

- 1 During a conversation, press [📞] to turn on the speakerphone.
 - Speak alternately with the caller.
- 2 When finished talking, press [📞] or place the handset on the base unit.

Note:

- For best performance, please note the following:
 - Use the speakerphone in a quiet environment.
- To switch back to the receiver, press [↶].

To adjust the receiver or speaker volume

Press [▲] or [▼] while talking. 4 volume levels are available for the receiver. 6 levels are available for the speaker.

Redial feature

Previously dialled phone numbers (each 24 digits max.) can be redialled.

To redial the last number dialled

Press [☎], then press [↶] or [📞].

- If [📞] is pressed, the unit will redial automatically if the other party's line is engaged.

Note:

- You can also press [↶] or [📞] before pressing [☎].

To make a call using the redial list

The last 10 phone numbers dialled are stored in the redial list.

- 1 Press [☎].
 - The last number dialled will be displayed.
- 2 Press [▲] or [▼] repeatedly to select the desired number.
 - To exit the list, press [📞].
- 3 Press [↶] or [📞].
 - If [📞] is pressed, the unit will redial automatically if the other party's line is engaged.

To redial automatically

If you press [📞] when redialling and the other party's line is engaged, the unit will redial the phone number again automatically. The unit will redial up to 11 times. While the handset is waiting to redial, [📞] will flash. While the handset is redialling, mute is automatically turned on.

Note:

- Automatic redial is cancelled when any button (except [☎]) is pressed.
- If mute does not turn off after the line is connected, press [C/✕].

To edit a number in the redial list before calling it

- 1 Press [☎].
- 2 Press [▲] or [▼] repeatedly to select the desired number, then press [☑/OK].
- 3 Select "Edit and Call", then press [▶].
- 4 Press [◀] or [▶] to move the cursor, then edit the number.

Making/Answering Calls

- Place the cursor on the number you wish to erase, then press **[C/⊗]**.
- Place the cursor to the right of where you want to insert a number, then press the appropriate dial key.

5 Press **[↶]** or **[↷]**.

To erase numbers in the redial list

- 1** Press **[☑]**.
- 2** Press **[▲]** or **[▼]** repeatedly to select the desired number, then press **[☑/OK]**.
- 3** Select **"Erase"**, then press **[▶]**.
 - If you want to erase all numbers in the list, select **"Erase All"**, then press **[▶]**.
- 4** Select **"Yes"**, then press **[▶]**.
- 5** Press **[↶⊗]**.

To store a number from the redial list into the handset phonebook

- 1** Press **[☑]**.
- 2** Press **[▲]** or **[▼]** repeatedly to select the desired number, then press **[☑/OK]**.
- 3** Select **"Add Phonebook"**, then press **[▶]**.
- 4** Enter a name (16 characters max.; see page 52 for character entry), then press **[☑/OK]**.
- 5** Edit the phone number if necessary, then press **[☑/OK]**.
- 6** Select the desired category (page 19), then press **[▶]**.
- 7** Select **"Save"**, then press **[▶]**.
- 8** Press **[↶⊗]**.

Other features

Voice enhancer

You can change the tone quality of the receiver while you are on a call. 3 settings are available.

- 1** Press **[☑/OK]** during a call.
 - For KX-TG1233 users, select **"Voice Enhancer"**, then press **[▶]**.
- 2** Select the desired setting, then press **[▶]**.

Note:

- If you select **"High Tone"** or **"Low Tone"**, **"[VE]"** is displayed.

Mute

You can mute your voice during a conversation. While mute is turned on, you will be able to hear the other party, but the other party will not be able to hear you.

- 1** To mute your voice, press **[C/⊗]**.
- 2** To return to the conversation, press **[C/⊗]** again.

Key lock

The handset can be locked so that no calls or settings can be made. Incoming calls can be answered, but all other functions are disabled while key lock is on.

To turn key lock on, press **[☑/OK]** for about 2 seconds.

- **"[X]"** is displayed.
- To turn key lock off, press **[☑/OK]** for about 2 seconds.

Note:

- Calls to emergency numbers (page 33) cannot be made until key lock is turned off.
- Key lock is turned off when the handset is turned off.

Making/Answering Calls

R button (to use the flash feature)

[R] is used to access optional telephone services. Contact your service provider for details.

Note:

- If your unit is connected to a PBX (private branch exchange), pressing **[R]** can allow you to access certain features of your host PBX such as transferring an extension call. Consult your PBX dealer for details.
- You can change the flash time (page 33).

Pause button (for PBX/long distance service users)

A pause is sometimes required when making calls using a PBX or long distance service.

Example: If you have to dial **[0]** before dialling outside numbers manually, you will probably pause after dialling **[0]** until you hear a dial tone.

- 1 Press **[0]**.
- 2 Press **[☉]**.
- 3 Dial the phone number, then press **[↶]** or **[↷]**.

Note:

- Pressing **[☉]** 1 time creates 1 pause. Press **[☉]** repeatedly to create longer pauses. To change pause length, see page 33.

Temporary tone dialling (for rotary or pulse service users)

You can temporarily switch the dialling mode to tone when you need to access touch tone services (e.g., telephone banking services).

- 1 Make a call.
- 2 Press **[✳]** when prompted to enter your code or PIN, then press the appropriate dial keys.

Note:

- The dialling mode will return to pulse when you hang up.

Recording a telephone conversation using the handset (KX-TG1233 only)

You can record your conversation while on an outside call.

Important:

- Before recording a conversation, you should inform the other party that the conversation will be recorded.
- 1 Press **[☒/OK]** during a conversation.
 - 2 Select "Record Call", then press **[▶]**.
 - A beep is heard and recording starts.
 - A beep sounds every 15 seconds and can be heard by the other party, but is not recorded.
 - 3 To stop recording, press **[☒/OK]**.

Note:

- Recorded conversations are treated as new messages.
- To listen to the recorded conversation, see page 41.
- If message memory becomes full, "Memory Full" is displayed and recording stops. Erase unnecessary messages (page 41).
- While recording a conversation, you cannot change the tone quality of the handset.

Making calls using the base unit

- 1 Press **[☒]**.
- 2 Dial the phone number.
 - Speak alternately with the caller.
- 3 When finished talking, press **[☒]**.

Note:

- For best performance, please note the following:

Making/Answering Calls

- Use the speakerphone in a quiet environment.
- While on a call, you can switch from the speakerphone to the handset:
 - If the handset is on the base unit, just lift it up.

To adjust the speaker volume

Press [∧] or [∨] while talking. 8 volume levels are available.

To redial the last number dialed

Press [☎], then press [●].

- If the other party's line is engaged, the unit will redial up to 11 times automatically. While the base unit is waiting to redial, the speakerphone indicator will flash. While the base unit is redialing, mute is automatically turned on.

Note:

- Automatic redial is cancelled when any dialling button (except [●]) is pressed.
- If mute does not turn off after the line is connected, press [☒].

Other features

Mute

You can mute your voice during a conversation. While mute is turned on, you will be able to hear the other party, but the other party will not be able to hear you.

- 1 To mute your voice, press [☒].
 - The speakerphone indicator flashes.
- 2 To return to the conversation, press [☒] again.

R button (to use the flash feature)

[R] is used to access optional telephone services. Contact your service provider for details.

Note:

- If your unit is connected to a PBX (private branch exchange), pressing [R] can allow you to access certain features of your host PBX such as transferring an extension call. Consult your PBX dealer for details.
- You can change the flash time (page 33).

Pause button (for PBX/long distance service users)

A pause is sometimes required when making calls using a PBX or long distance service.

Example: If you have to dial [0] before dialling outside numbers manually, you will probably pause after dialling [0] until you hear a dial tone.

- 1 Press [☎].
- 2 Press [0].
- 3 Press [●].
- 4 Dial the phone number.

Note:

- Pressing [●] 1 time creates 1 pause. Press [●] repeatedly to create longer pauses. To change pause length, see page 33.

Temporary tone dialling (for rotary or pulse service users)

You can temporarily switch the dialling mode to tone when you need to access touch tone services (e.g., telephone banking services).

- 1 Make a call.
- 2 Press [*] when prompted to enter your code or PIN, then press the appropriate dial keys.

Note:

- The dialling mode will return to pulse when you hang up.

Making/Answering Calls

Answering calls using the handset

- 1 Lift the handset and press [📞] or [📞] when the unit rings.
 - You can also answer a call by pressing any dial key from [0] to [9], [*], [#], or [INT]. (Any key answer feature)
- 2 When finished talking, press [📞] or place the handset on the base unit.

Auto talk feature

You can answer calls simply by lifting the handset off the base unit. You do not need to press [📞]. To turn this feature on, see page 29.

To adjust the ringer volume when an outside call comes in

Press [▲] or [▼] when an outside call comes in.

Note:

- The ringer volume cannot be adjusted if the handset is on the base unit.

Answering calls using the base unit

- 1 Press [📞].
- 2 When finished talking, press [📞].

To adjust the ringer volume

Press [▲] or [▼] when a call is received or when the base unit is in standby mode. 4 volume levels (high/medium/low/off) are available. To turn the ringer volume off, press and hold [▼] until the base unit beeps. To turn the ringer volume on again, press [▲].

Note:

- When the ringer volume is turned off, ✖ is displayed on the base unit (KX-TG1233 only).
- When the ringer volume is turned off, the base unit will not ring for outside calls and it will ring at the low level for intercom calls.
- When the message alert feature is on (page 45), the base unit will beep even if the ringer volume is turned off (KX-TG1233 only).

To change ringtones

You can change the ringtone used by the base unit.

KX-TG1223 users:

Press [◀] or [▶] repeatedly to select the desired ringtone.

KX-TG1233 users:

- 1 Press [Λ] or [V] when the base unit is in standby mode.
- 2 Press [◀◀] or [▶▶] repeatedly to select the desired ringtone, then press [▶■].

Handset phonebook

The handset phonebook allows you to make calls without having to dial manually. You can add 200 names and phone numbers to the handset phonebook, assign each handset phonebook entry to the desired category, and search for handset phonebook entries by name or category.

Adding entries to the handset phonebook

- 1 Press [□], then press [≡/OK].
- 2 Select "New Entry", then press [▶].
- 3 Enter the party's name (16 characters max.; see page 52 for character entry), then press [≡/OK].
- 4 Enter the party's phone number (24 digits max.), then press [≡/OK].
- 5 Select the desired category for the entry, then press [▶].
- 6 Select "Save", then press [▶].
- 7 Press [↶⓪].

Note:

- If there is no space to store new entries, "Memory Full" will be displayed. Erase unnecessary entries (page 20).

To edit/correct a mistake

Press [◀] or [▶] to place the cursor on the number or character you wish to erase, then press [C/✕]. Place the cursor to the right of where you want to insert a number or character, then press the appropriate dial key.

Note:

- Press and hold [C/✕] to erase all numbers or characters.

Categories

Categories can help you find entries in the handset phonebook quickly and easily. When adding an entry to the handset phonebook you can assign it to the desired category. You can change the names of categories assigned for handset phonebook entries ("Friends", "Family", etc.) and then search for handset phonebook entries by category. Additional category features are available for Caller ID subscribers (page 36).

Changing category names

- 1 Press [□], then press [≡/OK].
- 2 Select "Category", then press [▶].
- 3 Select the category you want to change the name of, then press [▶].
- 4 Select "Category Name", then press [▶].
- 5 Edit the name (10 characters max.; see page 52 for character entry), then press [≡/OK].
- 6 Press [↶⓪].

Finding and calling a handset phonebook entry

Handset phonebook entries can be searched for by first character, by category, or by scrolling through all handset phonebook entries.

Once you have found the desired entry, press [↶] or [↷] to dial the phone number.

Scrolling through all entries

- 1 Press [□].
- 2 Press [▲] or [▼] repeatedly to display the desired entry.

Searching by first character (index search)

- 1 Press [□], then press [●].

Phonebooks

- 2 Select “**Index Search**”, then press [▶].
- 3 Select the character entry mode that contains the character you are searching for, and press [▶].
- 4 Press the dial key ([0] to [9]) which contains the character you are searching for (page 52).
 - Press the same dial key repeatedly to display the first entry corresponding to each letter located on that dial key.
 - If there is no entry corresponding to the letter you selected, the next entry will be displayed.
- 5 Press [▲] or [▼] repeatedly to scroll through the handset phonebook if necessary.

Searching by category

- 1 Press [□], then press [●].
- 2 Select “**Category Search**”, then press [▶].
- 3 Select the category you want to search, then press [▶].
 - The first entry in that category is displayed.
 - If you select “**All**”, the unit will end the category search.
- 4 Press [▲] or [▼] repeatedly to scroll through the handset phonebook if necessary.

Editing entries in the handset phonebook

Handset phonebook entries can be edited after you have saved them. You can change the name, phone number, and category.

Changing a name, phone number, category

- 1 Find the desired entry (page 19), then press [≡/OK].

- 2 Select “**Edit**”, then press [▶].
- 3 Edit the name if necessary (16 characters max.; see page 52 for character entry), then press [≡/OK].
- 4 Edit the phone number if necessary (24 digits max.), then press [≡/OK].
- 5 Select the desired category, then press [▶].
- 6 Select “**Save**”, then press [▶].
- 7 Press [✕○].

Erasing entries from the handset phonebook

Erasing an entry

- 1 Find the desired entry (page 19), then press [≡/OK].
- 2 Select “**Erase**”, then press [▶].
- 3 Select “**Yes**”, then press [▶].
- 4 Press [✕○].

Erasing all entries

- 1 Press [□], then press [≡/OK].
- 2 Select “**Erase All**”, then press [▶].
- 3 Select “**Yes**”, then press [▶].
- 4 Select “**Yes**” again, then press [▶].
- 5 Press [✕○].

One touch dial

Assigning an entry in the handset phonebook to a one touch dial key

Dial keys [1] to [9] can each be used as a one touch dial key, allowing you to dial a number from the handset phonebook by simply pressing a dial key.

- 1 Find the desired entry (page 19), then press [≡/OK].
- 2 Select “**One Touch Dial**”, then press [▶].

Phonebooks

3 Press [**▲**] or [**▼**] to select the desired dial key number, then press [**▶**].

- When the dial key is already used as a one touch dial key, “*” is displayed next to the dial key number. If you select this dial key, “Overwrite” is displayed. You can overwrite the previous assignment if necessary.
- If you do not wish to overwrite, select “Go Back”.

4 Select “Save”, then press [**▶**].

5 Press [**↶**].

Making a call using a one touch dial key

1 Press and hold the desired one touch dial key ([**1**] to [**9**]).

- You can view other one touch dial assignments by pressing [**▲**] or [**▼**].

2 Press [**↶**] or [**↷**].

Erasing a one touch dial assignment

1 Press and hold the desired one touch dial key ([**1**] to [**9**]).

2 Press [**≡/OK**], then press [**▶**].

3 Select “Yes”, then press [**▶**].

Note:

- Only the one touch dial assignment is erased. The corresponding handset phonebook entry is not erased.

Chain dial

This feature allows you to dial phone numbers in the handset phonebook while you are on a call. This feature can be used, for example, to dial a calling card access number or bank account PIN that you have stored in the handset phonebook, without having to dial manually.

1 While on a call, press [**□□**].

2 Press [**▲**] or [**▼**] repeatedly to select the desired entry.

- To search by first character (index search), see page 19. To search by category, see page 20.

3 Press [**▶**] to dial the number.

Phonebooks

Shared phonebook (KX-TG1233 only)

The shared phonebook allows you to make calls without having to dial manually. Any handset registered to the same base unit can use the shared phonebook. You can add 20 names and phone numbers to the shared phonebook and search for shared phonebook entries by name. If you subscribe to Caller ID service, you can use the shared phonebook's audible call feature (page 36).

Adding entries to the shared phonebook

- 1 Press [□□] 2 times.
- 2 Press [≡/OK].
- 3 Select "New Entry", then press [▶].
- 4 Enter the party's name (16 characters max.; see page 52 for character entry), then press [≡/OK].
- 5 Enter the party's phone number (24 digits max.), then press [≡/OK].
- 6 To record an audible call announcement, select "Start Recording", then press [▶], otherwise select "Skip Recording", press [▶], then go to step 9.
 - Audible call (page 36) is useful for Caller ID subscribers only.
 - If "Memory Full" is displayed, erase any unnecessary answering system messages (page 41).
- 7 When "Recording" is displayed, speak into the microphone.
 - Maximum recording time is 10 seconds.
 - Hold the handset about 20 cm away and speak clearly into the microphone.

- 8 To end recording, select "Stop", then press [▶].
 - The recording is played back.
- 9 Select "Save", then press [▶].
- 10 Press [↶⊙].

Note:

- If "Error" is displayed, record the audible call announcement again.
- If there is no space to store new entries, "Memory Full" will be displayed. Erase unnecessary entries (page 23).

To edit/correct a mistake

Press [◀] or [▶] to place the cursor on the number or character you wish to erase, then press [C/✕]. Place the cursor to the right of where you want to insert a number or character, then press the appropriate dial key.

Note:

- Press and hold [C/✕] to erase all numbers or characters.

Finding and calling a shared phonebook entry

Shared phonebook entries can be searched for by first character or by scrolling through all shared phonebook entries. Once you have found the desired entry, press [↶] or [↷] to dial the phone number.

Scrolling through all entries

- 1 Press [□□] 2 times.
- 2 Press [▲] or [▼] repeatedly to display the desired entry.

Searching by first character (index search)

- 1 Press [□□] 2 times.
- 2 Press [●].

Phonebooks

- 3 Select the character entry mode that contains the character you are searching for, and press [▶].
- 4 Press the dial key ([0] to [9]) which contains the character you are searching for (page 52).
 - Press the same dial key repeatedly to display the first entry corresponding to each letter located on that dial key.
 - If there is no entry corresponding to the letter you selected, the next entry will be displayed.
- 5 Press [▲] or [▼] repeatedly to scroll through the shared phonebook if necessary.

Editing entries in the shared phonebook

Shared phonebook entries can be edited after you have saved them. You can change the name, phone number, and audible call.

Changing a name, phone number, audible call

- 1 Find the desired entry (page 22), then press [≡/OK].
- 2 Select "Edit", then press [▶].
- 3 Edit the name if necessary (16 characters max.; see page 52 for character entry), then press [≡/OK].
- 4 Edit the phone number if necessary (24 digits max.), then press [≡/OK].
- 5 Skip, record, or erase an audible call recording.
 - To record the audible call announcement, continue from step 6, "Adding entries to the shared phonebook", page 22.
 - To skip recording, select "Skip Recording" and press [▶].
 - To erase the audible call announcement, select "Erase" and press [▶].

- 6 Select "Save", then press [▶].
- 7 Press [✕⓪].

Playing back an audible call announcement

- 1 Find the desired entry (page 22), then press [≡/OK].
- 2 Select "Audible Call", then press [▶].
 - The audible call announcement is played back.
- 3 Press [✕⓪].

Erasing entries from the shared phonebook

Erasing an entry

- 1 Find the desired entry (page 22), then press [≡/OK].
- 2 Select "Erase", then press [▶].
- 3 Select "Yes", then press [▶].
- 4 Press [✕⓪].

Erasing all entries

- 1 Press [□] 2 times.
- 2 Press [≡/OK].
- 3 Select "Erase All", then press [▶].
- 4 Select "Yes", then press [▶].
- 5 Select "Yes" again, then press [▶].
- 6 Press [✕⓪].

Phonebooks

Copying phonebook entries

Copying handset phonebook entries to other handset

Handset phonebook entries (page 19) can be copied from the handset to the phonebook of a compatible Panasonic handset.

Copying one entry

- 1 Find the desired handset phonebook entry (page 19), then press **[F3/OK]**.
- 2 Select "copy", then press **[▶]**.
- 3 Enter the handset number you wish to send the handset phonebook entry to.
- 4 To continue copying another entry, select "yes", then press **[▶]**. Find the desired handset phonebook entry, then press **[▶]**.
 - To finish copying, select "no", then press **[▶]**.
- 5 Press **[*0]**.

Copying all entries

- 1 Press **[□]**, then press **[F3/OK]**.
- 2 Select "copy all", then press **[▶]**.
- 3 Enter the handset number you wish to send the handset phonebook entries to.
 - When all entries have been copied, "Completed" is displayed.
- 4 Press **[*0]**.

Note:

- If the other handset (the receiver) is not in standby mode, "Failed" is displayed on your handset (the sender).
- If there was an error while copying phonebook entries, "Incomplete" is displayed on your handset (the sender).

Copying handset phonebook entries to the shared phonebook (KX-TG1233 only)

- 1 Find the desired handset phonebook entry (page 19), then press **[F3/OK]**.
- 2 Select "copy", then press **[▶]**.
- 3 Press **[0]**.
- 4 To continue copying another entry, select "yes", then press **[▶]**. Find the desired entry, then press **[▶]**.
 - To finish copying, select "no", then press **[▶]**.
- 5 Press **[*0]**.

Handset Settings

Guide to handset settings

For your reference, a chart of all items which can be customised for the handset is printed below.

- When customising the handset, the current item or setting is indicated by ►.

| Handset settings menu | Sub-menu | Sub-menu 2 | Default setting | Page |
|-----------------------|-----------------|------------|-----------------|---------|
| Time Settings | Set Date & Time | | — | page 12 |
| | Alarm | | Off | page 26 |
| Ringer Setup | Ringer Volume | | Maximum | page 26 |
| | Ext. Ringtone | | Ringtone 1 | page 26 |
| | Int. Ringtone | | Ringtone 1 | page 26 |
| | Night Mode | Start/End | 23:00/06:00 | page 27 |
| | | On/Off | Off | page 27 |
| | | Ring Delay | 60 sec. | page 27 |
| Select Category | | — | page 28 | |
| Display Setup | Standby Display | | Off | page 28 |
| | Select Language | | English | page 28 |
| | Contrast | | Level 3 | page 29 |
| Call Options | Call Bar | | Off | page 29 |
| | Auto Talk | | Off | page 29 |
| Registration | Register H.set | | — | page 47 |
| Select Base | — | | Auto | page 47 |
| Other Options | Handset PIN | | 0000 | page 29 |
| | Keytones | | On | page 30 |
| | Reset Handset | | — | page 30 |

Note:

- Up to 3 menu items can be displayed at a time. To select a menu item not shown on the current page, scroll up or down by pressing the navigator key, [▲] or [▼], respectively.

Handset Settings

Time settings

Alarm

An alarm will sound for 3 minutes at the set time once or daily. Set the date and time beforehand (page 12).

- 1 Press [≡/OK].
- 2 Select "Handset Setup", then press [▶].
- 3 Select "Time Settings", then press [▶].
- 4 Select "Alarm", then press [▶] 2 times.
- 5 Select an alarm mode, then press [▶].
 - "Once": The alarm will sound once at the set time. Enter the desired day and month by selecting 2 digits for each.
 - "Daily": An alarm will sound daily at the set time.
 - "Off": Turns the alarm off. Press [▶] again, then press [✕] to finish.
- 6 Enter the desired hour and minute by selecting 2 digits for each.
 - You can select "AM", "PM" or 24-hour time entry by pressing [✕] repeatedly.
- 7 Press [≡/OK].
- 8 Select the ringtone that will sound at the set time, then press [▶].
- 9 Select "save", then press [▶].
- 10 Press [✕].

Note:

- To stop the alarm, press any dial key.
- When in talk or intercom mode, the alarm will not sound until the call has ended.
- The alarm will sound at the set time even when the ringer volume is turned off.
- If you select "Once", the setting will change to "Off" after the alarm sounds.

Ringer setup

Ringer volume

- 1 Press [≡/OK].
- 2 Select "Handset Setup", then press [▶].
- 3 Select "Ringer Setup", then press [▶].
- 4 Select "Ringer Volume", then press [▶].
- 5 Press [▲] or [▼] repeatedly to select the desired volume.
- 6 Press [▶].
- 7 Press [✕].

Note:

- Alarms will sound and the handset will ring for intercom calls and when paged even if the ringer is turned off.

Changing ringtones

You can change the ringtone used by the handset.

"Ext. Ringtone": Selects the ringtone for outside calls.

"Int. Ringtone": Selects the ringtone for intercom calls.

- 1 Press [≡/OK].
- 2 Select "Handset Setup", then press [▶].
- 3 Select "Ringer Setup", then press [▶].
- 4 Select the desired item, then press [▶].
- 5 Select the desired ringtone, then press [▶].
- 6 Press [✕].

Note:

- If you select one of the melody ringtones, the ringtone will continue to sound for

Handset Settings

several seconds if the caller hangs up before you answer. You may hear a dial tone or no one on the line when you answer a call.

- The preset melodies in this product are used with permission of © 2004 M-ZoNE Co., Ltd.

Night mode

Night mode allows you to select a block of time during which the handset will not ring for outside calls. This feature is useful for times when you do not want to be disturbed, for example, while sleeping. Night mode can be set independently for the handset and the base unit (page 32).

Using the handset phonebook's category feature (page 19), you can also select categories of callers whose calls will override night mode and ring the handset (Caller ID subscribers only). Set the date and time beforehand (page 12).

Note:

- To avoid disturbances, we recommend turning the call screening feature off (page 45) in addition to turning the night mode feature on (KX-TG1233 only).

Setting the start and end time for night mode

- 1 Press [≡/OK].
- 2 Select "Handset Setup", then press [▶].
- 3 Select "Ringer Setup", then press [▶].
- 4 Select "Night Mode", then press [▶].
- 5 Select "Start/End", then press [▶].
- 6 Enter the desired hour and minute you wish to start this feature by selecting 2 digits for each.

- If you use 12-hour time entry, select "AM" or "PM" by pressing [*] repeatedly before entering the time.

- 7 Enter the desired hour and minute you wish to end this feature by selecting 2 digits for each.

- If you use 12-hour time entry, select "AM" or "PM" by pressing [*] repeatedly before entering the time.

- 8 Press [≡/OK].

- 9 Press [✕○].

Turning night mode on/off

- 1 Press [≡/OK].
- 2 Select "Handset Setup", then press [▶].
- 3 Select "Ringer Setup", then press [▶].
- 4 Select "Night Mode", then press [▶].
- 5 Select "On/Off", then press [▶].
- 6 Select "on" or "off", then press [▶].
- 7 Press [✕○].

Note:

- When the night mode is turned on, "[N]" is displayed.

Setting the ring delay for night mode

This setting allows the handset to ring during night mode if the caller waits long enough. After the selected amount of time passes, the handset will ring. If you select "No Ringing", the handset will not ring during night mode.

- 1 Press [≡/OK].
- 2 Select "Handset Setup", then press [▶].
- 3 Select "Ringer Setup", then press [▶].
- 4 Select "Night Mode", then press [▶].
- 5 Select "Ring Delay", then press [▶].

Handset Settings

- 6 Select the desired setting, then press [▶].
- 7 Press [⏏].

Note:

- When the answering system answers the call, this feature does not work (KX-TG1233 only).

Selecting categories to bypass night mode

- 1 Press [⏏/OK].
- 2 Select "Handset Setup", then press [▶].
- 3 Select "Ringer Setup", then press [▶].
- 4 Select "Night Mode", then press [▶].
- 5 Select "Select Category", then press [▶].
- 6 Press the desired category numbers, then press [⏏/OK].
 - The selected category number will flash.
 - To cancel a selected category number, press the number again. The number will stop flashing.
- 7 Press [⏏].

Note:

- If a call is received from one of the categories set to bypass night mode, the handset will ring.

Display setup

Selecting the standby mode display

"**Base Number**": The current base unit number is displayed.

"**Handset Number**": The current handset number is displayed.

"**off**": Only the current date and time are displayed.

- 1 Press [⏏/OK].
- 2 Select "Handset Setup", then press [▶].
- 3 Select "Display Setup", then press [▶].
- 4 Select "Standby Display", then press [▶].
- 5 Select the desired setting, then press [▶].
- 6 Press [⏏].

Note:

- If "Base Number" is selected and the current base unit number is 2, "-2-" is displayed.
- If "Handset Number" is selected and the current handset number is 2, "[2]" is displayed.

Changing the display language

- 1 Press [⏏/OK].
- 2 Select "Handset Setup", then press [▶].
- 3 Select "Display Setup", then press [▶].
- 4 Select "Select Language", then press [▶].
- 5 Select the desired language, then press [▶].
- 6 Press [⏏].

Note:

- If you select a language you cannot read, press [⏏], [⏏/OK], press [▲] 2 times, press [▶], press [▼] 2 times, press [▶], press [▼], press [▶], select the desired language, then press [▶]. Press [⏏].

Handset Settings

Changing the display contrast

- 1 Press [OK].
- 2 Select "Handset Setup", then press [▶].
- 3 Select "Display Setup", then press [▶].
- 4 Select "Contrast", then press [▶].
- 5 Press [▲] or [▼] repeatedly to select the desired contrast, then press [▶].
- 6 Press [END].

Call options

Turning call bar on/off

This feature prohibits making outside calls with the handset. When call bar is turned on, only intercom calls and calls to emergency numbers (page 33) can be made. Call bar can be set independently for the handset and the base unit (page 34).

- 1 Press [OK].
- 2 Select "Handset Setup", then press [▶].
- 3 Select "Call Options", then press [▶].
- 4 Select "Call Bar", then press [▶].
- 5 Enter "0000" (default handset PIN).
 - If you changed the PIN, enter it (page 29).
- 6 Select "On" or "Off", then press [▶].
- 7 Press [END].

Note:

- When call bar is turned on, ☒ is displayed.

Turning auto talk on/off

When this feature is turned on, you can answer calls simply by lifting the handset off the base unit. You do not need to press [END].

- 1 Press [OK].
- 2 Select "Handset Setup", then press [▶].
- 3 Select "Call Options", then press [▶].
- 4 Select "Auto Talk", then press [▶].
- 5 Select "On" or "Off", then press [▶].
- 6 Press [END].

Other options

Changing the handset PIN (Personal Identification Number)

For security, the handset PIN must be entered when changing certain settings. The default PIN is "0000".

Important:

- If you change the PIN, please make note of your new PIN. The unit will not reveal the PIN to you. If you forget your PIN, consult your nearest Panasonic service centre.

- 1 Press [OK].
- 2 Select "Handset Setup", then press [▶].
- 3 Select "Other Options", then press [▶].
- 4 Select "Handset PIN", then press [▶].
- 5 Enter the current 4-digit handset PIN.
- 6 Enter the new 4-digit handset PIN, then press [OK].
- 7 Press [END].

Handset Settings

Turning keytones on/off

Keytones are tones heard when keys are pressed. Includes confirmation tones and error tones.

- 1 Press [OK].
- 2 Select "Handset Setup", then press [▶].
- 3 Select "Other Options", then press [▶].
- 4 Select "Keytones", then press [▶].
- 5 Select "On" or "Off", then press [▶].
- 6 Press [END].

Note:

- If keytones are turned off, error tones will not sound when you enter the wrong PIN or when memory is full.

Resetting the handset to its default settings

- 1 Press [OK].
- 2 Select "Handset Setup", then press [▶].
- 3 Select "Other Options", then press [▶].
- 4 Select "Reset Handset", then press [▶].
- 5 Enter "0000" (default handset PIN).
 - If you changed the PIN, enter it (page 29).
- 6 Select "Yes", then press [▶].
- 7 Press [END].

Note:

- The following items will be deleted or reset to their default settings:
 - Settings listed on page 25
 - Redial list
 - Voice enhancer
 - Category names

- Category ringtones
- The following items will be retained:
 - Handset phonebook entries (Category names and ringtones will be reset to their default settings.)
 - Date and time

Base Unit Settings

Guide to base unit settings

For your reference, a chart of all items which can be customised for the base unit is printed below.

- These items are customised using the handset.
- When customising the base unit, the current item or setting is indicated by ►.

| Base unit settings menu | Sub-menu | Sub-menu 2 | Default setting | Page |
|-------------------------|---------------|------------|-----------------|---------|
| Ringer Setup | Night Mode | Start/End | 23:00/06:00 | page 32 |
| | | On/Off | Off | page 32 |
| | | Ring Delay | 60 sec. | page 32 |
| Call Options | Dial Mode | | Tone | page 12 |
| | Recall | | 600 msec. | page 33 |
| | Pause Length | | 3 sec. | page 33 |
| | Emergency No. | | — | page 33 |
| | ARS Settings | Area Code | — | page 33 |
| | Call Restrict | | — | page 34 |
| | Call Bar | | Off | page 34 |
| Other Options | Base Unit PIN | | 0000 | page 35 |
| | Repeater Mode | | Off | page 48 |
| | Reset Base | | — | page 35 |

Note:

- Up to 3 menu items can be displayed at a time. To select a menu item not shown on the current page, scroll up or down by pressing the navigator key, [▲] or [▼], respectively.
- To change the base unit ringer volume and the base unit ringtone, see page 18.

Base Unit Settings

Ringer setup

Night mode

Night mode allows you to select a block of time during which the base unit will not ring for outside calls. This feature is useful for times when you do not want to be disturbed, for example, while sleeping. Night mode can be set independently for the handset (page 27) and the base unit.

Set the date and time beforehand (page 12).

Note:

- To avoid disturbances, we recommend turning the call screening feature off (page 45) in addition to turning the night mode feature on (KX-TG1233 only).

Setting the start and end time for night mode

- 1 Press [≡/OK].
- 2 Select "Base Unit Setup", then press [▶].
- 3 Enter "0000" (default base unit PIN).
 - If you changed the PIN, enter it (page 35).
- 4 Select "Ringer Setup", then press [▶].
- 5 Select "Night Mode", then press [▶].
- 6 Select "Start/End", then press [▶].
- 7 Enter the desired hour and minute you wish to start this feature by selecting 2 digits for each.
 - If you use 12-hour time entry, select "AM" or "PM" by pressing [✳] repeatedly before entering the time.
- 8 Enter the desired hour and minute you wish to end this feature by selecting 2 digits for each.
 - If you use 12-hour time entry, select "AM" or "PM" by pressing [✳] repeatedly before entering the time.

9 Press [≡/OK].

10 Press [✳0].

Turning night mode on/off

- 1 Press [≡/OK].
- 2 Select "Base Unit Setup", then press [▶].
- 3 Enter "0000" (default base unit PIN).
 - If you changed the PIN, enter it (page 35).
- 4 Select "Ringer Setup", then press [▶].
- 5 Select "Night Mode", then press [▶].
- 6 Select "On/Off", then press [▶].
- 7 Select "On" or "Off", then press [▶].
- 8 Press [✳0].

Setting the ring delay for night mode

This setting allows the base unit to ring during night mode if the caller waits long enough. After the selected amount of time passes, the base unit will ring. If you select "No Ringing", the base unit will not ring during night mode.

- 1 Press [≡/OK].
- 2 Select "Base Unit Setup", then press [▶].
- 3 Enter "0000" (default base unit PIN).
 - If you changed the PIN, enter it (page 35).
- 4 Select "Ringer Setup", then press [▶].
- 5 Select "Night Mode", then press [▶].
- 6 Select "Ring Delay", then press [▶].
- 7 Select the desired setting, then press [▶].
- 8 Press [✳0].

Note:

- When the answering system answers the call, this feature does not work (KX-TG1233 only).

Base Unit Settings

Call options

Changing the flash time

Change the flash time, if necessary, depending on the requirements of your service provider or PBX.

- 1 Press [OK].
- 2 Select "Base Unit Setup", then press [▶].
- 3 Enter "0000" (default base unit PIN).
 - If you changed the PIN, enter it (page 35).
- 4 Select "Call Options", then press [▶].
- 5 Select "Recall", then press [▶].
- 6 Select the desired setting, then press [▶].
- 7 Press [⏏].

Setting pause length

Change the pause length, if necessary, depending on the requirements of your service provider or PBX.

- 1 Press [OK].
- 2 Select "Base Unit Setup", then press [▶].
- 3 Enter "0000" (default base unit PIN).
 - If you changed the PIN, enter it (page 35).
- 4 Select "Call Options", then press [▶].
- 5 Select "Pause Length", then press [▶].
- 6 Select the desired setting, then press [▶].
- 7 Press [⏏].

Storing/changing emergency numbers

These settings determine which phone numbers can be dialed while the call bar feature is on (page 29).

- 1 Press [OK].
- 2 Select "Base Unit Setup", then press [▶].
- 3 Enter "0000" (default base unit PIN).
 - If you changed the PIN, enter it (page 35).
- 4 Select "Call Options", then press [▶].
- 5 Select "Emergency No.", then press [▶].
- 6 Select a memory location, then press [▶].
 - If the memory location already contains an emergency number, the number is displayed.
- 7 Enter/edit the number, then press [OK].
 - To erase an emergency number, press and hold [C/⏏].
- 8 Press [⏏].

Selecting area codes to be deleted automatically

In some situations, phone numbers stored automatically in the Caller ID list (page 37) will include area codes. If you do not want to dial the area codes when making calls from the Caller ID list, you can store the area codes which you want the unit to delete automatically.

Example: You have stored the area code "123". If you make a call from the Caller ID list to the phone number "123-456-7890", the unit dials "456-7890".

- 1 Press [OK].
- 2 Select "Base Unit Setup", then press [▶].

Base Unit Settings

- 3 Enter "0000" (default base unit PIN).
 - If you changed the PIN, enter it (page 35).
- 4 Select "Call Options", then press [▶].
- 5 Select "ARS Settings", then press [▶].
- 6 Select "Area Code", then press [▶].
- 7 Select an area code location (1 to 4), then press [▶].
 - If the location already contains an area code, the code is displayed.
- 8 Enter an area code (5 digits max.), then press [≡/OK].
- 9 Press [✕].

Setting call restriction

You can restrict the base unit or selected handsets from dialling certain numbers. Up to 6 phone numbers can be stored. Storing area codes here will prevent the restricted extensions (the base unit or selected handsets) from dialling any phone number in that area code.

Important:

- Call restriction can be set using handset 1 only. (To confirm which handset is handset 1, press [📞]) and [1] on the base unit. Handset 1 will ring.)

- 1 Press [≡/OK].
- 2 Select "Base Unit Setup", then press [▶].
- 3 Enter "0000" (default base unit PIN).
 - If you changed the PIN, enter it (page 35).
- 4 Select "Call Options", then press [▶].
- 5 Select "Call Restrict", then press [▶].
 - The base unit extension number "0" and the extension numbers of all registered handsets are displayed.

- 6 Select the extensions which will be restricted by pressing the desired number.
 - Flashing numbers indicate call restriction is turned on for the corresponding extension.
 - To turn call restriction off for an extension, press the dial key corresponding to its extension number. The number will stop flashing.
- 7 Press [≡/OK].
- 8 Select a memory location, then press [▶].
 - If the memory location already contains a restricted number, the number is displayed.
- 9 Enter the phone number or area code to be restricted (8 digits max.), then press [≡/OK].
 - To erase a restricted number, press [C/✕].
- 10 Press [✕].

Turning call bar on/off

This feature prohibits making outside calls with the base unit. When call bar is turned on, only intercom calls and calls to emergency numbers (page 33) can be made. Call bar can be set independently for the handset (page 29) and the base unit.

- 1 Press [≡/OK].
- 2 Select "Base Unit Setup", then press [▶].
- 3 Enter "0000" (default base unit PIN).
 - If you changed the PIN, enter it (page 35).
- 4 Select "Call Options", then press [▶].
- 5 Select "Call Bar", then press [▶].
- 6 Select "On" or "Off", then press [▶].
- 7 Press [✕].

Base Unit Settings

Other options

Changing the base unit PIN (Personal Identification Number)

For security, the base unit PIN must be entered when changing certain settings. The default PIN is "0000".

Important:

- If you change the PIN, please make note of your new PIN. The unit will not reveal the PIN to you. If you forget your PIN, consult your nearest Panasonic service centre.

- 1 Press [MENU/OK].
- 2 Select "Base Unit Setup", then press [▶].
- 3 Enter "0000" (default base unit PIN).
 - If you changed the PIN, enter it.
- 4 Select "Other Options", then press [▶].
- 5 Select "Base Unit PIN", then press [▶].
- 6 Enter the new 4-digit base unit PIN, then press [MENU/OK].
- 7 Press [EXIT].

Resetting the base unit to its default settings

- 1 Press [MENU/OK].
- 2 Select "Base Unit Setup", then press [▶].
- 3 Enter "0000" (default base unit PIN).
 - If you changed the PIN, enter it (page 35).
- 4 Select "Other Options", then press [▶].
- 5 Select "Reset Base", then press [▶].
- 6 Select "Yes", then press [▶].

- 7 Press [EXIT].

Note:

- The following items will be deleted or reset to their default settings:
 - Settings listed on page 31, 44
 - Base unit ringtone
 - Base unit ringer volume (Medium)
 - Caller list
- The following items will be retained:
 - Date and time
 - Shared phonebook entries (KX-TG1233 only)
 - Repeater mode
 - Recordings, including your greeting message, caller messages, voice memos, audible call announcements, and recorded conversations (KX-TG1233 only)

Caller ID Service

Using Caller ID service

Important:

- This unit is Caller ID compatible. To use Caller ID features (such as displaying caller phone numbers), you must subscribe to Caller ID service. Consult your service provider for details.

Caller ID features

When an outside call is received, the caller's phone number can be displayed.

- Phone numbers of the last 50 different callers will be logged in the caller list.
- While listening to a message recorded by the answering system using the handset, you can call back the caller without having to dial the phone number (KX-TG1233 only; page 42).
- When caller information is received and it matches a phone number stored in the unit's phonebook:
 - The stored name will be displayed and logged in the caller list.
 - The handset will use the ringtone assigned to the caller's category.
 - Both the base unit and handset will announce the audible call recording you made (KX-TG1233 only).
- If the unit is connected to a PBX system, you may not receive the caller information.
- When the caller dialed from an area which does not provide Caller ID service, "Out of Area" will be displayed.
- When the caller requested not to send caller information, either no information or "Private Caller" will be displayed.

Missed calls

If a call is not answered, the unit treats the call as a missed call. The number of missed calls is shown on the display. This lets you know if you should view the caller list to see who called while you were out.

Category features for handset phonebook

Categories can help you identify who is calling by using different ringtones for different categories of callers. When adding an entry to the handset phonebook you can assign it to the desired category (page 19). When a call is received from a caller assigned to a category, the category's ringtone you select is used.

Changing category ringtones

You can select a ringtone for each category. If you select "Ext. Ringtone", the unit will use the external ringtone you set on page 26 when calls from this category are received. The default setting is "Ext. Ringtone".

- 1 Press [□], then press [≡/OK].
- 2 Select "Category", then press [▶].
- 3 Select a category, then press [▶].
- 4 Select the current setting of the category ringtone, then press [▶].
- 5 Select the desired ringtone, then press [▶].
- 6 Press [↶⊙].

Audible call for shared phonebook (KX-TG1233 only)

Audible call allows you to know who is calling without looking at the display. If you record an audible call announcement for a shared phonebook entry (page 22), the audible call recording will be announced when you receive a call from that person.

Note:

- Audible call announcements will not be announced from an extension if its ringer volume is turned off.

Caller ID Service

Caller list

Viewing the caller list and calling back

Phone numbers of the last 50 different callers will be logged in the caller list. When the 51st call is received, the oldest caller information will be automatically erased. You can use this list to return missed calls.

- 1 Press [OK].
- 2 Select "Caller List", then press [▶].
 - The most recent call is displayed.
- 3 Press [▼] repeatedly to search from the most recent call, or press [▲] repeatedly to search from the oldest call.
 - If the item has already been viewed or answered, "✓" is displayed, even if it was viewed or answered using another handset.
- 4 Press [↶] or [↷] to call back the displayed party.

Note:

- If you do not want to dial the area codes when making calls from the Caller ID list, you can store the area codes which you want the unit to delete automatically (page 33).

Editing a caller's phone number before calling back

- 1 Press [OK].
- 2 Select "Caller List", then press [▶].
- 3 Press [▲] or [▼] repeatedly to display the desired entry.
- 4 **To add a number**
Press the dial key ([0] to [9]).
 - The number you pressed is added to the top of the current number.

To erase a number

Press [OK], select "Edit and Call", then press [▶].
Press [◀] or [▶] to place the cursor on the number you wish to erase, then press [C/✕].

- 5 Press [↶] or [↷].

Erasing caller information

- 1 Press [OK].
- 2 Select "Caller List", then press [▶].
- 3 Press [▲] or [▼] repeatedly to display the desired entry, then press [OK].
- 4 Select "Erase", then press [▶].
 - To erase all entries, select "Erase All", then press [▶].
- 5 Select "Yes", then press [▶].
- 6 Press [↶].

Storing caller information into the handset phonebook

- 1 Press [OK].
- 2 Select "Caller List", then press [▶].
- 3 Press [▲] or [▼] repeatedly to display the desired entry, then press [OK].
- 4 Select "Add Phonebook", then press [▶].
- 5 Continue from step 3, "Adding entries to the handset phonebook", page 19.

Voice mail service

Voice mail is an automatic answering service offered by your service provider. If you subscribe to this service, your service provider's voice mail system can answer calls for you when you are unavailable to answer the phone or when your line is busy.



Caller ID Service



Messages are recorded by the service provider, not your telephone.

Note:

- For more information on using the unit's answering system and your service provider's voice mail service, see page 45 (KX-TG1233 only).

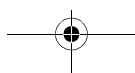
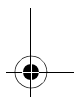
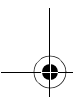
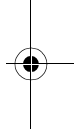
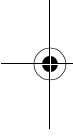

Answering System Features (KX-TG1233 only)

Answering system

The KX-TG1233 unit contains an answering system which can answer and record calls for you when you are unavailable to answer the phone. You can also record your own voice memos (page 42) and phone conversations (page 16).

Important:

- Only 1 person can access the answering system (listen to messages, record a greeting message, etc.) at a time.
- When callers leave messages, the unit records the day and time of each message. Make sure the date and time have been set (page 12).

Memory capacity

The total recording capacity (including your greeting message, caller messages, voice memos, audible call announcements, and recorded conversations) is about 15 minutes. A maximum of 64 messages can be recorded.

Note:

- If message memory becomes full:
 - “Answer Sys. Full” is shown on the handset display
 - the answer on indicator on the base unit flashes rapidly
 - the total number of recorded messages flashes on the base unit display
 Erase unnecessary messages (page 41).
- Messages are retained even if a power failure occurs.

Turning the answering system on/off

Using the base unit

Press [**Answer on**] to turn on/off the answering system.

- When the answering system is turned on, the answer on indicator lights.
- When the answering system is turned off, the answer on indicator turns off and the unit automatically plays new messages, if any.

Using the handset

- 1 Press [**≡/OK**].
- 2 Select “Answer System”, then press [**▶**].
- 3 Select “Answer On” or “Answer Off”, then press [**▶**].
- 4 Press [**⏏**].

Note:

- When the answering system is turned on, **☎** is displayed.

Greeting message

When the unit answers a call, callers are greeted by a greeting message. You can record your own greeting message or use a prerecorded greeting message.

Recording a greeting message

You can record your own greeting message (2 minutes and 30 seconds max.).

Using the base unit

- 1 Press and hold [**☎**] for about 1 second.

Answering System Features (KX-TG1233 only)

- Speak clearly about 20 cm away from the microphone.

- 2 Press [▶/■] to stop recording.
 - The greeting message is played back.

Note:

- If “E” is displayed, record the greeting message again.

Using the handset

- 1 Press [≡/OK].
- 2 Select “Answer System”, then press [▶].
- 3 Select “Record”, then press [▶].
- 4 Select “Record Greeting”, then press [▶].
 - Hold the handset about 20 cm away and speak clearly into the microphone.
- 5 Press [≡/OK] to stop recording.
 - The greeting message is played back.
- 6 Press [✕○].

Note:

- If “Error” is displayed, record the greeting message again.

Using a prerecorded greeting message

If you erase or do not record your own greeting message, the unit can play a prerecorded greeting message for callers and ask them to leave messages. If the message recording time (page 45) is set to “Greeting Only”, caller messages will not be recorded and the unit will play a different prerecorded greeting message asking callers to call again.

Playing back the greeting message

Using the base unit

Press [Ⓜ].

Using the handset

- 1 Press [≡/OK].
- 2 Select “Answer System”, then press [▶].
- 3 Select “Play Greeting”, then press [▶].
- 4 Press [✕○].

Erasing the greeting message

If you erase your own greeting message, the unit will play a prerecorded greeting message for callers.

Using the base unit

Press [Ⓜ], then press [✕] during playback.

Using the handset

- 1 Press [≡/OK].
- 2 Select “Answer System”, then press [▶].
- 3 Select “Erase Message”, then press [▶].
- 4 Select “Erase Greeting”, then press [▶].
- 5 Select “Yes”, then press [▶].
- 6 Press [✕○].

Listening to messages

Messages are stored and played back chronologically, from oldest message to newest.

Answering System Features (KX-TG1233 only)

Listening to new/all messages

When you have new messages:

- the answer on indicator on the base unit flashes
- the total number of new messages is shown on the handset display
- the base unit beeps about once a minute if the message alert feature (page 45) has been turned on

Note:

- The base unit display will show the total number of recorded messages.

Using the base unit

Press [▶/■].

- If new messages have been recorded, the base unit plays back new messages.
- If there are no new messages, the base unit plays back all messages.

Note:

- To adjust the speaker volume during playback, press [∧] or [∨] repeatedly. 9 volume levels are available.
- After playing back all of the new messages, the answer on indicator will stop flashing but will remain lit up when the answering system is turned on.

Using the handset

- 1 Press [≡/OK].
- 2 Select "Answer System", then press [▶].
- 3 Select "Play New Msg." or "Play All Msg.", then press [▶].

Note:

- To adjust the speaker volume during playback, press [▲] or [▼] repeatedly.
- While listening to messages, you can switch between the receiver and speaker by pressing [↶] or [↷].

Repeating, skipping, stopping, erasing a message during playback

- To repeat a message during playback:

- for the base unit, press [◀◀]
- for the handset, press [◀]

If pressed within the first 5 seconds of a message, the previous message will be played.

- To skip a message during playback:

- for the base unit, press [▶▶]
- for the handset, press [▶]

- To stop a message during playback:

- for the base unit, press [▶/■]
- for the handset, press [9]

- To erase a message during playback:

- for the base unit, press [X]
- for the handset, press [✳], [4]

Erasing all messages

Using the base unit

Press [X] 2 times.

Note:

- The greeting message is not erased.

Using the handset

- 1 Press [≡/OK].
- 2 Select "Answer System", then press [▶].
- 3 Select "Erase Message", then press [▶].
- 4 Select "Erase All", then press [▶].
- 5 Select "Yes", then press [▶].
- 6 Press [✳].

Note:

- The greeting message is not erased.

Answering System Features (KX-TG1233 only)

Calling back using the handset (Caller ID subscribers only)

If caller information was received for the call, you can call the caller back while listening to a message.

- 1 Press **[M/OK]** during playback.
- 2 Select **“Call Back”**, then press **[▶]**.

Note:

- To edit the number before calling back, select **“Edit and Call”**, press **[▶]**, edit the number, then press **[↶]** or **[↷]**.

Recording a voice memo using the handset

To leave a private message for yourself or someone else, you can record up to 3 minutes of voice memo. This memo can be played back later, either directly or remotely.

- 1 Press **[M/OK]**.
- 2 Select **“Answer System”**, then press **[▶]**.
- 3 Select **“Record”**, then press **[▶]**.
- 4 Select **“Record Memo”**, then press **[▶]**.
 - Hold the handset about 20 cm away and speak clearly into the microphone.
- 5 Press **[M/OK]** to stop recording.
- 6 Press **[*][0]**.

Note:

- Voice memos are treated as new messages.
- If **“Error”** is displayed, record the voice memo again.

Direct command operation using the handset

You can operate the answering system by pressing dial keys, rather than navigating through the menus. To use the following commands, press **[M/OK]**, select **“Answer System”**, then press **[▶]**.

| Key | Direct commands |
|---------------|--|
| [1] | Repeat message (during playback) ^{*1} |
| [2] | Skip message (during playback) |
| [3] | Enter the “Settings” menu |
| [4] | Play new messages |
| [5] | Play all messages |
| [6] | Play greeting message |
| [7][4] | Record memo message |
| [7][6] | Record greeting message |
| [8] | Turn answering system on |
| [9] | Stop (recording, playback) |
| [0] | Turn answering system off |
| [*][4] | Erase this message (during playback) |
| [*][5] | Erase all messages |
| [*][6] | Erase greeting message |

*1 If pressed within the first 5 seconds of a message, the previous message will be played.

Answering System Features (KX-TG1233 only)

Remote operation

Using a touch tone phone, you can call your phone number from outside and access the unit to listen to messages or change answering system settings. The unit's voice guidance will prompt you to press certain dial keys to perform different operations.

Important:

- In order to operate the answering system remotely, you must first turn on remote operation by setting a remote access code. This code must be entered each time you operate the answering system remotely.

Turning remote operation on/off

A 3-digit remote access code must be entered when operating the answering system remotely. This code prevents unauthorised parties from listening to your messages remotely. After you store your remote access code, remote operation is possible.

- 1 Press [OK].
- 2 Select "Answer System", then press [▶].
- 3 Select "Settings", then press [▶].
- 4 Select "Remote Code", then press [▶].
- 5 To turn on remote operation, enter a 3-digit remote access code.
 - To turn off remote operation, press [*].
- 6 Press [OK].
- 7 Press [ⓧ].

Note:

- If you have stored the remote access code, you can turn on answering system by calling the unit even when it is turned off. This call may be answered before the ring delay feature of the night mode (page

27, 32) activates. You need to select "30 sec." for activating the ring delay feature.

Using the answering system remotely

- 1 Dial your phone number from a touch tone phone.
 - If the number of rings is set to "Auto", (page 44), the number of rings you hear will indicate whether or not you have new messages.
- 2 After the greeting message starts, enter your remote access code.
 - The unit will announce the number of new messages.
 - After 3 seconds, voice guidance starts.
- 3 Follow the voice guidance prompts as necessary.

Note:

- You can hang up at any time.
- You can ignore the voice guidance and control the unit using remote commands (page 44).

Voice guidance

During remote operation, the unit's voice guidance will prompt you to press [1] to perform a specific operation, or press [2] to listen to more available operations.

Operations are presented by voice guidance in the following order:

- Play back all messages
- Play back new messages
- Record a message
- Erase all messages
- Record your greeting message

Note:

- If less than 5 minutes of recording time is available, the unit will announce the remaining recording time after the last message is played back.

Answering System Features (KX-TG1233 only)

- If message memory is full, erase unnecessary messages (page 44).

Remote commands

You can press dial keys to access certain answering system functions without waiting for the voice guidance to prompt you.

| Key | Remote command |
|--------|---|
| [1] | Repeat message (during playback) ^{*1} |
| [2] | Skip message (during playback) |
| [4] | Play new messages |
| [5] | Play all messages |
| [6] | Play greeting message |
| [7] | Record greeting message |
| [9] | Stop (recording, playback) |
| [0] | Turn answering system off |
| [*][4] | Erase this message (during playback) |
| [*][5] | Erase all messages |
| [*][6] | Erase greeting message (during greeting message playback) |
| [*][#] | End remote operation (or hang up) |

*1 If pressed within the first 5 seconds of a message, the previous message will be played.

Turning on the answering system remotely

If the answering system is off, you can turn it on remotely.

- 1 Dial your phone number from a touch tone phone.
- 2 Let the phone ring 20 times.
 - A long beep will be heard.
- 3 Enter your remote access code within 10 seconds after the long beep.

- The greeting message is played back.
- You can hang up, or enter your remote access code again and begin remote operation.

Guide to answering system settings

If the base unit is reset to its default settings (page 35), the following answering system-related settings will be reset.

| Answering system setting | Default setting | Page |
|--------------------------|------------------|---------|
| Answering system on/off | Answer On | page 39 |
| Remote access code | — | page 43 |
| Number of rings | 4 Rings | page 44 |
| Caller's recording time | 3 Minutes | page 45 |
| Call screening | On | page 45 |
| Message alert | Off | page 45 |

Changing the number of rings

You can change the number of times the phone rings before the unit answers calls. You can select 2 to 7 rings, or "Auto".

"Auto": The unit answers after 2 rings when new messages have been recorded, and after 5 rings when there are no new messages. If you call your phone from outside to listen to new messages (page 43), you will know that there are no messages when the phone rings for the 3rd time. You can then hang up without being charged for the call.

- 1 Press [M/OK].

Answering System Features (KX-TG1233 only)

- 2 Select "Answer System", then press [▶].
- 3 Select "Settings", then press [▶].
- 4 Select "Number of Rings", then press [▶].
- 5 Select the desired setting, then press [▶].
- 6 Press [⏏].

For voice mail service subscribers

Please note the following:

- To receive messages correctly with your voice mail service, we recommend that you do not use the unit's answering system. Make sure that the answering system is turned off (page 39).
- If you would rather use the unit's answering system rather than the voice mail service provided by your service provider, ask your service provider to deactivate your voice mail service. If your service provider cannot do this, set this unit's "Number of Rings" setting so that this unit's answering system answers calls before the service provider's voice mail service tries to answer your calls. It is necessary to check the number of rings required to activate the voice mail service provided by your service provider before changing this setting.

Selecting the caller's recording time

You can change the maximum message recording time allotted to each caller, or set the unit to greet callers but not record messages.

- 1 Press [⏏/OK].
- 2 Select "Answer System", then press [▶].
- 3 Select "Settings", then press [▶].

- 4 Select "Recording Time", then press [▶].
- 5 Select the desired setting, then press [▶].
- 6 Press [⏏].

Note:

- When the message recording time is set to "Greeting Only", "⏏" and "--" are displayed on the base unit.

Turning call screening on/off

While a caller is leaving a message, you can screen the call through the speaker of the base unit and the handset.

- 1 Press [⏏/OK].
- 2 Select "Answer System", then press [▶].
- 3 Select "Settings", then press [▶].
- 4 Select "Call Screening", then press [▶].
- 5 Select "On" or "Off", then press [▶].
- 6 Press [⏏].

Turning message alert on/off

This feature alerts you when new messages have been recorded. The base unit beeps about once a minute until you have listened to all new messages.

- 1 Press [⏏/OK].
- 2 Select "Answer System", then press [▶].
- 3 Select "Settings", then press [▶].
- 4 Select "New Msg. Alert", then press [▶].
- 5 Select "On" or "Off", then press [▶].
- 6 Press [⏏].

Note:

- If the base unit is in night mode, the base unit will not beep when new messages are recorded.

Multi-unit Operation

Operating additional units

Additional handsets

Up to 6 handsets can be registered to a single base unit. Additional handsets will give you the freedom to, for example, have an intercom call with another handset while a third handset is on an outside call. See page 5 for information on ordering additional handsets.

Important:

- The additional handset model recommended for use with this unit is noted on page 5. If other model handset is used, certain operations (handset settings, base unit settings, etc.) may not be available.

Additional base units

Handsets can be registered to up to 4 base units, allowing you to add additional base units and extend the area in which your handset(s) can be used. If a handset moves out of range of its base unit when "Auto" is selected on base unit selection (page 47), it will look for another base unit to make or receive calls. A base unit and the handsets it communicates with is called a "radio cell".

Note:

- Calls will be disconnected when the handset moves from one radio cell to another.
- Intercom calls and call transfers are only possible between handsets in the same radio cell.

Registering a handset to a base unit

To register an additional handset to a base unit (easy registration)

The included handset and base unit are preregistered. After purchasing an additional handset, register it to the base unit. Ensure that the additional handset is switched on. If it is not on, press and hold **[*0]** for few seconds to turn the handset on.

- 1 Lift the additional handset and press **[*0]** to put the handset in standby mode.
- 2 Press and hold **[*0]** on the base unit for about 3 seconds, until the registration tone sounds.
- 3 Place the additional handset on the base unit. The registration tone continues to sound. With the handset still on the base unit, wait until a confirmation tone sounds and **Y** stops flashing.

Note:

- If an error tone sounds, or if **Y** is still flashing, register the handset manually (manual registration; page 47).
- Charge the batteries of your additional handset for about 7 hours before initial use.
- This registration method cannot be used for handsets that have already been registered to a base unit. Register the handset manually (manual registration; page 47).

Multi-unit Operation

To register a handset to an additional base unit (manual registration)

You can register a handset to a base unit manually using the following method.

- 1 Press [≡/OK].
- 2 Select "Handset Setup", then press [▶].
- 3 Select "Registration", then press [▶] 2 times.
- 4 Select a base unit number, then press [▶].
 - This number is used by the handset as a reference only.
- 5 Press and hold [••] on the base unit for about 3 seconds, until the registration tone sounds.
 - After pressing [••], the rest of this procedure must be completed within 1 minute.
- 6 Wait until "Enter Base PIN" is displayed, then enter "0000" (default base unit PIN), then press [≡/OK].
 - If you changed the PIN, enter it (page 35).
 - When the handset has been registered successfully, ♯ will stop flashing. If keytones are turned on (page 30), a confirmation tone will be heard.

Selecting a base unit

When "Auto" is selected, the handset will automatically use any available base unit it is registered to. When a specific base unit is selected, the handset will make and receive calls using that base unit only. If the handset is out of range of that base unit, no calls can be made.

- 1 Press [≡/OK].
- 2 Select "Handset Setup", then press [▶].

- 3 Select "Select Base", then press [▶].
- 4 Select the desired base unit number, or "Auto", then press [▶].
 - The handset starts searching for the base unit.

Cancelling a handset

A maximum of 6 handsets can be registered to a base unit. A handset can cancel its own registration (or the registration of another handset) that is stored in the base unit. This will allow the base unit to "forget" the handset.

- 1 Press [≡/OK].
- 2 Select "Base Unit Setup", then press [▶].
- 3 Enter "0000" (default base unit PIN).
 - If you changed the PIN, enter it (page 35).
- 4 Enter "335".
- 5 Select "Cancel Handset", then press [▶].
 - The numbers of all handsets registered to the base unit are displayed.
- 6 Select the handset(s) you want to cancel, by pressing the desired handset number.
 - The selected handset number(s) will flash.
 - To cancel a selected handset number, press the number again. The number will stop flashing.
- 7 Press [≡/OK].
- 8 Select "Yes", then press [▶].
- 9 Press [✕⊙].

Multi-unit Operation

Canceling a base unit

A handset can be registered to a maximum of 4 base units. A handset can cancel a base unit that it is registered to. This allows the handset to "forget" the base unit.

- 1 Press [OK].
- 2 Select "Handset Setup", then press [▶].
- 3 Select "Registration", then press [▶].
- 4 Enter "335".
- 5 Select "Cancel Base", then press [▶].
- 6 Enter "0000" (default handset PIN).
 - If you changed the PIN, enter it (page 29).
- 7 Select the base unit(s) you want to cancel, by pressing the desired base unit number.
 - The selected base unit number(s) will flash.
 - To cancel a selected base unit number, press the number again. The number will stop flashing.
- 8 Press [OK].
- 9 Select "Yes", then press [▶].
- 10 Press [END].

Note:

- To register the handset to another base unit or to the same base unit again, see manual registration (page 47).

Increasing the range of the base unit

You can increase the range of the base unit by using a DECT repeater. Please use only the Panasonic DECT repeater noted on page 5. Consult your Panasonic dealer for details.

Important:

- Before registering the repeater to this base unit, you must turn the repeater mode on.

Turning the repeater mode on/off

- 1 Press [OK].
- 2 Select "Base Unit Setup", then press [▶].
- 3 Enter "0000" (default base unit PIN).
 - If you changed the PIN, enter it (page 35).
- 4 Select "Other Options", then press [▶].
- 5 Select "Repeater Mode", then press [▶].
- 6 Select "On" or "Off", then press [▶].
- 7 Press [END].

Note:

- After turning repeater mode on or off:
 - Certain icons displayed on the base unit will disappear for a moment (KX-TG1233 only).
 - ♯ will flash on the handset momentarily. This is normal. The handset can be used once ♯ stops flashing.
- While the repeater mode is turned on, audible call announcements may not be heard from the handset speaker (KX-TG1233 only).

Intercom

Intercom calls can be made between handsets/base unit in the same radio cell.

Multi-unit Operation

Between a handset and the base unit

When a handset calls the base unit

- 1 Handset:**
Press **[INT]** and **[0]**.
 - The base unit will ring.
- 2 Base unit:**
Press **[↵]** to answer.
- 3 Handset:**
When finished talking, press **[↵]**.
Base unit:
When finished talking, press **[↵]**.

When the base unit calls a handset

- 1 Base unit:**
Press **[📞]** and the desired handset number.
 - The handset will ring.
 - To page all handsets, press **[📞]** and **[0]**. You can talk with the handset user who answers first. **(Paging)**
 - To stop paging, press **[📞]** again.
- 2 Handset:**
Press **[↵]** or **[↵]** to answer.
- 3 Base unit:**
When finished talking, press **[↵]**.
Handset:
When finished talking, press **[↵]**.

Between handsets

Example: When handset 1 calls handset 2

- 1 Handset 1:**
Press **[INT]** and **[2]** (desired handset number).
 - The handset 2 will ring.
- 2 Handset 2:**
Press **[↵]** or **[↵]** to answer.
- 3** When finished talking, press **[↵]**.

Transferring calls, conference calls

Outside calls can be transferred to the base unit or to a handset in the same radio cell. 2 people in the same radio cell can have a conference call with an outside party.

From a handset to the base unit

When a handset transfers a call to the base unit

- 1 Handset:**
During an outside call, press **[INT]** and **[0]** to page the base unit.
 - The outside call will be put on hold.
 - If there is no answer, press **[INT]** to return to the outside call.
- 2 Base unit:**
Press **[↵]** to answer the page.
 - The base unit user can talk with a handset user.
- 3 Handset:**
To complete the call transfer, press **[↵]**.
To establish a conference call, press **[3]**.

Transferring a call without speaking to the base unit user

- 1** During an outside call, press **[INT]** and **[0]** to page the base unit.
 - 📞 flashes on the handset display to indicate the outside call is on hold.
- 2** Press **[↵]**.
 - The outside call rings at the base unit.

Note:

- If the base unit user does not answer the call within 1 minute, the call will ring at your handset again.

Multi-unit Operation

From the base unit to a handset

When the base unit transfers a call to a handset

1 Base unit:

During an outside call, press **[Ⓜ]** and the desired handset number to page the handset.

- The outside call will be put on hold.
- If there is no answer, press **[Ⓜ]** to return to the outside call.

2 Handset:

Press **[☞]** or **[☜]** to answer the page.

3 Base unit:

To complete the call transfer, press **[☜]**.
To establish a conference call, press **[3]**.

Transferring a call without speaking to the handset user

1 During an outside call, press **[Ⓜ]**, then press the desired handset number.

- The in use indicator flashes to indicate the outside call is on hold.

2 Press **[☜]**.

- The outside call rings at the handset.

Note:

- If the handset user does not answer the call within 1 minute, the call will ring at the base unit again.

Between handsets

Example: When handset 1 transfers a call to handset 2

1 Handset 1:

During an outside call, press **[INT]** and **[2]** (desired handset number).

- The outside call will be put on hold.
- If there is no answer, press **[INT]** to return to the outside call.

2 Handset 2:

Press **[☞]** or **[☜]** to answer the page.

- Handset 2 can talk with handset 1.

3 Handset 1:

To complete the call transfer, press **[☞]**.

To establish a conference call, press **[3]**.

Transferring a call without speaking to the other handset user

1 During an outside call, press **[INT]**, then press the desired handset number.

- **[☞]** flashes to indicate the outside call is on hold.

2 Press **[☞]**.

- The outside call rings at the other handset.

Note:

- If the other handset user does not answer the call within 1 minute, the call will ring at your handset again.

Useful Information

Wall mounting

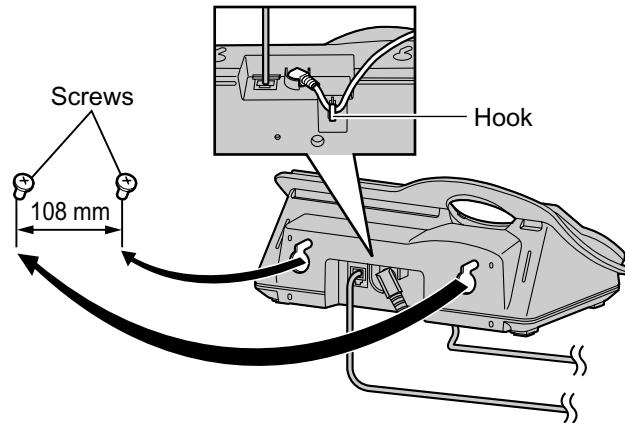

Note:

- Make sure the screws are securely fastened to the wall.
- Do not pinch the telephone line cord and AC adaptor cord between the base unit and the wall.
- Use the following wall template to position the screws before drilling.

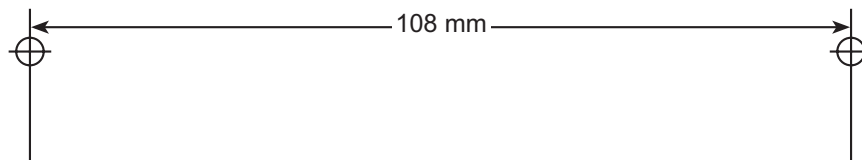

Useful Information

Available character entries

The dial keys are used to enter characters and numbers. Each dial key has multiple characters assigned to it. The available character entry modes are, Alphabet, Numeric, Greek, Extended 1, Extended 2, and Cyrillic. When in Alphabet (ABC), Greek (ABΓ), Extended 1 (AÄÄ), Extended 2 (SŠŠ), or Cyrillic (AБB) character entry modes, you can select which character is entered by pressing a dial key repeatedly.

- When the unit displays the character entry screen:
 - Press [◀] or [▶] to move the cursor.
 - Press dial keys to enter characters and numbers.
 - Press [C/⊗] to erase the character or number highlighted by the cursor. Press and hold [C/⊗] to erase all characters or numbers.
 - Press [✱] to switch between uppercase and lowercase.
 - To enter another character located on the same dial key, press [▶] to move the cursor to the next space, then press the appropriate dial key.

Character entry modes

Several character entry modes are available. When the unit displays the character entry screen, press [□□], then select a character entry mode, and press [▶]. The default mode is Alphabet.

Alphabet character table (ABC)

| 0 | 1 | ABC 2 | DEF 3 | GHI 4 | JKL 5 | MNO 6 | PQRS 7 | TUV 8 | WXYZ 9 |
|------------|-----------------------------------|--------------------------|--------------------------|--------------------------|--------------------------|--------------------------|------------------------------|--------------------------|------------------------------|
| Space 0 | Space # & ' () * , - . / 1 | A B C 2 a b c 2 | D E F 3 d e f 3 | G H I 4 g h i 4 | J K L 5 j k l 5 | M N O 6 m n o 6 | P Q R S 7 p q r s 7 | T U V 8 t u v 8 | W X Y Z 9 w x y z 9 |

Numeric entry table (0-9)

| 0 | 1 | ABC 2 | DEF 3 | GHI 4 | JKL 5 | MNO 6 | PQRS 7 | TUV 8 | WXYZ 9 |
|---|---|-------|-------|-------|-------|-------|--------|-------|--------|
| 0 | 1 | 2 | 3 | 4 | 5 | 6 | 7 | 8 | 9 |

Greek character table (ABΓ)

| 0 | 1 | ABC 2 | DEF 3 | GHI 4 | JKL 5 | MNO 6 | PQRS 7 | TUV 8 | WXYZ 9 |
|------------|-----------------------------------|--------------------------|--------------------------|--------------------------|--------------------------|--------------------------|--------------------------|----------------------------|--------------|
| Space 0 | Space # & ' () * , - . / 1 | A B Γ 2 Δ E Z 3 | Δ E Z 3 H Θ I 4 | H Θ I 4 K Λ M 5 | K Λ M 5 N Ξ O 6 | N Ξ O 6 Π P Σ 7 | Π P Σ 7 T Y Φ 8 | T Y Φ 8 X Ψ Ω Ξ 9 | X Ψ Ω Ξ 9 |

Useful Information

Extended 1 character table (AÄÅ)

| 0 | 1 | ABC 2 | DEF 3 | GHI 4 | JKL 5 | MNO 6 | PQRS 7 | TUV 8 | WXYZ 9 |
|------------|-----------------------------------|----------------------------------|-------------------------|-------------------------|------------|--------------------------------|----------------|-------------------------|------------------|
| Space 0 | Space # & ' () * , - . / 1 | A Ä Å Â Ã Ä Å Æ B C Ç 2 | D E È É Ê Ë Ë F 3 | G Ğ H I Ì Í Î Ï 4 | J K L 5 | M N Ñ O Ò Ó Ô Õ Ö ø 6 | P Q R S Ş 7 | T U Ù Ú Û Ü Û V 8 | W Ŵ X Y ŷ Z 9 |
| | | a à á â ã ä å æ b c ç 2 | d e è é ê ë ë f 3 | g ğ h i ì í î ï 4 | j k l 5 | m n ñ o ò ó ô õ ö ø 6 | p q r s ş 7 | t u ù ú û ü û v 8 | w ŵ x y ŷ z 9 |

- The following are used for both uppercase and lowercase:

ø Ş Ŵ ŷ

Extended 2 character table (SŠŠ)

| 0 | 1 | ABC 2 | DEF 3 | GHI 4 | JKL 5 | MNO 6 | PQRS 7 | TUV 8 | WXYZ 9 |
|------------|-----------------------------------|-------------------------|-----------------------|--------------|---------------------|-------------------------|-------------------------|-------------------------|---------------------------|
| Space 0 | Space # & ' () * , - . / 1 | A Á Ä Å B C Č Ć 2 | D Ď E É Ě ě F 3 | G H I Í 4 | J K L Ł Ł Ł 5 | M N Ń Ń O Ó Ö Ő 6 | P Q R Ŕ Ŕ S Š Š 7 | T Ť U Ú Ů ů ů V 8 | W X Y ŷ Ý Z Ž Ž Ž 9 |
| | | a á ä Å b c Č Ć 2 | d ě e é ě ě f 3 | g h i í 4 | j k l ł Ł Ł 5 | m n Ń ň o ó ö ő 6 | p q r ŕ ř s š š 7 | t ŧ u ú ű ů ű v 8 | w x y ŷ ý z ž ž ž 9 |

- The following are used for both uppercase and lowercase:

Å Ć Č Ě Ł Ł Ł Ń Ŕ Š Š ů ŷ Ž Ž Ž

Cyrillic character table (АБВ)

| 0 | 1 | ABC 2 | DEF 3 | GHI 4 | JKL 5 | MNO 6 | PQRS 7 | TUV 8 | WXYZ 9 |
|-------------------------|-----------------------------------|--------------|--------------|--------------|--------------|--------------|--------------|--------------|--------------|
| Space 0 Г Є І Ï Ÿ | Space # & ' () * , - . / 1 | А Б В Г 2 | Д Е Ж З 3 | И Й К Л 4 | М Н О П 5 | Р С Т У 6 | Ф Х Ц Ч 7 | Ш Щ Ъ Ы 8 | Ь Э Ю Я 9 |

Useful Information

Troubleshooting

If you still have difficulties after following the instructions in this section, disconnect the AC adaptor and turn off the handset, then reconnect the AC adaptor and turn on the handset.

Initial settings

| Problem | Cause & solution |
|--------------------------------------|--|
| <p>⚡ is flashing.</p> | <ul style="list-style-type: none"> ● The handset is not registered to the base unit. Register it (page 46). ● The handset is too far from the base unit. Move closer. ● The AC adaptor is not connected. Check the connections. ● You are using the handset or base unit in an area with high electrical interference. Locate the handset and base unit away from interference sources, such as antenna and mobile phones. |
| <p>The handset display is blank.</p> | <ul style="list-style-type: none"> ● The handset is not turned on. Turn the power on (page 12). |
| <p>The handset will not turn on.</p> | <ul style="list-style-type: none"> ● Make sure that the batteries are installed correctly (page 10). ● Fully charge the batteries (page 10). ● Clean the charge contact and charge again (page 10). |

Useful Information

Telephone

| Problem | Cause & solution |
|---|--|
| I cannot make or receive calls. | <ul style="list-style-type: none"> ● The AC adaptor or telephone line cord is not connected. Check the connections. ● If you are using a splitter to connect the unit, remove the splitter and connect the unit to the wall socket directly. If the unit operates properly, check the splitter. ● Disconnect the base unit from the telephone line and connect the line to a known working telephone. If the working telephone operates properly, contact our service personnel to have the unit repaired. If the working telephone does not operate properly, contact your service provider. ● The dialling mode setting is incorrect. Set to “Tone” or “Pulse” as needed (page 12). ● The call bar feature is turned on. Turn it off (page 29, 34). ● You dialled a call restricted number (page 34). ● The key lock feature is turned on. Turn it off (page 15). |
| The unit does not ring. | <ul style="list-style-type: none"> ● The ringer volume is turned off. Adjust the handset ringer volume (page 26) and the base unit ringer volume (page 18). ● The night mode feature is turned on. Turn it off (page 27, 32). |
| The batteries should be charging but the battery icon does not change. | <ul style="list-style-type: none"> ● Clean the charge contact and charge again (page 10). ● The AC adaptor is disconnected. Plug in the AC adaptor. |
| A busy tone is heard when  is pressed. | <ul style="list-style-type: none"> ● The handset is too far from the base unit. Move closer and try again. ● Another handset or the base unit is on an outside call. Wait for the other user to complete the call. |
| No sound is heard when making a call with the base unit. | <ul style="list-style-type: none"> ● If you make a call with the base unit while the ARS feature is turned on, no sound will be heard until the base unit determines which carrier should be used for the call. |

Useful Information

| Problem | Cause & solution |
|--|--|
| Static is heard, sound cuts in and out. Interference from other electrical units. | <ul style="list-style-type: none"> • Locate the handset and the base unit away from other electrical appliances. • Move closer to the base unit. • Your unit is connected to a telephone line with DSL service. We recommend connecting a filter (contact your DSL service provider) to the telephone line between the base unit and the telephone line jack. |
| Noise is heard during a call. | <ul style="list-style-type: none"> • You are using the handset or base unit in an area with high electrical interference. Locate the handset and base unit away from interference sources, such as antenna and mobile phones. |
| The handset/base unit stops working while being used. | <ul style="list-style-type: none"> • Disconnect the AC adaptor and turn off the handset. Connect the AC adaptor, turn on the handset and try again. |
| While storing an entry in the phonebook or assigning a one touch dial, the handset starts to ring. | <ul style="list-style-type: none"> • A call is being received. To answer the call, press [↶]. Programming will be cancelled. Start again. |
| Pressing [☎] does not display/dial the last number dialled. | <ul style="list-style-type: none"> • The redialled number was more than 24 digits long. Redial the number manually. |
| The handset beeps intermittently and/or [🔋] flashes. | <ul style="list-style-type: none"> • Fully charge the batteries (page 10). |
| I fully charged the batteries, but [🔋] still flashes. | <ul style="list-style-type: none"> • Clean the charge contact and charge again (page 10). • It is time to replace the batteries (page 11). |
| Caller information is not displayed. | <ul style="list-style-type: none"> • You must subscribe to Caller ID service. • Consult your service provider. • Your unit is connected to a telephone line with DSL service. We recommend connecting a filter (contact your DSL service provider) to the telephone line between the base unit and the telephone line jack. |
| While viewing caller information, the display returns to standby mode. | <ul style="list-style-type: none"> • Do not pause for over 1 minute while searching. |
| I cannot set call restriction. | <ul style="list-style-type: none"> • Call restriction can be set using handset 1 only. If you have multiple handsets, you can confirm which handset is handset 1 by pressing [📞] and [1] on the base unit. Handset 1 will start ringing. |

Useful Information

| Problem | Cause & solution |
|---|---|
| I cannot register a handset to a base unit. | <ul style="list-style-type: none"> ● The maximum number of base units (4) are already registered to the handset. Cancel unused base unit registrations from the handset (page 48). ● The maximum number of handsets (6) are already registered to the base unit. Cancel unused handset registrations from the base unit (page 47). ● You entered the wrong PIN number. If you forget your PIN, consult your nearest Panasonic service centre. ● Locate the handset and the base unit away from other electrical appliances. |

Answering system (KX-TG1233 only)

| Problem | Cause & solution |
|--|--|
| The other party complains that they cannot leave a message. | <ul style="list-style-type: none"> ● The recording time is set to "Greeting Only". Select "1 Minute" or "3 Minutes" (page 45). ● Message memory is full. Erase unnecessary messages (page 41). |
| I cannot operate the answering system. | <ul style="list-style-type: none"> ● Another handset or the base unit user is using the answering system, accessing the caller list or changing base unit settings. Wait for the other user to finish. ● A caller is leaving a message. Wait for the caller to finish. ● The handset is too far from the base unit. Move closer. |
| I cannot operate the answering system remotely. | <ul style="list-style-type: none"> ● You are entering the wrong remote access code. Confirm that the correct remote code is entered. If you forget the remote access code, store a new remote access code again (page 43). ● You are pressing the dial keys too quickly. Press each key firmly. ● The answering system is turned off. Turn it on (page 44). ● You are using a pulse telephone. Try again using a touch tone phone. |
| While recording a greeting message or listening to messages, the unit rings and recording stops. | <ul style="list-style-type: none"> ● A call is being received. Answer the call and try again later. |

Useful Information

Specifications

■ **Standard:**

DECT (Digital Enhanced Cordless Telecommunications),
GAP (Generic Access Profile)

■ **Number of channels:**

120 Duplex Channels

■ **Frequency range:**

1.88 GHz to 1.9 GHz

■ **Duplex procedure:**

TDMA (Time Division Multiple Access)

■ **Channel spacing:**

1,728 kHz

■ **Bit rate:**

1,152 kbit/s

■ **Modulation:**

GFSK (Gaussian Frequency Shift Keying)

■ **RF transmission power:**

Approx. 250 mW

■ **Voice coding (KX-TG1233 only):**

ADPCM 32 kbit/s

■ **Power source:**

220–240 V, 50/60 Hz

■ **Power consumption, Base unit:**

Standby: Approx. 3.8 W

Maximum: Approx. 9.2 W

■ **Operating conditions:**

5 °C–40 °C, 20 %–80 % relative air humidity
(dry)

■ **Dimensions:**

Base unit: Approx. 86 mm × 183 mm × 122 mm

Handset: Approx. 148 mm × 48 mm × 32 mm

■ **Mass (weight):**

Base unit: Approx. 417 g (KX-TG1223)

Base unit: Approx. 425 g (KX-TG1233)

Handset: Approx. 130 g

Note:

- Specifications are subject to change.

- The illustrations used in these operating instructions may differ slightly from the actual product.

Index

- A** Alarm: 26
 - Answering calls
 - Base unit: 18
 - Handset: 18
 - Answering system: 39
 - Listening to messages: 40
 - Remote operation: 43
 - Settings: 44
 - Turning on/off: 39
 - Audible call: 22, 23, 36
 - Auto talk: 18, 29
- B** Base unit
 - Additional base units: 46
 - Cancelling: 48
 - PIN: 35
 - Resetting: 35
 - Selecting: 47
 - Settings: 31
- Battery
 - Charge: 10
 - Installation: 10
 - Life: 11
 - Replacement: 11
 - Strength: 11
- C** Call bar
 - Base unit: 34
 - Handset: 29
- Caller ID service: 36
- Call restriction: 34
- Category: 19
 - Ringtones: 36
- Chain dial: 21
- Character entry: 52
- Conference calls: 49
- Connections: 10
- D** Date and time: 12
- Dialling mode: 12
- Display (Base unit)
 - Icons: 9
- Display (Handset)
 - Contrast: 29
 - Icons: 9
 - Language: 28
- Standby mode: 28
- E** Emergency numbers: 33
- F** Flash: 16, 17, 33
- H** Handset
 - Additional handsets: 46
 - Cancelling: 47
 - PIN: 29
 - Power on/off: 12
 - Registration: 46
 - Resetting: 30
 - Settings: 25
- I** Intercom: 48
- K** Key lock: 15
- Keytones: 30
- M** Making calls
 - Base unit: 16
 - Handset: 14
- Missed calls: 36
- Mute: 15, 17
- N** Night mode
 - Base unit: 32
 - Handset: 27
- O** One touch dial: 20
- P** Paging: 49
 - Pause: 16, 17, 33
- Phonebook copy: 24
- Phonebooks
 - Handset phonebook: 19
 - Shared phonebook: 22
- PIN
 - Base unit: 35
 - Handset: 29
- Power on/off: 12
- R** Recording
 - Audible call: 22
 - Greeting message: 39
 - Telephone conversations: 16
 - Voice memo: 42
- Redialling: 14, 17
- Redial list: 14
- Registration: 46
- Repeater: 48
- Ringtones
 - Base unit: 18
 - Handset: 26



Index

- S** Speakerphone: 14, 16
- T** Temporary tone dialling: 16, 17
Transfer calls: 49
- V** Voice enhancer: 15
Voice mail: 37
Volume
 - Receiver: 14
 - Ringer (Base unit): 18
 - Ringer (Handset): 26
 - Speaker (Base unit): 17
 - Speaker (Handset): 14
- W** Wall mounting: 51

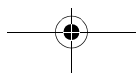
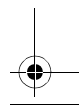
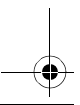
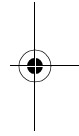
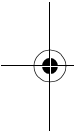

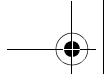

Notes

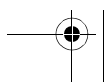
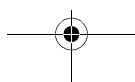
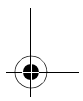
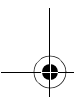
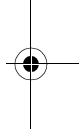
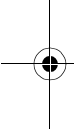



Notes

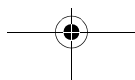
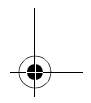
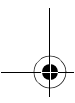
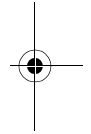
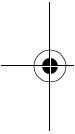



Notes

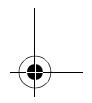
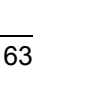
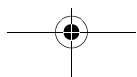
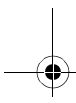
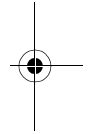
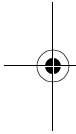

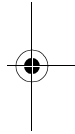
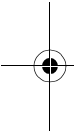
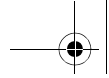

Panasonic Communications Co., Ltd.

1-62, 4-chome, Minoshima, Hakata-ku, Fukuoka 812-8531, Japan

Copyright:

This material is copyrighted by Panasonic Communications Co., Ltd., and may be reproduced for internal use only. All other reproduction, in whole or in part, is prohibited without the written consent of Panasonic Communications Co., Ltd.

© 2006 Panasonic Communications Co., Ltd. All Rights Reserved.

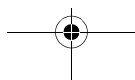

PQQX15928ZA CT1106DC0



Free Manuals Download Website

<http://myh66.com>

<http://usermanuals.us>

<http://www.somanuals.com>

<http://www.4manuals.cc>

<http://www.manual-lib.com>

<http://www.404manual.com>

<http://www.luxmanual.com>

<http://aubethermostatmanual.com>

Golf course search by state

<http://golfingnear.com>

Email search by domain

<http://emailbydomain.com>

Auto manuals search

<http://auto.somanuals.com>

TV manuals search

<http://tv.somanuals.com>