

Panasonic

2.4GHz Cordless Answering System

Model No. **KX-TG2570B**
KX-TG2570S
KX-TG2570F

Pulse-or-tone dialing capability

Operating Instructions



KX-TG2570B



2.4GHz
GIGARANGE EXTREME

**PLEASE READ BEFORE USE
AND SAVE.**

Caller ID Compatible

Charge the battery for about 7 hours before initial use.

Download from www.Somanuals.com. All Manuals Search And Download.

Preparation

Cordless Telephone

Answering System

Useful Information

Before Initial Use

Please read **IMPORTANT SAFETY INSTRUCTIONS** on page 80 before use.
Read and understand all instructions.

Thank you for purchasing your new Panasonic cordless telephone.

Caller ID and Call Waiting Service, where available, are telephone company services. After subscribing to Caller ID this phone will display a caller's name and phone number. Visual Call Waiting, which displays a second caller's name and phone number while the user is on another call, requires a subscription to both Caller ID and Call Waiting.

Attach your purchase receipt here.

For your future reference

Serial No. _____

(found on the bottom of the unit)

Date of purchase _____

Name and address of dealer _____

Accessories (included) For extra orders, call 1-800-332-5368.

- AC Adaptor (p. 11)
Order No. PQLV10Z

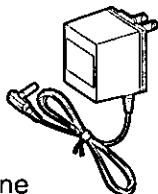

one

- Telephone Line Cord (p. 11)

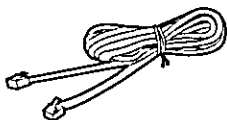

one

- Belt Clip (p. 72)
Order No.
PQKE10084Z1

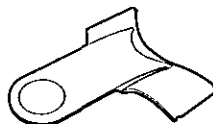

one

For Best Performance

Battery Charge

A rechargeable Nickel-Metal Hydride (Ni-MH) battery powers the handset. Charge the battery for about **7 hours** before initial use (p. 12).



Base Unit Location/Noise

Calls are transmitted between the base unit and the handset using wireless radio waves. **For maximum distance and noise-free operation**, the recommended base unit location is:

Away from electrical appliances such as a TV, personal computer or another cordless phone.

In a **HIGH and CENTRAL** location with no obstructions such as walls.

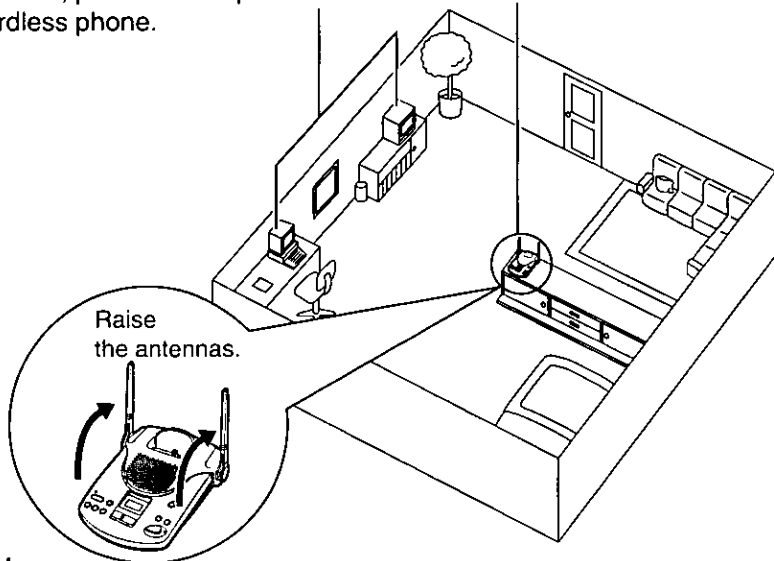

Note:

While using the handset:

- If you are near a microwave oven which is being used, noise may be heard from the receiver. Move away from the microwave oven and closer to the base unit.
- If more than one cordless phone is being used and your handset is near another cordless phone's base unit, noise may be heard. Move away from the other cordless phone's base unit and closer to your base unit.

Contents

Preparation

Location of Controls	6
Displays	8
Settings	11
Connections.....	11
Battery Charge	12
Selecting the Dialing Mode.....	14
Selecting the Line Mode	15
Programmable Functions	16
Storing Your Area Code	17
Storing a Second Area Code.....	18
Setting the Auto Talk Feature.....	19
Selecting the Ringer Volume	20
Preparing the Answering System	21
Greeting Message	21
Programming Summary for the Answering System.....	23
Time and Day Adjustment	24
Selecting the Caller's Recording Time	26
Selecting the Number of Rings.....	27

Cordless Telephone

Making Calls	28
Answering Calls	30
With the Handset	30
With the Base Unit (Digital Duplex Speakerphone).....	30
Caller ID Service	32
Using the Caller List	34
Viewing the Caller List	34
Calling Back from the Caller List	36
Editing the Caller's Phone Number	37
Storing Caller List Information in the Directory	38
Erasing Caller List Information	39
Using the Directory	40
Storing Names and Numbers in the Directory	40
Steps for Entering Names and Symbols	42
Finding Items in the Directory	44
Dialing from the Directory	45
Editing an Item in the Directory	46

Erasing an Item from the Directory	47
Intercom	48
Transferring a Call Using the Intercom	49
Special Features	50
Automatic Security Code Setting.....	50
How to Use the PAUSE Button (For Analog PBX Line/Long Distance Service Users)	50
For Call Waiting Service Users.....	51
Temporary Tone Dialing (For Rotary or Pulse Service Users)	51
FLASH Button.....	52

Answering System

Automatic Answering Operation	53
Setting the Unit to Answer Calls	53
Listening to Messages	54
From the Handset.....	56
Erasing Messages	57
Pager Call	58
Storing a Pager Number.....	58
Storing Your Home Telephone Number	60
Pager Mode Setting.....	62
Setting the Unit to Call a Pager	63
Remote Operation from a Touch Tone Phone	64
Setting the Remote Code	65
Voice Menu.....	66
Direct Remote Operation	68
Remote Operation with the Handset	70

Useful Information

Using the Belt Clip	72
Using an Optional Headset	72
Battery Replacement	73
Adding Another Phone	73
Before Requesting Help	74
Important Safety Instructions	80
FCC and Other Information	82

Location of Controls

Handset

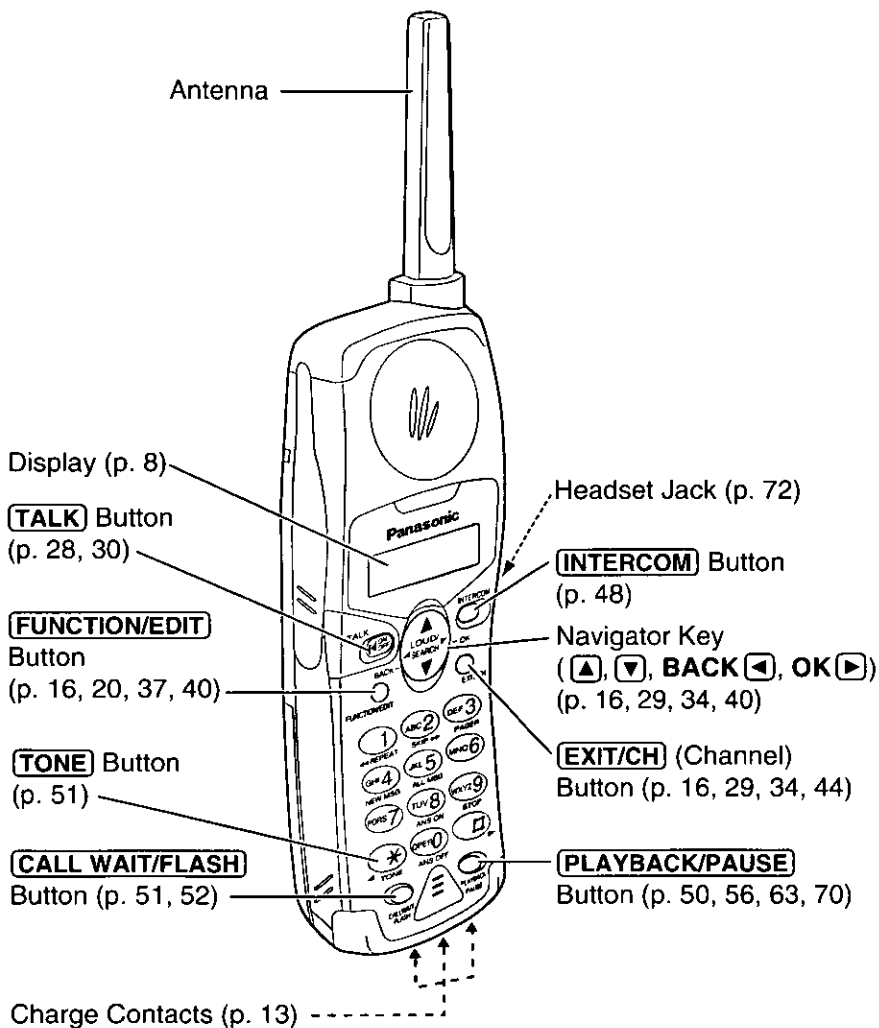

Base unit

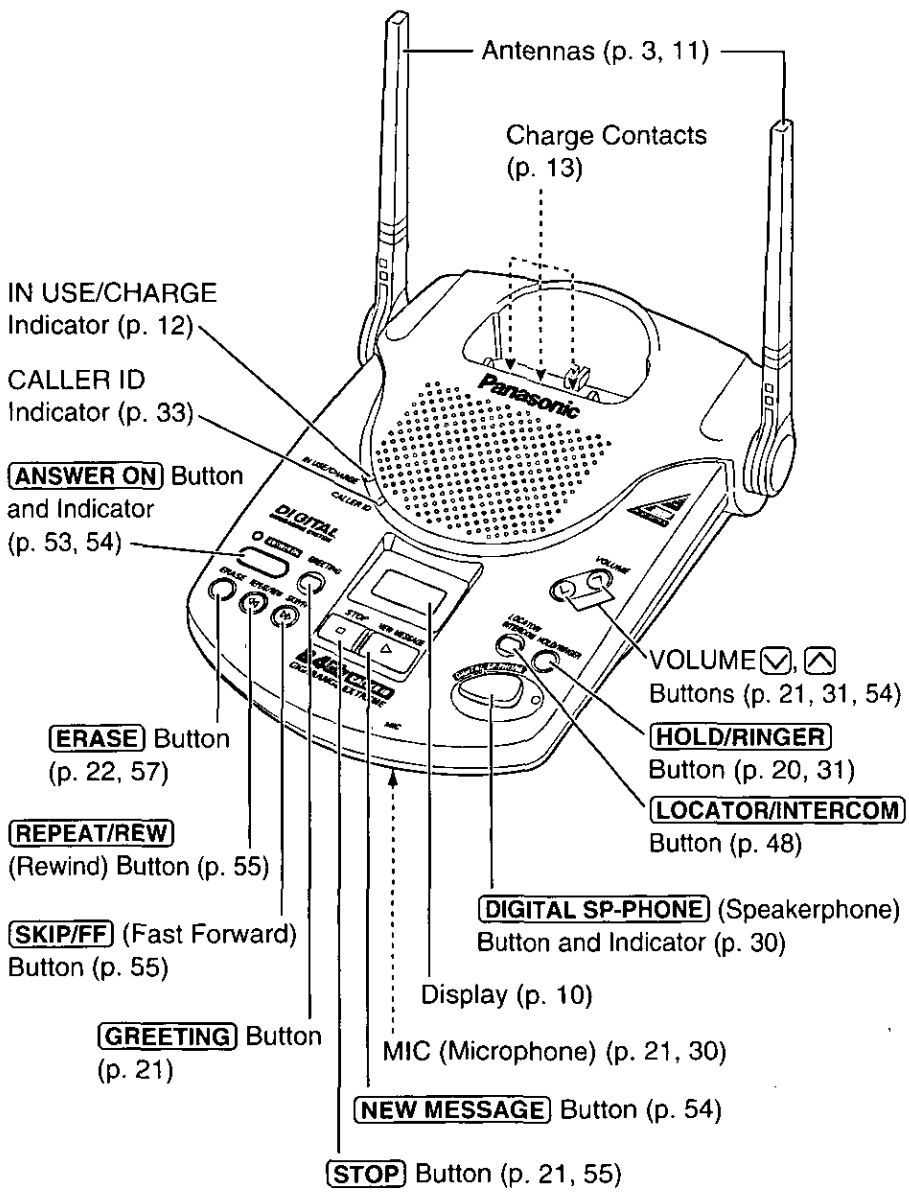

Displays

Both the handset and the base unit show you information and instructions on their displays. These display prompts are shown below.

Handset display

No items stored

The Caller List is empty or there are no stored items in the directory.

Recharge



The battery needs to be charged. Place the handset on the base unit to charge the battery (p. 12).

12 new calls



The display shows the number of new calls and the battery strength (p. 12) while the handset is on the base unit.

12 new calls
v=New ^=Old

This display will be shown when:

- you lift the handset off the base unit, or
- or is pressed when the handset is off the base unit.

To search from the most recent call, press (New key). To search from the oldest call, press (Old key) (p. 34).

Talk

01-06-35



During a conversation, the display shows the length of the call (ex. 1 hour, 6 minutes and 35 seconds). The battery strength is also displayed.

Out of range

The handset has lost communication with the base unit. Move closer to the base unit.

Save error

While programming, the handset lost communication with the base unit. Move closer to the base unit.

TINA ROBINSON

1-000-222-3333

When a call is received, the display shows the caller's name and number after the first ring.

Not available

or , **OK** , **PLAYBACK/PAUSE** or **INTERCOM** was pressed while the base unit was not in the stand-by mode.



JACK SMITH
111-2222
11:20A JAN12 ×3

This is a name from the Caller List.
The display shows:
— the caller's name,
— the caller's number,
— the time and date of the last call
(ex. Jan. 12, 11:20 AM), and
— the number of times called (ex. 3 times).

Paging
Press INTERCOM

The base unit is paging the handset (p. 48).

Intercom
00-00-07 {■■■■}

The handset and the base unit are in the intercom mode (p. 48).

Intercom hold
00-01-12 {■■■■}

An outside call has been put on hold by the handset user in the intercom mode. To release the hold, press **TALK** or **DIGITAL SP-PHONE** (p. 49).

NANCY BROWN
1-000-222-3333
----Waiting----

A second call is received during a conversation (p. 51).

Please lift up
and try again

▼ or **▲** was pressed while the handset was on the base unit. Lift the handset and press **▼** or **▲** again.

Memory is full

When trying to store an item or Caller List information in the directory, the directory memory is full (p. 38, 41).

Ann
1234567890

This is a name from the directory. The stored name and phone number are displayed.

Answering
system setting
{■■■■}

The unit is in answering system programming mode (p. 23).

Remote
operation
{■■■■}

The handset is operating the answering system remotely (p. 70).

➔ Displays

Base unit display



The clock needs adjusting (p. 24).

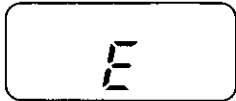

Your greeting message was not recorded correctly. Record it again (p. 21).



The unit is in the answering system programming mode.

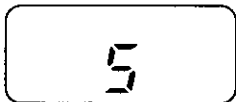

The speaker volume level is set to "5".

You can select:

- 9 levels (0–8) while using the answering system (p. 21, 54).
- 8 levels (1–8) while using the speakerphone (p. 31).

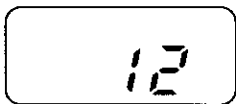

12 messages have been recorded.

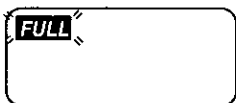

Memory is full. Erase some or all of the messages (p. 57).



The recording time is set to "greeting only" (p. 26). (The display is blank.)



The base unit ringer volume is set to OFF (p. 20).



The pager call mode is set to ON (p. 63).



Connections

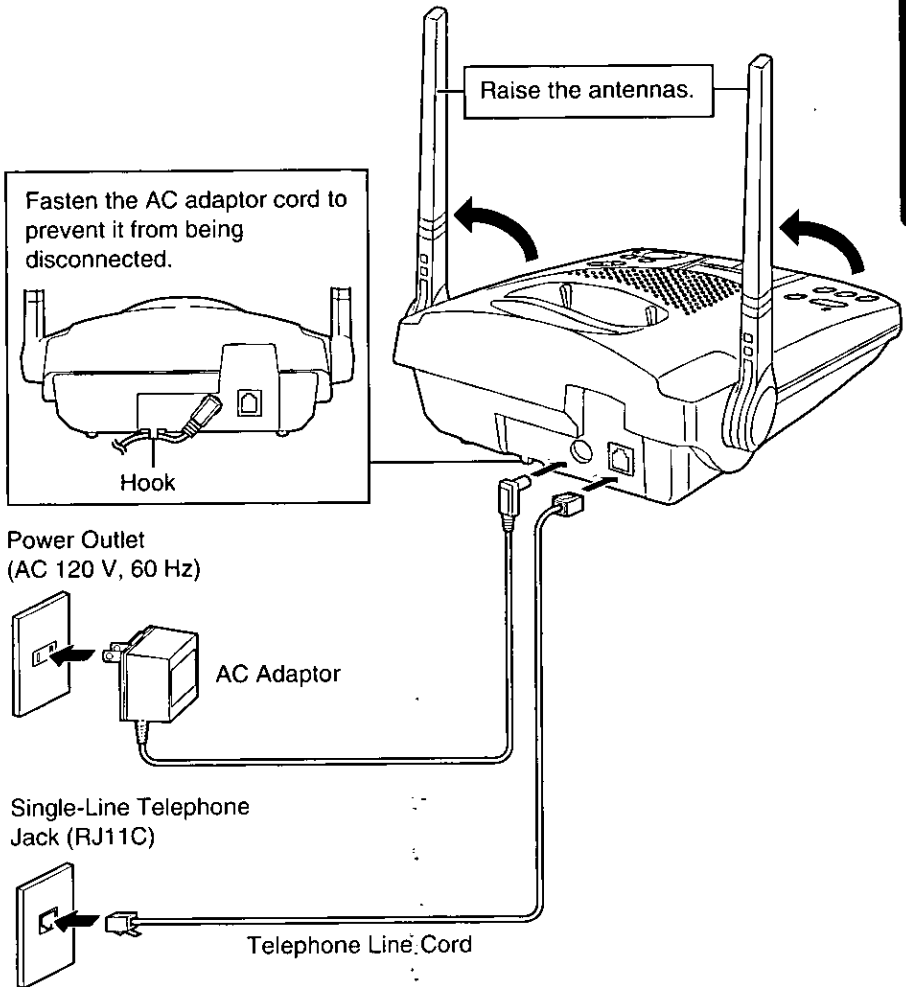

- USE ONLY WITH Panasonic AC ADAPTOR PQLV10 (Order No. PQLV10Z).
- The AC adaptor must remain connected at all times. (It is normal for the adaptor to feel warm during use.)
- To connect a standard telephone on the same line, see page 73.
- If your unit is connected to a PBX which does not support Caller ID services, you cannot access those services.

Battery Charge

Place the handset on the base unit and charge for about **7 hours** before initial use.

- The IN USE/CHARGE indicator lights.

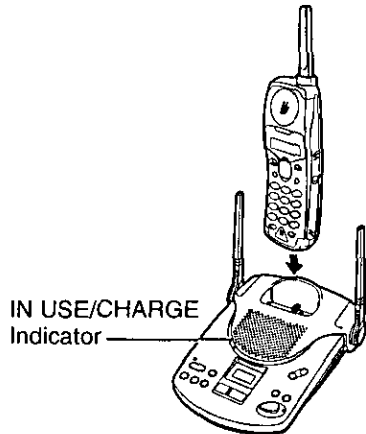

Battery strength

You can check the battery strength on the handset display while the handset is on the base unit, while it is in use (making/answering a call etc.), or after viewing the Caller List or directory items, programming etc. The battery strength will remain for 5 seconds after using the handset, then the display will return to the stand-by mode (see next page).

The battery strength is shown as in the chart below.

Display prompt	Battery strength
{ ■■■ }	Fully charged
{ ■■ }	Medium
{ ■ }	Low
⋈ { ■ } ⋈ (flashing)	Needs to be recharged.

Recharge

Recharge the battery when:

- “Recharge” is displayed on the handset,
- “{ ■ }” flashes on the handset display, or
- the handset beeps intermittently while it is in use.

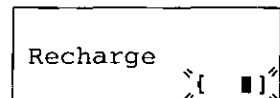

- If you DO NOT recharge the battery for more than 15 minutes, the display will keep indicating “Recharge” and/or “{ ■ }” will continue to flash.



Battery information

After your Panasonic battery is fully charged (p. 12):

Operation		Approx. battery life
While in use (TALK)	near the base unit*	8–9 hours
	away from the base unit	3–4 hours
While not in use (Stand-by)		14 days

*Within about 10 feet (3 m)

- Battery life may be shortened depending on usage conditions, such as viewing the Caller ID Caller List or directory items, and ambient temperature.
- **Clean the handset and the base unit charge contacts with a soft, dry cloth once a month. Clean more often if the unit is subject to grease, dust or high humidity.** Otherwise the battery may not charge properly.
- If the battery is fully charged, you do not have to place the handset on the base unit until “Recharge” is displayed and/or “[■]” flashes. This will maximize the battery life.
- The battery cannot be overcharged.

Stand-by mode (The handset is off the base unit.)

The handset goes into the stand-by mode after you finish using the handset (making/answering a call, viewing the Caller List or directory items etc.). The display is blank, but the handset can receive calls.

The battery life is conserved in this mode.

Selecting the Dialing Mode

You can program the dialing mode **using the handset near the base unit**. If you have touch tone service, set to "Tone". If rotary or pulse service is used, set to "Pulse". Your phone comes from the factory set to "Tone". **Make sure that the unit is in the stand-by mode.**

1 Press **FUNCTION/EDIT**.

```
▶Redial
  Directory
  v^      OK=Yes
```

2 Press **▼** or **▲** repeatedly until the arrow points to "Program".

```
  Ringer volume
  ▶Program
  v^      OK=Yes
```

3 Press **OK** **▶** (Yes key).

```
▶Save directory
  Set flash time
  v^      OK=Yes
```

4 Press **▼** or **▲** repeatedly until the arrow points to "Set dial mode".

```
  Set line mode
  ▶Set dial mode
  v^      OK=Yes
```

5 Press **OK** **▶** (Yes key).

```
  Dial mode
                :Tone
  v^      OK=Save
```

6 Press **▼** or **▲** to select "Pulse" or "Tone", and press **OK** **▶** (Save key).

```
  Dial mode
                :Pulse
```

- A beep sounds.
- The display will return to step 4. To return to the stand-by mode, press **EXIT/CH** or wait for 60 seconds.

- You can exit the programming mode any time by pressing **EXIT/CH**.
- If 3 beeps sound and the display shows "Save error", move closer to the base unit and try again. If "Save error" is still displayed, place the handset on the base unit. Start again from step 1.

If a power failure occurs, the mode will return to the factory preset (Tone). Reprogram if necessary.

Selecting the Line Mode

If the line is connected to a low voltage system such as a PBX, set to "B". Otherwise the Visual Call Waiting (Call Waiting ID) Service may not be accessible (p. 51), and the unit may not alert your pager (p. 58). Your phone comes from the factory set to "A".

Make sure that the unit is in the stand-by mode.

1 Press **FUNCTION/EDIT**.

```

▶Redial
  Directory
v^      OK=Yes
  
```

2 Press **▼** or **▲** repeatedly until the arrow points to "Program".

```

  Ringer volume
▶Program
v^      OK=Yes
  
```

3 Press **OK** **▶** (Yes key).

```

▶Save directory
  Set flash time
v^      OK=Yes
  
```

4 Press **▼** or **▲** repeatedly until the arrow points to "Set line mode".

```

▶Set line mode
  Set dial mode
v^      OK=Yes
  
```

5 Press **OK** **▶** (Yes key).

```

  Line mode
                                     :A
v^      OK=Save
  
```

6 Press **▼** or **▲** to select "B" or "A", and press **OK** **▶** (Save key).

```

  Line mode
                                     :B
  
```

- A beep sounds.
- The display will return to step 4. To return to the stand-by mode, press **EXIT/CH** or wait for 60 seconds.

- You can exit the programming mode any time by pressing **EXIT/CH**.
- If 3 beeps sound and the display shows "Save error", move closer to the base unit and try again. If "Save error" is still displayed, place the handset on the base unit. Start again from step 1.

If a power failure occurs, the mode will return to the factory preset (A). Reprogram if necessary.

Programmable Functions

You can program the following function items **using the handset near the base unit**. The display shows the programming instructions. See the corresponding pages for the function details.

Make sure that the unit is in the stand-by mode.

Press **FUNCTION/EDIT**.



<Function menu>*

▶Redial.....	To redial the last number dialed (p. 28).
Directory.....	To use the directory (p. 44).
Ringer volume.....	To select the ringer volume (p. 20).
Program	



Press **OK** .



<Function menu>*

▶Save directory.....	To store items in the directory (p. 40).
Set flash time.....	To select the flash time (p. 52).
Area code.....	To store your area code (p. 17).
2nd area code.....	To store a second area code (p. 18).
Set line mode.....	To select the line mode (p. 15).
Set dial mode.....	To select the dial mode (p. 14).
Talk switching.....	To set the auto talk feature (p. 19).
TAD program.....	To program answering system functions (p. 23)

During programming

*To select a desired function item, press  or  repeatedly until the arrow points to that item. Press **OK**  to go to the next step.

- You can exit the programming mode any time by pressing **EXIT/CH**.



Storing Your Area Code

We recommend that you first program your area code before using the Caller ID feature (p. 32). Incoming calls from the same area code will then be recorded in the Caller List without the area code. You do not have to remove the area code before calling back or storing. When incoming calls from a different area code are received, "1" will automatically be added before the area code.

Make sure that the unit is in the stand-by mode.

1 Press **FUNCTION/EDIT**.

2 Press **▼** or **▲** repeatedly until the arrow points to "Program".

```
Ringer volume
▶Program
v^      OK=Yes
```

3 Press **OK** **▶** (Yes key).

4 Press **▼** or **▲** repeatedly until the arrow points to "Area code".

```
▶Area code
  2nd area code
v^      OK=Yes
```

5 Press **OK** **▶** (Yes key).

- The current setting is displayed. If no area code has been stored, "---" will be displayed.

```
Area code
: ---
Enter area code
```

6 Enter your area code.

- If you enter a wrong number, press **BACK** **◀** and enter the correct number.

```
Area code
: 123
      OK=Save
```

7 Press **OK** **▶** (Yes key).

- A beep sounds.
- The display will return to step 4. To return to the stand-by mode, press **EXIT/CH** or wait for 60 seconds.

```
Area code
: 123
```

To erase the area code

Press **BACK** **◀** in step 6.

- If a "2nd area code" has been stored (p. 18), it will also be erased automatically.
- You can exit the programming mode any time by pressing **EXIT/CH**.

Storing a Second Area Code

You can also program a second local area code. This area code does not require "1" before it when dialing. After storing this area code, the display will show the 10 digits (3-digit area code plus 7-digit phone number) after a call is received from that area code. Calls will be recorded in the Caller List without "1". You cannot store a second area code unless your area code is stored first (p. 17).

Make sure that the unit is in the stand-by mode.

1 Press **FUNCTION/EDIT**.

2 Press **▼** or **▲** repeatedly until the arrow points to "Program".

```
Ringer volume
▶Program
▼▲          OK=Yes
```

3 Press **OK** **▶** (Yes key).

4 Press **▼** or **▲** repeatedly until the arrow points to "2nd area code".

```
Area code
▶2nd area code
▼▲          OK=Yes
```

5 Press **OK** **▶** (Yes key).

- The current setting is displayed. If no second area code has been stored, "---" will be displayed.
- If 3 beeps sound, your area code is not stored. Store the code first (p. 17).

```
2nd area code
          :---
Enter area code
```

6 Enter a second area code.

- If you enter a wrong number, press **BACK** **◀** and enter the correct number.

```
2nd area code
          :124
          OK=Save
```

7 Press **OK** **▶** (Save key).

- A beep sounds.
- The display will return to step 4. To return to the stand-by mode, press **EXIT/CH** or wait for 60 seconds.

```
2nd area code
          :124
```

To erase the second area code

Press **BACK** **◀** in step 6.

- You can exit the programming mode any time by pressing **EXIT/CH**.

Setting the Auto Talk Feature

The Auto Talk feature allows you to answer a call by lifting the handset off the base unit without pressing **TALK**. If you want to use this feature, turn the feature ON by programming. Your phone comes from the factory set to OFF.

Make sure that the unit is in the stand-by mode.

1 Press **FUNCTION/EDIT**.

2 Press **▼** or **▲** repeatedly until the arrow points to "Program".

```
Ringer volume
▶Program
v^      OK=Yes
```

3 Press **OK** **▶** (Yes key).

4 Press **▼** or **▲** repeatedly until the arrow points to "Talk switching".

```
▶Talk switching
TAD program
v^      OK=Yes
```

5 Press **OK** **▶** (Yes key).

```
Auto talk
:Off
v^      OK=Save
```

6 Press **▼** or **▲** to select "On" or "Off". Press **OK** **▶** (Save key).

```
Auto talk
:On
```

- A beep sounds.
- The display will return to step 4. To return to the stand-by mode, press **EXIT/CH** or wait for 60 seconds.

- You can exit the programming mode any time by pressing **EXIT/CH**.
- In order to view Caller ID information before answering a call, leave the Auto Talk feature OFF.

➔ Programmable Functions

Selecting the Ringer Volume

With the handset

You can program the ringer volume to HIGH, LOW or OFF. If set to OFF, the handset will not ring. Your phone comes from the factory set to HIGH. Make sure that the unit is in the stand-by mode.

1 Press **FUNCTION/EDIT**.

2 Press **▼** or **▲** repeatedly to select "Ringer volume". Press **OK** **▶** (Yes key).

3 Press **▼** or **▲** to select the desired volume.

- The selected volume is displayed and rings.
- **To turn the ringer OFF**, press and hold **▼** until 2 beeps sound.
- The handset will return to the stand-by mode.

To turn the ringer ON, press **▼** or **▲** in step 3.

- The ringer will sound at the LOW level.

▶Redial
Directory
v^ OK=Yes

▶Ringer volume
Program
v^ OK=Yes

HIGH
Ringer
Low ■■■■■ High
v^



LOW
Ringer
Low ■■ High
v^



OFF
Ringer off
v^

With the base unit

Make sure that the unit is in the stand-by mode.

- **To select HIGH (preset) or LOW**, press **HOLD/RINGER**. (Each time you press the button, the ringer volume will change and the selected volume will ring.)
- **To turn the ringer OFF**, press and hold **HOLD/RINGER** until 2 beeps sound. "**RINGER OFF**" will be displayed.
- **To turn the ringer ON**, press **HOLD/RINGER**.
The ringer will sound at the HIGH level.

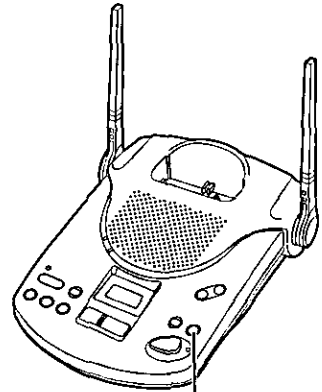

HOLD/RINGER

Preparing the Answering System ➔

Greeting Message

You can record a personal greeting message of **up to 2 minutes**. If a greeting message is not recorded, one of two pre-recorded greetings will be played when a call is received (p. 22).

All messages (greeting, incoming, etc.) are stored in digital memory (p. 54). The **total recording time is about 15 minutes**.

We recommend you record a **brief greeting message** (see sample on next page) in order to leave more time for recording new messages.

To record a greeting message

- 1 Press and hold **[GREETING]** to start the recording mode.
 - "Record greeting after the beep" is heard.
- 2 After the long beep, talk clearly, about 8 inches (20 cm) away from the **MIC** (microphone).
 - The base unit display shows the elapsed recording time.
 - If you record for over 2 minutes, the unit will automatically stop recording.
- 3 When finished, press **[STOP]**.
 - **To check** the recorded greeting, press **[GREETING]**.
 - **To change** the message, repeat from step 1.

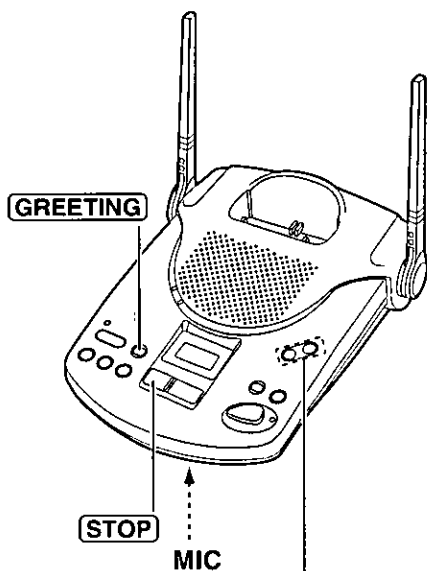

To increase the volume, press **VOLUME** .
To decrease, press **VOLUME** .

➔ Preparing the Answering System

Greeting message sample

"Hello, this is (your name and/or number). Sorry I cannot take your call. Please leave a message after the beep. Thank you."

To erase the recorded greeting message

Press **GREETING** ➔ press **ERASE** while the message is being played.

- The unit will answer calls with a pre-recorded greeting.

Pre-recorded greeting message

If you do not record a greeting message (p. 21), one of two messages will be played when a call is received, depending on the caller's recording time (p. 26).

To check the pre-recorded greeting, press **GREETING**.

- A pre-recorded greeting will be played as follows:
 - When the recording time is set to "1 minute" or "3 minutes":
"Hello, we are not available now. Please leave your name and phone number after the beep. We will return your call."
 - When the recording time is set to "greeting only":
"Hello, we are not available now. Please call again. Thank you for your call."

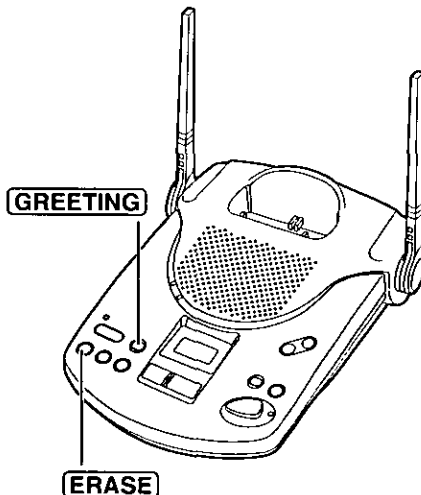



Programming Summary for the Answering System

You can program the following functions **using the handset near the base unit**. See the page numbers below for details.

Make sure that the unit is in the stand-by mode.

Press **FUNCTION/EDIT**.



Press **▼** or **▲** to select "Program", and press **OK** **▶**.



Press **▼** or **▲** to select "TAD program", and press **OK** **▶**.

- "Answering system setting" is displayed on the handset.



- If the handset displays "Out of range" and an alarm tone sounds, move closer to the base unit and try again.

To adjust **the time and day**, press **0**. (page 24)

To set **the remote code**, press **1**. (page 65)

To select **the number of rings**, press **2**. (page 27)

To select **the caller's recording time**, press **5**. (page 26)

To select **the pager mode setting**, press **6**. (page 62)

To store **your home telephone number**, press **7**. (page 60)

To store **a pager number**, press **#**. (pages 58, 59)

- The base unit display shows numbers or characters related to the adjustment or settings.



Press **OK** **▶**.

- A beep sounds.

- You can exit the programming mode any time by pressing **EXIT/CH**.
- If 6 beeps sound during programming, a wrong key was pressed. Enter the correct number.

A quick reference instruction sticker is included. Please attach this sticker in a convenient place. (Do not attach on the handset.)

➔ Preparing the Answering System

Time and Day Adjustment

Voice Time/Day Stamp: During playback, a synthesized voice will announce the time and day that each message was recorded.

Make sure that the unit is in the stand-by mode.

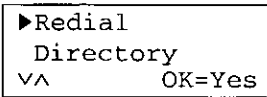
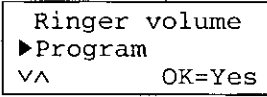
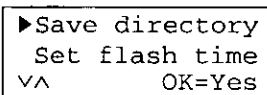
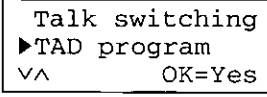
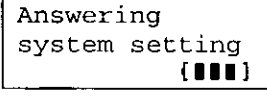
- 1 Press **FUNCTION/EDIT**.

- 2 Press **▼** or **▲** repeatedly until the arrow points to "Program".

- 3 Press **OK** **▶** (Yes key).

- 4 Press **▼** or **▲** repeatedly until the arrow points to "TAD program".

- 5 Press **OK** **▶** (Yes key).
 - "P" is displayed on the base unit.
- 6 Press **0**.
 - "Set time" is announced.
 - If previously adjusted, the time/day will be heard.
- 7 Enter the current time (hour and minute) using a 4-digit number.
(Ex. To set 9:30, enter "0930".)
 - The entered number is displayed on the base unit.
- 8 Press ***** to select "AM" or "PM".
Press **#** repeatedly to set the day.



9 Press OK .

- The unit announces the time/day. The clock starts working.
 - If 6 beeps sound, the setting is not correct. The display will return to step 4. Start from step 5.
 - The display will return to step 4. To return to the stand-by mode, press **EXIT/CH** or wait for 60 seconds.
-
- In step 7, you cannot enter numbers greater than 12. **Do not use military time.** (To set 13:00 hours, enter "0100" and select "PM" by pressing .)

If a power failure occurs, the adjusted time/day will be erased. Reprogram the current time/day.

To check the time/day

Repeat steps 1 to 6 on page 24.

- The current time/day is heard. When finished, press **EXIT/CH**.

For Caller ID service users (p. 32)

- The Caller ID information will re-set the clock after the first ring if the adjusted time is incorrect. However, if the time has not previously been set (p. 24), the Caller ID information will not adjust the clock.
- The Caller ID information will automatically adjust the clock for daylight saving time.

➔ Preparing the Answering System

Selecting the Caller's Recording Time

You can select "1 minute", "3 minutes" or "greeting only" for the caller's recording time. Your phone comes from the factory set to "3 minutes".

Make sure that the unit is in the stand-by mode.

- 1 Press **FUNCTION/EDIT**.

▶Redial
Directory
∨∧ OK=Yes
- 2 Press **▼** or **▲** repeatedly until the arrow points to "Program".

Ringer volume
▶Program
∨∧ OK=Yes
- 3 Press **OK** **▶** (Yes key).

▶Save directory
Set flash time
∨∧ OK=Yes
- 4 Press **▼** or **▲** repeatedly until the arrow points to "TAD program".

Talk switching
▶TAD program
∨∧ OK=Yes
- 5 Press **OK** **▶** (Yes key).
 - "P" is displayed on the base unit.

Answering
system setting
{■■■■}
- 6 Press **5**.
 - The current setting is displayed on the base unit.
 - 1: 1 minute
 - 2: 3 minutes (factory preset)
 - 3: greeting only
- 7 Press **1**, **2** or **3** to select the recording time.
 - The setting is displayed on the base unit.
- 8 Press **OK** **▶**.
 - A beep sounds.
 - The display will return to step 4. To return to the stand-by mode, press **EXIT/CH** or wait for 60 seconds.

If you select "greeting only", the unit will answer a call with the greeting message, and then hang up. The unit will not record any incoming messages.

Selecting the Number of Rings

You can select the number of times the unit rings before the answering system answers a call, from "2" to "7" or "AUTO (for Toll Saver*)". Your phone comes from the factory set to "AUTO".

Make sure that the unit is in the stand-by mode.

- 1 Press **FUNCTION/EDIT**.

▶Redial
Directory
√^ OK=Yes
- 2 Press **▼** or **▲** repeatedly until the arrow points to "Program".

Ringer volume
▶Program
√^ OK=Yes
- 3 Press **OK** **▶** (Yes key).

▶Save directory
Set flash time
√^ OK=Yes
- 4 Press **▼** or **▲** repeatedly until the arrow points to "TAD program".

Talk switching
▶TAD program
√^ OK=Yes
- 5 Press **OK** **▶** (Yes key).
 - "P" is displayed on the base unit.

Answering system setting
{■■■■}
- 6 Press **2**.
 - The current setting is displayed on the base unit.
- 7 Press **0**, or **2** to **7** to set the number of rings.
 - 0**: Selects "AUTO". "A" is displayed.
 - 2-7**: The unit will answer after the selected number of rings.
- 8 Press **OK** **▶**.
 - A beep sounds.
 - The display will return to step 4. To return to the stand-by mode, press **EXIT/CH** or wait for 60 seconds.

*Toll Saver (When set to "AUTO")

When you call the unit from a touch tone telephone:

If the unit answers on the 2nd ring, there is at least one new message.

If the unit answers on the 4th ring, there are no new messages.

Hang up when you hear the 3rd ring. This will save you the toll charge for the call.

Making Calls

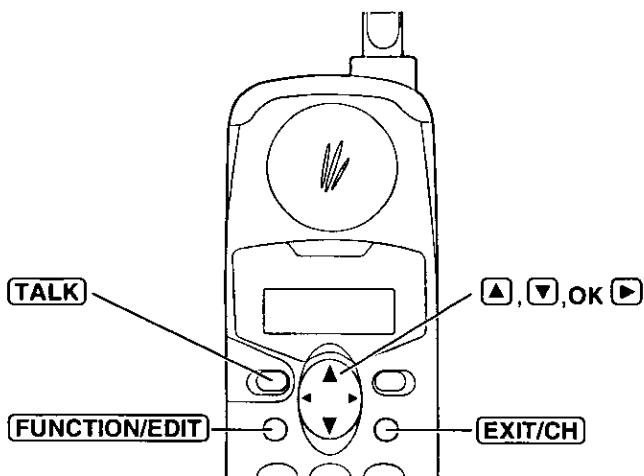

1 Press **TALK**.

Talk

2 Dial a phone number.

- The dialed number is displayed.
- After a few seconds, the display will show the length of the call and the battery strength.

Talk
1112222

Talk
00-00-00 [■■■■]

3 To hang up, press **TALK** or place the handset on the base unit.

- If "Out of range" is displayed and an alarm tone sounds in step 1, move closer to the base unit or place the handset on the base unit, and try again.

To redial the last number dialed

Press **FUNCTION/EDIT** ➔ **TALK**.

To redial after confirming the number in redial memory

1. Press **FUNCTION/EDIT**.
2. While the arrow points to "Redial", press **OK** ►.
 - The last number dialed is displayed.
3. Press **TALK**.

To select the receiver volume

Press ▲ or ▼ while talking.

- Each time you press ▲ or ▼, the volume level will change.
- The display will return to the length of the call.

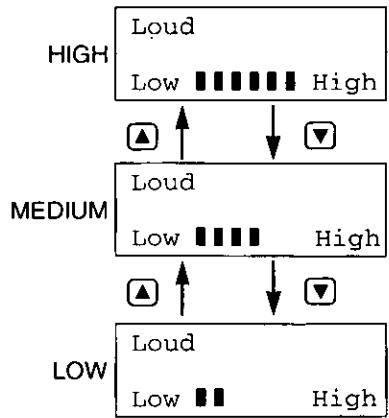

If noise interferes with the conversation

Press **EXIT/CH** to select a clearer channel or move closer to the base unit.

Lighted handset keypad

The handset dialing buttons will light when you press a button or lift the handset off the base unit, and flash when a call is received. The lights will go out about 10 seconds after pressing a button, lifting the handset or answering a call.

Backlit LCD display

The lighted handset display will stay on for about 10 seconds after pressing a handset button or lifting the handset off the base unit.

Answering Calls

When a call is being received, the unit rings and "Incoming call" is displayed on the handset. If you subscribe to a Caller ID service, the calling party information will be displayed after the first ring (p. 32). In order to view the CALLER ID information, please wait until the second ring to answer a call.

With the Handset

If the handset is off the base unit, press

TALK.

- You can also answer a call by pressing any dialing button **0** to **9**, ***** or **#** (— Any Key Talk).

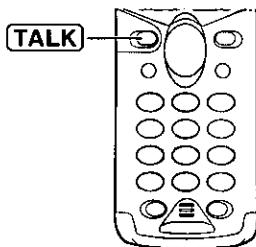

Auto Talk

If you set the Auto Talk feature to ON (p. 19), you can answer a call by lifting the handset off the base unit without pressing **TALK**.

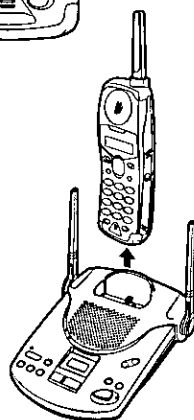

With the Base Unit (Digital Duplex Speakerphone)

1 Press **DIGITAL SP-PHONE**.

2 Talk into the MIC.

3 To hang up, press **DIGITAL SP-PHONE**.

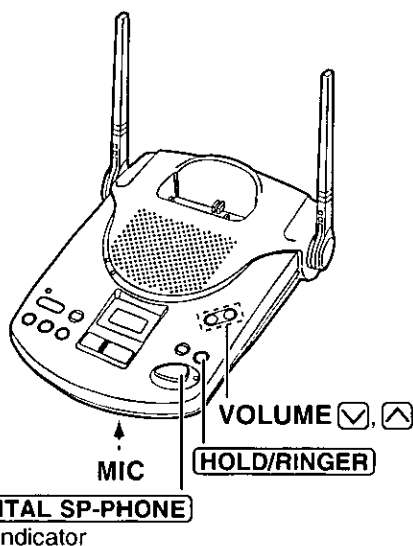

- To switch to the handset while using the speakerphone:
 - If the handset is off the base unit, press **TALK**.
 - If on the base unit, just lift up.
- During a call using the handset, the call can be switched to the speakerphone by pressing **DIGITAL SP-PHONE**.

Hands-free Digital Duplex Speakerphone

For best performance, please note the following:

- Talk alternately with the caller in a quiet room.
- If the other party has difficulty hearing you, press **VOLUME** to decrease the speaker volume.
- If the other party's voice from the speaker cuts in/out during a conversation, press **VOLUME** to decrease the speaker volume.

To adjust the speaker volume (8 levels) while talking

To increase, press **VOLUME** . To decrease, press **VOLUME** .

To put a call on hold

Press **HOLD/RINGER**.

- The DIGITAL SP-PHONE indicator flashes.

To release the hold

From the base unit, press **DIGITAL SP-PHONE**.

From the handset, press **TALK** or lift the handset off the base unit.

- If another phone is connected on the same line (p. 73), you can also release the hold by lifting its handset.

Caller ID Service

This unit is compatible with a Caller ID service offered by your telephone company. After subscribing to a Caller ID service, the calling party's information will be displayed on the handset after the first ring.

The unit can record information of up to 50 different callers, including the time and date the call was received and the number of times called, in the Caller List. The Caller List information is sorted from the most recent to the oldest call. When the 51st call is received, the oldest call is deleted.

Using the list, you can automatically call back a caller. You can store the callers' numbers from the Caller List in the directory.

If you subscribe to a Visual Call Waiting (Call Waiting ID) service, when a second call is received while talking, the new caller's name and phone number will be displayed (p. 51).

How caller information is displayed when a call is received

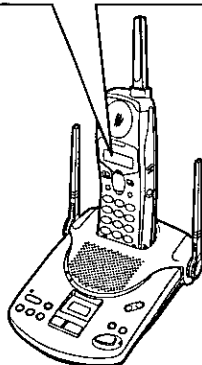
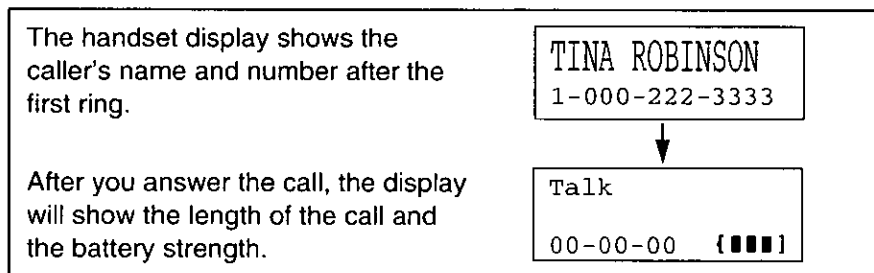

- Caller information cannot be displayed in the following cases:
 - If the caller dialed from an area which does not provide a Caller ID service, the display will show "Out of area".
 - If the caller has requested not to display his/her information, the display will show "Private caller".

- If your unit is connected to a PBX which does not support Caller ID services, you cannot access those services.
- In some calling areas, the name display service may not be available. For further information, please contact your telephone company.

To check the number of new calls

When new calls have been received, the CALLER ID indicator flashes on the base unit.

While the handset is on the base unit:

If you have received 10 new calls, the handset display will show the following:

```

10 new calls
  [||||]
  
```

When you lift the handset, the display changes to the following:

```

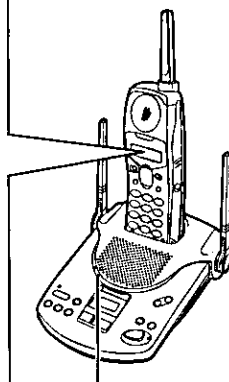

10 new calls
v=New      ^=Old
  
```

- After 10 seconds, the display changes to the stand-by mode (p. 13).



CALLER ID Indicator

While the handset is off the base unit:

Press  or  to turn the display on. If you have received 10 new calls, the display will show the following:

```

10 new calls
v=New      ^=Old
  
```

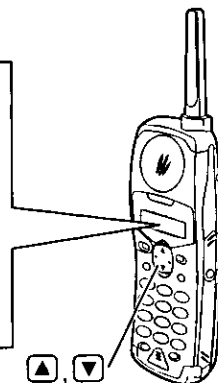



Using the Caller List





Viewing the Caller List

To check who has called, follow the steps below.

Make sure that the unit is in the stand-by mode.

- 1 Lift the handset off the base unit.
OR
If the handset is off the base unit, press  or  to enter the list.
 - The display will show the following.

2 new calls
v=New ^=Old

- 2 To search from the most recent call, press  (New key).
To search from the oldest call, press  (Old key).
 - To scroll between callers, press  or .

- 3 To exit the list, press **EXIT/CH**.
 - The handset will return to the stand-by mode.

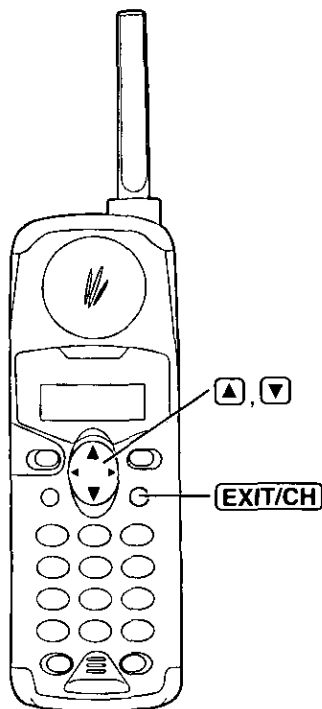

- Once new calls have been checked, "√" will be added.
- If "No items stored" is displayed in step 1, the Caller List is empty.
- If more than one call is received from the same caller, the date and time of the most recent call will be recorded. If the same caller calls again, the call entry with "√" will be deleted.



Ex. When you search from the most recent call:

Lift the handset off the base unit.

OR

If the handset is off the base unit, press or .

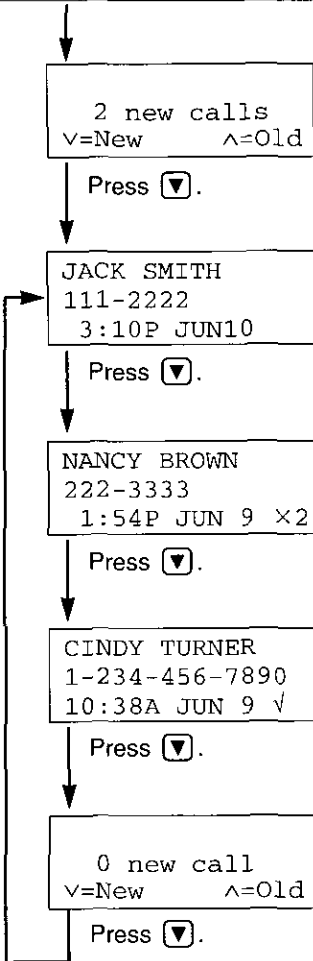

- If there is no name information for a caller, the display will only show the phone number.

To return to the previous caller, press .

To exit the Caller List, press **EXIT/CH**.



- The handset will return to the stand-by mode.

Display meaning:

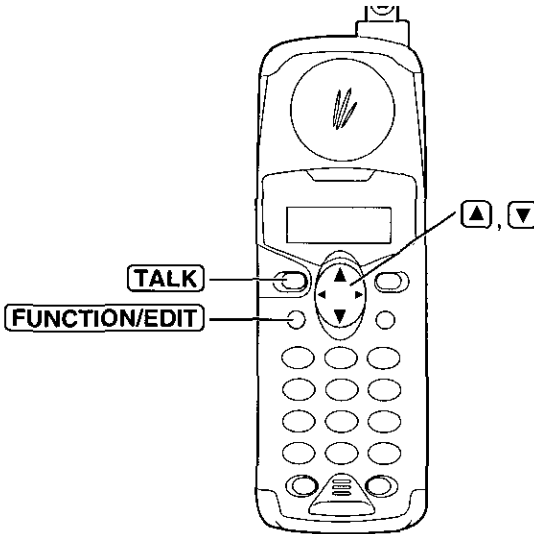

- ✓ : You have checked this caller information, answered the call, called back the caller or played back the message.
- ×2-×9 : The number of times the same caller called (up to 9). After checking, "×2" - "×9" will be replaced with "✓".

Calling Back from the Caller List



- 1** Lift the handset off the base unit.
OR
If the handset is off the base unit,
press  or  to enter the list.

3 new calls v=New ^=Old

- 2** Press  or  repeatedly to find the
desired caller.

CINDY TURNER 1-234-456-7890 11:20A JAN12 ×3

- 3** Press **TALK**.
- The displayed phone number is dialed automatically.

Talk 1234567890

Talk 00-00-00 
--

- In some cases you may have to edit the number before dialing (p. 37).
(Ex. You may have to add "1" for long distance calls.)
If you did not store your area code (p. 17), the edited number will not be saved in the Caller List.
- If a phone number is not displayed in the caller information, you cannot call back that caller.



Editing the Caller's Phone Number

The unit can edit a phone number into one of 4 patterns.

Make sure that the unit is in the stand-by mode.

- 1** Lift the handset off the base unit.
OR
If the handset is off the base unit, press or to enter the list.

```

5 new calls
v=New      ^=Old
  
```

- 2** Press or repeatedly to find the desired caller.

```

FRED PARKER
321-5555
11:20A JAN12 x3
  
```

- 3** Press **FUNCTION/EDIT** to select a pattern. Each time you press **FUNCTION/EDIT**, the number is rearranged into one of 4 different patterns.

(a)

```

FRED PARKER
1-321-5555
11:20A JAN12 x3
  
```

(b)

```

FRED PARKER
1-234-321-5555
11:20A JAN12 x3
  
```

(c)

```

FRED PARKER
234-321-5555
11:20A JAN12 x3
  
```

(d)

```

FRED PARKER
321-5555
11:20A JAN12 x3
  
```

- (a)** 1 - .
- (b)** 1 - - .
- (c)** - .
- (d)** .

- The order in which patterns **(a)** - **(d)** are displayed depends on how the telephone number is displayed in step 2.

- 4** After editing the number, you can continue with calling back or storing procedures.
To call back, press **TALK** (p. 36).
To store the number in the directory, press **OK** and follow the instructions on the display (see page 38, from step 3).

➔ Using the Caller List

Storing Caller List Information in the Directory

You can store names and phone numbers that are in the Caller List into the directory.

Make sure that the unit is in the stand-by mode.

1 Lift the handset off the base unit.

OR

If the handset is off the base unit, press **▼** or **▲** to enter the list.

```
10 new calls
v=New      ^=Old
```

2 Press **▼** or **▲** repeatedly to find the caller you want to store in the directory, and press **OK** **▶**.

```
CINDY TURNER
1-234-456-7890
11:20A JAN12 x3
```

• If the number requires editing, see page 37.

3 While the arrow points to "Save directory", press **OK** **▶**.

```
▶Save directory
Clear
v^          OK=Yes
```

If there is no name information for the caller, "Enter name" will be displayed.

a) If a name is not required, press **OK** **▶** (Save key).

b) If a name is required, enter the name (p. 42). When finished, press **OK** **▶** (Save key).

```
Enter name
□
*#=←→     OK=Save
```

```
Enter name
CINDY TURNER
*#=←→     OK=Save
```

• A beep sounds.



• The display will return to step 2. You can continue storing other items. To return to the stand-by mode, press **EXIT/CH** or wait for 60 seconds.

- You can exit the programming mode any time by pressing **EXIT/CH**.
- If the display shows "Memory is full" in step 3, the display will return to step 2. Press **EXIT/CH** to exit the list. To erase other stored items from the directory, see page 47.
- You cannot store caller information in the directory if a phone number is not displayed.



Erasing Caller List Information

After checking the Caller List, you can erase some or all of the entries.
Make sure that the unit is in the stand-by mode.

To erase a specific caller from the Caller List

- 1 Lift the handset off the base unit.
OR
If the handset is off the base unit, press  or  to enter the list.

10 new calls v=New ^=Old

- 2 Press  or  repeatedly to find the caller you want to erase from the caller list, and press **OK** .

TOM REAGAN 444-5555 12:20A JAN12 ✓
--



- 3 Press  or  to select "Clear".

Save directory ▶Clear v^ OK=Yes
--

- 4 Press **OK**  (Yes key).
 - A beep sounds and the information is erased.
 - After a few seconds, the display will show the previous caller information.
 - To return to the stand-by mode, press **EXIT/CH** or wait for 60 seconds.



Clear

To erase all entries in the Caller List

- 1 Lift the handset off the base unit.
OR
If the handset is off the base unit, press  or  to enter the list.

Make sure this display is shown.

0 new call v=New ^=Old

- 2 Press **OK** .
- 3 Press  or  to select "All clear".

Exit ▶All clear v^ OK=Yes

- 4 Press **OK**  (Yes key).
 - A beep sounds and all entries are erased.
 - The handset will return to the stand-by mode.

All clear

Using the Directory

You can store up to 30 names and phone numbers in the directory. All directory items are sorted by the first word in alphabetical order. Using the directory, you can make a call by selecting a name on the handset display.

Storing Names and Numbers in the Directory

Make sure that the unit is in the stand-by mode.

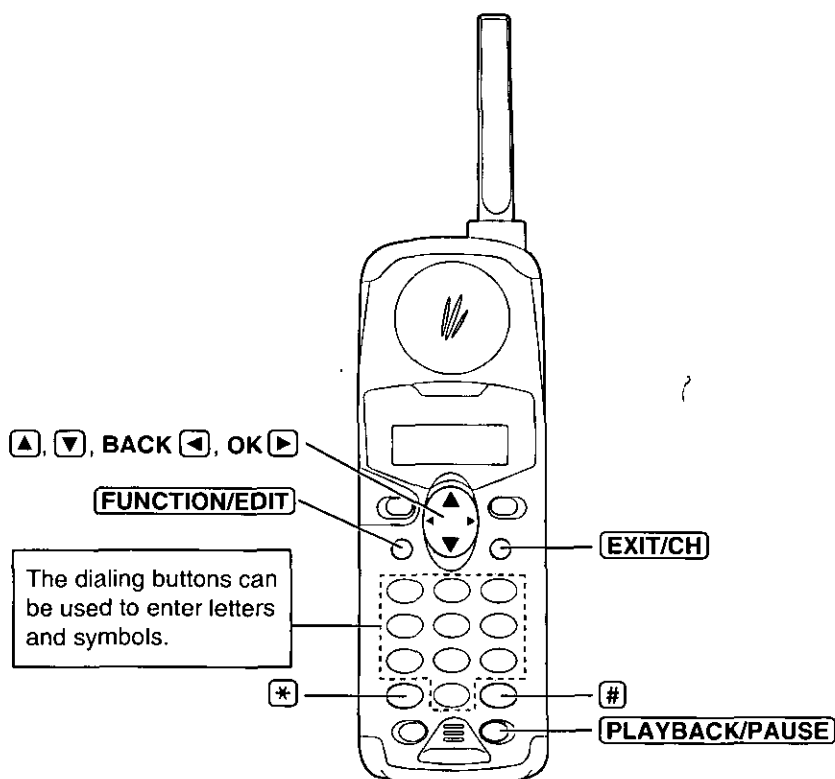



- 1 Press **FUNCTION/EDIT**.
- 2 Press **▼** or **▲** repeatedly until the arrow points to "Program", and press **OK** **▶** (Yes key).

```
Ringer volume
▶Program
v^          OK=Yes
```

```
▶Save directory
Set flash time
v^          OK=Yes
```

- 3 While the arrow points to "Save directory", press **OK** **▶** (Yes key).

```
Directory=
0 item
```

- 4 Enter a name up to 15 characters with the dialing buttons, ***** (←) or **#** (→).

- See the steps for entering names and symbols on page 42.
- If a name is not required, press **OK** **▶** (Next key) and go to step 6.

```
Enter name
□
*#=←→     OK=Next
```

```
Enter name
Tom Jones
*#=←→     OK=Next
```

- 5 Press **OK** **▶** (Next key).

```
Enter phone no.
```

- 6 Enter a phone number up to 22 digits.
 - If you misdial, press **BACK** **◀**. Digits are erased from the right.

```
0987654321□
OK=Save
```

- 7 Press **OK** **▶** (Save key).
 - A beep sounds.
 - The display will return to step 2. You can continue storing other items after pressing **OK** **▶** (Yes key).
 - To return to the stand-by mode, press **EXIT/CH** or wait for 60 seconds.

```
Tom Jones
0987654321
```

- If a pause is required for dialing, **PLAYBACK/PAUSE** can be stored in a phone number in step 6. This counts as one digit (p. 50).
- You can exit the programming mode any time by pressing **EXIT/CH**.
- If the display shows "Memory is full" in step 3, the handset will return to step 2. Press **EXIT/CH**, and erase other stored items from the directory (p. 47).

➔ Using the Directory

Steps for Entering Names and Symbols

The handset dialing buttons can be used to enter letters and symbols.

Each button selects a character as shown below.

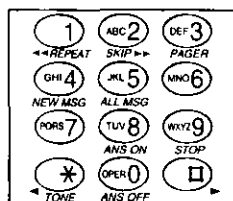

Keys	Number of times key is pressed										
	1	2	3	4	5	6	7	8	9	10	11
①	#	&	'	()	*	,	-	.	/	1
②	A	B	C	a	b	c	2				
③	D	E	F	d	e	f	3				
④	G	H	I	g	h	i	4				
⑤	J	K	L	j	k	l	5				
⑥	M	N	O	m	n	o	6				
⑦	P	Q	R	S	p	q	r	s	7		
⑧	T	U	V	t	u	v	8				
⑨	W	X	Y	Z	w	x	y	z	9		
⑩	0	Blank									
*	To move the cursor <input type="checkbox"/> to the left.										
#	To move the cursor <input type="checkbox"/> to the right.										

If you make a mistake while entering a name

Use * (←) or # (→) to move the cursor to the incorrect character, press **BACK** (◀) to delete, and enter the correct character. Each time you press **BACK** (◀) a character is erased from the right.

To erase all characters, press **BACK** (◀) firmly.



For example, to enter "Tom Jones":

- 1 Press **FUNCTION/EDIT**.
- 2 Press **▼** or **▲** repeatedly until the arrow points to "Program", and press **OK ▶** (Yes key).
- 3 While the arrow points to "Save directory", press **OK ▶** (Yes key).
- 4 Press **8**.
- 5 Press **6** six times, then press **# (→)** to move the cursor to the right.
- 6 Press **6** four times.
- 7 Press **# (→)** twice to enter a blank.
- 8 Press **5**.
- 9 Press **6** six times, then press **# (→)** to move the cursor to the right.
- 10 Press **6** five times.
- 11 Press **3** five times.
- 12 Press **7** eight times.
- 13 When finished, press **OK ▶** (Next key).
 - To enter a phone number, see page 41, from step 6.

Directory=
20 items

Enter name
□
*#=←→ OK=Next

T

To□

Tom

Tom □

Tom J

Tom Jo□

Tom Jon

Tom Jones

Enter name
Tom Jones
*#=←→ OK=Next

Enter phone no.

- While entering names, the cursor will flash on the display.
- To enter another character using the same dialing button, press **# (→)** to move the cursor to the next space.

Finding Items in the Directory

Make sure that the unit is in the stand-by mode.

- 1 Press **FUNCTION/EDIT**.
- 2 Press **▼** or **▲** repeatedly until the arrow points to "Directory".

```
Redial
▶Directory
v^      OK=Yes
```

- 3 Press **OK** **▶** (Yes key).
 - The first item is displayed.

```
Ann
1234567890
```

- 4 Press **▼** or **▲** repeatedly until the desired item is displayed.
 - All directory items are stored in the order shown on the right.

To search for a name by initial:

- ① Press the dialing button for the first letter of the desired name until any name with the same initial is displayed (see the Index table on page 45).
Ex. To find "Frank", press **3** until the first item under "F" is displayed.
- ② Press **▼** until the desired name is displayed.

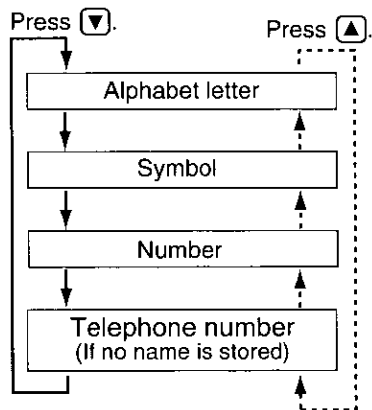
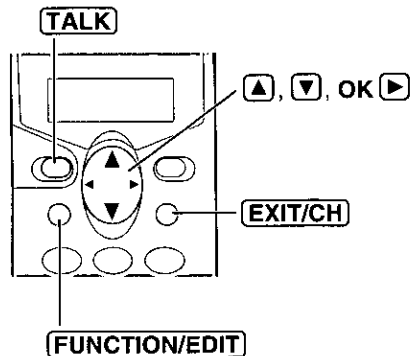

- You can leave the directory any time by pressing **EXIT/CH**.
- If "No items stored" is displayed in step 3, the directory is empty.



Keys	Index	Keys	Index
①	Other symbols, 1	⑥	M, N, O, 6
②	A, B, C, 2	⑦	P, Q, R, S, 7
③	D, E, F, 3	⑧	T, U, V, 8
④	G, H, I, 4	⑨	W, X, Y, Z, 9
⑤	J, K, L, 5	⑩	0

Dialing from the Directory

- 1 Press **FUNCTION/EDIT**.
- 2 Press **▼** or **▲** repeatedly until the arrow points to "Directory".
- 3 Press **OK** **▶** (Yes key).
 - The first item is displayed.
- 4 Press **▼** or **▲** repeatedly to find the directory item that you want to dial (p. 44).
 - To exit the directory, press **EXIT/CH**.
- 5 Press **TALK**.
 - The number is dialed automatically.
- 6 To hang up, press **TALK** or place the handset on the base unit.

```

▶Redial
  Directory
v^          OK=Yes
  
```

```

  Redial
▶Directory
v^          OK=Yes
  
```

```

Frank
4567890
  
```

```

Talk
4567890
  
```

➔ Using the Directory

Editing an Item in the Directory

Make sure that the unit is in the stand-by mode.

- 1 Press **FUNCTION/EDIT**.
- 2 Press **▼** or **▲** repeatedly until the arrow points to "Directory".

Redial
▶Directory
v^ OK=Yes
- 3 Press **OK** **▶** (Yes key).
 - The first item is displayed.
- 4 Press **▼** or **▲** repeatedly to find the directory item you want to change (p. 44), and press **OK** **▶**.

Jane
1234567
- 5 While the arrow points to "Edit", press **OK** **▶**.

▶Edit
Clear
v^ OK=Yes
- 6 Press **OK** **▶** (Yes key).
 - If you do not need to change the name, go to step 8.
- 7 Edit the name by using the dialing buttons, ***** (←) or **#** (→) (p. 42), up to 15 characters.

Enter name
Jane
*#=←→ OK=Next
- 8 Press **OK** **▶** (Next key).
 - If you do not need to change the number, press **OK** **▶** (Save key).
- 9 Add a number to the current number.
 - Each time you press **BACK** **◀** the digit to the left of the cursor is erased. To erase all of the digits, press **BACK** **◀** firmly.
- 10 When finished, press **OK** **▶** (Save key).
 - The display will return to step 4. You can continue editing other items.
 - To return to the stand-by mode, press **EXIT/CH** or wait for 60 seconds.

1234567
OK=Save0981234567
OK=SaveJane Walker
0981234567

- You can exit the programming mode any time by pressing **EXIT/CH**.

Erasing an Item from the Directory

Make sure that the unit is in the stand-by mode.

- 1 Press **FUNCTION/EDIT**.
- 2 Press **▼** or **▲** repeatedly until the arrow points to "Directory".
- 3 Press **OK** **▶** (Yes key).
 - The first item is displayed.
- 4 Press **▼** or **▲** repeatedly to find the directory item you want to erase (p. 44).
- 5 Press **OK** **▶**.
- 6 Press **▼** or **▲** to select "Clear".
- 7 Press **OK** **▶** (Yes key).
 - The display will show the next item.
 - To return to the stand-by mode, press **EXIT/CH** or wait for 60 seconds.

```
Redial
▶Directory
v^          OK=Yes
```

```
Helen
1234567890
```

```
▶Edit
Clear
v^          OK=Yes
```

```
Edit
▶Clear
v^          OK=Yes
```

```
Clear
```

- You can exit the programming mode any time by pressing **EXIT/CH**.

Intercom

A 2-way intercom is available between the handset and the base unit.

Paging the base unit from the handset

- 1 Handset:**
Press **INTERCOM**. Talk to the paged party after the beeps.
 - "Intercom" is displayed.
- 2 Base unit:**
When the other party's voice is heard, answer using the **MIC**.
- 3 Handset:**
To end the intercom, press **INTERCOM**.

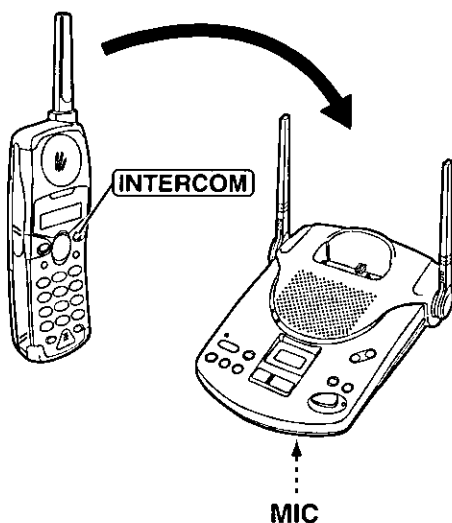

Paging the handset from the base unit (Handset locator)

Using this feature, you can locate a misplaced handset.

- 1 Base unit:**
Press **LOCATOR/INTERCOM**.
 - The handset beeps for 1 minute and "Paging Press INTERCOM" is displayed.
 - To stop paging, press **LOCATOR/INTERCOM** again.
- 2 Handset:**
Press **INTERCOM** to answer.
 - "Intercom" is displayed.
- 3 Base unit:**
Talk into the **MIC**.
- 4 Handset:**
To end the intercom, press **INTERCOM**.

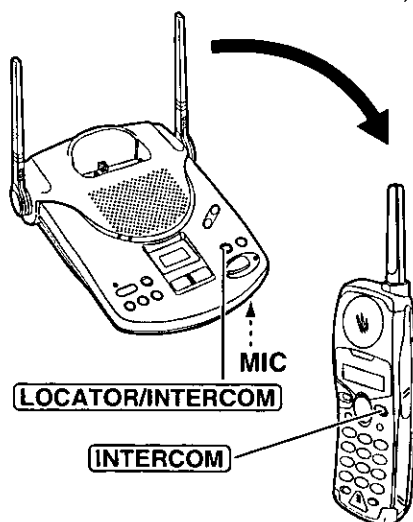

During an intercom call:

- Intercom calls can only be ended with the handset.
- If the handset user has difficulty hearing the base unit user, decrease the base unit speaker volume by pressing **VOLUME** .
- If an incoming call is received, the intercom call stops and the unit starts to ring. To answer, press **TALK** or **DIGITAL SP-PHONE**.

Transferring a Call Using the Intercom

The intercom can be used during a call. This feature enables you to transfer a call between the handset and the base unit.

From the handset to the base unit

1 Handset:
During a call, press **INTERCOM**. Talk to the paged party after the beeps.

- The call is put on hold and "Intercom hold" is displayed.
- If the base unit user does not answer, press **TALK**.

2 Base unit:
When the paging party's voice is heard, answer using the **MIC**.

3 Base unit:
To answer the call, press **DIGITAL SP-PHONE**.

- The transfer is complete.

From the base unit to the handset

1 Base unit:
During a call, press **LOCATOR/INTERCOM**.

- The call is put on hold.
- If the handset user does not answer, press **DIGITAL SP-PHONE**.

2 Handset:
Press **INTERCOM** to answer the page.

3 Handset:
To answer the call, press **TALK**.

- The transfer is complete.

Special Features

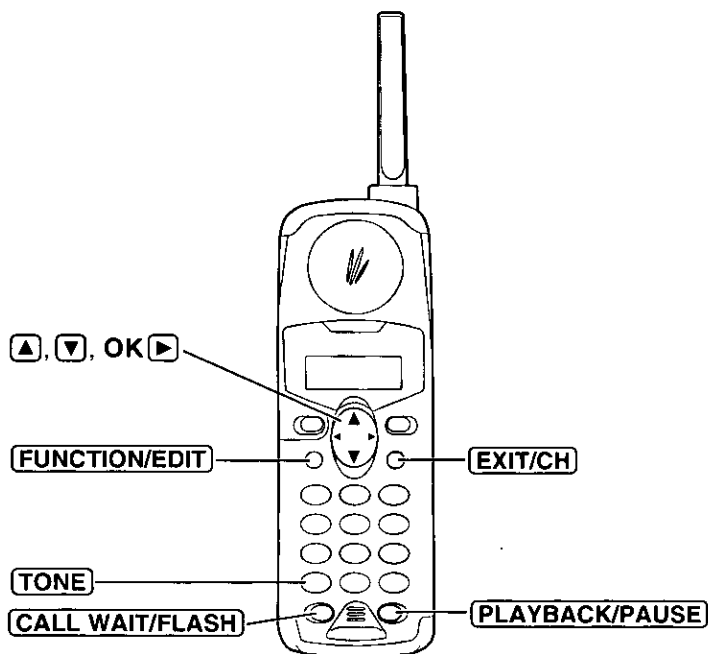

Automatic Security Code Setting

Each time you place the handset on the base unit, the unit automatically selects one of a million security codes. These codes help prevent the unauthorized use of your telephone line by another cordless telephone user.

How to Use the PAUSE Button

(For Analog PBX Line/Long Distance Service Users)

We recommend you press **PLAYBACK/PAUSE** if a pause is required for dialing with a PBX or to access a long distance service.

Ex. Line access number **9** (PBX)

9 ⇒ **PLAYBACK/PAUSE** ⇒ Phone number

- Pressing **PLAYBACK/PAUSE** once creates a 3.5 second pause. This prevents misdialing when you redial or dial a stored number.
- Pressing **PLAYBACK/PAUSE** more than once increases the length of the pause between numbers.



For Call Waiting Service Users

Press **CALL WAIT/FLASH** if you hear a call-waiting tone while talking.

- The first call is put on hold and you can answer the second call.
- To return to the first caller, press **CALL WAIT/FLASH** again.
- The call waiting service cannot be used when:
 - the answering system is recording someone's message, or
 - a parallel connected telephone is in use.
- If this function does not operate properly, consult your telephone company for details.

Visual Call Waiting (Call Waiting ID) Service

Visual Call Waiting (Call Waiting ID) Service allows your handset to display the second caller's information. After you hear a call-waiting tone while talking, the handset will display the caller's name with the phone number and "----Waiting----".

NANCY BROWN 1-000-222-3333 ----Waiting----
--

- The second caller's information will not be displayed when you are having a conversation using the base unit while the handset is off the base unit.
- Please contact your telephone company for details and availability in your area.

Temporary Tone Dialing (For Rotary or Pulse Service Users)

Press **TONE** before entering access numbers which require tone dialing.

- The dialing mode changes to tone. You can enter numbers to access an answering service, electronic banking service, etc. When you hang up, the mode will return to pulse.
- Access numbers entered after pressing **TONE** will not be included when redialing.

FLASH Button

Pressing **CALL WAIT/FLASH** allows you to use special features of your host PBX such as transferring an extension call or accessing special telephone services (optional) such as call waiting.

Selecting the flash time

The flash time depends on your telephone exchange or host PBX. You can select from flash times: "700, 600, 400, 300, 250, 110, 100 or 90 ms (milliseconds)", **using the handset near the base unit**. Your phone comes from the factory set to "700 ms".

Make sure that the unit is in the stand-by mode.

1 Press **FUNCTION/EDIT**.

2 Press **▼** or **▲** repeatedly until the arrow points to "Program".

Ringer volume
▶Program
▼^ OK=Yes

3 Press **OK** **▶** (Yes key).

4 Press **▼** or **▲** repeatedly until the arrow points to "Set flash time".

Save directory
▶Set flash time
▼^ OK=Yes

5 Press **OK** **▶** (Yes key).

Flash time
:700ms
▼^ OK=Save

6 Press **▼** or **▲** repeatedly until the desired time is displayed.

7 Press **OK** **▶** (Save key).

- A beep sounds.
- The display will return to step 4. To return to the stand-by mode, press **EXIT/CH** or wait for 60 seconds.

- You can exit the programming mode any time by pressing **EXIT/CH**.
- If 3 beeps sound and the display shows "Save error", move closer to the base unit and try again. If "Save error" is still displayed, place the handset on the base unit. Start again from step 1.
- If you are connected via a PBX, a longer flash time may be necessary to use PBX functions (transferring a call etc.). Consult your PBX installer for the correct setting.

If a power failure occurs, the setting will return to the factory preset (700 ms). Reprogram if necessary.
--

Automatic Answering Operation

When the unit answers a call, a greeting message is played and the caller's message is recorded.

- The total recording time (including greeting message) is **about 15 minutes**. If messages are recorded in noisy rooms, the time may be shortened by up to 3 minutes.
- A maximum of 64 messages (including greeting message) can be recorded.

Setting the Unit to Answer Calls

Press **ANSWER ON** to turn on the answering system.

- The indicator lights and "Answer set" and the current day and time is heard.
- The unit will announce the remaining recording time if it is less than 5 minutes.
- If you hear "Memory full", "**FULL**" is displayed on the base unit and the ANSWER ON indicator flashes rapidly, erase some or all of the messages (p. 57).

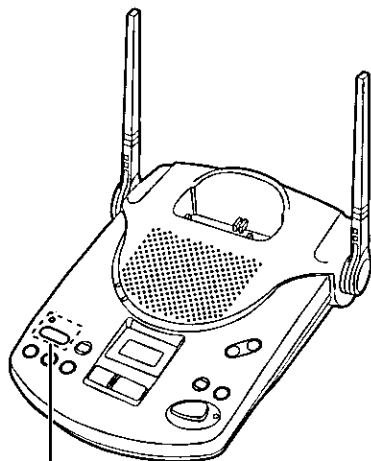

ANSWER ON
and Indicator

- If you do not want the unit to answer calls, press **ANSWER ON** again to turn off the answering system. The indicator light goes out and "Answer off" is heard.
- You can also turn on the answering system remotely using any other phone (p. 69).

Monitoring incoming calls

While a call is being recorded, you can monitor it through the speaker. To answer the call with the speakerphone, press **DIGITAL SP-PHONE**. For the handset, press **TALK**. The unit stops recording.

Listening to Messages

You can see the total number of recorded messages on the base unit display. If the ANSWER ON indicator flashes, new messages have been recorded.

Listening to only new messages

Press **NEW MESSAGE** briefly.

- The unit announces the number of new messages and plays them back.

Listening to all recorded messages

Press and hold **NEW MESSAGE** until playback starts.

- At the end of the last message, "End of final message" is heard. The unit will announce the remaining recording time if it is less than 5 minutes.

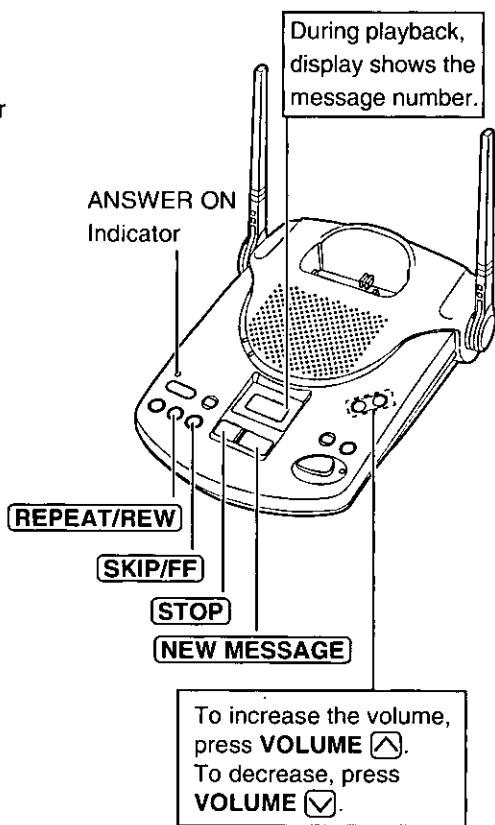

Flash Memory Message Backup

Messages are stored indefinitely on a "flash memory" IC chip and will not be affected by power failures. All messages are saved until you erase them.



During playback

To repeat/ rewind message	To repeat from the beginning of the message Press REPEAT/REW briefly. (If you press within 5 seconds of playback, the previous message will be played.) To rewind part of the message Press and hold REPEAT/REW until you reach the desired place. <ul style="list-style-type: none">• At the beginning of the message, 3 beeps will sound.
To skip/cue message	To skip to the next message Press SKIP/FF briefly. To cue to part of the message Press and hold SKIP/FF until you reach the desired place. <ul style="list-style-type: none">• The message will be heard at twice the normal speed.• At the end of the message, 3 beeps will sound.
To stop operation	Press STOP . <ul style="list-style-type: none">• To resume playback, press NEW MESSAGE.• If you do not press any button for 60 seconds or if you press STOP again, the unit will return to the stand-by mode.

For Caller ID service users (p. 32)

- During playback, when the handset is on the base unit, the handset display will show the name and/or number of the caller whose message is being played.

To call back the displayed number:

1. During playback, lift the handset.
2. Press **TALK** within 10 seconds.
 - The unit stops playback and automatically dials the displayed phone number.

- After listening to new incoming messages, “√” will be added to the call entries in the Caller ID Caller List (p. 35).

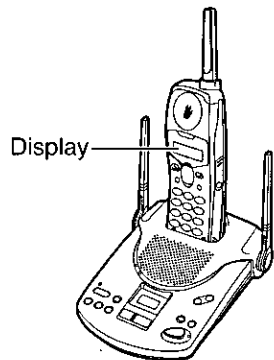

➔ Listening to Messages

From the Handset

If someone else is in the room and you want to listen to the recorded messages privately, you can use the handset.

1 Handset:
Press **PLAYBACK/PAUSE**.

- The number of new messages is heard on the handset.

2 Base unit:
To listen to new messages, press **NEW MESSAGE** briefly.

To listen to all messages, press and hold **NEW MESSAGE** until playback starts.

- The messages will be heard on the handset.
- **REPEAT/REW**, **SKIP/FF** and **STOP** can also be used during playback (p. 55).

3 When finished, press **PLAYBACK/PAUSE** or place the handset on the base unit.

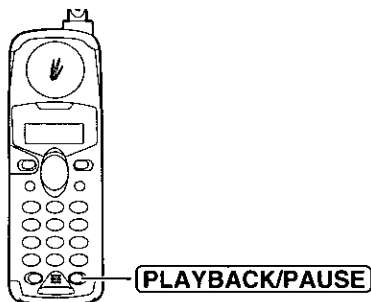

- You can also listen to messages without using the base unit. See page 70.

Erasing Messages

The unit will announce the remaining recording time after playback, if it is less than 5 minutes. New messages cannot be recorded when:

- "Memory full" is heard.
- "**FULL**" is displayed on the base unit.
- the ANSWER ON indicator flashes rapidly.

Erase some or all of the messages. We recommend you erase unnecessary messages after each playback.

Erasing a specific message

Press **ERASE** while the message you want to erase is being played.

- The unit erases the message.
- A short beep will sound and the unit will continue to play the next message.

Erasing all messages

All recorded messages, except the greeting message, can be erased at one time.

- 1 Press **ERASE**.
 - "Press ERASE again to erase all messages" is heard.
- 2 Within 5 seconds, press **ERASE** again.
 - A long beep sounds and "No messages" is heard. The base unit display shows "0".

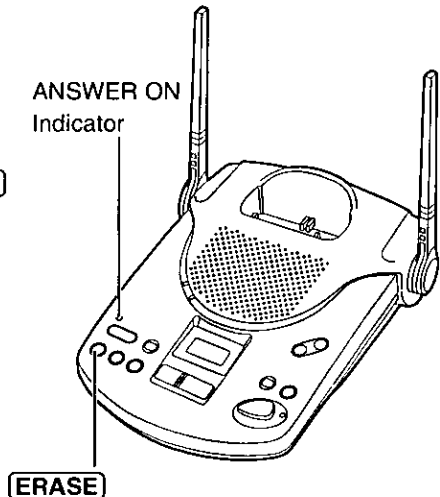

- The information in the caller list will not be erased. To erase the Caller List information, see page 39.

Pager Call

This feature allows you to alert your pager when the unit records an incoming message or receives a Caller ID call (p. 62). You can retrieve the message from a touch tone telephone (p. 64). If you subscribe to a Caller ID service, the caller's telephone number will be displayed on your pager. First program the following settings (p. 58–62), then set the unit to call the pager. **Make sure that the unit is in the stand-by mode.**

Storing a Pager Number

If you use a 1-800 pager number, see the next page for the storing procedure.

- 1 Press **FUNCTION/EDIT**.
- 2 Press **▼** or **▲** repeatedly until the arrow points to "Program".

Ringer volume
▶Program
∇∧ OK=Yes
- 3 Press **OK** **▶** (Yes key).

▶Save directory
Set flash time
∇∧ OK=Yes
- 4 Press **▼** or **▲** repeatedly until the arrow points to "TAD program", and press **OK** **▶** (Yes key).
 - "P" is displayed on the base unit.

Talk switching
▶TAD program
∇∧ OK=Yes
- 5 Press **#**.
 - "-" is displayed on the base unit.

Answering
system setting
{■■■■}
- 6 Enter your pager number, and press **PLAYBACK/PAUSE** twice.* Enter the access code, if required by your pager company, and press **PLAYBACK/PAUSE** twice again.*
 - The entered number is displayed on the base unit.
 - If you misdial, press **EXIT/CH** and start again from step 1.
 - You can enter a total of 44 digits.
- 7 Press **OK** **▶**.
 - A beep sounds.
 - The display will return to step 4. To return to the stand-by mode, press **EXIT/CH** or wait for 60 seconds.

* Pager companies require a delay after the pager number and/or the access code is dialed. Contact your pager company regarding the required pause time. Pressing **PLAYBACK/PAUSE** once creates a 3.5 second delay and counts as one digit.

- If the line has rotary or pulse service, press ***** between the pager number and **PLAYBACK/PAUSE** in step 6.



Storing a 1-800 pager number

If you use a 1-800 pager number with a PIN code, store the pager number as follows.

1 Press **FUNCTION/EDIT**.

```
▶Redial
  Directory
v^      OK=Yes
```

2 Press **▼** or **▲** repeatedly until the arrow points to "Program".

```
Ringer volume
▶Program
v^      OK=Yes
```

3 Press **OK** **▶** (Yes key).

```
▶Save directory
  Set flash time
v^      OK=Yes
```

4 Press **▼** or **▲** repeatedly until the arrow points to "TAD program".

```
Talk switching
▶TAD program
v^      OK=Yes
```

5 Press **OK** **▶** (Yes key).
• "P" is displayed on the base unit.

```
Answering
system setting
  [■■■■]
```

6 Press **#**.
• "-" is displayed on the base unit.

7 ① Enter the 1-800 pager number, and press **PLAYBACK/PAUSE** 3 times.*

② Enter the PIN code, and press **PLAYBACK/PAUSE** twice.*

- If you misdial, press **EXIT/CH** and start again from step 1.
- You can enter a total of 44 digits.

8 Press **OK** **▶**.
• A beep sounds.
• The display will return to step 4. To return to the stand-by mode, press **EXIT/CH** or wait for 60 seconds.

* Pager companies require a delay after the pager number and the PIN code are dialed. Contact your pager company regarding the required pause time. Pressing **PLAYBACK/PAUSE** once creates a 3.5 second delay and counts as one digit.

- If the line has rotary or pulse service, press ***** between the pager number and **PLAYBACK/PAUSE** in step 7.
- Alphanumeric voice dispatch pager services will not work with this function.

Storing Your Home Telephone Number

After storing your home telephone number, it will then be displayed on your pager when your family wants you to call home. (See useful information on page 61.)

1 Press **FUNCTION/EDIT**.

```
▶Redial
  Directory
  v^      OK=Yes
```

2 Press **▼** or **▲** repeatedly until the arrow points to "Program".

```
Ringer volume
▶Program
  v^      OK=Yes
```

3 Press **OK** **▶** (Yes key).

```
▶Save directory
  Set flash time
  v^      OK=Yes
```

4 Press **▼** or **▲** repeatedly until the arrow points to "TAD program".

```
Talk switching
▶TAD program
  v^      OK=Yes
```

5 Press **OK** **▶** (Yes key).
• "P" is displayed on the base unit.

```
Answering
system setting
      [||||]
```

6 Press **7**.
• "-" is displayed on the base unit.

7 Enter your home telephone number up to 10 digits.
• The entered number is displayed on the base unit.
• If you misdial, press **EXIT/CH** and start again from step 1.

8 Press **OK** **▶**.
• A beep sounds.
• The display will return to step 4. To return to the stand-by mode, press **EXIT/CH** or wait for 60 seconds.

• Your pager will also display your home number if the unit receives a call from an area which does not provide the Caller ID service or the caller requests not to show their information. Please call home to check who alerted your pager.



To confirm the stored pager and home numbers

Press **TALK** ➔ **FUNCTION/EDIT** ➔ **#**.

- The unit dials the stored pager number.
- The pager beeps, and displays your home number and “11”*.
- If the pager does not beep or does not display your home number and “11”, store the pager and home numbers again (p. 58–60).

Useful Information

Your family can let you know when they want you to call home by pressing **TALK** ➔ **FUNCTION/EDIT** ➔ **#**.

* What “11” means

When your unit alerts your pager, “11” will be displayed after the caller’s telephone number. “11” will not be displayed when another phone alerts your pager.

Ex. If the unit records a caller’s message whose number is “2345678”:

“234567811” will be displayed on your pager. If you select pager mode “2” (p. 62) and a caller does not leave a message, “00” will be displayed instead of “11”.

Ex. If the caller whose number is “2345678” alerts your pager directly:

“2345678” will be displayed on your pager.

To erase the stored pager number

1. Press **FUNCTION/EDIT**.
2. Press **▼** or **▲** to select “Program”, and press **OK** **▶**.
3. Press **▼** or **▲** to select “TAD program”, and press **OK** **▶**.
4. Press **#**.
5. Press **OK** **▶**.
6. Press **EXIT/CH**.

- The pager call mode will automatically return to OFF (p. 63).

To erase the stored home telephone number

Repeat steps 1 to 6 on page 60 ➔ press **OK** **▶** ➔ press **EXIT/CH**.

Pager Mode Setting

After subscribing to a Caller ID service (p. 32), you can select one of the following pager mode settings. The unit will alert your pager:

1. After the unit records an incoming message (factory preset),
OR
2. Each time the unit receives a Caller ID call, even if the caller does not leave a message.

If you want to change the mode, proceed as follows.

- 1 Press **FUNCTION/EDIT**.

▶Redial Directory v^ OK=Yes

- 2 Press **▼** or **▲** repeatedly until the arrow points to "Program".

Ringer volume ▶Program v^ OK=Yes
--
- 3 Press **OK** **▶** (Yes key).

▶Save directory Set flash time v^ OK=Yes
--
- 4 Press **▼** or **▲** repeatedly until the arrow points to "TAD program".

Talk switching ▶TAD program v^ OK=Yes

- 5 Press **OK** **▶** (Yes key).
 - "P" is displayed on the base unit.

Answering system setting {■■■■}

- 6 Press **6**.
 - The current setting is displayed on the base unit.
- 7 To select "2", press **2**.
OR
To select "1", press **1**.
 - The entered number is displayed on the base unit.
- 8 Press **OK** **▶**.
 - A beep sounds.
 - The display will return to step 4. To return to the stand-by mode, press **EXIT/CH** or wait for 60 seconds.

- If you select "2" and set the unit to call a pager (p. 63), the unit will alert your pager even if the answering system is not turned on.
- Even if you select "2", the unit will not alert your pager if a Caller ID call which does not have a phone number is received.

Setting the Unit to Call a Pager

- 1 Press **PLAYBACK/PAUSE**.
 - The number of new messages is heard on the handset.
- 2 Press **3**.
 - “**PAGER**” is displayed on the base unit.
 - If “**PAGER**” is not displayed, the pager number has not been stored. Store the number (p. 58, 59), and try again.
- 3 Press **PLAYBACK/PAUSE**.

To turn off the pager call mode, repeat steps 1 through 3.

- “**PAGER**” will disappear.
- Each time you press **3** in step 2, the mode will turn on or off.

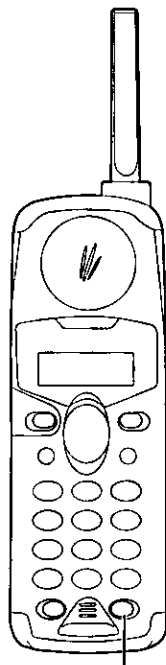

PLAYBACK/PAUSE

If you have not subscribed to a Caller ID service, the caller's telephone number will not be displayed on your pager.

- If another message (or Caller ID call) is received before the unit alerts your pager for a previous message (or Caller ID call), the previous caller information will not be sent to your pager. Only the last call received will be sent to your pager.
- If someone else makes or answers another call with the unit or a parallel connected phone before the unit alerts your pager for a previous message (or Caller ID call), the unit will stop alerting your pager for that message (or Caller ID call).
- If you receive a telephone number on your pager but cannot recognize the caller, you may have received a direct inward dial (DID) call, such as from a PBX. Please call your unit to check the caller's message.

Remote Operation from a Touch Tone Phone

You can operate the answering system from any touch tone phone. A synthesized voice menu will guide you on how to operate the unit (p. 66).

- To skip the voice menu and operate the unit directly, see page 68.

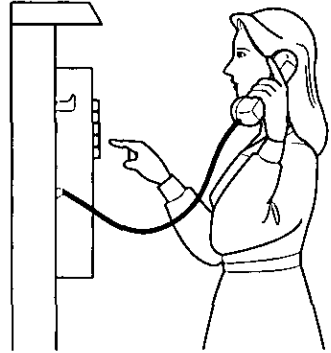

Summary of remote operation

Call your unit from a touch tone phone.



Enter your remote code (p. 65) during or after the greeting message.

- The number of new messages is heard.



After 3 seconds, the voice menu will start (p. 66).
Follow the menu or enter the direct commands (p. 68).



To end remote operation, hang up.

- The messages are saved.

- The unit will announce the remaining recording time after playback, if it is less than 5 minutes.



Setting the Remote Code

The remote code prevents unauthorized people from accessing your unit and listening to your messages. Choose any **2-digit number (00–99)**.

The factory preset remote code is “11”. If you do not program your own remote code, you can use “11”.

Make sure that the unit is in the stand-by mode.

1 Press **FUNCTION/EDIT**.

▶Redial
Directory
√∧ OK=Yes

2 Press **▼** or **▲** repeatedly until the arrow points to “Program”.

Ringer volume
▶Program
√∧ OK=Yes

3 Press **OK** **▶** (Yes key).

▶Save directory
Set flash time
√∧ OK=Yes

4 Press **▼** or **▲** repeatedly until the arrow points to “TAD program”.

Talk switching
▶TAD program
√∧ OK=Yes

5 Press **OK** **▶** (Yes key).
• “P” is displayed on the base unit.

Answering
system setting
{■■■■}

6 Press **1**.
• The current remote code is displayed on the base unit.

7 Enter a remote code using a **2-digit number (00–99)**.
• The entered number is displayed on the base unit.

8 Press **OK** **▶**.
• A beep sounds.
• The display will return to step 4. To return to the stand-by mode, press **EXIT/CH** or wait for 60 seconds.

• If 6 beeps sound during programming, a wrong key was pressed. Enter the correct number.

To check the remote code

Repeat steps 1 to 6.

• The current remote code is displayed on the base unit. When finished, press **EXIT/CH**.

➔ Remote Operation from a Touch Tone Phone

Voice Menu

The shaded boxes are voice prompts.

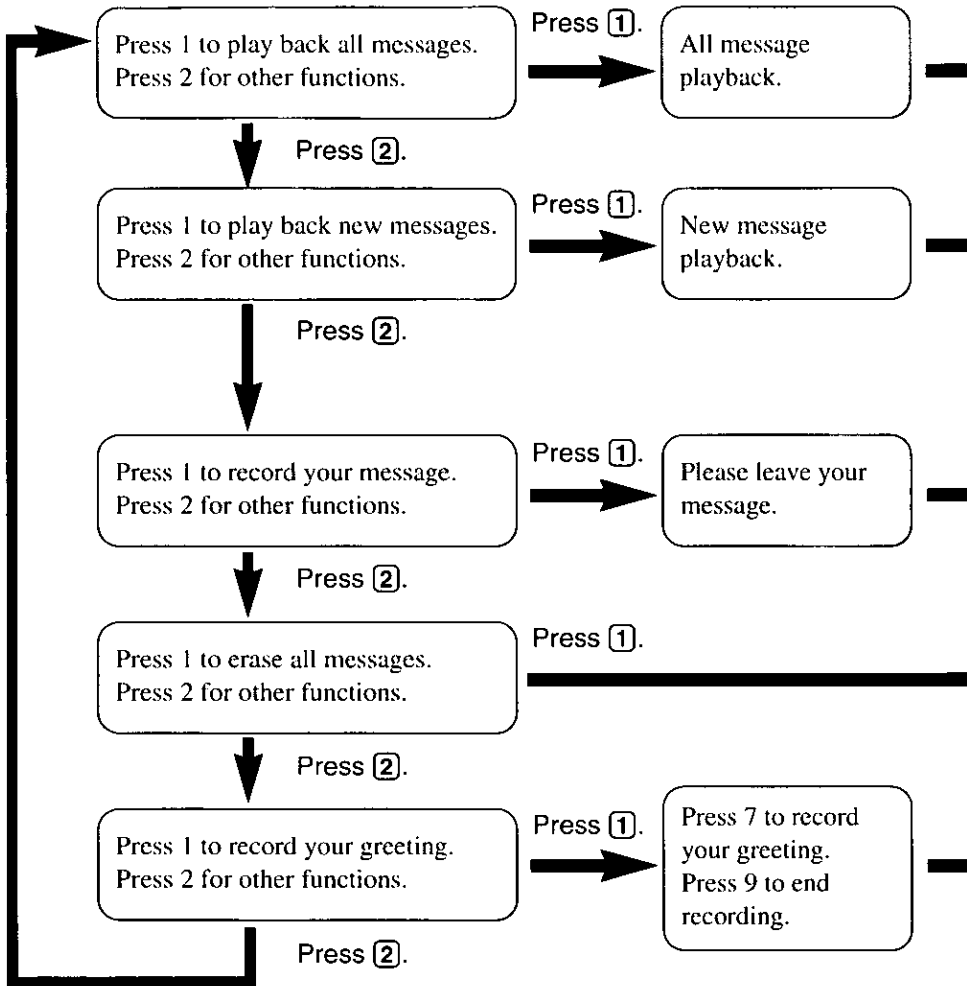



All Message Playback

All recorded messages are played back. At the end of the last message, "End of final message" is heard. The unit will announce the remaining recording time if it is less than 5 minutes.

New Message Playback

Only new messages are played back. At the end of the last message, "End of final message" is heard. The unit will announce the remaining recording time if it is less than 5 minutes.

Recording a Memo Message

You can leave a personal message.

1. Talk after you hear "Please leave your message."
2. When you finish recording, hang up.

Erase All Messages

All recorded messages (except greeting message) are erased.

Recording a Greeting Message

You can re-record your greeting message.

1. Press **[7]**.
You will hear a voice prompt followed by a long beep.
2. After the beep, talk for up to 2 minutes.
3. When you finish recording, press **[9]**.
4. Your greeting will be played back for confirmation.

- 3 seconds after playback, the voice menu will start again from the beginning.
- If you hear "Memory full" after playback, erase some or all of the messages (p. 68).

➔ Remote Operation from a Touch Tone Phone

Direct Remote Operation

Once you have entered the remote code, you can also control your unit by direct commands instead of using the voice menu. To end the remote operation, hang up anytime.

Direct commands

NEW MESSAGE PLAYBACK	4	<ul style="list-style-type: none">• Only new messages are played back.
-------------------------	----------	--

ALL MESSAGE PLAYBACK	5	<ul style="list-style-type: none">• All messages are played back.
-------------------------	----------	---

REPEAT (During playback)	1	<ul style="list-style-type: none">• The current message is repeated.
-----------------------------	----------	--

SKIP (During playback)	2	<ul style="list-style-type: none">• The current message is skipped. The next message is played.
---------------------------	----------	---

STOP	9	<ul style="list-style-type: none">• Operation is stopped temporarily.• To resume operation, enter a direct command within 15 seconds, or the voice menu will start.
------	----------	--

GREETING MESSAGE RECORDING	7	<ul style="list-style-type: none">• A long beep sounds.
	↓ RECORD	<ul style="list-style-type: none">• After the beep, talk immediately for up to 2 minutes.
	↓ 9	<ul style="list-style-type: none">• The recording is stopped.• The recorded message is played.

ERASING A SPECIFIC MESSAGE (During playback)	* 4	<ul style="list-style-type: none">• The current message is erased.• A short beep will sound and the next message will be played.
---	------------	---

ERASING ALL MESSAGES	* 5	<ul style="list-style-type: none">• All recorded messages are erased.• A long beep sounds and "No messages" is heard.
-------------------------	------------	--

PAGER CALL
ON/OFF

3

- Each time you press **3**, "on/off" is heard and the mode will turn on or off.
- If you have not stored a pager number, 6 beeps will sound and the mode will not turn on.

ANSWERING
SYSTEM OFF

0

- The unit hangs up and will not answer calls until turned on again.
-

Turning on the answering system

Call your unit and wait for 15 rings.

- The unit will answer and the greeting message will be played.
- The answering system will turn on. Hang up or enter the remote code for other options.
- When turning on the answering system using a rotary or pulse service telephone, you cannot enter the remote code for other options.

Skipping the greeting message

After calling your unit, press ***** during the greeting message.

- The unit skips the rest of the greeting message and you can start recording your message after the long beep.

Remote Operation with the Handset

You can operate your answering system with the handset.

The announcements and recorded messages can only be heard with the handset.

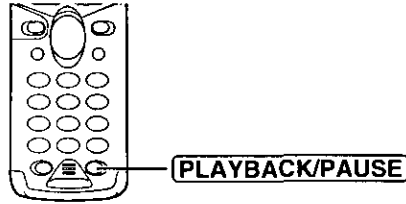

Summary of remote operation

Press **PLAYBACK/PAUSE**.

- The number of new messages is heard.
- "Remote operation" is displayed on the handset.



Enter the desired direct commands (p. 71).

- If you do not enter a command, the voice menu below will start.
- After the voice menu, all message playback will start.



To end remote operation, press **PLAYBACK/PAUSE**.

- The messages are saved.

- The unit will announce the remaining recording time after playback, if it is less than 5 minutes.
- If the unit starts to ring during the remote operation, press **TALK** to answer the call. The remote operation is ended.
- If you hear "Memory full" after playback, erase some or all of the messages (p. 71).

Voice menu

If no commands are entered after you press **PLAYBACK/PAUSE**, the unit will start the following voice menu.

"Press 4 to play back new messages; Press 5 to play back all messages."

- You can enter direct commands even if the voice menu has started.

Direct commands

NEW MESSAGE
PLAYBACK

4

- Only new messages are played back.

ALL MESSAGE
PLAYBACK

5

- All messages are played back.

REPEAT
(During playback)

1

- The current message is repeated.

SKIP
(During playback)

2

- The current message is skipped.
The next message is played.

STOP

9

- Operation is stopped temporarily.
- To resume operation, enter a direct command within 15 seconds, or the voice menu will start (p. 70).

ERASING A
SPECIFIC
MESSAGE
(During playback)

✖

4

- The current message is erased.
- A short beep will sound and the next message will be played.

ERASING ALL
MESSAGES

✖

5

- All recorded messages are erased.
- A long beep sounds and "No messages" is heard.

PAGER CALL
ON/OFF

3

- Each time you press **3**, the mode will turn on or off.
- If you have not stored a pager number, "**PAGER**" will not be displayed on the base unit and the mode will not turn on.

ANSWERING
SYSTEM OFF

0

- "Answer off" is heard and the answering system is turned off.

ANSWERING
SYSTEM ON

8

- "Answer set" is heard and the answering system is turned on.
-

Using the Belt Clip

You can hang the handset on your belt or pocket using the belt clip.

To attach the belt clip

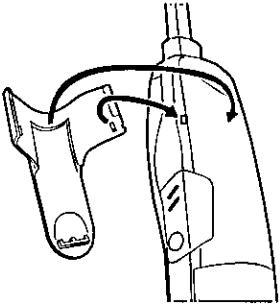

To remove the belt clip

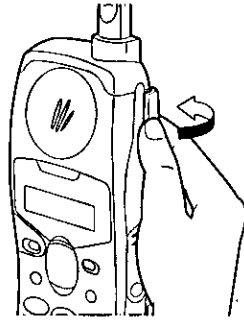

Using an Optional Headset

Plugging an optional headset into the handset allows a hands-free phone conversation. Please use only a Panasonic KX-TCA80 or KX-TCA90 headset. To order, call the accessories telephone number on page 2.

Connecting the headset to the handset

Open the headset jack cover, and connect the optional headset to the headset jack as shown.

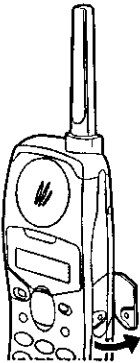

The illustration headset is a KX-TCA90.

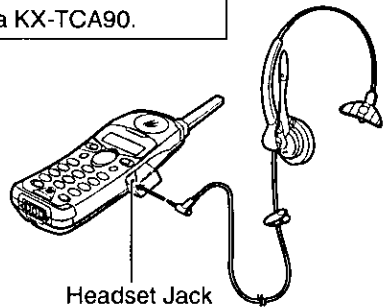

When the optional headset is connected to the handset, be sure to use the headset to talk with the caller. If you want to have a normal cordless phone conversation, disconnect the headset.

Battery Replacement

If "Recharge" is displayed and/or "[■]" flashes after being fully charged, replace the battery with a new Panasonic HHR-P401 battery. To order, call the accessories telephone number on page 2. To avoid memory loss, replace within 3 minutes.

- 1 Lay the handset on a flat surface. **Carefully** insert a flat metal object and turn **slowly** to remove the cover.

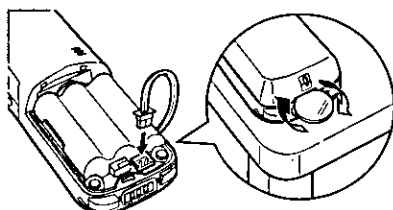

- 2 Replace the battery, and close the cover.

- 3 Be sure to charge the new battery for about 7 hours in order to display the battery strength prompt correctly (p. 12).

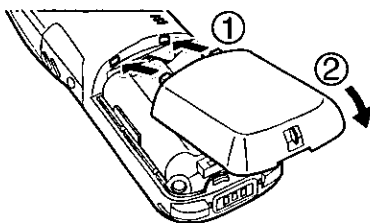

Adding Another Phone

This unit will not function during a power failure. To connect a standard telephone on the same line, use the Panasonic T-adaptor KX-J66. To order, call the accessories telephone number on page 2.

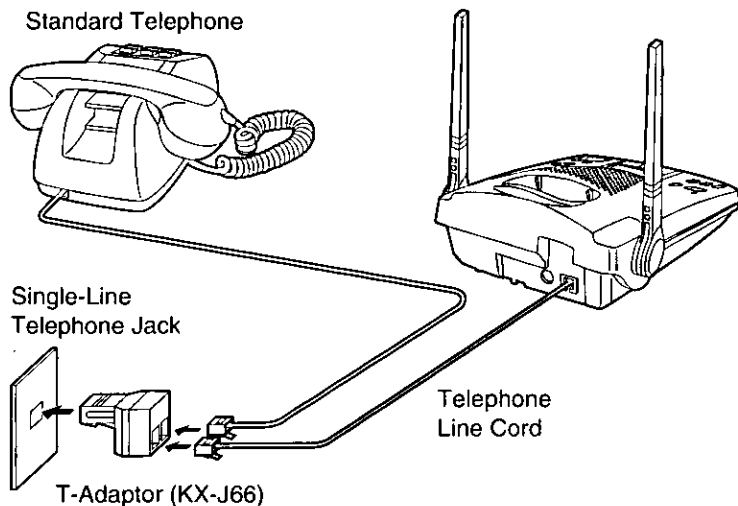

Before Requesting Help

Cordless Telephone

Problem	Remedy
"Out of range" is displayed and an alarm tone sounds.	<ul style="list-style-type: none">• You are too far from the base unit. Move closer and try again.• Place the handset on the base unit and try again.• Plug in the AC adaptor.• Raise the base unit antennas.
Static, sound cuts in/out, fades. Interference from other electrical units.	<ul style="list-style-type: none">• Locate the handset and the base unit away from other electrical appliances (p. 3).• Move closer to the base unit.• Raise the base unit antennas.• Press EXIT/CH to select a clearer channel.
The handset does not ring.	<ul style="list-style-type: none">• The ringer volume is set to OFF. Set to HIGH or LOW (p. 20).
The base unit does not ring.	<ul style="list-style-type: none">• The ringer volume is set to OFF. Press HOLD/RINGER while the unit is in the stand-by mode (p. 20).
The handset display is blank.	<ul style="list-style-type: none">• The handset is in the stand-by mode (p. 13). Press ▼ or ▲ to turn the display on.
The handset display is still blank after pressing ▼ or ▲ .	<ul style="list-style-type: none">• Charge the battery fully (p. 12).
You cannot program items, such as the dialing mode.	<ul style="list-style-type: none">• Programming is not possible while the unit is in the talk, speakerphone or intercom mode, or while the answering system is in use.• Do not pause for over 60 seconds while programming.• ▼ or ▲ may have been pressed when you picked up the handset. Press EXIT/CH, and try again.



Problem	Remedy
You cannot store a name and phone number in the directory.	<ul style="list-style-type: none">• You cannot store an item in the directory while the unit is in the talk or intercom mode.• Do not pause for over 60 seconds while storing.
While programming or searching, the unit starts to ring and stops the program/search.	<ul style="list-style-type: none">• To answer the call, press TALK or DIGITAL SP-PHONE. Start again from the beginning after hanging up.
The unit does not display the caller's name and/or phone number.	<ul style="list-style-type: none">• Other telephone equipment may be interfering with your phone. Disconnect it and try again.• Other electrical appliances connected to the same outlet may be interfering with the Caller ID information.• Telephone line noise may be affecting the Caller ID information.
The handset display goes to the stand-by mode while viewing the Caller List.	<ul style="list-style-type: none">• Do not pause for over 60 seconds while searching.• DIGITAL SP-PHONE was pressed.

➔ Before Requesting Help

Problem	Remedy
When a second call is received during a conversation, the unit does not display the new caller's name and/or phone number.	<ul style="list-style-type: none">• The line mode selection is incorrect. See page 15.
LOCATOR/INTERCOM on the base unit does not function.	<ul style="list-style-type: none">• The handset is too far from the base unit.• The handset is engaged in an outside call or is viewing the Caller List. Wait until the IN USE/CHARGE indicator light goes out.
You cannot redial the last number dialed.	<ul style="list-style-type: none">• If the last number dialed was more than 32 digits long, the number will not be redialed.• Access numbers entered after pressing TONE will not be included when redialing.
You cannot have a conversation using the headset.	<ul style="list-style-type: none">• When the headset is connected (p. 72), you must use the headset to talk with the caller. To have a normal cordless phone conversation, disconnect the headset.
You cannot have a conversation using the headset.	<ul style="list-style-type: none">• Make sure that the headset is plugged into the headset jack properly (p. 72).



Answering system

Problem	Remedy
The answering system is on, but incoming messages are not recorded.	<ul style="list-style-type: none">• The recording time is set to "greeting only". Select "1 minute" or "3 minutes" (p. 26).• Memory is full. Erase some or all of the messages (p. 57).
You cannot listen to the recorded messages.	<ul style="list-style-type: none">• Make sure that the unit is in the stand-by mode.
" FULL " is displayed and the ANSWER ON indicator flashes rapidly, and no new messages are recorded.	<ul style="list-style-type: none">• Memory is full. Erase some or all of the messages (p. 57).
You cannot operate the answering system at the base unit.	<ul style="list-style-type: none">• The handset user is operating the answering system or is engaged in an outside call. Wait until the IN USE/CHARGE indicator light goes out.
You cannot operate the answering system from a touch tone phone.	<ul style="list-style-type: none">• Make sure you enter the correct remote code.• The answering system may not respond if the tones are too short to activate the unit. Press each button firmly.• The answering system is off. Turn it on (p. 69).
You cannot operate the answering system with the handset.	<ul style="list-style-type: none">• Someone is operating the answering system.• You are too far from the base unit. Move closer to the base unit.• The unit is recording a message. To answer the call, press TALK.

➔ Before Requesting Help

Problem	Remedy
While recording a greeting message, the unit starts to ring and stops recording.	<ul style="list-style-type: none">• To answer the call, press DIGITAL SP-PHONE or press TALK. The recording will stop. Start from the beginning after hanging up.
While using the answering system at the base unit, it suddenly stops.	<ul style="list-style-type: none">• The handset user pressed TALK. Wait until the IN USE/CHARGE indicator goes out.
During playback, the unit starts to ring and stops playback.	<ul style="list-style-type: none">• To answer the call, press DIGITAL SP-PHONE or press TALK. To resume playback, press NEW MESSAGE after hanging up.
The handset does not display the name and/or number of the caller whose message is being played.	<ul style="list-style-type: none">• Place the handset on the base unit correctly (p. 55).• If the caller is not stored in the caller list, the handset will not display the caller's information.
The unit does not alert your pager.	<ul style="list-style-type: none">• The line mode selection is incorrect. See page 15.

General

Problem	Remedy
The unit does not work.	<ul style="list-style-type: none">• Check the settings (p. 11–15).• Charge the battery fully (p. 12).• Clean the charge contacts and charge again (p. 13).• Install the battery properly (p. 73).• Place the handset on the base unit and unplug the AC adaptor to reset. Plug in and try again.• Re-install the battery within 3 minutes to avoid loss of memory and place the handset on the base unit. Try again.
You cannot program items, such as the time/day adjustment (p. 23).	<ul style="list-style-type: none">• Programming is not possible while the unit is in the talk, speakerphone or intercom mode, or while the answering system is in use.• Move closer to the base unit.
Previously programmed information is erased.	<ul style="list-style-type: none">• If a power failure occurs, programmed information may be erased. Reprogram if necessary.
"Recharge" is displayed, "[■]" flashes or the unit beeps intermittently.	<ul style="list-style-type: none">• Charge the battery fully (p. 12).
You charged the battery fully, but "Recharge" is still displayed and/or "[■]" continues to flash.	<ul style="list-style-type: none">• Clean the charge contacts and charge again (p. 12, 13).• Install a new battery (p. 73).
The IN USE/CHARGE indicator light does not go out while charging.	<ul style="list-style-type: none">• This is normal.
If you cannot solve your problem	<ul style="list-style-type: none">• Call our customer call center at 1-800-211-PANA(7262).

Important Safety Instructions

When using this unit, basic safety precautions should always be followed to reduce the risk of fire, electric shock, or personal injury.

1. Read and understand all instructions.
2. Follow all warnings and instructions marked on this unit.
3. Unplug this unit from AC outlets before cleaning. Do not use liquid or aerosol cleaners. Use a damp cloth for cleaning.
4. Do not use this unit near water, for example, near a bathtub, washbowl, kitchen sink, or the like.
5. Place this unit securely on a stable surface. Serious damage and/or injury may result if the unit falls.
6. Do not cover slots and openings on the unit. They are provided for ventilation and protection against overheating. Never place the unit near radiators, or in a place where proper ventilation is not provided.
7. Use only the power source marked on the unit. If you are not sure of the type of power supplied to your home, consult your dealer or local power company.
8. Do not place objects on the power cord. Install the unit where no one can step or trip on the cord.
9. Do not overload wall outlets and extension cords. This can result in the risk of fire or electric shock.
10. Never push any objects through slots in this unit. This may result in the risk of fire or electric shock. Never spill any liquid on the unit.
11. To reduce the risk of electric shock, do not disassemble this unit. Take the unit to an authorized servicer when service is required. Opening or removing covers may expose you to dangerous voltages or other risks. Incorrect reassembly can cause electric shock when the unit is subsequently used.
12. Unplug this unit from the wall outlet and refer servicing to an authorized servicer when the following conditions occur:
 - A. When the power supply cord or plug is damaged or frayed.
 - B. If liquid has been spilled into the unit.
 - C. If the unit has been exposed to rain or water.
 - D. If the unit does not work normally by following the operating instructions. Adjust only controls covered by the operating instructions. Improper adjustment may require extensive work by an authorized servicer.
 - E. If the unit has been dropped or physically damaged.
 - F. If the unit exhibits a distinct change in performance.
13. During thunderstorms, avoid using telephones except cordless types. There may be a remote risk of an electric shock from lightning.
14. Do not use this unit to report a gas leak, when in the vicinity of the leak.

SAVE THESE INSTRUCTIONS

CAUTION:

To reduce the risk of fire or injury to persons, read and follow these instructions.

1. Use only the battery(ies) specified.
2. Do not dispose of the battery(ies) in a fire. They may explode. Check with local waste management codes for special disposal instructions.
3. Do not open or mutilate the battery(ies). Released electrolyte is corrosive and may cause burns or injury to the eyes or skin. The electrolyte may be toxic if swallowed.
4. Exercise care in handling batteries in order not to short the battery to conductive materials such as rings, bracelets, and keys. The battery and/or conductor may overheat and cause burns.
5. Charge the battery(ies) provided with or identified for use with this product only in accordance with the instructions and limitations specified in this manual.

WARNING:

TO PREVENT FIRE OR SHOCK HAZARD, DO NOT EXPOSE THE BASE UNIT TO RAIN OR ANY TYPE OF MOISTURE. ONLY THE HANDSET IS SHOCK AND SPLASH RESISTANT.

Splash-Resistant (HANDSET ONLY)

The handset is designed to be splash resistant. You can use the handset with wet hands.

CAUTION:

- Do not immerse in water or leave under running water.
- Keep the handset away from salt water.
- Avoid exposure to prolonged high humidity.
- Since water in headset jack may cause damage, close the headset jack cover when the optional headset is not in use. When the optional headset is connected, do not use the handset with wet hands.
- If the handset is wet, wipe with a soft dry cloth.
- The base unit is not designed to be splash resistant. Do not place the wet handset on the base unit.

Shock-Resistant (HANDSET ONLY)

Although the handset is designed to be shock resistant, do not throw or step on the handset.

FCC and Other Information

If requested by the telephone company, inform them as follows:

FCC Registration No.(found on the bottom of the unit)

Ringer Equivalence0.1B

The particular telephone line to which the equipment is connected.

This unit must not be connected to a coin operated line.

If you are on a party line, check with your local telephone company.

Ringer Equivalence No. (REN):

The REN is useful in determining the quantity of devices you may connect to your telephone line and still have all of those devices ring when your telephone number is called. In most, but not all areas, the sum of the REN's of all devices connected to one line should not exceed five (5.0). To be certain of the number of devices you may connect to your line, as determined by the REN, you should contact your local telephone company to determine the maximum REN for your calling area.

In the event terminal equipment causes harm to the telephone network, the telephone company should notify the customer, if possible, that service may be stopped.

However, where prior notice is impractical, the company may temporarily cease service providing that they:

- (a) Promptly notify the customer.
- (b) Give the customer an opportunity to correct the problem with their equipment.
- (c) Inform the customer of the right to bring a complaint to the Federal Communication Commission pursuant to procedures set out in FCC Rules and Regulations Subpart E of Part 68.

The Telephone Company may make changes in its communications facilities, equipment, operations or procedures, where such action is reasonably required in the operation of its business and is not inconsistent with the rules and regulations in FCC Part 68.

If such changes can be reasonably expected to render any customer terminal equipment incompatible with telephone company communications facilities, or require modification or alteration of such terminal equipment, or otherwise materially affect its use or performance, the customer shall be given adequate notice in writing, to allow the customer an opportunity to maintain uninterrupted service.

When programming emergency numbers and/or making test calls to emergency numbers:

1. Remain on the line and briefly explain to the dispatcher the reason for the call before hanging up.
2. Perform such activities in the off-peak hours, such as early morning hours or late evenings.

This device complies with Part 15 of the FCC Rules. Operation is subject to the following two conditions: (1) This device may not cause harmful interference, and (2) this device must accept any interference received, including interference that may cause undesired operation.

CAUTION:

Any changes or modifications not expressly approved by the party responsible for compliance could void the user's authority to operate this device.

Note:

This equipment has been tested and found to comply with the limits for a Class B digital device, pursuant to Part 15 of the FCC Rules. These limits are designed to provide reasonable protection against harmful interference in a residential installation. This equipment generates, uses, and can radiate radio frequency energy and, if not installed and used in accordance with the instructions, may cause harmful interference to radio communications. However, there is no guarantee that interference will not occur in a particular installation. If this equipment does cause harmful interference to radio or television reception, which can be determined by turning the equipment off and on, the user is encouraged to try to correct the interference by one or more of the following measures:

- Reorient or relocate the receiving antenna.
- Increase the separation between the equipment and receiver.
- Connect the equipment into an outlet on a circuit different from that to which the receiver is connected.
- Consult the dealer or an experienced radio/TV technician for help.

Some cordless telephones operate at frequencies that may cause interference to nearby TVs and VCRs. To minimize or prevent such interference, the base of the cordless telephone should not be placed near or on top of a TV or VCR. If interference is experienced, move the cordless telephone further away from the TV or VCR. This will often reduce or eliminate interference.

Operating near 2.4GHz electrical appliances may cause interference. Move away from the electrical appliances and/or press the CH (Channel) button.

- **Environment** — do not place the unit in a room where the temperature is less than 5°C (41°F) or greater than 40°C (104°F). Allow 10 cm (4") clearance around the unit for proper ventilation. Avoid excessive smoke, dust, mechanical vibration, shock, or direct sunlight.
- **Medical** — consult the manufacturer of any personal medical devices, such as pacemakers, to determine if they are adequately shielded from external RF (radio frequency) energy. (The unit operates in the frequency range of 904MHz to 925MHz and 2406MHz to 2478MHz, and the power output level can range from 0.02 watts to 0.40 watts.) Do not use the unit in health care facilities if any regulations posted in the area instruct you not to do so. Hospitals or health care facilities may be using equipment that could be sensitive to external RF (radio frequency) energy.
- **Routine care** — wipe the unit with a soft cloth. Do not use benzine, thinner, or any abrasive powder. When you leave the unit unused for a long period of time, unplug the AC adaptor from the outlet.
- **If there is any trouble** — disconnect the unit from the telephone line and connect a known working phone. If the known working phone operates properly, have your unit repaired by one of the authorized Panasonic Factory Service Centers. If the known working phone does not operate properly, consult your telephone company.

For product service

- Panasonic Servicenters are listed in the servicenter directory.
- Call 1-800-211-PANA(7262) for the location of an authorized servicenter.

When you ship the product

- Carefully pack your unit, preferably in the original carton.
- Attach a letter, detailing the symptom, to the outside of the carton.

Symptom

- Send the unit to an authorized servicenter, prepaid and adequately insured.
- Do not send your unit to the Panasonic Consumer Electronics Company listed below or to executive or regional sales offices. These locations do not repair consumer products.

- This cordless telephone is designed for use in the United States of America. Sale or use of this product in other countries may violate local laws.
- Ce téléphone sans fil est conçu pour être utilisé aux États-Unis d'Amérique. La vente ou l'emploi de cet appareil dans certains autres pays peut constituer une infraction à la législation locale.
- Este teléfono sin cordón fue elaborado para uso en los Estados Unidos de América. La venta o el empleo de este producto en ciertos países puede constituir violación de la legislación local.
- このコードレス電話機は、日本国外での使用を目的として設計されており、日本国内での使用は法律違反となります。従って、当社では日本国内においては原則として修理などのサービスは致しかねます。

**Panasonic Consumer Electronics Company,
Division of Matsushita Electric Corporation of America**
One Panasonic Way, Secaucus, New Jersey 07094

**Panasonic Sales Company,
Division of Matsushita Electric of Puerto Rico, Inc.**
Ave. 65 de Infantería, Km. 9.5, San Gabriel Industrial Park
Carolina, Puerto Rico 00985

Printed in Japan

PQQX12310YA SS0899ST1080

Free Manuals Download Website

<http://myh66.com>

<http://usermanuals.us>

<http://www.somanuals.com>

<http://www.4manuals.cc>

<http://www.manual-lib.com>

<http://www.404manual.com>

<http://www.luxmanual.com>

<http://aubethermostatmanual.com>

Golf course search by state

<http://golfingnear.com>

Email search by domain

<http://emailbydomain.com>

Auto manuals search

<http://auto.somanuals.com>

TV manuals search

<http://tv.somanuals.com>