

Panasonic®

Operating Instructions

2.4 GHz Digital Cordless Phone

Model No. **KX-TG3711BX/KX-TG3712BX**
KX-TG3719BX
KX-TG3711SX/KX-TG3712SX
KX-TG3811BX
KX-TG3811JX
KX-TG3811SX

2.4 GHz Digital Cordless Answering System

Model No. **KX-TG3721BX/KX-TG3722BX**
KX-TG3721SX/KX-TG3722SX
KX-TG3821BX
KX-TG3821JX/KX-TG3822JX
KX-TG3821SX

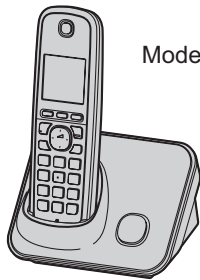

Model shown is KX-TG3711.

Before initial use, see "Getting Started" on page 9.

Thank you for purchasing a Panasonic product.

Please read these operating instructions before using the unit and save them for future reference.

This unit is compatible with Caller ID. You must subscribe to the appropriate service offered by your service provider/telephone company.

Please access our online customer survey:
<http://panasonic.net/pcc/tel/q>

Table of Contents

Introduction	
Model composition	3
Accessory information	5
Important Information	
For your safety	6
Important safety instructions	7
For best performance	7
Other information	8
Specifications	8
Getting Started	
Setting up	9
Note when setting up	11
Controls	12
Belt clip	15
Display	15
Initial settings	16
Making/Answering Calls	
Making calls	18
Answering calls	19
Useful features during a call	20
Dial lock	21
Power back-up operation	22
Phonebook	
Handset phonebook	24
Copying phonebook entries	26
Programming	
Programmable settings	27
Special programming	32
Caller ID Service	
Using Caller ID service	34
Caller list	34
Answering System	
Answering system	37
Turning the answering system on/off	37
Greeting message	38
Listening to messages using the base unit	38
Listening to messages using the handset	39
Remote operation	40
Answering system settings	41
Voice Mail Service	
Voice mail service	42
Intercom/Locator	
Intercom	43
Handset locator	43
Transferring calls, conference calls	44
Useful Information	
Wall mounting	45
Character entry	47
Error messages	49
Troubleshooting	50
Index	
Index	55

Introduction

Model composition

■ **KX-TG3711 series**

■ **KX-TG3721 series**

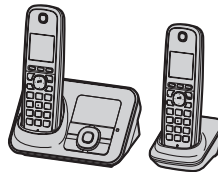
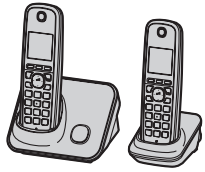

● Model shown is KX-TG3712.

● Model shown is KX-TG3722.

Series	Model No.	Base unit	Handset	Quantity
		Part No.	Part No.	
KX-TG3711 series	KX-TG3711BX	KX-TG3711BX	KX-TGA371BX	1
	KX-TG3712BX	KX-TG3711BX	KX-TGA371BX	2
	KX-TG3719BX	KX-TG3719BX	KX-TGA371BX	1
	KX-TG3711SX	KX-TG3711SX	KX-TGA371SX	1
	KX-TG3712SX	KX-TG3711SX	KX-TGA371SX	2
KX-TG3721 series	KX-TG3721BX	KX-TG3721BX	KX-TGA371BX	1
	KX-TG3722BX	KX-TG3721BX	KX-TGA371BX	2
	KX-TG3721SX	KX-TG3721SX	KX-TGA371SX	1
	KX-TG3722SX	KX-TG3721SX	KX-TGA371SX	2

Introduction

■ KX-TG3811 series

■ KX-TG3821 series

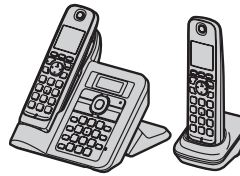



● Model shown is KX-TG3822.

Series	Model No.	Base unit	Handset	
		Part No.	Part No.	Quantity
KX-TG3811 series	KX-TG3811BX	KX-TG3811BX	KX-TGA381BX	1
	KX-TG3811JX	KX-TG3811JX	KX-TGA381JX	1
	KX-TG3811SX	KX-TG3811SX	KX-TGA381SX	1
KX-TG3821 series	KX-TG3821BX	KX-TG3821BX	KX-TGA381BX	1
	KX-TG3821JX	KX-TG3821JX	KX-TGA381JX	1
	KX-TG3822JX	KX-TG3821JX	KX-TGA381JX	2
	KX-TG3821SX	KX-TG3821SX	KX-TGA381SX	1

- The suffix (BX/JX/SX) in the following model numbers will be omitted in these instructions:
 KX-TG3711BX/KX-TG3712BX/KX-TG3719BX/KX-TG3721BX/KX-TG3722BX/
 KX-TG3711SX/KX-TG3712SX/KX-TG3721SX/KX-TG3722SX/KX-TG3811BX/
 KX-TG3821BX/KX-TG3811JX/KX-TG3821JX/KX-TG3822JX/KX-TG3811SX/KX-TG3821SX

Feature differences

Series	Answering system	Call using base unit ^{*1}	Base unit display ^{*2}	Headset jack	Intercom ^{*3}
					 ↔  ^{*4}
KX-TG3711 series	–	–	–	–	–
KX-TG3721 series	●	–	–	–	–
KX-TG3811 series	–	●	●	●	●
KX-TG3821 series	●	●	●	●	●

*1 A call can be made or answered with the base unit.

*2 Base unit display shows date and time, caller information, and messages recorded on the answering system.

*3 KX-TG3712/KX-TG3722/KX-TG3822

*4 Intercom calls can be made between the base unit and handset.

Introduction

Accessory information

Supplied accessories

No.	Accessory item/ Part number	Quantity			
		KX-TG3711 KX-TG3719 KX-TG3721	KX-TG3712 KX-TG3722	KX-TG3811 KX-TG3821	KX-TG3822
①	AC adaptor ^{*1}	1	2	1	2
②	Telephone line cord	1	1	1	1
③	Rechargeable batteries ^{*2}	2	4	2	4
④	Handset cover ^{*3}	1	2	1	2
⑤	Belt clip	–	–	1	2
⑥	Charger	–	1	–	1

*1 PNLV226BX: KX-TG3711BX/KX-TG3712BX/KX-TG3721BX/KX-TG3722BX/
KX-TG3811BX/KX-TG3821BX/KX-TG3811JX/KX-TG3821JX/KX-TG3822JX
PNLV226BX or PNLV226SX: KX-TG3711SX/KX-TG3712SX/KX-TG3721SX/
KX-TG3722SX/KX-TG3811SX/KX-TG3821SX
PNLV226E: KX-TG3719BX

*2 See page 5 for replacement battery information.

*3 The handset cover comes attached to the handset.

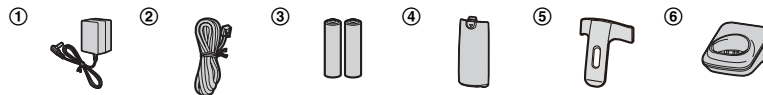

Additional/replacement accessories

Please contact your nearest Panasonic dealer for sales information.

Accessory item	Order number
Rechargeable batteries	HHR-4MRT ^{*1}
	Battery type: – Nickel metal hydride (Ni-MH) – 2 x AAA (R03) size for each handset
Headset	KX-TCA94EX ^{*2} , RP-TCA400, RP-TCA430

*1 Replacement batteries may have a different capacity from that of the supplied batteries.

*2 Not available for KX-TG3811SX/KX-TG3821SX.

Important Information

For your safety

To prevent severe injury and loss of life/property, read this section carefully before using the product to ensure proper and safe operation of your product.

WARNING

Power connection

- Use only the power source marked on the product.
- Do not overload power outlets and extension cords. This can result in the risk of fire or electric shock.
- Completely insert the AC adaptor/power plug into the power outlet. Failure to do so may cause electric shock and/or excessive heat resulting in a fire.
- Regularly remove any dust, etc. from the AC adaptor/power plug by pulling it from the power outlet, then wiping with a dry cloth. Accumulated dust may cause an insulation defect from moisture, etc. resulting in a fire.
- Unplug the product from power outlets if it emits smoke, an abnormal smell, or makes an unusual noise. These conditions can cause fire or electric shock. Confirm that smoke has stopped emitting and contact an authorized service center.
- Unplug from power outlets and never touch the inside of the product if its casing has been broken open.
- Never touch the plug with wet hands. Danger of electric shock exists.

Installation

- To prevent the risk of fire or electrical shock, do not expose the product to rain or any type of moisture.
- Do not place or use this product near automatically controlled devices such as automatic doors and fire alarms. Radio waves emitted from this product may cause such devices to malfunction resulting in an accident.

- Do not allow the AC adaptor or telephone line cord to be excessively pulled, bent or placed under heavy objects.

Operating safeguards

- Unplug the product from power outlets before cleaning. Do not use liquid or aerosol cleaners.
- Do not disassemble the product.
- Do not spill liquids (detergents, cleansers, etc.) onto the telephone line cord plug, or allow it to become wet at all. This may cause a fire. If the telephone line cord plug becomes wet, immediately pull it from the telephone wall jack, and do not use.
- The use of excessive sound volume through earphones, headphones, or headsets may cause hearing loss.
- Do not place a handset on the base unit with the headset jack cover opened.

Medical

- Consult the manufacturer of any personal medical devices, such as pacemakers or hearing aids, to determine if they are adequately shielded from external RF (radio frequency) energy. (The product operates in the frequency range of 2.40 GHz to 2.48 GHz, and the RF transmission power is 125 mW (max.)
- Do not use the product in health care facilities if any regulations posted in the area instruct you not to do so. Hospitals or health care facilities may be using equipment that could be sensitive to external RF energy.

CAUTION

Installation and location

- Never install telephone wiring during an electrical storm.
- Never install telephone line jacks in wet locations unless the jack is specifically designed for wet locations.
- Never touch uninsulated telephone wires or terminals unless the telephone line has been disconnected at the network interface.

Important Information

- Use caution when installing or modifying telephone lines.
- The AC adaptor is used as the main disconnect device. Ensure that the AC outlet is installed near the product and is easily accessible.
- This product is unable to make calls when:
 - the handset batteries need recharging or have failed.
 - there is a power failure.
- 2. Avoid using a telephone (other than a cordless type) during an electrical storm. There may be a remote risk of electric shock from lightning.
- 3. Do not use the telephone to report a gas leak in the vicinity of the leak.
- 4. Use only the power cord and batteries indicated in this manual. Do not dispose of batteries in a fire. They may explode. Check with local codes for possible special disposal instructions.

SAVE THESE INSTRUCTIONS

Battery

- We recommend using the batteries noted on page 5. **USE ONLY rechargeable Ni-MH batteries AAA (R03) size.**
- Do not mix old and new batteries.
- Do not open or mutilate the batteries. Released electrolyte from the batteries is corrosive and may cause burns or injury to the eyes or skin. The electrolyte is toxic and may be harmful if swallowed.
- Exercise care when handling the batteries. Do not allow conductive materials such as rings, bracelets, or keys to touch the batteries, otherwise a short circuit may cause the batteries and/or the conductive material to overheat and cause burns.
- Charge the batteries provided with or identified for use with this product only, in accordance with the instructions and limitations specified in this manual.
- Only use a compatible base unit (or charger) to charge the batteries. Do not tamper with the base unit (or charger). Failure to follow these instructions may cause the batteries to swell or explode.

Important safety instructions

When using your product, basic safety precautions should always be followed to reduce the risk of fire, electric shock, and injury to persons, including the following:

1. Do not use this product near water for example, near a bathtub, washbowl, kitchen sink, or laundry tub, in a wet basement or near a swimming pool.

For best performance

Base unit location/avoiding noise

The base unit and other compatible Panasonic units use radio waves to communicate with each other.

- For maximum coverage and noise-free communications, place your base unit:
 - at a convenient, high, and central location with no obstructions between the handset and base unit in an indoor environment.
 - away from electronic appliances such as TVs, radios, personal computers, wireless devices, or other phones.
 - facing away from radio frequency transmitters, such as external antennas of mobile phone cell stations. (Avoid putting the base unit on a bay window or near a window.)
- Coverage and voice quality depends on the local environmental conditions.
- If the reception for a base unit location is not satisfactory, move the base unit to another location for better reception.

Environment

- Keep the product away from electrical noise generating devices, such as fluorescent lamps and motors.
- The product should be kept free from excessive smoke, dust, high temperature, and vibration.

Important Information

- The product should not be exposed to direct sunlight.
- Do not place heavy objects on top of the product.
- When you leave the product unused for a long period of time, unplug the product from the power outlet.
- The product should be kept away from heat sources such as heaters, kitchen stoves, etc. It should not be placed in rooms where the temperature is less than 0 °C or greater than 40 °C. Damp basements should also be avoided.
- The maximum calling distance may be shortened when the product is used in the following places: Near obstacles such as hills, tunnels, underground, near metal objects such as wire fences, etc.
- Operating the product near electrical appliances may cause interference. Move away from the electrical appliances.

Routine care

- **Wipe the outer surface of the product with a soft moist cloth.**
- Do not use benzine, thinner, or any abrasive powder.

Other information

CAUTION: Risk of explosion if battery is replaced by an incorrect type. Dispose of used batteries according to the instructions.

Notice for product disposal, transfer, or return

- This product can store your private/confidential information. To protect your privacy/confidentiality, we recommend that you erase information such as phonebook or caller list entries from the memory before you dispose of, transfer, or return the product.

Information on Disposal in other Countries outside the European Union



These symbols are only valid in the European Union. If you wish to discard these items, please contact your local authorities or dealer and ask for the correct method of disposal.

Specifications

- **Frequency range:**
2.40 GHz to 2.48 GHz
 - **RF transmission power:**
125 mW (max.)
 - **Power source:**
100-240 V AC, 50/60 Hz^{*1}
220-240 V AC, 50/60 Hz^{*2}
 - **Power consumption:**
Base unit^{*3}:
Standby: Approx. 1.0 W
Maximum: Approx. 3.0 W
Base unit^{*4}:
Standby: Approx. 1.0 W
Maximum: Approx. 4.0 W
Charger:
Standby: Approx. 0.1 W
Maximum: Approx. 2.0 W
 - **Operating conditions:**
0 °C – 40 °C, 20 % – 80 % relative air humidity (dry)
- *1 KX-TG3711/KX-TG3712/KX-TG3721/
KX-TG3722/KX-TG3811/KX-TG3821/
KX-TG3822
*2 KX-TG3719
*3 KX-TG3711/KX-TG3721 series: page 3
*4 KX-TG3811/KX-TG3821 series: page 4
- Note:**
- Design and specifications are subject to change without notice.
 - The illustrations in these instructions may vary slightly from the actual product.

Getting Started

Setting up

Connections

Note:

- Use only the supplied Panasonic AC adaptor.

*1 PNLV226BX: KX-TG3711BX/
 KX-TG3712BX/KX-TG3721BX/
 KX-TG3722BX/KX-TG3811BX/
 KX-TG3821BX/KX-TG3811JX/
 KX-TG3821JX/KX-TG3822JX
 PNLV226BX or PNLV226SX:
 KX-TG3711SX/KX-TG3712SX/
 KX-TG3721SX/KX-TG3722SX/
 KX-TG3811SX/KX-TG3821SX

*2 PNLV226E: KX-TG3719BX

*3 DSL/ADSL filter (not supplied) is required if you have DSL/ADSL service.

■ **Base unit (KX-TG3711 series: page 3)**

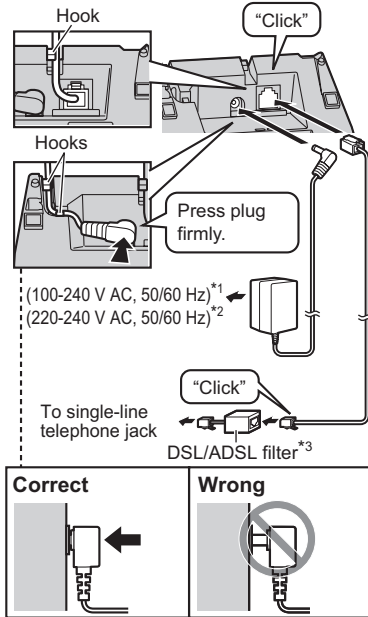

■ **Base unit (KX-TG3721 series: page 3)**

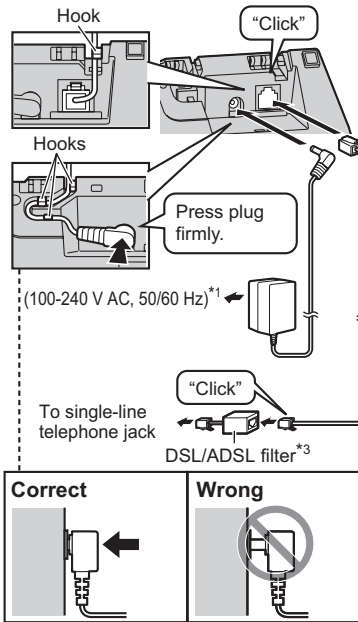

Getting Started

■ Base unit (KX-TG3811/KX-TG3821 series: page 4)

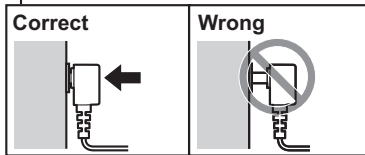
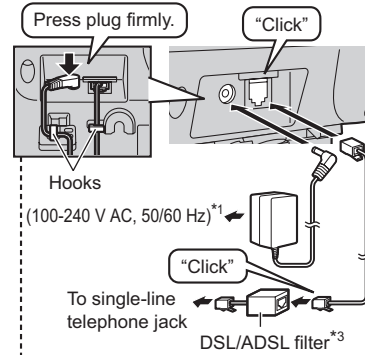

■ Charger

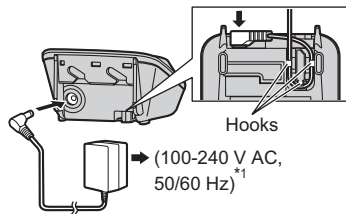

Battery installation

- USE ONLY Ni-MH batteries AAA (R03) size.
- Do NOT use Alkaline/Manganese/Ni-Cd batteries.

- Confirm correct polarities (+, -).

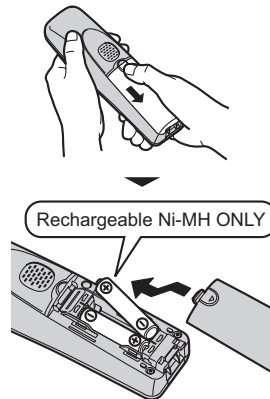

When the language selection or the date and time setting is displayed, see page 17.

Battery charging

Charge for about 7 hours.

- When the batteries are fully charged, the charge indicator goes off and "Fully charged" is displayed.

■ KX-TG3711/KX-TG3721 series: page 3

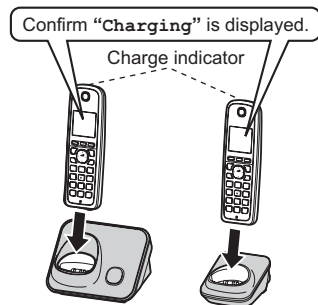

Model shown is KX-TG3712.

Getting Started

■ KX-TG3811/KX-TG3821 series: page 4

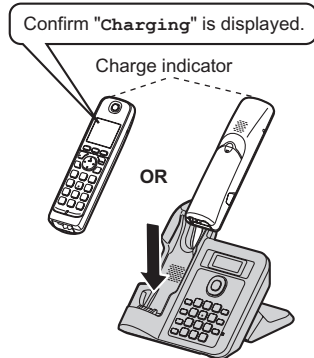

Model shown is KX-TG3811.

Note when setting up

Note for connections

- The AC adaptor must remain connected at all times. (It is normal for the adaptor to feel warm during use.)
- The AC adaptor should be connected to a vertically oriented or floor-mounted AC outlet. Do not connect the AC adaptor to a ceiling-mounted AC outlet, as the weight of the adaptor may cause it to become disconnected.

Note for battery installation

- Use the supplied rechargeable batteries. For replacement, we recommend using the Panasonic rechargeable batteries noted on page 5, 7.
- Wipe the battery ends (+, -) with a dry cloth.
- Avoid touching the battery ends (+, -) or the unit contacts.

Note for battery charging

- It is normal for the handset to feel warm during charging.

- Clean the charge contacts of the handset, base unit, and charger with a soft and dry cloth once a month. Before cleaning the unit, disconnect from power outlets and any telephone line cords. Clean more often if the unit is exposed to grease, dust, or high humidity.

Battery level

Icon	Battery level
	High
	Medium
	Low
	Needs charging.

Panasonic Ni-MH battery performance (supplied batteries)

Operation	Operating time
In continuous use	10 hours max.
Not in use (standby)	6 days max.

Note:

- Actual battery performance depends on usage and ambient environment.
- Even after the batteries are fully charged, the handset can be left on the base unit or charger without any ill effect on the batteries.
- The battery level may not be displayed correctly after you replace the batteries. In this case, place the handset on the base unit or charger and let it charge for at least 7 hours.

Getting Started

Controls

Handset (KX-TG3711/KX-TG3721 series: page 3)

■ KX-TGA371BX/KX-TGA371SX

Important:

- Arabic/Persian characters are not printed on KX-TGA371SX handset dial keypads.

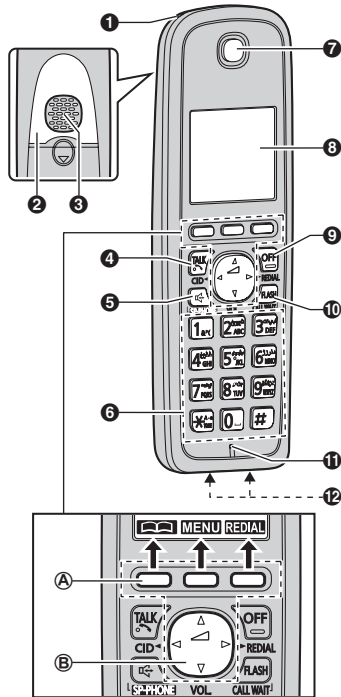

- ❶ Charge indicator
- Ringer indicator
- ❷ Secure grip
 - Secure grip offers support when you cradle the handset between your shoulder and ear.
- ❸ Speaker

- ❹ [TALK]
- ❺ [SP-PHONE: Speakerphone]
- ❻ Dial keypad (TONE)
- ❼ Receiver
- ❽ Display
- ❾ [OFF]
- ❿ [FLASH] [CALL WAIT]
- ⓫ Microphone
- ⓬ Charge contacts

■ Control type

Ⓐ Soft keys

The handset features 3 soft keys. By pressing a soft key, you can select the feature shown directly above it on the display.

Ⓑ Navigator key

- [▲], [▼], [◀], or [▶]: Scroll through various lists and items.
- VOL. (Volume: [▲] or [▼]): Adjust the receiver or speaker volume while talking.
- [◀] CID (Caller ID): View the caller list.
- [▶] REDIAL: View the redial list.

Getting Started

Handset (KX-TG3811/KX-TG3821 series: page 4)

■ KX-TGA381BX/KX-TGA381JX/
KX-TGA381SX

Important:

- Arabic/Persian characters are not printed on KX-TGA381SX handset dial keypads.

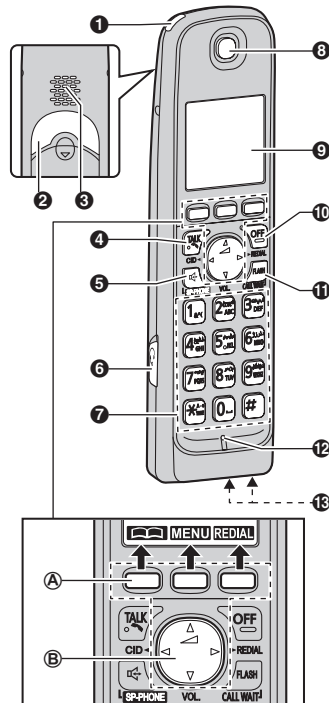

- 1** Charge indicator
Ringer indicator
- 2** Secure grip
 - Secure grip offers support when you cradle the handset between your shoulder and ear.
- 3** Speaker
- 4** [TALK]

- 5** [SP-PHONE: Speakerphone]
- 6** Headset jack
- 7** Dial keypad (TONE)
- 8** Receiver
- 9** Display
- 10** [OFF]
- 11** [FLASH] [CALL WAIT]
- 12** Microphone
- 13** Charge contacts

Control type

A Soft keys

The handset features 3 soft keys. By pressing a soft key, you can select the feature shown directly above it on the display.

B Navigator key

- [▲], [▼], [←], or [→]: Scroll through various lists and items.
- VOL. (Volume: [▲] or [▼]): Adjust the receiver or speaker volume while talking.
- [CID] (Caller ID): View the caller list.
- [REDIAL]: View the redial list.

Base unit

■ KX-TG3711 series: page 3

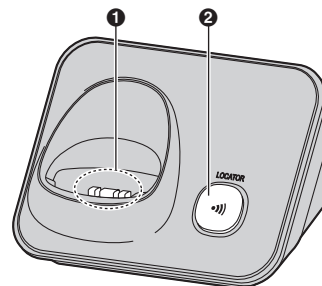

- 1** Charge contacts
- 2** [LOCATOR]

Getting Started

■ KX-TG3721 series: page 3

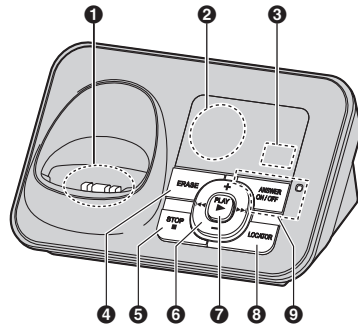

- 1 Charge contacts
- 2 Speaker
- 3 Message counter
- 4 [ERASE]
- 5 [■] (STOP)
- 6 [+]/[-] (Volume up/down)
[↶]/[↷] (Repeat/Skip)
- 7 [▶] (PLAY)
Message indicator
- 8 [LOCATOR]
- 9 [ANSWER ON/OFF]
ANSWER ON/OFF indicator

■ KX-TG3811 series: page 4

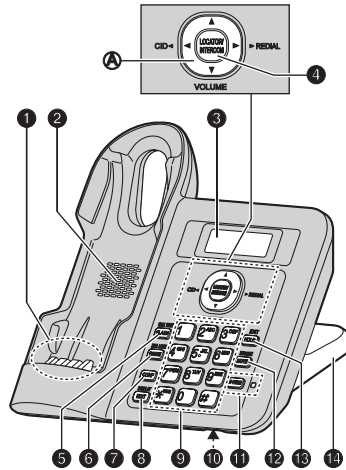

- 1 Charge contacts
- 2 Speaker
- 3 Display
- 4 [LOCATOR] [INTERCOM]
- 5 [FLASH] [CALL WAIT]
- 6 [PAUSE] [DIAL LOCK]
- 7 [CONF] (Conference)
- 8 [EDIT] [DISPLAY]
- 9 Dial keypad (☒): TONE
- 10 Microphone
- 11 [SP-PHONE] (Speakerphone)
SP-PHONE indicator
- 12 [MUTE] [ERASE]
- 13 [HOLD] [EXIT]
- 14 Bracket*1

*1 The base unit has an unremovable bracket for desk or wall mounting. To mount on a wall, see page 45.

■ Control type

Ⓐ Navigator key

- [▲], [▼], [←], or [→]: Scroll through various lists and items.
- [▲] or [▼] (Volume): Adjust the speaker volume while talking.
- [←] CID (Caller ID): View the caller list.
- [→] REDIAL: View the redial list.

Getting Started

■ KX-TG3821 series: page 4

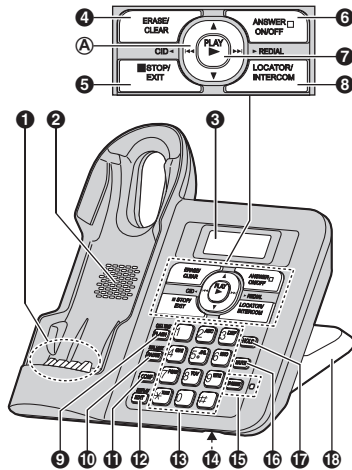

- 1 Charge contacts
- 2 Speaker
- 3 Display
- 4 [ERASE] [CLEAR]
- 5 [■] (STOP) [EXIT]
- 6 [ANSWER ON/OFF]
ANSWER ON/OFF indicator
- 7 [▶] (PLAY)
Message indicator
- 8 [LOCATOR] [INTERCOM]
- 9 [FLASH] [CALL WAIT]
- 10 [PAUSE] [DIAL LOCK]
- 11 [CONF] (Conference)
- 12 [EDIT] [DISPLAY]
- 13 Dial keypad (☒: TONE)
- 14 Microphone
- 15 [SP-PHONE] (Speakerphone)
SP-PHONE indicator
- 16 [MUTE]
- 17 [HOLD]
- 18 Bracket*1

*1 The base unit has an unremovable bracket for desk or wall mounting. To mount on a wall, see page 45.

■ Control type

Ⓐ Navigator key

- [▲], [▼], [◀], or [▶]: Scroll through various lists and items.
- [▲] or [▼] (Volume): Adjust the speaker volume while talking.
- [◀] CID (Caller ID): View the caller list.
- [▶] REDIAL: View the redial list.
- [◀◀]/[▶▶]: Repeat/skip messages during playback.

Belt clip

Available for:
KX-TG3811/KX-TG3821 series: page 4

■ To attach

■ To remove



Display

Handset display items

Item	Meaning
☒	Within base unit range
☒	Out of base unit range
☎	Paging, intercom mode*1
☎	The line is in use. <ul style="list-style-type: none"> ● When flashing: The call is put on hold. ● When flashing rapidly: An incoming call is now being received.
☎	The LCD and key backlight is off. (page 29)

Getting Started

Item	Meaning
	Answering system is on.*2 (page 37)
	Answering system answers calls with a greeting message and caller messages are not recorded.*2 ("Selecting "Greeting Only", page 41)
	Equalizer is set. (page 21)
	Speakerphone is on. (page 18)
	Dial lock is on. (page 22)
	Ringer volume is off. (page 29)
	Night mode is on. (page 32)
	Privacy mode is on.*1 (page 30)
	Alarm is on. (page 32)
	Battery level
	Blocked call (page 33)
BOOST	Clarity booster is on. (page 21)
	New voice mail message received.*3 (page 42)
In use	Answering system is being used by: <ul style="list-style-type: none"> - another handset*4 - the base unit.*5
Line in use	Someone is using the line.*1

*1 KX-TG3712, KX-TG3722, KX-TG3811/
KX-TG3821 series (page 4)
*2 KX-TG3721/KX-TG3821 series: page 3, 4
*3 Voice mail subscribers only
*4 KX-TG3722/KX-TG3822
*5 KX-TG3721 series: page 3

Base unit display items

■ KX-TG3721 series: page 3

Item	Meaning
--	Answering system answers calls with a greeting message and caller messages are not recorded. ("Selecting "Greeting Only", page 41)

■ KX-TG3811/KX-TG3821 series: page 4

Item	Meaning
	Answering system answers calls with a greeting message and caller messages are not recorded.*1 ("Selecting "Greeting Only", page 41)
	Dial lock is on. (page 22)
	Ringer volume is off. (page 19)
PRIV	Privacy mode is on. (page 30)
	New voice mail message received.*2 (page 42)
In use	Answering system is being used by a handset.*1
Line in use	Someone is using the line.

*1 KX-TG3821 series: page 4
*2 Voice mail subscribers only

Initial settings





■ Direct command code:

Programmable settings can be accessed by pressing **[MENU]**, **[#]** and then the corresponding code on the dial keypad (page 27).

Example: Press **[MENU][#][1][0][1]**.

Getting Started

■ Symbol meaning:

Symbol	Meaning
	Perform with the handset.
	Perform with the base unit.
Example:  : "Off"	Press [] or [] to select the words in quotations.

Important:

- When you install the batteries for the first time, the handset may prompt you to set display language and date and time.
 - Perform step 2 in "Display language", page 17, and then press **[OK]**.
 - Continue from step 2 in "Date and time", page 17.

Display language

Available for:
 KX-TG3711BX/KX-TG3712BX/
 KX-TG3719BX/KX-TG3721BX/
 KX-TG3722BX/KX-TG3811BX/
 KX-TG3821BX/KX-TG3811JX/
 KX-TG3821JX/KX-TG3822JX

You can select "English", "العربية", or "فارسي" as the display language. The default setting is "English".

Handset

- [MENU]** **#** **1** **1** **0**
- [↕]**: Select your desired language. → **[OK]**
- [OFF]**

Base unit*1

*1 KX-TG3811/KX-TG3821 series: page 4

- [DISPLAY]**
- [↕]**: "Language" → **[▶]**
- [↕]**: Select your desired language. → **[▶]**

Date and time

Important:

- When you install the batteries for the first time, the handset may prompt you to set date and time. First press **[OK]**, then proceed to step 2.

- [MENU]** **#** **1** **0** **1**
- Enter the current date, month, and year by selecting 2 digits for each. → **[OK]**
Example: 15 July, 2011
1 **5** **0** **7** **1** **1**
- Enter the current hour and minute (24-hour clock format) by selecting 2 digits for each.
Example: 15:30
1 **5** **3** **0**
- [OK]** → **[OFF]**

Note:

- The order in which you enter the date differs according to the selected display language.
Example:
 Arabic/Persian: Year/Month/Date
 English: Date/Month/Year
- The date and time may be incorrect after a power failure. In this case, set the date and time again.

Dialing mode

If you cannot make calls, change this setting according to your telephone line service. The default setting is "Tone".

"Tone": For tone dial service.
 "Pulse": For rotary/pulse dial service.

- [MENU]** **#** **1** **2** **0**
- [↕]**: Select the desired setting.
- [OK]** → **[OFF]**

Making/Answering Calls

Making calls

Using the handset

- 1 Lift the handset and dial the phone number.
 - To correct a digit, press **[CLEAR]**.
- 2 Press **[↶]** or **[CALL]**.
- 3 When you finish talking, press **[OFF]** or place the handset on the base unit or charger.

Using the speakerphone

- 1 Dial the phone number and press **[☎]**.
 - Speak alternately with the other party.
- 2 When you finish talking, press **[OFF]**.

Note:

- For best performance, use the speakerphone in a quiet environment.
- To switch back to the receiver, press **[☎]/[↶]**.

Adjusting the receiver or speaker volume

Press **[▲]** or **[▼]** repeatedly while talking.

Making a call using the redial list

The last 10 phone numbers dialed are stored in the redial list (each 24 digits max.).

- 1 **[REDIAL]** or **[▶]** REDIAL
- 2 **[↕]**: Select the desired phone number.
- 3 **[↶]**

Erasing a number in the redial list

- 1 **[REDIAL]** or **[▶]** REDIAL
- 2 **[↕]**: Select the desired phone number.
→ **[ERASE]**
- 3 **[↕]**: "Yes" → **[OK]**
- 4 **[OFF]**

Using the base unit

Available for:

KX-TG3811/KX-TG3821 series: page 4

- 1 Dial the phone number.
- 2 **[SP-PHONE]**
- 3 When the other party answers, speak into the microphone.
 - Speak alternately with the other party.
- 4 When you finish talking, press **[SP-PHONE]**.

Note:

- For best performance, use the speakerphone in a quiet environment.
- While on a call, you can switch from the base unit to the handset:
 - Press **[↶]** on the handset, then press **[SP-PHONE]** on the base unit with the privacy mode off (page 30).
 - If the handset is on the base unit, simply lift it.

Adjusting the speaker volume

Press **[▲]** or **[▼]** repeatedly while talking.

Making a call using the redial list

The last 10 phone numbers dialed are stored in the redial list (each 48 digits max.).

- 1 **[▶]** REDIAL
- 2 **[↕]**: Select the desired phone number.
- 3 **[SP-PHONE]**

Erasing a number in the redial list

- 1 **[▶]** REDIAL
- 2 **[↕]**: Select the desired phone number.
→ **[ERASE]**
- 3 **[↕]**: "Yes" → **[▶]**
- 4 **[EXIT]**

Pause (for PBX/long distance service users)

A pause is sometimes required when making calls using a PBX or long distance service. When storing a calling card access number

Making/Answering Calls

and/or PIN in the phonebook, a pause is also needed (page 25).

Example: If you need to dial the line access number "9" when making outside calls with a PBX:

Handset

- 1 **[9]** → **[PAUSE]**
- 2 Dial the phone number. → **[↵]**

Base unit^{*1}

*1 KX-TG3811/KX-TG3821 series: page 4

- 1 **[9]** → **[PAUSE]**
- 2 Dial the phone number. → **[SP-PHONE]**

Note for handset and base unit:

- A 3.5 second pause is inserted each time **[PAUSE]** is pressed. Repeat as needed to create longer pauses.

Answering calls

Using the handset

When a call is being received, the ringer indicator flashes rapidly.

- 1 Lift the handset and press **[↵]** or **[⏏]** when the unit rings.
 - You can also answer the call by pressing any dial key from **[0]** to **[9]**, **[*]**, or **[#]**. (**Any key answer feature**)
- 2 When you finish talking, press **[OFF]** or place the handset on the base unit or charger.

Auto talk

You can answer calls simply by lifting the handset off the base unit or charger. You do not need to press **[↵]**. To turn this feature on, see page 29.

Adjusting the handset ringer volume

- **While the handset is ringing for an incoming call:**
Press **[▲]** or **[▼]** repeatedly to select the desired volume.

Programming the volume beforehand:

- 1 **[MENU]****[#]****[1]****[6]****[0]**
- 2 **[↕]**: Select the desired volume.
- 3 **[OK]** → **[OFF]**

Temporary handset ringer off

While the handset is ringing for a call, you can turn the ringer off temporarily by pressing **[⏏]**.

Using the base unit

Available for:
KX-TG3811/KX-TG3821 series: page 4

When a call is being received, the SP-PHONE indicator flashes rapidly.

- 1 Press **[SP-PHONE]** when the unit rings.
- 2 Speak into the microphone.
- 3 When you finish talking, press **[SP-PHONE]**.

Adjusting the base unit ringer volume

Press **[▲]** or **[▼]** repeatedly to select the desired volume.

- To turn the ringer off, press and hold **[▼]** until the unit beeps.

Note:

- Even when the ringer volume is set to off, the base unit still rings for intercom calls (page 43).

Making/Answering Calls

Useful features during a call

Hold

This feature allows you to put an outside call on hold.

Handset

- 1 Press **[MENU]** during an outside call.
- 2 **[⇄]**: "Hold" → **[OK]**
- 3 To release hold, press **[↶]**.
 - Another handset user can take the call by pressing **[↶]**. (KX-TG3712/KX-TG3722/KX-TG3822)
 - The base unit user can take the call by pressing **[SP-PHONE]**. (KX-TG3811/KX-TG3821 series: page 4)

Base unit*1

*1 KX-TG3811/KX-TG3821 series: page 4

- 1 Press **[HOLD]** during an outside call.
- 2 To release hold, press **[SP-PHONE]**.
 - A handset user can take the call by pressing **[↶]**.

Note for handset and base unit:

- If a call is kept on hold for more than 9 minutes, an alarm tone starts to sound and the ringer indicator on the handset flashes rapidly. After 1 additional minute on hold, the call is disconnected.
- If another phone is connected to the same line, you can also take the call by lifting its handset.
- While an outside call is on hold, the SP-PHONE indicator on the base unit flashes. (KX-TG3811/KX-TG3821 series: page 4)

Mute

While mute is turned on, you can hear the other party, but the other party cannot hear you.

Handset

- 1 Press **[MUTE]** during conversation.

- **[MUTE]** flashes.

- 2 To return to the conversation, press **[MUTE]** again.

Note:

- **[MUTE]** is a soft key visible on the handset display during a call.

Base unit*1

*1 KX-TG3811/KX-TG3821 series: page 4

- 1 Press **[MUTE]** during conversation.
 - The SP-PHONE indicator flashes.
- 2 To return to the conversation, press **[MUTE]** again.

Flash

Handset / Base unit*1

*1 KX-TG3811/KX-TG3821 series: page 4

[FLASH] allows you to use the special features of your host PBX such as transferring an extension call, or accessing optional telephone services.

Note:

- To change the flash time, see page 30.

For call waiting or Call Waiting Caller ID service users

To use call waiting or Call Waiting Caller ID, you must first subscribe with your service provider/telephone company.

This feature allows you to receive calls while you are already talking on the phone. If you receive a call while on the phone, you will hear a call waiting tone.

If you subscribe to both Caller ID and Call Waiting with Caller ID services, the 2nd caller's information is displayed on the handset or base unit that is in use after you hear the call waiting tone.

Handset / Base unit*1

*1 KX-TG3811/KX-TG3821 series: page 4

- 1 Press **[CALL WAIT]** to answer the 2nd call.

Making/Answering Calls

- To switch between calls, press **[CALL WAIT]**.

Note:

- Please contact your service provider/ telephone company for details and availability of this service in your area.

Temporary tone dialing (for rotary/pulse service users)

You can temporarily switch the dialing mode to tone when you need to access touch-tone services (for example, answering services, telephone banking services, etc.).

 **Handset** /  **Base unit***1

*1 KX-TG3811/KX-TG3821 series: page 4

Press **[TONE]** (TONE) before entering access numbers which require tone dialing.

Handset clarity booster

This feature can improve sound clarity when the handset is used in an area where there may be interference. During an outside call, this feature is turned on automatically when necessary.

- When this feature is turned on, **[BOOST]** is displayed.
- While this feature is turned on, the battery operating time is shortened (page 11).

Handset equalizer

This feature clarifies the voice of the person you are talking to, producing a more natural-sounding voice that is easier to hear and understand.

- Press **[MENU]** while talking.
- [↕]**: "Equalizer" → **[OK]**
- [↕]**: Select the desired setting.
- Press **[OK]** to exit.

Note:

- When this feature is turned on, **[E]** is displayed while talking.
- Depending on the condition and quality of your telephone line, this feature may

emphasize existing line noise. If it becomes difficult to hear, turn this feature off.

- This feature is not available while using the speakerphone.

Call share

Available for:
KX-TG3712, KX-TG3722, KX-TG3811/
KX-TG3821 series (page 4)

You can join an existing outside call.

 **Handset**

To join the conversation, press **[↶]** when the other unit is on an outside call.

 **Base unit***1

*1 KX-TG3811/KX-TG3821 series: page 4

To join the conversation, press **[SP-PHONE]** when the handset is on an outside call.

Note for handset and base unit:

- To prevent other users from joining your conversations with outside callers, turn the privacy mode on (page 30).

Dial lock

This feature prohibits making outside calls. The default setting is off.

Important:

- When dial lock is turned on, only phone numbers stored in the phonebook as emergency numbers (numbers stored with a **[*]** at the beginning of the name) can be dialed using the phonebook (page 24). We recommend storing emergency numbers in the phonebook before using this feature.**
- When dial lock is turned on, you cannot store, edit, or erase entries in the phonebook.

Making/Answering Calls

Turning dial lock on

 Handset /  Base unit*1

*1 KX-TG3811/KX-TG3821 series: page 4

- 1 Proceed with the operation for your unit.
Handset: **[MENU][#][2][5][1]**
Base unit: **[DIAL LOCK]**
- 2 Enter a 4-digit password.
 - This password is required when turning dial lock off. We recommend writing the password down.
- 3 Proceed with the operation for your unit.
Handset: **[OK]** 2 times → **[OFF]**
Base unit: **[▶]** 2 times

Note:

- If dial lock is turned on,  is displayed.

Turning dial lock off

 Handset /  Base unit*1

*1 KX-TG3811/KX-TG3821 series: page 4

- 1 Proceed with the operation for your unit.
Handset: **[MENU][#][2][5][1]**
Base unit: **[DIAL LOCK]**
- 2 Enter the same password that was entered when dial lock was turned on.
- 3 Proceed with the operation for your unit.
Handset: **[OK]** 2 times → **[OFF]**
Base unit: **[▶]** 2 times



Note:

- If you forget the password, see page 53.

Power back-up operation

When a power failure occurs, the charged handset temporarily supplies power to the base unit (power back-up mode). This allows you to make and receive calls using a handset during a power failure. The base unit will not perform any other functions. You can program "Power Failure" and the default setting is "Auto" (page 30).

Important:

- If a handset is not placed on the base unit when a power failure occurs, "Base no power Press OFF" is displayed. After pressing **[OFF]** on the handset, place it on the base unit to start power back-up mode.
- Power back-up mode will not work if the battery level of the power supplying handset is  or .
- Do not lift the power supplying handset from the base unit during power back-up mode.
- Do not touch the handset's charge contacts during power back-up mode.
- If the battery level is low, the unit will not work sufficiently during power back-up mode. In addition, in case handset battery power runs out, we recommend connecting a corded-type telephone (without AC adaptor) to the same telephone line or to the same telephone line jack using a T-adaptor.

Panasonic Ni-MH battery performance (supplied batteries) during power back-up mode

When the batteries are fully charged, operating time of the handset in power back-up mode varies depending on usage.

- Continuous use of the handset in power back-up mode: 2 hours max.
- Continuous use of the handset other than a handset in power back-up mode: 3 hours max.
- Not in use in power back-up mode: 3 hours max.

Note:

- Actual battery performance depends on usage and ambient environment.

Making calls during a power failure

■ **When only 1 handset is registered:**

- 1 Lift the handset and dial the phone number.
- 2 Within 1 minute, place the handset on the base unit.

Making/Answering Calls

- Wait until speakerphone is turned on automatically and the call is made.

- 3 When the other party answers the call, keep the handset on the base unit and talk using the speakerphone.
- 4 When you finish talking, press **[OFF]**.

Note:

- In step 2, if you do not place the handset on the base unit within 1 minute, the power back-up mode turns off. In this case, press **[OFF]** on the handset and dial the phone number. Then try again from step 2.

- **When 2 or more handsets are registered:** You should leave one handset on the base unit for supplying the power, and use another handset for making calls. For the operation, please see "Making calls", page 18.

Note:

- During a call with the handset placed on the base unit (power back-up mode), the call may be disconnected if you touch the handset. In such case, try to call back.
- The range of the base unit is limited during a power failure. Please use the handset close to the base unit.

Making a call using the redial list

- **When only 1 handset is registered:**

- 1 Lift the handset.
- 2 **[REDIAL]** or **[>]** REDIAL
- 3 **[+]**: Select the desired phone number.
- 4 Within 1 minute, place the handset on the base unit.
 - Wait until speakerphone is turned on automatically and the call is made.

- **When 2 or more handsets are registered:** You should leave one handset on the base unit for supplying the power, and use another handset for making calls. For the operation, please see "Making a call using the redial list", page 18.

Making a call using the handset phonebook

- **When only 1 handset is registered:**

- 1 Lift the handset.
- 2 **[☎]**
- 3 **[+]**: Select the desired entry.
- 4 Within 1 minute, place the handset on the base unit.
 - Wait until speakerphone is turned on automatically and the call is made.

- **When 2 or more handsets are registered:** You should leave one handset on the base unit for supplying the power, and use another handset for making calls. For the operation, please see "Finding and calling from a phonebook entry", page 24.

Answering calls during a power failure

- **When only 1 handset is registered:**

- 1 When the unit rings, keep the handset on the base unit and press **[↶]** or **[☎]**.
 - Speakerphone is turned on.
- 2 When you finish talking, press **[OFF]**.

- **When 2 or more handsets are registered:** When the unit rings, use a handset which is not supplying power to the base unit. For the operation, please see "Answering calls", page 19.

- Do not use or lift the handset which is placed on the base unit during power back-up mode.

Note:

- During a call with the handset placed on the base unit (power back-up mode), the call may be disconnected if you touch the handset. In such case, try to call back.
- The range of the base unit is limited during a power failure. Please use the handset close to the base unit.

Phonebook

Handset phonebook

The phonebook allows you to make calls without having to dial manually. You can add 100 names and phone numbers.

Adding entries

- 1 → [ADD]
- 2 Enter the party's name (16 characters max.). → [OK]
- 3 Enter the party's phone number (24 digits max.). → [OK] 2 times
 - To add other entries, repeat from step 2.
- 4 [OFF]

Note:

Available for:
 KX-TG3711BX/KX-TG3712BX/
 KX-TG3719BX/KX-TG3721BX/
 KX-TG3722BX/KX-TG3811BX/
 KX-TG3821BX/KX-TG3811JX/
 KX-TG3821JX/KX-TG3822JX

- In step 2, you can change the character entry mode by pressing [1/A/?] (page 47).

To store emergency numbers

Emergency numbers are numbers stored in the phonebook that can be dialed using the phonebook even when dial lock is turned on (page 21).

To store a number as an emergency number, add at the beginning of the name (see "Adding entries", page 24).

Character table for entering names

Available for:
 KX-TG3711SX/KX-TG3712SX/
 KX-TG3721SX/KX-TG3722SX/
 KX-TG3811SX/KX-TG3821SX

While entering characters, you can switch between uppercase and lowercase by pressing (A→a).

Key	Character
[1]	& ' () * , - . / 1
[2]	A B C 2 a b c 2
[3]	D E F 3 d e f 3
[4]	G H I 4 g h i 4
[5]	J K L 5 j k l 5
[6]	M N O 6 m n o 6
[7]	P Q R S 7 p q r s 7
[8]	T U V 8 t u v 8
[9]	W X Y Z 9 w x y z 9
[0]	␣ 0
[#]	#

- To enter another character that is located on the same dial key, first press to move the cursor to the next space.
- If you do not press any dial key within 5 seconds after entering a character, the character is fixed and the cursor moves to the next space.
- ␣ in the above table represents a single space.

Erasing the character or number

Press or . → [CLEAR]

- Press and hold [CLEAR] to erase all characters or numbers.

Finding and calling from a phonebook entry

Scrolling through all entries

- 1

Phonebook

- 2 **[↕]**: Select the desired entry.
 - You can scroll through the phonebook entry by pressing and holding **[▼]** or **[▲]**.

- 3 **[↶]**

Searching by first character

- 1 **[☞]**
- 2 Press the dial key (**[0]** to **[9]**, or **[*]**) which contains the character you are searching for (page 24, 47).
 - Press the same dial key repeatedly to display the first entry corresponding to each character located on that dial key.
 - If there is no entry corresponding to the character you selected, the next entry is displayed.
- 3 **[↕]**: Scroll through the phonebook if necessary.
- 4 **[↶]**

Note:

Available for:
 KX-TG3711BX/KX-TG3712BX/
 KX-TG3719BX/KX-TG3721BX/
 KX-TG3722BX/KX-TG3811BX/
 KX-TG3821BX/KX-TG3811JX/
 KX-TG3821JX/KX-TG3822JX

- In step 1, you can change the character entry mode if necessary:
[SEARCH] → **[↕]**: Select the character entry mode. → **[OK]**

Editing entries

- 1 Find the desired entry (page 24). → **[MENU]**
- 2 **[↕]**: "Edit" → **[OK]**
- 3 Edit the name if necessary (16 characters max.; page 24, 47). → **[OK]**
- 4 Edit the phone number if necessary (24 digits max.). → **[OK]** 2 times → **[OFF]**

Erasing entries

Erasing an entry

- 1 Find the desired entry (page 24).
- 2 **[ERASE]** → **[↕]**: "Yes" → **[OK]** → **[OFF]**

Erasing all entries

- 1 **[☞]** → **[MENU]**
- 2 **[↕]**: "Erase All" → **[OK]**
- 3 **[↕]**: "Yes" → **[OK]**
- 4 **[↕]**: "Yes" → **[OK]** → **[OFF]**

Chain dial

This feature allows you to dial phone numbers in the phonebook while you are on a call. This feature can be used, for example, to dial a calling card access number or bank account PIN that you have stored in the phonebook, without having to dial manually.

- 1 During an outside call, press **[MENU]**.
- 2 **[↕]**: "Phonebook" → **[OK]**
- 3 **[↕]**: Select the desired entry.
- 4 Press **[CALL]** to dial the number.

Note:

- When storing a calling card access number and your PIN in the phonebook as one phonebook entry, press **[PAUSE]** to add pauses after the number and PIN as necessary (page 18).
- If you have rotary/pulse service, you need to press **[☒]** (TONE) before pressing **[MENU]** in step 1 to change the dialing mode temporarily to tone. When adding entries to the phonebook, we recommend adding **[☒]** (TONE) to the beginning of phone numbers you wish to chain dial (page 24).

Phonebook

Copying phonebook entries

Available for:
KX-TG3712/KX-TG3722/KX-TG3822

You can copy phonebook entries between 2 handsets.*1

*1 Panasonic compatible handset

Copying an entry

- 1 Find the desired entry (page 24). → **[MENU]**
- 2 **[⇄]**: "Copy" → **[OK]**
- 3 **[⇄]**: Select the handset you want to send the phonebook entry to. → **[OK]**
 - When an entry has been copied, "Completed" is displayed.
 - To continue copying another entry: **[⇄]**: "yes" → **[OK]** → **[⇄]**: Select the desired entry. → **[OK]**
- 4 **[OFF]**

Copying all entries

- 1 **[☰]** → **[MENU]**
- 2 **[⇄]**: "Copy All" → **[OK]**
- 3 **[⇄]**: Select the handset you want to send the phonebook entry to. → **[OK]**
 - When all entries have been copied, "Completed" is displayed.
- 4 **[OFF]**

Programming

Programmable settings

You can customize the unit by programming the following features using the handset. To access the features, there are 2 methods.

■ Scrolling through the display menus

- 1 [MENU]
- 2 Press [▼] or [▲] to select the desired main menu. → [OK]
- 3 Press [▼] or [▲] to select the desired item from the next sub-menus. → [OK]
- 4 Press [▼] or [▲] to select the desired setting. → [OK]
 - This step may vary depending on the feature being programmed.
 - To exit the operation, press [OFF].

■ Using the direct command code

- 1 [MENU] → Enter the desired code.
 Example: Press [MENU][#][1][0][1].
- 2 Select the desired setting. → [OK]
 - This step may vary depending on the feature being programmed.
 - To exit the operation, press [OFF].

Note:

- In the following table, < > indicates the default settings.
- In the following table,  indicates the reference page number.
- Display menu order and sub-menu may vary depending on your model.

Display the menu tree and direct command code table

Main menu:  "Caller List"

Operation	Code	
Viewing the caller list.	#213	34

Main menu:  "Answer System"^{*1}

Sub-menu 1	Sub-menu 2	Setting	Code	
Play New Msg.	–	–	#323	39
Play All Msg.	–	–	#324	39
Erase All Msg. ^{*2}	–	–	#325	40
Greeting	Start REC ^{*2} (Record greeting)	–	#302	38
	Play Greeting	–	#303	38
	Default ^{*2} (Reset to pre-recorded greeting)	–	#304	38

Programming

Sub-menu 1	Sub-menu 2	Setting	Code	↑
Settings	Number of Rings ^{*2}	2-7: 2-7 Rings <4 Rings> 0: Toll Saver	#211	41
	Recording Time ^{*2}	1: 1 Minute 3: <3 Minutes> 0: Greeting Only ^{*3}	#305	41
	Remote Code ^{*2}	<111>	#306	40
	Call Screening	1: <On> 0: Off	#310	37
Answer On ^{*2}	-	-	#327	37
Answer Off ^{*2}	-	-	#328	37

Main menu: **[4]** "Time Settings"

Sub-menu 1	Sub-menu 2	Setting	Code	↑
Set Date/Time ^{*2}	-	-	#101	17
Alarm	-	1: Once 2: Daily 0: <Off>	#720	32
Time Adjustment ^{*2, *4}	-	1: Caller ID 0: <Manual>	#226	-

Main menu: **[5]** "Intercom"^{*5}

Operation	Code	↑
Paging the desired unit.	#274	43

Main menu: **[6]** "Ringer Setup"

Sub-menu 1	Sub-menu 2	Settings	Code	↑
Ringer Volume	Handset ^{*6}	0-6: Off-6 <6>	#160	19
	Base Unit ^{*2, *7}	0-6: Off-6 <1>	#*160	-
Ringtone ^{*8, *9} (Handset)	-	<Ringtone 1>	#161	-
Night Mode	On/Off	1: On 0: <Off>	#238	32
	Start/End	<23:00/06:00>	#237	32
	Ring Delay	1: 30 sec. 2: <60 sec.> 3: 90 sec. 4: 120 sec. 0: No Ringing	#239	32

ProgrammingMain menu:  "Initial Setup"

Sub-menu 1	Sub-menu 2	Setting	Code	
Ringer Setup	Ringer Volume - Handset ^{*6}	0-6: Off-6 <6>	#160	19
	Ringer Volume - Base Unit ^{*2, *7}	0-6: Off-6 <1>	#*160	-
	Ringtone ^{*8, *9} (Handset)	<Ringtone 1>	#161	-
	Night Mode - On/Off	1: On 0: <Off>	#238	32
	Night Mode - Start/End	<23:00/06:00>	#237	32
	Night Mode - Ring Delay	1: 30 sec. 2: <60 sec.> 3: 90 sec. 4: 120 sec. 0: No Ringing	#239	32
Time Settings	Set Date/Time ^{*2}	-	#101	17
	Alarm	1: Once 2: Daily 0: <Off>	#720	32
	Time Adjustment ^{*2, *4}	1: Caller ID 0: <Manual>	#226	-
Handset Name	-	-	#104	33
Caller Barred ^{*2}	-	-	#217	33
Display Setup	LCD & Key Backlight	1: <On> 0: Off	#276	-
	Contrast ^{*10} (Display contrast)	1-6: Level 1-6 <3>	#145	-
Keytones ^{*11}	-	1: <On> 0: Off	#165	-
Area Code ^{*2, *12}	-	-	#255	35
Dial Lock ^{*2}	-	-	#251	21
Auto Talk ^{*13}	-	1: On 0: <Off>	#200	19

Programming

Sub-menu 1	Sub-menu 2	Setting	Code	↑
Line Setup	Dial Mode ^{*2}	1: Pulse 2: <Tone>	#120	17
	Flash Time ^{*2, *14}	0: 900 msec. 1: <700 msec.> 2: 600 msec. 3: 400 msec. 4: 300 msec. 5: 250 msec. *: 200 msec. #: 160 msec. 6: 110 msec. 7: 100 msec. 8: 90 msec. 9: 80 msec.	#121	20
Privacy Mode ^{*2, *5, *15}	—	1: On 0: <Off>	#194	—
Register	Register H.set	—	#130	54
	Cancel Register ^{*3}	—	#131	54
Power Failure	—	1: <Auto> 0: Off	#152	22
Language ^{*12}	—	1: <English> 2: العربية 3: فارسی	#110	17

*1 KX-TG3721/KX-TG3821 series: page 3, 4

*2 If you program these settings using one of the handsets, you do not need to program the same item using another handset. (KX-TG3712/KX-TG3722/KX-TG3822)

*3 This menu is not displayed when scrolling through the display menus. It is only available in direct command code.

*4 If the Caller ID time and date display service is available in your area, this feature allows the unit to automatically adjust the date and time each time caller information including date and time is received.

To turn this feature on, select "Caller ID". To turn this feature off, select "Manual". (Caller ID subscribers only) To use this feature, set the date and time first (page 17).

*5 KX-TG3712, KX-TG3722, KX-TG3811/KX-TG3821 series (page 4)

*6 Ringer volume cannot be turned off for alarm, intercom calls, and paging.

*7 KX-TG3721 series: page 3

*8 If you select one of the melody ringer tones, the ringer tone continues to play for several seconds even if the caller has already hung up. You may either hear a dial tone or no one on the line when you answer the call.

*9 The preset melodies in this product are used with permission of © 2011 Copyrights Vision Inc.

*10 KX-TG3811/KX-TG3821 series base unit

You can adjust the contrast of the base unit display by performing the following operation.

[DISPLAY] → [↕]: "Contrast" → [▶] → [↕]: Select the desired setting. → [▶]

*11 Turn this feature off if you prefer not to hear key tones while you are dialing or pressing any keys, including confirmation tones and error tones.

*12 KX-TG3711BX/KX-TG3712BX/KX-TG3719BX/KX-TG3721BX/KX-TG3722BX/
KX-TG3811BX/KX-TG3821BX/KX-TG3811JX/KX-TG3821JX/KX-TG3822JX

*13 If you subscribe to a Caller ID service and want to view the caller's information after lifting up the handset to answer a call, turn off this feature.



Programming

*14 The flash time depends on your telephone exchange or host PBX. Contact your PBX supplier if necessary.

*15 To prevent other users from joining your conversations with outside callers, turn this feature on.

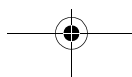
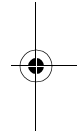
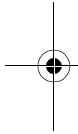

Programming

Special programming

Alarm

An alarm sounds at the set time for 3 minutes once or daily. Alarm can be set for each handset.

Important:

- Set the date and time beforehand (page 17).

- 1 **[MENU]#720**
- 2 **[↑]**: Select the desired alarm option. → **[OK]**

Off	Turns alarm off. Go to step 6.
Once	An alarm sounds once at the set time.
Daily	An alarm sounds daily at the set time. Go to step 4.

- 3 Enter the desired date and month. → **[OK]**
- 4 Set the desired time. → **[OK]**
- 5 **[↑]**: Select the desired alarm tone. → **[OK]**
 - We recommend selecting a different ringer tone from the one used for outside calls.
- 6 **[OK]** → **[OFF]**
 - When the alarm is set, ☺ is displayed.

Note:

- The order in which you enter the date differs according to the selected display language.

Example:

Arabic/Persian: Month/Date
English: Date/Month

- To stop the alarm, press **[OFF]** or place the handset on the base unit or charger.
- When the handset is in use, the alarm will not sound until the handset is in standby mode.

Night mode

Night mode allows you to select a period of time during which the handset will not ring for outside calls. This feature is useful for time

periods when you do not want to be disturbed, for example, while sleeping. Night mode can be set for each handset.

Important:

- Set the date and time beforehand (page 17).
- We recommend turning the base unit ringer off (page 19, 29) in addition to turning the night mode on. (KX-TG3721/KX-TG3811/KX-TG3821 series: page 3, 4)
- If you have set the alarm, the alarm sounds even if the night mode is turned on.

Turning night mode on/off

- 1 **[MENU]#238**
- 2 **[↑]**: Select the desired setting. → **[OK]**
 - If you select "off", press **[OFF]** to exit.
- 3 Enter the desired hour and minute you wish to start this feature. → **[OK]**
- 4 Enter the desired hour and minute you wish to end this feature.
- 5 **[OK]** → **[OFF]**
 - When the night mode is set, ☾ is displayed.

Changing the start and end time

- 1 **[MENU]#237**
- 2 Continue from step 3, "Turning night mode on/off", page 32.

Setting the ring delay

This setting allows the handset to ring during night mode if the caller waits long enough. After the selected amount of time passes, the handset rings. If you select "No Ringing", the handset never rings during night mode.

- 1 **[MENU]#239**
- 2 **[↑]**: Select the desired setting. → **[OK]** → **[OFF]**

Note:

- When the answering system answers the call, this feature does not work. (KX-TG3721/KX-TG3821 series: page 3, 4)

Programming

Changing the handset name

Each handset can be given a customized name ("Bob", "Kitchen", etc.). This is useful when you make intercom calls between handsets. You can also select whether or not the handset name is displayed in standby mode. The default setting is "No". If you select "Yes" without entering any handset name, "Handset 1" to "Handset 2" is displayed.

- 1 **[MENU]** **[#]** **[1]** **[0]** **[4]**
- 2 Enter the desired name (max. 10 characters; see the character table, page 24, 47).
 - If not required, go to step 3.
- 3 **[OK]**
- 4 **[↕]**: Select the desired setting. → **[OK]** 2 times
- 5 **[OFF]**

Incoming call barring (Caller ID subscribers only)

This feature allows the unit to reject calls from specified phone numbers that you do not want to answer such as junk calls.

When a call is received, the unit does not ring while the caller is being identified. If the phone number matches an entry in the call barred list, the unit sends out a busy tone to the caller, and then disconnects the call.

Important:

- When the unit receives a call from a number that is stored in the call barred list, the call is logged in the caller list (page 34) with  after the call is disconnected.

Storing unwanted callers

You can store up to 30 phone numbers in the call barred list.

Important:

- You must store the phone number with an area code in the call barred list.

■ From the caller list:

- 1 **[←]** CID
- 2 **[↕]**: Select the entry to be barred.
- 3 **[SAVE]**
- 4 **[↕]**: "Caller Barred" → **[OK]**

- 5 **[↕]**: "Yes" → **[OK]**
- 6 **[OFF]**

■ By entering phone numbers:

- 1 **[MENU]** **[#]** **[2]** **[1]** **[7]** → **[ADD]**
- 2 Enter the phone number (24 digits max.).
 - To erase a digit, press **[CLEAR]**.
- 3 **[OK]** → **[OFF]**

Viewing/editing/erasing bar call numbers

- 1 **[MENU]** **[#]** **[2]** **[1]** **[7]**
- 2 **[↕]**: Select the desired entry.
 - To exit, press **[OFF]**.
- 3 **To edit a number:**
[EDIT] → Edit the phone number. → **[OK]** → **[OFF]**

To erase a number:

[ERASE] → **[↕]**: "Yes" → **[OK]** → **[OFF]**

Note:

- When editing, press the desired dial key to add, **[CLEAR]** to erase.

Caller ID Service

Using Caller ID service

Important:

- This unit is Caller ID compatible. To use Caller ID features, you must subscribe to a Caller ID service. Contact your service provider/telephone company for details.

Caller ID features

 Handset /  Base unit*1

*1 KX-TG3811/KX-TG3821 series: page 4

When an outside call is being received, the caller's phone number is displayed. Caller information for the last 50 callers is logged in the caller list from the most recent call to the oldest.

- If the unit cannot receive caller information, the following is displayed:
 - “**Out of Area**”: The caller dials from an area which does not provide a Caller ID service.
 - “**Private Caller**”: The caller requests not to send caller information.
- If the unit is connected to a PBX system, caller information may not be properly received. Contact your PBX supplier.
- If the name display service is available in your area, the display shows caller names. For further information, please contact your service provider/telephone company.

Missed calls

 Handset /  Base unit*1

*1 KX-TG3811/KX-TG3821 series: page 4

If a call is not answered, the unit treats it as a missed call. The display shows “**Missed call**”. This lets you know if you should view the caller list to see who called while you were away.

Note:

- Even when there are unviewed missed calls, “**Missed call**” disappears from the standby display if the following operation is performed by one of the units:

- A handset is replaced on the base unit or charger.
- Pressing [**OFF**] on a handset.
- Pressing [**EXIT**] on the base unit.

Phonebook name display

 Handset

When caller information is received and it matches a phone number stored in the phonebook, the stored name in the phonebook is displayed and logged in the caller list.

Note:

- The base unit display shows only caller information, not the stored name in the phonebook. (KX-TG3811/KX-TG3821 series: page 4)

Caller list

Important:

- Only 1 person can access the caller list at a time.
- Make sure the unit's date and time setting is correct (page 17).

Viewing the caller list and calling back

 Handset /  Base unit*1

*1 KX-TG3811/KX-TG3821 series: page 4

- 1 [**←**] CID
- 2 Press [**v**] to search from the most recent call, or [**▲**] to search from the oldest call.
 - If **▶** is displayed, not all of the information is shown. To see the remaining information, press [**▶**]. To return to the previous screen, press [**←**].
- 3 Proceed with the operation for your unit.

Handset:

 - To call back, press [**↶**].
 - To exit, press [**OFF**].

Base unit:

 - To call back, press [**SP-PHONE**].

Caller ID Service

– To exit, press **[EXIT]**.

Note:

- If the entry has already been viewed or answered, “✓” is displayed, even if it was viewed or answered using another unit.
- If you do not want to dial the area code when making calls from the caller list, you can store the area code which you want the unit to delete automatically (page 35).

Storing an area code to be deleted automatically

Available for:

KX-TG3711BX/KX-TG3712BX/
KX-TG3719BX/KX-TG3721BX/
KX-TG3722BX/KX-TG3811BX/
KX-TG3821BX/KX-TG3811JX/
KX-TG3821JX/KX-TG3822JX

In some situations, phone numbers stored automatically in the caller list (page 34) will include area codes. If you do not want to dial the area code when making calls from the caller list, you can store the area code which you want the unit to delete automatically.

Example: You have stored the area code “123”. If you make a call from the caller list to the phone number “123-456-7890”, the unit dials “456-7890”.

- 1 **[MENU]** **#** **2** **5** **5**
- 2 Enter your area code (5 digits max.).
- 3 **[OK]** → **[OFF]**

To erase your area code

- 1 **[MENU]** **#** **2** **5** **5**
- 2 Press and hold **[CLEAR]** until all digits erased. → **[OK]** → **[OFF]**

Editing a caller’s phone number before calling back

You can edit a phone number in the caller list.

Handset

- 1 **[←]** CID
- 2 **[↕]**: Select the desired entry.

- 3 **[EDIT]** → Add or erase digits to the beginning of the number as necessary.

- To add a digit, press the desired dial key.
- To erase a digit, press **[CLEAR]**.

- 4 **[↶]**

Base unit*1

*1 KX-TG3811/KX-TG3821 series: page 4

- 1 **[←]** CID
- 2 **[↕]**: Select the desired entry.
- 3 **[EDIT]** → Add or erase digits to the beginning of the number as necessary.
 - To add a digit, press the desired dial key.
 - To erase a digit, press **[ERASE]**.
- 4 **[SP-PHONE]**

Note:

- The edited phone number is not saved in the caller list.

Erasing selected caller information

Handset

- 1 **[←]** CID
- 2 **[↕]**: Select the desired entry.
- 3 **[ERASE]** → **[↕]**: “Yes” → **[OK]** → **[OFF]**

Base unit*1

*1 KX-TG3811/KX-TG3821 series: page 4

- 1 **[←]** CID
- 2 **[↕]**: Select the desired entry.
- 3 **[ERASE]** → **[↕]**: “Yes”
- 4 **[>]** → **[EXIT]**

Erasing all caller information

Handset

- 1 **[←]** CID
- 2 **[ERASE]** → **[↕]**: “Yes” → **[OK]** → **[OFF]**

Caller ID Service

Base unit*1

*1 KX-TG3811/KX-TG3821 series: page 4

- 1 [**←**] CID
- 2 [**ERASE**] → [**↕**]: "Yes"
- 3 [**▶**]

Storing caller information to the phonebook

Handset

- 1 [**←**] CID
- 2 [**↕**]: Select the desired entry.
- 3 [**SAVE**]
- 4 [**↕**]: "Phonebook" → [**OK**]
- 5 Continue from step 3, "Editing entries", page 25.

Answering System

Answering system

Available for:
KX-TG3721/KX-TG3821 series: page 3, 4

The answering system can answer and record calls for you when you are unavailable to answer the phone.

You can also set the unit to play a greeting message but not to record caller messages by selecting "Greeting Only" as the recording time setting (page 41).

Important:

- Only 1 person can access the answering system (listen to messages, record a greeting message, etc.) at a time.
- When callers leave messages, the unit records the day and time of each message. Make sure the date and time have been set correctly (page 17).
- Answering system announcements are in English only.

Memory capacity (including your greeting message)

The total recording capacity is about 18 minutes. A maximum of 64 messages can be recorded.

Note:

- When message memory becomes full:
 - "Messages Full" is shown on the handset and base unit*1 display.
 - The ANSWER ON/OFF indicator on the base unit flashes rapidly if the answering system is turned on.
 - The message counter on the base unit flashes if the answering system is turned on. (KX-TG3721 series: page 3)
 - If you use the pre-recorded greeting message, the unit automatically switches to another pre-recorded greeting message asking callers to call again later.
 - If you recorded your own greeting message, the same message is still announced to callers even though their messages are not recorded.

*1 KX-TG3821 series: page 4

Turning the answering system on/off

Base unit

Press **[ANSWER ON/OFF]** to turn on/off the answering system.

Handset

- To turn on:**
[MENU][#][3][2][7]
To turn off:
[MENU][#][3][2][8]
- [OFF]**

Note for base unit and handset:

- When the answering system is turned on:
 - The ANSWER ON/OFF indicator on the base unit lights up.
 - The message counter on the base unit displays the total number of messages (old and new). (KX-TG3721 series: page 3)
 -  is displayed next to the battery icon on the handset.

Call screening

While a caller is leaving a message, you can listen to the call through the unit's speaker.

Handset

To adjust the speaker volume, press **[▲]** or **[▼]** repeatedly. You can answer the call by pressing **[↶]**. Call screening can be set for each handset. The default setting is "on".

- [MENU][#][3][1][0]**
- [↕]:** Select the desired setting. → **[OK]**
→ **[OFF]**

Base unit*1

*1 KX-TG3821 series: page 4

To adjust the speaker volume, press **[▲]** or **[▼]** repeatedly. You can answer the call by pressing **[SP-PHONE]**.

To turn off while screening a call, press **[▼]** repeatedly until the sounds goes off.

Answering System

- If you adjust the speaker volume while listening to messages or having a conversation, the speaker volume for call screening is turned on again.

Greeting message

When the unit answers a call, a greeting message is played to callers.

You can use either:

- your own greeting message
- a pre-recorded greeting message

Recording your greeting message

- 1 [MENU]#302
- 2 [↕]: “Yes” → [OK]
- 3 After a beep sounds, hold the handset about 20 cm away and speak clearly into the microphone (2 minutes max.).
- 4 Press [STOP] to stop recording.
- 5 [OFF]

Using a pre-recorded greeting message

The unit provides 2 pre-recorded greeting messages:

- If you erase or do not record your own greeting message, the unit plays a pre-recorded greeting asking callers to leave a message.
- If the message recording time (page 41) is set to “Greeting Only”, callers’ messages are not recorded and the unit plays a different pre-recorded greeting message asking callers to call again.

Resetting to a pre-recorded greeting message

If you want to use a pre-recorded greeting message once you record your own greeting message, you need to erase your own greeting message.

- 1 [MENU]#304

- 2 [OK] → [OFF]

Playing back the greeting message

- 1 [MENU]#303
- 2 [OFF]

Listening to messages using the base unit

When new messages have been recorded:

- [▶] on the base unit flashes.
- “New Message” is displayed. (KX-TG3821 series: page 4)

Press [▶] (PLAY).

- If new messages have been recorded, the base unit plays back new messages.
- If there are no new messages, the base unit plays back all messages.

Operating the answering system during playback

Key	Operation
[+] or [–] ^{*1}	Adjust the speaker volume
[▲] or [▼] ^{*2}	
[◀◀]	Repeat message ^{*3}
[▶▶]	Skip message
[PAUSE] ^{*2}	Pause message To resume playback, press [▶] (PLAY).
[■] (STOP)	Stop playback
[ERASE]	Erase currently playing message

*1 KX-TG3721 series: page 3

*2 KX-TG3821 series: page 4

*3 If pressed within the first 5 seconds of a message, the previous message is played.

Answering System

Calling back (Caller ID subscribers only)

Available for:
KX-TG3821 series (page 4)

If caller information was received for the call, you can call the caller back while listening to a message.

Press **[SP-PHONE]** during playback.

- To edit the number before calling back, press **[EDIT]**. Add or erase digits to the beginning of the number as necessary.

Erasing all messages

Press **[ERASE]** 2 times while the unit is not in use.

Listening to messages using the handset

When new messages have been recorded, "New Message" is displayed.

- To listen to new messages:
[MENU] # [3] [2] [3]
To listen to all messages:
[MENU] # [3] [2] [4]
- When finished, press **[OFF]**.

Note:

- To switch to the receiver, press **[↶]**.

Operating the answering system

[MENU] → **[↕]**: "Answer System" → **[OK]**

Key	Operation
[▲] or [▼]	Adjust the receiver/speaker volume (during playback)
[1] or [◀]	Repeat message (during playback)*1
[2] or [▶]	Skip message (during playback)

Key	Operation
[3]	Enter the "Settings" menu
[4]	Play new messages
[5]	Play all messages
[6]	Play greeting message
[7] [6]	Record greeting message
[8]	Turn answering system on
[MENU]	Pause message*2
[9] or [STOP]	Stop recording Stop playback
[0]	Turn answering system off
[*] [4] *3	Erase currently playing message
[*] [5]	Erase all messages
[*] [6]	Reset to a pre-recorded greeting message

*1 If pressed within the first 5 seconds of a message, the previous message is played.

*2 To resume playback:

[↕]: "Play" → **[OK]**

*3 You can also erase as follows:

[ERASE] → **[↕]**: "Yes" → **[OK]**

Calling back (Caller ID subscribers only)

If caller information is received for the call, you can call the caller back while listening to a message.

- Press **[MENU]** during playback.
- [↕]**: "Call Back" → **[OK]**

Editing the number before calling back

- Press **[MENU]** during playback.
- [↕]**: "Edit & Call" → **[OK]**
- Edit the number. → **[↶]**

Answering System

Erasing all messages

- 1 [MENU]#325
- 2 [↕]: "Yes" → [OK] → [OFF]

Remote operation

Using a touch-tone phone, you can call your phone number from outside and access the unit to listen to messages or change answering system settings. The unit's voice guidance prompts you to press certain dial keys to perform different operations.

Remote access code

A 3-digit remote access code must be entered when operating the answering system remotely. This code prevents unauthorized parties from listening to your messages remotely. The default setting is "111".

Important:

- To prevent unauthorized access to this product, we recommend that you regularly change the remote code.

- 1 [MENU]#306
- 2 Enter the desired 3-digit remote access code.
- 3 [OK] → [OFF]

Deactivating remote operation

Press [X] in step 2 on "Remote access code", page 40.

- The entered remote access code is deleted.

Using the answering system remotely

- 1 Dial your phone number from a touch-tone phone.
- 2 After the greeting message starts, enter your remote access code.
- 3 Follow the voice guidance prompts as necessary or control the unit using remote commands (page 40).
- 4 When finished, hang up.

40

Voice guidance

During remote operation, the unit's voice guidance starts and prompts you to press [1] to perform a specific operation, or press [2] to listen to more available operations.

Note:

- If you do not press any dial keys within 10 seconds after a voice guidance prompt, the unit disconnects your call.

Remote commands

You can press dial keys to access certain answering system functions without waiting for the voice guidance to prompt you.

Key	Operation
[1]	Repeat message (during playback)*1
[2]	Skip message (during playback)
[4]	Play new messages
[5]	Play all messages
[6]	Play greeting message
[7]	Record greeting message
[9]	Stop recording Stop playback
[0]	Turn answering system off
[X]4	Erase currently playing message
[X]5	Erase all messages
[X]6	Reset to a pre-recorded greeting message (during greeting message playback)
[X]#	End remote operation (or hang up)

*1 If pressed within the first 5 seconds of a message, the previous message is played.

Turning on the answering system remotely

If the answering system is off, you can turn it on remotely.

Answering System

- 1 Dial your phone number from a touch-tone phone.
- 2 Let the phone ring 15 times.
 - A long beep is heard.
- 3 Enter your remote access code within 10 seconds after the long beep.
 - The greeting message is played back.
 - You can either hang up, or enter your remote access code again and begin remote operation (page 40).

Answering system settings

Number of rings before the unit answers a call

You can change the number of times the phone rings "**Number of Rings**" before the unit answers calls. You can select 2 to 7 rings, or "**Toll Saver**".

The default setting is "**4 Rings**".

"**Toll Saver**": The unit's answering system answers at the end of the 2nd ring when new messages have been recorded, or at the end of the 5th ring when there are no new messages. If you call your phone from outside to listen to new messages (page 40), you know that there are no new messages when the phone rings for the 3rd time. You can then hang up without being charged for the call.

- 1 **[MENU]#211**
- 2 **[+]**: Select the desired setting. → **[OK]**
→ **[OFF]**

For voice mail service subscribers

To receive voice mail and use answering system properly, please note the following:

- To use the voice mail service provided by your service provider/telephone company rather than the unit's answering system, turn off the answering system (page 37).
- To use this unit's answering system rather than the voice mail service provided by your service provider/telephone company, please contact your service provider/telephone company to deactivate your voice mail service.

If your service provider/telephone company cannot do this:

- Set this unit's "**Number of Rings**" setting so that this unit's answering system answers calls before the voice mail service of your service provider/telephone company does. It is necessary to check the number of rings required to activate the voice mail service provided by your service provider/telephone company before changing this setting.
- Change the number of rings of the voice mail service so that the answering system can answer the call first. To do so, contact your service provider/telephone company.

Caller's recording time

You can change the maximum message recording time allowed for each caller. The default setting is "**3 Minutes**".

- 1 **[MENU]#305**
- 2 **[+]**: Select the desired setting. → **[OK]**
→ **[OFF]**

Selecting "Greeting Only"

You can select "**Greeting Only**" which sets the unit to announce a greeting message to callers but not record messages.

Select "**Greeting Only**" in step 2 on "Caller's recording time", page 41.

Note:



- When you select "**Greeting Only**":
 - If you do not record your own message, the unit will play the pre-recorded greeting-only message asking callers to call again later.
 - If you use your own message, record the greeting-only message asking callers to call again later (page 38).

Voice Mail Service

Voice mail service

Voice mail is an automatic answering service offered by your service provider/telephone company. After you subscribe to this service, your service provider/telephone company's voice mail system answers calls for you when you are unavailable to answer the phone or when your line is busy. Messages are recorded by your service provider/telephone company, not your telephone. When you have new messages,  is displayed if message indication service is available. Please contact your service provider/telephone company for details of this service.

Important:

- If  still remains on the display even after you have listened to new messages, turn it off by pressing and holding  for 2 seconds.
- To use the voice mail service provided by your service provider/telephone company rather than the unit's answering system, turn off the answering system (page 37). For details, see page 41. (KX-TG3721/KX-TG3821 series: page 3, 4)

Intercom/Locator

Intercom

Intercom calls can be made:

- between handsets (KX-TG3712/
KX-TG3722/KX-TG3822)
- between a handset and the base unit
(KX-TG3811/KX-TG3821 series: page 4)

Note:

- If you receive an outside call while talking on the intercom, you hear 2 tones.
 - To answer the call with the handset, press **[OFF]**, then press **[↶]**.
 - To answer the call with the base unit, press **[SP-PHONE]** 2 times.
(KX-TG3811/KX-TG3821 series: page 4)
- When paging unit(s), the paged unit(s) beeps for 1 minute.

Making an intercom call

Handset

- 1 **[MENU]** → **[INT]**
- 2 **[↕]**: Select the desired unit. → **[OK]**
 - To stop paging, press **[OFF]**.
- 3 When you finish talking, press **[OFF]**.

Base unit*1

*1 KX-TG3811/KX-TG3821 series: page 4

- 1 Press **[INTERCOM]**.
When 2 or more handsets are registered:
 - To page a specific handset, enter the handset number.
 - To page all handsets, press **[0]** or wait for a few seconds.
 - To stop paging, press **[INTERCOM]**.
- 2 When you finish talking, press **[INTERCOM]**.

Answering an intercom call

Handset

- 1 Press **[↶]** to answer the page.
- 2 When you finish talking, press **[OFF]**.

Base unit*1

*1 KX-TG3811/KX-TG3821 series: page 4

- 1 Press **[INTERCOM]** to answer the page.
- 2 When you finish talking, press **[INTERCOM]**.

Handset locator

You can locate a misplaced handset by paging it.

- 1 **Base unit:** Press **[LOCATOR]**.
 - All registered handsets beep for 1 minute.
- 2 To stop paging:
Base unit: Press **[LOCATOR]**.
Handset:
 - **KX-TG3711/KX-TG3721 series: page 3**
Press **[OFF]**.
 - **KX-TG3811/KX-TG3821 series: page 4**
Press **[↶]**, then press **[OFF]**.

Intercom/Locator

Transferring calls, conference calls

Outside calls can be transferred or a conference call with an outside party can be made:

- between 2 handsets (KX-TG3712/KX-TG3722/KX-TG3822)
- between a handset and the base unit (KX-TG3811/KX-TG3821 series: page 4)

Handset

- 1** During an outside call, press **[INT]** to put the call on hold.
- 2** **[↕]**: Select the desired unit. → **[OK]**
- 3** Wait for the paged party to answer.
 - If the paged party does not answer, press **[BACK]** to return to the outside call.
- 4** **To complete the transfer:**
Press **[OFF]**.
 - The outside call is being routed to the destination unit.**To establish a conference call:**
[MENU] → **[↕]**: "Conference" → **[OK]**
 - To leave the conference, press **[OFF]**. The other 2 parties can continue the conversation.
 - To put the outside call on hold: **[MENU]** → **[↕]**: "Hold" → **[OK]**
To resume the conference: **[MENU]** → **[↕]**: "Conference" → **[OK]**

Base unit*1

*1 KX-TG3811/KX-TG3821 series: page 4

- 1** During an outside call, press **[INTERCOM]**.
When 2 or more handsets are registered:
 - To page a specific handset, enter the handset number.
 - To page all handsets, press **[0]** or wait for a few seconds.
- 2** Wait for the paged party to answer.

- If paged party does not answer, press **[INTERCOM]** to return to the outside call.

3 To complete the transfer:

Press **[SP-PHONE]**.

- The outside call is being routed to the handset.

To establish a conference call:

Press **[CONF]**.

- To leave the conference, press **[SP-PHONE]**. The other 2 parties can continue the conversation.
- To put the outside call on hold, press **[HOLD]**. To resume the conference, press **[CONF]**.

Answering a transferred call

Handset

Press **[↶]** to answer the page.

Base unit*1

*1 KX-TG3811/KX-TG3821 series: page 4

Press **[SP-PHONE]** to answer the page.

Useful Information

Wall mounting

Note:

- Make sure that the wall and the fixing method are strong enough to support the weight of the unit.
- Drive the screws (not supplied) into the wall.

**Base unit (KX-TG3711/
KX-TG3721 series: page 3)**

■ **KX-TG3711 series: page 3**

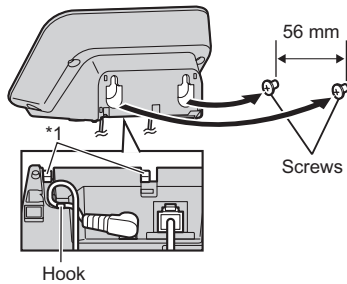

■ **KX-TG3721 series: page 3**

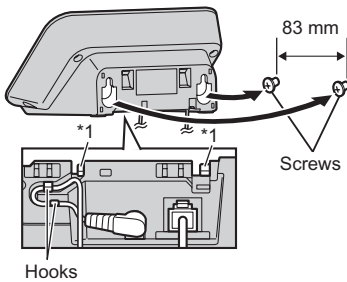

*1 When mounting the base unit on a wall, do not pass the cords through these hooks.

**Base unit (KX-TG3811/
KX-TG3821 series: page 4)**

The base unit can be mounted on a wall by revolving the bracket to "WALL" position (default: "DESK" stand position).

- 1 Turn the bracket 180 degrees counterclockwise in the "WALL" direction until a click is heard.

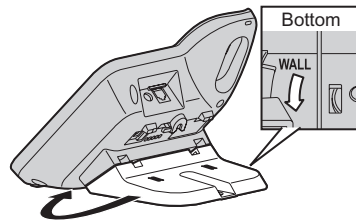

- The bracket cannot be removed. Do not turn the bracket more than 180 degrees.

- 2 Tuck in the telephone line cord (1). Connect the AC adaptor cord and telephone line cord (2).

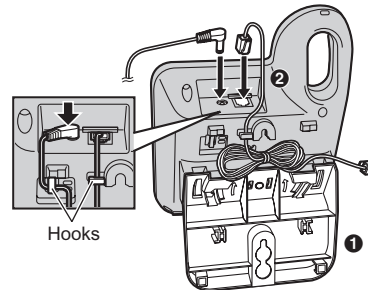

Useful Information

- 3** Mount the unit on a wall then slide down to secure in place.

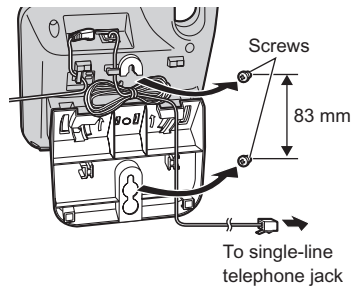

To stand on a desk

Turn the bracket 180 degrees clockwise from the "WALL" position to the "DESK" direction until a click is heard.

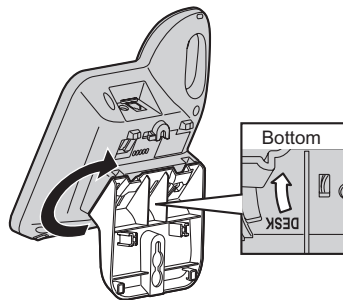

Charger

Drive the screws (not supplied) into the wall.

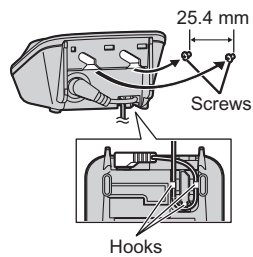

Useful Information

Character entry

Available for:
 KX-TG3711BX/KX-TG3712BX/KX-TG3719BX/KX-TG3721BX/KX-TG3722BX/
 KX-TG3811BX/KX-TG3821BX/KX-TG3811JX/KX-TG3821JX/KX-TG3822JX

The dial keys are used to enter characters and numbers. Each dial key has multiple characters assigned to it. The characters that can be entered depend on the character entry mode (page 47).

- Press [←] or [→] to move the cursor left or right.
- Press dial keys to enter characters and numbers.
- Press [CLEAR] to erase the character or number highlighted by the cursor. Press and hold [CLEAR] to erase all characters or numbers.
- Press [A→a] to switch between uppercase and lowercase.
- If you do not press any dial key within 5 seconds after entering a character, the character is fixed and the cursor moves to the next space.
- When entering another character located on the same dial key, operation will differ depending on the display language you select.

English

- Press [→] to move the cursor to the next space, then press the appropriate dial key.

Arabic/Persian

- Press [←] to move the cursor to the next space, then press the appropriate dial key.

Character entry modes

The available character entry modes are Alphabet (ABC), Numeric (0-9), Arabic/Persian (أبج) and Extended (AAA). When in these entry modes except Numeric, you can select which character is entered by pressing a dial key repeatedly.

When the unit displays the character entry screen:
 [1/A/?] → [↕]: Select a character entry mode. → [OK]

Note:

- _ in the following tables represents a single space.
- When you select Arabic or Persian as the display language, numbers in the character table are displayed in Arabic or Persian.

Alphabet character table (ABC)

0 _	1 &'() * , - .	2 ABC	3 DEF	4 GHI	5 JKL	6 MNO	7 PQRS	8 TUV	9 WXYZ	#
_ 0	& ' () * , - . / 1	A B C 2 a b c 2	D E F 3 d e f 3	G H I 4 g h i 4	J K L 5 j k l 5	M N O 6 m n o 6	P Q R 7 p q r s 7	T U V 8 t u v 8	W X Y 9 w x y 9	#

Numeric entry table (0-9)

0 _	1 &'()	2 ABC	3 DEF	4 GHI	5 JKL	6 MNO	7 PQRS	8 TUV	9 WXYZ	#
0	1	2	3	4	5	6	7	8	9	#

Useful Information

Arabic character table (أبجد)

- When you select Arabic as the display language, Arabic character table is available.

0	1	2	3	4	5	6	7	8	9	#
٠	١	٢	٣	٤	٥	٦	٧	٨	٩	#

Persian character table (أبجد)

- When you select Persian as the display language, Persian character table is available.

0	1	2	3	4	5	6	7	8	9	#
٠	١	٢	٣	٤	٥	٦	٧	٨	٩	#

Extended character table (AĀĀ)

0	1	2	3	4	5	6	7	8	9	#
0	& ' () * , - . / 1	A Ā Á Â Ã Ä Å Æ B C Ç 2	D E Ê Ë Ì Í Î Ï 3	G Ğ H I Î Ï Ĵ 4	J K L 5	M N Ñ O Ò Ó Ô Õ Ö ø 6	P Q R S Ş ß 7	T U Û Ü Ü Ü Û V 8	W Ŵ X Y Ŷ Z 9	#
		a à á â ã ä å æ b c ç 2	d e è é ê ë ë f 3 4	g ğ h i î ï ĵ 4	j k l 5	m n ñ o ò ó ô õ ö ø 6	p q r s ş ş ß 7	t u ù ú û ü ü v 8	w ŵ x y ŷ z 9	

- The following are used for both uppercase and lowercase: ø Ş Ŵ Ŷ

Useful Information

Error messages

Display message	Cause/solution
Base no power or No link. Reconnect AC adaptor. or No link.	<ul style="list-style-type: none"> • The handset has lost communication with the base unit. Move closer to the base unit and try again. • Unplug the base unit's AC adaptor to reset the unit. Reconnect the adaptor and try again. • The handset's registration may have been canceled. Re-register the handset (page 54). • When "No link." is displayed during a power failure, place a handset on the base unit to supply power to the base unit.
Check Phone Line	<ul style="list-style-type: none"> • The supplied telephone line cord has not been connected yet or not connected properly. Check the connections (page 9).
Dial Locked	<ul style="list-style-type: none"> • Dial lock is turned on. To turn it off, see page 21.
Error	<ul style="list-style-type: none"> • Recording was too short. Try again.^{*1} • The entered password was wrong in programming dial lock. Enter the correct password.
Failed^{*2}	<ul style="list-style-type: none"> • Phonebook copy failed (page 26). Confirm the other handset (the receiver) is in standby mode and try again.
Incomplete^{*2}	<ul style="list-style-type: none"> • The receiver's phonebook memory is full. Erase the unwanted phonebook entries from the other handset (the receiver) and try again.
Memory Full	<ul style="list-style-type: none"> • The phonebook memory is full. Erase unwanted entries (page 25). • Message memory is full. Erase unwanted messages (page 38, 39).^{*1} • The call barred list memory is full. Erase unwanted entries (page 33).
Use rechargeable battery.	<ul style="list-style-type: none"> • A wrong type of battery such as Alkaline or Manganese was inserted. Use only the rechargeable Ni-MH batteries noted on page 5, 7.
You must first subscribe to Caller ID.	<ul style="list-style-type: none"> • You must subscribe to a Caller ID service. Once you receive caller information after subscribing to a Caller ID service, this message will not be displayed.

*1 KX-TG3721/KX-TG3821 series: page 3, 4

*2 KX-TG3712/KX-TG3722/KX-TG3822

Useful Information

Troubleshooting

If you still have difficulties after following the instructions in this section, disconnect the base unit's AC adaptor, then reconnect the base unit's AC adaptor. Remove the batteries from the handset, and then insert the batteries into the handset again.

General use

Problem	Cause/solution
The handset does not turn on even after installing charged batteries.	<ul style="list-style-type: none"> Place the handset on the base unit or charger to turn on the handset.
The unit does not work.	<ul style="list-style-type: none"> Make sure the batteries are installed correctly (page 10). Fully charge the batteries (page 10). Check the connections (page 9). Unplug the base unit's AC adaptor to reset the unit. Reconnect the adaptor and try again. The handset has not been registered to the base unit. Register the handset (page 54).
I cannot hear a dial tone.	<ul style="list-style-type: none"> The base unit's AC adaptor or telephone line cord is not connected. Check the connections. Disconnect the base unit from the telephone line and connect the line to a known working telephone. If the working telephone operates properly, contact our service personnel to have the unit repaired. If the working telephone does not operate properly, contact your service provider/telephone company.
I cannot use the intercom feature. ^{*1}	<ul style="list-style-type: none"> This feature is available between the handset and base unit, or between handsets. Although the handset displays "Intercom", this feature is not available for this model.
I cannot use the phonebook copy feature. ^{*2}	<ul style="list-style-type: none"> This feature is available between the handsets. Although the handset displays "Copy All" or "Copy", this feature is not available for this model.

*1 KX-TG3711/KX-TG3719/KX-TG3721

*2 KX-TG3711/KX-TG3719/KX-TG3721/KX-TG3811/KX-TG3821



Programmable settings

Problem	Cause/solution
The display is in a language I cannot read.	<ul style="list-style-type: none"> Change the display language (page 17).^{*1}
While programming, the display returns to standby mode.	<ul style="list-style-type: none"> A call matching an entry in the call barred list is being received. Wait and try again later.

*1 KX-TG3711BX/KX-TG3712BX/KX-TG3719BX/KX-TG3721BX/KX-TG3722BX/
KX-TG3811BX/KX-TG3821BX/KX-TG3811JX/KX-TG3821JX/KX-TG3822JX

Useful Information

Battery recharge

Problem	Cause/solution
The handset beeps and/or  flashes.	<ul style="list-style-type: none"> • Battery charge is low. Fully charge the batteries (page 10).
I fully charged the batteries, but <ul style="list-style-type: none"> –  still flashes or – the operating time seems to be shorter. 	<ul style="list-style-type: none"> • Clean the battery ends (\oplus, \ominus) and the charge contacts with a dry cloth and charge again. • It is time to replace the batteries (page 10).

Making/answering calls, intercom

Problem	Cause/solution
 is displayed.	<ul style="list-style-type: none"> • The handset is too far from the base unit. Move closer. • The base unit's AC adaptor is not properly connected. Reconnect AC adaptor to the base unit. • The handset is not registered to the base unit. Register it (page 54).
Noise is heard, sound cuts in and out.	<ul style="list-style-type: none"> • You are using the handset or base unit in an area with high electrical interference. Re-position the base unit and use the handset away from sources of interference. • Move closer to the base unit. • If you use a DSL/ADSL service, we recommend connecting a DSL/ADSL filter between the base unit and the telephone line jack. Contact your DSL/ADSL provider for details.
The handset does not ring.	<ul style="list-style-type: none"> • The ringer volume is turned off. Adjust the ringer volume (page 19). • Night mode is turned on. Turn it off (page 32).
The base unit does not ring. ^{*1}	<ul style="list-style-type: none"> • The ringer volume is turned off. Adjust the ringer volume (page 19, 29).
I cannot make a call.	<ul style="list-style-type: none"> • The dialing mode may be set incorrectly. Change the setting (page 17). • The handset is too far from the base unit. Move closer and try again. • Another unit is in use.^{*2} Wait and try again later. • Answering system is being used.^{*3} Wait and try again later. • Dial lock is turned on. To turn it off, see page 21.

*1 KX-TG3721/KX-TG3811/KX-TG3821 series: page 3, 4

*2 KX-TG3712, KX-TG3722, KX-TG3811/KX-TG3821 series (page 4)

*3 KX-TG3721/KX-TG3821 series: page 3, 4

Useful Information

Caller ID

Problem	Cause/solution
Caller information is not displayed.	<ul style="list-style-type: none"> You must subscribe to a Caller ID service. Contact your service provider/telephone company for details. If your unit is connected to any additional telephone equipment such as a Caller ID box or cordless telephone line jack, plug the unit directly into the wall jack. If you use a DSL/ADSL service, we recommend connecting a DSL/ADSL filter between the base unit and the telephone line jack. Contact your DSL/ADSL provider for details. Other telephone equipment may be interfering with this unit. Disconnect the other equipment and try again.
Caller information is displayed late.	<ul style="list-style-type: none"> Depending on your service provider/telephone company, the unit may display the caller's information at the 2nd ring or later. Move closer to the base unit.
Time on the unit has shifted.	<ul style="list-style-type: none"> Incorrect time information from incoming Caller ID changes the time. Set the time adjustment to "Manual" (off) (page 29).
The name stored in the phonebook is not fully displayed while an outside call is being received.	<ul style="list-style-type: none"> Edit the phonebook entry name to fit in 1 line of text (page 25).

Answering system (KX-TG3721/KX-TG3821 series: page 3, 4)

Problem	Cause/solution
The unit does not record new messages.	<ul style="list-style-type: none"> The answering system is turned off. Turn it on (page 37). The message memory is full. Erase unwanted messages (page 38). The recording time is set to "Greeting Only". Change the setting (page 41). If your own greeting message is not recorded properly, callers are unable to leave a message. Record your own greeting message again (page 38). If you subscribe to a voice mail service, messages are recorded by your service provider/telephone company, not your telephone. Change the unit's number of rings setting or contact your service provider/telephone company (page 41).
My own greeting message cannot be properly heard.	<ul style="list-style-type: none"> Record your own greeting message again (page 38).
I cannot operate the answering system.	<ul style="list-style-type: none"> Someone is using the unit. Wait for the other user to finish. A caller is leaving a message. Wait for the caller to finish. The handset is too far from the base unit. Move closer.

Useful Information

Problem	Cause/solution
I cannot operate the answering system remotely.	<ul style="list-style-type: none"> • The remote access code is not set. Set the remote access code (page 40). • You are entering the wrong remote access code. If you have forgotten your remote access code, enter the remote access code setting to check your current code (page 40). • Press each key firmly. • The answering system is turned off. Turn it on (page 40).

Dial lock

Important:

- Anyone can turn off the dial lock using the following method. Be sure to keep these operating instructions in a safe place in order to prevent unauthorized persons from using your phone without permission.

Problem	Cause/solution
I cannot remember the dial lock password.	<ul style="list-style-type: none"> • Turn the dial lock off using the following method. Handset / Base unit^{*1} *1 KX-TG3811/KX-TG3821 series: page 4 <ol style="list-style-type: none"> 1 Proceed with the operation for your unit. Handset: [MENU]# [2] [5] [1] Base unit: [DIAL LOCK] 2 Press [*] [7] [0] [0] [0]. 3 Proceed with the operation for your unit. Handset: [OK] 2 times → [OFF] Base unit: [▶] 2 times

Liquid damage

Problem	Cause/solution
Liquid or other form of moisture has entered the handset/base unit.	<ul style="list-style-type: none"> • Disconnect the AC adaptor and telephone line cord from the base unit. Remove the batteries from the handset and leave to dry for at least 3 days. After the handset/base unit are completely dry, reconnect the AC adaptor and telephone line cord. Insert the batteries and charge fully before use. If the unit does not work properly, contact an authorized service center.

Caution:

- To avoid permanent damage, do not use a microwave oven to speed up the drying process.

Useful Information

Registering a handset to the base unit

- 1 Handset:**
[MENU] [2] [1] [3] [0]
- 2 Base unit:**
 - **KX-TG3711 series: page 3**
Press and hold [LOCATOR] for about 5 seconds. (No registration tone)
 - **KX-TG3721/KX-TG3811/KX-TG3821 series: page 3, 4**
Press and hold [LOCATOR] for about 5 seconds until the registration tone sounds.
 - If all registered handsets start ringing, press [LOCATOR] again to stop, then repeat this step. (KX-TG3712/KX-TG3722/KX-TG3822)
 - The next step must be completed within 90 seconds.
- 3 Handset:**
Press [OK], then wait until a long beep sounds.
Note:
 - While registering, "Base in registering" is displayed on all registered handsets. (KX-TG3712/KX-TG3722/KX-TG3822)

Deregistering a handset

- 1 [MENU] [2] [1] [3] [1]**
 - All handsets registered to the base unit are displayed.
- 2 [↕]:** Select the handset you want to cancel. → [OK]
- 3 [↕]:** "Yes" → [OK]
- 4 [OFF]**

Index

- A** Alarm: 32
- Answering calls: 19
- Answering system
 - Call screening: 37
 - Erasing messages: 38, 39, 40
 - Greeting message: 38
 - Greeting only: 41
 - Listening to messages: 38, 39, 40
 - Number of rings: 41
 - Recording time: 41
 - Remote access code: 40
 - Remote operation: 40
 - Toll saver: 41
 - Turning on/off: 37, 39, 40
- Area code: 35
- Auto talk: 19
- B** Battery: 10, 11
- Belt clip: 15
- Booster (Clarity booster): 21
- C** Caller ID service: 34
- Caller list: 34
- Caller list edit: 35
- Call share: 21
- Call waiting: 20
- Call Waiting Caller ID: 20
- Chain dial: 25
- Character entry: 24, 47
- CID (Caller ID): 34
- Conference calls: 44
- Control type: 12, 13, 14, 15
- D** Date and time: 17
- Dialing mode: 17
- Dial lock: 21
- Direct command code: 27
- Display
 - Contrast: 29
 - Language: 17
- E** Emergency numbers: 24
- Equalizer: 21
- Error messages: 49
- F** Flash: 20, 30
- H** Handset
 - Deregistration: 54
 - Locator: 43
 - Name: 33
 - Registration: 54
 - Hold: 20
- I** Incoming call barring: 33
- Intercom: 43
- K** Key tone: 29
- M** Making calls: 18
- Missed calls: 34
- Mute: 20
- N** Night mode: 32
- P** Pause: 18
- Phonebook: 24
- Power failure (power back-up operation): 22
- Privacy mode: 30
- R** Redialing: 18
- Ringer tone: 29
- Rotary/pulse service: 21
- S** SP-PHONE (Speakerphone): 18
- T** Temporary tone dialing: 21
- Time adjustment: 29
- Transferring calls: 44
- Troubleshooting: 50
- V** Voice mail: 41, 42
- Volume
 - Receiver: 18
 - Ringer (Base unit): 19, 29
 - Ringer (Handset): 19, 29
 - Speaker: 18
- W** Wall mounting: 45



For your future reference

We recommend keeping a record of the following information to assist with any repair under warranty.

Serial No.

Date of purchase

(found on the bottom of the base unit)

Name and address of dealer

Attach your purchase receipt here.

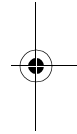
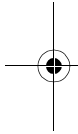

Panasonic System Networks Co., Ltd.

1-62, 4-chome, Minoshima, Hakata-ku, Fukuoka 812-8531, Japan

Web Site: <http://www.panasonic.net/>

© Panasonic System Networks Co., Ltd. 2011



TG3711 BX

PNQX3187ZA TC0611MG0

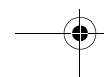
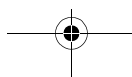

Free Manuals Download Website

<http://myh66.com>

<http://usermanuals.us>

<http://www.somanuals.com>

<http://www.4manuals.cc>

<http://www.manual-lib.com>

<http://www.404manual.com>

<http://www.luxmanual.com>

<http://aubethermostatmanual.com>

Golf course search by state

<http://golfingnear.com>

Email search by domain

<http://emailbydomain.com>

Auto manuals search

<http://auto.somanuals.com>

TV manuals search

<http://tv.somanuals.com>