

Panasonic®

Operating Instructions

Digital Cordless Phone

Model No. **KX-TG6411BX**

KX-TG6412BX

KX-TG6413BX

Digital Cordless Answering System

Model No. **KX-TG6421BX**

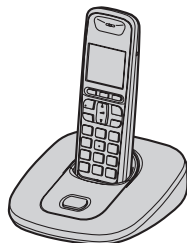

Model shown is KX-TG6411.

Thank you for purchasing a Panasonic product.

This unit is compatible with Caller ID. You must subscribe to the appropriate service offered by your service provider/telephone company.

Charge the batteries for about 7 hours before initial use.

Please read these operating instructions before using the unit and save them for future reference.

Table of Contents

Introduction		Voice Mail Service	
Model composition	3	Voice mail service	33
Accessory information	4	Intercom/Locator	
Important Information		Intercom	34
For your safety	5	Handset locator	34
Important safety instructions	6	Transferring calls, conference calls	34
For best performance	6	Useful Information	
Specifications	7	Character entry	36
Getting Started		Error messages	38
Setting up	8	Troubleshooting	39
Note when setting up	9	Wall mounting	44
Controls	10	Index	
Display	11	Index	45
Turning the power on/off	12		
Initial settings	12		
Making/Answering Calls			
Making calls	14		
Answering calls	14		
Useful features during a call	15		
Key lock	16		
Phonebook			
Handset phonebook	17		
Copying phonebook entries	18		
Programming			
Programmable settings	19		
Special programming	21		
Registering a unit	23		
Caller ID Service			
Using Caller ID service	25		
Caller list	25		
Answering System			
Answering system	27		
Turning the answering system on/off	27		
Greeting message	28		
Listening to messages using the base unit	28		
Listening to messages using the handset	29		
Remote operation	30		
Answering system settings	31		

Introduction

Model composition

Series	Model No.	Base unit	Handset	
		Part No.	Part No.	Quantity
KX-TG6411 series	KX-TG6411	KX-TG6411	KX-TGA641	1
	KX-TG6412	KX-TG6411	KX-TGA641	2
	KX-TG6413	KX-TG6411	KX-TGA641	3
KX-TG6421 series	KX-TG6421	KX-TG6421	KX-TGA641	1

- The suffix (BX) in the following model numbers will be omitted in these instructions: KX-TG6411BX/KX-TG6412BX/KX-TG6413BX/KX-TG6421BX
- References in these operating instructions to the charger and multiple handsets are for KX-TG6412/KX-TG6413 only.

Feature differences

Series	Answering system	Intercom
		Between handsets
KX-TG6411 series	–	●*1
KX-TG6421 series	●	–

*1 KX-TG6412/KX-TG6413

Introduction

Accessory information

Supplied accessories

No.	Accessory item/Part number	Quantity		
		KX-TG6411 KX-TG6421	KX-TG6412	KX-TG6413
①	AC adaptor/PQLV219BX	1	2	3
②	Telephone line cord	1	1	1
③	Rechargeable batteries ^{*1/} HHR-55AAAB or N4DHYYY00001	2	4	6
④	Handset cover ^{*2}	1	2	3
⑤	Charger	—	1	2

*1 See page 4 for replacement battery information.

*2 The handset cover comes attached to the handset.

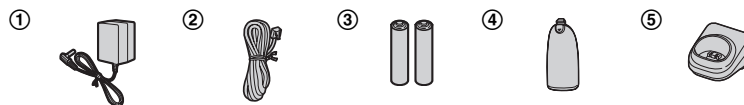

Additional/replacement accessories

Please contact your nearest Panasonic dealer for sales information.

Accessory item	Model number
Rechargeable batteries	HHR-4MPT ^{*1}
	Battery type: – Nickel metal hydride (Ni-MH). – 2 x AAA (R03) size for each handset.
DECT repeater	KX-A272

*1 Replacement batteries may have a different capacity from that of the supplied batteries.

Important Information

For your safety

To prevent severe injury and loss of life/property, read this section carefully before using the product to ensure proper and safe operation of your product.

WARNING

Power connection

- Use only the power source marked on the product.
- Do not overload power outlets and extension cords. This can result in the risk of fire or electric shock.
- Completely insert the AC adaptor/power plug into the power outlet. Failure to do so may cause electric shock and/or excessive heat resulting in a fire.
- Regularly remove any dust, etc. from the AC adaptor/power plug by pulling it from the power outlet, then wiping with a dry cloth. Accumulated dust may cause an insulation defect from moisture, etc. resulting in a fire.
- Unplug the product from power outlets if it emits smoke, an abnormal smell, or makes an unusual noise. These conditions can cause fire or electric shock. Confirm that smoke has stopped emitting and contact an authorised service centre.
- Unplug from power outlets and never touch the inside of the product if its casing has been broken open.
- Never touch the plug with wet hands. Danger of electric shock exists.

Installation

- To prevent the risk of fire or electrical shock, do not expose the product to rain or any type of moisture.
- Do not place or use this product near automatically controlled devices such as automatic doors and fire alarms. Radio waves emitted from this product may cause such devices to malfunction resulting in an accident.
- Do not allow the AC adaptor or telephone line cord to be excessively pulled, bent or placed under heavy objects.

Operating safeguards

- Unplug the product from power outlets before cleaning. Do not use liquid or aerosol cleaners.
- Do not disassemble the product.
- Do not spill liquids (detergents, cleansers, etc.) onto the telephone line cord plug, or allow it to become wet at all. This may cause a fire. If the telephone line cord plug becomes wet, immediately pull it from the telephone wall jack, and do not use.

Medical

- Consult the manufacturer of any personal medical devices, such as pacemakers or hearing aids, to determine if they are adequately shielded from external RF (radio frequency) energy. (The product operates in the frequency range of 1.88 GHz to 1.90 GHz, and the RF transmission power is 250 mW (max..))
- Do not use the product in health care facilities if any regulations posted in the area instruct you not to do so. Hospitals or health care facilities may be using equipment that could be sensitive to external RF energy.

CAUTION

Installation and relocation

- Never install telephone wiring during an electrical storm.
- Never install telephone line jacks in wet locations unless the jack is specifically designed for wet locations.
- Never touch uninsulated telephone wires or terminals unless the telephone line has been disconnected at the network interface.
- Use caution when installing or modifying telephone lines.
- The AC adaptor is used as the main disconnect device. Ensure that the AC outlet is installed near the product and is easily accessible.
- This product is unable to make calls when:
 - the handset batteries need recharging or have failed.
 - there is a power failure.
 - the key lock feature is turned on.

Important Information

Battery

- We recommend using the batteries noted on page 4. **USE ONLY rechargeable Ni-MH batteries AAA (R03) size.**
- Do not mix old and new batteries.
- Do not open or mutilate the batteries. Released electrolyte from the batteries is corrosive and may cause burns or injury to the eyes or skin. The electrolyte is toxic and may be harmful if swallowed.
- Exercise care when handling the batteries. Do not allow conductive materials such as rings, bracelets, or keys to touch the batteries, otherwise a short circuit may cause the batteries and/or the conductive material to overheat and cause burns.
- Charge the batteries provided with or identified for use with this product only, in accordance with the instructions and limitations specified in this manual.
- Only use a compatible base unit (or charger) to charge the batteries. Do not tamper with the base unit (or charger). Failure to follow these instructions may cause the batteries to swell or explode.

Important safety instructions

When using your product, basic safety precautions should always be followed to reduce the risk of fire, electric shock, and injury to persons, including the following:

1. Do not use this product near water for example, near a bathtub, washbowl, kitchen sink, or laundry tub, in a wet basement or near a swimming pool.
2. Avoid using a telephone (other than a cordless type) during an electrical storm. There may be a remote risk of electric shock from lightning.
3. Do not use the telephone to report a gas leak in the vicinity of the leak.
4. Use only the power cord and batteries indicated in this manual. Do not dispose of batteries in a fire. They may explode. Check with local codes for possible special disposal instructions.

SAVE THESE INSTRUCTIONS

For best performance

Base unit location/avoiding noise

The base unit and other compatible Panasonic units use radio waves to communicate with each other.

- For maximum coverage and noise-free communications, place your base unit:
 - at a convenient, high, and central location with no obstructions between the handset and base unit in an indoor environment.
 - away from electronic appliances such as TVs, radios, personal computers, wireless devices, or other phones.
 - facing away from radio frequency transmitters, such as external antennas of mobile phone cell stations. (Avoid putting the base unit on a bay window or near a window.)
- Coverage and voice quality depends on the local environmental conditions.
- If the reception for a base unit location is not satisfactory, move the base unit to another location for better reception.

Environment

- Keep the product away from electrical noise generating devices, such as fluorescent lamps and motors.
- The product should be kept free from excessive smoke, dust, high temperature, and vibration.
- The product should not be exposed to direct sunlight.
- Do not place heavy objects on top of the product.
- When you leave the product unused for a long period of time, unplug the product from the power outlet.
- The product should be kept away from heat sources such as radiators, cookers, etc. It should not be placed in rooms where the temperature is less than 0 °C or greater than 40 °C. Damp basements should also be avoided.
- The maximum calling distance may be shortened when the product is used in the following places: Near obstacles such as hills, tunnels, underground, near metal objects such as wire fences, etc.

Important Information

- Operating the product near electrical appliances may cause interference. Move away from the electrical appliances.

Routine care

- **Wipe the outer surface of the product with a soft moist cloth.**
- Do not use benzine, thinner, or any abrasive powder.

Notice for product disposal, transfer, or return

- This product can store your private/confidential information. To protect your privacy/confidentiality, we recommend that you erase information such as phonebook or caller list entries from the memory before you dispose of, transfer, or return the product.

Information on Disposal in other Countries outside the European Union



These symbols are only valid in the European Union. If you wish to discard these items, please contact your local authorities or dealer and ask for the correct method of disposal.

Specifications

- **Standard:**
DECT (Digital Enhanced Cordless Telecommunications),
GAP (Generic Access Profile)
- **Frequency range:**
1.88 GHz to 1.90 GHz
- **RF transmission power:**
Approx. 10 mW (average power per channel)
- **Power source:**
220–240 V AC, 50/60 Hz
- **Power consumption:**
Base unit*¹:
Standby: Approx. 0.7 W
Maximum: Approx. 3.8 W
Base unit*²:
Standby: Approx. 0.8 W
Maximum: Approx. 4.2 W
Charger:
Standby: Approx. 0.2 W
Maximum: Approx. 3.2 W
- **Operating conditions:**
0 °C – 40 °C, 20 % – 80 % relative air humidity (dry)

*1 KX-TG6411/KX-TG6412/KX-TG6413

*2 KX-TG6421

Note:

- Design and specifications are subject to change without notice.
- The illustrations in these instructions may vary slightly from the actual product.

Getting Started

Setting up

Connections

- Use only the supplied Panasonic AC adaptor PQLV219BX.

■ Base unit

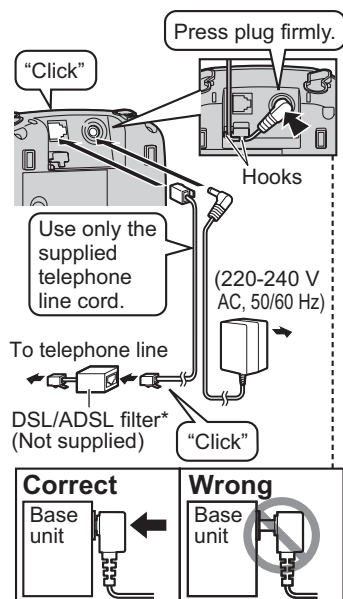

*For DSL/ADSL service users

■ Charger (KX-TG6412/KX-TG6413)

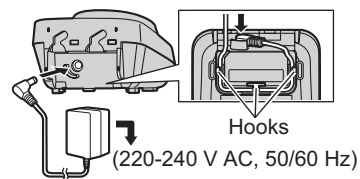

Battery installation

- USE ONLY Ni-MH batteries AAA (R03) size.

- Do NOT use alkaline/Manganese/Ni-Cd batteries.
- Confirm correct polarities (+, -).

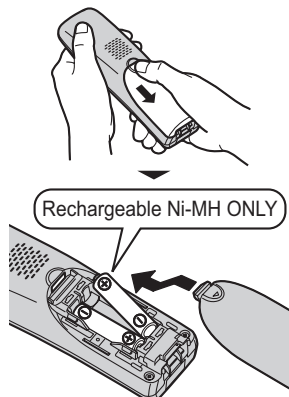

- When the language selection is displayed, see page 12.

Battery charge

Charge for about 7 hours.

- When the batteries are fully charged, the charge indicator goes off.

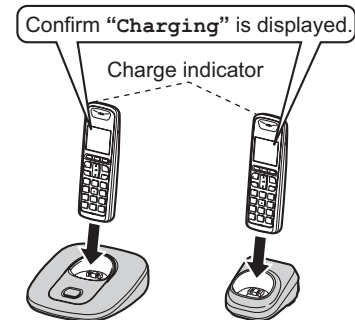

Base unit Charger*1

*1 KX-TG6412/KX-TG6413

Getting Started

Note when setting up

Note for connections

- The AC adaptor must remain connected at all times. (It is normal for the adaptor to feel warm during use.)
- The AC adaptor should be connected to a vertically oriented or floor-mounted AC outlet. Do not connect the AC adaptor to a ceiling-mounted AC outlet, as the weight of the adaptor may cause it to become disconnected.

During a power failure

The unit will not work during a power failure. We recommend connecting a corded-type telephone (without AC adaptor) to the same telephone line or to the same telephone line jack using a T-adaptor.





Note for battery installation

- Use the supplied rechargeable batteries. For replacement, we recommend using the Panasonic rechargeable batteries noted on page 4, 6.
- Wipe the battery ends (⊕, ⊖) with a dry cloth.
- Avoid touching the battery ends (⊕, ⊖) or the unit contacts.

Note for battery charge

- It is normal for the handset to feel warm during charging.
- Clean the charge contacts of the handset, base unit, and charger with a soft and dry cloth once a month. Clean more often if the unit is exposed to grease, dust, or high humidity.

Battery level

Icon	Battery level
	High
	Medium
	Low
	Needs charging.

Panasonic Ni-MH battery performance (supplied batteries)

Operation	Operating time
In continuous use	18 hours max.
Not in use (standby)	170 hours max.

Note:

- It is normal for batteries not to reach full capacity at the initial charge. Maximum battery performance is reached after a few complete cycles of charge/discharge (use).
- Actual battery performance depends on a combination of how often the handset is in use and how often it is not in use (standby).
- Even after the handset is fully charged, the handset can be left on the base unit or charger without any ill effect on the batteries.
- The battery level may not be displayed correctly after you replace the batteries. In this case, place the handset on the base unit or charger and let it charge for at least 7 hours.

Getting Started

Controls

Handset

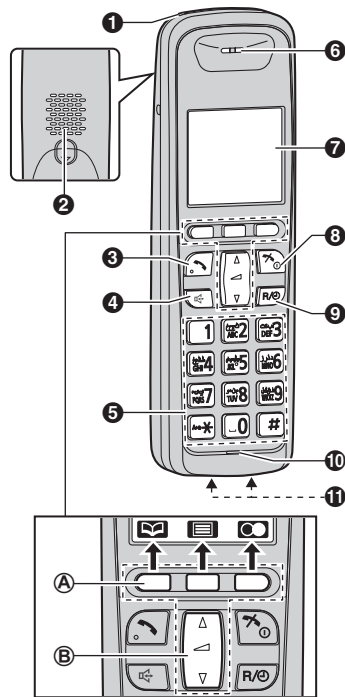

- 1** Charge indicator
Ringer indicator
- 2** Speaker
- 3** [☎] (Talk)
- 4** [☎] (Speakerphone)
- 5** Dial keypad
- 6** Receiver
- 7** Display
- 8** [⏻] (Off/Power)
- 9** [R/⏻]
R: Recall/Flash
⏻: Alarm shortcut key
- 10** Microphone

11 Charge contacts

■ Control type

Ⓐ Soft keys

The handset features 3 soft keys. By pressing a soft key, you can select the feature shown directly above it on the display.

Ⓑ Navigator key/ **(Volume) key**
By pressing this key ([▲] or [▼]) repeatedly, you can:

- scroll through (up or down) various lists or items
- adjust the receiver or speaker volume (up or down) while talking
- move the cursor (left or right) to edit number or name

Base unit

■ KX-TG6411/KX-TG6412/ KX-TG6413

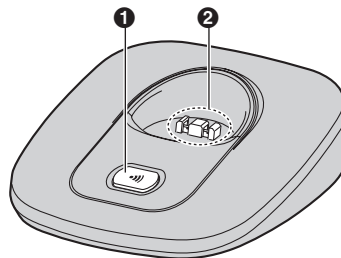

- 1** [☎] (Locator)
- 2** Charge contacts

Getting Started

■ KX-TG6421

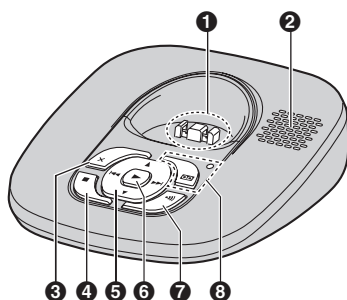

- 1** Charge contacts
- 2** Speaker
- 3** [X] (Erase)
- 4** [■] (Stop)
- 5** [▲]/[▼] (Volume up/down)
[◀◀]/[▶▶] (Repeat/Skip)
- 6** [▶] (Play)
Message indicator
- 7** [📶] (Locator)
- 8** [📞] (Answer on)
Answer on indicator

Display

Handset display items

Item	Meaning
📶	Within range of a base unit <ul style="list-style-type: none"> • When flashing: Handset is searching for base unit. (page 41)
📶)	Paging, intercom mode.*1
📞	Handset is on an outside call.
➔)	Missed call*2 (page 25)

Item	Meaning
📞	When displayed next to the battery icon: Answering system is on.*3 (page 27)
📧	When displayed with a number: New messages have been recorded.*3 (page 29)
📞	Answering system answers calls with a greeting message and caller messages are not recorded.*3 ("Caller's recording time", page 32)
🔋	Battery level
🕒	Alarm is on. (page 21)
🔒	Privacy mode is on. (page 20)
🔇	Ringer volume is off. (page 20)
🚫	Blocked call*2, *3 (page 22, 25)
📧	New voice mail message received.*4 (page 33)
IN USE	<ul style="list-style-type: none"> • Someone is using the line.*1 • Answering system is being used by the base unit.*3

*1 KX-TG6412/KX-TG6413

*2 Caller ID subscribers only

*3 KX-TG6421

*4 Voice mail subscribers only

Getting Started

Soft key icons

Icon	Action
	Returns to the previous screen.
	Displays the menu.
	Accepts the current selection.
	Displays a previously dialed phone number.
	Opens the phonebook.
	Stores phone numbers in the call barred list.* ¹ (page 22)
	Displays the character entry mode for phonebook search. (page 17)
	Turns the key lock feature off. (page 16)
	Selects a character entry mode.
	Stops recording or playback.* ¹
	Inserts a dialling pause.
	Erases the selected item.
	Allows you to make an intercom call.* ²
	Switches the screen. (page 25)
	Erases a number/character.
	Puts the call on mute.

*1 KX-TG6421

*2 KX-TG6412/KX-TG6413

Turning the power on/off

Power on

Press **[*][0]** for about 1 second.

Power off

Press **[*][0]** for about 2 seconds.

Initial settings

Symbol meaning:

Example: **[v]/[^]:** "off"

Press **[v]** or **[^]** to select the words in quotations.

Display language

Important:

- When the language selection is displayed after installing the batteries for the first time, perform step 5.

You can select "English", "العربية", or "فارسي".

- (middle soft key)
- [v]/[^]:** "Handset Setup" → **OK**
- [v]/[^]:** "Display Setup" → **OK**
- [v]/[^]:** "Language" → **OK**
- [v]/[^]:** Select your desired language. → **OK** → **[*][0]**

Getting Started

If you select a language you cannot read

- 1 **[*0]** → **[Menu]**
- 2 Proceed with the operation for your model.
 - **KX-TG6411/KX-TG6412/KX-TG6413**
[▲] 3 times → **OK**
 - **KX-TG6421**
[▲] 4 times → **OK**
- 3 **[▼]** 2 times → **OK** 2 times → **[▼]/[▲]**: Select your desired language. → **OK** → **[*0]**

Example: 15:30
[1][5] [3][0]

7 **OK** → **[*0]**

Note:

- When you select Arabic as the display language, enter the current year, month, and date.
- To correct a digit, press **[▲]** or **[▼]** to move the cursor to the digit, then make the correction.
- The date and time may be incorrect after a power failure. In this case, set the date and time again.

Dialling mode

If you cannot make calls, change this setting according to your telephone line service. The default setting is "Tone".
 "Tone": For tone dial service.
 "Pulse": For rotary/pulse dial service.

- 1 **[Menu]** (middle soft key)
- 2 **[▼]/[▲]**: "Base Unit Setup" → **OK**
- 3 **[▼]/[▲]**: "Dial Mode" → **OK**
- 4 **[▼]/[▲]**: Select the desired setting. → **OK** → **[*0]**

Date and time

- 1 **[Menu]** (middle soft key)
- 2 **[▼]/[▲]**: "Handset Setup" → **OK**
- 3 **[▼]/[▲]**: "Time Settings" → **OK**
- 4 **[▼]/[▲]**: "Set Date/Time" → **OK**
- 5 Enter the current date, month, and year. → **OK**
Example: 15 July, 2009
[1][5] [0][7] [0][9]
- 6 Enter the current hour and minute.

Making/Answering Calls

Making calls

- 1 Lift the handset and dial the phone number.
 - To correct a digit, press **C**.
- 2 **[↶]**
- 3 When you finish talking, press **[⏏]** or place the handset on the base unit or charger.

Using the speakerphone

- 1 Dial the phone number and press **[📞]**.
 - Speak alternately with the other party.
- 2 When you finish talking, press **[⏏]**.

Note:

- For best performance, use the speakerphone in a quiet environment.
- To switch back to the receiver, press **[↶]**.

Adjusting the receiver or speaker volume

Press **[▲]** or **[▼]** repeatedly while talking.

Making a call using the redial list

The last 10 phone numbers dialed are stored in the redial list (each 24 digits max.).

- 1 **[📞]** (right soft key)
- 2 **[▼]/[▲]**: Select the desired phone number.
- 3 **[↶]**

Erasing a number in the redial list

- 1 **[📞]** (right soft key)
- 2 **[▼]/[▲]**: Select the desired phone number. → **[📄]** → **OK**

- 3 **[▼]/[▲]**: "Yes" → **OK** → **[⏏]**

Pause (for PBX/long distance service users)

A pause is sometimes required when making calls using a PBX or long distance service. When storing a calling card access number and/or PIN in the phonebook, a pause is also needed (page 18).

Example: If you need to dial the line access number "0" when making outside calls with a PBX:

- 1 **[0]** → **P**
- 2 Dial the phone number. → **[↶]**

Note:

- A 3 second pause is inserted each time **P** is pressed. Repeat as needed to create longer pauses.

Answering calls

When a call is being received, the ringer indicator on the handset flashes.

- 1 Lift the handset and press **[↶]** or **[📞]** when the unit rings.
 - You can also answer the call by pressing any dial key from **[0]** to **[9]**, **[*]**, or **[#]**. (**Any key answer feature**)
- 2 When you finish talking, press **[⏏]** or place the handset on the base unit or charger.

Auto talk

You can answer calls simply by lifting the handset off the base unit or charger. You do not need to press **[↶]**. To turn this feature on, see page 19.

Making/Answering Calls

Adjusting the handset ringer volume

Press **[▲]** or **[▼]** repeatedly to select the desired volume while the handset is ringing for an incoming call.

Note:

- You can also program the handset ringer volume beforehand (page 19).

Useful features during a call

Mute

While mute is turned on, you can hear the other party, but the other party cannot hear you.

- Press **[M]** during conversation.
 - [M]** flashes.
- To return to the conversation, press **[M]** again.

Recall/flash

[R/⊕] allows you to use the special features of your host PBX such as transferring an extension call, or accessing optional telephone services.

Note:

- To change the recall/flash time, see page 20.

For call waiting or Call Waiting Caller ID service users

To use call waiting, you must first subscribe to the call waiting service of your service provider/telephone company.

This feature allows you to receive calls while you are already talking on the phone. If you receive a call while on the phone, you will hear a call waiting tone.

If you subscribe to both Caller ID and Call Waiting with Caller ID services, the 2nd caller's information is displayed after you hear the call waiting tone on the handset.

- Press **[R/⊕]** to answer the 2nd call.
- To switch between calls, press **[R/⊕]**.

Note:

- Please contact your service provider/telephone company for details and availability of this service in your area.

Temporary tone dialling (for rotary/pulse service users)

You can temporarily switch the dialling mode to tone when you need to access touch-tone services (for example, telephone banking services).

- Make a call.
- Press **[*]** when prompted to enter your code or PIN, then press the appropriate dial keys.

Note:

- The dialling mode will return to pulse when you hang up.

Call share

Available for:
KX-TG6412/KX-TG6413

You can join an existing outside call. To join the conversation, press **[R/⊕]** when the other handset is on an outside call.

Note:



- To prevent other users from joining your conversations with outside callers, turn the privacy mode on (page 20).

Making/Answering Calls

Key lock

The handset can be locked so that no calls or settings can be made. Incoming calls can be answered, but all other functions are disabled while key lock is on.

To turn key lock on, press  (middle soft key) for about 3 seconds.

-  is displayed.
- To turn key lock off, press  (middle soft key) for about 3 seconds.



Note:

- Calls to emergency numbers cannot be made until key lock is turned off.

Phonebook**Handset phonebook**

The phonebook allows you to make calls without having to dial manually. You can add 100 names and phone numbers.

Adding entries

- 1  (left soft key) → 
- 2 **[v]/[Δ]**: "New Entry" → **OK**
- 3 Enter the party's name (16 characters max.). → **OK**
 - You can change the character entry mode by pressing **1/A/?** (page 36).
- 4 Enter the party's phone number (24 digits max.). → **OK** 2 times
 - To add other entries, repeat from step 3.
- 5 **[*0]**

Finding and calling a phonebook entry**Scrolling through all entries**

- 1  (left soft key)
- 2 **[v]/[Δ]**: Select the desired entry.
 - You can scroll through the phonebook entry by pressing and holding **[v]** or **[Δ]**.
- 3 **[↶]**

Searching by first character (using a dial key)

- 1  (left soft key)
 - Change the character entry mode if necessary:
A/B/C → **[v]/[Δ]**: Select the character entry mode. → **OK**

- 2 Press the dial key (**[0]** to **[9]**) which contains the character you are searching for (page 36).
 - Press the same dial key repeatedly to display the first entry corresponding to each character located on that dial key.
 - If there is no entry corresponding to the character you selected, the next entry is displayed.
- 3 **[v]/[Δ]**: Scroll through the phonebook if necessary.
- 4 **[↶]**



Editing entries

- 1 Find the desired entry (page 17). → 
- 2 **[v]/[Δ]**: "Edit" → **OK**
- 3 Edit the name if necessary (16 characters max.; page 36). → **OK**
- 4 Edit the phone number if necessary (24 digits max.). → **OK** 2 times → **[*0]**

Erasing entries**Erasing an entry**

- 1 Find the desired entry (page 17). → 
- 2 **[v]/[Δ]**: "Erase" → **OK**
- 3 **[v]/[Δ]**: "Yes" → **OK** → **[*0]**

Erasing all entries

- 1  (left soft key) → 
- 2 **[v]/[Δ]**: "Erase All" → **OK**
- 3 **[v]/[Δ]**: "Yes" → **OK**
- 4 **[v]/[Δ]**: "Yes" → **OK** → **[*0]**

Phonebook

Chain dial

This feature allows you to dial phone numbers in the phonebook while you are on a call. This feature can be used, for example, to dial a calling card access number or bank account PIN that you have stored in the phonebook, without having to dial manually.

- 1 During an outside call, press .
→ **OK**
- 2 **[▼]/[▲]**: Select the desired entry.
- 3 Press **OK** to dial the number.

Note:

- When storing a calling card access number and your PIN in the phonebook as one phonebook entry, press **P** to add pauses after the number and PIN as necessary (page 14).
- If you have rotary/pulse service, you need to press **[*]** before pressing  in step 1 to change the dialling mode temporarily to tone. When adding entries to the phonebook, we recommend adding **[*]** to the beginning of phone numbers you wish to chain dial (page 13).

Copying phonebook entries



Available for:
KX-TG6412/KX-TG6413

You can copy phonebook entries to the phonebook of another compatible Panasonic handset.

Copying an entry

- 1 Find the desired entry (page 17).
→ 
- 2 **[▼]/[▲]**: "Copy" → **OK**
- 3 Enter the handset number you wish to send the phonebook entry to.
 - When an entry has been copied, "Completed" is displayed.
 - To continue copying another entry: **[▼]/[▲]**: "Yes" → **OK**
→ Find the desired entry. → **OK**
- 4 **[*]⓪**

Copying all entries

- 1  (left soft key) → 
- 2 **[▼]/[▲]**: "Copy All" → **OK**
- 3 Enter the handset number you wish to send the phonebook entry to.
 - When all entries have been copied, "Completed" is displayed.
- 4 **[*]⓪**

Programmable settings

You can customise the unit by programming the following features using the handset.

Programming by scrolling through the display menus



- 1  (middle soft key)
- 2 Press [**▼**] or [**▲**] to select the desired top-menu. → **OK**
- 3 Press [**▼**] or [**▲**] to select the desired item in sub-menu 1. → **OK**
 - In some cases, you may need to select from sub-menu 2. → **OK**
- 4 Press [**▼**] or [**▲**] to select the desired setting. → **OK**
 - This step may vary depending on the feature being programmed.
 - To exit the operation, press [**✕**].

Note:

- For other top-menus, please refer to each chapter.
- In the following table, < > indicates the default settings.
- The current item or setting is highlighted on the display.

Top-menu	Sub-menu 1	Sub-menu 2	Page
Handset Setup 	Time Settings	Set Date/Time ^{*1}	13
		Alarm	21
		Time Adjust ^{*1, *2} <Manual>	–
	Ringer Setup	Ringer Volume ^{*3} <Maximum>	–
		Ringtone ^{*4, *5} <Ringtone 1>	–
		Display Setup	Language <English>
		Contrast <Level 3>	–
	Register H.set	–	23
	Keytones ^{*6} <On>	–	–
	Auto Talk ^{*7} <Off>	–	14

Programming

Top-menu	Sub-menu 1	Sub-menu 2	Page
Base Unit Setup ^{*1} 	Ringer Volume ^{*8} <Medium>	–	–
	Dial Mode <Tone>	–	13
	Privacy Mode ^{*9} <Off>	–	–
	Recall/Flash ^{*10} <600 msec.>	–	15
	Area Code	–	21
	Base Unit PIN <0000>	–	21
	Repeater <Off>	–	24
Caller Barred ^{*1, *8} 	–	–	22

- *1 If you program these settings using one of the handsets, you do not need to program the same item using another handset. (KX-TG6412/KX-TG6413)
- *2 This feature allows the unit to automatically adjust the date and time each time caller information including date and time is received.
To turn this feature on, select “**Caller ID**”. To turn this feature off, select “**Manual**”. (Caller ID subscribers only)
To use this feature, set the date and time first (page 13).
- *3 When the ringer volume is turned off, \mathcal{A} is displayed and the handset does not ring for outside calls.
However even when the ringer volume is set to off, the handset rings:
– at the low level for alarm (page 21) and intercom calls (page 34)
– at the high level for paging (page 34)
- *4 If you select one of the melody ringer tones, the ringer tone continues to play for several seconds even if the caller has already hung up. You may either hear a dial tone or no one on the line when you answer the call.
- *5 The preset melodies in this product are used with permission of © 2007 Copyrights Vision Inc.
- *6 Turn this feature off if you prefer not to hear key tones while you are dialling or pressing any keys, including confirmation tones and error tones.
- *7 If you subscribe to a Caller ID service and want to view the caller’s information after lifting up the handset to answer a call, turn off this feature.
- *8 KX-TG6421
- *9 To prevent other users from joining your conversations with outside callers, turn this feature on.
- *10 The recall/flash time depends on your telephone exchange or host PBX. Contact your PBX supplier if necessary.

Special programming

Alarm

You can set one of 2 different alarm options (once or daily) at a time for each handset. An alarm sounds at the set time for 3 minutes.

Important:

- Set the date and time beforehand (page 13).

- 1  (middle soft key)
- 2 **[v]/[^]**: "Handset Setup" → **OK**
- 3 **[v]/[^]**: "Time Settings" → **OK**
- 4 **[v]/[^]**: "Alarm" → **OK**
- 5 **[v]/[^]**: Select the desired alarm option. → **OK**

"Off"

Turns alarm off. Press **OK** again, then press **[*0]** to exit.

"Once"

An alarm sounds once at the set time. Enter the desired date and month. → **OK**

- If you select Arabic as the display language, enter the desired month and date.

"Daily"

An alarm sounds daily at the set time.

- 6 Set the desired time. → **OK**
- 7 **[v]/[^]**: Select the desired alarm tone. → **OK** 2 times
 - We recommend selecting a different ringer tone to the one used for outside calls.
- 8 **[*0]**
 - When the alarm is set,  is displayed.

Note:

- You can skip to step 4 by pressing **[R/⊙]** in standby mode.
- To stop the alarm, press any dial key or place the handset on the base unit or charger.
- When the handset is in use, the alarm will not sound until the handset is in standby mode.
- If you select "Once", the setting changes to "off" after the alarm sounds.

Selecting area codes to be deleted automatically

In some situations, phone numbers stored automatically in the caller list (page 25) will include area codes. If you do not want to dial the area codes when making calls from the caller list, you can store the area codes which you want the unit to delete automatically.

Example: You have stored the area code "123". If you make a call from the caller list to the phone number "123-456-7890", the unit dials "456-7890".

- 1  (middle soft key)
- 2 **[v]/[^]**: "Base Unit Setup" → **OK**
- 3 **[v]/[^]**: "Area Code" → **OK**
- 4 Enter an area code (5 digits max.). → **OK** → **[*0]**

Changing the base unit PIN (Personal Identification Number)

Important:

- If you change the PIN, please make note of your new PIN. The unit will not reveal the PIN to you. If you forget your PIN, contact your nearest Panasonic service centre.

Programming

- 1  (middle soft key)
- 2 **[v]/[Δ]: "Base Unit Setup" → OK**
- 3 **[v]/[Δ]: "Base Unit PIN" → OK**
- 4 Enter the current 4-digit base unit PIN (default: "0000").
- 5 Enter the new 4-digit base unit PIN. → **OK** → **[*0]**

Incoming call barring (Caller ID subscribers only)

Available for:
KX-TG6421

This feature allows the unit to reject calls from specified phone numbers that you do not want to answer such as junk calls. When a call is received, the unit does not ring while the caller is being identified. If the phone number matches an entry in the call barred list, the unit sends out a busy tone to the caller, and then disconnects the call.

Important:

- When the unit receives a call from a number that is stored in the call barred list, the call is logged in the caller list (page 25) with ***i** after the call is disconnected.

Storing unwanted callers

You can store up to 30 phone numbers in the call barred list by using the caller list or by entering the numbers directly.

Important:



- You must store the phone number with an area code in the call barred list.

■ From the caller list:



- 1  (middle soft key)
- 2 **[v]/[Δ]: "Caller List" → OK**

- 3 **[v]/[Δ]: Select the entry to be barred. → **
- 4 **[v]/[Δ]: "Add Bar List" → OK**
- 5 **[*0]**

■ By entering phone numbers:

- 1  (middle soft key)
- 2 **[v]/[Δ]: "Caller Barred" → OK → **
- 3 Enter the phone number (24 digits max.). → **OK**
 - To erase a digit, press **C**.
- 4 **[*0]**

Viewing/editing/erasing bar call numbers

- 1  (middle soft key)
- 2 **[v]/[Δ]: "Caller Barred" → OK**
- 3 **[v]/[Δ]: Select the desired entry.**
 - To exit, press **[*0]**.
- 4 Proceed with the desired operation.
 - **Editing a number:**
 → **[v]/[Δ]: "Edit" → OK** → Press **[Δ]** or **[v]** to move the cursor. → Edit the number. → **OK** → **[*0]**
 - **Erasing a number:**
 → **[v]/[Δ]: "Erase" → OK** → **[v]/[Δ]: "Yes" → OK** → **[*0]**

Note:

- When editing, press the desired dial key to add, **C** to erase.

Programming

Registering a unit

Registering a handset to the base unit

The supplied handset and base unit are pre-registered. If for some reason the handset is not registered to the base unit (for example, Ψ flashes even when the handset is near the base unit), re-register the handset.

- 1 **Handset:**
 (middle soft key)
- 2 **[v]/[^]:** "Handset Setup" → **OK**
- 3 **[v]/[^]:** "Register H.set" → **OK**
- 4 **Base unit:**
 Proceed with the operation for your model.
 - **KX-TG6411/KX-TG6412/KX-TG6413**
 Press and hold **[*]** for about 5 seconds. (No registration tone)
 - **KX-TG6421**
 Press and hold **[*]** for about 5 seconds, until the registration tone sounds.
 - If all registered handset(s) start(s) ringing, press the same button to stop. Then repeat this step.
 - The next step must be completed within 90 seconds.
- 5 **Handset:**
 Wait until "Base PIN" is displayed.
 → Enter the base unit PIN (default: "0000"). → **OK**
 - If you forget your PIN, contact your nearest Panasonic service centre.

- When the handset has been registered successfully, Ψ stops flashing.

Deregistering a handset

A handset can cancel its own registration (or the registration of another handset) that is stored to the base unit. This allows the handset to end its wireless connection with the system.

- 1  (middle soft key)
- 2 **[v]/[^]:** "Base Unit Setup" → **OK**
- 3 **[3][3][5]**
- 4 **[v]/[^]:** "Cancel Register" → **OK**
 - The numbers of all handsets registered to the base unit are displayed.
- 5 Select the handset(s) you want to cancel by pressing the desired handset number. → **OK**
 - The selected handset number(s) flashes.
 - To cancel a selected handset number, press the number again. The number stops flashing.
- 6 **[v]/[^]:** "Yes" → **OK**
 - A confirmation tone sounds as each handset number disappears.
 - The handset does not beep when cancelling its own registration.
- 7 **[*]0**

Increasing the range of the base unit

You can increase the signal range of the base unit by using a DECT repeater. Please use only the Panasonic DECT repeater noted on page 4. Contact your Panasonic dealer for details.

Programming

Important:

- Before registering the repeater to this base unit, you must turn the repeater mode on.
- Do not use more than one repeater at a time.

Setting the repeater mode

- 1  (middle soft key)
- 2 **[▼]/[▲]**: "Base Unit Setup" → **OK**
- 3 **[▼]/[▲]**: "Repeater" → **OK**
- 4 **[▼]/[▲]**: Select the desired setting.
→ **OK** → **[*] [0]**

Note:

- After turning the repeater mode on or off, **Y** flashes on the handset momentarily. This is normal and the handset can be used once **Y** stops flashing.

Caller ID Service**Using Caller ID service****Important:**

- This unit is Caller ID compatible. To use Caller ID features, you must subscribe to a Caller ID service. Contact your service provider/telephone company for details.



Caller ID features

When an outside call is being received, the caller's phone number is displayed. Caller information for the last 50 callers is logged in the caller list from the most recent call to the oldest.

- If the unit cannot receive caller information, the following is displayed:
 - **“Out of Area”**: The caller dials from an area which does not provide a Caller ID service.
 - **“Private Caller”**: The caller requests not to send caller information.
- If the unit is connected to a PBX system, caller information may not be properly received. Contact your PBX supplier.

Missed calls

If a call is not answered, the unit treats it as a missed call and  is displayed. This lets you know if you should view the caller list to see who called while you were away.

Even if only one missed call in the caller list is viewed (page 25),  disappears from the display. When you receive another new call,  is displayed again.

Phonebook name display



When caller information is received and it matches a phone number stored in the phonebook, the stored name in the

phonebook is displayed and logged in the caller list.



Caller list**Important:**

- Only 1 person can access the caller list at a time. (KX-TG6412/KX-TG6413)
- Make sure the unit's date and time setting is correct (page 13).

Viewing the caller list and calling back

- 1  (middle soft key)
- 2 **[▼]/[▲]**: “Caller List” → **OK**
- 3 Press **[▼]** to search from the most recent call, or press **[▲]** to search from the oldest call.
 - If the other party's name is displayed on the screen, you can switch the screen between the name and its phone number by pressing  repeatedly.
- 4 To call back, press **[↶]**. To exit, press **[✕⊙]**.

Note:



- If the item has already been viewed or answered:
 - “” is displayed. (KX-TG6411/KX-TG6421)
 - “” is displayed, even if the item was viewed or answered using another handset. (KX-TG6412/KX-TG6413)
- To erase the item, press **[✕]**. → **[▼]/[▲]**: “Yes” → **OK**
- If the call matches an entry in the call barred list, the number is logged with  (page 22). (KX-TG6421)

Caller ID Service



- If you do not want to dial the area codes when making calls from the caller list, you can store the area codes which you want the unit to delete automatically (page 21).

- 5 To store the name, continue from step 3, "Adding entries", page 17.



Editing a caller's phone number before calling back

- 1  (middle soft key)
- 2 **[v]/[Δ]**: "Caller List" → **OK**
- 3 **[v]/[Δ]**: Select the desired entry.
 - If the other party's name is displayed on the screen, you can switch the screen between the name and its phone number by pressing  repeatedly.
- 4  → **[v]/[Δ]**: "Edit & Call" → **OK**
- 5 Edit the number.
 - Press dial key (**[0]** to **[9]**) to add, **C** to delete.
- 6 **[↶]**

Erasing caller information

- 1  (middle soft key)
- 2 **[v]/[Δ]**: "Caller List" → **OK**
- 3 **[v]/[Δ]**: Select the desired entry. → 
- 4 **[v]/[Δ]**: Select "Erase" or "Erase All". → **OK**
- 5 **[v]/[Δ]**: "Yes" → **OK** → **[*0]**

Storing caller information to the phonebook

- 1  (middle soft key)
- 2 **[v]/[Δ]**: "Caller List" → **OK**
- 3 **[v]/[Δ]**: Select the desired entry. → 
- 4 **[v]/[Δ]**: "Add Phonebook" → **OK**

Answering System

Answering system

Available for:
KX-TG6421

The answering system can answer and record calls for you when you are unavailable to answer the phone. You can also set the unit to play a greeting message but not to record caller messages by selecting "Greeting Only" as the recording time setting (page 32).

Important:

- When callers leave messages, the unit records the day and time of each message. Make sure the date and time have been set correctly (page 13).
- Answering system announcements are in English only.

Memory capacity

The total recording capacity (including your greeting message) is about 20 minutes. A maximum of 64 messages can be recorded.

Note:

- If message memory becomes full:
 - "Messages Full" is shown on the handset display.
 - The answer on indicator on the base unit flashes rapidly when the answering system is turned on.
- When the message memory becomes full:
 - If you use the pre-recorded greeting message, the unit automatically switches to another pre-recorded greeting message asking callers to call again later.
 - If you recorded your own greeting message, the same message is still

announced to callers even though their messages are not recorded.

Turning the answering system on/off

The answering system is preset to on.

Base unit

Press **[☎]** to turn on/off the answering system.

- When the answering system is turned on, the answer on indicator lights up.

Handset

- 1 **[☎]** (middle soft key)
- 2 **[▼]/[▲]**: "Answer System" → **OK**
- 3 **[▼]/[▲]**: Select "Answer On" or "Answer Off". → **OK** → **[*0]**

Note:

- When the answering system is turned on, **[☎]** is displayed next to the battery icon.

Call screening

While a caller is leaving a message, you can listen to the call through the handset's speaker. To adjust the speaker volume, press **[▲]** or **[▼]** repeatedly. You can answer the call by pressing **[☎]** on the handset. The default setting is "On".

- 1 **[☎]** (middle soft key)
- 2 **[▼]/[▲]**: "Answer System" → **OK**
- 3 **[▼]/[▲]**: "Settings" → **OK**
- 4 **[▼]/[▲]**: "Call Screening" → **OK**

Answering System

- 5 [▼]/[▲]: Select the desired setting.
→ **OK** → [↶⊙]

Greeting message



When the unit answers a call, a greeting message is played to callers.

You can use either:

- your own greeting message
- pre-recorded greeting message

Recording your greeting message

You can record your own greeting message (2 minutes max.).

- 1  (middle soft key)
- 2 [▼]/[▲]: “Answer System” → **OK**
- 3 [▼]/[▲]: “Greeting” → **OK**
- 4 [▼]/[▲]: “Start REC” → **OK**
- 5 [▼]/[▲]: “Yes” → **OK**
- 6 Hold the handset about 20 cm away and speak clearly into the microphone.
- 7 Press  to stop recording.
- 8 [↶⊙]

Using a pre-recorded greeting message

The unit provides 2 pre-recorded greeting messages:

- If you erase or do not record your own greeting message, the unit plays a pre-recorded greeting asking callers to leave a message.
- If the message recording time (page 32) is set to “Greeting Only”, callers’ messages are not recorded and the unit plays a different pre-

recorded greeting message asking callers to call again.

Erasing your greeting message (Resetting to a pre-recorded greeting message)

If you want to use a pre-recorded greeting message once you record your own greeting message, you need to erase your own greeting message.

- 1  (middle soft key)
- 2 [▼]/[▲]: “Answer System” → **OK**
- 3 [▼]/[▲]: “Greeting” → **OK**
- 4 [▼]/[▲]: “Default” → **OK**
2 times
- 5 [↶⊙]

Playing back the greeting message

- 1  (middle soft key)
- 2 [▼]/[▲]: “Answer System” → **OK**
- 3 [▼]/[▲]: “Greeting” → **OK**
- 4 [▼]/[▲]: “Play Greeting” → **OK**
- 5 [↶⊙]

Listening to messages using the base unit

When new messages have been recorded, [▶] on the base unit flashes. Press [▶].

- If new messages have been recorded, the base unit plays back new messages.
- If there are no new messages, the base unit plays back all messages.

Answering System

Note:

- When the answer on indicator on the base unit flashes rapidly, the message memory is full ("Memory capacity", page 27).

Operating the answering system during playback

Key	Operation
[▲] or [▼]	Adjust the speaker volume
[⏮]	Repeat message*1
[⏭]	Skip message
[■]	Stop playback
[X]	Erase currently playing message

*1 If pressed within the first 5 seconds of a message, the previous message is played.

Erasing all messages

Press [X] 2 times while the unit is not in use.

Listening to messages using the handset

When new messages have been recorded, [M] is displayed on the handset with the total number of new messages.

- 1 [M] (middle soft key)
- 2 [▼]/[▲]: "Answer System" → **OK**
- 3 [▼]/[▲]: Select "Play New Msg." or "Play All Msg.". → **OK**
- 4 When finished, press [⏏].

Note:

- To switch to the receiver, press [↶].
- If "Messages Full" is shown on the display, [M] and the total number of new messages are not displayed.

Operating the answering system

[M] (middle soft key) →

[▼]/[▲]: "Answer System" → **OK**

Key	Operation
[▲] or [▼]	Adjust the receiver or speaker volume (during playback)
[1]	Repeat message (during playback)*1
[2]	Skip message (during playback)
[3]	Enter the "Settings" menu
[4]	Play new messages
[5]	Play all messages
[6]	Play greeting message
[7][6]	Record greeting message
[8]	Turn answering system on
[9] or [M]	Stop recording Stop playback
[0]	Turn answering system off
[*][4]*2	Erase currently playing message
[*][5]	Erase all messages
[*][6]	Erase greeting message*3

Answering System

- *1 If pressed within the first 5 seconds of a message, the previous message is played.
- *2 You can also erase as follows:
X → **[v]/[▲]**: "Yes" → **OK**
- *3 Unit resets to a pre-recorded greeting message.

Calling back (Caller ID subscribers only)

If caller information is received for the call, you can call the caller back while listening to a message.

- 1 Press **[M]** during playback.
- 2 **[v]/[▲]**: "Call Back" → **OK**

Editing the number before calling back

- 1 Press **[M]** during playback.
- 2 **[v]/[▲]**: "Edit & Call" → **OK**
- 3 Edit the number. → **[↶]**

Erasing all messages

- 1 **[M]** (middle soft key)
- 2 **[v]/[▲]**: "Answer System" → **OK**
- 3 **[v]/[▲]**: "Erase All Msg." → **OK**
- 4 **[v]/[▲]**: "Yes" → **OK** → **[*0]**

Remote operation

Using a touch-tone phone, you can call your phone number from outside and access the unit to listen to messages or change answering system settings. The unit's voice guidance prompts you to press certain dial keys to perform different operations.

Remote access code

A 3-digit remote access code must be entered when operating the answering system remotely. This code prevents unauthorised parties from listening to your messages remotely.

Important:

- In order to operate the answering system remotely, you must first set a remote access code.

- 1 **[M]** (middle soft key)
- 2 **[v]/[▲]**: "Answer System" → **OK**
- 3 **[v]/[▲]**: "Settings" → **OK**
- 4 **[v]/[▲]**: "Remote Code" → **OK**
- 5 To turn on remote operation, enter the desired 3-digit remote access code.
 - To turn off remote operation, press **[*]**.
- 6 **OK** → **[*0]**

Using the answering system remotely

- 1 Dial your phone number from a touch-tone phone.
- 2 After the greeting message starts, enter your remote access code.
 - The unit announces the number of new messages.
- 3 Follow the voice guidance prompts as necessary or control the unit using remote commands (page 31).
- 4 When finished, hang up.

Note:

- You can also leave a message just as any outside caller can. After the greeting message starts, press **[*]** to skip the greeting message and record your message after the beep.

Answering System

Voice guidance

During remote operation, the unit's voice guidance starts and prompts you to press **[1]** to perform a specific operation, or press **[2]** to listen to more available operations.

Remote commands

You can press dial keys to access certain answering system functions without waiting for the voice guidance to prompt you.

Key	Operation
[1]	Repeat message (during playback) ^{*1}
[2]	Skip message (during playback)
[4]	Play new messages
[5]	Play all messages
[6]	Play greeting message
[7]	Record greeting message
[9]	Stop recording Stop playback
[0]	Turn answering system off
[*][4]	Erase currently playing message
[*][5]	Erase all messages
[*][6]	Erase greeting message (during greeting message playback) ^{*2}
[*][#]	End remote operation (or hang up)

*1 If pressed within the first 5 seconds of a message, the previous message is played.

*2 Unit resets to a pre-recorded greeting message.

Turning on the answering system remotely

If the answering system is off, you can turn it on remotely.

- 1 Dial your phone number from a touch-tone phone.
- 2 Let the phone ring 15 times.
 - A long beep is heard.
- 3 Enter your remote access code within 10 seconds after the long beep.
 - The greeting message is played back.
 - You can either hang up, or enter your remote access code again and begin remote operation (page 30).

Answering system settings

Number of rings before the unit answers a call

You can change the number of times the phone rings "Number of Rings" before the unit answers a call. You can select 2 to 7 rings, or "Auto". The default setting is "4 Rings".

"Auto": The unit's answering system answers at the end of the 2nd ring when new messages have been recorded, or at the end of the 5th ring when there are no new messages. If you call your phone from outside to listen to new messages (page 30), you know that there are no new messages when the phone rings for the 3rd time. You can then hang up without being charged for the call.

- 1  (middle soft key)

Answering System

- 2 [▼]/[▲]: "Answer System" → **OK**
- 3 [▼]/[▲]: "Settings" → **OK**
- 4 [▼]/[▲]: "Number of Rings" → **OK**
- 5 [▼]/[▲]: Select the desired setting.
→ **OK** → [↶○]

For voice mail service subscribers

To receive voice mail and use answering system properly, please note the following:

- To use the voice mail service (page 33) provided by your service provider/telephone company rather than the unit's answering system, turn off the answering system (page 27).
- To use this unit's answering system rather than the voice mail service provided by your service provider/telephone company, please contact your service provider/telephone company to deactivate your voice mail service.

If your service provider/telephone company cannot do this:

- Set this unit's "Number of Rings" setting so that this unit's answering system answers calls before the voice mail service of your service provider/telephone company does. It is necessary to check the number of rings required to activate the voice mail service provided by your service provider/telephone company before changing this setting.
- Change the number of rings of the voice mail service so that the answering system can answer the call first. To do so, contact your service provider/telephone company.

Caller's recording time

You can change the maximum message recording time allotted to each caller. You can also select "Greeting Only" which sets the unit to greet callers but not record messages. The default setting is "3 Minutes".

- 1  (middle soft key)
- 2 [▼]/[▲]: "Answer System" → **OK**
- 3 [▼]/[▲]: "Settings" → **OK**
- 4 [▼]/[▲]: "Recording Time" → **OK**
- 5 [▼]/[▲]: Select the desired setting.
→ **OK** → [↶○]

Note:

- When you select "Greeting Only":
 - If you do not record your own message, the unit will play the pre-recorded greeting-only message asking callers to call again later.
 - If you use your own message, record the greeting-only message asking callers to call again later (page 28).

Voice Mail Service

Voice mail service

Voice mail is an automatic answering service offered by your service provider/telephone company. After you subscribe to this service, your service provider/telephone company's voice mail system answers calls for you when you are unavailable to answer the phone or when your line is busy. Messages are recorded by your service provider/telephone company, not your telephone. When you have new messages,  is displayed on the handset if message indication service is available. Please contact your service provider/telephone company for details of this service.

Important:

- If  still remains on the display even after you have listened to new messages, turn it off by pressing and holding **[#]** for 2 seconds.
- To use the voice mail service provided by your service provider/telephone company rather than the unit's answering system, turn off the answering system (page 27). For details, see page 32. (KX-TG6421)

Intercom/Locator

Intercom



Available for:
KX-TG6412/KX-TG6413

Intercom calls can be made between handsets.

Note:

- If you receive an outside call while talking on the intercom, you hear interrupt tones. To answer the call, press [**FXO**], then press [**FX**].
- When paging the handset, the paged handset beeps for 1 minute.

Making an intercom call

- 1  (middle soft key) → 
- 2 To page a specific handset, enter the handset number.
 - To stop paging, press [**FXO**].
- 3 When you finish talking, press [**FXO**].

Answering an intercom call

- 1 Press [**FX**] to answer the page.
- 2 When you finish talking, press [**FXO**].

Handset locator

You can locate a misplaced handset by pressing [**FX**] on the base unit.



- All registered handset(s) beep(s) for 1 minute.

To stop paging, press it again or [**FXO**] on the handset.

Transferring calls, conference calls

Available for:
KX-TG6412/KX-TG6413

Outside calls can be transferred between 2 handsets.

- 1 During an outside call, press  to put the call on hold.
 -  flashes to indicate the outside call is on hold.
- 2 Enter the desired handset number you want to transfer to.
- 3 Wait for the paged party to answer.
 - If the paged party does not answer, press  to return to the outside call.

4 To transfer the call:

- Press [**FXO**].
- The outside call is routed to the handset.

To establish a conference call:

- Press [**3**].
- To leave the conference, press [**FXO**]. The other parties can continue the conversation.

Transferring a call without speaking to the other handset user

- 1 Perform step 1 and 2, "Transferring calls, conference calls", page 34.
- 2 [**FXO**]
 - The outside call rings at the other handset.

Note:

- If the other handset user does not answer the call within 1 minute, the call rings at your handset again.

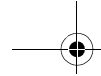

Intercom/Locator

Answering a transferred call

Press [] to answer the page.

Note:

- After the paging party disconnects, you can talk to the outside caller.

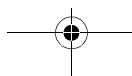
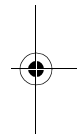
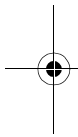

Useful Information

Character entry

The dial keys are used to enter characters and numbers. Each dial key has multiple characters assigned to it. The characters that can be entered depend on the character entry mode (page 36).

- Press [▲] or [▼] to move the cursor left or right.
- Press dial keys to enter characters and numbers.
- Press **C** to erase the character or number highlighted by the cursor. Press and hold **C** to erase all characters or numbers.
- Press [✖] to switch between uppercase and lowercase.
- If you do not press any dial key within 5 seconds after entering a character, the character is fixed and the cursor moves to the next space.
- When entering another character located on the same dial key, operation will differ depending on the display language you select.

English

Press [▼] to move the cursor to the next space, then press the appropriate dial key.

Arabic/Persian

Press [▲] to move the cursor to the next space, then press the appropriate dial key.

Character entry modes

The available character entry modes are Alphabet (ABC), Numeric (0-9), Arabic/Persian (ا ب ت) and Extended (AÄÅ). When in these entry modes except Numeric, you can select which character is entered by pressing a dial key repeatedly.

When the unit displays the character entry screen:

1/A/? (right soft key) → [▼]/[▲]: Select a character entry mode. → **OK**

Note:

- When you select Arabic or Persian as the display language, numbers in the character table are displayed in Arabic or Persian.

Alphabet character table (ABC)

0	1	ABC 2	DEF 3	GHI 4	JKL 5	MNO 6	PQRS 7	TUV 8	WXYZ 9
Space	Space #	A B C	D E F	G H I	J K L	M N O	P Q R S	T U V	W X Y Z
0	& ' () *	2	3	4	5	6	7	8	9
	, - . / 1	a b c	d e f	g h i	j k l	m n o	p q r s	t u v	w x y z
		2	3	4	5	6	7	8	9

Numeric entry table (0-9)

0	1	ABC 2	DEF 3	GHI 4	JKL 5	MNO 6	PQRS 7	TUV 8	WXYZ 9
0	1	2	3	4	5	6	7	8	9

Useful Information

Arabic character table (اَبْت)

- When you select Arabic as the display language, Arabic character table is available.

0	1	2 ABC	3 DEF	4 GHI	5 JKL	6 MNO	7 PQRS	8 TUV	9 WXYZ
Space .	# Space * () ' & \ / . - ,	ث ج ح خ ٢	ا ب ة ت ا ا ا ٣	ط ط ع غ ع	س ش ص ض ه ٥	ذ ز ر ز ٦	ي ء ٧	م ن ه و ٨	ف ق ك ل ٩

Persian character table (اَبْت)

- When you select Persian as the display language, Persian character table is available.

0	1	2 ABC	3 DEF	4 GHI	5 JKL	6 MNO	7 PQRS	8 TUV	9 WXYZ
Space .	# Space * () ' & \ / . - ,	ث ج ح خ ٢	ا ب ة ت ا ا ا ٣	ط ط ع غ ٤	س ش ص ض ه ٥	ذ ز ر ز ٦	ي ء ٧	م ن ه و ٨	ف ق ك ل ٩

Extended character table (AÄÄ)

0	1	2 ABC	3 DEF	4 GHI	5 JKL	6 MNO	7 PQRS	8 TUV	9 WXYZ
Space 0	Space # & ' () * , - . / 1	A Ä Á Å Æ B C Ç 2	D E È É Ê Ë Ï Î Ï 3	G Ğ H I Ì Í Ĵ Ķ 4	J K L 5	M N Ñ O Ö Ó Ô Õ Ö 6	P Q R S Ş ß 7	T U Û Ü Ú Û Û V 8	W Ŵ X Y ŷ Z 9
		a à á â ã ä å æ b c ç 2	d e è é ê ë ë f 3	g ğ h i ì í ĵ ħ 4	j k l 5	m n ñ o ö ó ô õ ö ø 6	p q r s ş ß 7	t u ù ú û ü ü v 8	w ŵ x y ŷ z 9

- The following are used for both uppercase and lowercase: ø Ş Ŵ ŷ

Useful Information

Error messages

If the unit detects a problem, one of the following messages is shown on the display.

Display message	Cause/solution
Check Phone Line	<ul style="list-style-type: none"> The supplied telephone line cord has not been connected yet or not connected properly. Check the connections (page 8).
Error ^{*1}	<ul style="list-style-type: none"> Recording was too short. Try again.
Failed ^{*2}	<ul style="list-style-type: none"> Phonebook copy failed (page 18). Confirm the other handset (the receiver) is in standby mode and try again.
Incomplete ^{*2}	<ul style="list-style-type: none"> The receiver's phonebook memory is full. Erase the unnecessary phonebook entries from the other handset (the receiver) and try again.
Memory Full	<ul style="list-style-type: none"> The phonebook memory is full. Erase unnecessary entries (page 17). Message memory is full. Erase unnecessary messages (page 29).^{*1} The call barred list memory is full. Erase unnecessary entries (page 22).^{*1}
No link. Reconnect AC adaptor.	<ul style="list-style-type: none"> The handset has lost communication with the base unit. Move closer to the base unit and try again. Unplug the base unit's AC adaptor to reset the unit. Reconnect the adaptor and try again. The handset's registration may have been cancelled. Re-register the handset (page 23).
Use rechargeable battery.	<ul style="list-style-type: none"> A wrong type of battery such as Alkaline or Manganese was inserted. Use only the rechargeable Ni-MH battery noted on page 4, 6.
You must first subscribe to Caller ID.	<ul style="list-style-type: none"> You must subscribe to a Caller ID service. Once you receive caller information after subscribing to a Caller ID service, this message will not be displayed.

*1 KX-TG6421

*2 KX-TG6412/KX-TG6413

Useful Information**Troubleshooting**

If you still have difficulties after following the instructions in this section, disconnect the base unit's AC adaptor and turn off the handset, then reconnect the base unit's AC adaptor and turn on the handset.

General use

Problem	Cause/solution
The handset does not automatically turn on after installing/replacing batteries.	<ul style="list-style-type: none"> • The battery is empty or too weak to turn on the power. Place the handset on the base unit or charger, and let it charge.
The unit does not work.	<ul style="list-style-type: none"> • Make sure the batteries are installed correctly (page 8). • Fully charge the batteries (page 8). • Check the connections (page 8). • Unplug the base unit's AC adaptor to reset the unit and turn off the handset. Reconnect the adaptor, turn on the handset and try again. • The handset has not been registered to the base unit. Register the handset (page 23).
I cannot hear a dial tone.	<ul style="list-style-type: none"> • Make sure that you are using the supplied telephone line cord. Your old telephone line cord may have a different wiring configuration. • The base unit's AC adaptor or telephone line cord is not connected. Check the connections. • If you are using a splitter to connect the unit, remove the splitter and connect the unit to the wall jack directly. If the unit operates properly, check the splitter. • Disconnect the base unit from the telephone line and connect the line to a known working telephone. If the working telephone operates properly, contact our service personnel to have the unit repaired. If the working telephone does not operate properly, contact your service provider/telephone company.

Useful Information



Problem	Cause/solution
I do not know how to erase → (Missed call) from the display.	<ul style="list-style-type: none"> There are unviewed missed calls remaining. View them and erase → in the following way. <ol style="list-style-type: none">  (middle soft key) [▼]/[▲]: "Caller List" → OK Press [▼] to search from the most recent call, or press [▲] to search from the oldest call.

Programmable settings

Problem	Cause/solution
I have changed the display language to a language I cannot read.	<ul style="list-style-type: none"> Change the display language (page 13).
While programming, the handset starts to ring.	<ul style="list-style-type: none"> A call is being received. Answer the call and start again after hanging up.
While programming, the display returns to standby mode.	<ul style="list-style-type: none"> A call matching an entry in the call barred list is being received.*¹ Wait and try again later.
I cannot register a handset to a base unit.	<ul style="list-style-type: none"> You entered the wrong PIN. If you forget your PIN, contact your nearest Panasonic service centre. Place the handset and the base unit away from other electrical appliances.

*1 KX-TG6421

Battery recharge

Problem	Cause/solution
The handset beeps and/or  flashes.	<ul style="list-style-type: none"> Battery charge is low. Fully charge the batteries (page 8).
I fully charged the batteries, but  still flashes.	<ul style="list-style-type: none"> Clean the charge contacts and charge again (page 9). It is time to replace the batteries (page 8).
I fully charged the batteries, but the operating time seems to be shorter.	<ul style="list-style-type: none"> Clean the battery ends (+, -) and the charge contacts with a dry cloth and charge again.
The handset display is blank.	<ul style="list-style-type: none"> The handset is not turned on. Turn the power on (page 12).

Useful Information

Making/answering calls, intercom

Problem	Cause/solution
<p>☐ is flashing.</p>	<ul style="list-style-type: none"> ● The handset is too far from the base unit. Move closer. ● The base unit's AC adaptor is not properly connected. Reconnect AC adaptor to the base unit. ● You are using the handset or base unit in an area with high electrical interference. Reposition the base unit and use the handset away from sources of interference. ● The handset is not registered to the base unit. Register it (page 23).
<p>Noise is heard, sound cuts in and out.</p>	<ul style="list-style-type: none"> ● You are using the handset or base unit in an area with high electrical interference. Reposition the base unit and use the handset away from sources of interference. ● Move closer to the base unit. ● If you use a DSL/ADSL service, we recommend connecting a DSL/ADSL filter between the base unit and the telephone line jack. Contact your DSL/ADSL provider for details.
<p>The handset does not ring.</p>	<ul style="list-style-type: none"> ● The ringer volume is turned off. Adjust ringer volume (page 19).
<p>The base unit does not ring.*1</p>	<ul style="list-style-type: none"> ● The ringer volume is turned off. Adjust ringer volume (page 20).
<p>I cannot make a call.</p>	<ul style="list-style-type: none"> ● The dialling mode may be set incorrectly. Change the setting (page 13). ● The handset is too far from the base unit. Move closer and try again. ● Another unit is in use. Wait and try again later. ● Answering system is being used.*1 Wait and try again later. ● The key lock feature is turned on. Turn it off (page 16).

*1 KX-TG6421

Useful Information

Caller ID

Problem	Cause/solution
Caller information is not displayed.	<ul style="list-style-type: none">• You must subscribe to a Caller ID service. Contact your service provider/telephone company for details.• If your unit is connected to any additional telephone equipment, remove and plug the unit directly into the wall jack.• If you use a DSL/ADSL service, we recommend connecting a DSL/ADSL filter between the base unit and the telephone line jack. Contact your DSL/ADSL provider for details.• Other telephone equipment may be interfering with this unit. Disconnect the other equipment and try again.
Caller information is slow to display.	<ul style="list-style-type: none">• Depending on your service provider/telephone company, the unit may display the caller's information at the 2nd ring or later.• Move closer to the base unit.
Time on the unit has shifted.	<ul style="list-style-type: none">• Incorrect time information from incoming Caller ID changes the time. Set the time adjustment to "Manual" (off) (page 19).
The name stored in the phonebook is not fully displayed while an outside call is being received.	<ul style="list-style-type: none">• Edit the phonebook entry name to fit in 1 line of text (page 17).

Useful Information**Answering system (KX-TG6421)**

Problem	Cause/solution
The unit does not record new messages.	<ul style="list-style-type: none"> ● The answering system is turned off. Turn it on (page 27). ● The message memory is full. Erase unnecessary messages (page 29). ● The recording time is set to “Greeting Only”. Change the setting (page 32). ● If your own greeting message is not recorded properly, callers are unable to leave a message. Record your own greeting message again (page 28). ● If you subscribe to a voice mail service, messages are recorded by your service provider/telephone company, not your telephone. Change the unit's number of rings setting or contact your service provider/telephone company (page 31).
My own greeting message cannot be properly heard.	<ul style="list-style-type: none"> ● Record your own greeting message again (page 28).
I cannot operate the answering system.	<ul style="list-style-type: none"> ● Someone is using the unit. Wait for the other user to finish. ● A caller is leaving a message. Wait for the caller to finish. ● The handset is too far from the base unit. Move closer.
I cannot operate the answering system remotely.	<ul style="list-style-type: none"> ● You are entering the wrong remote access code. If you have forgotten your remote access code, enter the remote access code setting to check your current code (page 30). ● Press each key firmly. ● The answering system is turned off. Turn it on (page 31). ● You are using a rotary/pulse telephone. Try again using a touch-tone phone.
While recording a greeting message or listening to messages, the unit rings and the operation stops.	<ul style="list-style-type: none"> ● A call is being received. Answer the call and try again later.

Useful Information

Liquid damage

Problem	Cause/solution
Liquid or other form of moisture has entered the handset/base unit.	<ul style="list-style-type: none"> Disconnect the AC adaptor and telephone line cord from the base unit. Remove the batteries from the handset and leave to dry for at least 3 days. After the handset/base unit are completely dry, reconnect the AC adaptor and telephone line cord. Insert the batteries and charge fully before use. If the unit does not work properly, contact your nearest Panasonic service centre.

Caution:

- To avoid permanent damage, do not use a microwave oven to speed up the drying process.

Wall mounting

■ Base unit

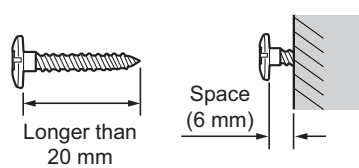
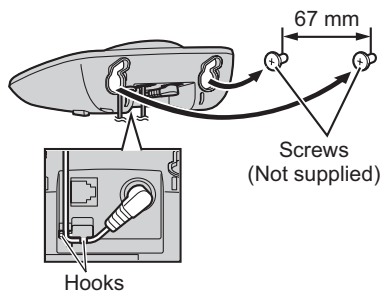

■ Charger

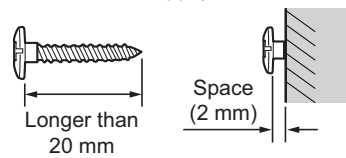
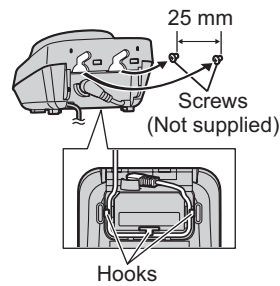

Index

- A** Alarm: 21
- Answering calls: 14
- Answering system: 27
- Call screening: 27
- Erasing messages: 29, 31
- Greeting only: 32
- Listening to messages: 28, 29, 30
- Number of rings: 31
- Recording time: 32
- Remote access code: 30
- Remote operation: 30
- Turning on/off: 27, 29, 31
- Area code: 21
- Auto talk: 14, 19
- B** Battery: 8, 9
- C** Caller ID service: 25
- Caller list: 25
- Caller list edit: 26
- Call share: 15
- Call waiting: 15
- Call Waiting Caller ID: 15
- Chain dial: 18
- Character entry: 36
- Conference calls: 34
- D** Date and time: 13
- Dialling mode: 13
- Display
- Contrast: 19
- Language: 12
- E** Error messages: 38
- G** Greeting message: 28
- H** Handset
- Deregistration: 23
- Locator: 34
- Registration: 23
- I** Incoming call barring: 22
- Intercom: 34
- K** Key lock: 16
- Keytones: 19
- M** Making calls: 14
- Missed calls: 25
- Mute: 15
- P** Pause: 14
- Phonebook: 17
- PIN: 21
- Power failure: 9
- Power on/off: 12
- Privacy mode: 20
- R** Recall/flash: 15, 20
- Redialling: 14
- Repeater: 23
- Ringer tone: 19
- S** Speakerphone: 14
- T** Temporary tone dialling: 15
- Time adjustment: 19
- Transferring calls: 34
- Troubleshooting: 39
- V** Voice mail: 33
- Volume
- Receiver: 14
- Ringer (Base unit): 20
- Ringer (Handset): 15, 19
- Speaker: 14
- W** Wall mounting: 44

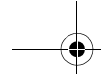

Notes

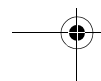
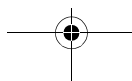
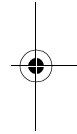
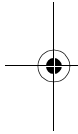

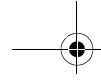

Notes

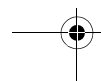
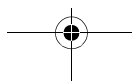
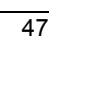
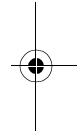
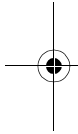

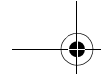

For your future reference

We recommend keeping a record of the following information to assist with any repair under warranty.

Serial No.

Date of purchase

(found on the bottom of the base unit)

Name and address of dealer

Attach your purchase receipt here.

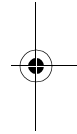
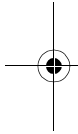

Panasonic Communications Co., Ltd.

1-62, 4-chome, Minoshima, Hakata-ku, Fukuoka 812-8531, Japan

Copyright:

This material is copyrighted by Panasonic Communications Co., Ltd., and may be reproduced for internal use only. All other reproduction, in whole or in part, is prohibited without the written consent of Panasonic Communications Co., Ltd.

© Panasonic Communications Co., Ltd. 2009



TG6411 BX

PNQX1690ZA CC0509DQ0

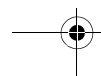
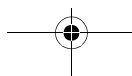

Free Manuals Download Website

<http://myh66.com>

<http://usermanuals.us>

<http://www.somanuals.com>

<http://www.4manuals.cc>

<http://www.manual-lib.com>

<http://www.404manual.com>

<http://www.luxmanual.com>

<http://aubethermostatmanual.com>

Golf course search by state

<http://golfingnear.com>

Email search by domain

<http://emailbydomain.com>

Auto manuals search

<http://auto.somanuals.com>

TV manuals search

<http://tv.somanuals.com>