

# Panasonic®

## Operating Instructions

Expandable Digital Cordless Phone

Model No. **KX-TG9321**  
**KX-TG9322**

**2LINE**

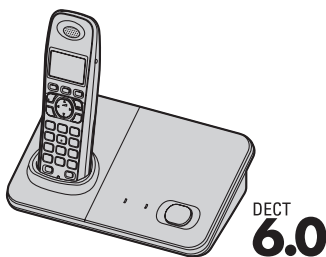

Model shown is KX-TG9321.

***Before initial use, see “Getting Started” on page 8.***

**Thank you for purchasing a Panasonic product.**

Please read these operating instructions before using the unit and save them for future reference.

**Consulte “Guía Rápida Española”, página 47.**

This unit is compatible with Caller ID. You must subscribe to the appropriate service offered by your service provider/telephone company.

For assistance, visit our Web site: <http://www.panasonic.com/help> for customers in the U.S.A. or Puerto Rico.

**Please register your product: <http://www.panasonic.com/prodreg>**

## Table of Contents

---

### Introduction

Model composition . . . . .	3
Accessory information . . . . .	3

### Important Information

For your safety . . . . .	5
Important safety instructions . . . . .	6
For best performance . . . . .	6
Other information . . . . .	7
Specifications . . . . .	7

### Getting Started

Setting up . . . . .	8
Note when setting up . . . . .	11
Controls . . . . .	12
Display . . . . .	13
Initial settings . . . . .	13

### Making/Answering Calls

Making calls . . . . .	15
Answering calls . . . . .	16
Useful features during a call . . . . .	16
Using the other line during a call . . . . .	18

### Phonebook

Handset phonebook . . . . .	19
Copying phonebook entries . . . . .	21

### Programming

Programmable settings . . . . .	23
Special programming . . . . .	28
Registering a unit . . . . .	29

### Caller ID Service

Using Caller ID service . . . . .	30
Caller list . . . . .	30

### Voice Mail Service

Voice mail service . . . . .	33
------------------------------	----

### Intercom/Locator

Intercom . . . . .	35
Handset locator . . . . .	35
Transferring calls . . . . .	35
Conference calls . . . . .	35

### Useful Information

Wall mounting . . . . .	37
Belt clip . . . . .	38

Error messages . . . . .	39
Troubleshooting . . . . .	41
FCC and other information . . . . .	45

### Guía Rápida Española

Guía Rápida Española . . . . .	47
--------------------------------	----

### Appendix

Customer services . . . . .	51
Warranty (For United States and Puerto Rico) . . . . .	52

### Index

Index . . . . .	54
-----------------	----

## Model composition

Series	Model No.	Base unit	Handset	
		Part No.	Part No.	Quantity
KX-TG9321 series	KX-TG9321 <sup>*1</sup>	KX-TG9321	KX-TGA939	1
	KX-TG9322	KX-TG9321	KX-TGA939	2

\*1 Feature differences:

Intercom calls can be made between handsets by purchasing and registering one or more optional handsets (page 4).

## Accessory information

### Supplied accessories

No.	Accessory item/Order number	Quantity	
		KX-TG9321	KX-TG9322
①	AC adaptor/PQLV219Y	1	2
②	4-wire telephone line cord with green plugs/PQJA10088Z	1	1
③	2-wire telephone line cord with transparent plugs/PQJA10075Z	1	1
④	Wall mounting adaptor/PQKL10078Z2	1	1
⑤	Rechargeable batteries/HHR-4DPA (Part No. HHR-55AAABU or N4DHYYY00004)	2	4
⑥	Handset cover <sup>*1</sup> /PNYNTGA939TR	1	2
⑦	Belt clip/PNKE1004Z1	1	2
⑧	Charger/PNLC1001YT	–	1

\*1 The handset cover comes attached to the handset.

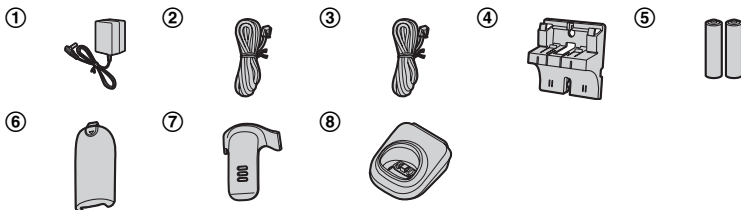

### Additional/replacement accessories

Please contact your nearest Panasonic dealer for sales information (page 51).

Accessory item	Order number
Rechargeable batteries	HHR-4DPA <sup>*1</sup> <ul style="list-style-type: none"><li>● To order, please call 1-800-332-5368 or visit <a href="http://www.panasonic.com/batterystore">http://www.panasonic.com/batterystore</a></li></ul>
	Battery type: <ul style="list-style-type: none"><li>– Nickel metal hydride (Ni-MH)</li><li>– 2 x AAA (R03) size for each handset</li></ul>
Headset	KX-TCA60, KX-TCA93, KX-TCA94, KX-TCA400, KX-TCA430
T-adaptor	KX-J66
2-line splitter	KX-J42
Battery back-up power supply	KX-TCA230

\*1 Replacement batteries may have a different capacity from that of the supplied batteries.

### Expanding your phone system

You can expand your phone system by registering optional handsets (6 max.) to a single base unit.

- Optional handsets may be a different color from that of the supplied handsets.

#### Important:

- When you purchase an additional handset, please check whether models KX-TG9321/KX-TG9322 are noted as compatible models on the carton box to support all original features.

**Handset (optional): KX-TGA939**



---

## For your safety

To prevent severe injury and loss of life/property, read this section carefully before using the product to ensure proper and safe operation of your product.

---

### WARNING

---

#### Power connection

- Use only the power source marked on the product.
- Do not overload power outlets and extension cords. This can result in the risk of fire or electric shock.
- Completely insert the AC adaptor/power plug into the power outlet. Failure to do so may cause electric shock and/or excessive heat resulting in a fire.
- Regularly remove any dust, etc. from the AC adaptor/power plug by pulling it from the power outlet, then wiping with a dry cloth. Accumulated dust may cause an insulation defect from moisture, etc. resulting in a fire.
- Unplug the product from power outlets if it emits smoke, an abnormal smell, or makes an unusual noise. These conditions can cause fire or electric shock. Confirm that smoke has stopped emitting and contact the Panasonic Call Center at 1-800-211-PANA (1-800-211-7262).
- Unplug from power outlets and never touch the inside of the product if its casing has been broken open.
- Never touch the plug with wet hands. Danger of electric shock exists.

---

#### Installation

- To prevent the risk of fire or electrical shock, do not expose the product to rain or any type of moisture.
- Do not place or use this product near automatically controlled devices such as automatic doors and fire alarms. Radio waves emitted from this product may cause such devices to malfunction resulting in an accident.
- Do not allow the AC adaptor or telephone line cord to be excessively pulled, bent or placed under heavy objects.

---

#### Operating safeguards

- Unplug the product from power outlets before cleaning. Do not use liquid or aerosol cleaners.
- Do not disassemble the product.
- Do not spill liquids (detergents, cleansers, etc.) onto the telephone line cord plug, or allow it to become wet at all. This may cause a fire. If the telephone line cord plug becomes wet, immediately pull it from the telephone wall jack, and do not use.

---

#### Medical

- Consult the manufacturer of any personal medical devices, such as pacemakers or hearing aids, to determine if they are adequately shielded from external RF (radio frequency) energy. (The product operates in the frequency range of 1.92 GHz to 1.93 GHz, and the RF transmission power is 115 mW (max.).)
- Do not use the product in health care facilities if any regulations posted in the area instruct you not to do so. Hospitals or health care facilities may be using equipment that could be sensitive to external RF energy.

---

### CAUTION

---

#### Installation and location

- Never install telephone wiring during an electrical storm.
- Never install telephone line jacks in wet locations unless the jack is specifically designed for wet locations.
- Never touch uninsulated telephone wires or terminals unless the telephone line has been disconnected at the network interface.
- Use caution when installing or modifying telephone lines.
- The AC adaptor is used as the main disconnect device. Ensure that the AC outlet is installed near the product and is easily accessible.
- This product is unable to make calls when:
  - the handset batteries need recharging or have failed.
  - there is a power failure.

### Battery

- We recommend using the batteries noted on page 4. **USE ONLY rechargeable Ni-MH batteries AAA (R03) size.**
- Do not mix old and new batteries.
- Do not open or mutilate the batteries. Released electrolyte from the batteries is corrosive and may cause burns or injury to the eyes or skin. The electrolyte is toxic and may be harmful if swallowed.
- Exercise care when handling the batteries. Do not allow conductive materials such as rings, bracelets, or keys to touch the batteries, otherwise a short circuit may cause the batteries and/or the conductive material to overheat and cause burns.
- Charge the batteries provided with or identified for use with this product only, in accordance with the instructions and limitations specified in this manual.
- Only use a compatible base unit (or charger) to charge the batteries. Do not tamper with the base unit (or charger). Failure to follow these instructions may cause the batteries to swell or explode.

### Attention:



A nickel metal hydride battery that is recyclable powers the product you have purchased. Please call 1-800-8-BATTERY (1-800-822-8837) for information on how to recycle this battery.

---

## Important safety instructions

When using your product, basic safety precautions should always be followed to reduce the risk of fire, electric shock, and injury to persons, including the following:

1. Do not use this product near water for example, near a bathtub, washbowl,

kitchen sink, or laundry tub, in a wet basement or near a swimming pool.

2. Avoid using a telephone (other than a cordless type) during an electrical storm. There may be a remote risk of electric shock from lightning.
3. Do not use the telephone to report a gas leak in the vicinity of the leak.
4. Use only the power cord and batteries indicated in this manual. Do not dispose of batteries in a fire. They may explode. Check with local codes for possible special disposal instructions.

### SAVE THESE INSTRUCTIONS

---

## For best performance

---

### Base unit location/avoiding noise

The base unit and other compatible Panasonic units use radio waves to communicate with each other.

- For maximum coverage and noise-free communications, place your base unit:
  - at a convenient, high, and central location with no obstructions between the handset and base unit in an indoor environment.
  - away from electronic appliances such as TVs, radios, personal computers, wireless devices, or other phones.
  - facing away from radio frequency transmitters, such as external antennas of mobile phone cell stations. (Avoid putting the base unit on a bay window or near a window.)
- Coverage and voice quality depends on the local environmental conditions.
- If the reception for a base unit location is not satisfactory, move the base unit to another location for better reception.

---

### Environment

- Keep the product away from electrical noise generating devices, such as fluorescent lamps and motors.
- The product should be kept free from excessive smoke, dust, high temperature, and vibration.
- The product should not be exposed to direct sunlight.
- Do not place heavy objects on top of the product.

- When you leave the product unused for a long period of time, unplug the product from the power outlet.
- The product should be kept away from heat sources such as heaters, kitchen stoves, etc. It should not be placed in rooms where the temperature is less than 0 °C (32 °F) or greater than 40 °C (104 °F). Damp basements should also be avoided.
- The maximum calling distance may be shortened when the product is used in the following places: Near obstacles such as hills, tunnels, underground, near metal objects such as wire fences, etc.
- Operating the product near electrical appliances may cause interference. Move away from the electrical appliances.

### Routine care

- **Wipe the outer surface of the product with a soft moist cloth.**
- Do not use benzine, thinner, or any abrasive powder.

## Other information

**CAUTION:** Risk of explosion if battery is replaced by an incorrect type. Dispose of used batteries according to the instructions.

### Notice for product disposal, transfer, or return

- This product can store your private/confidential information. To protect your privacy/confidentiality, we recommend that you erase information such as phonebook or caller list entries from the memory before you dispose of, transfer, or return the product.

### Notice

- This product is designed for use in the United States of America. Sale or use of this product in other countries may violate local laws.
- Cet appareil est conçu pour être utilisé aux États-Unis d'Amérique. La vente ou l'emploi de cet appareil dans certains autres pays peut constituer une infraction à la législation locale.

- Este producto está diseñado para usarse en los Estados Unidos de América. La venta o el empleo de este producto en ciertos países puede constituir violación de la legislación local.
- 本產品專為美國使用而設。若在其他國家銷售或使用，可能會違反當地法例。
- この製品は、日本国外での使用を目的として設計されており、日本国内での使用は法律違反となります。従って、当社では日本国内においては原則として修理などのサービスは致しかねます。

### ENERGY STAR

As an ENERGY STAR® Partner, Panasonic has determined that this product meets the ENERGY STAR guidelines for energy efficiency. ENERGY STAR is a U.S. registered mark.



## Specifications

- **Standard:**  
DECT 6.0 (Digital Enhanced Cordless Telecommunications 6.0)
- **Frequency range:**  
1.92 GHz to 1.93 GHz
- **RF transmission power:**  
115 mW (max.)
- **Power source:**  
120 V AC, 60 Hz
- **Power consumption:**  
**Base unit:**  
Standby: Approx. 1.4 W  
Maximum: Approx. 4.2 W  
**Charger:**  
Standby: Approx. 0.6 W  
Maximum: Approx. 3.6 W
- **Operating conditions:**  
0 °C – 40 °C (32 °F – 104 °F), 20 % – 80 % relative air humidity (dry)

### Note:

- Design and specifications are subject to change without notice.
- The illustrations in these instructions may vary slightly from the actual product.

## Setting up

### Connecting the AC adaptor

- Use only the supplied Panasonic AC adaptor PQLV219.

#### ■ Base unit

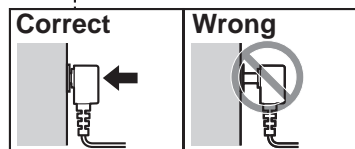
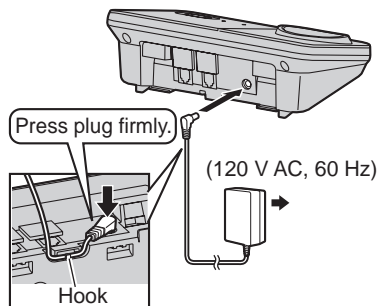

#### ■ Charger

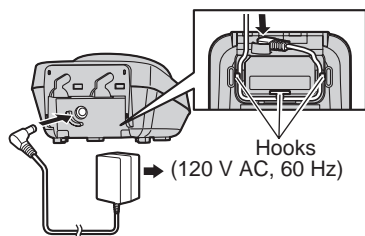

## Connecting the telephone line cord

Refer to one of the following methods depending on your situation:

- To connect to a 2-line telephone jack: page 8
- To connect to 2 single-line telephone jacks: page 9
- If you use the unit as a single-line telephone only: page 9

Connect the telephone line cord until it clicks into the base unit and telephone line jack.

### To connect to a 2-line telephone jack

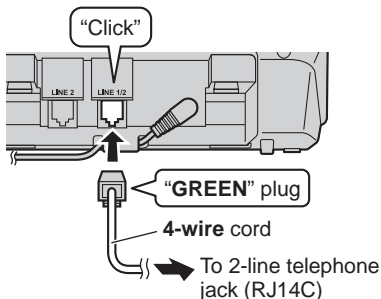



## To connect to 2 single-line telephone jacks

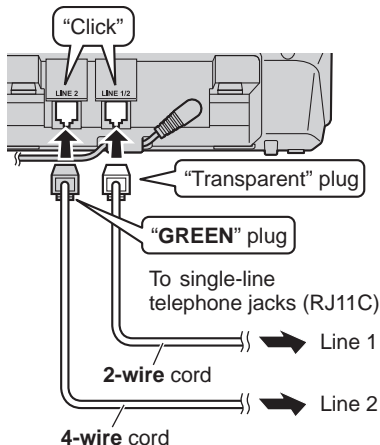

## If you use the unit as a single-line telephone only

Be sure to connect the telephone line cord to LINE 1/2. Change the line selection mode from “Auto” to “Line1” (page 14).

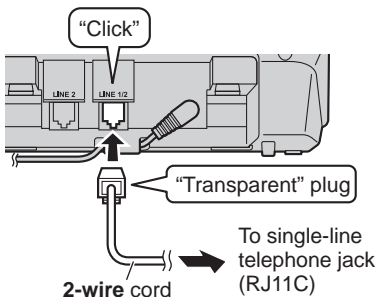

### Note:

- “Check tel line 2” is displayed on the unit. To erase it, see page 39.

## If you subscribe to a DSL/ADSL service

Please attach a DSL/ADSL filter (contact your DSL/ADSL provider) to the telephone line between the base unit and the telephone line jack in the event of the following:

- noise is heard during conversations.
- Caller ID features do not function properly.

## To connect to a 2-line telephone jack

For this connection, please purchase a Panasonic 2-line splitter (page 4).

**Example:** DSL/ADSL line is line 2

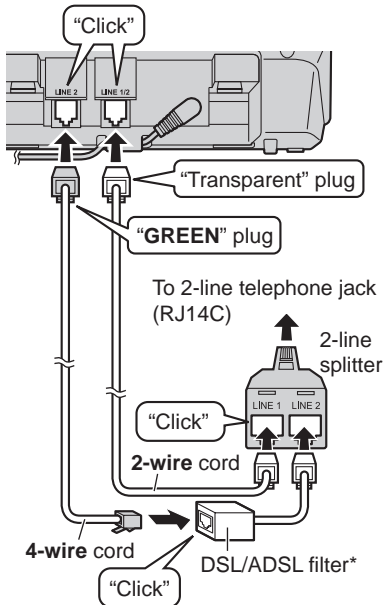

\*DSL/ADSL filter (not supplied) is required if you have DSL/ADSL service.

## To connect to 2 single-line telephone jacks

Example: DSL/ADSL line is line 2

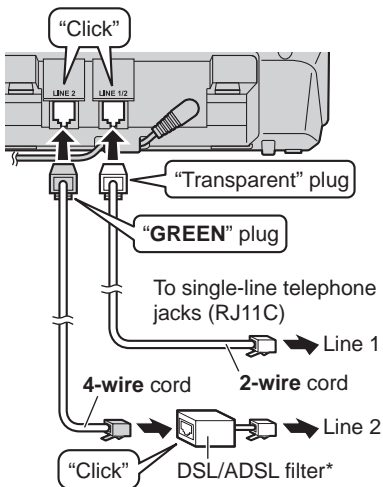

\*DSL/ADSL filter (not supplied) is required if you have DSL/ADSL service.

## Battery installation

- USE ONLY Ni-MH batteries AAA (R03) size.
- Do NOT use Alkaline/Manganese/Ni-Cd batteries.
- Confirm correct polarities ( $\oplus$ ,  $\ominus$ ).

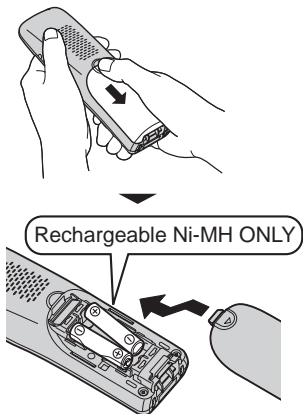

## Battery charge

Charge for about 7 hours.

- When the batteries are fully charged, "Charge completed" is displayed.

Confirm "Charging" is displayed.

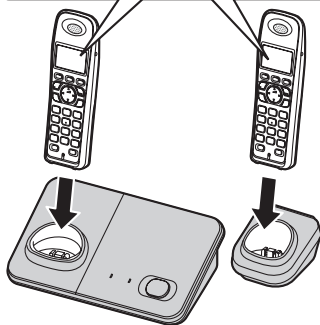

## Note when setting up

### Note for connections

- The AC adaptor must remain connected at all times. (It is normal for the adaptor to feel warm during use.)
- The AC adaptor should be connected to a vertically oriented or floor-mounted AC outlet. Do not connect the AC adaptor to a ceiling-mounted AC outlet, as the weight of the adaptor may cause it to become disconnected.

### During a power failure

The unit will not work during a power failure. We recommend connecting a corded-type telephone (without AC adaptor) to the same telephone line or to the same telephone line jack using a Panasonic T-adaptor (page 4). Emergency power can be supplied to the unit by connecting a Panasonic battery back-up power supply noted on page 4.





### Note for battery installation

- Use the supplied rechargeable batteries. For replacement, we recommend using the Panasonic rechargeable batteries noted on page 4, 6.
- Wipe the battery ends (+, -) with a dry cloth.
- Avoid touching the battery ends (+, -) or the unit contacts.

### Note for battery charge

- It is normal for the handset to feel warm during charging.
- Clean the charge contacts of the handset, base unit, and charger with a soft and dry cloth once a month. Clean more often if the unit is exposed to grease, dust, or high humidity.

### Battery level

Icon	Battery level
	High
	Medium
	Low
	Needs charging.

### Panasonic Ni-MH battery performance (supplied batteries)

Operation	Operating time
In continuous use	12 hours max.
Not in use (standby)	6 days max.

### Note:

- Actual battery performance depends on usage and ambient environment.
- Even after the handset is fully charged, the handset can be left on the base unit or charger without any ill effect on the batteries.
- The battery level may not be displayed correctly after you replace the batteries. In this case, place the handset on the base unit or charger and let it charge for at least 7 hours.

## Controls

### Handset

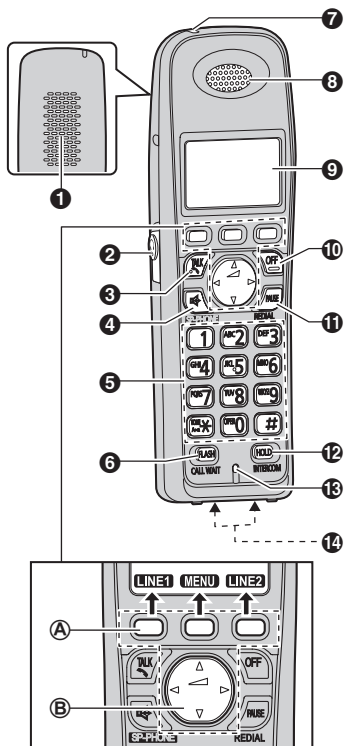

- 1 Speaker
- 2 Headset jack
- 3 [ TALK ]
- 4 [ SP-PHONE: Speakerphone ]
- 5 Dial keypad ([ \* ]: TONE)
- 6 [ FLASH ] [ CALL WAIT ]
- 7 Charge indicator  
Ringer indicator
- 8 Receiver
- 9 Display
- 10 [ OFF ]

- 11 [ PAUSE ] [ REDIAL ]
- 12 [ HOLD ] [ INTERCOM ]
- 13 Microphone
- 14 Charge contacts

#### Control type

##### A Soft keys

The handset features 3 soft keys. By pressing a soft key, you can select the feature shown directly above it on the display.

##### B Navigator key

- [▲], [▼], [◀], or [▶]: Scroll through various lists and items.
- ▲ (Volume: [▲] or [▼]): Adjust the receiver or speaker volume while talking.



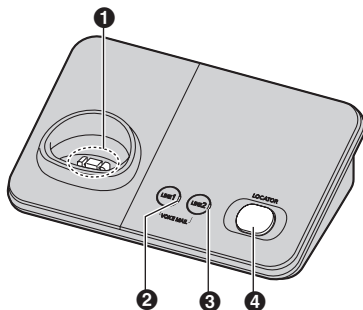





### Base unit



- 1 Charge contacts
- 2 LINE1 indicator for VOICE MAIL
- 3 LINE2 indicator for VOICE MAIL
- 4 [ LOCATOR ]

# Display







## Handset display items

Item	Meaning
	Battery level
	Within range of a base unit <ul style="list-style-type: none"> <li>When flashing: Handset is searching for the base unit. (page 42)</li> </ul>
 	The line is in use. <ul style="list-style-type: none"> <li>When flashing: The call is put on hold on that line.</li> <li>When flashing rapidly: An incoming call is now being received on that line.</li> </ul>
 L1 L2	Ringer volume is off. <sup>*1</sup> (page 26)
	Speakerphone is on. (page 15)
	Night mode is on. (page 28)
	Alarm is on. (page 28)
	Handset number
PRIV.	Privacy mode is on. (page 17)

\*1 Corresponding line number(s) is indicated next to the item.

## Handset main menu icons

The following icons are shown when you press down on the middle soft key in standby mode.

Icon	Feature
	View Caller ID
	Phonebook
	V.M. access
	Ringer settings
	Initial settings
	Customer support

## Initial settings

### Symbol meaning:

Example: [▼]/[▲]: “off”

Press [▼] or [▲] to select the words in quotations.

## Display language

You can select either “English” or “Español” as the display language. The default setting is “English”.

- [MENU] → [#][1][1][0]**
- [▼]/[▲]:** Select the desired setting.
- [SAVE] → [OFF]**

## Dialing mode

If you cannot make calls, change this setting according to your telephone line service. The default setting is “Tone”.  
 “Tone”: For tone dial service.  
 “Pulse”: For rotary/pulse dial service.

- [MENU] → [#][1][2][0]**
- [▼]/[▲]:** Select the desired setting.
- [SAVE] → [OFF]**

## Date and time

- 1 **[MENU]** → **[#][1][0][1]**
- 2 Enter the current month, date, and year by selecting 2 digits for each.  
**Example:** December 15, 2010  
**[1][2] [1][5] [1][0]**
- 3 Enter the current hour and minute (12-hour clock format) by selecting 2 digits for each.  
**Example:** 9:30  
**[0][9] [3][0]**
- 4 Press **[\*]** to select “**AM**” or “**PM**”.
- 5 **[SAVE]** → **[OFF]**

### Note:

- When English is selected as the display language, 12-hour clock format is used. When Spanish is selected, 24-hour clock format is used.
- To correct a digit, press **[▲]**, **[▼]**, **[←]**, or **[→]** to move the cursor to the digit, then make the correction.
- The date and time may be incorrect after a power failure. In this case, set the date and time again.

## Line selection mode

The line selection mode determines which line is selected when you press **[📞]/[📞]** on the handset (when making/answering calls).

The following settings are available:

- “**Auto**” (default): When making a call, line 1 is selected. If that line is unavailable, line 2 is selected. When you call back using the caller list (page 30), the indicated line is used. When answering a call, the ringing line is selected.
- “**Line1**”: Line 1 is selected.
- “**Line2**”: Line 2 is selected.

- 1 **[MENU]** → **[#][2][5][0]**

- 2 **[▼]/[▲]**: Select the desired setting.
- 3 **[SAVE]** → **[OFF]**

### Note:

- You can select a line manually regardless of the line selection mode by pressing **[LINE 1]** or **[LINE 2]**.

## Making calls

- 1 Lift the handset and dial the phone number.
  - To correct a digit, press **[CLEAR]**.
- 2 
  - An available line is automatically selected and the line number is displayed. To change the line selection mode, see page 14.
  - You can also select the line manually by pressing **[LINE 1]** or **[LINE 2]**.
- 3 When you finish talking, press **[OFF]** or place the handset on the base unit or charger.

### Note:

- **When 2 or more handsets are registered,**  
2 outside calls can be handled simultaneously on separate telephone lines.

**Example:** While line 1 is in use, you can make or answer a call on line 2 at the same time.

## Using the speakerphone

- 1 During a conversation, press  to turn on the speakerphone.
  - Speak alternately with the other party.
- 2 When you finish talking, press **[OFF]**.

### Note:

- For best performance, use the speakerphone in a quiet environment.
- To switch back to the receiver, press .

## Adjusting the receiver or speaker volume

Press **[▲]** or **[▼]** repeatedly while talking.

## Making a call using the redial list

The last 10 phone numbers dialed are stored in the redial list (each 48 digits max.).

- 1 **[REDIAL]**
- 2 **[▼]/[▲]**: Select the desired phone number.
- 3 

## Erasing a number in the redial list

- 1 **[REDIAL]**
- 2 **[▼]/[▲]**: Select the desired phone number. → **[ERASE]**
- 3 **[▼]/[▲]**: "Yes" → **[SELECT]**
- 4 **[OFF]**

## Pause (for PBX/long distance service users)

A pause is sometimes required when making calls using a PBX or long distance service. When storing a calling card access number and/or PIN in the phonebook, a pause is also needed (page 21).



**Example:** If you need to dial the line access number "9" when making outside calls with a PBX:



- 1 **[9]** → **[PAUSE]**
- 2 Dial the phone number. → 

### Note:

- A 3.5 second pause is inserted each time **[PAUSE]** is pressed. Repeat as needed to create longer pauses.

### Answering calls



When a call is being received, the ringer indicator and  and/or  flash rapidly.

- 1 Lift the handset and press [] or [] when the unit rings.
  - The called line is automatically selected. To change the line selection mode, see page 14.
  - You can also answer the call by pressing [**LINE 1**] or [**LINE 2**].
  - You can also answer the call by pressing any dial key from [**0**] to [**9**], [**\***], or [**#**]. (**Any key answer feature**)
- 2 When you finish talking, press [**OFF**] or place the handset on the base unit or charger.

#### Auto talk

You can answer calls simply by lifting the handset off the base unit or charger. You do not need to press []. To turn this feature on, see page 26.

#### Adjusting the handset ringer volume

Press [] or [] repeatedly to select the desired volume while the handset is ringing for an incoming call.

#### Note:

- You can also program the handset ringer volume beforehand (page 25).

#### Temporary handset ringer off

While the handset is ringing for a call, you can turn the ringer off temporarily by pressing [**OFF**].

### Useful features during a call

#### Hold

This feature allows you to put an outside call on hold.

- 1 Press [**HOLD**] 2 times during an outside call.
- 2 To release hold, press [**LINE 1**] or [**LINE 2**] that is flashing on the handset.
  - Another handset user can take the call by pressing [**LINE 1**] or [**LINE 2**].

#### Note:

- If a call is kept on hold for more than 9 minutes, an alarm tone starts to sound. After 1 additional minute on hold, the call is disconnected.
- If another phone is connected to the same line (page 11), you can also take the call by lifting its handset.

#### Mute

While mute is turned on, you can hear the other party, but the other party cannot hear you.

- 1 Press [**MUTE**] during conversation.
  - [**MUTE**] flashes.
- 2 To return to the conversation, press [**MUTE**] again.

#### Note:

- [**MUTE**] is a soft key visible on the handset display during a call.

#### Flash

[**FLASH**] allows you to use the special features of your host PBX such as transferring an extension call, or accessing optional telephone services.



**Note:**

- To change the flash time, see page 26.

---

## For call waiting or Call Waiting Caller ID service users

To use call waiting, you must first subscribe to call waiting from your service provider/telephone company. This feature allows you to receive calls while you are already talking on the phone. If you receive a call while on the phone, you will hear a call waiting tone.

**If you subscribe to both Caller ID and Call Waiting with Caller ID services,** the 2nd caller's information is displayed after you hear the call waiting tone on the handset.

- 1 Press **[CALL WAIT]** to answer the 2nd call.
- 2 To switch between calls, press **[CALL WAIT]**.

**Note:**

- Please contact your service provider/telephone company for details and availability of this service in your area.

---

## Temporary tone dialing (for rotary/pulse service users)

You can temporarily switch the dialing mode to tone when you need to access touch-tone services (for example, answering services, telephone banking services, etc.).

Press **[\*]** (TONE) before entering access numbers which require tone dialing.

---

## Call share

This feature allows you to join an existing outside call.

**Important:**

- When the privacy mode is on, you cannot join the conversation. Turn it off.

To join the conversation, press **[LINE 1]** or **[LINE 2]** to select the line that is being used by another extension for an outside call.

**Note:**

- A maximum of 3 parties (including 1 outside party) can join a conversation.

---

## Privacy mode

When the privacy mode is "on", the unit prevents other users from joining your conversations with outside callers. You can turn the feature on for both lines by programming before the call. To allow other users to join your conversations (call share), leave this feature off. The default setting is "off".

1 **[MENU] → [#][1][9][4]**

2 **[▼]/[▲]:** Select "On" or "Off".

3 **[SAVE] → [OFF]**

- When this feature is turned on, "PRIV." is displayed during an outside call.

---

## Temporarily turning privacy mode on/off

During an outside call, you can temporarily turn privacy mode on/off.

1 Press **[MENU]** during an outside call.

2 **[▼]/[▲]:** "Privacy" → **[SELECT]**

3 **[▼]/[▲]:** "On" or "Off" → **[SELECT]**

- When this feature is turned on, "PRIV." is displayed.

### Note:

- After you hang up the call, the feature will return to the setting programmed on page 26.

---

## Using the other line during a call

You can use the other line in the following ways:

- When a call is being received on the other line during a conversation, an interrupt tone will be heard (page 25). You can answer the 2nd call while holding the 1st call.
- During an outside call, you can also make a call using the other line by holding the 1st call.

**Example:** If you are using line 1:

- 1** Press **[HOLD]** 2 times to put the 1st call (line 1) on hold.
- 2** Press **[LINE 2]** to make or answer a 2nd call.
  - To hold the 2nd call, press **[HOLD]** 2 times.
- 3** To return to the 1st call (line 1), press **[LINE 1]**.

### Note:

- If you subscribe to Caller ID, the 2nd caller's information is displayed when a call is being received on the other line (page 30).

## Handset phonebook

The phonebook allows you to make calls without having to dial manually. You can add 100 names and phone numbers to the phonebook, and assign each phonebook entry to the desired group.

### Important:

- Caller ID subscribers can use group ringer tone features (page 30).

## Adding entries

- [MENU]** → **[#][2][8][0]**
- [ADD]**
- Enter the party's name (16 characters max.). → **[OK]**
- Enter the party's phone number (24 digits max.). → **[OK]**
- [▼]/[▲]**: Select the desired group. → **[SELECT]** 2 times
  - To add other entries, repeat from step 3.
- [OFF]**

### Character table for entering names

While entering characters, you can switch between uppercase and lowercase by pressing **[\*]** (A→a).

Key	Character
<b>[1]</b>	Space # & ' ( ) * , - . / 1
<b>[2]</b>	A B C 2
	a b c 2
<b>[3]</b>	D E F 3
	d e f 3
<b>[4]</b>	G H I 4
	g h i 4
<b>[5]</b>	J K L 5
	j k l 5

Key	Character
<b>[6]</b>	M N O 6
	m n o 6
<b>[7]</b>	P Q R S 7
	p q r s 7
<b>[8]</b>	T U V 8
	t u v 8
<b>[9]</b>	W X Y Z 9
	w x y z 9
<b>[0]</b>	Space 0

- To enter another character that is located on the same dial key, first press **[▶]** to move the cursor to the next space.

### Correcting a mistake

Press **[◀]** or **[▶]** to move the cursor to the character or number you want to erase, then press **[CLEAR]**. Enter the appropriate character or number.

- Press and hold **[CLEAR]** to erase all characters or numbers.

## Groups

Groups can help you find entries in the phonebook quickly and easily. When adding an entry to the phonebook, you can assign it to one of 9 groups. You can change the names of groups assigned for phonebook entries ("Friends", "Family", etc.) and then search for phonebook entries by group. The group ringer tone feature is available for Caller ID subscribers (page 30).

### Changing group names

The default group name is "Group 1" to "Group 9".

- [MENU]** → **[#][2][8][0]**
- [MENU]**
- [▼]/[▲]**: "Group" → **[SELECT]**

## Phonebook

---

- 4 **[▼]/[▲]**: Select the desired group.  
→ **[SELECT]**
- 5 **[▼]/[▲]**: "Group name" →  
**[SELECT]**
- 6 Edit the name (10 characters max.;  
page 19). → **[SAVE]**
- 7 **[OFF]**

---

## Finding and calling a phonebook entry

---

### Scrolling through all entries

- 1 **[MENU]** → **[#][2][8][0]**
- 2 **[▼]/[▲]**: Select the desired entry.
- 3 **[↶]**
  - You can also make a call by  
pressing **[CALL]**, then pressing  
**[LINE 1]** or **[LINE 2]**.

---

### Searching by first character

- 1 **[MENU]** → **[#][2][8][0]**
- 2 Press the dial key (**[0] – [9]**) which  
contains the character you are  
searching for (page 19).
  - Press the same dial key  
repeatedly to display the first  
entry corresponding to each  
character located on that dial key.
  - If there is no entry corresponding  
to the character you selected, the  
next entry is displayed.
- 3 **[▼]/[▲]**: Scroll through the  
phonebook if necessary.
- 4 **[↶]**
  - You can also make a call by  
pressing **[CALL]**, then pressing  
**[LINE 1]** or **[LINE 2]**.

---

### Searching by group

- 1 **[MENU]** → **[#][2][8][0]**
- 2 **[GROUP]**

- 3 **[▼]/[▲]**: Select the group you want  
to search. → **[SELECT]**
  - If you select "All groups", the  
unit ends the group search.
- 4 **[▼]/[▲]**: Select the desired entry.
- 5 **[↶]**
  - You can also make a call by  
pressing **[CALL]**, then pressing  
**[LINE 1]** or **[LINE 2]**.

---

## Editing entries

### Important:

- If there are entries with the same  
name and phone number, erase  
unnecessary entries before editing, in  
order to edit the information properly.
- 1 Find the desired entry (page 20).  
→ **[MENU]**
  - 2 **[▼]/[▲]**: "Edit" → **[SELECT]**
  - 3 Edit the name if necessary (16  
characters max.; page 19). →  
**[OK]**
  - 4 Edit the phone number if necessary  
(24 digits max.). → **[OK]**
  - 5 **[▼]/[▲]**: Select the desired group  
(page 19). → **[SELECT]**
  - 6 **[SELECT]** → **[OFF]**

---

## Erasing entries

### Erasing an entry

- 1 Find the desired entry (page 20).  
→ **[MENU]**
- 2 **[▼]/[▲]**: "Erase" → **[SELECT]**
- 3 **[▼]/[▲]**: "Yes" → **[SELECT]** →  
**[OFF]**

---

### Erasing all entries

- 1 **[MENU]** → **[#][2][8][0]**
- 2 **[MENU]**

- 3 [▼]/[▲]: "Erase all" → [SELECT]
- 4 [▼]/[▲]: "Yes" → [SELECT]
- 5 [▼]/[▲]: "Yes" → [SELECT]
- 6 [OFF]

## Chain dial

This feature allows you to dial phone numbers in the phonebook while you are on a call. This feature can be used, for example, to dial a calling card access number or bank account PIN that you have stored in the phonebook, without having to dial manually.

- 1 During an outside call, press [MENU].
- 2 [▼]/[▲]: "Phonebook" → [SELECT]
- 3 [▼]/[▲]: Select the desired entry.
- 4 Press [CALL] to dial the number.

### Note:

- When storing a calling card access number and your PIN in the phonebook as one phonebook entry, press [PAUSE] to add pauses after the number and PIN as necessary (page 15).
- If you have rotary/pulse service, you need to press [✳] (TONE) before pressing [MENU] in step 1 to change the dialing mode temporarily to tone. When adding entries to the phonebook, we recommend adding [✳] (TONE) to the beginning of phone numbers you wish to chain dial (page 19).

## Copying phonebook entries

You can copy phonebook entries between 2 handsets.\*1

\*1 Panasonic compatible handset

### Important:

- Groups (including their names and ringer tones) are not copied. Copied entries are automatically assigned to group 1.
- Entries copied from one handset to another are stored without overwriting any previously stored entries even in the case when name and phone number are same. Before editing such entries, erase unnecessary entries in order to edit the information properly.

## Copying an entry

- 1 [MENU] → [#][2][8][0]
- 2 [▼]/[▲]: Select the desired entry. → [MENU]
- 3 [▼]/[▲]: "Copy to handset" → [SELECT]
- 4 Enter the handset number you want to copy to.
  - When an entry has been copied, "Completed" is displayed.
  - To continue copying another entry:
    - [▼]/[▲]: "Yes" → [SELECT]
    - Find the desired entry (page 20). → [SEND]
- 5 [OFF]

## Copying all entries

- 1 [MENU] → [#][2][8][0] → [MENU]
- 2 [▼]/[▲]: "Copy all to HS" → [SELECT]

- 3 Enter the handset number you want to copy to.
  - When all entries have been copied, "Completed" is displayed.
- 4 [OFF]

## Programmable settings

You can customize the unit by programming the following features using the handset. To access the features, there are 2 methods:

- scrolling through the display menus (page 23)
- using the direct commands (page 25)
- Direct command is the main method used in these operating instructions.

### Programming by scrolling through the display menus



- 1 **[MENU]**
- 2 Press **[▼]**, **[▲]**, **[▶]**, or **[◀]** to select the desired main menu. → **[SELECT]**
- 3 Press **[▼]** or **[▲]** to select the desired item in sub-menu 1. → **[SELECT]**
  - In some cases, you may need to select from sub-menu 2. → **[SELECT]**
- 4 Press **[▼]** or **[▲]** to select the desired setting. → **[SAVE]**
  - This step may vary depending on the feature being programmed.
  - To exit the operation, press **[OFF]**.

#### Note:

- See page 25 for the default settings.

Main menu	Sub-menu 1	Sub-menu 2	Page
View Caller ID →)	–	–	30
Phonebook 📖	–	–	19
V.M. access 📧	–	–	34
Ringer settings 🎵	Ringer volume	Line1	–
		Line2	
	Ringer tone	Line1	–
		Line2	
	Interrupt tone	–	18, 35
Night mode	Start/End	28	
	On/Off	28	

## Programming

Main menu	Sub-menu 1	Sub-menu 2	Page	
Initial settings 	Set date & time	Date and time <sup>*1</sup>	14	
		Alarm	28	
		Time adjustment <sup>*1</sup>	–	
	Voice mail	Store V.M. no. <sup>*1</sup>	–	33
		– Line1	–	
		– Line2	–	
		VM tone detect <sup>*1</sup>	–	33
	Contrast	–	–	
	Key tone	–	–	
	Auto talk	–	16	
	Line select	–	14	
	Set tel line	Caller ID edit	–	31
		Set dial mode <sup>*1</sup>	–	13
		Set flash time <sup>*1</sup>	–	16
		– Line1	–	
		– Line2	–	
		Set line mode <sup>*1</sup>	–	–
	– Line1	–		
	– Line2	–		
Privacy <sup>*1</sup>	–	17		
Registration	HS registration	–	29	
	Deregistration	–	29	
Change language	Display language	–	13	
Customer support 	–	–	–	

\*1 If you program these settings using one of the handsets, you do not need to program the same item using another handset.



## Programming using the direct commands

- 1 **[MENU]** → **[#]**
- 2 Enter the desired code.
- 3 **[▼]/[▲]**: Select the desired setting. → **[SAVE]**
  - This step may vary depending on the feature being programmed.
  - To exit the operation, press **[OFF]**.

### Note:

- In the following table, < > indicates the default settings.

Feature	Code	Setting	System <sup>*1</sup>	Page	
View Caller ID	<b>[2][1][3]</b>	–	–	31	
Phonebook	<b>[2][8][0]</b>	–	–	19	
V.M. access (V.M.: Voice mail)	<b>[3][3][0]</b>	–	–	34	
Ringer volume <sup>*2</sup> (Handset)	<b>[1][6][0]</b>	Line 1 Line 2	Level 1–<6>, Off	–	
Ringer tone (Handset) <sup>*3, *4, *5</sup>	<b>[1][6][1]</b>	Line 1 Line 2	Line 1: <Tone 1> Line 2: <Tone 2> Tone 1–5 Melody 1–10	–	
Interrupt tone <sup>*6</sup>	<b>[2][0][1]</b>	<On> Off	–	18, 35	
Night mode (Start/End)	<b>[2][3][7]</b>	<11:00 PM/06:00 AM>	–	28	
Night mode (On/Off)	<b>[2][3][8]</b>	On <Off>	–	28	
Date and time	<b>[1][0][1]</b>	–	●	14	
Alarm	<b>[7][2][0]</b>	<Off> Once Daily	–	28	
Time adjustment <sup>*7</sup>	<b>[2][2][6]</b>	<Caller ID[auto]> Manual	●	–	
Store V.M. no.	<b>[3][3][1]</b>	Line 1 Line 2	–	●	33
VM tone detect (VM: Voice mail)	<b>[3][3][2]</b>	<On> Off	●	33	
Contrast (Display contrast)	<b>[1][4][5]</b>	Level 1–6 <3>	–	–	
Key tone <sup>*8</sup>	<b>[1][6][5]</b>	<On> Off	–	–	

## Programming

Feature	Code	Setting	System <sup>*1</sup>	Page
Auto talk <sup>*9</sup>	[2][0][0]	On <Off>	–	16
Line select	[2][5][0]	<Auto> Line1 Line2	–	14
Caller ID edit (Caller ID number auto edit)	[2][1][4]	<On> Off	–	31
Set dial mode	[1][2][0]	<Tone> Pulse	●	13
Set flash time <sup>*10</sup>	[1][2][1]	Line 1 80 ms Line 2 90 ms 100 ms 110 ms 160 ms 200 ms 250 ms 300 ms 400 ms 600 ms <700 ms> 900 ms	●	16
Set line mode <sup>*11</sup>	[1][2][2]	Line 1 A Line 2 <B>	●	–
Privacy	[1][9][4]	On <Off>	●	17
HS registration (HS: Handset)	[1][3][0]	–	–	29
Deregistration	[1][3][1]	–	–	29
Display language	[1][1][0]	<English> Español	–	13
Customer support <sup>*12</sup>	[6][8][0]	–	–	–

\*1 If “System” column is checked, you do not need to program the same item using another handset.

\*2 When the ringer volume is turned off,  $\times$  is displayed followed by the selected line number(s) and the handset does not ring for outside calls.

However even when the ringer volume for both lines is set to off, the handset still rings for alarm (page 28), intercom calls, and paging (page 35).

\*3 If you subscribe to a distinctive ring service (such as IDENT-A-RING), select a tone (tone 1 to 5). If you select a melody, you cannot distinguish lines by their ringers.

- \*4 If you select one of the melody ringer tones, the ringer tone continues to play for several seconds even if the caller has already hung up. You may either hear a dial tone or no one on the line when you answer the call.
- \*5 The preset melodies in this product are used with permission of © 2007 Copyrights Vision Inc.
- \*6 This tone lets you know when you receive an outside call while you are on the other line or an intercom call. If you select “On”, the tone sounds 2 times.
- \*7 This feature allows the unit to automatically adjust the date and time each time caller information including date and time is received.  
To turn this feature on, select “**Caller ID[auto]**”. To turn this feature off, select “**Manual**”. (Caller ID subscribers only)  
To use this feature, set the date and time first (page 14).
- \*8 Turn this feature off if you prefer not to hear key tones while you are dialing or pressing any keys, including confirmation tones and error tones.
- \*9 If you subscribe to a Caller ID service and want to view the caller's information after lifting up the handset to answer a call, turn off this feature.
- \*10 The flash time depends on your telephone exchange or host PBX. Contact your PBX supplier if necessary. The setting should stay at “**700 ms**” unless pressing **[FLASH]** fails to pick up the waiting call.
- \*11 Generally, the line mode setting should not be adjusted. If **L1** or **L2** does not display when another phone connected to the same line is in use, you need to change the line mode to “**A**”.
- \*12 The handset can display the Internet address where you can download the operating instructions or get further information for this product, using your computer.

## Special programming

### Night mode

Night mode allows you to select a period of time during which the handset will not ring for outside calls. This feature is useful for time periods when you do not want to be disturbed, for example, while sleeping. Night mode can be set for each handset.

#### Important:

- Set the date and time beforehand (page 14).
- If you have set the alarm, the alarm sounds even if the night mode is turned on.

### Changing the start and end time

- 1 **[MENU]** → **[#][2][3][7]**
- 2 Enter the desired hour and minute you wish to start this feature.
- 3 Press **[\*]** to select “AM” or “PM”. → **[OK]**
- 4 Enter the desired hour and minute you wish to end this feature.
- 5 Press **[\*]** to select “AM” or “PM”. → **[OK]**
- 6 **[OFF]**

#### Note:

- To correct a digit, press **[◀]** or **[▶]** to move the cursor to the digit, then make the correction.

### Turning night mode on/off

- 1 **[MENU]** → **[#][2][3][8]**
- 2 **[▼]/[▲]**: Select “on” or “off”. → **[SAVE]**
- 3 **[OFF]**
  - When the night mode is set,  is displayed.

## Alarm

An alarm sounds at the set time for 3 minutes once or daily. Alarm can be set for each handset.

#### Important:

- Set the date and time beforehand (page 14).
- 1 **[MENU]** → **[#][7][2][0]**
  - 2 **[▼]/[▲]**: Select the desired alarm option. → **[SELECT]**

#### “OFF”

Turns alarm off. Go to step 6.

#### “Once”

An alarm sounds once at the set time.

#### “Daily”

An alarm sounds daily at the set time. Go to step 4.

- 3 Enter the desired month and date.
- 4 Set the desired time. → **[OK]**
- 5 **[▼]/[▲]**: Select the desired alarm tone. → **[SELECT]**
  - We recommend selecting a different ringer tone from the one used for outside calls.
- 6 **[SELECT]** → **[OFF]**
  - When the alarm is set,  is displayed.

#### Note:

- To stop the alarm, press any dial key or place the handset on the base unit or charger.
- When the handset is in use, the alarm will not sound until the handset is in standby mode.
- The ringer volume for alarm follows the higher volume level of the 2 lines (page 25).

## Registering a unit

### Operating additional units

#### Additional handsets

Up to 6 handsets can be registered to the base unit.

#### Important:

- See page 4 for information on the available model.

### Registering a handset to the base unit

The supplied handset and base unit are pre-registered. If for some reason the handset is not registered to the base unit, re-register the handset.

#### 1 Handset:

**[MENU] → [#][1][3][0]**

#### 2 Base unit:

Press and hold **[LOCATOR]** for about 5 seconds until the indicators for VOICE MAIL turn on. (No registration tone)

- If all registered handsets start ringing, press the same button to stop. Then repeat this step.
- The next step must be completed within 90 seconds.

#### 3 Handset:

Press **[OK]**, then wait until a long beep sounds.

#### Note:

- When you purchase an additional handset, refer to the additional handset's installation manual for registration.

### Deregistering a handset

A handset can cancel its own registration (or the registration of

another handset) that is stored to the base unit. This allows the handset to end its wireless connection with the system.

**1 [MENU] → [#][1][3][1]**

**2 [3][3][5] → [OK]**

**3** Select the handset(s) you want to cancel by pressing the desired handset number.

- The selected handset number(s) flashes.
- To cancel a selected handset number, press the number again. The number stops flashing.

**4 [OK] → [▼]/[▲]: "Yes" → [SELECT]**

- When you cancel a different handset than the one you are now using, press **[OFF]** to exit.

# Using Caller ID service

### Important:

- This unit is Caller ID compatible. To use Caller ID features, you must subscribe to a Caller ID service. Contact your service provider/ telephone company for details.

## Caller ID features

When an outside call is being received, the caller's name and phone number are displayed.

Caller information for the last 50 callers is logged in the caller list from the most recent call to the oldest.

- If the unit cannot receive caller information, the following is displayed:
  - “**Out of area**”: The caller dials from an area which does not provide a Caller ID service.
  - “**Private caller**”: The caller requests not to send caller information.
  - “**Long distance**”: The caller makes a long distance call.
- If the unit is connected to a PBX system, caller information may not be properly received. Contact your PBX supplier.

## Missed calls

If a call is not answered, the unit treats it as a missed call. The display shows “**Missed call**”. This lets you know if you should view the caller list to see who called while you were away.

## Phonebook name display

When caller information is received and it matches a phone number stored in the phonebook, the stored name in the phonebook is displayed and logged in the caller list.

## Group ringer tone for phonebook

This feature can help you identify who is calling by using different ringer tones for different groups of callers. When adding an entry to the phonebook, you can assign it to the desired group (page 19). When a call is received from a caller assigned to a group, the ringer you selected for that group rings after caller information is displayed. If you select “**No ringer ID**” (default), the unit uses the ringer tone you selected on page 25 when calls from this group are received.

- 1 **[MENU]** → **[#][2][8][0]**
- 2 **[MENU]**
- 3 **[▼]/[▲]**: “Group” → **[SELECT]**
- 4 **[▼]/[▲]**: Select the desired group. → **[SELECT]**
- 5 **[▼]/[▲]**: Select the current setting of the group ringer tone. → **[SELECT]**
- 6 **[▼]/[▲]**: Select the desired ringer tone. → **[SAVE]**
- 7 **[OFF]**

## Caller list

### Important:

- Only 1 person can access the caller list at a time.
- Make sure the unit's date and time setting is correct (page 14).

## Viewing the caller list and calling back

- 1 **[MENU]** → **[▼]/[▲]**: "View Caller ID" → **[SELECT]**
- 2 Press **[▼]** to search from the most recent call, or **[▲]** to search from the oldest call.
- 3 To call back, press **[↶]**.  
To exit, press **[OFF]**.

### Note:

- In step 2;
  - **[1]** and **[2]** indicate which line the caller information was received from.
  - If the item has already been viewed or answered, "✓" is displayed, even if it was viewed or answered using another handset.
  - If **▶** is displayed after the number, not all of the phone number is shown. To see the remaining numbers, press **[▶]**. To return to the previous display, press **[◀]**.
- In step 3, the unit automatically uses the line you set in line selection mode (page 14) to call back. When the line selection mode is set to "Auto", the indicated line (**[1]** or **[2]**) is used for the call. If the indicated line is already being used or you want to select the other line, press **[CALL]**, then press **[LINE 1]** or **[LINE 2]**.

## Editing a caller's phone number before calling back

You can edit a phone number in the caller list by removing its area code and/or the long distance code "1".

- 1 **[MENU]** → **[▼]/[▲]**: "View Caller ID" → **[SELECT]**
- 2 **[▼]/[▲]**: Select the desired entry.  
→ **[CALL]**

- 3 Press **[EDIT]** repeatedly until the phone number is shown in the desired format.
  - ① Local phone number  
**Example:** 321-5555
  - ② Area code – Local phone number  
**Example:** 555-321-5555
  - ③ 1 – Area code – Local phone number  
**Example:** 1-555-321-5555

## 4 **[↶]**

- If the indicated line is already being used or you want to select the other line, press **[LINE 1]** or **[LINE 2]**.

## Caller ID number auto edit feature

Once you call back an edited number, the handset which was used to call back remembers the area code and format of the edited number. The next time someone calls from the same area code, caller information is customized by the handset as follows:

- When the call is being received, the Caller ID number is displayed in the same format as the edited number.
- After the call has ended, the caller's phone number is displayed in the same format as the edited number, when reviewed from the caller list.

For example, you can use this feature to set the handset to ignore the area code of callers in your area, so that you can call these local numbers using caller information without dialing the area code.

To activate this feature, you must edit an entry in the caller list, then call that number. After that, phone numbers from that caller's area code are edited automatically.

## Caller ID Service

---

This feature can be set for each handset (page 26). The default setting is “On”.

### Note:

- Phone numbers from the 4 most recently edited area codes are automatically edited.
- If you move to another area, you can turn this feature off to erase previously edited area codes. To use this feature again, turn it on and reprogram the area codes you want to edit once again.

---

### Erasing selected caller information

- 1 **[MENU]** → **[▼]/[▲]**: “View Caller ID” → **[SELECT]**
- 2 **[▼]/[▲]**: Select the desired entry.
- 3 **[ERASE]** → **[▼]/[▲]**: “Yes” → **[SELECT]** → **[OFF]**

---

### Erasing all caller information

- 1 **[MENU]** → **[▼]/[▲]**: “View Caller ID” → **[SELECT]**
- 2 **[ERASE]** → **[▼]/[▲]**: “Yes” → **[SELECT]** → **[OFF]**

---

### Storing caller information to the phonebook

- 1 **[MENU]** → **[▼]/[▲]**: “View Caller ID” → **[SELECT]**
- 2 **[▼]/[▲]**: Select the desired entry.
  - To edit the number, press **[SAVE]**. → Press **[EDIT]** repeatedly until the phone number is shown in the desired format. → **[SAVE]** → Go to step 4.
- 3 Press **[SAVE]** 2 times.
- 4 Continue from step 3, “Editing entries”, page 20.



## Voice mail service

Voice mail is an automatic answering service offered by your service provider/telephone company. After you subscribe to this service, your service provider/telephone company's voice mail system answers calls for you when you are unavailable to answer the phone or when your line is busy. Messages are recorded by your service provider/telephone company, not your telephone. Please contact your service provider/telephone company for details of this service.

### Storing the voice mail (VM) access number

In order to listen to your voice mail messages, you must dial your service provider/telephone company's voice mail access number. Once you have stored your voice mail access number, you can dial it automatically (page 34).

- 1 **[MENU]** → **[#][3][3][1]**
- 2 **[▼]/[▲]**: Select the desired line. → **[SELECT]**
- 3 Enter your access number (24 digits max.). → **[SAVE]** → **[OFF]**

#### Note:

- When storing your voice mail access number and your mailbox password, press **[PAUSE]** to add pauses (page 15) between the access number and the password as necessary. Contact your service provider/telephone company for the required pause time.

#### Example:

1-222-333-4444	PPPP	8888
VM access number	Pauses	Password

### To erase the voice mail access number

- 1 **[MENU]** → **[#][3][3][1]**
- 2 **[▼]/[▲]**: Select the desired line. → **[SELECT]**
- 3 Press and hold **[CLEAR]** until all digits are erased. → **[SAVE]** → **[OFF]**

### Voice mail (VM) tone detection

Your service provider/telephone company sends special signals (sometimes called "voice mail tones" or "stutter tones") to the unit to let you know you have new voice mail messages. If you hear a series of dial tones followed by a continuous dial tone after you press **[↶]**, you have new voice mail messages. Soon after you hang up a call or after the phone stops ringing, your unit checks the phone line to see if new voice mail messages have been recorded.

Turn this feature off when:

- You do not subscribe to voice mail service.
- Your service provider/telephone company does not send voice mail tones.
- Your phone is connected to a PBX.

If you are not sure which setting is required, contact your service provider/telephone company.

### Turning VM tone detection on/off

The default setting is "On".

- 1 **[MENU]** → **[#][3][3][2]**
- 2 **[▼]/[▲]**: Select the desired setting. → **[SAVE]** → **[OFF]**

### Listening to voice mail messages

The unit lets you know that you have new voice mail messages in the following ways:

- “VoiceMail:Line1” and/or “VoiceMail:Line2” is displayed on the handset if message indication service is available.
- The indicator for VOICE MAIL on the base unit flashes.

- 1** **[MENU]** → **[#][3][3][0]**
- 2** Press **[LINE 1]** or **[LINE 2]** that is flashing.
  - The speakerphone turns on.
- 3** Follow the pre-recorded instructions.
- 4** When finished, press **[OFF]**.

#### Note:

- To switch to the receiver, press **[↶]**.
- If the handset or base unit still indicates there are new messages even after you have listened to all new messages, turn it off by pressing and holding **[OFF]** until the handset beeps.
- If your voice mail service uses voice mail tones and a message is over 3 minutes long, the handset may not indicate new messages.
- If your voice mail service uses voice mail tones, the tones are heard from any phone connected to the same line. If you want to use another phone to listen to voice mail messages, you have to dial your access number manually.

## Intercom

Intercom calls can be made between handsets.

### Note:

- If you receive an outside call while talking on the intercom, you hear an interrupt tone (page 25). To answer the call, press **[OFF]**, then press **[↶]**. You can also answer the call by pressing **[LINE 1]** or **[LINE 2]** after hanging up the intercom.
- When paging the handset, the paged handset beeps for 1 minute.

## Making an intercom call

- 1 **[INTERCOM]**
- 2 To page another handset, enter its extension number.
  - To stop paging, press **[OFF]**.
- 3 When you finish talking, press **[OFF]**.

## Answering an intercom call

- 1 Press **[↶]** to answer the page.
- 2 When you finish talking, press **[OFF]**.

### Note:

- The ringer volume for intercom calls follows the higher volume level of the 2 lines (page 25).

## Handset locator

You can locate a misplaced handset by pressing **[LOCATOR]** on the base unit.

- All registered handsets beep for 1 minute.

To stop paging, press it again or **[OFF]** on the handset.

## Transferring calls

Outside calls can be transferred between 2 handsets.

- 1 During an outside call, press **[INTERCOM]** to put the call on hold.
- 2 To page another handset, enter its extension number.
- 3 Wait for the paged party to answer.
  - If the paged party does not answer, press **[LINE 1]** or **[LINE 2]** that is flashing to return to the outside call.
- 4 **[OFF]**
  - The outside call is being routed to the destination unit.

## Answering a transferred call

Press **[↶]** to answer the page.

## Conference calls

3 people can establish a conference call.

## Conference call with 2 outside calls

While you are talking with an outside caller, you can make or answer a 2nd call on the other line, and then combine the calls to establish a conference call.

- 1 During an outside call, press **[HOLD]** 2 times.
- 2 To answer a 2nd call, press **[LINE 1]** or **[LINE 2]**.  
To make a 2nd call, press **[LINE 1]** or **[LINE 2]**, then dial the phone number.

- 3** When the 2nd call is connected, press **[MENU]**. →  
**[▼]/[▲]**: "Conference" →  
**[SELECT]**
- The 2 calls are combined.
  - To hang up only one line, press **[LINE 1]** or **[LINE 2]** for the party with which you want to continue talking.
  - To put both lines on hold, press **[HOLD]**.
    - To talk with only one caller, press **[LINE 1]** or **[LINE 2]** for the party with which you want to continue talking.
    - To resume both lines, press **[CONF]**.

---

### Conference call with an outside call and an intercom call

While you are talking with an outside caller, one more extension can join the conversation and establish a conference call.

- 1** During an outside call, press **[INTERCOM]** to put the call on hold.
- 2** To page another handset, enter its extension number.
- 3** When the paged party answers, press **[CONF]**.
- The 2 calls are combined.
  - To leave the conference, press **[OFF]**. The other 2 parties can continue the conversation.

#### Note:

- The outside call can be put on hold by pressing **[HOLD]**. Only the person who placed the call on hold can resume the full conference by pressing **[CONF]**.

## Wall mounting

### Note:

- Make sure that the wall is strong enough to support the weight of the unit.

### Base unit

- 1 Lead the AC adaptor cord and telephone line cord through the hole in the wall mounting adaptor in the direction of the arrow.

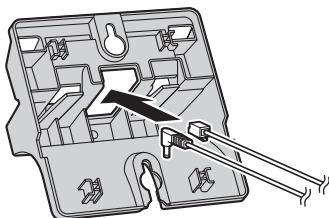

- 2 Tuck the telephone line cord inside the wall mounting adaptor (1). Connect the AC adaptor cord and telephone line cord (2).

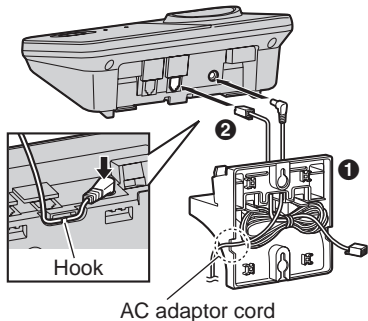

- 3 Insert the hooks on the wall mounting adaptor into holes A and B on the base unit.

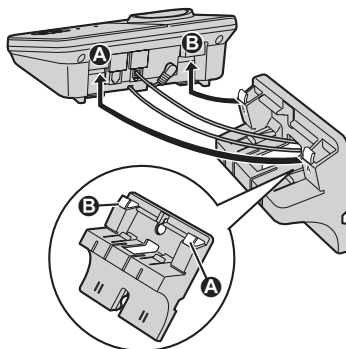

- 4 Adjust the adaptor to hold the base unit, then push it in the direction of the arrow until it clicks into place.

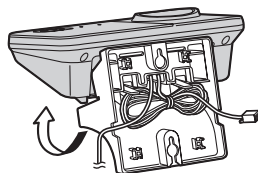
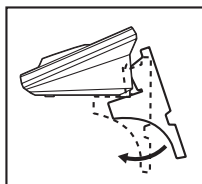

## Useful Information

- 5 Mount the unit on a wall then slide down to secure in place.

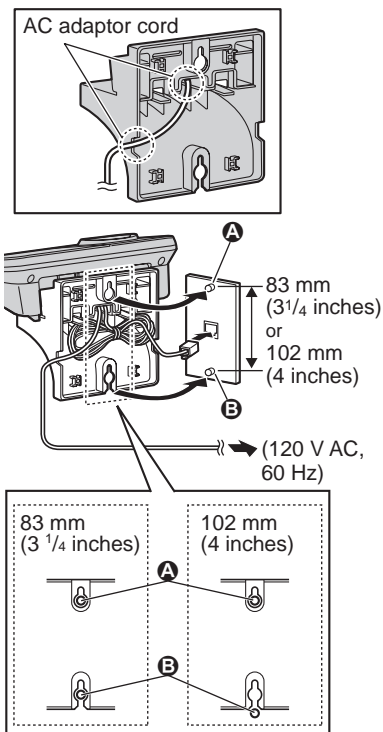

### To remove the wall mounting adaptor

While pushing down the release levers (1), remove the adaptor (2).

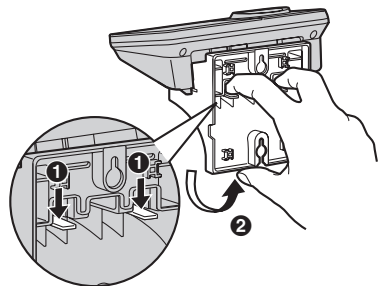

## Charger

- 1 Drive the screws (not supplied) into the wall.

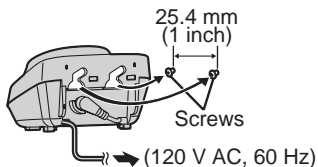

- 2 Mount the charger (1), then slide it down (2) and to the right (3) until it is secure.

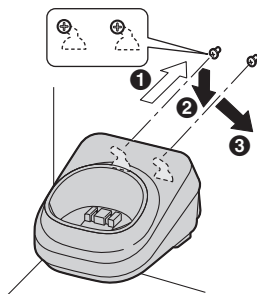

## Belt clip

■ To attach

■ To remove

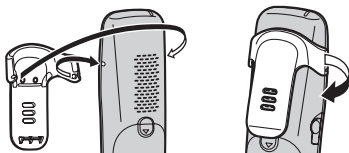

## Error messages

If the unit detects a problem, one of the following messages is shown on the display.

Display message	Cause/solution
<b>Busy</b>	<ul style="list-style-type: none"> <li>• The called unit is in use.</li> <li>• Other units are in use and the system is busy. Try again later.</li> <li>• Privacy mode is on for the call you tried to join (page 26).</li> <li>• The handset you are using is too far from the base unit. Move closer and try again.</li> <li>• The handset's registration may have been canceled. Re-register the handset (page 29).</li> </ul>
<b>Call phone company for your access #</b>	<ul style="list-style-type: none"> <li>• You have not stored the voice mail access number. Store the number (page 33).</li> </ul>
<b>Check tel line 1</b> <b>Check tel line 2</b>	<ul style="list-style-type: none"> <li>• The supplied telephone line cord has not been connected yet or not connected properly. Check the connections (page 8).</li> <li>• If you use the unit as a single-line telephone only, erase the message as follows: To erase "<b>Check tel line 1</b>", press <b>[MENU]</b>. → <b>[#][1][8][9]</b> To erase "<b>Check tel line 2</b>", press <b>[MENU]</b>. → <b>[#][1][9][0]</b> When a power failure occurs, the message is displayed again. Erase again as above.</li> </ul>
<b>Failed</b>	<ul style="list-style-type: none"> <li>• Phonebook copy failed (page 21). Confirm the other unit (the receiver) is in standby mode and try again.</li> </ul>
<b>Incomplete</b>	<ul style="list-style-type: none"> <li>• Phonebook copy is incomplete. The receiver's phonebook memory is full. Erase the unnecessary phonebook entries (page 20) from the other unit (the receiver) and try again.</li> </ul>
<b>Memory full</b>	<ul style="list-style-type: none"> <li>• The phonebook memory is full. Erase unnecessary entries (page 20).</li> </ul>

## Useful Information

Display message	Cause/solution
No link to base. Reconnect AC adaptor.	<ul style="list-style-type: none"><li>● The handset has lost communication with the base unit. Move closer to the base unit and try again.</li><li>● Unplug the base unit's AC adaptor to reset the unit. Reconnect the adaptor and try again.</li><li>● The handset's registration may have been canceled. Re-register the handset (page 29).</li></ul>
Use rechargeable battery.	<ul style="list-style-type: none"><li>● A wrong type of battery such as Alkaline or Manganese was inserted. Use only the rechargeable Ni-MH batteries noted on page 4, 6.</li></ul>
You must first subscribe to Caller ID.	<ul style="list-style-type: none"><li>● You must subscribe to a Caller ID service. Once you receive caller information after subscribing to a Caller ID service, this message will not be displayed.</li></ul>



## Troubleshooting

If you still have difficulties after following the instructions in this section, disconnect the base unit's AC adaptor, then reconnect the base unit's AC adaptor. Remove the batteries from the handset, and then insert the batteries into the handset again.

### General use

Problem	Cause/solution
The handset does not turn on even after installing charged batteries.	<ul style="list-style-type: none"> <li>Place the handset on the base unit or charger to turn on the handset.</li> </ul>
The unit does not work.	<ul style="list-style-type: none"> <li>Make sure the batteries are installed correctly (page 10).</li> <li>Fully charge the batteries (page 10).</li> <li>Check the connections (page 8).</li> <li>Unplug the base unit's AC adaptor to reset the unit. Reconnect the adaptor and try again.</li> <li>The handset has not been registered to the base unit. Register the handset (page 29).</li> </ul>
I cannot hear a dial tone.	<ul style="list-style-type: none"> <li>The base unit's AC adaptor or telephone line cord is not connected. Check the connections.</li> <li>If you are using a splitter to connect the unit, remove the splitter and connect the unit to the wall jack directly. If the unit operates properly, check the splitter.</li> <li>Disconnect the base unit from the telephone line and connect the line to a known working telephone. If the working telephone operates properly, contact our service personnel to have the unit repaired. If the working telephone does not operate properly, contact your service provider/ telephone company.</li> </ul>
The indicator on the base unit flashes.	<ul style="list-style-type: none"> <li>New voice mail messages have been recorded. Listen to the new voice mail messages (page 34).</li> </ul>



### Programmable settings

Problem	Cause/solution
The display is in a language I cannot read.	<ul style="list-style-type: none"> <li>Change the display language (page 13).</li> </ul>

## Useful Information

Problem	Cause/solution
I cannot register a handset to a base unit.	<ul style="list-style-type: none"><li>● The maximum number of handsets (6) is already registered to the base unit. Cancel unused handset registrations from the base unit (page 29).</li></ul>

### Battery recharge

Problem	Cause/solution
The handset beeps and/or  flashes.	<ul style="list-style-type: none"><li>● Battery charge is low. Fully charge the batteries (page 10).</li></ul>
I fully charged the batteries, but <ul style="list-style-type: none"><li>–  still flashes or</li><li>– the operating time seems to be shorter.</li></ul>	<ul style="list-style-type: none"><li>● Clean the battery ends (+, -) and the charge contacts with a dry cloth and charge again.</li><li>● It is time to replace the batteries (page 10).</li></ul>

### Making/answering calls, intercom

Problem	Cause/solution
 is flashing.	<ul style="list-style-type: none"><li>● The handset is too far from the base unit. Move closer.</li><li>● The base unit's AC adaptor is not properly connected. Reconnect AC adaptor to the base unit.</li><li>● The handset is not registered to the base unit. Register it (page 29).</li></ul>
Noise is heard, sound cuts in and out.	<ul style="list-style-type: none"><li>● You are using the handset or base unit in an area with high electrical interference. Re-position the base unit and use the handset away from sources of interference.</li><li>● Move closer to the base unit.</li><li>● If you use a DSL/ADSL service, we recommend connecting a DSL/ADSL filter between the base unit and the telephone line jack. Contact your DSL/ADSL provider for details.</li></ul>
The handset does not ring.	<ul style="list-style-type: none"><li>● The ringer volume is turned off. Adjust the ringer volume (page 25).</li><li>● Night mode is turned on. Turn it off (page 28).</li></ul>
I cannot make a call.	<ul style="list-style-type: none"><li>● The dialing mode may be set incorrectly. Change the setting (page 13).</li><li>● The handset is too far from the base unit. Move closer and try again.</li></ul>
I cannot make long distance calls.	<ul style="list-style-type: none"><li>● Make sure that you have long distance service.</li></ul>

## Caller ID

Problem	Cause/solution
Caller information is not displayed.	<ul style="list-style-type: none"> <li>● You must subscribe to Caller ID service. Contact your service provider/telephone company for details.</li> <li>● If your unit is connected to any additional telephone equipment such as a Caller ID box or cordless telephone line jack, plug the unit directly into the wall jack.</li> <li>● If you use a DSL/ADSL service, we recommend connecting a DSL/ADSL filter between the base unit and the telephone line jack. Contact your DSL/ADSL provider for details.</li> <li>● The name display service may not be available in some areas. Contact your service provider/telephone company for details.</li> <li>● Other telephone equipment may be interfering with this unit. Disconnect the other equipment and try again.</li> </ul>
Caller information is displayed late.	<ul style="list-style-type: none"> <li>● Depending on your service provider/telephone company, the unit may display the caller's information at the 2nd ring or later.</li> <li>● Move closer to the base unit.</li> </ul>
The caller list/incoming phone numbers are not edited automatically.	<ul style="list-style-type: none"> <li>● The Caller ID number auto edit feature is turned off. Turn it on and try again (page 26).</li> <li>● You need to call back the edited number to activate Caller ID number auto edit.</li> </ul>
I cannot dial the phone number edited in the caller list.	<ul style="list-style-type: none"> <li>● The phone number you dialed might have been edited incorrectly (for example, the long distance "1" or the area code is missing). Edit the phone number with another pattern (page 31).</li> </ul>
Time on the unit has shifted.	<ul style="list-style-type: none"> <li>● Incorrect time information from incoming Caller ID changes the time. Set the time adjustment to "Manual" (off) (page 25).</li> </ul>
The 2nd caller's information is not displayed during an outside call.	<ul style="list-style-type: none"> <li>● In order to use Caller ID, call waiting, or Call Waiting Caller ID (CWID), you must first contact your service provider/telephone company and subscribe to the desired service. After subscribing, you may need to contact your service provider/telephone company again to activate this specific service, even if you already subscribed to both Caller ID and Call Waiting with Caller ID services (CWID).</li> </ul>

### Liquid damage

Problem	Cause/solution
Liquid or other form of moisture has entered the handset/base unit.	<ul style="list-style-type: none"><li>● Disconnect the AC adaptor and telephone line cord from the base unit. Remove the batteries from the handset and leave to dry for at least 3 days. After the handset/base unit are completely dry, reconnect the AC adaptor and telephone line cord. Insert the batteries and charge fully before use. If the unit does not work properly, contact an authorized service center.</li></ul>

#### Caution:

- To avoid permanent damage, do not use a microwave oven to speed up the drying process.

## FCC and other information

This equipment complies with Part 68 of the FCC rules and the requirements adopted by the ACTA. On the bottom of this equipment is a label that contains, among other information, a product identifier in the format US:ACJ-----.

If requested, this number must be provided to the telephone company.

- Registration No.....(found on the bottom of the unit)
- Ringer Equivalence No. (REN).....0.1B

A plug and jack used to connect this equipment to the premises wiring and telephone network must comply with the applicable FCC Part 68 rules and requirements adopted by the ACTA. A compliant telephone cord and modular plug is provided with the product. It is designed to be connected to a compatible modular jack that is also compliant.

The REN is used to determine the number of devices that may be connected to a telephone line. Excessive RENs on a telephone line may result in the devices not ringing in response to an incoming call. In most but not all areas, the sum of RENs should not exceed five (5.0). To be certain of the number of devices that may be connected to a line, as determined by the total RENs, contact the local telephone company. For products approved after July 23, 2001, the REN for the product is part of the product identifier that has the format US:AAEQ##TXXXX. The digits represented by ## are the REN without a decimal point (e.g., 03 is a REN of 0.3).

If this equipment causes harm to the telephone network, the telephone company will notify you in advance that temporary discontinuance of service may be required. But if advance notice isn't practical, the telephone company will notify the customer as soon as possible. Also, you will be advised of your right to file a complaint with the FCC if you believe it is necessary.

The telephone company may make changes in its facilities, equipment, operations or procedures that could affect the operation of the equipment. If this happens the telephone company will provide advance notice in order for you to make necessary modifications to maintain uninterrupted service.

If trouble is experienced with this equipment, for repair or warranty information, please contact a Factory Service Center or other Authorized Servicer. If the equipment is causing harm to the telephone network, the telephone company may request that you disconnect the equipment until the problem is resolved.

Connection to party line service is subject to state tariffs. Contact the state public utility commission, public service commission or corporation commission for information.

If your home has specially wired alarm equipment connected to the telephone line, ensure the installation of this equipment does not disable your alarm equipment. If you have questions about what will disable alarm equipment, consult your telephone company or a qualified installer.

This equipment is hearing aid compatible as defined by the FCC in 47 CFR Section 68.316.

When you hold the phone to your ear, noise might be heard in your Hearing Aid. Some Hearing Aids are not adequately shielded from external RF (radio frequency) energy. If noise occurs, use an optional headset accessory or the speakerphone option (if applicable) when using this phone. Consult with your audiologist or Hearing Aid manufacturer about the availability of Hearing Aids which provide adequate shielding to RF energy commonly emitted by digital devices.

### WHEN PROGRAMMING EMERGENCY NUMBERS AND/OR MAKING TEST CALLS TO EMERGENCY NUMBERS:

- 1) Remain on the line and briefly explain to the dispatcher the reason for the call.
- 2) Perform such activities in the off-peak hours, such as early morning or late evenings.

This device complies with Part 15 of the FCC Rules. Operation is subject to the following two conditions:

(1) This device may not cause harmful interference, and (2) this device must accept any interference received, including interference that may cause undesired operation.

Privacy of communications may not be ensured when using this phone.

### CAUTION:

Any changes or modifications not expressly approved by the party responsible for compliance could void the user's authority to operate this device.

### NOTE:

This equipment has been tested and found to comply with the limits for a Class B digital device, pursuant to Part 15 of the FCC Rules. These limits are designed to provide reasonable protection against harmful interference in a residential installation. This equipment generates, uses, and can radiate radio frequency energy and, if not installed and used in accordance with the instructions, may cause harmful interference to radio communications.

However, there is no guarantee that interference will not occur in a particular installation. If this equipment does cause harmful interference to radio or television reception, which can be determined by turning the equipment off and on, the user is encouraged to try to correct the interference by one or more of the following measures:

- Reorient or relocate the receiving antenna.
- Increase the separation between the equipment and receiver.
- Connect the equipment into an outlet on a circuit different from that to which the receiver is connected.

- Consult the dealer or an experienced radio/TV technician for help.

Some cordless telephones operate at frequencies that may cause interference to nearby TVs and VCRs. To minimize or prevent such interference, the base of the cordless telephone should not be placed near or on top of a TV or VCR. If interference is experienced, move the cordless telephone further away from the TV or VCR. This will often reduce or eliminate interference.

### FCC RF Exposure Warning:

- This product complies with FCC radiation exposure limits set forth for an uncontrolled environment.
- To comply with FCC RF exposure requirements, the base unit must be installed and operated 20 cm (8 inches) or more between the product and all person's body (excluding extremities of hands, wrist and feet).
- This product may not be collocated or operated in conjunction with any other antenna or transmitter.
- The handset may be carried and operated with only the specific provided belt-clip. Other non-tested belt-clips or similar body-worn accessories may not comply and must be avoided.

### Notice

- FCC ID can be found inside the battery compartment or on the bottom of the units.

### Compliance with TIA-1083 standard:

Telephone handsets identified with this logo have reduced noise and interference when used with T-Coil equipped hearing aids and cochlear implants.



# Guía Rápida Española

## Instalación

### Cómo conectar el adaptador para corriente

- Use solo el adaptador de corriente Panasonic PQLV219 incluido.

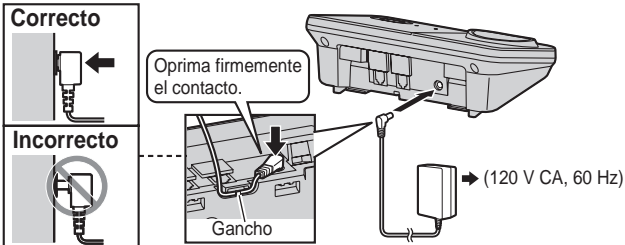

### Cómo conectar el cable de la línea telefónica

- Para conectarlo a una toma telefónica para 2 líneas

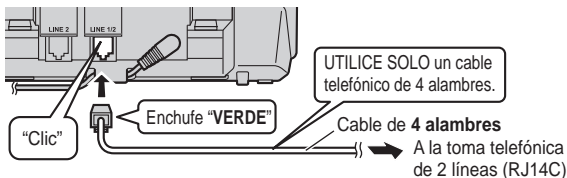

- Para conectarlo a 2 tomas telefónicas de una sola línea

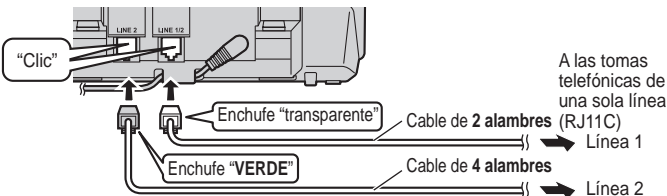

Si está suscrito a un servicio de DSL/ADSL, añada un filtro de DSL/ADSL a la línea telefónica entre la unidad base y la toma de la línea telefónica. Consulte las instrucciones de operación para ver las conexiones.

## Instalación

### Auricular

- UTILICE SOLO baterías de Ni-MH tamaño AAA (R03).
- NO utilice baterías Alcalinas, de Manganeseo o de Ni-Cd.
- Compruebe que las polaridades son las correctas (+, -).

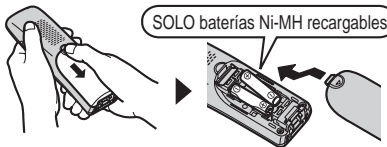

### Cargador

- Use solo el adaptador de corriente Panasonic PQLV219 incluido.

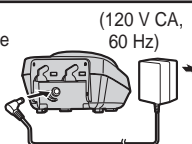

### CARGUE APROXIMADAMENTE DURANTE 7 HORAS

Confirme que aparezca "Cargando".

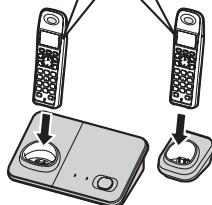

### Cómo usar la unidad sólo como teléfono de una sola línea

Conecte el cable de la línea telefónica a LINE (LÍNEA) 1/2.

- Para usar sólo la línea 1: **[MENU]** → **[#][2][5][0]** → **[▼]/[▲]**: "Linea1" → **[GUARD.]** → **[OFF]**

- Para borrar el mensaje "Rev. Línea tel 2": **[MENU]** → **[#][1][9][0]**



Use el cable de la línea telefónica con el enchufe "Transparent" (cable de 2 alambres).

## Sugerencias de operación

### Teclas de función

El auricular incluye 3 teclas de función. Al oprimir una tecla de función, puede seleccionar la función que aparece directamente encima de ella en la pantalla.

**[LINEA1]**, **[MENU]**, **[LINEA2]** y otras funciones adicionales se asignan a las teclas de función. Preste atención a la pantalla para ver qué funciones están asignadas a las teclas de función durante la operación del auricular.

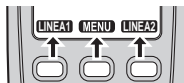



## Sugerencias de operación

### Tecla navegadora

- [▲], [▼], [◀], o [▶]: Navegue por diversas listas y elementos.
- ◀ (Volumen: [▲] o [▼]): Ajuste el volumen del receptor o el altavoz mientras habla.

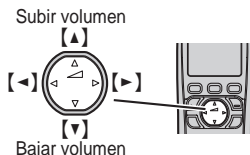

## Idioma de la pantalla (Auricular) (predeterminado: inglés)

[MENU] → [#][1][1][0] → [▼]/[▲]: "Español" → [GUARD.] → [OFF]

## Fecha y hora (Auricular)

- 1 [MENU] → [#][1][0][1]
- 2 Introduzca el día, mes y año actuales.
- 3 Introduzca la hora y minuto actuales (formato de reloj de 24 horas).
- 4 [GUARD.] → [OFF]

## Operaciones básicas

### Cómo hacer y contestar llamadas (Auricular)

Para hacer llamadas	Marque el número telefónico. → [📞]/[📞]
Para contestar llamadas	[📞]/[📞]
Para colgar	[OFF]
Para ajustar el volumen del receptor o del altavoz	Oprima [▲] o [▼] repetidamente mientras habla.
Cómo hacer una llamada usando la lista de remarcación	[REDIAL] → [▼]/[▲]: Seleccione el número telefónico deseado. → [📞]
Para ajustar el volumen del timbre del auricular	<ol style="list-style-type: none"> <li>1 [MENU] → [#][1][6][0]</li> <li>2 [▼]/[▲]: Seleccione la línea deseada. → [SELEC.]</li> <li>3 [▼]/[▲]: Seleccione el volumen deseado. → [GUARD.] → [OFF]</li> </ol>

### Directorio telefónico del auricular

Para añadir entradas	<ol style="list-style-type: none"> <li>1 [MENU] → [#][2][8][0] → [AÑADIR]</li> <li>2 Introduzca el nombre de la persona (máx. 16 caracteres). → [OK]</li> <li>3 Introduzca el número telefónico de la persona (máx. 24 dígitos). → [OK]</li> <li>4 [▼]/[▲]: Seleccione el grupo deseado. → [SELEC.] 2 veces → [OFF]</li> </ol>
Para hacer llamadas	<ol style="list-style-type: none"> <li>1 [MENU] → [#][2][8][0]</li> <li>2 [▼]/[▲]: Seleccione la entrada deseada. → [📞]</li> </ol>

**Preguntas frecuentes**

Pregunta	Causa y solución
¿Por qué está parpadeando $\Psi$ ?	<ul style="list-style-type: none"> <li>● El auricular está demasiado lejos de la unidad base. Acérquelo.</li> <li>● El adaptador para corriente de la unidad base no está conectado correctamente. Conecte de nuevo el adaptador para corriente a la unidad base.</li> <li>● El auricular no está registrado en la unidad base. Regístrelo.</li> </ul> <p><b>1 Auricular:</b> [MENU] → [#][1][3][0]</p> <p><b>2 Unidad base:</b> Oprima y mantenga oprimido [LOCATOR] durante aproximadamente 5 segundos. (No hay tono de registro)</p> <p><b>3 Auricular:</b> Oprima [OK], y después espere hasta que suene un pitido largo.</p>
¿Cómo se incrementa el nivel de volumen del auricular?	<ul style="list-style-type: none"> <li>● Oprima la tecla de navegación [▲] repetidamente mientras habla.</li> </ul>
¿Por qué hay ruido o se corta la conversación?	<ul style="list-style-type: none"> <li>● Trate de reubicar la unidad base de forma que se minimice la distancia al auricular.</li> <li>● Si ocurre el mismo problema aunque el auricular se encuentre enseguida de la unidad base, llame a soporte al cliente de Panasonic al 1-800-211-PANA (1-800-211-7262).</li> </ul>
¿Es posible añadir otro auricular accesorio a mi unidad base?	<ul style="list-style-type: none"> <li>● Sí, puede añadir hasta 6 auriculares (incluyendo los que se venden con su unidad base) a una sola unidad base.</li> <li>● Para adquirir auriculares accesorios adicionales (KX-TGA939), visite <a href="http://www.panasonic.com">http://www.panasonic.com</a> o llame al 1-800-332-5368. Los usuarios TTY (usuarios con impedimentos auditivos o del habla) pueden llamar al 1-866-605-1277.</li> </ul>
¿Es posible mantener cargando las baterías todo el tiempo?	<ul style="list-style-type: none"> <li>● Puede dejar el auricular en la unidad base o el cargador en cualquier momento. Esto no daña las baterías.</li> </ul>
¿Cómo se contestan las llamadas en espera (segunda llamada)?	<ul style="list-style-type: none"> <li>● Oprima [CALL WAIT] cuando escuche el tono de llamada en espera.</li> </ul>

Para obtener más información acerca del registro, visite <http://www.panasonic.com/RegisterYourHandset> (solo en inglés)

---

---

## Customer services

### ***Customer Services Directory (United States and Puerto Rico)***

Obtain Product Information and Operating Assistance; locate your nearest Dealer or Service Center; purchase Parts and Accessories; or make Customer Service and Literature requests by visiting our Web Site at:

**<http://www.panasonic.com/help>**

or, contact us via the web at:

**<http://www.panasonic.com/contactinfo>**

You may also contact us directly at: 1-800-211-PANA (1-800-211-7262),  
Monday - Friday 9 am to 9 pm; Saturday - Sunday 10 am to 7 pm, EST.

TTY users (hearing or speech impaired users) can call 1-877-833-8855.

### ***Accessory Purchases (United States and Puerto Rico)***

Purchase Parts, Accessories and Instruction Books online for all Panasonic Products by visiting our Web Site at:

**<http://www.pstc.panasonic.com>**

or, send your request by E-mail to:

**[npcparts@us.panasonic.com](mailto:npcparts@us.panasonic.com)**

You may also contact us directly at:

1-800-332-5368 (Phone) 1-800-237-9080 (Fax Only)

(Monday - Friday 9 am to 9 pm, EST.)

Panasonic Service and Technology Company

20421 84th Avenue South, Kent, WA 98032

(We Accept Visa, MasterCard, Discover Card, American Express, and Personal Checks.)

TTY users (hearing or speech impaired users) can call 1-866-605-1277.

## Warranty (For United States and Puerto Rico)

PANASONIC CORPORATION OF NORTH AMERICA  
One Panasonic Way, Secaucus, New Jersey 07094

### Panasonic Telephone Products Limited Warranty

#### Limited Warranty Coverage

If your product does not work properly because of a defect in materials or workmanship, Panasonic Corporation of North America (referred to as "the warrantor") will, for the length of the period indicated on the chart below, which starts with the date of original purchase ("Limited Warranty period"), at its option either (a) repair your product with new or refurbished parts, or (b) replace it with a new or a refurbished product. The decision to repair or replace will be made by the warrantor.

**Parts**  
**One (1) Year**

**Labor**  
**One (1) Year**

During the "Labor" Limited Warranty period there will be no charge for labor. During the "Parts" Limited Warranty period, there will be no charge for parts. You must mail-in your product prepaid during the Limited Warranty period. This Limited Warranty excludes both parts and labor for batteries, antennas, and cosmetic parts (cabinet). This Limited Warranty only applies to products purchased and serviced in the United States or Puerto Rico. This Limited Warranty is extended only to the original purchaser and only covers products purchased as new.

#### Ship-In Service

For assistance in the continental United States and Puerto Rico in obtaining repairs please ship the product prepaid to:

**PSTC (Panasonic) Exchange Center,**  
**4900 George McVay Drive, Suite B Door #12, McAllen, TX 78503**  
[panacare@us.panasonic.com](mailto:panacare@us.panasonic.com)

When shipping the unit carefully pack in a padded shipping carton, include all accessories, and send it prepaid. Include a letter detailing the complaint, a return address and provide a day time phone number where you can be reached. P.O. Boxes are not acceptable. Keep the tracking number for your records. A copy of valid registered receipt is required under the 1 year parts and labor Limited Warranty.

For Limited Warranty service for headsets if a headset is included with this product please follow instructions above.

**IF REPAIR IS NEEDED DURING THE LIMITED WARRANTY PERIOD THE PURCHASER WILL BE REQUIRED TO FURNISH A SALES RECEIPT/PROOF OF PURCHASE INDICATING DATE OF PURCHASE, AMOUNT PAID AND PLACE OF PURCHASE. CUSTOMER WILL BE CHARGED FOR THE REPAIR OF ANY UNIT RECEIVED WITHOUT SUCH PROOF OF PURCHASE.**

## Limited Warranty Limits And Exclusions

This Limited Warranty ONLY COVERS failures due to defects in materials or workmanship, and DOES NOT COVER normal wear and tear or cosmetic damage. The Limited Warranty ALSO DOES NOT COVER damages which occurred in shipment, or failures which are caused by products not supplied by the warrantor, or failures which result from accidents, misuse, abuse, neglect, bug infestation, mishandling, misapplication, alteration, faulty installation, set-up adjustments, misadjustment of consumer controls, improper maintenance, power line surge, lightning damage, modification, introduction of sand, humidity or liquids, commercial use such as hotel, office, restaurant, or other business or rental use of the product, or service by anyone other than a Factory Service Center or other Authorized Servicer, or damage that is attributable to acts of God.

**THERE ARE NO EXPRESS WARRANTIES EXCEPT AS LISTED UNDER "LIMITED WARRANTY COVERAGE". THE WARRANTOR IS NOT LIABLE FOR INCIDENTAL OR CONSEQUENTIAL DAMAGES RESULTING FROM THE USE OF THIS PRODUCT, OR ARISING OUT OF ANY BREACH OF THIS LIMITED WARRANTY.** (As examples, this excludes damages for lost time, lost calls or messages, cost of having someone remove or re-install an installed unit if applicable, travel to and from the servicer. The items listed are not exclusive, but are for illustration only.) **ALL EXPRESS AND IMPLIED WARRANTIES, INCLUDING THE WARRANTY OF MERCHANTABILITY, ARE LIMITED TO THE PERIOD OF THE LIMITED WARRANTY.**

Some states do not allow the exclusion or limitation of incidental or consequential damages, or limitations on how long an implied warranty lasts, so the exclusions may not apply to you.

This Limited Warranty gives you specific legal rights and you may also have other rights which vary from state to state. If a problem with this product develops during or after the Limited Warranty period, you may contact your dealer or Service Center. If the problem is not handled to your satisfaction, then write to the warrantor's Consumer Affairs Department at the addresses listed for the warrantor.

**PARTS AND SERVICE, WHICH ARE NOT COVERED BY THIS LIMITED WARRANTY, ARE YOUR RESPONSIBILITY.**

### When you ship the product

- Carefully pack your unit, preferably in the original carton.
- Attach a letter, detailing the symptom.
- Send the unit to PSTC (Panasonic) Exchange Center, prepaid and adequately insured.
- Do not send your unit to Panasonic Corporation of North America listed on the back cover or to executive or regional sales offices. These locations do not repair consumer products.

**Index**

- A** Additional handset: 29
  - Alarm: 28
  - Answering calls: 16
  - Auto talk: 16
- B** Battery: 10, 11
  - Belt clip: 38
- C** Caller ID number auto edit: 31
  - Caller ID service: 30
  - Caller list: 30
  - Caller list edit: 31
  - Call share: 17
  - Call waiting: 17
  - Call Waiting Caller ID: 17
  - Chain dial: 21
  - Check tel line 1: 39
  - Check tel line 2: 39
  - Conference calls: 35
  - Control type: 12
  - Customer support: 26
- D** Date and time: 14
  - Dialing mode: 13
  - Direct commands: 25
  - Display
    - Contrast: 25
    - Language: 13
- E** Error messages: 39
- F** Flash: 16, 26
- G** Groups: 19, 30
- H** Handset
  - Deregistration: 29
  - Locator: 35
  - Registration: 29
  - Hold: 16
- I** Intercom: 35
  - Interrupt tone: 25
- K** Key tone: 25
- L** Line mode: 26
  - Line selection mode: 14
- M** Making calls: 15
  - Missed calls: 30
  - Mute: 16
- N** Night mode: 28
- P** Pause: 15
  - Phonebook: 19
  - Power failure: 11
  - Privacy mode: 17
- R** Redialing: 15
  - Ringer tone: 25, 30
  - Rotary/pulse service: 17
- S** SP-PHONE (Speakerphone): 15
- T** Temporary tone dialing: 17
  - Time adjustment: 25
  - Transferring calls: 35
  - Troubleshooting: 41
  - TTY: 51
- V** VM (Voice mail): 33
  - Voice mail: 33
  - Volume
    - Receiver: 15
    - Ringer (Handset): 16, 25
    - Speaker: 15
- W** Wall mounting: 37

---

# Notes

# IMPORTANT!

If your product is not working properly. . .

- ① **Reconnect AC adaptor to the base unit.**
- ② **Check if telephone line cord is connected.**
- ③ **Use rechargeable Ni-MH batteries.**  
(Alkaline/Manganese/Ni-Cd batteries CANNOT be used.)
- ④ Read **troubleshooting** page in the **Operating Instructions**.



Visit our Web site: <http://www.panasonic.com/help>

- **FAQ and troubleshooting hints are available.**

### For your future reference

We recommend keeping a record of the following information to assist with any repair under warranty.

Serial No.

Date of purchase

---

(found on the bottom of the base unit)

Name and address of dealer

---

Attach your purchase receipt here.

Panasonic Corporation of North America

One Panasonic Way, Secaucus, New Jersey 07094

### Copyright:

This material is copyrighted by Panasonic System Networks Co., Ltd., and may be reproduced for internal use only. All other reproduction, in whole or in part, is prohibited without the written consent of Panasonic System Networks Co., Ltd.

© Panasonic System Networks Co., Ltd. 2010



\*TG9321\*

Printed in Malaysia



## Free Manuals Download Website

<http://myh66.com>

<http://usermanuals.us>

<http://www.somanuals.com>

<http://www.4manuals.cc>

<http://www.manual-lib.com>

<http://www.404manual.com>

<http://www.luxmanual.com>

<http://aubethermostatmanual.com>

Golf course search by state

<http://golfingnear.com>

Email search by domain

<http://emailbydomain.com>

Auto manuals search

<http://auto.somanuals.com>

TV manuals search

<http://tv.somanuals.com>