

Panasonic

Digital Cordless Answering System

Model No. **KX-TCD725EM**

Operating Instructions



Caller ID Compatible

PLEASE READ BEFORE USE AND SAVE.

Charge the batteries for about 15 hours before initial use.

Dear purchaser,

You have acquired a KX-TCD725EM, which is a product made in regard with the European Standards for Cordless Telephones (DECT). DECT technology is characterised by high-security protection against interceptions as well as high-quality digital transmission.

This telephone was designed for a wide range of applications.

For example, this telephone can be used within a network of base units and handsets, constituting a telephone system which:

- operates up to 6 handsets at one base unit
- allows an intercom between 2 handsets
- allows the operation of a handset at up to 4 base units, expanding the communication radio area.

This telephone may be used for:

- operating several handsets
- operating at several base units
- connecting the base unit to a PBX.

Important Information

Do not connect the AC adaptor to any AC outlet other than the standard AC 220–240 V, 50 Hz.

- Outlet voltage DC 9 V, 500 mA
- The apparatus is approved for use with the PQLV1E power supply.
- CAUTION: Do not remove cover. Live parts inside.

This apparatus has been approved for the use of the following facilities:

- 1) Storage of names and telephone numbers in the phonebook for retrieval
- 2) Last number redial
- 3) Simple telephone facility
- 4) PBX earth register recall (option)
PBX timed break register recall
- 5) MF signalling
- 6) LD signalling
- 7) Pause
- 8) Intercom
- 9) Call prohibition
- 10) Call restriction
- 11) Direct call
- 12) Intercom between handsets
- 13) Transferring a call from one handset to another

- 14) Conference
- 15) Setting the call waiting tone
- 16) Accessing the base unit
- 17) Caller ID service compatible
- 18) Answering & Recording Machine
- 19) Recording and playback of ICM
- 20) DTMF tone remote control system
- 21) Memo recording feature
- 22) Monitoring a telephone call
- 23) LCD call-counter: to indicate received messages
- 24) Vox facility: detection of caller's hanging up
- 25) Selecting the number of rings
2–7/AUTO
- 26) Auto disconnect
- 27) Total recording time (including the greeting message) is about
15 minutes
- 28) Security code for remote operation

Any other usage will invalidate the approval of the apparatus if as a result, it then ceases to conform to the standards against which approval was granted.

Method of connection

This is connected to the exchange line or PABX/PMBX (Private Automatic/Manual Branch Exchange) extension by the new standard British Telecom plug and socket. Arrangements for provision of this type of termination can be made through the nearest British Telecom Sales Office. The apparatus may be connected to the following types of installation. The apparatus has been approved for use under the following conditions:

- a) This apparatus may be used on telecommunication systems employing MF signalling. It is suitable for connection to a direct exchange line on the PSTN (Public Switched Telephone Network) or via a compatible PBX (Private Branch Exchange). (Contact the supplier for an up to date list of compatible PBX's.)
- b) This apparatus is not suitable as an extension to a payphone or for use on a party line with shared service. This cordless telephone has been designed to operate on radio frequencies which have been assigned to the exclusive use of cordless telephones. As the use of cordless telephones becomes more widespread users may experience a reduction in the quality of service obtainable from this apparatus.

Although this equipment can use either loop disconnected or DTMF signalling, only the performance of the DTMF signalling is subject to regulatory requirements for correct operation. It is therefore strongly recommended that the equipment is set to use DTMF signalling for access to public or private emergency services. DTMF signalling also provides faster call set up.

999 or 112 can be dialled on the apparatus for the purposes of making outgoing calls to the BT Emergency (999 or 112) Service.

WARNING:

The apparatus may be unable to make emergency 999 or 112 telephone calls, under certain conditions, e.g.

- Radio interference caused by another cordless telephone operating on the same radio frequency.
- The portable handset battery needs recharging, or has failed.
- The portable handset cannot be used while charging.
- When KEY LOCK is set to ON.
- When the unit is in Direct Call Mode.

Any cases of difficulty should be referred in the first instance to the supplier of the apparatus.

NOTE:

If you experience any problems with the normal use of your apparatus, you should unplug it from the telephone outlet and connect a known working telephone in its place. If the known working telephone still gives problems, then please contact the customer service department of your PSTN operator. If it operates properly, then the problem is likely to be a fault in your apparatus. In this case, contact your supplier for advice. Your PSTN operator may charge you if they attend a service call that is not due to apparatus supplied by them.

Thank you for purchasing your new Panasonic digital cordless telephone.





- Order accessory items for all Communications Products with ease and confidence either by telephoning our Customer Care Centre on:
08705 357357 Monday - Friday 9:00am - 5:30pm
- Or go on line through our Internet Accessory ordering application at www.panasonic.co.uk.
- Most major credit and debit cards accepted.
- All enquires transactions and distribution facilities are provided directly by Panasonic UK Ltd.
- It couldn't be simpler!

For your future reference

Serial No. _____ Date of purchase _____
 (found on the bottom of the unit)

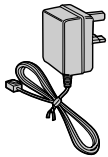
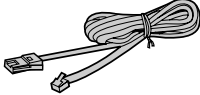
Name and address of dealer _____

Accessories (included)

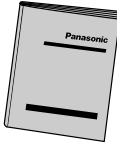
<input type="checkbox"/> AC Adaptor (p. 10) Part No. PQLV1E  one	<input type="checkbox"/> Telephone Line Cord (p. 10) Part No. PQJA87S  one	<input type="checkbox"/> Batteries (p. 10) Part No. BYD N4DH33B00001  two
<input type="checkbox"/> Handset Cover (p. 10) Part No. PQKK10109ZA5  one	<input type="checkbox"/> Belt Clip (p. 88) Part No. PQKE10120ZA2  one	<input type="checkbox"/> Operating Instructions Part No. PQQX13076ZA  one

- Please unpack all of the contents and check if all accessories are included.
- Accessories are subject to technical changes.
- Please keep the original carton box and packaging materials.

Optional accessories

Please contact the place of purchase for the following options.

Model No.	Description
KX-A118EX	Handset/Charger
P6H	Ni-Cd batteries
KX-A109EX	Option Covers

Base Unit Location

Calls are transmitted between the base unit and the handset using wireless radio waves. **For maximum distance and noise-free operation**, the recommended base unit location is:

Away from electrical appliances such as a TV, radio, personal computer or another telephone.

In a **HIGH** and **CENTRAL** location with no obstructions such as walls.

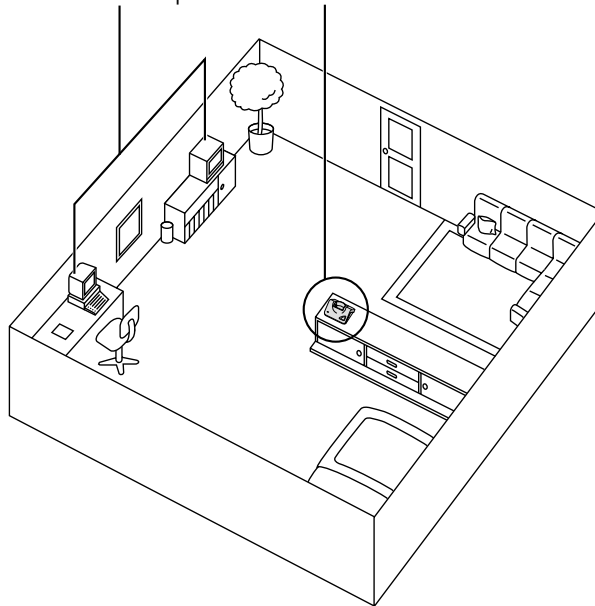

Operating range:

The range of operation depends on the construction of your home, weather and usage conditions. Normally you will get longer range outdoors than indoors.

Obstacles such as walls, metal shelves or cement-iron walls may shorten the operating range.

Noise:

Occasional noise or interference may occur due to other random radio waves.

Contents

Chapter 1 Preparation

Location of Controls8
Display9
Getting Started10
 Installing the Batteries in the
 Handset10
 Connections10
 Battery Charge.....11
Basic Start-up Operations12
 Turning the Power ON/OFF.....12
 Making a Call.....12
 Answering a Call.....12
 Terminating a Call.....12
Basic Answering System
Operations13
 Pre-Recorded Greeting Message13

Chapter 2 Cordless Telephone

Making Calls14
 Making a call after Confirming
 the Entered Phone Number.....14
 Redial Call14
 Calling Back with the Caller List15
 Digital Speakerphone15
 Auto Talk.....16
 Storing a Dialed Number into
 the Phonebook16
Answering Calls17
Paging18
Caller ID.....19
 Caller ID Service.....19
Caller List20
 Viewing the Caller List20
 Editing the Caller's Phone Number ..21
 Clearing Caller Information in the
 Caller List.....22
 Storing Caller List Information
 into the Phonebook.....23

Phonebook24
 Storing Caller Information into
 the Phonebook24
 Private Category Feature25
 Private Category Table26
 Selecting Characters27
 Character Table28
 Editing a Caller Information in the
 Phonebook.....30
 Clearing a Caller Information in the
 Phonebook.....30
 Finding a Caller Information in the
 Phonebook.....31
 Making a Call with the Phonebook....32
 Hot Key Dial.....33
 Phonebook Copy34
Special Features.....36
 Pause Feature (For Analogue PBX
 Line/Long Distance Service Users).....36
 Key Lock36
 Recall Feature37
 Call Waiting and Caller ID
 Compatible.....37

Chapter 3 Programmable Function on the Handset

**Summary of Programmable
 Functions on the Handset**.....38
Handset PIN40
Time Alarm.....41
Ringer Option43
Tone Option44
Display Option.....46
Call Option50
Other Option52
Reset Handset Settings.....53

Chapter 4
Programmable Function on the Base Unit

Summary of Programmable Functions on the Base Unit54
Base Unit PIN55
Ringer Mode Selection56
Base Unit Ringer Volume58
Other Feature.....59
Call Restriction.....61
Reset the Base Unit Settings63
Date and Time.....64

Chapter 5
Answering System

Summary of Answering System Operations65
Summary of Direct Command for Answering System Operations.....66
Answering System Operations.....67
 Greeting Message67
 Incoming /Memo Message69
 During Playback an/a Incoming/ Memo Message71
 During Playback an/a Greeting/ Incoming/Memo Message71
 Quick Play New Message.....71
 Recording Your Telephone Conversation Using the Handset....72
 Setting the VOX SENS Function....72
 Selecting Receiver Volume During Playback73
 Selecting the Number of Rings.....73
 Selecting the Caller's Recording Time...74
 Setting the Monitor Function ON/OFF74
Remote Operation from a Touch Tone Phone.....75
 Setting the Remote Code76
 Voice Menu.....77
 Direct Remote Operation.....78

Chapter 6
Multi-Unit User Operations

Optional Multi-Unit User Operations ..79
 Operating More than One Handset79
 Operating More than One Base Unit79
Registration80
 Registering a Handset in the Base Unit80
 Selecting the Base Unit Access.....81
 Cancelling a Handset Registration in the Base Unit.....82
 Cancelling a Base Unit82
Intercom83
 Intercom between Handsets83
 Transferring a Call from One Handset to Another.....84
 Conference85

Chapter 7
Useful Information

Battery Replacement86
Important Notice Concerning the Correct Use and Charging of Ni-MH (Ni-Cd) Batteries87
Using the Belt Clip88
Using the Optional Headset88
Wall Mounting89
Option Covers90
Before Requesting Help91
Safety Instructions95
Adding Another Phone96
Term Definitions97
GUARANTEE98

Chapter 1

Chapter 2

Chapter 3

Chapter 4

Chapter 5

Chapter 6

Chapter 7

Location of Controls

Handset

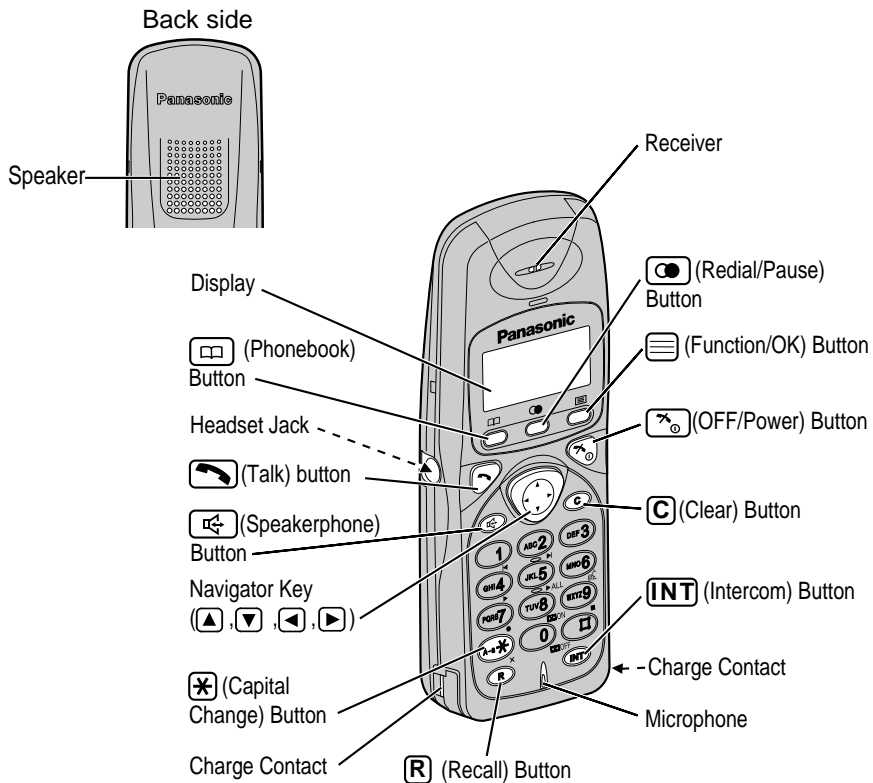

Base Unit

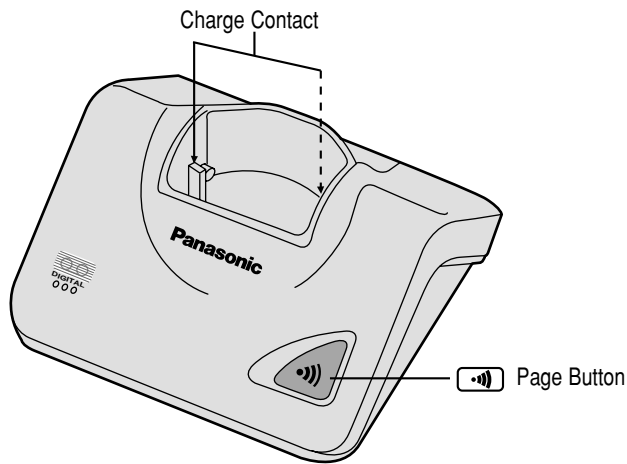



Display

Handset Display





Icons

 The in-range icon indicates that the handset is in range of the base unit. It flashes when the handset is out of range.

 The page/intercom icon is displayed when paging or using the intercom. It flashes when another unit pages the handset.

 The talk icon is displayed when making or answering calls. It flashes when an outside call is being received.

 The call prohibition icon is displayed when call prohibition mode is set to on (p. 50).

 The phonebook icon is displayed when storing or viewing caller information into the phonebook (p. 24).

 The battery icon indicates the battery strength (p. 11).

Characters

P "Pause" is selected while dialling (p. 36).

↳ Direct call mode is ON (p. 51).

[A] Answering system is ON (p. 13)

F **[R]** is pressed while dialling.

[X] Key lock is ON (p. 36).

Getting Started

Installing the Batteries in the Handset

Install the batteries as shown, then install the handset cover.

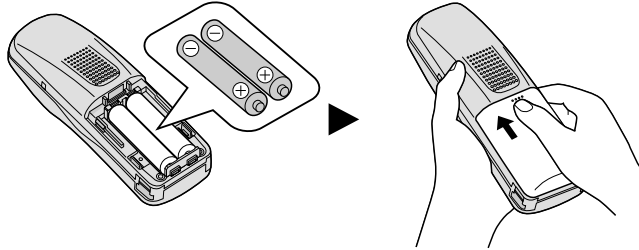

- If the rechargeable batteries are not inserted correctly, the handset will not work.

Connections

Plug in the AC adaptor cord and the telephone line cord to the bottom of the unit. Then connect the cords as shown.

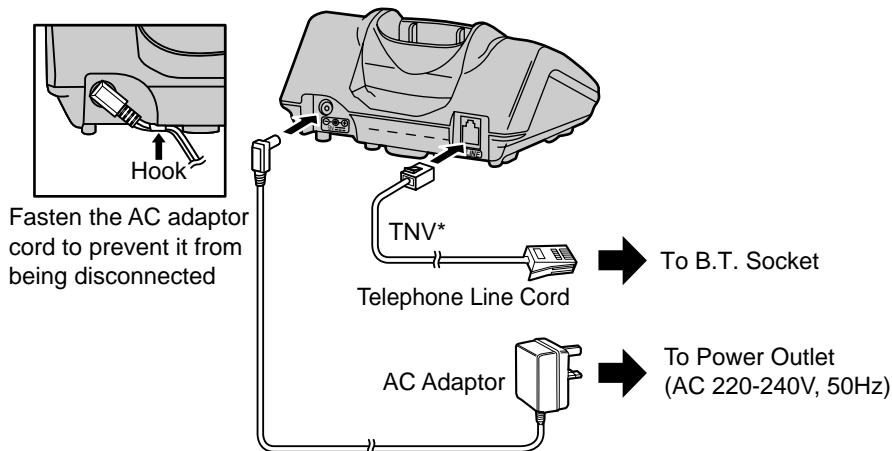

- USE ONLY WITH Panasonic AC ADAPTOR PQLV1E.
- The AC adaptor must remain connected at all times. (It is normal for the adaptor to feel warm during use.)
- If your unit is connected to a PBX which does not support Caller ID services, you cannot access those services.
- To connect a standard telephone on the same line, see page 96.
- * The abbreviation TNV means "Telephone Network Voltage".

CONNECTION OF POWER SUPPLY

This apparatus is intended for use when powered by the PQLV1E.

Using other power supplies will invalidate any approval given to this apparatus.

Battery Charge

At the time of shipment, the batteries are not charged. To charge, place the handset on the base unit. Please charge the batteries for about **15 hours** before initial use. During charging the battery icon is as shown below.

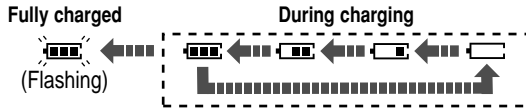

You can check the present battery strength on the display.

Battery strength	Fully charged	High	Medium	Low	Need to be charged
Battery icon					

Recharge

When “” flashes or the unit beeps every 15 seconds, recharge the batteries.

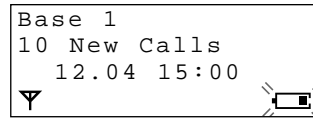

Battery information

After your batteries are fully charged, battery life depends on its type and usage condition.

	Approx. Ni-MH battery life (Included)	Approx. Ni-Cd battery life (Optional)*
While in use (Talk)	Up to about 20 hours	Up to about 10 hours
While not in use (Standby)	Up to about 200 hours	Up to about 100 hours

- Battery life may be shortened depending on usage conditions, such as:
 - when viewing the Caller ID Caller List (p. 20) or phonebook (p. 31)
 - when talking in speakerphone mode (p. 15)
 - ambient temperature.
 - **Clean the handset and the base unit charge contacts with a soft, dry cloth once a month. Clean more often if the unit is subject to grease, dust or high humidity, otherwise the batteries may not be charged properly.**
 - If the batteries are fully charged, you do not have to place the handset on the base unit until “” flashes. This will maximise the battery life.
 - The batteries cannot be overcharged.
- * Nickel Cadmium (Ni-Cd) rechargeable batteries (AA size) are available.
If you replace the batteries with Ni-Cd batteries, battery type selection on the handset programming must be changed to Ni-Cd (p. 52).
- Read “Important Notice Concerning the Correct Use and Charging of Ni-MH (Ni-Cd) Batteries” on page 87.

Basic Start-up Operations

Turning the Power ON/OFF

To turn the power ON

Press and hold .

- After all possible configurations briefly appear, the display will change to the standby mode. A beep sounds.

To turn the power OFF

Press and hold  until a beep sounds.

- The display will go blank.
- The handset will not ring.
- A beep sounds.

Standby mode

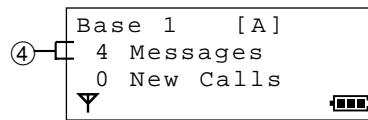
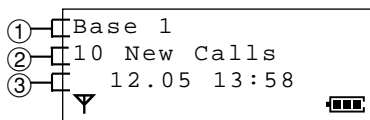

- If incoming/memo message(s) is/are recorded, the standby mode will be shown as below.

- ① The current connected base unit number: You can select whether to display the base unit number, handset number or no display in the standby mode by programming (p. 46).
- ② The number of new Caller ID calls received (p. 19).
- ③ The current date and time (p. 64).
- ④ The number of recorded incoming/memo message. If new incoming/memo message(s) is/are recorded, ④ will flash. When memory is full, ④ will flash faster.

Making a Call

For further information on making calls, see page 14.

Make sure that the power is ON, and the unit is in the standby mode.

Press  then dial a phone number.

- After a few seconds, the display will start showing the length of the call.
- If you misdialled, press  and start over again.
- The dialled number is automatically stored into the redial list (p. 14).

Answering a Call

For further information on answering calls, see page 17.

Make sure that the power is ON, otherwise the handset will not ring.

Press  or any dialling button, **0** to **9**, **INT**, ***** or **#** —Any Key Answer.

- After a few seconds, the display will start showing the length of the call.

Terminating a Call

Press  or place the handset on the base unit.

- The handset will returned to the standby mode.

Basic Answering System Operations

For further information on answering system, see page 67.

You can operate the answering system by function menu or by pressing dialling button as direct command.

If you set the current date and time (p. 64) and set the answering system ON, a synthesized voice announce the date and time an/a incoming/memo message was recorded after playback—**Voice Date/Time Stamp**.

Pre-Recorded Greeting Message

There are 2 pre-recorded greeting messages. A pre-recorded greeting message depends on selecting the caller's recording time (p. 74).

You can record your own greeting message (p. 67).

Make sure that the power is ON (p. 12), and the unit is in the standby mode.

To play the pre-recorded greeting message

1 Press **INT** then **□**.

2 Press **▼** or **▲** until the arrow points to "Play OGM", then press **☰**.

OR

Press **6**.

- A pre-recorded greeting message is played as follows.

- When the recording time is set to "1 minute" or "unlimited (16 minutes)" (p. 74).
 - "Hello, we are not available now. Please leave your name, message and phone number after the beep. We will return your call."
- When the recording time is set to "greeting only" (p. 74).
 - "Hello, no one is available to take your call. Please call back later."

To set the answering system ON

1 Press **INT** then **□**.

2 Press **▼** or **▲** until the arrow points to "Answer ON", then press **☰**.

OR

Press **8**.

- A beep sounds, and "Answer Set" is heard.
- [A] is displayed.

To set the answering system OFF

1 Press **INT** then **□**.

2 Press **▼** or **▲** until the arrow points to "Answer OFF", then press **☰**.

OR

Press **0**.

- A beep sounds, and "Answer OFF" is heard.

- To playback new/all incoming/memo messages, see page 69.

Making Calls

For basic making a call operation, see page 12.

Making a Call after Confirming the Entered Phone Number

Make sure that the power is ON (p. 12), and the unit is in the standby mode.

1 Enter a phone number.

- The entered number is displayed.
- To cancel, press and hold **C** or press **✕**.

2 Press **☎**.

- “☎” is displayed.

- After a few seconds, the display will start showing the length of the call.

3 Press **✕** or place the handset on the base unit to hang up.

- The handset will return to the standby mode.

Redial Call

The unit automatically stores the last 10 dialed phone numbers into the redial list. If the redial list is empty, “No Stored Memory” is displayed when you press **☎**. If you press **☎** then **☎** for redial call and the other party is busy, the unit will call back automatically every 40 seconds, up to 12 times.

Make sure that the power is ON (p. 12), and the unit is in the standby mode.

To redial the last number dialed

Press **☎** then **☎** or **☎**.

OR

Press **☎** or **☎** then **☎**.

- The last number dialed is automatically redialed.

To redial with the redial list

1 Press **☎**.

- The last number dialed is displayed.

2 Press **▼** or **▲** until the arrow points to the phone number you desire to call.

- To exit the redial list, press **✕**.

3 Press **☎** or **☎**.

- The selected number is automatically redialed.

To clear a phone number in the redial list

1 Press **☎**.

- The last number dialed is displayed.

2 Press **▼** or **▲** until the phone number you desire to clear is displayed, then press **▶**.

- To exit the redial list, press **✕**.

3 Press **▼** or **▲** until the arrow points to “Clear”, then press **▶**.

4 Press **▼** or **▲** to select “YES”, then press **☎**.

- “CLEARED” is displayed.

To clear all phone numbers in the redial list

1 Press **☎** then **▶**.

2 Press **▼** or **▲** until the arrow points to “All Clear”, then press **▶**.

3 Press **▼** or **▲** to select “YES”, then press **☎**.

- “CLEARED” is displayed.
- “No Stored Memory” is displayed.



Calling Back with the Caller List

Information from up to 50 different callers is automatically stored from the most recent call to the oldest call in the Caller List. When the 51st call is received, the oldest caller information is deleted. If you receive a call from the same phone number you stored with name in the phonebook, the display will show the caller name also (p. 24). If the caller list is empty, "No Stored Memory" is displayed when you press or for viewing the caller list.

Make sure that the power is ON (p. 12), and the unit is in the standby mode.

1 Press or .

- The most recent caller's information is displayed.

2 Press repeatedly to search from the most recent call or press repeatedly to search from the oldest call until the arrow points to the caller information you desire to call.

- To scroll between callers, press and hold or .

3 Press or .

- The displayed phone number is automatically dialed.

4 To hang up, press or place the handset on the base unit.

- The handset will return to the standby mode.
- If a phone number is not displayed, you cannot call back that caller.

Digital Speakerphone

Make sure that the power is ON (p. 12), and the unit is in the standby mode.

To make a hands-free phone conversation

1 Press then enter a phone number. OR

Enter a phone number then press .

- The dialled number is displayed.
- After a few seconds, the display will start showing the length of the call.

2 When the other party answers, talk into the microphone.

3 To hang up, press .

- If "T" flashes and an alarm tone sounds after pressing or , move closer to the base unit, then try again.
- You can select whether to display the length of the call or dialled phone number while in the talk mode (p. 47).

For best performance on digital speakerphone

- Talk alternately with the caller in a quiet room.
- If the other party has difficulty hearing you, press to decrease the speaker volume.
- If the other party's voice from the speaker cuts in/out during a conversation, press to decrease the speaker volume.
- While talking, you can switch to the hands-free phone conversation by pressing . To switch back to the receiver, press or .















➔ Making Calls

Auto Talk

The auto talk feature allows you to answer a call by lifting the handset off the base unit without pressing . The factory preset is OFF. In order to view Caller ID information before answering a call, leave the auto talk feature OFF.

Make sure that the power is ON (p. 12), and the unit is in the standby mode.





To set the auto talk feature ON/OFF

- 1 Press .
- 2 Press  or  until the arrow points to "Setting Handset", then press .
- 3 Press  or  until the arrow points to "Other Option", then press .
- 4 Press  or  until the arrow points to "Auto Talk", then press .
 - The current setting is at the arrow.
- 5 Press  or  to select "ON" or "OFF".
- 6 Press .
 - A beep sounds.
 - The display will return to "Auto Talk".
To return to the standby mode, press  or wait for 60 seconds.
 - You can exit the programming mode any time by pressing .





Storing a Dialed Number into the Phonebook

Make sure that the power is ON (p. 12), and the unit is in the standby mode.

To store an entered number into the phonebook

- 1 Enter a phone number.
 - The entered number is displayed.
 - If you misdial, press . Digits are erased from the right.
 - To cancel, press and hold  or press .
- 2 Press .
- 3 Follow steps 4 to 7 on Storing Caller List Information into Phonebook (p. 23).
- 4 While "Save" is at the arrow, press .
 - A beep sounds and "Saved" is displayed.
 - The display will return to the entered phone number.

To store a redial number into the phonebook

- 1 Press .
 - The last number dialed is displayed.
- 2 Press  or  until the arrow points to the phone number you desire to store, then press .
- 3 Follow steps 4 to 7 on Storing Caller List Information into Phonebook (p. 23).
- 4 While "Save" is at the arrow, press .
 - A beep sounds and "Saved" is displayed.
 - The display will return to the stored caller information.



Answering Calls

For basic answering a call operation, see page 12.

If you subscribe to a Caller ID service, the caller information will be displayed after the first ring (p. 19).



Make sure that the power is ON (p. 12), otherwise the handset will not ring.

Selecting the receiver volume (HIGH, MEDIUM or LOW) or speaker volume (6 levels) during conversation

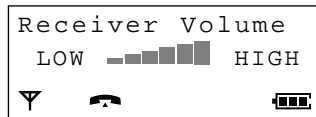

Press  to decrease volume, or press  to increase volume.

Ex. Receiver volume: HIGH



- Each time you press  or , the volume level will change.
- The display will return to the talk mode after receiver/speaker volume selection.

Temporary Ringer OFF

- 1 Press and hold  for 1 second while handset is ringing.
 - The handset stops ringing.
- 2 Press  or any dialling button, **0** to **9**, **INT**, ***** or **#** to answer a call—Any Key Answer.
 - After a few seconds the display will start showing the length of the call.
 - This function is not available when the handset is on the base unit.
 - This function is for external call only.

Auto Talk

If you set the auto talk feature ON (p. 16), you can answer a call by lifting the handset off the base unit without pressing .

Display Backlight







The lighted display will stay on for about 10 seconds after pressing a handset button or lifting the handset off the base unit. You can select one of 3 display backlight colours, green, orange, or red (p. 49).

Paging

In multi-unit user operation, conversation between handsets is available with intercom feature (p. 83).
Make sure that the power is ON (p. 12), and the unit is in the standby mode.













Paging the Handset from the Base Unit (Handset Locator)

Using this feature, you can locate a misplaced handset.

- 1 Press  on the base unit.
 - The handset rings for 1 minute and “” flashes.
- 2 To stop paging, press , **0** to **9**, **INT**, ,  or  on the handset or  on the base unit.

Selecting the Ringer Type for Paging



You can select one of 20 ringer types for paging.
Make sure that the power is ON (p. 12), and the unit is in the standby mode.

- 1 Press .
- 2 Press  or  until the arrow points to “Setting Handset”, then press .
- 3 Press  or  until the arrow points to “Ringer Option”, then press .
- 4 Press  or  until the arrow points to “Paging Type”, then press .
 - The current setting is at the arrow and rings.
- 5 Press  or  to select the desired ringer type.

```

Paging Type
▶ Ringer 1
  Ringer 2
▼                                     

```

 - Each time you press a button, selected ringer type sounds.
- 6 Press .
 - A beep sounds.
 - The display will return to “Paging Type”. To return to the standby mode, press  or wait for 60 seconds.

Caller ID

Caller ID Service

Caller ID, where available, is a telephone company service, and if you subscribe to this service, the caller information will be displayed after the first ring.

If you subscribe to a Caller ID and Call Waiting service, when a second call is received while talking, the new caller's phone number will be displayed.

How caller information is displayed when a call is received

After the first ring, the display shows the caller's phone number.

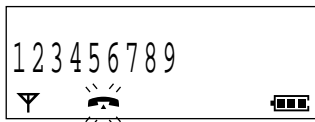

- After you answer the call, the display will start showing the length of the call.

If you receive a call from the same phone number you stored with name in the phonebook, the display shows the caller's phone number and name. You must store names and numbers in the phonebook if you desire to use this function.

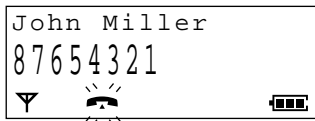

- After you answer the call, the display will start showing the length of the call.
- Caller information cannot be displayed in the following cases.
 - If the caller dialed from an area where Caller ID service is unavailable, the display will show "Out of Area".
 - If the caller has requested not to display his/her information, the display will show "Private Caller".
- If your unit is connected to a PBX which does not support Caller ID services, you cannot access those services.

Checking the number of new calls

When new calls have been received, the display shows the number of new calls in the standby mode.

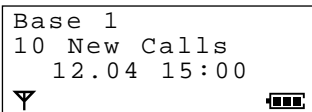

Caller List

Viewing the Caller List

Information from up to 50 different callers is stored from the most recent call to the oldest call in the caller list. When the 51st call is received the oldest caller information is deleted. Each caller's phone number and the date and time received are shown. If you receive a call from the same phone number you stored with name in the phonebook, the display will show the caller name also (p. 24).



Make sure that the power is ON (p. 12), and the unit is in the standby mode.

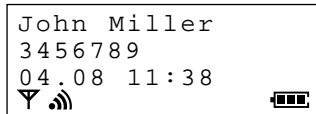

1 Press  **or** .

- The most recent caller's information is displayed.

Ex. A caller's name, phone number received date/time are displayed.



2 Press  **repeatedly to search from the most recent call or press**  **repeatedly to search from the oldest.**

- To scroll between callers, press and hold  or .

3 To exit the list, press .

- The handset will return to the standby mode.
- If Caller List is empty, "No Stored Memory" is displayed in step 1. The display will return to the standby mode.
- If more than one call is received from the same caller, only the date and time of the most recent call will be stored.
- To call back with the caller list, see page 15.

What "✓" means

When you have checked new calls, answered the call or called back the caller, "✓" will be added to the caller information.

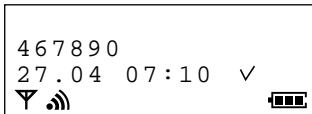

- When the same caller calls again, the call entry with "✓" will be deleted and replaced with the new call entry.

When viewing long telephone numbers

If an arrow (→) is displayed after the number the whole telephone number has not been shown.

Press  **to see the remaining numbers.**





Editing the Caller's Phone Number

You can edit a phone number in the caller list. After editing the phone number, you can continue to calling back or phonebook storing procedures.

Make sure that the power is ON (p. 12), and the unit is in the standby mode.

- 1 Press or .
 - The most recent caller's information is displayed. - 2 Press repeatedly to search from the most recent call or press repeatedly to search from the oldest call until the arrow points to the caller information you desire to edit.
 - 3 Press .
 - 4 Press or until the arrow points to "Edit For Call", then press .
 - 5 Edit the number with the dialling buttons, , , or .
 - Pressing erases the digit to the left of the cursor.
 - If a pause is required for dialling, press . A pause can be stored in a phone number counting as one digit (p. 36).
- 6 Press to call back.
OR
Press to store the phone number into the phonebook, then while "Save Phonebook" is at the arrow, press . Follow steps 5 to 8 on Storing Caller List Information into the Phonebook (p. 23).













➔ Caller List

Clearing Caller Information in the Caller List









You can clear selected or all caller information in the Caller List.

Make sure that the power is ON (p. 12), and the unit is in the standby mode.

To clear a selected caller information in the caller list

- 1 Press  or .
 - The most recent caller's information is displayed.
- 2 Press  repeatedly to search from the most recent call or press  repeatedly to search from the oldest call until the arrow points to the caller information you desire to clear.
- 3 Press .
- 4 Press  or  until the arrow points to "Clear", then press .
 - "Clear ?" is displayed.
- 5 Press  or  to select "YES", then press .
 - A beep sounds and "CLEARED" is displayed.
 - After a few seconds, the next caller information is displayed, or "No Stored Memory" is displayed if no more stored caller information in the Caller List. To return to the standby mode, press  or wait for 60 seconds.

To clear all caller information in the caller list

- 1 Press  or .
 - The most recent caller's information is displayed.
- 2 Press .
- 3 Press  or  until the arrow points to "All Clear", then press .
 - "All Clear ?" is displayed.
- 4 Press  or  to select "YES", then press .
 - A beep sounds and "CLEARED" is displayed.
 - After a few seconds, "No Stored Memory" is displayed and the handset will return to the standby mode.



Storing Caller List Information into the Phonebook

You can store the Caller List information into the phonebook. You can categorise the caller information in the phonebook up to 9 categories, then you can select one of 3 display backlight colours and one of 20 ringer types for each private category—**Private Category Feature (p. 25)**.

Make sure that the power is ON (p. 12), and the unit is in the standby mode.

1 Press  or .

- The most recent caller's information is displayed.



2 Press  repeatedly to search from the most recent call or press  repeatedly to search from the oldest call until the arrow points to the caller information you desire to store.

3 Press .

4 While "Save Phonebook" is at the arrow, press .

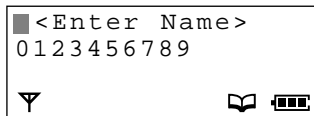

- The display shows the number of remaining phonebook items, then "<Enter name>".







5 Enter the name up to 16 characters with the dialling buttons, ,  or .

- To select characters, see page 27.
- If the phone number requires editing, press  and see step 5 on page 21.

6 Press .

7 Press  or  to select the desired private category number 1 to 9 or OFF, then press .

8 While "Save" is at the arrow, press .

- A beep sounds and "Saved" is displayed.
- The display will return to caller list. You can continue the storing procedure begin with step 3. To return to the standby mode, press  or wait for 60 seconds.
- If a pause is required for dialling, press . A pause can be stored in a phone number counting as one digit (p. 36).
- You can exit the programming mode any time by pressing .
- If the display shows "Memory Full" in step 2, the display will return to the standby mode. You must clear the other caller information in the phonebook (p. 30).

Phonebook

You can store up to 200 caller information in the phonebook. All caller information is automatically stored by the first word in alphabetical order.

If you received a call from the same phone number you stored with name in the phonebook, the display will show the caller name and phone number (p. 19).

You can categorise the caller information in the phonebook up to 9 categories, then you can select one of 3 display backlight colours and one of 20 ringer types for each private category—**Private Category Feature (p. 25)**. This feature is only available on subscription to Caller ID.

You can make a call with phonebook (p. 32).

Storing Caller Information into the Phonebook



Make sure that the power is ON (p. 12), and the unit is in the standby mode.

1 Press .

2 Press  or  until the arrow points to "New Phonebook", then press .

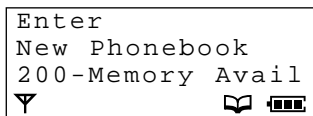
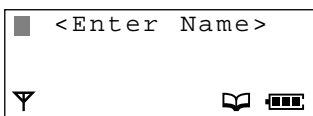
- The display shows the number of remaining phonebook items, then "<Enter Name>".





3 Enter a name up to 16 characters with the dialling buttons, ,  or .

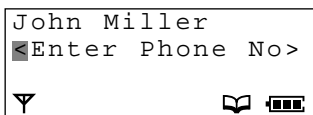

- To select characters, see page 27.

4 Press .



- "<Enter Phone No>" is displayed.





5 Enter a phone number, up to 24 digits.

- If you misdial, press . Digits are erased from the right. To erase all digits, press  firmly.

6 Press .

7 Press  or  to select the desired private category number 1 to 9 or OFF, then press .

8 While "Save" is at the arrow, press .

- A beep sounds and "Saved" is displayed.
- The display will return to "<Enter Name>". You can continue the storing procedure begin with step 3. To return to the standby mode, press  or wait for 60 seconds.
- If a pause is required for dialling, press . A pause can be stored in a phone number counting as one digit (p. 36).
- You can exit the programming mode any time by pressing .
- If the display shows "Memory Full" in step 2, the display will return to the standby mode. You must clear the other caller information in the phonebook (p. 30).



Private Category Feature

When receiving a call, you can easily figure out a person in which category has called by selected display backlight colour and ringer type for each private category. We recommend you to write down the private category table (p. 26) for making the phonebook registration easier. This feature is only available on subscription to Caller ID.

Make sure that the power is ON (p. 12), and the unit is in the standby mode.

To select the display backlight colour for the private category

You can select one of 3 display backlight colours, green, orange, or red for each category. The factory preset is green.

- 1 Press
- 2 Press or until the arrow points to "Setting Handset", then press .
- 3 Press or until the arrow points to "Display Option", then press .
- 4 Press or until the arrow points to "Private color", then press .
- 5 Press or to select the desired category, then press .
 - The current display backlight colour lights.
- 6 Press or to select the display backlight colour.
 - Each time you press or , the display backlight colour will change and lights.
 - Ex. Red is selected for the category 1.



- 7 Press .
 - A beep sounds.
 - To return to the standby mode, press or wait for 60 seconds.

To select the ringer type for the private category

You can select one of 20 ringer types for each category. The factory preset is 1.

- 1 Press .
- 2 Press or until the arrow points to "Setting Handset", then press .
- 3 Press or until the arrow points to "Ringer Option", then press .
- 4 Press or until the arrow points to "Private Ring", then press .
- 5 Press or to select the desired category, then press .
 - The current ringer type rings.
- 6 Press or to select the ringer type.
 - Each time you press or , the ringer type will change and rings.
 - Ex. Ringer 1 is selected for the category 1.

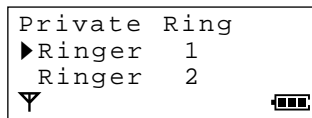

- 7 Press .
 - A beep sounds.
 - To return to the standby mode, press or wait for 60 seconds.

➔ Phonebook

Private Category Table

For example

Private Category	Display Backlight Colour			Ringer Type	Memo
	Green	Orange	Red		
1	✓			3	Friends

Private Category	Display Backlight Colour			Ringer Type	Memo
	Green	Orange	Red		
1					
2					
3					
4					
5					
6					
7					
8					
9					
OFF					



Selecting Characters

The dialling buttons can be used to enter letters and character symbols. The letters are printed on the dialling buttons. Pressing each button selects a character as shown on page 28, 29.

To change the character mode

You can select one of 6 character modes by pressing during entering a name procedure. The factory preset is "ABC".

- 1 Press while entering a name.
 - 2 Press or until the arrow points to the desired character mode, then press .
- The character mode is displayed.

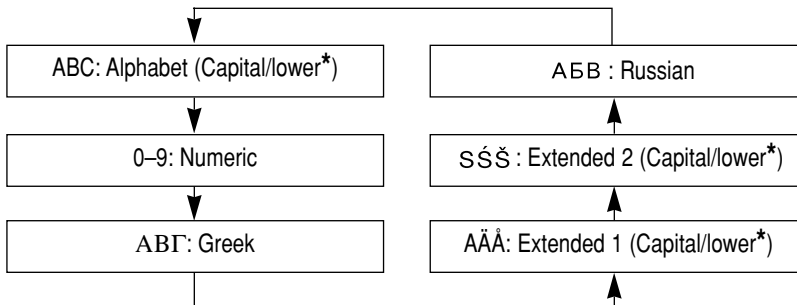
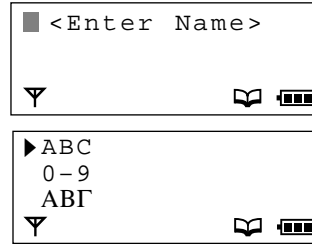

*To change from capital to lower case, press . Each time you press , the mode will change.

For example, to enter "Anne":

1. Press then .
2. Press then TWICE.
3. Press then TWICE.
4. Press TWICE.

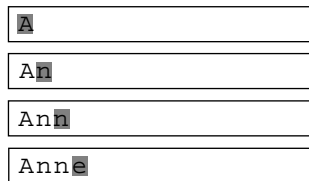

If you make a mistake while entering a name

Press or to move the cursor to the incorrect character, press to delete, and enter the correct character. Pressing erases the character to the left of the cursor. To erase all characters, press and hold .

➔ Phonebook

Character Table

Buttons	ABC (Alphabet)	0-9 (Numeric)	ΑΒΓ (Greek)	ÄÅ (Extended)
1	# & ' () * , - . /	1	# & ' () * , - . /	# & ' () * , - . /
	# & ' () * , - . /	1	# & ' () * , - . /	# & ' () * , - . /
2	A B C	2	ΑΒΓ	Ä Å Ä Å Ä Å Æ B C Ç
	a b c	2	ΑΒΓ	a à á â ã ä å æ b c ç
3	D E F	3	ΔΕΖ	D E È É Ê Ë Ì
	d e f	3	ΔΕΖ	d e è é ê ë ì
4	G H I	4	ΗΘΙ	G Ğ H I Ì Í Î Ï
	g h i	4	ΗΘΙ	g ğ h i ì í î ï
5	J K L	5	ΚΛΜ	J K L
	j k l	5	ΚΛΜ	j k l
6	M N O	6	ΝΞΟ	M N Ñ O Ò Ó Ô Õ Ö Ø
	m n o	6	ΝΞΟ	m n ñ o ò ó ô õ ö ø
7	P Q R S	7	ΠΡΣ	P Q R S Ş ß
	p q r s	7	ΠΡΣ	p q r s ş ß
8	T U V	8	ΤΥΦ	T U Ù Ú Û Ü Õ V
	t u v	8	ΤΥΦ	t u ù ú û ü õ v
9	W X Y Z	9	ΧΨΩ ÿ	W X Y Z
	w x y z	9	ΧΨΩ ÿ	w x y z
0	blank	0	blank	blank
	blank	0	blank	blank
◀	To move the cursor █ to the left.			
▶	To move the cursor █ to the right. (To enter another character using the same dialling button, move the cursor to the next space.)			
C	To erase characters.			
*	To shift from capital to lower case, press *. Each time you press *, the mode will change.			



Character Table

Buttons	Š ŠŠ (Extended 2)	АБВ (Russian)
1	# & ' () * , - . /	# & ' () * , - . /
	# & ' () * , - . /	# & ' () * , - . /
2	Á Ā Ä Å Æ Ç Ć Ć	А Б В Г
	Á á ä å æ ç Ć Ć	А Б В Г
3	Đ Ď Ę É Ě Ě Ě F	Д Е Ж З
	Đ Ď ę é Ě Ě f	Д Е Ж З
4	Ĝ Ĥ Ĩ Í	И Й К Л
	Ĝ ĥ ĩ í	И Й К Л
5	Ĵ Ķ Ļ Ł Ĺ Ĺ	М Н О П
	Ĵ ĵ ĳ ł ł Ĺ Ĺ	М Н О П
6	Ń Ņ ņ Ő Ó Ö Ő	Р С Т У
	ń Ņ ņ ő ó ö ő	Р С Т У
7	Ŕ Ŗ Ŗ Ŗ Š Š Š	Ф Х Ц Ч
	ŕ ŗ ŗ ŗ š š š	Ф Х Ц Ч
8	Ť ť Ů Ű Ū Ŵ	Ш Щ Ъ Ы
	t ť ú ű ū ŵ	Ш Щ Ъ Ы
9	Ŷ Ÿ Ź Ź Ź Ź	Ь Э Ю Я
	w x y ý z ź ź ź	Ь Э Ю Я
0	blank	blank
	blank	blank
◀	To move the cursor █ to the left.	
▶	To move the cursor █ to the right. (To enter another character using the same dialling button, move the cursor to the next space.)	
C	To erase characters.	
✳	To shift from capital to lower case, press ✳. Each time you press ✳, the mode will change.	

The following small letters of Greek, Russian (Cyrillic), Polish, Czech and Slovakian are not available. Then same letter as Capital will be displayed.

ą ć ċ đ ę ħ ł ĺ Ń Ņ ņ Ŗ ŗ ŝ š ť ź ž ž

Chapter 2
Cordless Telephone

➔ Phonebook

Editing a Caller Information in the Phonebook

Make sure that the power is ON (p. 12), and the unit is in the standby mode.

1 Press  to enter the phonebook.

- The first caller information is displayed.

2 Press  or  until the arrow points to the caller information you desire to edit.

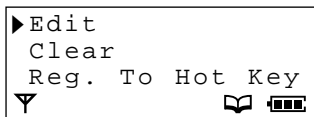

- You can also find a name by initial (p. 31).

3 Press .



4 While “Edit” is at the arrow, press .

- If you do not need to change the name, go to step 6.



5 Edit the name up to 16 characters with the dialling buttons, ,  or  (p. 27).

6 Press .



- If you do not need to change the number, go to step 8.

7 Edit the number with the dialling buttons

,  or .

- Pressing  erases the digit to the left of the cursor. To erase all digits, press and hold .

8 Press .

9 Press  or  to select the desired category number 1 to 9 or OFF, then press .

10 While “Save” is at the arrow, press .

- A beep sounds and “Saved” is displayed.
- To return to the standby mode, press  or wait for 60 seconds.

Clearing a Caller Information in the Phonebook

Make sure that the power is ON (p. 12), and the unit is in the standby mode.

1 Press  to enter the phonebook.

- The first caller information is displayed.



2 Press  or  until the arrow points to the caller information you desire to clear.

- You can also find a name by initial (p. 31).

3 Press .

4 Press  or  until the arrow points to “Clear”, then press .

- “Clear ?” is displayed.

5 Press  or  to select “YES”, and press .

- A beep sounds and “CLEARED” is displayed.
- After a few seconds, the display will show the next caller information.
- To return to the standby mode, press  or wait for 60 seconds.



Finding a Caller Information in the Phonebook

Make sure that the power is ON (p. 12), and the unit is in the standby mode.

To find a name by pressing or .

- 1 Press to enter the phonebook.
 - The first caller information is displayed.
- 2 Press or until the name you desire to find is displayed.
 - All phonebook items are sorted in the following order.

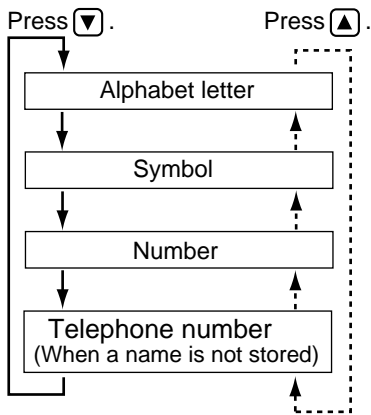

- To exit the phonebook, press .

To find a name by initial

- 1 Press to enter the phonebook.
 - The first caller information is displayed.
- 2 Press the dialling button for the first letter of the name you desire to find until any name with the same initial is displayed.

- The letters are printed on the dialling buttons.

Ex. To find "Felix", press repeatedly until the caller information begin with "F" is displayed.

- 3 Press until the name you desire to find is displayed.



- To exit the phonebook, press .

- If the phonebook is empty "No Stored Memory" is displayed in step 1. The handset will return to the standby mode.

➔ Phonebook

Making a Call with the Phonebook

Make sure that the power is ON (p. 12), and the unit is in the standby mode.

- 1 Follow steps on Finding a Caller Information in the Phonebook (p. 31) to find the name you desire to call.
- 2 Press  or  .
 - The selected phone number is automatically dialed.
- 3 To hang up, press  or place the handset on the base unit.



Hot Key Dial

The dialling buttons 1 to 9 function as one-touch dials. You can assign up to 9 caller information in the phonebook into each dialling button 1 to 9 as hot key dial.

Make sure that the power is ON (p. 12), and the unit is in the standby mode.

To store a caller information as hot key dial

- 1 Follow steps on Finding a Caller Information in the Phonebook (p. 31), then press .
- 2 Press or until "Reg. To Hot Key" is displayed, and press .

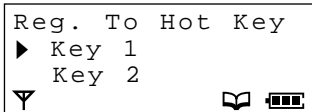

- If already stored, "✓" will be displayed on the left of the hot key number.
- 3 Press or to select a hot key number, then press .
 - 4 Press or until "Save" is displayed.
OR
If the hot key number with "✓" is selected, press or until "Overwrite" is displayed.
 - 5 Press .
- After a few seconds, the display will show the next caller information.
 - To return to the standby mode, press or wait for 60 seconds.

To make a call with hot key dial

- 1 Press and hold a hot key number 1 to 9.
 - The stored caller information is displayed.
- 2 Press or .
 - The number is automatically dialled.
- 3 To hang up, press .

To clear a caller information in the hot key dial

- 1 Press and hold a hot key number 1 to 9.
 - The stored caller information is displayed.
- 2 Press .
- 3 Press or until the arrow points to "Clear", then press .
 - "Clear ?" is displayed.
- 4 Press or to select "Yes", then press .
 - A beep sounds and "CLEARED" is displayed.
 - "No Stored Memory" is displayed if clear all hot key dial.

➔ Phonebook

Phonebook Copy





You can copy the caller information in the phonebook between the handsets registered in the same base unit. The phonebook copy must be operated in intercom mode (p. 83).

Ex. Handset 2 is copying the phonebook to Handset 1 during an intercom call.











Make sure that the power is ON (p. 12), and the unit is in the standby mode.

To copy a selected caller information in the phonebook

Station 1 (Receiver):





- 1 During an intercom call, press .
- 2 Press  or  until the arrow points to "Recv Phonebook", then press .
 - "Copy Proceeding" is on the display.

Station 2 (Sender):









- 1 Press .
 - 2 Press  or  until the arrow points to "Send Phonebook", then press .
 - The phonebook is displayed.
 - 3 Press . Press  or  until the name you desire to copy is displayed, then press .
 - 4 Press  or  until the arrow points to "Copy Entry", then press .
 - "Copy Proceeding" is on the display and the selected information is copied.
 - After copying is completed, a beep sounds and "Copy Complete" is displayed.
 - After a few seconds, the display will return to the intercom call.
- If "Copy Incomplete" is displayed, the receiver handset memory is full.
 - If "Copy Failure" is displayed, the receiver and/or sender did not prepare for copying within 60 seconds.

To copy all caller information in the phonebook

Station 1 (Receiver):

- 1 During an intercom call, press .
- 2 Press  or  until the arrow points to "Recv Phonebook", then press .
 - "Copy Proceeding" is on the display.

Station 2 (Sender):

- 1 Press .
 - 2 Press  or  until the arrow points to "Send Phonebook", then press .
 - The phonebook is displayed.
 - 3 Press . Press  or  until the arrow points to "Copy Forward", then press .
 - "Copy Proceeding" is on the display and all forwarded information in the phonebook is copied.
 - After copying is completed, a beep sounds and "Copy Complete" is displayed.
 - After a few seconds, the display will return to intercom call.
- If "Copy Incomplete" is displayed, the receiver handset memory is full.
 - If "Copy Failure" is displayed, the receiver and/or sender did not prepare for copying within 60 seconds.

Special Features

Pause Feature

(For Analogue PBX Line/Long Distance Service Users)

We recommend you to insert "Pause" if a pause is required for dialling with a PBX or to access a long distance service.

Make sure that the power is ON (p. 12), and the unit is in the standby mode.

Ex. Line access number **9** (PBX)

9 →  → Phone number

OR

1 Press  then **9**.

2 Press  and press  to select "Pause".

3 Enter a phone number.

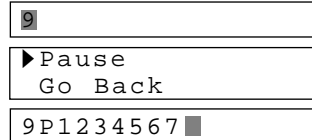

- Selecting "Pause" creates a pause. "P" is displayed. This prevents misdialling when you redial or dial a stored number.
- Selecting "Pause" more than once increases the length of the pause between numbers.

Key Lock

You can lock the handset dialling buttons. Only incoming calls are accepted while the key lock is ON.

Make sure that the power is ON (p. 12), and the unit is in the standby mode.

To set the key lock

Press and hold  until a beep sounds.

- "[X]" is displayed and all dialling buttons are locked.

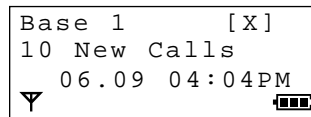

To cancel the key lock

Press and hold  for about 2 seconds.

- "[X]" will disappear and the key lock will be cancelled.
- The key lock will also be cancelled when the power is OFF (p. 12).
- When the key lock is ON, emergency calls can not be made until the key lock is cancelled.

Recall Feature

R is used to access special telephone services (optional) such as call waiting. Contact your telephone company for details.

Example: British Telecom call waiting

When a call waiting tone is heard during a conversation:

a) **To hold the existing call and accept the waiting call**

Press **R**

- Each time you press **R**, you can switch between the first and second call.
- Depending on the provider, you may need to enter a code after pressing **R**. Follow the instructions given by your provider.

b) **To accept the waiting call and hang up the existing call**

Press ***0** to end existing call. When the unit rings, press **☎** to answer the new call.

c) **To reject the waiting call**

Wait for the call waiting to time out. This will take about 40 seconds.

If your unit is connected to a PBX, pressing **R** allows you to access some features of your host PBX such as transferring an extension call.

Call Waiting and Caller ID Compatible

If you subscribe to Caller ID and Call Waiting service, your handset displays a second caller's information while talking. After you hear a second caller waiting tone, the caller's phone number and "CALL WAITING" will be displayed.

You can answer the second call, keeping the first call on hold.

- If the phone number is stored in the phonebook, the caller's name will be displayed (p. 24).
- Please consult your telephone company for details and available in your area.

Summary of Programmable Functions on the Handset

You can program the following function items **using the handset near the base unit.**

See the corresponding pages for function details.

Make sure that the power is ON (p. 12), and the unit is in the standby mode.

<Standby mode>

```
Base 1
 2 New Calls
 03.08 21:06
```

Press 

<Function menu>

```
New Phonebook
▶ Setting Handset
  Setting Base
```

Press 

- If new incoming/memo message(s) is/are recorded, the function menu will show as follows.

```
Play New Msg
New Phonebook
Setting Handset
Setting Base
```

<Function menu>

Time Alarm	→
Ringer Option	→
Tone Option	→
Display Option	→
Call Option	→
Other Option	→
Registration	→
Select Base	To select the base unit access (p. 81)
Reset Handset	To clear the handset settings (p. 53)

<Function menu>

- ▶Set Alarm Time To set the alarm time (p. 41)
- Alarm ON/OFF To set the alarm ON/OFF (p. 41)

- ▶Ringer Volume To select the handset ringer volume (p. 43)
- Ext Ring Type To select the ringer type for external call (p. 43)
- Int Ring Type To select the ringer type for internal call (p. 43)
- Paging Type To select the ringer type for paging (p. 18)
- Alarm Type To select the ringer type for time alarm (p. 42)
- Private Ring To select the ringer type for private category (p. 25)

- ▶Key Tone ON/OFF To set the key tone ON/OFF (p. 44)
- Call Waiting To set the call waiting tone ON/OFF (p. 44)
- Range Alarm To set the range warning alarm ON/OFF (p. 45)
- Battery Alarm To set the battery low alarm ON/OFF (p. 45)

- ▶Standby Display To select the standby mode display (p. 46)
- Talk Display To select the talk mode display (p. 47)
- Select Language To select the display language (p. 48)
- Backlight Color To select the display backlight colour (p. 49)
- Private Color To select display backlight colour for private category (p. 25)

- ▶Call Bar To set the call prohibition mode ON/OFF (p. 50)
- Direct Call No. To set the direct call number (p. 51)
- Direct ON/OFF To set the direct call mode ON/OFF (p. 51)

- ▶Change Hset PIN To change the 4-digit handset PIN (p. 40)
- Auto Talk To set the auto talk feature ON/OFF (p. 16)
- Battery type To select the battery type (p. 52)

- ▶Register H/set To register a handset in the base unit (p. 80)
- Cancel Base To cancel the base unit (p. 82)

Chapter 3

Programmable Function on the Handset

Handset PIN

Changing the 4-digit Handset PIN











You can program a 4-digit handset PIN (Personal Identification Number). The factory preset is 0000. Changing the PIN may prevent the unauthorised use of your unit by another person.

Once you have programmed the 4-digit Handset PIN, you cannot confirm it. We recommend you to write down your 4-digit Handset PIN. If you forget it, please consult your Panasonic Customer Care Centre.

You need to enter the 4-digit handset PIN for the following functions.

- To set the call prohibition mode ON/OFF (p. 50).
- Reset Handset Settings (p. 53).
- To cancel the base unit (p. 82).

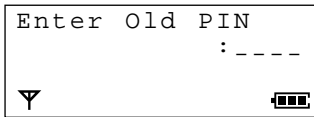

Make sure that the power is ON (p. 12), and the unit is in the standby mode.

- 1 Press .
- 2 Press  or  until the arrow points to "Setting Handset", then press .
- 3 Press  or  until the arrow points to "Other Option", then press .
- 4 Press  or  until the arrow points to "Change Hset PIN", then press .



- 5 Enter the current 4-digit handset PIN.
 - The factory preset is 0000.

- 6 Enter the new 4-digit handset PIN TWICE.

- If you misdial, press . Digits are erased from the right. To erase all digits, press and hold .

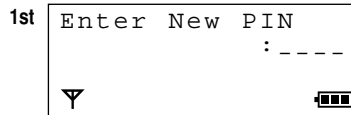

- A beep sounds.
- To return to the standby mode, press  or wait for 60 seconds.
- If 5 beeps sound in step 5, the entered 4-digit handset PIN is incorrect. Enter the correct PIN.

4-digit handset PIN

--	--	--	--

Time Alarm



The handset will sound an alarm at a preset time for 30 seconds just for once or repeated daily. You can also select the ringer type for time alarm (p. 42). If you select the melody for time alarm, the handset will sound longer (It depends on the ringer type). You must set the date and time before setting the alarm time.

Setting the Alarm Time

Make sure that the power is ON (p. 12), and the unit is in the standby mode.

- 1 Press
- 2 Press or until the arrow points to "Setting Handset", then press .
- 3 Press or until the arrow points to "Time Alarm", then press .
- 4 Press or until the arrow points to "Set Alarm Time", then press .
 - The current setting is displayed on the 2nd line.

```
<Enter Time>
- : - -
└─┘
```

- 5 Enter the desired time (hour and minute) using a 4-digit number (24-hour time), then press .

Ex: To set 06:30, enter "0630".

```
<Enter Time>
06:30
└─┘
```

- 6 While "Save" is at the arrow, press .
- 7 Press or to select "Once" or "Repeat Daily".
- 8 Press .
 - A beep sounds.
 - The display will return to "Time Alarm". To return to the standby mode, press or wait for 60 seconds.

Setting the Time Alarm OFF

Make sure that the power is ON (p. 12), and the unit is in the standby mode.

- 1 Follow steps 1 to 3 on Setting the Alarm Time.
- 2 Press or until the arrow points to "Alarm ON/OFF", then press .
- 3 Press or to select "OFF", then press .
 - A beep sounds.
 - The display will return to "Time Alarm". To return to the standby mode, press or wait for 60 seconds.



➔ Time Alarm



Selecting the Ringer Type for Time Alarm



You can select one of 20 ringer types for the time alarm. The factory preset is type 1.

Make sure the the power is ON (p. 12), and the unit is in the standby mode.

1 Press .

2 Press  or  until the arrow points to "Setting Handset", then press .



3 Press  or  until the arrow points to "Ringer Option", then press .

4 Press  or  until the arrow points to "Alarm Type", then press .

- The current setting is at the arrow and rings.

```
Alarm Type
▶Ringer 1
  Ringer 2
▼
```



5 Press  or  to select the desired ringer type.





- Each time you press a button, the selected ringer type sounds.

6 Press .

- A beep sounds.
- The display will return to "Alarm Type". To return to the standby mode, press  or wait for 60 seconds.

- You can exit the programming mode any time by pressing .

To stop the time alarm

When the alarm sounds and "Time Alarm" is displayed, press any dialling button  to , , , or .

- After 30 seconds, the alarm will stop ringing and the display returns to the standby mode.
- If "Once" is selected, the setting is automatically turned off. If "Repeat Daily" is selected, the setting remains and the alarm will repeatedly sound at the setting time.
- If the unit is in the talk, speakerphone or intercom mode during the alarm time, the alarm will not sound. After finishing a conversation, the alarm will start ringing.
- If the alarm sounds during charging, the alarm will stop ringing when you lift the handset from the cradle.

Ringer Option



In "Ringer Option" menu, **Selecting the ringer type for paging (p. 18)**, **To select the ringer type for private category (p. 25)**, and **Selecting the ringer type for time alarm (p. 42)** are also available.

Selecting the Handset Ringer Volume/Type

Make sure that the power is ON (p. 12), and the unit is in the standby mode.

To select the handset ringer volume

7 levels are available. The lowest level is 1. The highest level is 6. The factory preset is 3. When set to OFF, the handset will not ring.

- 1 Press
- 2 Press or until the arrow points to "Setting Handset", then press .
- 3 Press or until the arrow points to "Ringer Option", then press .
- 4 Press or until the arrow points to "Ringer Volume", then press .
 - The current setting is displayed and rings.
- 5 Press or to select the desired level.
 - Each time you press or , the selected volume is displayed and rings.
 - Ex. Level 6 is selected.



- To set to OFF, erase "■" by pressing until "OFF" is displayed.
- 6 Press .
 - A beep sounds.
 - The display will return to "Ringer Volume". To return to the standby mode, press or wait for 60 seconds.
 - When set to OFF, "Ring Off" will be displayed.

To select the handset ringer type for external/internal call

You can select one of 20 ringer types for each external and internal call. The factory preset is type 1.

- 1 Follow steps 1 to 3 of To select the handset ringer volume.
- 2 Press or to select "Ext Ring Type" for external call.
OR
Press or to select "Int Ring Type" for internal call.
- 3 Press .
 - The current setting is at the arrow and rings.
 - Ex. "Ext Ring Type" is selected.

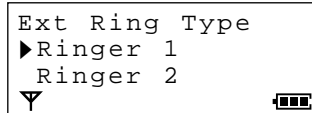

- 4 Press or to select the desired type.
 - Each time you press a button, the selected ringer type sounds.
- 5 Press .
 - A beep sounds.
 - The display will return to step 2. To return to the standby mode, press or wait
- You can exit the programming mode any time by pressing .

Chapter 3













Programmable Function on the Handset

Tone Option

Setting the Key Tone ON/OFF

You can choose whether or not the handset keys will sound (key tone, confirmation tone, error tone). The factory preset is ON.















Make sure that the power is ON (p. 12), and the unit is in the standby mode.

- 1 Press .
- 2 Press  or  until the arrow points to "Setting Handset", then press .
- 3 Press  or  until the arrow points to "Tone Option", then press .
- 4 While "Key Tone ON/OFF" is at the arrow, then press .
 - The current setting is at the arrow.
- 5 Press  or  to select "ON" or "OFF".
- 6 Press .
 - If ON is selected, a beep sounds.
 - The display will return to "Key Tone ON/OFF". To return to the standby mode, press  or wait for 60 seconds.
 - You can exit the programming mode any time by pressing .

Setting the Call Waiting Tone ON/OFF

If an incoming call has been received during an intercom between handsets, a call waiting tone sounds. The factory preset is ON.















Make sure that the power is ON (p. 12), and the unit is in the standby mode.

- 1 Press .
- 2 Press  or  until the arrow points to "Setting Handset", then press .
- 3 Press  or  until the arrow points to "Tone Option", press .
- 4 Press  or  until the arrow points to "Call Waiting", then press .
 - The current setting is at the arrow.
- 5 Press  or  to select "ON" or "OFF".
- 6 Press .
 - A beep sounds.
 - The display will return to "Call Waiting". To return to the standby mode, press  or wait for 60 seconds.
 - You can exit the programming mode any time by pressing .

Setting the Range Warning Alarm ON/OFF

The factory preset is OFF.















Make sure that the power is ON (p. 12), and the unit is in the standby mode.

- 1 Press .
 - 2 Press  or  until the arrow points to "Setting Handset", then press .
 - 3 Press  or  until the arrow points to "Tone Option", then press .
 - 4 Press  or  until the arrow points to "Range Alarm", then press .
 - The current setting is at the arrow.
 - 5 Press  or  to select "ON" or "OFF".
 - 6 Press .
 - A beep sounds.
 - The display will return to "Range Alarm". To return to the standby mode, press  or wait for 60 seconds.
- You can exit the programming mode any time by pressing .

Setting the Battery Low Alarm ON/OFF

The factory preset is ON.

Make sure that the power is ON (p. 12), and the unit is in the standby mode.

- 1 Press .
 - 2 Press  or  until the arrow points to "Setting Handset", then press .
 - 3 Press  or  until the arrow points to "Tone Option", then press .
 - 4 Press  or  until the arrow points to "Battery Alarm", then press .
 - The current setting is at the arrow.
 - 5 Press  or  to select "ON" or "OFF".
 - 6 Press .
 - A beep sounds.
 - The display will return to "Battery Alarm". To return to the standby mode, press  or wait for 60 seconds.
- You can exit the programming mode any time by pressing .

Display Option



In "Display Option" menu, To select the display backlight colour for the private category (p. 25) is also available.



Selecting the Standby Mode Display

You can select whether to display the currently connected base unit number, handset number or no display in the standby mode. The factory preset is the base unit number.

Make sure that the power is ON (p. 12), and the unit is in the standby mode.

1 Press .

2 Press  or  until the arrow points to "Setting Handset", then press .

3 Press  or  until the arrow points to "Display Option", then press .

4 While "Standby Display" is at the arrow, press .

- The current setting is at the arrow.

5 Press  or  to select "Base Number", "Handset Number" or "OFF", then press .

- A beep sounds.
- The display will return to "Standby Display". To turn to the standby mode, press  or wait for 60 seconds.

- You can exit the programming mode any time by pressing .

Ex. "Base Number" is selected.

```
Base 1
10 New Calls
  25.04 15:00
▽ 
```

Ex. "Handset Number" is selected.

```
INT.1
10 New Calls
  25.04 15:00
▽ 
```

Ex. "OFF" is selected.

```
10 New Calls
  25.04 15:00
▽ 
```



Selecting the Talk Mode Display

You can select whether to display the length of the call or the dialled telephone number while in the talk mode. The factory preset is set to show the length of the call.

Make sure that the power is ON (p. 12), and the unit is in the standby mode.

- 1 Press
- 2 Press or until the arrow points to "Setting Handset", then press .
- 3 Press or until the arrow points to "Display Option", then press .
- 4 Press or until the arrow points to "Talk Display", then press .
 - The current setting is at the arrow.
 - "Talk Time": Length of the call
 - "Phone No.": Dialled phone number
- 5 Press or to select "Talk Time" or "Phone No.", then press .
 - A beep sounds.
 - The display will return to "Talk Display". To return to the standby mode, press or wait for 60 seconds.
 - You can exit the programming mode any time by pressing .

During a conversation, the display will be as follows.

"Talk Time" is selected.
(Ex. 1 hour, 30 minutes, 40 seconds.)

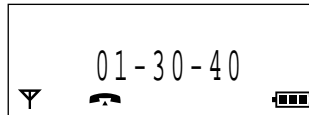

"Phone No." is selected.
(Ex. 123-456-7890)

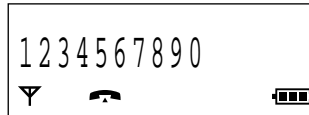















➔ Display Option

Selecting the Display Language

You can choose one of 20 display languages. The factory preset is English.

Make sure that the power is ON (p. 12), and the unit is in the standby mode.

















- 1 Press .
 - 2 Press  or  until the arrow points to "Setting Handset", then press .
 - 3 Press  or  until the arrow points to "Display Option", then press .
 - 4 Press  or  until the arrow points to "Select Language", then press .
 - The current setting is at the arrow.
 - 5 Press  or  to select the desired language, then press .
 - A beep sounds.
 - The display will return to "Select Language". To return to the standby mode, press  or wait for 60 seconds.
- You can exit the programming mode any time by pressing .

Selecting the Display Backlight Colour

You can set the display backlight colour to green, orange, or red. The display backlight will light in the selected colour when pressing a button, lifting the handset from the base unit or receiving a call.

The factory preset is green.

Make sure that the power is ON (p. 12), and the unit is in the standby mode.

- 1 Press .
- 2 Press  or  until the arrow points to "Setting Handset", then press .
- 3 Press  or  until the arrow points to "Display Option", then press .
- 4 Press  or  until the arrow points to "Backlight Color", then press .
 - The current setting is at the arrow.
- 5 Press  or  to select the desired display backlight colour.
 - Each time you press  or , the display backlight colour will change from green, orange to red on the handset.
- 6 Press .
 - A beep sounds.
 - The display will return to "Backlight Color". To return to the standby mode, press  or wait for 60 seconds.
 - You can exit the programming mode any time by pressing .









Call Option









Call Prohibition

You can prohibit anyone from making a call with your handset except for emergency calls (999, 112). Incoming calls are accepted. The factory preset is OFF.



Make sure that the power is ON (p. 12), and the unit is in the standby mode.

To set the call prohibition mode ON/OFF

- 1 Press .
 - 2 Press  or  until the arrow points to "Setting Handset", then press .
 - 3 Press  or  until the arrow points to "Call Option", then press .
 - 4 While "Call Bar" is at the arrow, press .
- Enter H/set PIN : -----

 
- 5 Enter the 4-digit handset PIN (p. 40).
 - The current mode is displayed.
 - 6 Press  or  to select "ON" or "OFF", then press .
 - A beep sounds and " " is displayed if ON is selected.
 - The display will return to "Call Bar". To return to the standby mode, press  or wait for 60 seconds.
 - After returning to the standby mode, " " will go out if OFF is selected.
 - You can exit the programming mode any time by pressing .



















Direct Call

You can easily make a call using a stored direct call number by pressing  or . Incoming calls are accepted. The factory preset is OFF.







After storing the direct call number, the unit will automatically switch to the direct call mode. When the direct call mode is on, you can ONLY dial the number stored in the direct call memory.

Make sure that the power is ON (p. 12), and the unit is in the standby mode.

To set the direct call number

- 1 Press .
- 2 Press  or  until the arrow points to "Setting Handset", then press .
- 3 Press  or  until the arrow points to "Call Option", then press .
- 4 Press  or  until the arrow points to "Direct Call No.", then press .
 - "Enter Phone No" is displayed.
- 5 Enter the phone number up to 24 digits.
 - If you misdial, press . The digits are erased from the right. To erase all digits, press and hold .
- 6 Press .
- 7 While "Save" is at the arrow, press .
- 8 Press  or  to select "ON" or "OFF", then press .
 - A beep sounds.
 - The display will return to "Direct Call No.". To return to the standby mode, press  or wait for 60 seconds. "↳" will be shown at the top right corner on the standby mode display when set to ON.

To set the direct call mode ON/OFF

- 1 Follow steps 1 to 3 on To set the direct call number.
- 2 Press  or  until the arrow points to "Direct ON/OFF", then press .
- 3 Press  or  to select "ON" or "OFF", then press .
 - A beep sounds.
 - The display will return to "Direct ON/OFF". To return to the standby mode, press  or wait for 60 seconds. "↳" will be shown at the top right corner on the standby mode display when set to ON.
 - When set to off, "↳" will go out.

To dial the stored number

Make sure that "↳" is displayed, then press  or .

- The number stored in the direct call memory is automatically dialed.















Other Option

In "Other Option" menu, **Changing the 4-digit handset PIN (p. 40)**, **To set the auto talk feature ON/OFF (p. 16)** are also available.

Selecting the Battery Type

Two Nickel Metal-hydrate (Ni-MH) batteries are included with this unit. Nickel Cadmium (Ni-Cd) rechargeable batteries can also be used. If you replace the batteries with Ni-Cd batteries, you must set the battery type selection to "Ni-Cd", or the battery strength will not be displayed correctly. The factory preset is "Ni-MH".

Make sure that the power is ON (p. 12), and the unit is in the standby mode.

- 1 Press .
- 2 Press  or  until the arrow points to "Setting Handset", then press .
- 3 Press  or  until the arrow points to "Other Option", then press .
- 4 Press  or  until the arrow points to "Battery Type", then press .
 - The current battery type is at the arrow.
- 5 Press  or  to select "Ni-Cd" or "Ni-MH", then press .
 - The display will return to the "Battery Type". To return to the standby mode, press  or wait for 60 seconds.
 - Incorrect battery type selection may shorten battery life.

Reset Handset Settings

This function enables the handset to clear the following setting at one time. They will return to their initial settings.







Function	Initial setting
Time alarm mode	OFF
Alarm time	clear
Handset ringer volume	3 (MEDIUM)
External ringer type	1
Internal ringer type	1
Alarm type	1
Paging ringer type	1
Private ringer type	1
Key tone	ON
Call waiting tone	ON
Range warning alarm	OFF
Battery low alarm	ON
Standby mode display	Base unit number

Function	Initial setting
Talk mode display	Length of the call
Call prohibition mode	OFF
Display language	English
Backlight colour	Green
Private colour	Green
Direct call number	Clear
Direct call mode	OFF
4-digit handset PIN	0000
Auto talk	OFF
Base unit access	Automatic base unit access
Handset receiver volume	MEDIUM
Redial memory	All clear





Chapter 3

Programmable Function on the Handset

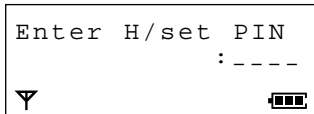
Make sure that the power is ON (p. 12), and the unit is in the standby mode.

- 1 Press .
- 2 Press  or  until the arrow points to "Setting Handset", then press .
- 3 Press  or  until the arrow points to "Reset Handset", then press .



- 4 Enter the 4-digit handset PIN (p. 40).
 - "Reset Handset" is displayed.
 - 5 Press  or  to select "YES".
 - 6 Press .
 - A beep sounds and "CLEARED" is displayed.
 - The display will return to "Reset Handset". To return to the standby mode, press  or wait for 60 seconds.
- You can exit the programming mode any time by pressing .

Summary of Programmable Functions on the Base Unit

You can select and execute answering system by pressing direct command as follows without programming. See the corresponding pages for function details.

Make sure that the power is ON (p. 12), and the unit is in the standby mode.

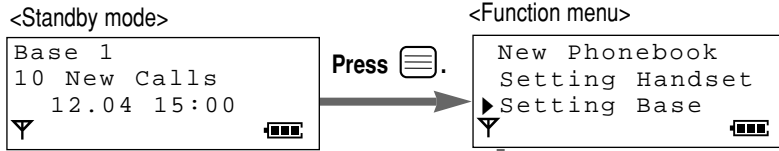

Press .

•“Input Command” is displayed.

<Direct command>

Press 1 , 4-digit base unit PIN, then 1	To select the all handsets ringer mode (p. 56)
Press 1 , 4-digit base unit PIN, then 2	To select the selected handset(s) ringer mode (p. 56)
Press 1 , 4-digit base unit PIN, then 3	To select the selected then all handsets ringer mode (p. 57)
Press 2 then 2	To select the base unit ringer volume (p. 58)
Press 3 , 4-digit base unit PIN, then 2	To select the Time Break Recall/earth mode (p. 59)
Press 3 , 4-digit base unit PIN, then 3	To select the pause timing (p. 60)
Press 5 then 4-digit base unit PIN	To change the 4-digit base unit PIN (p. 55)
Press 6 then 4-digit base unit PIN	To set the call restriction (p. 61)
Press 7 then 4-digit base unit PIN	To cancel the handset registration in the base unit (p. 82)
Press 0 then 4-digit base unit PIN	To reset the base unit settings (p. 63)
Press *	To set the date/time (p. 64)
Press then 1	To set the remote code (p. 76)
Press then 2	To select the number of rings (p. 73)
Press then 3	To select the caller's recording time (p. 74)
Press then 4	To set the greeting monitor function ON/OFF (p. 74)

Base Unit PIN

Setting the 4-digit Base Unit PIN





You can program a 4-digit base unit PIN (Personal Identification Number). The factory preset is 0000. Changing the PIN may prevent the unauthorised use of your unit by another person.

Once you have programmed the 4-digit base unit PIN, you cannot confirm it. We recommend you to write down the 4-digit base unit PIN. If you forget it, please consult your Panasonic Customer Care Centre.

You need to enter the 4-digit base unit PIN when using the following functions.

- Ringer Mode Selection (p. 56, 57)
- Selecting Time Break Recall/Earth Mode (p. 59)
- Selecting the Pause Timing (p. 60)
- Call Restriction (p. 61)
- Cancelling a Handset Registration in the Base Unit (p. 82)
- Reset the Base Unit Settings (p. 63)

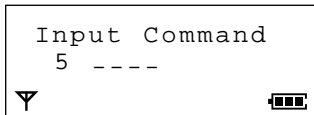

Make sure that the power is ON (p. 12), and the unit is in the standby mode.

- 1 Press .
- 2 Press  or  until the arrow points to "Setting Base", then press .
 - "Input Command" is displayed.
- 3 Press , then enter the current 4-digit base unit PIN.
 - The factory preset is 0000.

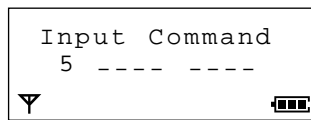

- 4 Enter the new 4-digit base unit PIN TWICE.



- A beep sounds.
- The display will return to "Setting Base". To return to the standby mode, press  or wait for 60 seconds.
- If 5 beeps sound in step 3, the entered 4-digit base unit PIN is incorrect. Enter the correct 4-digit base unit PIN.
- You can exit the programming mode any time by pressing .

4-digit handset PIN

--	--	--	--

Ringer Mode Selection









You can select one of 3 base unit ringer modes.

- **All handsets:** All handsets registered in the base unit ring at the same time.
- **Selected handset(s):** The only selected handset(s) ring(s) at the same time.
- **Selected then all handsets:** The selected handset(s) ring(s) first, then if no answer, all handsets start ringing.

The factory preset is All handsets.

Selecting the All Handsets Ringer Mode



Make sure that the power is ON (p. 12), and the unit is in the standby mode.

- 1 Press .
- 2 Press  or  until the arrow points to "Setting Base", then press .
 - "Input Command" is displayed.
- 3 Press , then enter the 4-digit base unit PIN (p. 55).
 - The current mode is displayed.
- 4 Press .
- 5 Press .
 - A beep sounds.
 - The display will return to "Setting Base". To return to the standby mode, press .

Selecting the Selected Handset(s) Ringer Mode

Make sure that the power is ON (p. 12), and the unit is in the standby mode.





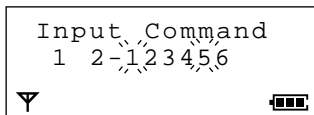

- 1 Follow steps 1 to 3 on Selecting the All Handsets Ringer Mode.
- 2 Press , then select handset number(s) you desire to ring.
 - The selected handset number(s) blink(s).





Ex. All registered handset number (1 to 6) is displayed and selected handset numbers (1 and 5) blink.
- 3 Press .
 - A beep sounds.
 - The display will return to "Setting Base". To return to the standby mode, press .



Selecting the Selected then All Handsets Ringer Mode

Make sure that the power is ON (p. 12), and the unit is in the standby mode.

- 1 Press .
- 2 Press  or  until the arrow points to "Setting Base", then press .
 - "Input Command" is displayed.
- 3 Press , then enter the 4-digit base unit PIN (p. 55).
 - The current mode is displayed.
- 4 Press , then select handset number(s) you desire to ring first.
 - The selected handset number(s) blink(s).

Ex. All registered handset number (1 to 6) is displayed and selected handset numbers (1 and 5) to ring first blink.
- 5 Press .
 - The current number of rings is displayed at the end of the 2nd line.
- 6 Select the number of rings 1 through 6 with the dialling buttons  to , then press .
 - A beep sounds.
 - The display will return to "Setting Base". To return to the standby mode, press .

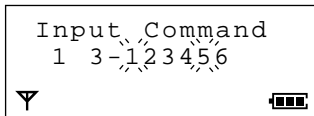



Base Unit Ringer Volume

Selecting the Base Unit Ringer Volume

4 levels (HIGH, MEDIUM, LOW, OFF) are available. The factory preset is MEDIUM. When set to OFF, the base unit will not ring.

Make sure that the power is ON (p. 12), and the unit is in the standby mode.



1 Press .

2 Press  or  until the arrow points to "Setting Base", then press .

- "Input Command" is displayed.

3 Press  TWICE.

- The current ringer volume is displayed.
1: LOW 2: MEDIUM 3: HIGH 0: OFF

4 Select your desired ringer volume 0 through 3 with dialling button  through .

- Each time you press a button, the selected volume level is displayed and rings.

Ex. 3 (HIGH) is selected.

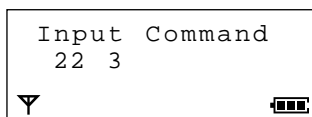

5 Press .









- A beep sounds.
- The display will return to "Setting Base". To return to the standby mode, press .

Other Feature



Selecting Time Break Recall/Earth (Option) Mode



The earth relay can be installed as an option depending on your PBX requirements. Please consult your Panasonic Customer Care Helpline for installation, then you can select the time break recall or earth mode. The factory preset is time break recall.

Make sure that the power is ON (p. 12), and the unit is in the standby mode.

- 1 Press .
- 2 Press  or  until the arrow points to "Setting Base", then press .
 - "Input Command" is displayed.
- 3 Press , then enter the 4-digit base unit PIN (p. 55).
- 4 Press  then  for time break recall mode.
OR
Press  then  for earth mode.
 - The current setting is displayed.
 Ex. Earth is selected.

Input Command
3 2 2

- 5 Press .
 - A beep sounds.
 - The display will return to "Setting Base". To return to the standby mode, press .



➔ Other Feature

Selecting the Pause Timing

You can select the pause timing of 3 or 5 seconds, depending on your PBX requirement. Please consult your Panasonic Customer Care Centre for installation. The factory preset is 3 seconds.

Make sure that the power is ON (p. 12), and the unit is in the standby mode.

1 Press .

2 Press  or  until the arrow points to "Setting Base", then press .

- "Input Command" is displayed.

3 Press , then enter the 4-digit base unit PIN (p. 55).

4 Press  then  for 3 seconds.

OR

Press  then  for 5 seconds.

Ex. 5 seconds is selected.

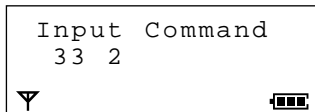

5 Press .

- A beep sounds.
- The display will return to "Setting Base". To return to the standby mode, press .

Call Restriction



You can restrict desired handset(s) from dialling selected phone numbers. Phone numbers beginning with the restricted digits cannot be dialled out. For example, if "00" is assigned as the call restriction number, international calls cannot be made.

For selected handset(s), you can assign up to 6 call restriction numbers (up to 8 digits). The factory preset is OFF.

Setting the Call Restriction

Make sure that the power is ON (p. 12), and the unit is in the standby mode.

1 Press .

2 Press or until the arrow points to "Setting Base", then press .

- "Input Command" is displayed.

3 Press , then enter the 4-digit base unit PIN (p. 55).

- All registered handset number(s) is/are displayed.
- The handset number(s) flash(es) if the call restriction number(s) is/are already stored. Ex. 6 handsets are registered.

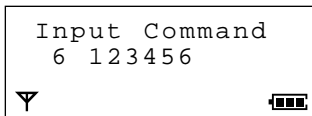

4 Enter the handset number(s) which you desire to restrict.

- The selected handset number(s) flash(es).
- If you misdial, press the number(s) again.

Ex. Handset number 5 is selected.

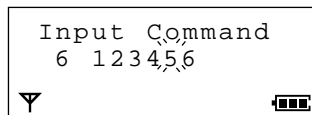

5 Press .

6 Enter a call restriction number, up to 8 digits.

- If you misdial, press . The digits are erased from the right. To erase all digits, press and hold .

7 Press .

- A beep sounds.
- If you desire to set another call restriction, follow steps 6 to 7. If you finish, go to step 8.

8 Press .

- The display will return to "Setting Base". To return to the standby mode, press .
- You can exit the programming mode any time by pressing .

When you dial a restricted number

The call is not succeeded, and the dialled number flashes.

Ex. The restricted number is "00".





➔ Call Restriction

To cancel the call restricted handset(s)

1 Follow steps 1 to 3 on Setting the Call Restriction, then enter the handset number(s) you desire to cancel.

- The cancelled handset number(s) stop(s) flashing.

2 Press  repeatedly until "Setting Base" is displayed.



- To return to the standby mode, press .

- You can exit the programming mode any time by pressing .

To cancel the call restriction number(s)

1 Follow steps 1 to 3 on Setting the Call Restriction, then select the call restricted handset press .

2 Press .

3 Press  repeatedly until the call restriction number you desire to cancel is displayed, then erase the number by pressing .

- The call restriction number is cleared.

4 Press  repeatedly until "Setting Base" is displayed.

- To return to the standby mode, press .

- You can exit the programming mode any time by pressing .





Reset the Base Unit Settings

This function enables the base unit to clear the following settings at one time. They will return to their initial settings.



Function	Initial setting
Ringer mode selection	All handsets
Number of rings (Selected then all handsets)	3
Earth/Time Break Recall	Time Break Recall
Flash timing	80m seconds
Pause timing	3 seconds

Function	Initial setting
Call restricted handset(s)	All clear
Call restriction number(s)	All clear
4-digit base unit PIN	0000
Base unit ringer volume	2 (MEDIUM)

Make sure that the power is ON (p. 12), and the unit is in the standby mode.

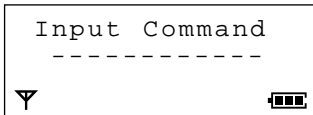
- 1 Press .
- 2 Press  or  until the arrow points to "Setting Base", then press .
 - "Input Command" is displayed.
- 3 Press , then enter the 4-digit base unit PIN (p. 55).



- 4 Press .
 - A beep sounds.
 - The display will return to "Setting Base". To return to the standby mode, press .
- You can exit the programming mode any time by pressing .



Date and Time

For using Voice Date/Time Stamp in answering system operation, you must set the current date and time.

Setting the Current Time

Make sure that the power is ON (p. 12), and the unit is in the standby mode.

1 Press .

2 Press  or  until the arrow points to "Setting Base", then press .

- "Input Command" is displayed.

3 Press .

4 Enter the current time (hour and minute) using 4-digit number.

- The entered numbers are displayed.
Ex. 1805 is entered for 18:05.

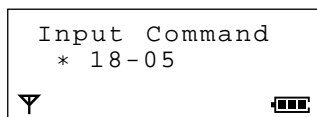

5 Press .

- A beep sounds.
- The display will return to "Setting Base". To return to the standby mode, press .

Setting the Current Date

Make sure that the power is ON (p. 12), and the unit is in the standby mode.

1 Follow steps 1 to 3 on Setting the Current Time, then press .

2 Enter the current date (day, month and year) using 6-digit number.

- The entered numbers are displayed.
Ex. 160201 is entered for February 16th, 2001.

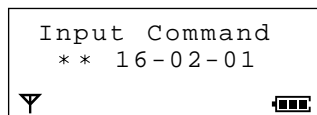

3 Press .

- A beep sounds.
- The display will return to "Setting Base". To return to the standby mode, press .

Summary of Answering System Operations

See corresponding pages for function details.

Make sure that the power is ON (p. 12), and the unit is in the standby mode.

<Standby mode>

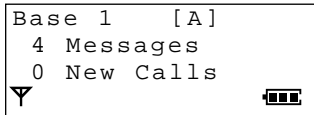

Press **INT** then **[]**.

- **[]** lights and voice guidance is heard from the speaker.
- Message information is displayed for 2 seconds, then function menu is displayed.
- A brief voice guidance indicates the number of new message received, then you can hear "Press 4 to playback new messages" and "Press 5 to playback all messages."

<Function menu>

▶ Repeat Msg*	To repeat an/a incoming/memo message during playback (p. 71)
Skip Msg*	To skip an/a incoming/memo message during playback (p. 71)
Receiver Volume	To select the receiver volume during playback (p. 73)
Play New Msg	To playback new incoming/memo message(s) (p. 69)
Play All Msg	To playback all incoming/memo message(s) (p. 69)
Play OGM	To playback a greeting message (p. 13, 68)
Record	To record a greeting/memo message (p. 67, 70)
Answer ON	To set the answering system ON (p. 13, 68)
Stop	To stop the answering system operation (p. 71)
Answer OFF	To set the answering system OFF (p. 13, 68)
Erase One Msg*	To erase one incoming/memo message (p. 69)
Erase All Msg	To erase all incoming/memo message(s) (p. 70)
Erase OGM**	To erase the recorded greeting message (p. 68)

* These functions are available only during incoming/memo message playback.

** This function is available only during your own greeting message playback.

- If each operation procedure is not completed within 30 seconds, the display will return to the standby mode.

Summary of Direct Command for Answering System Operations

See the corresponding pages for function details.

Make sure that the power is ON (p. 12), and the unit is in the standby mode.

<Standby mode>

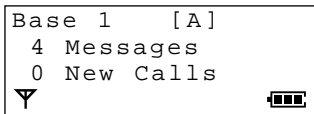

Press **INT** then **[]**.

- **[]** lights and voice guidance is heard from the speaker.
- Message information is displayed for 2 seconds, then function menu is displayed.
- A brief voice guidance indicates the number of new message received, then you can hear "Press 4 to playback new messages" and "Press 5 to playback all messages."

<Direct command>

◀	Press [1]	To repeat an/a incoming/memo message during playback (p. 71)
▶	Press [2]	To skip an/a incoming/memo message during playback (p. 71)
	Press [3]	To select the receiver volume during playback (p. 73)
▶	Press [4]	To playback new incoming/memo message(s) (p. 69)
▶ALL	Press [5]	To playback all incoming/memo message(s) (p. 69)
☎	Press [6]	To playback a greeting message (p. 13, 68)
● ▶	Press [7][4]	To record a memo message (p. 70)
● ☎	Press [7][6]	To record a greeting message (p. 67)
☎ON	Press [8]	To set the answering system ON (p. 13, 68)
■	Press [9]	To stop the answering system operation (p. 71)
☎OFF	Press [0]	To set the answering system OFF (p. 13, 68)
× ▶	Press [*][4]	To erase one incoming/memo message* (p. 69)
× ▶ALL	Press [*][5]	To erase all incoming/memo message(s) (p. 70)
× ☎	Press [*][6]	To erase the recorded greeting message** (p. 68)

* These functions are available only during incoming/memo message playback.

** This function is available only during your own greeting message playback.

- If each operation procedure is not completed within 30 seconds, the display will return to standby mode.

Answering System Operations

For basic answering system operation, see page 13.

You can operate the answering system by function menu or by pressing dialling button as direct command. All messages (greeting, incoming, and memo) are stored indefinitely on a "Flash memory" IC chip – even if a power failure occurs. All of the messages are saved until you erase them – **Flash Memory Message Backup**.

Greeting Message

The total recording time is approximately 15 minutes. Any recorded noise may shorten the recording time up to 3 minutes. The greeting recording time is limited to 2 minutes and 30 seconds. We recommend you to record a brief greeting message in order to leave more time for recording new incoming/memo messages.

Make sure that the power is ON (p. 12), and the unit is in the standby mode.

To record your own greeting message with function menu

- 1 Press **[INT]** then **[☐]**.
- 2 Press **[▼]** or **[▲]** until the arrow points to "Record", then press **[▶]**.
- 3 While "Record OGM" is at the arrow, press **[▶]**.
- 4 After the long beep, talk clearly, about 20 cm away from the MIC (microphone) on the handset.

- During recording, the arrow points to "Stop".

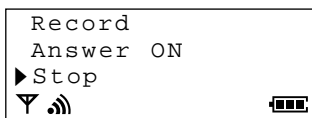

- 5 When finish recording, press **[☰]**.
 - A recorded your own greeting message is played back.
 - The display will return to "Remote Operation". To return to the standby mode, press **[☒]** or wait for 30 seconds.

To record your own greeting message with direct command

- 1 Press **[INT]** then **[☐]**.
- 2 Press **[7]** then **[6]**.
- 3 After the long beep, talk clearly, about 20 cm away from the MIC (microphone) on the handset.
 - The display will start showing the length of the recording time.

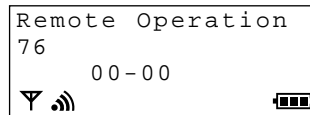

- 5 When finish recording, press **[9]**.
 - A recorded your own greeting message is played back.
 - The display will return to "Remote Operation". To return to the standby mode, press **[☒]** or wait for 30 seconds.

➔ Answering System Operations

To playback your own greeting message

- 1 Press **[INT]** then **[□]**.
- 2 Press **[▼]** or **[▲]** until the arrow points

to "Play OGM", then press **[▶]**.

OR

Press **[6]**.

- A recorded your own greeting message is played back.
- If your own greeting message is not recorded, one of 2 pre-recorded greeting messages is played back.
- The display will return to "Remote Operation". To return to the standby mode, press **[*0]** or wait for 30 seconds.

To set the answering system ON/OFF

See basic answering system operations (p. 13).

- 1 Press **[INT]** then **[□]**.
- 2 Press **[8]** to set ON, or press **[0]** to set OFF.

- "[A]" is displayed if set to ON.
- The display will return to "Remote Operation". To return to the standby mode, press **[*0]** or wait for 30 seconds.

To erase your own greeting message with function menu

- 1 During playback your own greeting message, press **[▶]**.
- 2 Press **[▼]** or **[▲]** until the arrow points to "Erase OGM", then press **[▶]**.
- 3 Press **[▼]** or **[▲]** to select "Yes", then press **[☰]**.

- A recorded your own greeting message is erased.
- The display will return to "Remote Operation". To return to the standby mode, press **[*0]** or wait for 30 seconds.

To erase your own greeting message with direct command

- 1 During playback your own greeting message, press **[▶]**.
- 2 Press **[*]** then **[6]**.
 - A recorded your own greeting message is erased.
 - The display will return to "Remote Operation". To return to the standby mode, press **[*0]** or wait for 30 seconds.



Incoming/Memo Message

Incoming messages and memo messages are stored in chronological order. New messages cannot be recorded when "Memory is Full" is heard. We recommend you to erase unnecessary message after each playback in order to leave more time for recording new incoming/memo message(s).

Make sure that the power is ON (p. 12), and the unit is in the standby mode.

To playback new incoming/memo message(s)

- 1 Press **[INT]** then **[□]**.
- 2 Press **[▼]** or **[▲]** until the arrow points to "Play New Msg", then press **[☰]**.
OR
Press **[4]**.
 - New incoming/memo message(s) is/are played back from the speaker on the handset if recorded.
 - The unit will announce the remaining recording time after playback.
 - The display will return to "Remote Operation". To return to the standby mode, press **[*⓪]** or wait for 30 seconds.

To erase one incoming/memo message with function menu

- 1 During playback an/a incoming/memo message, press **[▶]**.
- 2 Press **[▼]** or **[▲]** until the arrow points to "Erase One Msg", then press **[▶]**.
- 3 Press **[▼]** or **[▲]** to select "Yes", then press **[☰]**.
 - One incoming/memo message is erased.
 - The display will return to "Remote Operation". To return to the standby mode, press **[*⓪]** or wait for 30 seconds.

To playback all incoming/memo message(s)

- 1 Press **[INT]** then **[□]**.
- 2 Press **[▼]** or **[▲]** until the arrow points to "Play All Msg", then press **[☰]**.
OR
Press **[5]**.
 - All incoming/memo message(s) is/are played back from the speaker on the handset if recorded.
 - The unit will announce the remaining recording time after playback.
 - The display will return to "Remote Operation". To return to the standby mode, press **[*⓪]** or wait for 30 seconds.

To erase one incoming/memo message with direct command

- 1 During playback an/a incoming/memo message, press **[▶]**.
- 2 Press **[*]** then **[4]**.
 - One incoming/memo message is erased.
 - The display will return to "Remote Operation". To return to the standby mode, press **[*⓪]** or wait for 30 seconds.

➔ Answering System Operations

To erase all incoming/memo message(s) with function menu

- 1 Press **[INT]** then **[☐]**.
- 2 Press **[▼]** or **[▲]** until the arrow points to "Erase All Msg", then press **[▶]**.
- 3 Press **[▼]** or **[▲]** to select "Yes", then press **[☐]**.
 - All incoming/memo message(s) is/are erased.
 - The display will return to "Remote Operation". To return to the standby mode, press **[*0]** or wait for 30 seconds.

To record a memo message with function menu

- 1 Press **[INT]** then **[☐]**.
- 2 Press **[▼]** or **[▲]** until the arrow points to "Record", then press **[▶]**.
- 3 Press **[▼]** or **[▲]** to select "Record Memo", then press **[▶]**.
- 4 After the long beep, talk clearly, about 20 cm away from the MIC (microphone) on the handset.
 - During recording, the arrow points to "Stop".

Record
Answer ON
▶Stop
📶 🔋
- 5 When finish recording, press **[☐]**.
 - A beep sounds.
 - The display will return to "Remote Operation". To return to the standby mode, press **[*0]** or wait for 30 seconds.

To erase all incoming/memo message(s) with direct command

- 1 Press **[INT]** then **[☐]**.
- 2 Press **[*]** then **[5]**.
 - All incoming/memo message(s) is/are erased.
 - The display will return to "Remote Operation". To return to the standby mode, press **[*0]** or wait for 30 seconds.

To record a memo message with direct command

- 1 Press **[INT]** then **[☐]**.
- 2 Press **[7]** then **[4]**.
- 3 After the long beep, talk clearly, about 20 cm away from the MIC (microphone) on the handset.
 - The display will start showing the length of the recording time.

Remote Operation
74
00-00
📶 🔋
- 4 When finish recording, press **[9]**.
 - A beep sounds.
 - The display will return to "Remote Operation". To return to the standby mode, press **[*0]** or wait for 30 seconds.



During Playback an/a Incoming/Memo Message

To repeat a message

Press to display "Repeat Msg", then press .

OR

Press .

- If you press within 5 seconds from start playback, the previous message will be played.
- If you press over 5 seconds from start playback, the current message will be played.
- The display will return to "Remote Operation". To return to the standby mode, press or wait for 30 seconds.

To skip a message

Press . Press or until the arrow points to "Skip Msg", then press .

OR

Press .

- The next message will be played if recorded.
- The display will return to "Remote Operation". To return to the standby mode, press or wait for 30 seconds.

During Playback an/a Greeting/Incoming/Memo Message

To stop answering system operation

Press . Press or until the arrow points to "Stop", then press .

OR

Press .

- The display will return to "Remote Operation". To return to the standby mode, press or wait for 30 seconds.

Quick Play New Message

Make sure that the power is ON (p. 12), and the unit is in the standby mode.

1 Press .

- If new message(s) is/are recorded, "Play New Msg" is displayed and pointed by arrow.

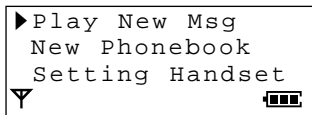

2 Press .

- New message(s) is/are played back.
- The unit will announce the remaining recording time after playback.
- The display will return to "Remote Operation". To return to the standby mode, press or wait for 30 seconds.

➔ Answering System Operations

Recording Your Telephone Conversation Using the Handset

You can record a telephone conversation.

1 During a conversation, press  then .

- "Recording" is displayed on the handset.

2 Continue your conversation.



3 When finished, press  then .

- When you record your 2-way telephone conversation, you should inform the other party that the conversation is being recorded.
- A beep sounds every 15 seconds.

Setting the VOX SENS Function

The VOX SENS function is preset is 1 (HIGH). If the unit continues to operate after a caller hangs up or there are long pauses between or after messages, set to 2 (LOW).

1 Press .

2 Press  or  until the arrow points to "Setting Base", then press .

- "Input Command" is displayed.

3 Press .

- "Remote Operation" is displayed on the handset.

5 Press .

6 To set to LOW, press .

OR

To set to HIGH, press .

- The setting is displayed.

7 Press .

- The display will return to "Setting Base". To return to the standby mode, press .



Selecting Receiver Volume During Playback

- 1 Press . Press or until the arrow points to “Receiver Volume”, then press .
OR
Press .
- 2 Press to decrease volume, or press to increase volume.



- Each time you press or , the volume level will change.

Selecting the Number of Rings

You can select the number of times the unit rings before the answering system answers a call, from 2 to 7 or AUTO (for Toll Saver*). The factory preset is AUTO.

Make sure that the power is ON (p. 12), and the unit is in the standby mode.

- 1 Press .
- 2 Press or until the arrow points to “Setting Base”, then press .
 - “Input Command” is displayed.
- 3 Press .
 - “Remote Operation” is displayed on the handset.
- 4 Press .
- 5 Press dialling button , or to to set the number of rings.
 - 0: Selects “AUTO”.
 - 2-7: The unit will answer after the selected number of rings.

- 6 Press .

- The display will return to “Setting Base”. To return to the standby mode, press .

*Toll Saver (When set to “AUTO”)

When you call the unit from a touch tone telephone:

If the unit answers on the 2nd ring, there is at least one new message.

If the unit answers on the 5th ring, there are no new messages.











Hang up when you hear the 3rd ring. This will save you the toll charge for the call.

➔ Answering System Operations

Selecting the Caller's Recording Time

You can select "1 minute", "unlimited (16 minutes)" or "greeting only" for the caller's recording time. The factory preset is "unlimited". A pre-recorded greeting message (p. 13) depends on selecting the caller's recording time. If you select "greeting only" and set the answering system ON, the unit will answer a call with the greeting message, then hang up. The unit does not record any incoming messages.











Make sure that the power is ON (p. 12), and the unit is in the standby mode.

- 1 Press .
- 2 Press  or  until the arrow points to "Setting Base", then press .
 - "Input Command" is displayed.
- 3 Press .
 - "Remote Operation" is displayed.
- 4 Press .
 - The current setting is displayed.
- 5 Press ,  or  to select the recording time.
 - 1: 1 minute 2: unlimited 3: greeting only
 - The setting is displayed.
- 6 Press .
 - The display will return to "Setting Base". To return to the standby mode, press .

Setting the Monitor Function ON/OFF

When your greeting message is being played to the caller, you can listen to it through the handset. To listen to your greeting, set to 2 (ON). The factory preset is 2 (ON).

Make sure that the power is ON (p. 12), and the unit is in the standby mode.

- 1 Press .
- 2 Press  or  until the arrow points to "Setting Base", then press .
 - "Input Command" is displayed.
- 3 Press .
 - "Remote Operation" is displayed.
- 4 Press .
 - The current setting is displayed.
- 5 To set to ON, press .
OR
To set to OFF, press .
 - The setting is displayed.
- 6 Press .
 - The display will return to "Setting Base". To return to the standby mode, press .

Remote Operation from a Touch Tone Phone ➡

You can operate the answering system from any touch tone phone.

To operate the unit remotely, you must store your remote code first using the handset near the base unit (p. 76).

A synthesised voice menu will guide you on how to operate the unit (p. 77).

- To skip the voice menu and operate the unit directly, see page 78.

Summary of remote operation

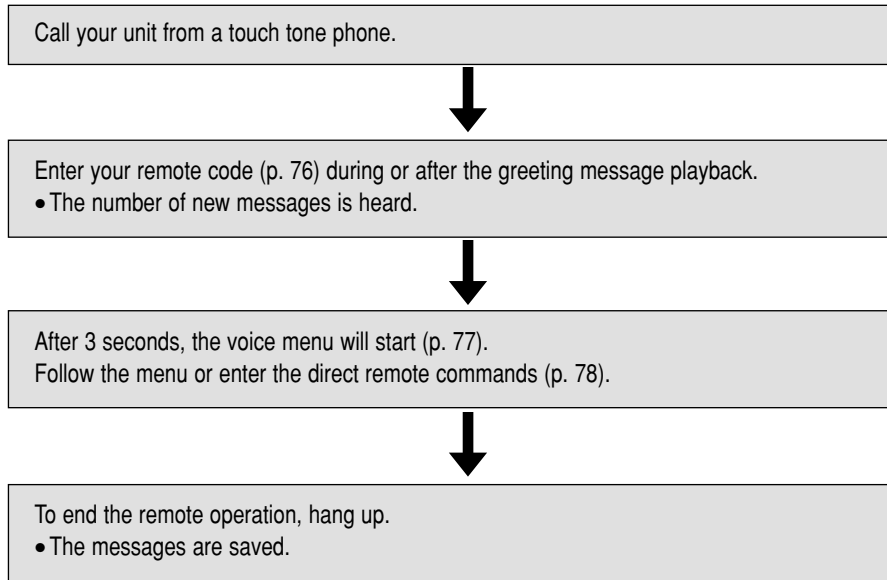









➔ Remote Operation from a Touch Tone Phone

Setting the Remote Code

The 3-digit remote code prevents unauthorised use of your unit for listening recorded incoming/memo messages. The remote code is not preset.

Make sure that the power is ON (p. 12), and the unit is in the standby mode.

- 1 Press .
 - 2 Press  or  until the arrow points to "Setting Base", then press .
 - "Input Command" is displayed.
 - 3 Press .
 - "Remote Operation" is displayed.
 - 4 Press .
- 5 Enter a 3-digit remote code number to set the remote operation ON.
OR
Press  to set the remote operation OFF.
 - 6 Press .
 - A beep sounds.
 - To change the remote code, repeat from step 2.
 - If 5 beeps sound in step 5, a 3-digit number was not entered. Start again from step 2 and enter a 3-digit number.
 - If a remote code is not programmed, you cannot use the unit remotely.



Voice Menu

The shaded boxes are voice prompts.

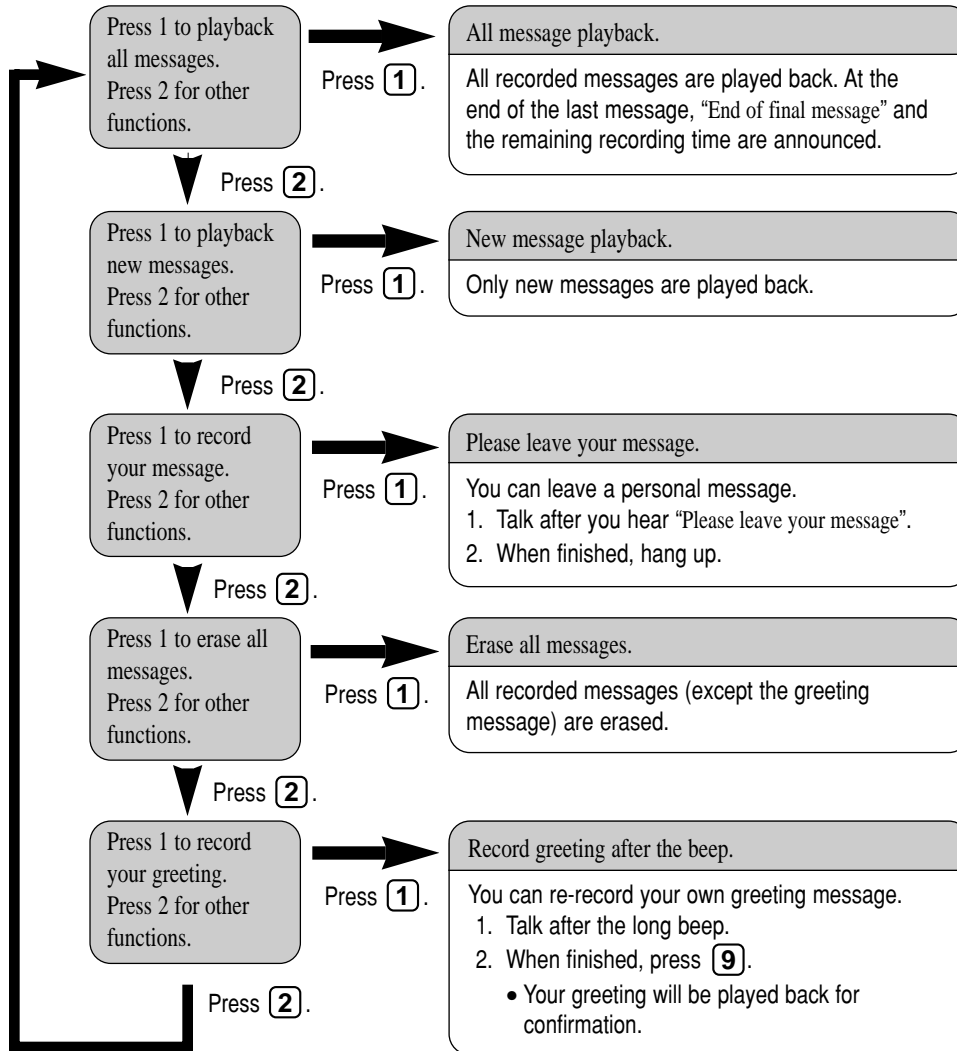

- 3 seconds after playback, the voice menu will start again from the beginning.
- If you hear "Memory is full" after playback, erase some or all of the messages (p. 78).

➔ Remote Operation from a Touch Tone Phone

Direct Remote Operation

Once you have entered the remote code, you can also control your unit by direct commands instead of using the voice menu. Hang up anytime to end the remote operation.

Direct commands

<p>4 NEW MESSAGE PLAYBACK</p> <ul style="list-style-type: none"> • Only new messages are played back. 	<p>*4 ERASING A SPECIFIC MESSAGE (During playback)</p> <ul style="list-style-type: none"> • The current message is erased. • A short beep will sound and the next message will be played.
<p>5 ALL MESSAGE PLAYBACK</p> <ul style="list-style-type: none"> • All messages are played back. 	
<p>1 REPEAT (During playback)</p> <ul style="list-style-type: none"> • The current message is repeated. 	<p>*5 ERASING ALL MESSAGES</p> <ul style="list-style-type: none"> • All recorded messages are erased. • A long beep sounds and "No message" is heard.
<p>2 SKIP (During playback)</p> <ul style="list-style-type: none"> • The current message is skipped. The next message is played. 	
<p>9 STOP (During playback)</p>	<p>*6 ERASING GREETING MESSAGE</p>
<p>7 GREETING MESSAGE RECORDING</p> <p>↓</p> <p>RECORD • Talk immediately after the long beep.</p> <p>↓</p>	
<p>9</p> <ul style="list-style-type: none"> • The recording is stopped. • The recorded message is played. 	<p>0 ANSWERING SYSTEM OFF</p> <ul style="list-style-type: none"> • "Answer off" is heard. • The unit hangs up and will not answer calls until turned on again.
	<p>*□ DISCONNECT</p> <ul style="list-style-type: none"> • The call is terminated and messages will be saved.

Turning on the answering system

- 1 Call your unit and wait for 20 rings.**
- 2 Press the remote code within 10 seconds after the long beep.**
 - The unit will answer and the greeting message will be played.
 - The answering system will turn on. Hang up or enter the remote code for other options.
 - When turning on the answering system using a rotary or pulse service telephone, you cannot enter the remote code for other options.
 - If your remote code is not stored, you cannot turn on the answering system remotely.

Optional Multi-Unit User Operations

Operating More than One Handset

You can register and operate up to 6 handsets at the base unit. Operating more than one handset allows you to have an internal call while simultaneously conducting an external phone call using another handset.

Ex. 6 optional handsets are added to a base unit. Handset 1 is engaged in an internal call with handset 3. Handset 2 is engaged in an external call.

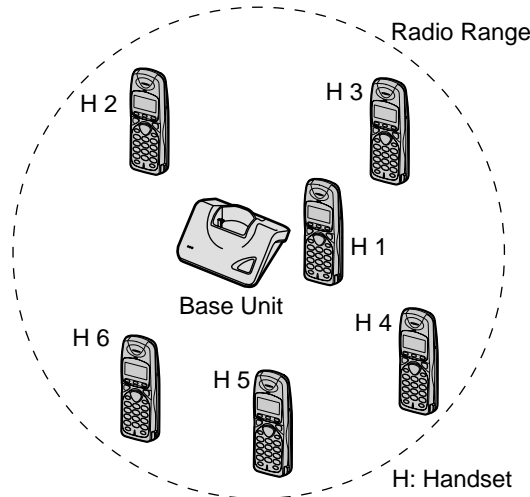

- The optional handset model number is KX-A118EX. The functions of the optional handset are the same as those of the KX-TCD725EM handset.

Operating More than One Base Unit

You can register and operate your handset at up to 4 base units.

Since each base unit forms a radio cell, you can extend the range or area in which you can make/answer calls with the same handset by placing the base units in suitable locations. For example, you can use a handset in different radio areas, such as at home or the office. However, calls in progress are cancelled when the unit moves to another radio area.

Ex. 3 optional KX-A118EX handsets are added to 2 base units.

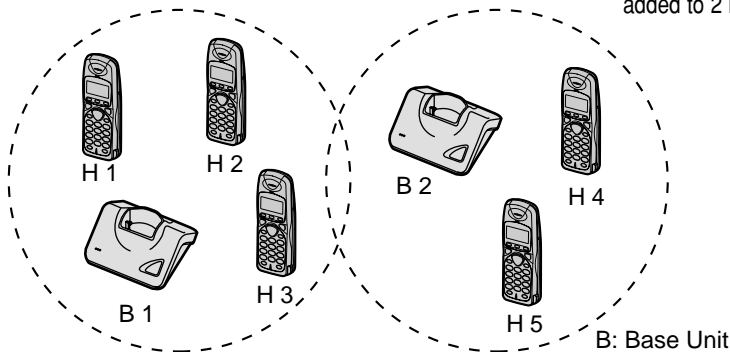

Registration

Registering a Handset in the Base Unit

You must register the handset in the base unit before use.

- Charge the optional handset batteries for approximately 15 hours before initial use.
- Make sure that the power is ON (p. 12) and the unit is in the standby mode.
- Register the handset number within 1 minute. If not registered within 1 minute, press  on the handset to cancel the programming mode. Then start over again from step 1.

1 Handset:



Press .

2 Press or until the arrow points to "Setting Handset", then press .

3 Base unit where handset is to be registered :

Press and hold  on the base unit for more than 10 seconds until a confirmation tone sounds.

4 Handset:

Press  or  until the arrow points to "Registration", then press .

5 Press or until the arrow points to "Register H/set", then press .

- The available base unit numbers are displayed.

6 Press or to select the desired base unit number, then press .

- The number is assigned as the base unit number for the handset.

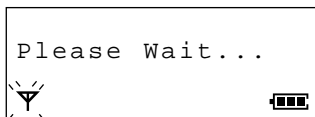

7 Enter the 4-digit base unit PIN (p. 55).

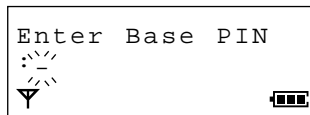

8 Press .

- "Please Wait..." is displayed, then a confirmation tone sounds.
- The handset will return to the standby mode. The current connected base unit number will be displayed.

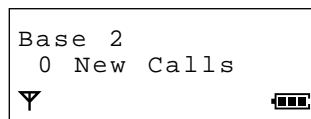

- To register the handset in more than one base unit, repeat from step 1 with the other base unit(s).

- You can exit the programming mode any time by pressing .
- The base unit number which the handset is currently in contact with can be displayed in the standby mode (p. 46). Calls (both incoming and outgoing) can be conducted only via the displayed base unit (even if the radio areas overlap with neighbouring base units).



Selecting the Base Unit Access

Automatic base unit access (Auto)

The handset automatically selects a registered base unit.

- When the handset moves to another base unit radio area, it loses contact with the previous base unit and automatically accesses the new base unit.
- If the handset is in the overlap area between several base unit radio areas, the handset will access the nearest base unit.

Specified base unit access

You can select one registered base unit (1 to 4) you desire to operate.

- You can choose the base unit/telephone line where you can make/receive calls.

The factory preset is Auto (automatic base unit access).

1 Press .

2 Press or until the arrow points to "Setting Handset", then press .

3 Press or until the arrow points to "Select Base", then press .

- The current setting, "Auto" or a registered base unit number is at the arrow.

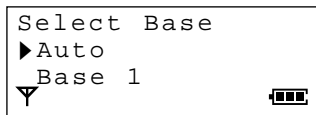

4 Press or to select the desired base unit.

5 Press .









- A beep sounds and the handset will return to the standby mode.
- The selected base unit number will be displayed.
- You can exit the programming mode any time by pressing .

➔ Registration

cancelling a Handset Registration in the Base Unit

Each handset can cancel itself or another handset.

Make sure that the power is ON (p. 12), and the unit is in the standby mode.



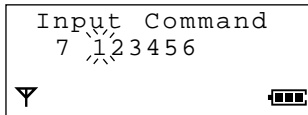















- 1 Press .
- 2 Press  or  until the arrow points to "Setting Base", then press .
 - "Input Command" is displayed.
- 3 Press .
- 4 Enter the 4-digit base unit PIN (p. 55).
 - The current registered handset number(s) is/are displayed.
- 5 Enter the handset number(s) you desire to cancel.
 - The selected handset number(s) flash(es).
- 6 Press .
 - A beep sounds.
 - The display will return to "Setting Base". To return to the standby mode, press  or wait for 60 seconds.
 - You can exit the programming mode any time by pressing .



cancelling a Base Unit

If another handset is out of range and/or its power is OFF when cancelling a handset registration in the base unit, the previous base unit number will still remain in the cancelled handset. Therefore, you need to cancel the base unit registered in the cancelled handset.

Make sure that the power is ON (p. 12), and the unit is in the standby mode.

- 1 Press .
- 2 Press  or  until the arrow points to "Setting Handset", then press .
- 3 Press  or  until the arrow points to "Registration", then press .
- 4 Press  or  until the arrow points to "Cancel Base", then press .
 - "Enter H/set PIN" is displayed.
- 5 Enter the 4-digit handset PIN (p. 40).
 - Registered base unit(s) is(are) displayed.
- 6 Press  or  until the arrow points to the base unit(s) you desire to cancel, then press .
 - "✓" marks the selected base unit.
- 7 Press .
 - "Clear ?" is displayed.
- 8 Press  or  to select "YES", then press .
 - A beep sounds and "CLEARED" is displayed.
 - To return to the standby mode, press .

Intercom



Intercom between Handsets

A 2-way intercom is available between one of the handsets registered in the same base unit.

Ex. Handset 1 is paging Handset 2.

1 Handset 1:

Press **INT**.

2 Handset 1:

Enter the desired handset number.

- “” is displayed and the paged handset rings.

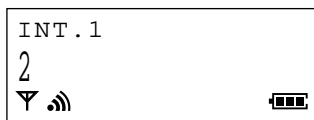

3 Handset 2:

When the unit rings, press to answer.

- The intercom duration is displayed.

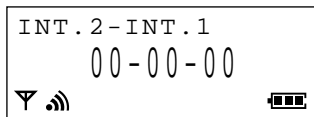

4 Handsets 1 and 2:

To end the intercom, press .

- Intercom calls can be conducted within the radio area of the current base unit, but not with units in neighbouring radio areas.

➔ Intercom

Transferring a Call from One Handset to Another

The intercom can be used during a call, enabling you to transfer a call between handsets registered to the same base unit.

To transfer a call using the intercom

Ex. Handset 1 is transferring a call to Handset 2.

1 Handset 1:

During a call, press **INT**.

Then enter the desired handset number.

- The call is put on hold.
- You will hear an internal ring back tone until the other handset is answered.
- If there is no answer, press **INT** to return to the call.

2 Handset 2:

When the unit rings, press  to answer.

3 Transferring a call:

Handset 1:

Press .

- The transfer is completed. Handset 2 can answer the call.

OR

Ending the intercom:

Handset 1:

Press **INT**.

- Handset 1 returns to the call.

To transfer a call without using the intercom

This feature enables you to transfer the call to another handset without waiting for the paged handset to answer.

Ex. Handset 1 is transferring a call to Handset 2.

1 Handset 1:

During a call, press **INT** and enter the desired handset number. Then press  to transfer the call.

- The call is put on hold.

2 Handset 2:

When the unit rings, press  to answer the call.

- The transfer is completed.

- If the paged handset is not answered within 30 seconds, a ring tone sounds at the paging handset. The paging handset can return to the call by pressing .

Conference

During a conversation in an external call, you can make an intercom call to another handset and then combine the calls together to establish a conference call.

1 Handset 1:

During a call, press **INT**. Then enter the desired handset number.

- The call is put on hold.
- If there is no answer, press **INT** to return to the call.

2 Handset 2:

When the unit rings, press  to answer.

3 Handset 1:

Press **3** to establish a conference call.

4 Handset 1 or 2:

Press  to hang up the conference call.

Battery Replacement

If “” flashes after a few telephone calls even when the handset batteries have been fully charged, it is time to replace the batteries with new ones. **Remember to charge the new batteries after replacement.**

- 1 Turn the power OFF to prevent memory loss (p. 12). Remove the cover by sliding while pressing in the direction of the arrow, then take out the batteries.
- 2 Replace the batteries with new ones as shown.
 - When you finish, close the handset cover and turn the power ON (p. 12).
- 3 Be sure to charge the new batteries fully in order to display the battery icon correctly (p. 11).

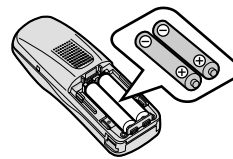
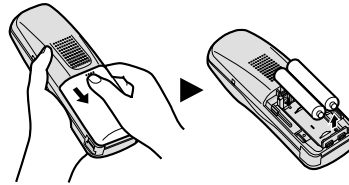

Ni-Cd battery: For about 10 hours
Ni-MH battery: For about 15 hours

- Discard defective batteries as soon as possible. Defective batteries may leak into the unit.
- Please use only Panasonic P6H or P6P batteries.
- If the rechargeable batteries are not inserted correctly, the handset will not work.
- At the end of its useful life, the Nickel-Cadmium battery must be disposed of properly.
- Nickel Cadmium (Ni-Cd) rechargeable batteries (AA size) are available.
Please use only Panasonic P6H batteries.

Caution:

To reduce the risk of fire or injury to persons, read and follow these instructions.

1. Use only the batteries specified.
 2. Do not use non-rechargeable batteries.
 3. Do not mix old and new batteries.
 4. Do not dispose of the batteries in a fire. They may explode. Check with local waste management codes for special disposal instructions.
 5. Do not open or mutilate the batteries. Released electrolyte is corrosive and may cause burns or injury to the eyes or skin. The electrolyte may be toxic if swallowed.
 6. Exercise care in handling the batteries in order not to short the batteries with conductive materials such as rings, bracelets, and keys. The batteries and/or conductor may overheat and cause burns.
 7. Charge the batteries provided with or identified for use with this product only in accordance with the instructions and limitations specified in this manual.
- Read “Important Notice Concerning the Correct Use and Charging of Ni-MH (Ni-Cd) Batteries” on page 87.

Important Notice Concerning the Correct Use and Charging of Ni-MH (Ni-Cd) Batteries

Batteries, due to their construction, undergo some wear and tear. The lifetime of a battery also depends on correct maintenance. Charging and discharging are the most important factors. You should take notice of the following to maintain the life of the battery as long as possible.

Ni-MH (Ni-Cd) batteries have a kind of memory, the "memory effect". If fully charged batteries are used several times only for 15 minutes in the handset and then recharged, the capacity of the batteries will be reduced to 15 minutes due to the memory effect. Therefore you should discharge the batteries completely, i.e. use them in the handset until "  " on the display starts flashing. Then recharge them as described in the manual. After the memory effect has occurred, it is possible to achieve almost complete capacity of the Ni-MH (Ni-Cd) batteries by charging and discharging several times one after another.

Ni-MH (Ni-Cd) batteries can also self-discharge. This self-discharge depends on the ambient temperature. At temperatures under 0°C, the self-discharge will be the lowest. High humidity and high temperatures support the self-discharge. Also long-term storage will lead to self-discharge. A dead Ni-MH (Ni-Cd) battery should not be disposed of normally. They contain toxic heavy metal hydride (cadmium) and therefore should be recycled.

Using the Belt Clip

You can hang the handset on your belt or pocket using the belt clip.

To attach the belt clip

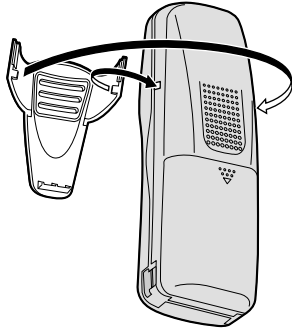

To remove the belt clip



Using the optional Headset

Plugging an optional headset into the handset allows a hands-free phone conversation. Please use only the Panasonic KX-TCA89EX headset.

Connecting the headset to the handset

Open the headset jack cover, and connect the headset to the headset jack as shown.

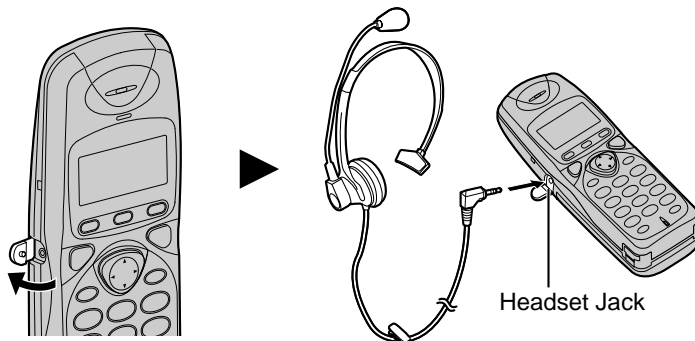

To adjust the headset receiver volume (HIGH, MEDIUM or LOW):

While using the headset, press ▼ or ▲.

When the optional headset is connected to the handset, make sure to use the headset to talk with the caller. If you want to have a normal cordless phone conversation, disconnect the headset.

Wall mounting

- This unit can be mounted on a wall.

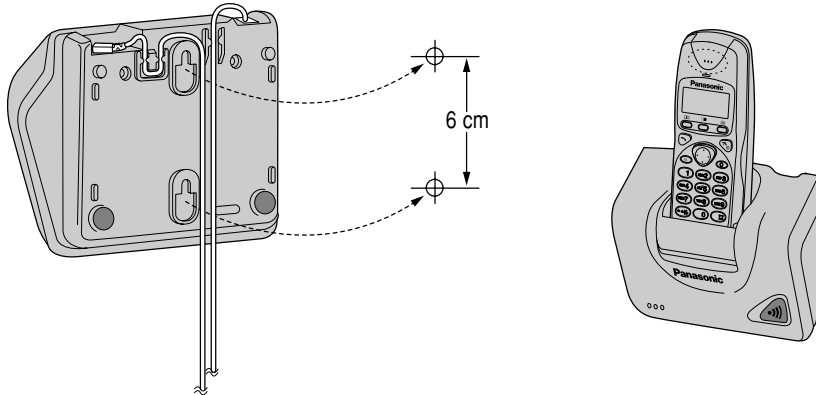

- Install screws using the wall template below.
- Connect the line cord, and AC adaptor.
- Arrange the wires as shown, then mount the unit.

Wall Template

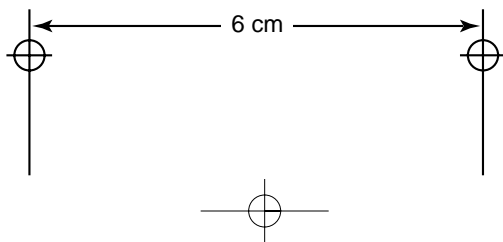

Option Covers

You can change the look of your phone's handset with option covers (KX-A109EX).

1. Turn the power OFF to prevent memory loss (p. 12). Remove the battery cover by sliding while pressing the arrow. Remove the batteries.
2. The option cover is locked with the right and left tabs. Unlock one of the tabs by pressing horizontally ① and vertically ②, and partially pull down the option cover ③, ④, as shown. Repeat this operation on other tab.

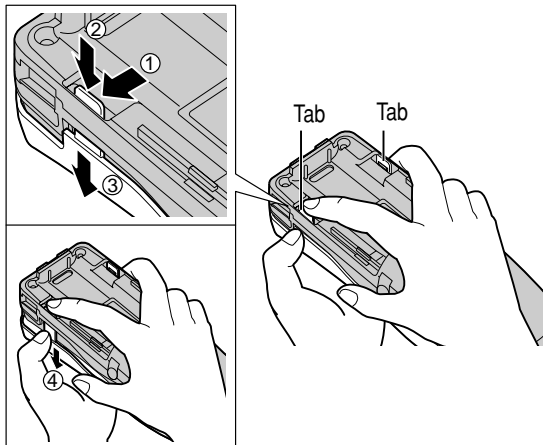

3. Place the new option cover fitting the tabs on the cover into their slots on the handset.

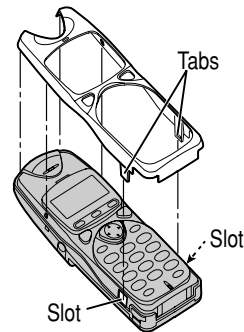

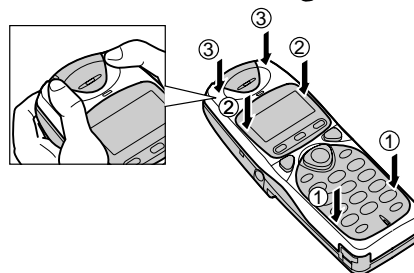

4. Snap the option cover shut on the lower ①, middle ② and upper ③ parts of the handset.









5. Install the batteries and close the battery cover.
 - When you finish, close the handset cover and turn the power ON (p. 12).

Before Requesting Help

Cordless Telephone



Problem	Remedy
“Y” flashes and an alarm tone sounds when you press  .	<ul style="list-style-type: none"> You are too far from the base unit. Move closer and try again. Plug in the AC adaptor.
A busy tone sounds when you press  .	<ul style="list-style-type: none"> Another handset is in use.
“Y” flashes during a conversation and the call is disconnected.	<ul style="list-style-type: none"> The handset is out of range. Move closer to the base unit and make the call again. Plug in the AC adaptor.
Static, sound cuts in/out, fades. Interference from other electrical units.	<ul style="list-style-type: none"> Locate the handset and base unit away from other electrical appliances (p. 5). Move closer to the base unit.
The handset does not ring.	<ul style="list-style-type: none"> Turn the power ON (p. 12). The ringer is set to OFF. Select the desired volume level (p. 43).
The base unit does not ring.	<ul style="list-style-type: none"> The ringer is set to OFF. Set to HIGH, MEDIUM or LOW (p. 58).
You cannot dial.	<ul style="list-style-type: none"> Check that the dialling mode selection is correct (p. 59). The unit is in call prohibition mode. Cancel the mode (p. 50). The dialled number is restricted. Cancel the number (p. 62). Key lock mode is set. Cancel the mode (p. 36).
You cannot redial.	<ul style="list-style-type: none"> If the last number dialled was more than 24 digits long, the number will not be redialled.
You cannot program function items such as the dialling mode.	<ul style="list-style-type: none"> Programming is not possible while the unit is in the talk or intercom mode. Do not pause for over 60 seconds while programming.
You cannot store a name and phone number in the phonebook.	<ul style="list-style-type: none"> You cannot store a name and phone number while the unit is in the talk or intercom mode. Do not pause for over 60 seconds while storing.

➔ Before Requesting Help

Problem	Remedy
While programming or searching, the unit starts to ring and stops the program/search.	<ul style="list-style-type: none"> • To answer the call, press . Start again from the beginning after hanging up.
The unit does not display the caller's phone numbers.	<ul style="list-style-type: none"> • Other telephone equipment may be interfering with your telephone. Disconnect it. Try again. • Other electrical appliances connected to the same outlet may be interfering with the Caller ID information. Telephone line noise may be affecting the Caller ID information.
The display goes to the standby mode while viewing the Caller List or phonebook.	<ul style="list-style-type: none"> • Do not pause for over 60 seconds while searching.
 does not function.	<ul style="list-style-type: none"> • The handset is too far from the base unit. • The handset is engaged in an outside call or is viewing the Caller List.
The paged handset does not answer.	<ul style="list-style-type: none"> • The handset is not in the same radio area. • The handset is engaged in an outside call. • The handset has been cancelled or has not been registered. Register the handset in the base unit (p. 80).
While using the intercom, two tones sound.	<ul style="list-style-type: none"> • A call is being received. To answer, press  then .
The unit misdials when connected to a PBX.	<ul style="list-style-type: none"> • Check the pause function (p. 36).
You cannot register the handset in the base unit.	<ul style="list-style-type: none"> • The base unit has registered a maximum of 6 handsets or the handset has registered a maximum of 4 base units. • There is interference from other electrical units. Locate the handset and base unit away from them. • You must finish registration within 1 minute after the confirmation tone sounds, or programming will be cancelled (p. 80).
When redialling with pressing  and  , you cannot talk to the other party.	<ul style="list-style-type: none"> • Press .





Answering System

Problem	Remedy
The answering system is on, but incoming messages are not recorded.	<ul style="list-style-type: none"> • The recording time is set to “greeting only”. Select “1 minute” or “unlimited” (p. 74). • Memory is full. Erase some or all of the messages (p. 69, 70).
You cannot operate the answering system from a touch tone phone.	<ul style="list-style-type: none"> • Make sure you enter the correct remote code. • The answering system may not respond if the tones are too short to activate the unit. Press each button firmly. • The answering system is off. Turn it on (p. 13).
You cannot operate the answering system with the handset.	<ul style="list-style-type: none"> • Someone is operating the answering system. • You are too far from the base unit. Move closer to the base unit. • The unit is recording a message. To answer the call, press .
While recording a greeting message, the unit starts to ring and stops recording.	<ul style="list-style-type: none"> • To answer the call, press . The recording stops halfway. Start from the beginning after hanging up.
During playback, the unit starts to ring and stops playback.	<ul style="list-style-type: none"> • To answer the call, press .

➔ Before Requesting Help

General

Problem	Remedy
The unit does not work.	<ul style="list-style-type: none"> • Turn the power ON (p. 12). • Check the settings (p. 54). • Charge the batteries fully (p. 11). • Clean the charge contacts and charge again (p. 11). • Unplug the AC adaptor and turn the power OFF to reset. Plug in the AC adaptor and turn the power ON. Then try again. • The handset has been cancelled or has not been registered. Register the handset (p. 80). • Re-install the handset batteries and try again.
You cannot program items such as the time/day adjustment.	<ul style="list-style-type: none"> • Programming is not possible while the unit is in the talk or intercom mode. • Move closer to the base unit.
The battery strength is not displayed correctly.	<ul style="list-style-type: none"> • Check that the battery type selection is correct (p. 52).
“  ” flashes or the unit beeps every 15 seconds.	<ul style="list-style-type: none"> • Charge the batteries fully (p. 11).
You charged the batteries fully, but “  ” flashes.	<ul style="list-style-type: none"> • Clean the charge contacts and charge again (p. 11). • Install new batteries (p. 52, 86).

Safety Instructions



Take special care to follow the safety suggestions listed below.

Safety

- 1) The unit should be connected to a power supply only of the type described in the operating instructions or as marked on the unit.
- 2) When the unit is not used, turn the power off. When left unused for a long period of time, the base unit should be unplugged from the household AC outlet.

Installations

Environment

- 1) Do not use this unit near water—for example, near a bath tub, washbowl, sink, etc. Damp basements should also be avoided.
- 2) The unit should be kept away from heat sources such as radiators, kitchen range, etc. It also should not be placed in rooms where the temperature is less than 5°C or greater than 40°C.
- 3) The AC adaptor is used as the main disconnect device, ensure that the AC outlet is located/ installed near the unit and is easily accessible.

Placement

- 1) Do not place heavy objects on top of this unit.
- 2) Care should be taken so that objects do not fall onto and liquids are not spilled into the unit. Do not subject this unit to excessive smoke, dust, mechanical vibration, or shock.
- 3) Place the unit on a flat surface.

For best performance

- 1) If noise prevents the conversation from being understood at the handset, approach the base unit to lessen the noise.
- 2) The handset should be used at the HIGH volume setting when the reception tone is difficult to hear.
- 3) The handset should be fully recharged on the base unit when “” on the display flashes.
- 4) The maximum calling distance may be shortened when the unit is used in the following places:
Near obstacles such as hills, tunnels, underground, near metal objects such as wire fences, etc.

Lightning surge

This unit has already been equipped with a built-in lightning protection circuit. However, we recommend that you install the following options, if your area has frequent lightning strikes.

- 1) Lightning protection on the telephone line
- 2) Lightning protection on the power source

To install the above options, please contact your local sales shop.

- Lightning damage is not covered in the warranty even if lightning protection is installed.

Adding Another Phone

This unit will not function during a power failure. To connect a standard telephone on the same line, use a T-adaptor.

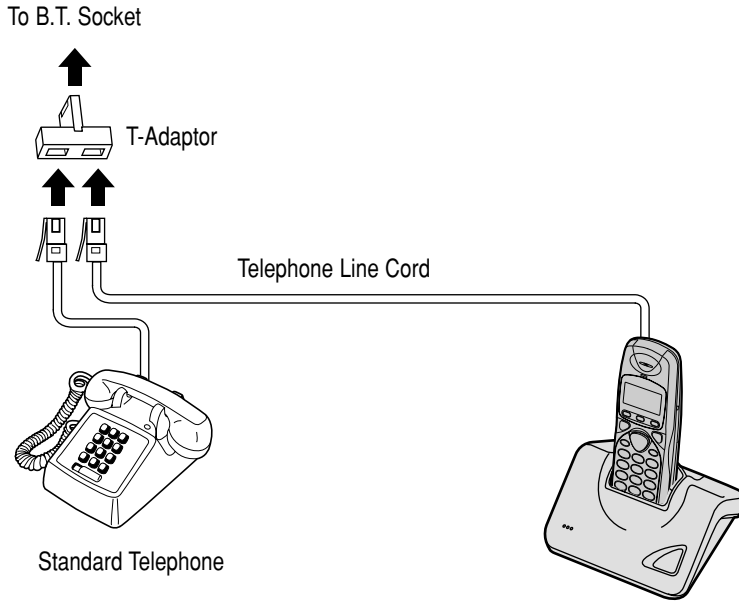

Term Definitions

DECT

The abbreviation DECT means “Digital Enhanced Cordless Telecommunications”.

Advantages of DECT

Excellent voice quality: Through sampling of digital signals DECT units obtain nearly noiseless transmission.

High grade tapping security: Based on digital transmission, DECT conversations are well protected against unapproved monitoring.

Multi-Handset operation: To operate several handsets at the base unit, no cable installation is required.

Interlink: Intercom conversation can be held free of charge between the registered handsets.

Functions like a PBX: More than one operation can be performed at the same time, like a PBX. eg., during an external call, an internal call or outside call can be transferred to another handset.

Multi-Base station operation: More than one handset can be registered to several base units, e.g., for private and office applications.

Equipment Manufacturer’s Code (EMC)

For identification, this unit is prepared with an EM Code, which can be applied to future operators in mobile networks.

GUARANTEE CONDITIONS OF GUARANTEE

This guarantee is in addition to and does not in any way affect any statutory or other rights of consumer purchasers. If within the applicable guarantee period, the appliance proves to be defective by reason of faulty design, workmanship or materials, we undertake subject to the following conditions to have the defective appliance (or any part or parts there of) repaired or replaced free of charge.

1. The appliance shall have been purchased and used solely within the UK and in accordance with standard operating instructions and the technical and/or Safety Standards required in the UK.
2. The appliance should be returned together with this guarantee and proof of date of purchase promptly on being found defective at the purchaser's risk and expense to the authorised dealer from whom the appliance was purchased or to the nearest authorised dealer. All enquires must be through such dealers.
3. This guarantee shall not apply to damage caused through fire, accident, lightning, misuse, wear and tear, neglect, incorrect adjustment or repair, to damage caused through installation, adaption, modification or use in an improper manner or inconsistent with the technical and/or safety standards required in the country where this appliance is used, or to damage occurred during transit to or from the purchaser.
4. If at any time during the guarantee period any part or parts of the appliance are replaced with a part or parts not supplied or approved by us or of an objective quality safe and suitable for the appliance, or the appliance has been dismantled or repaired by any person not authorised by us, we shall have the right to terminate this guarantee in whole or in part immediately without further notice.
5. The purchaser's sole and exclusive remedy under this guarantee against us is for the repair or replacement of the appliance or any defective part or parts and no other remedy, including, but not limited to, incidental or consequential damage or loss of whatsoever nature shall be available to the purchaser.
6. This guarantee shall not apply to cassette tapes, batteries and any other items of limited natural life.
7. Our decision on all matters relating to complaints shall be final. Any appliance or defective part which has been replaced shall become our property.
8. The guarantee period applicable to this product shall be 12 months.

Please keep these Operating Instructions with your receipt.

Panasonic Business Systems U.K.

Receipt No. _____ Date of Purchase _____

Model No. **KX-TCD725EM** Serial No. _____

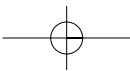
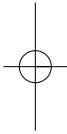



MODEL No. KX-TC725EM

Manufacturer's Declaration:

Hereby, Kyushu Matsushita Electric (U.K.) Ltd., declares that this Dect Cordless Telephone is in compliance with the essential requirements and other relevant provisions of Directive 1999/5/EC.

A copy of the manufacturer's declaration of conformity to the essential requirements of the R&TTE Directive is available at the following web address:
<http://doc.panasonic-tc.de>

Customer Care Helpline Tel. No.: 08705 357357**CE0436**

1999/5/EC

This equipment is designed for use on the United Kingdom only.
In the event of problem, you should contact your equipment supplier in the first instance.

Technical specifications are subject to change.

Sales Department:**Panasonic Business Systems U.K.**

Panasonic House, Willoughby Road, Bracknell, Berkshire, RG12 8FP

Kyushu Matsushita Electric (U.K.) Ltd.

Pencarn Way, Duffryn, Newport, South Wales, NP10 8YE, United Kingdom

Printed in Thailand

PQXX13076YA

DU0701NR1101

Free Manuals Download Website

<http://myh66.com>

<http://usermanuals.us>

<http://www.somanuals.com>

<http://www.4manuals.cc>

<http://www.manual-lib.com>

<http://www.404manual.com>

<http://www.luxmanual.com>

<http://aubethermostatmanual.com>

Golf course search by state

<http://golfingnear.com>

Email search by domain

<http://emailbydomain.com>

Auto manuals search

<http://auto.somanuals.com>

TV manuals search

<http://tv.somanuals.com>