

Panasonic

DVD Player/Receiver
DVD-Player/Receiver
Lecteur DVD/récepteur
Sintoamplificatore/lettore DVD
Reproductor de DVD/receptor
DVD-плеер/ресивер



Model: **CQ-D1703N**



Operating Instructions
Bedienungsanleitung
Manuel d'instructions
Manuale di istruzioni
Manual de Instrucciones
Инструкция по эксплуатации



MP3



- Please read these instructions carefully before using this product and keep this manual for future reference.
- Bitte lesen Sie diese Bedienungsanleitung vor der Verwendung dieses Produktes aufmerksam durch und bewahren Sie sie danach für spätere Nachschlagzwecke sorgfältig auf.
- Prière de lire ces instructions attentivement avant d'utiliser le produit et garder ce manuel pour l'utilisation ultérieure.
- Si prega di leggere attentamente queste istruzioni prima di usare questo prodotto e di conservare questo manuale per usi futuri.
- Lea con atención estas instrucciones antes de utilizar el producto y guarde este manual para poderlo consultar en el futuro.
- Перед началом эксплуатации просим прочитать настоящую инструкцию внимательно и хранить ее на пользование на будущее.

Safety Information

■ Read the operating instructions for the unit and all other components of your car audio system carefully before using the system. They contain instructions about how to use the system in a safe and effective manner. Panasonic assumes no responsibility for any problems resulting from failure to observe the instructions given in this manual.

■ This manual uses pictographs to show you how to use the product safely and to alert you to potential dangers resulting from improper connections and operations. The meanings of the pictographs are explained below. It is important that you fully understand the meanings of the pictographs in order to use this manual and the system properly.



This pictograph intends to alert you to the presence of important operating instructions and installation instructions. Failure to heed the instructions may result in severe injury or death.



Caution

This pictograph intends to alert you to the presence of important operating instructions and installation instructions. Failure to heed the instructions may result in injury or material damage.

Warning

Observe the following warnings when using this unit.

- ❑ **The driver should neither watch the display nor operate the system while driving.**
Watching the display or operating the system will distract the driver from looking ahead of the vehicle and can cause accidents. Always stop the vehicle in a safe location and use the parking brake before watching the display or operating the system.
- ❑ **Use the proper power supply.**
This product is designed for operation with a negative grounded 12 V DC battery system. Never operate this product with other battery systems, especially a 24 V DC battery system.
- ❑ **Keep batteries out of reach of infants.**
Batteries can be ingested, so keep them out of the reach of infants. If an infant ingests a battery, please seek immediate medical attention.
- ❑ **Protect the Deck Mechanism.**
Do not insert any foreign objects into the slot of this unit.
- ❑ **Do not disassemble or modify the unit.**
Do not disassemble, modify the unit or attempt to repair the product yourself. If the product needs to be repaired, consult your dealer or an authorized Panasonic Service Centre.
- ❑ **Do not use the unit when it is out of order.**
If the unit is out of order (no power, no sound) or in an abnormal state (has foreign objects in it, is exposed to water, is smoking, or smells), turn it off immediately and consult your dealer.
- ❑ **The remote control unit should not lie about in the car.**
If the remote control unit lies about, it could fall on the floor while driving, get wedged under the brake pedal, and lead to a traffic accident.
- ❑ **Refer fuse replacement to qualified service personnel.**
When the fuse blows out, eliminate the cause and have it replaced with the fuse prescribed for this unit by a qualified service engineer. Incorrect replacement of the fuse may lead to smoke, fire, and damage to the product.

Observe the following warnings when installing.

- ❑ **Disconnect the lead from the negative (–) battery terminal before installation.**
Wiring and installation with the negative (–) battery terminal connected may cause electrical shock and injury due to a short circuit.
Some cars equipped with the electrical safety system have specific procedures of battery terminal disconnection.
FAILURE TO FOLLOW THE PROCEDURE MAY LEAD TO THE UNINTENDED ACTIVATION OF THE ELECTRICAL SAFETY SYSTEM RESULTING IN DAMAGE TO THE VEHICLE AND PERSONAL INJURY OR DEATH.
- ❑ **Never use safety-related components for installation, grounding, and other such functions.**
Do not use safety-related vehicle components (fuel tank, brake, suspension, steering wheel, pedals, airbag, etc.) for wiring or fixing the product or its accessories.
- ❑ **Installing the product on the air bag cover or in a location where it interferes with airbag operation is prohibited.**
- ❑ **Check for piping, gasoline tank, electric wiring, and other items before installing the product.**
If you need to open a hole in the vehicle chassis to attach or wire the product, first check where the wire harness, gasoline tank, and electric wiring are located. Then open the hole from outside if possible.
- ❑ **Never install the product in a location where it interferes with your field of vision.**
- ❑ **Never have the power cord branched to supply other equipment with power.**
- ❑ **After installation and wiring, you should check the normal operation of other electrical equipment.**
The continuation of their using in abnormal conditions may cause fire, electrical shock or a traffic accident.
- ❑ **In the case of installation to an airbag-equipping car, confirm warnings and cautions of the vehicle manufacturer before installation.**
- ❑ **Make sure the leads do not interfere with driving or getting in and out of the vehicle.**
- ❑ **Insulate all exposed wires to prevent short circuiting.**

Caution

Observe the following cautions when using this unit.

- ❑ **Keep the sound volume at an appropriate level.**
Keep the volume level low enough to be aware of road and traffic conditions while driving.
- ❑ **This unit is designed for use exclusively in automobiles.**
- ❑ **Do not operate the unit for a prolonged period with the engine turned off.**
Operating the audio system for a long period of time with the engine turned off will drain the battery.
- ❑ **Do not expose the unit to direct sunlight or excessive heat.**
Otherwise these will raise the interior temperature of the unit, and it may lead to smoke, fire, or other damage to the unit.
- ❑ **Do not use the product where it is exposed to water, moisture, or dust.**
Exposure of the unit to water, moisture, or dust may lead to smoke, fire, or other damage to the unit. Make especially sure that the unit does not get wet in car washes or on rainy days.
- ❑ **Set the volume level to low enough before the AUX connection is completed.**
Failure to observe this, the loud noise may come out and damage your speakers and your hearing. Direct connection of the speaker/headphone output of an external device without any attenuator may distort sound or damage the connected external device.

Observe the following cautions when installing.

- ❑ **Refer wiring and installation to qualified service personnel.**
Installation of this unit requires special skills and experience. For maximum safety, have it installed by your dealer. Panasonic is not liable for any problems resulting from your own installation of the unit.
- ❑ **Follow the instructions to install and wire the product.**
Not following the instructions to properly install and wire the product could cause an accident or fire.
- ❑ **Take care not to damage the leads.**
When wiring, take care not to damage the leads. Prevent them from getting caught in the vehicle chassis, screws, and moving parts such as seat rails. Do not scratch, pull, bend or twist the leads. Do not run them near heat sources or place heavy objects on them. If leads must be run over sharp metal edges, protect the leads by winding them with vinyl tape or similar protection.

- ❑ **Use the designated parts and tools for installation.**
Use the supplied or designated parts and appropriate tools to install the product. The use of parts other than those supplied or designated may result in internal damage to the unit. Faulty installation may lead to an accident, a malfunction or fire.
- ❑ **Do not block the air vent or the cooling plate of the unit.**
Blocking these parts will cause the interior of the unit to overheat and will result in fire or other damage.
- ❑ **Do not install the product where it is exposed to strong vibrations or is unstable.**
Avoid slanted or strongly curved surfaces for installation. If the installation is not stable, the unit may fall down while driving and this can lead to an accident or injury.
- ❑ **Installation Angle**
The product should be installed in a horizontal position with the front end up at a convenient angle, but not more than 30°. The user should bear in mind that in some areas there may be restrictions on how and where this unit can be installed. Consult your dealer for further details.
- ❑ **Wear gloves for safety. Make sure that wiring is completed before installation.**
- ❑ **To prevent damage to the unit, do not connect the power connector until the whole wiring is completed.**
- ❑ **Do not connect more than one speaker to one set of speaker leads. (except for connecting to a tweeter)**

Observe the following cautions when handling the battery for the remote control unit.

- Use only specified battery (CR2025).
- Match the polarity of the battery with the (+) and (-) marks in the battery case.
- Replace dead battery as soon as possible.
- Remove the battery from the remote control unit when not using it for an extended period of time.
- Insulate the battery (by placing them in a plastic bag or covering them with vinyl tape) before disposal or storage.
- Dispose of the battery according to the local regulations.
- Do not disassemble, recharge, heat or short the battery. Do not throw a battery into a fire or water.

In case of battery leakage

- Thoroughly wipe the battery liquid off the battery case and insert new battery.
- If any part of your body or clothing comes into contact with battery liquid, wash it with plenty of water.
- If battery liquid comes into contact with your eyes, wash them with plenty of water and get immediate medical attention.

Warning

For your safety, this system is designed not to see the moving picture while you are driving.

When connecting this unit to the front monitor (on-dash/in-dash):

- Park your car in a safe place and use the parking brake lever before seeing the moving picture.
- For your safety, you must ensure that the connection of the parking brake lead is correct. (➔ Page 51)

Warning

When driving please enjoy sound only.

Safety Information (continued)

Laser Product

Label Indications and Their Locations

CAUTION
LASER RADIATION
WHEN OPEN.
DO NOT STARE INTO BEAM.

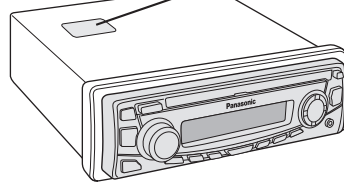

CLASS 1 LASER PRODUCT

Caution Label

CAUTION - LASER RADIATION WHEN OPEN. AVOID EXPOSURE TO BEAM.	VAROITUS - LASER-SÄTEILYVAARA AVATTAESSA. VARO ALTISTUMISTA SÄTEELLE.
VORSICHT - LASERSTRAHLUNG. WENN GEOFFNET, VERMEIDEN SIE EIN AUSSETZEN GEGENÜBER DEM LASERSTRAHL.	FÖRSIKTIGHET - LASERSTRÅLNING I ÖPPNAT LÄGE. UNDVIK ATT UTSÄTTAS FÖR STRÅLEN.
ATTENTION - RAYONNEMENT LASER SI OUVERT, EVITER TOUTE EXPOSITION AU FAISCEAU.	ADVARSEL - LASERSTRÅLING. UNNGÅ EKSPONERING FOR STRÅLEN VED ÅPNING.
ADVARSEL - LASER UDSENDES NÅR DER ER ÅBNET. UNDGÅ UDSÆTTELSE FOR STRÅLER.	ВНИМАНИЕ - ЛАЗЕРНОЕ ИЗЛУЧЕНИЕ ПРИ ОТКРЫТИИ. ИЗБЕЖАТЬ ВОЗДЕЙСТВИЯ ЛАЗЕРНОГО ИЗЛУЧЕНИЯ.

Caution: This product utilizes a laser.
Use of controls or adjustments or performance of procedures other than those specified herein may result in hazardous radiation exposure.

Do not take apart this unit or attempt to make any changes yourself.
This unit is a very intricate device that uses a laser pickup to retrieve information from the surface of compact discs. The laser is carefully shielded so that its rays remain inside the cabinet. Therefore, never try to disassemble the player or alter any of its parts since you may be exposed to laser rays and dangerous voltages.

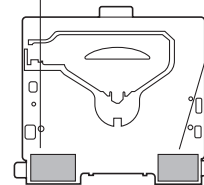

Deck Ass'y
(In this unit, upper side)

Information on Disposal for Users of Waste Electrical & Electronic Equipment (private households)

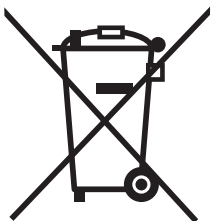

This symbol on the products and/or accompanying documents means that used electrical and electronic products should not be mixed with general household waste.

For proper treatment, recovery and recycling, please take these products to designated collection points, where they will be accepted on a free of charge basis. Alternatively, in some countries you may be able to return your products to your local retailer upon the purchase of an equivalent new product.

Disposing of this product correctly will help to save valuable resources and prevent any potential negative effects on human health and the environment which could otherwise arise from inappropriate waste handling. Please contact your local authority for further details of your nearest designated collection point.

Penalties may be applicable for incorrect disposal of this waste, in accordance with national legislation.

For business users in the European Union

If you wish to discard electrical and electronic equipment, please contact your dealer or supplier for further information.

Information on Disposal in other Countries outside the European Union

This symbol is only valid in the European Union.

If you wish to discard this product, please contact your local authorities or dealer and ask for the correct method of disposal.

Panasonic welcomes you to our constantly growing family of electronic products owners. We endeavor to give you the advantages of precise electronic and mechanical engineering, manufactured with carefully selected components, and assembled by people who are proud of the reputation their work has built for our company. We know this product will bring you many hours of enjoyment, and after you discover the quality, value and reliability we have built into it, you too will be proud to be a member of our family.













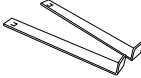



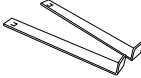

Differences between 2 Models

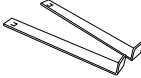
- This operating instruction manual is for 2 models CQ-D1703N2 and CQ-D1703N5. The following table describes the differences between 2 models.

Features	Models	CQ-D1703N2	CQ-D1703N5
Region number		2, ALL	5, ALL

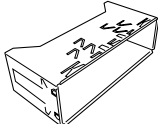

Accessories

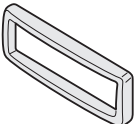
 <p>Operating Instructions (YEFM285852) Q'ty: 1</p>	 <p>PAN EUROPEAN GUARANTEE (Warranty Card) Q'ty: 1</p>	<table border="1"> <tbody> <tr> <td data-bbox="502 639 675 954">  <p>Lock Cancel Plate Q'ty: 2</p> </td> <td data-bbox="696 639 869 954">  <p>Mounting Bolt Q'ty: 1</p> </td> <td data-bbox="897 639 1070 954">  <p>ISO Antenna Adapter Q'ty: 1</p> </td> <td data-bbox="1094 639 1275 954">  <p>Clip Connector Q'ty: 1</p> </td> </tr> <tr> <td colspan="4" data-bbox="502 954 1275 1025" style="text-align: center;"> Installation kit (YEP0FZ5725) </td> </tr> </tbody> </table>				 <p>Lock Cancel Plate Q'ty: 2</p>	 <p>Mounting Bolt Q'ty: 1</p>	 <p>ISO Antenna Adapter Q'ty: 1</p>	 <p>Clip Connector Q'ty: 1</p>	Installation kit (YEP0FZ5725)			
 <p>Lock Cancel Plate Q'ty: 2</p>	 <p>Mounting Bolt Q'ty: 1</p>	 <p>ISO Antenna Adapter Q'ty: 1</p>	 <p>Clip Connector Q'ty: 1</p>										
Installation kit (YEP0FZ5725)													
 <p>Power Connector (K1HY12YY0001) Q'ty: 1</p>	 <p>Mounting Collar (YEFX0217263A) Q'ty: 1</p>	 <p>Removable Face Plate Case (YEFA131839) Q'ty: 1</p>	 <p>Remote Control Unit (YEFX9995584) Q'ty: 1</p>	 <p>Battery (CR2025) Q'ty: 1</p>	 <p>Trim Plate (YEFX05657) Q'ty: 1</p>								

Note:

- The number in parentheses underneath each accessory part name is the part number for maintenance and service.
- Accessories and their parts numbers are subject to modification without prior notice due to improvements.
- Trim Plate and Mounting Collar are mounted on the main unit at shipment.

Features

Discs that can be Played Back (⇒ Page 8)

■ **Playback of various moving pictures such as DivX files**

Connection of the optional monitor (CY-VM7203N) allows users to enjoy DivX files recorded on CD-Rs/RWs and DVD-Rs/RWs as well as DVD videos and video CDs.

■ **MP3/DivX playback recorded on CD-Rs/RWs or DVD-Rs/RWs**

MP3/DivX files recorded on CD-Rs/RWs and DVD-Rs/RWs can be enjoyed. Up to 1200 tracks of MP3/DivX files can be saved on 1 piece of DVD-R/RW.

***This unit is not compatible with WMA file.**

■ **Digital Audio Output**

Digital audio output terminal for upgrading to Dolby Digital and dts surround [Requires separately sold optical cable (CA-LRD60) and digital surround processor.]

■ **SQ (Sound Quality)**

SQ is a function that can call up various sound types at the touch of button in accordance with your listening music type.

■ **The AUX input terminal is equipped on the front panel.**

Your mobile audio player and other devices are connectable to this unit without any difficulty.

■ **Private mode (P-MODE)**

A different source can be selected between the front and rear seats. Thus, traffic information can be obtained in the front seat of a car, while DVD's audio and visual can be enjoyed in the rear seat of the same car.

Contents

Common

Safety Information 2
Accessories 5
Features 6
Contents 6
System Upgrade 7
Discs that can be Played Back 8
Preparation (Battery Replacement, TV Type setting, ACC Setting) 9
General (Main Unit) 10
General (Remote Control Unit) 12

Each source

Radio 14
Radio Data System (RDS) 16
Before Disc Playback 22
CD Player 23
MP3/DivX Player 24
DVD/VCD Player 26
Advanced Operation for Video Discs (DVD/VCD/DivX) 28
OSD (On-Screen Display) 30
Notes on MP3/DivX 32

As needed

Audio Settings (Volume, Bass/Treble, Balance/Fader, Audio Output Level) 34
Function Settings (FM Monaural Reception, Local Tuning, Region (REG) Mode, PTY Language Selection, Private Mode (P-MODE), External Mute, ACC Selection) 36
User Settings (TV Type, etc.) 40
Language Code List 44
Definition of Terms 45
Anti-Theft System 46
Fuse 47
Maintenance 47
Notes on Discs 47
Installation 48
Wiring 50
Troubleshooting 56
Specifications 63

System Upgrade

Optional system (Example)

This unit can be combined with other components like shown below. For more details, refer to the operating instructions for the connected devices.

Preparation:

- The TV standard format (NTSC/PAL) setting of this unit ("TV Type" → Page 42) should be the same as the input signal setting (NTSC/PAL) of the monitor to be connected. Otherwise, pictures appear incorrectly. (Default: PAL)



Color LCD Display: CY-VM7203N

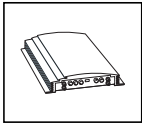



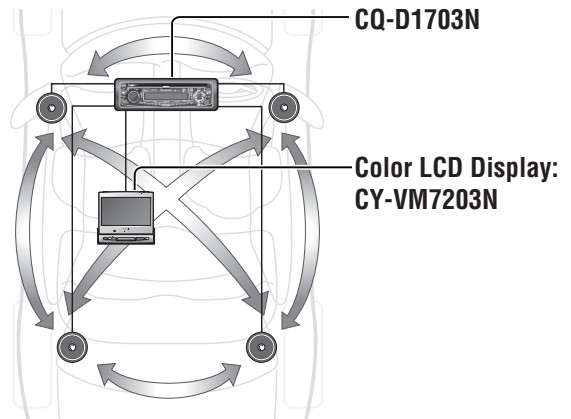

External Power Amplifier (CY-PA2003, etc.)

Basic System



Discs that can be Played Back

Disc Type

DISC	DVD	VCD (Video CD)	CD	CD-R/RW
Mark/logo		 (IEC62107)		
Disc Size	12 cm / 8 cm			
Video Format	NTSC / PAL			
Audio Format	LPCM, MPEG1, MPEG2, Dolby Digital	LPCM (CD-DA*), MPEG1, MPEG2 (SVCD)	LPCM (CD-DA*), MP3	
Region No.	2, 5, ALL* ²			

*¹ CD-DA : A general music CD format.

Note:

- Only discs with logos shown in the “Mark/logo” row of the table above are playable.
- About CD-Rs and CD-RWs, refer to “Notes on CD-Rs/RWs, DVD-Rs/RWs”. (→ Page 47)
- Some copy-protected music CDs are not playable.
- Even if you play a dts DVD or a dts CD, analog sound cannot be reproduced. (Only digital output comes out)

Notes on DVD-Rs/RWs (DVD Video)

- Do not mix DVD-Video formatted data and other formatted data on the same disc.
- Discs in the video recording (VR) format are unplayable.
- Unfinalized discs are unplayable.
- Use disc-at-once recording for DVD-R DL (double-layer).
- Some discs are unplayable depending on the disc itself, device, drive and software that are used for disc recording.

Discs not supported

The following discs are not played back on this product.



- DVD-Audio
- DVD-ROM
- DVD-RAM
- DVD+R
- DVD+RW
- VSD
- CVD
- CD-G
- CD-ROM (except MP3)
- CD-RW (except MP3/DivX and CD-DA)
- CD-R (except MP3/DivX and CD-DA)
- SACD
- Photo CD
- CDV
- Hybrid SACD (except CD-DA)
- CD-EXTRA (audio-only playback possible)
- DVDs with a region number other than “2”, “5” or “ALL”^{*2}
- Playing back a photo CD disc with this unit could damage the data that is recorded on the disc.

About DivX

- DivX files recorded on CD-Rs/RWs and DVD-Rs/RWs are playable. Refer to “Notes on MP3/DivX” for further information. (→ Page 32)



Symbols used on jackets

(Examples of such symbols include)

-  : Number of subtitle languages
-  : Number of audio tracks
-  : Number of angles

The numbers indicate the number of languages, tracks, angles, etc., recorded on the disc.

Screen size (H:V aspect ratio)

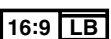
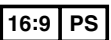
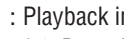
-  : 4:3 standard size
-  : Letterbox (→ Page 43, 45)
- 16:9 wide size
-  : Playback in letterbox format on a standard screen (4:3).
-  : Playback in  (pan and scan) (→ Page 43, 45) format on a standard screen (4:3).

Note:

- The size of the image that is displayed on the screen depends on the screen mode (“TV Display” → Page 42), and on the screen size for the content on the disc.

Region Management Information

This product is designed and manufactured to respond to the Region Management Information that is recorded on a DVD disc. If the Region number described on the DVD disc does not correspond to the Region number of this product, this product does not play the disc.

*² The Region number for this product is “2” (for CQ-D1703N2), “5” (for CQ-D1703N5) or “ALL”.

Example:



Preparation

Remote Control Unit

Battery Replacement

1 Remove the battery holder with the remote control unit placed on a flat surface.

- ① Stick your thumbnail into the groove, and push the holder in the direction of the arrow at the same time.
- ② Pull it out in the direction of the arrow using a tough pointed object.

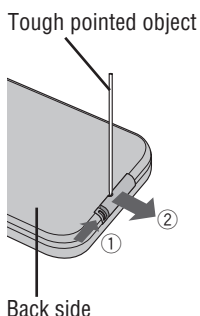

- ② Put a battery in the case with (+) side facing up.
- ③ Put the case back.

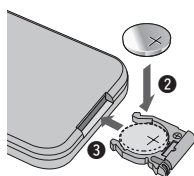

Warning

- Keep batteries away from children to avoid the risk of accidents. If an infant ingests a battery, please seek immediate medical attention.

Caution

- Remove and dispose of an old battery immediately.
- Do not disassemble, heat or short a battery. Do not throw a battery into a fire or water.
- Follow local regulations when disposing of a battery.
- Improper use of a battery may cause overheating, an explosion or ignition, resulting in injury or a fire.

Note:

- Battery Information:
 Battery Type: Panasonic lithium battery (CR2025)
 Battery Life: Approximately 6 months under normal use (at room temperature)

Main Unit

TV Type setting

You can select a TV standard format (NTSC/PAL). Refer to "Optional system (Example)" (⇒ Page 7) and "TV Type" (⇒ Page 42).

Note:

- This unit is not compatible with SECAM format.

ACC Setting

Caution

- Be sure to select OFF when your car has no ACC position in the ignition switch. Failure to do this could cause the battery to go dead.

For an ACC-equipped car, select ON. (⇒ Page 38) The following functions are available. (Default: off)

- The power is turned on automatically when inserting a disc.
- The clock can be displayed even if the power is off. (⇒ Page 10)

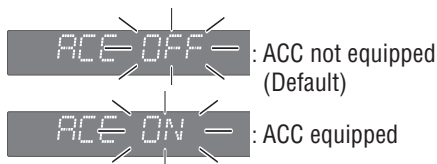

General (Main Unit)

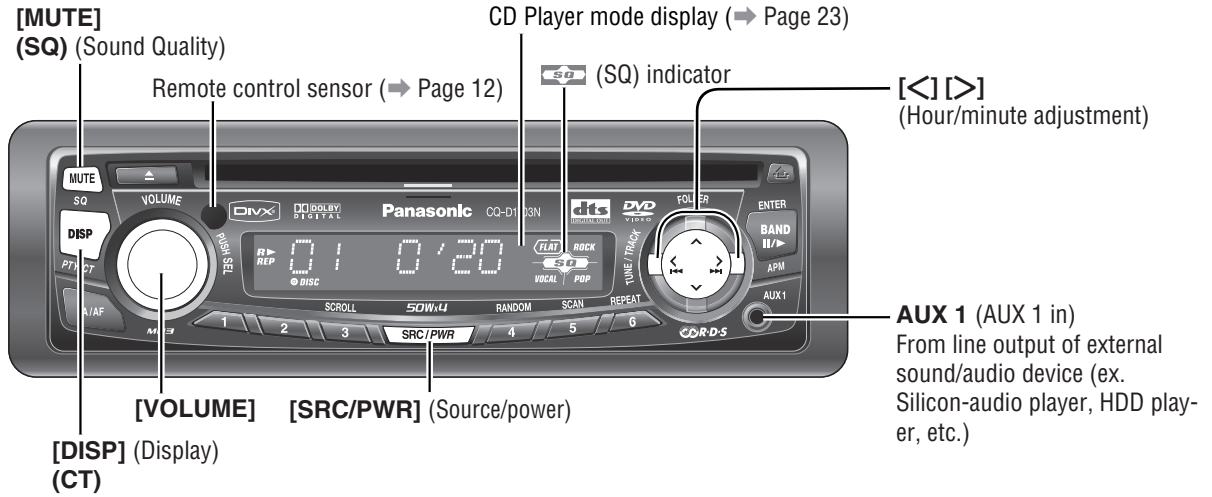

Power

Set your car's ignition switch to the ACC or ON position.

ON: Press [SRC/PWR].



OFF: Press and hold [SRC/PWR] for more than 1 second.

Mute MUTE

ON : Press [MUTE].

OFF : Press [MUTE] again.



[MUTE] indicator

Clock Display (at Power Off)

When the power of the unit is set to OFF, press [DISP] (CT) (ACC ON).



(Clock time) (Default)



(Display off)

When the power is set to ON, refer to the description for each source mode.

Volume

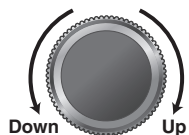

Default: 18
Setting range: 0 to 40

Note:

- The volume level can be set independently for each source. (For radio, one volume setting for AM (LW/MW), one volume setting for all FMs)

SQ (Sound Quality)

SQ is a function that can call up various sound types at the touch of button in accordance with your listening music type.

Press and hold [MUTE] (SQ) for more than 1 second to select the sound type (SQ) as follows:



(FLAT) flat frequency response: does not emphasize any part. (Default)



(ROCK) speedy and heavy sound: exaggerates bass and treble.



(POP) wide-ranged and deep sound: slightly emphasizes bass and treble.



(VOCAL) clear sound: emphasizes middle tone and slightly emphasizes treble.

Note:

- If no operation takes place for more than 5 seconds in the SQ mode, the display returns to the regular mode.
- Settings of SQ, bass/treble and volume are influenced one another. If such an influence causes distortion to the audio signal, readjust bass/treble or volume. (→ Page 34)

Source

Press [SRC/PWR] to change the source.

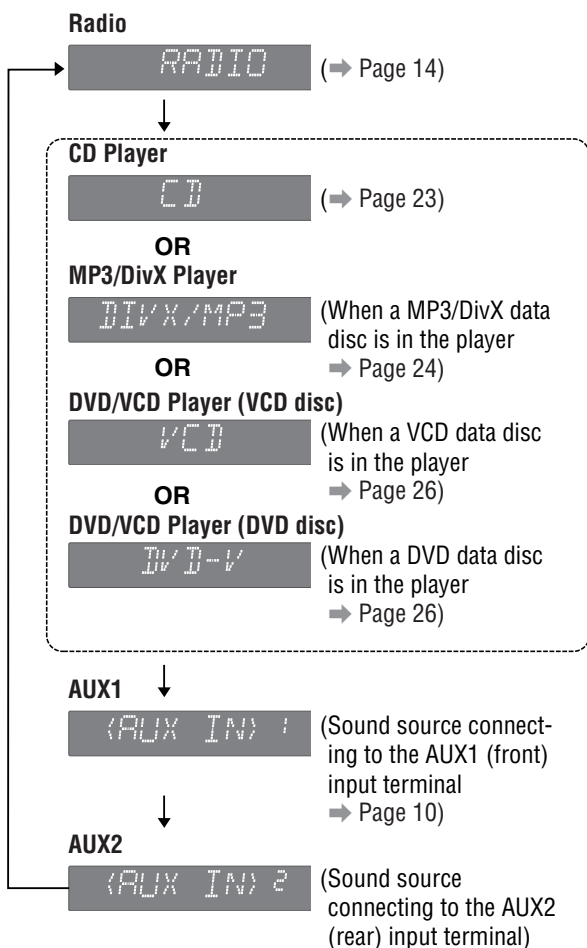

⚠ Caution

- Set the volume level to low enough before the AUX connection is completed. Failure to observe this, the loud noise may come out and damage your speakers and your hearing.

Clock Setting

The 24-hour system is used for the clock.

Note:

- Adjust the clock when “NO CT” appears on the screen.

Select the radio AM (LW/MW) mode. (→ Page 14)

AM 531 Frequency



Press and hold [DISP] (CT) for more than 2 seconds.

CT 0:00 Hour blinks



Adjust the hour.

[>] : put forward hour.
 [<] : put back hour.

CT 8:00 Hour entered



Press [DISP] (CT).

CT 8:00 Minute blinks



Adjust the minute.

[>] : put forward minute.
 [<] : put back minute.

CT 8:37 Minute entered



Press [DISP] (CT).

CT 8:37 Completed





Note:

- When a broadcast of FM Radio Data System is received, the clock is adjusted automatically by the Clock Time service. (→ Page 16)

General (Remote Control Unit)

□ General

In this manual, the pictographs shown below are used to indicate compatible types of discs and operating units.

- Discs**
-  : DVD Video
 -  : VCD (Video CD)
 -  : CD
 -  : CD-Rs/RWs or DVD-Rs/RWs containing MP3 files
 -  : CD-Rs/RWs or DVD-Rs/RWs containing DivX files

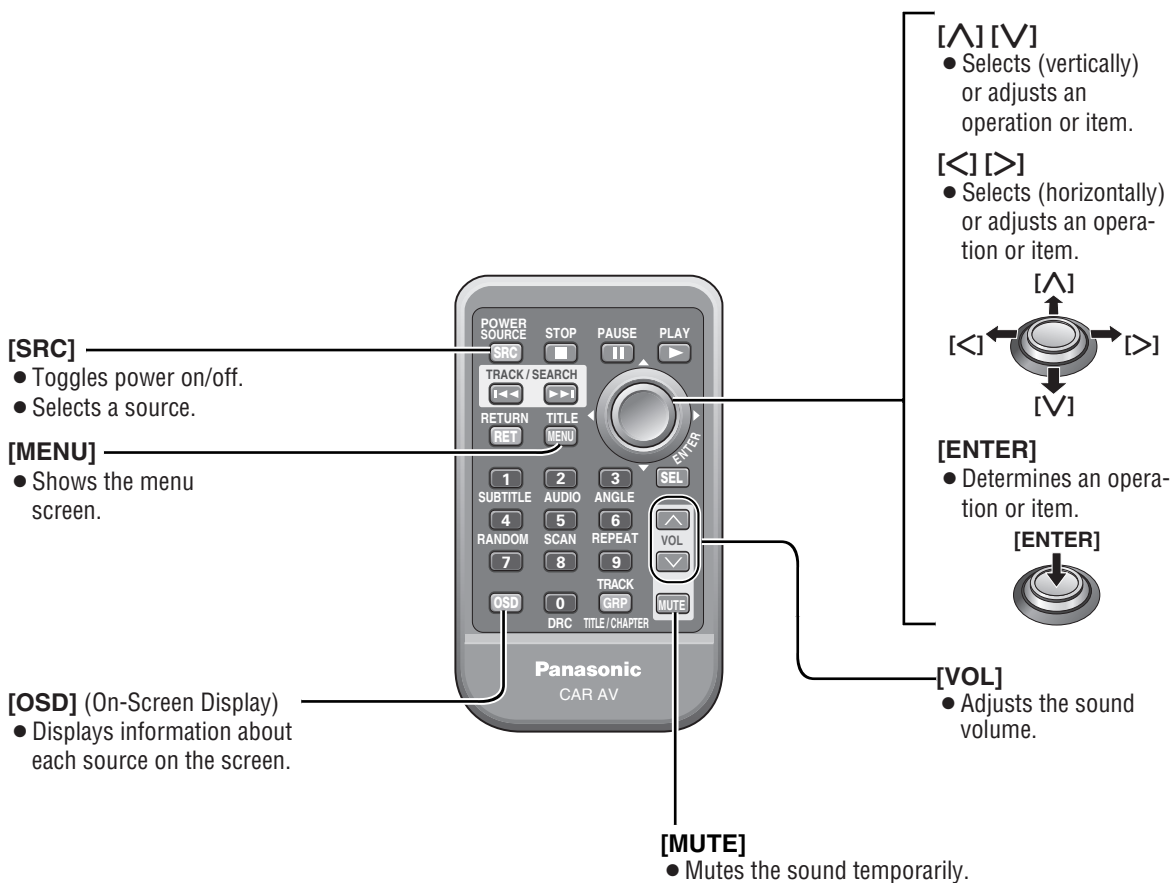

Discs (DVD/VCD/CD/MP3/DivX)

[■] (STOP) DVD VCD CD MP3 DivX

- Stops playback.

[⏸] (PAUSE) DVD VCD CD MP3 DivX

- Pause.

[⏮] DVD VCD

- Frame to Frame Play.

[▶] (PLAY) DVD VCD CD MP3 DivX

- Playback.

[◀◀] [▶▶] DVD VCD CD MP3 DivX

- Goes to the beginning.
- Chapter/track/file selection.
- Fast forward/fast reverse.

[▶▶] DVD VCD

- Slow playback.

[RET] (RETURN)

DVD VCD CD MP3 DivX

- Return to the previous display.
- Input the number again.
- Displays the video CD's menu.

[MENU] (TITLE) DVD

- Displays the DVD menu. (Operations vary according to the disc.)
- Displays the Title menu. (Operations vary according to the disc.)



[^] [v] [◀] [▶] DVD

- Selects an operation or item.

[ENTER] DVD VCD CD MP3 DivX

- Determines an operation or item.

[^] [v] MP3 DivX

- Selects a folder.
- Folder up/down.

[GRP] (Group) (TRACK) (TITLE/CHAPTER) DVD VCD CD MP3 DivX

- Direct title/chapter selection.
- Direct track selection.
- Direct folder/file selection.

[0] to [9] DVD VCD

- Selects an item on the menu.

[0] to [9] DVD VCD CD MP3 DivX

- Direct title/chapter selection.
- Direct track selection.
- Direct folder/file selection.

[0] to [9] DVD

- Sets the language code.

[1] (SUBTITLE) DVD DivX

- Switches the subtitle language.

[2] (AUDIO) DVD DivX

- Switches the audio language.

[2] (AUDIO) VCD

- Switches between stereo and monaural sound.

[3] (ANGLE) DVD

- Switches the angle.

[4] (RANDOM) CD MP3 DivX

- Random play.

[5] (SCAN) CD

- Scan play.

[6] (REPEAT) DVD VCD CD MP3 DivX

- Repeat play.

[0] (DRC) DVD

- Selects a range of dynamic range compression.

Radio

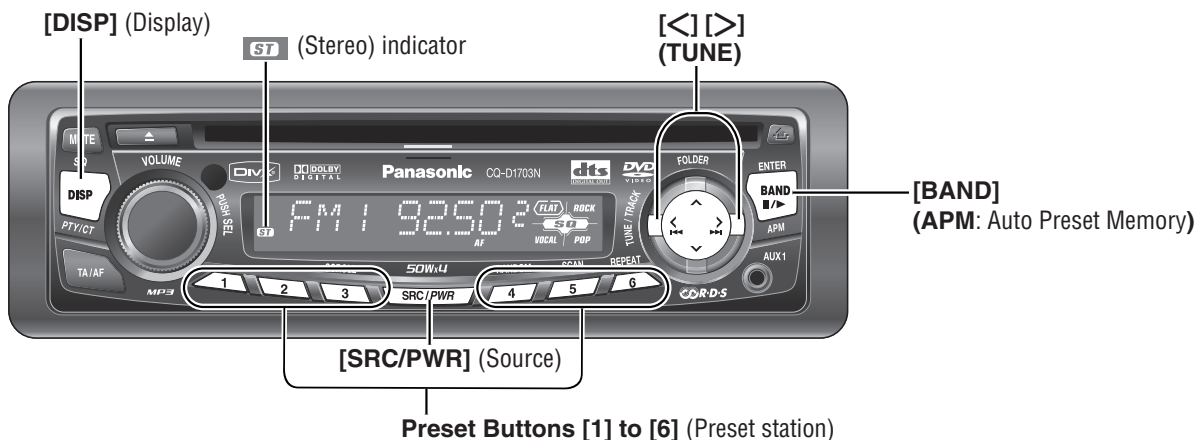

1 Radio Mode

Press [SRC/PWR] to select the radio mode.

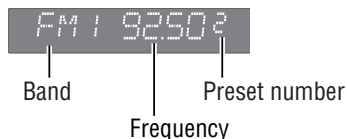

2 Band

Press [BAND].

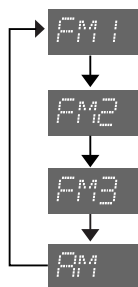

Note:

- For tuning in to only stations whose receiving conditions are good in the seeking mode, set LOCAL to ON. (⇒ Page 36)
- For reducing noise when a receiving FM stereo wave is weak, set FM MONO to ON. (⇒ Page 36)

Display Change

Press [DISP] to change the display as follows.

■AM (LW/MW)

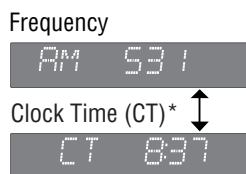

■FM (non RDS)

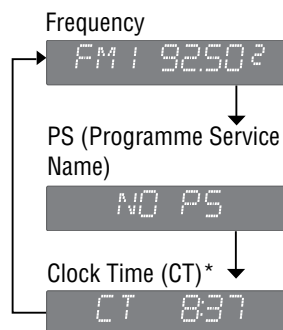

3 Tuning

[>]: Higher frequency

[<]: Lower frequency

Press and hold [>] or [<] for more than 0.5 seconds, then release it. Seeking will start.

*Adjust the clock when "NO CT" appears on the screen. (Clock setting ⇒ Page 11)

Station Preset

Up to 6 stations can be stored in each of the FM1, FM2, FM3 and AM (LW/MW) band selections.

Note:

- New stations overwrite existing saved stations after these procedures.

Warning

- To ensure safety, never attempt to preset stations while you are driving.

Auto Preset Memory (APM)

With this operation, stations with good receiving conditions can be automatically stored in the preset memory.

- ① Select a band. (→ Previous page)
- ② Press and hold **[BAND] (APM)** for more than 2 seconds.

6 stations with first to 6th highest in signal strength will be preset to each band.

Once set, the preset stations are sequentially scanned for 5 seconds each. (scanning)

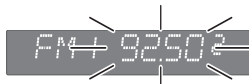

Note:

- To stop scanning, press one of the buttons from **[1]** to **[6]**.
- Only RDS stations will be saved at default setting (AF ON). **To select non-RDS stations, set AF to OFF.** (→ Page 17)

Manual Preset Memory

With this operation, a station can be manually stored in the preset memory.

- ① Select a band and frequency. (→ Previous page)
- ② Press and hold one of the preset buttons from **[1]** to **[6]** until the display blinks once.



Preset number

Preset Station Calling

- ① Select a band. (→ Previous page)
- ② Press one of the preset buttons from **[1]** to **[6]**.

Radio Data System (RDS)

RDS Basics

Some FM stations are broadcasting added data compatible with RDS. This unit offers convenient functions using such data. RDS service availability varies with areas. Please understand if RDS service is not available in your area, the following service is not available, either. This chapter explains the summary and operation regarding RDS.

The following functions are available when receiving RDS stations.

Programme Service Name (PS) Display

The name of the station is displayed.



Programme Identification (PI)

Each programme has its own number. This may be used to search for another frequency on which the same programme is broadcast.

Region (REG)

Each region has its own number. This may be used to identify the region where the station you are now listening to is located.

Alternative Frequency (AF)

When reception is poor, an RDS station broadcasting the same programme is tuned in automatically.

Traffic Programme (TP)

Some RDS FM stations periodically provide a traffic announcement.

Stations which broadcast the traffic announcement are called Traffic Programme (TP).

Traffic Announcement (TA)

Radio announcements on traffic conditions.

Clock Time (CT) Service

When receiving an RDS station, the CT service automatically adjusts the time.

“NO CT” is displayed in areas where CT service is not available. (→ Page 11 for Clock Setting)



Programme Type (PTY) Display

RDS FM stations provide a programme type identification signal.

Example: news, rock, classical music, etc. (→ Page 19)



Alternative Frequency (AF)

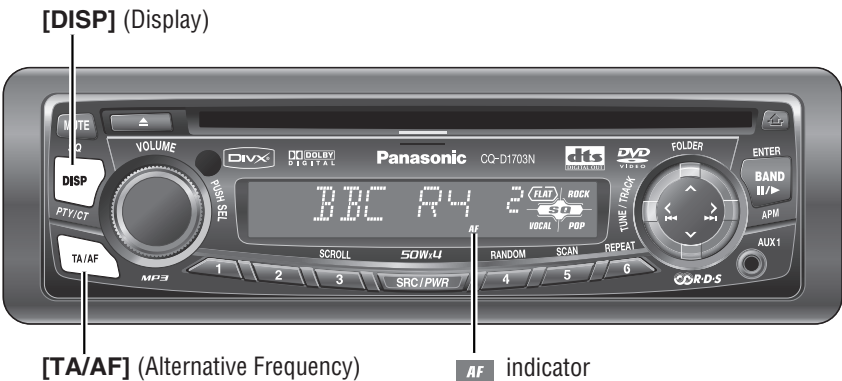

Alternative Frequency (AF) Mode AF

Press and hold **[TA] (AF)** for more than 2 seconds to select one of the following AF modes.

- AF ON** : AF, Best Station Research and PI seek function are active.
- AF OFF** : When the AF network of an RDS station is not required.

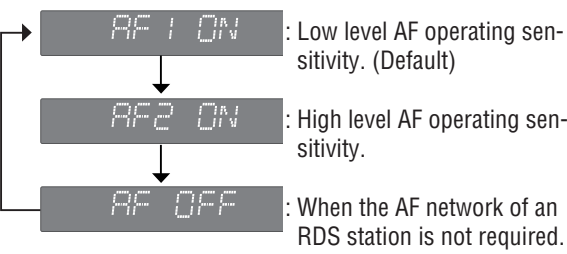

Display Change

Press **[DISP]** to change the display as follows.

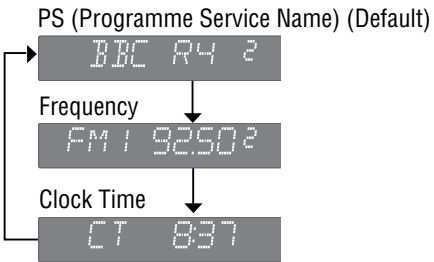

Preset Memory (AF ON Setting)

Preset Station Calling (Best Station Research)

AF self-tuning allows you to select a station with good reception from the same network when the preset tuning is activated.

For Poor Reception (PI Seek)

If reception becomes poor when tuning in a preset station, press the same preset number button. The same station with better reception will be searched for. Press the same preset number button again to cancel.



Note:

- For PI Seek, cancel the TA mode first, then execute PI Seek.

Radio Data System (RDS) (continued)

Traffic Announcement (TA)

Some RDS FM stations periodically provide traffic information.

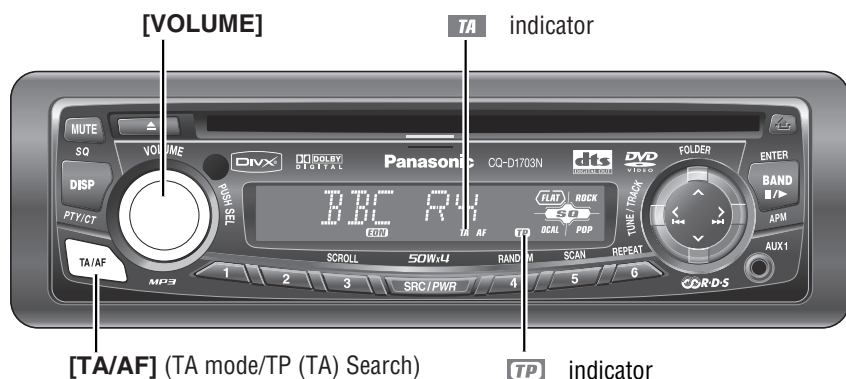

TA ON/OFF **TA** (Default: OFF)

Press **[TA/AF]** (TA mode) to switch the TA mode on and off.

The following functions are available when the TA mode is active.

- A TP station is automatically searched for and received at the instant of toggling the TA mode on if you are receiving a non-TP station or a TP station with poor reception.
- When executing seek tuning or APM, only TP stations are selected. (→ Page 15 for Auto Preset Memory)
- Setting to TA on with the unit in another mode, it will automatically switch to radio mode and a traffic announcement is broadcast on the radio when the traffic announcement begins. The traffic announcement having finished, the unit will return to the previous mode. (TA standby mode)

Traffic information only (TA mute)

While listening to an FM station which is not currently broadcasting traffic announcement, turn the **[VOLUME]** to the counterclockwise to set the volume to 0. The traffic announcement will be output at the TA volume level.

Programme Type (PTY) Reception

RDS FM stations provide a programme type identification signal. (Example: news, rock, classical music, etc.)

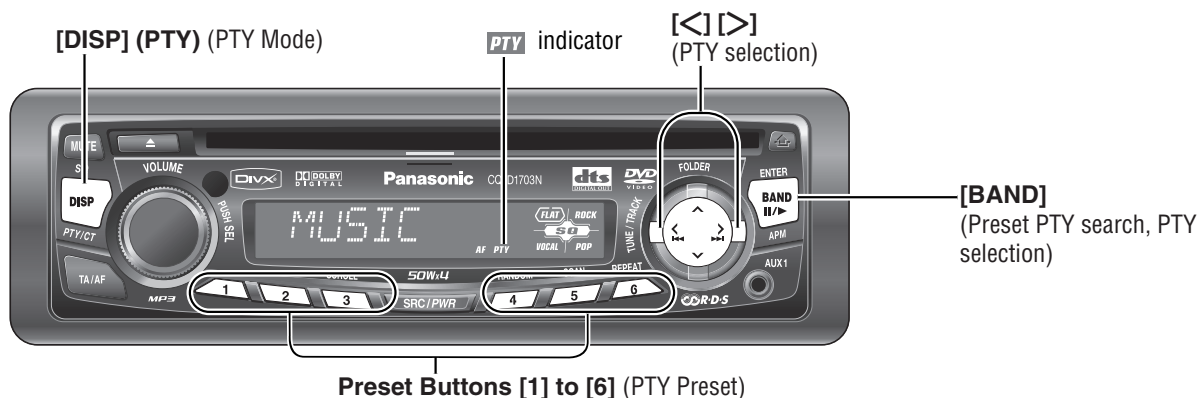

Programme Type (PTY) Mode PTY

Press and hold **[DISP] (PTY)** for more than 2 seconds to switch the PTY display mode on and off. The PTY function described below becomes enabled after selecting to the PTY mode.

PTY Selection

- Press **[>]** to change the programme type as shown below. (**[<]**: opposite direction)

SPEECH	→	MUSIC	→	NEWS	→	AFFAIRS	→
INFO	→	SPORT	→	EDUCATE	→	DRAMA	→
CULTURE	→	SCIENCE	→	VARIED	→	POP_M	→
ROCK_M	→	EASY_M	→	LIGHT_M	→	CLASSICS	→
OTHER_M	→	WEATHER	→	FINANCE	→	CHILDREN	→
SOCIAL	→	RELIGION	→	PHONE_IN	→	TRAVEL	→
LEISURE	→	JAZZ	→	COUNTRY	→	NATION_M	→
OLDIES	→	FOLK_M	→	DOCUMENT	→		

- Select a desired programme type and press **[BAND]**. Search will start to tune in to a station broadcasting the selected programme type.



Press **[BAND]** again to cancel.

Note:

- When there is no corresponding programme type station, "NONE" is displayed for 2 seconds.

PTY Preset

PTY Preset Call

Programme types are stored in memory under preset buttons from **[1]** to **[6]** as shown in the table on the next page.

To tune in a desired programme type, press any of preset buttons from **[1]** to **[6]**.

Preset PTY Search

- Select a programme type by pressing the preset button. The preset programme type appears on the display for 5 seconds.
Example: Press preset button **[1]**.
- Press the same preset button again (or press **[BAND]**) to tune in the desired programme type station.
Example: Press preset button **[1]** again. Press **[BAND]** again to cancel.

Note:

- When there is no corresponding programme type station, "NONE" is displayed for 2 seconds.

PTY Preset Change

- Select a programme type by using PTY Selection or pressing PTY Preset buttons.
- Press and hold one of the buttons from **[1]** to **[6]** for more than 2 seconds.
Example: Press and hold preset button **[2]** for more than 2 seconds.

Radio Data System (RDS) (continued)

Programme Type (PTY) Reception (continued)

PTY Preset (Default)

Preset No.	Programme Type	When PTY search is activated, these programme types are receivable.
1	NEWS	NEWS
2	SPEECH	AFFAIRS, INFO, EDUCATE, DRAMA, CULTURE, SCIENCE, VARIED, WEATHER, FINANCE, CHILDREN, SOCIAL, RELIGION, PHONE_IN, TRAVEL, LEISURE, DOCUMENT
3	SPORT	SPORT
4	POP_M	POP_M
5	CLASSICS	CLASSICS
6	MUSIC	ROCK_M, EASY_M, LIGHT_M, OTHER_M, JAZZ, COUNTRY, NATION_M, OLDIES, FOLK_M

Other PTY functions

PTY Language Selection: The language displayed on the screen is selectable. (English or Swedish) (→ Page 36)

Other RDS functions

Enhanced Other Network (EON)

EON



EON indicator

When EON data is received, the EON indicator lights and the TA and AF functions are expanded as follows.

TA: Traffic information from the current and other network stations can be received.

AF: The frequency list of preset RDS stations is updated by EON data.

EON enables the radio to make fuller use of RDS information. It constantly updates the AF list of preset stations, including the one that is currently tuned in to. For example, if you preset a station far from home, you will later be able to receive the same station at an alternative frequency, or another station serving the same programme. EON also keeps track of locally available TP stations for quick reception.

Emergency Announcement Reception

When an emergency announcement is broadcast, the unit is automatically switched to receiving the broadcast even if a source other than radio is selected. During receiving the emergency announcement, "ALARM" appears on the display.



Note:

- Emergency announcements are broadcast at the TA volume level (→ Page 18). Use caution not to decrease the TA volume excessively.

Before Disc Playback

Caution

- Do not insert a disc when **DISC** indicator lights because a disc is already loaded.
- Do not use irregularly shaped discs.
- Do not use discs that have a seal or label attached.
- Do not insert foreign objects into the disc slot.

Note:

- Refer to "Discs that can be Played Back". (⇒ Page 8)
- Refer to the section on "Notes on MP3/DivX" (⇒ Page 32) and "Notes on Discs" (⇒ Page 47).
- The power will be turned on automatically when a disc is loaded. (ACC ON)
- A disc which has both CD-DA data and MP3/DivX data on it may not be played back normally.

OSD (On-Screen Display)

(Only for remote control unit)

You can set up the optional monitor (CY-VM7203N) to display or hide the information on the disc.

Press [OSD] to switch the OSD text displays. (⇒ Page 30)

Disc Insert

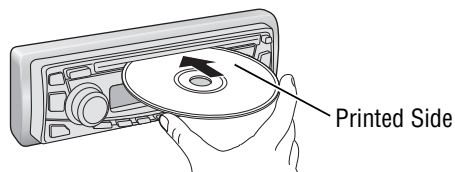

Note:

- It may take some time to start playing.
- Playback will start automatically after recognizing the data of the loaded disc.

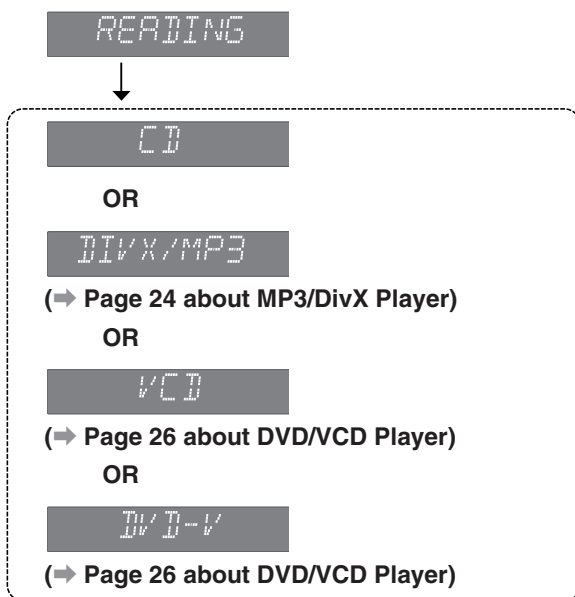

Disc Eject

Press [▲].

CD Player

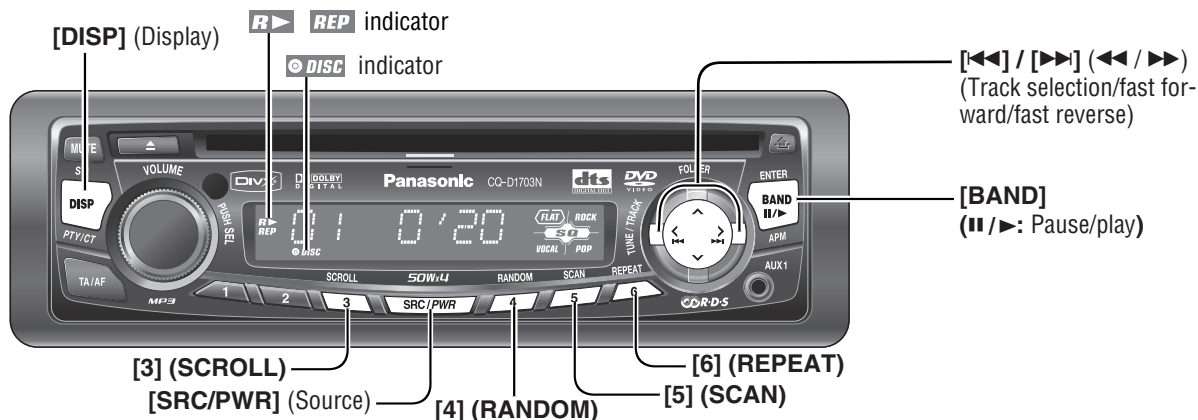

When CD is in the player

Press [SRC/PWR] to select the CD player mode and play-back starts.



Display Change

Press [DISP].

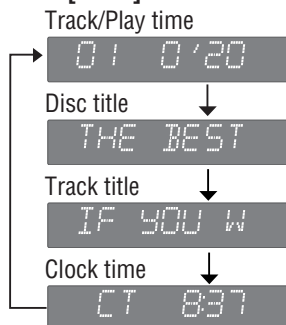

Note:

- "NO TEXT" is displayed when there is no information on the disc.
- To have another circle scroll while a title is displayed, press [3] (SCROLL).

Track Selection

[>>>]: Next track

[<<<]: Beginning of the current track

For the previous track, press twice.

Fast Forward/Fast Reverse

Press and hold for more than 0.5 seconds.

Each time you press the button, the speed changes as follows.
Regular speed → 2 times → 5 times → 10 times → 20 times

[>>>] (>>>): Fast forward

[<<<] (<<<): Fast reverse

Press [BAND] (|| / >) to cancel.

Pause (|| / >)

Press [BAND] (|| / >).



Press [BAND] (|| / >) again to cancel.

Random Play

All the available tracks are played in a random sequence.

Press [4] (RANDOM).

lights.

Press [4] (RANDOM) again to cancel.

Scan Play

The first 10 seconds of each track is played in sequence.

Press [5] (SCAN).



Press [5] (SCAN) again to cancel.

Repeat Play

The current track is repeated.

Press [6] (REPEAT).

lights.

Press [6] (REPEAT) again to cancel.

Direct Track Selection

(Only for remote control unit)

Example: Track number 10



① Press [GRP].

② Press [1] [0]. (Press [RET] to cancel.)

③ Press [ENTER].

Note:

- To suspend direct selection, press [DISP].

- Random, Scan and Repeat plays are canceled once [ENTER] is pressed.

MP3/DivX Player

The optional monitor (CY-VM7203N) is necessary to be connected to see images of DivX files.

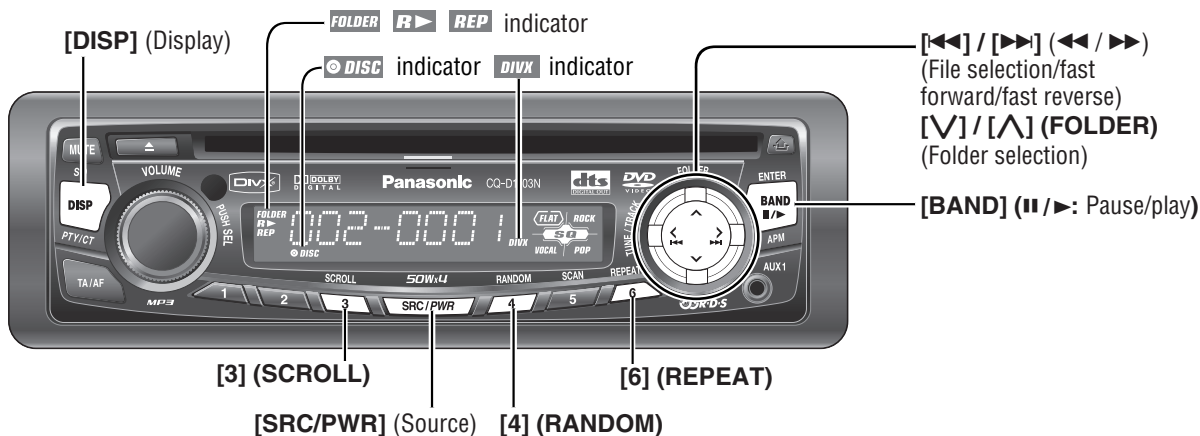

Note:

- This unit is not compatible with WMA file.
- Refer to “Notes on MP3/DivX” (⇒ Page 32).

When a disc is in the player

Press [SRC/PWR] to select the MP3/DivX player mode and playback starts.

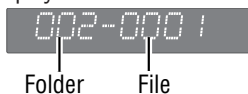

Note:

- “NO TEXT” is displayed when there is no information on the disc.
- To have another circle scroll while a title is displayed, press [3] (SCROLL).

Display Change

Press [DISP].

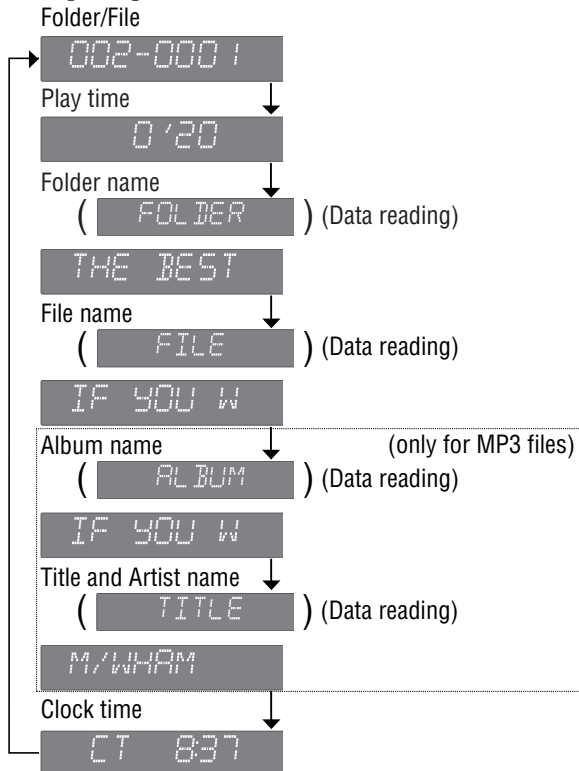

Folder Selection

- [^]: Next folder
- [V]: Previous folder

File Selection

- [>>]: Next file
- [<<]: Beginning of the current file
- For the previous file, press twice.

Fast Forward/Fast Reverse

Press and hold for more than 0.5 seconds. The speeds of fast forward and fast reverse change incrementally in 4 steps every time the corresponding button is pressed.

- [>>>] (>>>): Fast forward
- [<<<] (<<<): Fast reverse
- Press [BAND] (|| / >) to cancel.

Note:

- The speeds of fast forward and fast reverse vary with the file type, file specifications, and other factors.

Pause (|| / >)

Press [BAND] (|| / >).



Press [BAND] (|| / >) again to cancel.

Random Play **R▶**

All the available files are played in a random sequence.

Press **[4] (RANDOM)**.

R▶ lights.

Press **[4] (RANDOM)** again to cancel.

Folder Random Play **FOLDER R▶**

All the files in the current folder are played in a random sequence.

Press and hold **[4] (RANDOM)** for more than 2 seconds.

FOLDER R▶ light.

Press and hold **[4] (RANDOM)** again for more than 2 seconds to cancel.

Repeat Play **REP**

The current file is repeated.

Press **[6] (REPEAT)**.

REP lights.

Press **[6] (REPEAT)** again to cancel.

Folder Repeat Play **FOLDER REP**

The current folder is repeated.

Press and hold **[6] (REPEAT)** for more than 2 seconds.

FOLDER REP light.

Press and hold **[6] (REPEAT)** again for more than 2 seconds to cancel.

Direct Selection

(Only for remote control)

Direct Folder Selection

Example: Folder number 10 (⇒ Page 33)

FLDR _ 10

- ① Press **[GRP]** twice.
- ② Press **[1] [0]**. (Press **[RET]** to cancel.)
- ③ Press **[ENTER]**.

Direct File Selection

Example: File number 10

FILE _ _ 10

- ① Press **[GRP]**.
- ② Press **[1] [0]**. (Press **[RET]** to cancel.)
- ③ Press **[ENTER]**.

Note:

- To suspend direct selection, press **[DISP]**.
- Random, Folder Random, Repeat and Folder Repeat plays are canceled once **[ENTER]** is pressed.

DivX display example



DVD/VCD Player

You can enjoy watching DVDs and VCDs if the optional monitor (CY-VM7203N) is connected.

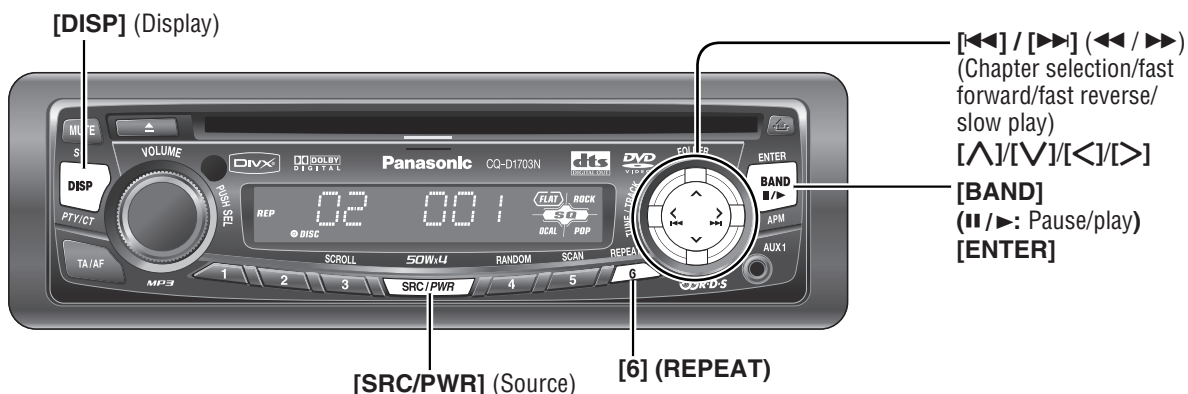

When a disc is in the player

Press [SRC/PWR] to select the DVD/VCD player mode and playback starts. (If automatic start is not performed, press [▶] (PLAY) of the remote control, or try to operate it manually according to the menu screen of the disc.)

(When DVD disc is in the player)

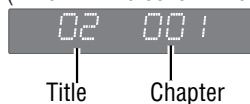

(When VCD disc is in the player)



Display Change

Press [DISP].

■ DVD disc

Title/Chapter



Clock time



■ VCD disc

VCD



Clock time



DVD display example



Chapter Selection

[>>>]: Next chapter

[<<<]: Beginning of the current chapter
For the previous chapter, press twice.

Fast Forward/Fast Reverse

Press and hold for more than 0.5 seconds.

Each time you press the button, the speed changes as follows.
Regular speed → 2 times → 5 times → 10 times → 20 times

[>>>] (>>>): Fast forward

[<<<] (<<<): Fast reverse

Press [BAND] (|| / ▶) to cancel.

Pause (|| / ▶)

Press [BAND] (|| / ▶).



Press [BAND] (|| / ▶) again to cancel.

Slow play

Press and hold [>>>] for more than 0.5 seconds during pausing.

Press [BAND] (|| / ▶) again to cancel.

Repeat Play

The current chapter is repeated.

Press and hold [6] (REPEAT) for more than 2 seconds.
 light.

Press and hold [6] (REPEAT) again for more than 2 seconds to cancel.

Disc Menu

You can stop playing the disc temporarily and call up the on-disc menu screen.

- ① Press **[MENU]** on the remote control during playback.
- ② Press **[^]/[v]/[<]/[>]** to select an item.
- ③ Press **[ENTER]** to determine the selection.

Title Menu

You can stop playing the disc temporarily and call up the on-disc title menu screen.

- ① Press and hold **[MENU] (TITLE)** on the remote control for more than 2 seconds during playback.
- ② Press **[^]/[v]/[<]/[>]** to select an item.
- ③ Press **[ENTER]** to determine the selection.

Note:

- You can also select an item by pressing **[0]** to **[9]** on the remote control. (Press **[RET]** to cancel the operation.)

Functions Only by Remote Control Unit

Stop

Press **[■]** (STOP).

Press **[▶]** (PLAY) to resume playback from the point where **[■]** (STOP) is pressed. (Continued playback function)

To cancel continued playback, press **[■]** (STOP) again in the stop mode.

Frame to Frame Play

Press **[⏏]** (PAUSE) to go to next frame in the pause.

To resume normal playback, press **[▶]** (PLAY).

Direct Selection (during playback)

Direct Chapter Selection

Example: Chapter number 10

CHAPT_10

- ① Press **[GRP]**.
- ② Press **[1] [0]**. (Press **[RET]** to cancel.)
- ③ Press **[ENTER]**.

Direct Title Selection

Example: Title number 10

TITLE_10

- ① Press **[GRP]** twice.
- ② Press **[1] [0]**. (Press **[RET]** to cancel.)
- ③ Press **[ENTER]**.

List Selection

Only for PBC-applicable (Playback control → Page 45)

VCDs or some DVDs

Example: List number 10

NUMBER

- ① Press **[1] [0]**. (Press **[RET]** to cancel.)
- ② Press **[ENTER]**.

Note:

- If a non-existent title/chapter/track/number is input and entered, the command is invalid and the display returns to regular mode.
- Direct title selections can be made by pressing **[GRP]** once in the stop mode. 
- To return to the regular mode, press **[DISP]**.

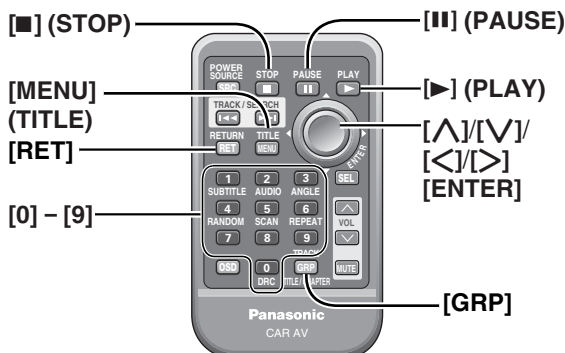

Advanced Operation for Video Discs (DVD/VCD/DivX)

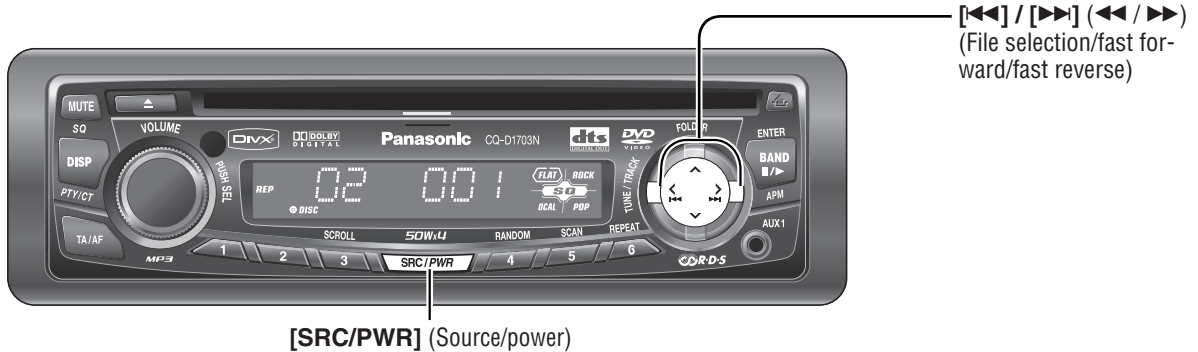

About DivX VOD content

DivX Video-on-Demand (VOD) content is encrypted for copyright protection. In order to play DivX VOD content on this unit, you first need to register the unit.

Follow the on line instructions for purchasing DivX VOD content to enter the unit's registration code and register the unit. For more information about DivX VOD, visit www.divx.com/vod.

Display the unit's registration code

(Only for remote control unit, → Page 42 "User Settings")

- ① Press **[MENU]**
- ② Press **[9]**.



8 alphanumeric characters

Note:

- We recommend that you make a note of this code for future reference.
- After playing DivX VOD content for the first time, another registration code is then displayed in "DivX Registration". Do not use this registration code to purchase DivX VOD content. If you use this code to purchase DivX VOD content, and then play the content on this unit, you will no longer be able to play any content that you purchased using the previous code.
- If you purchase DivX VOD content using a registration code different from this unit's code, you will not be able to play this content. ("Authorization Error" is displayed.)

Regarding DivX content that can only be played a set number of times

Some DivX VOD content can only be played a set number of times. When you play this content, the remaining number of plays is displayed. You cannot play this content when the number of remaining plays is zero. ("Rental Expired" is displayed.)

When playing this content

- The number of remaining plays is reduced by one if
 - you press **[SRC/PWR]**.
 - you press **[■] (STOP)** on the remote control unit.
 - you press **[[<<] / [>>]] (<< / >>)]** etc. and arrive at another content or the start of the content being played.
- Resume (→ Page 27 "Stop") function does not work.

Functions Only by Remote Control Unit

Subtitle

You can select a subtitle language if the loaded disc has multi-language subtitles.

When **[1] (SUBTITLE)** is kept pressed for more than 1 second, the subtitle language is changed over at the intervals of 1 second.

Audio

You can select an audio channel if the disc holding multi-audio channels is loaded.

When **[2] (AUDIO)** is kept pressed for more than 1 second, the audio channel is changed over at the intervals of 1 second.

Note:

- Channel change may take time when a DivX file plays depending on its file structure.

Audio

You can select audio output among “STEREO”, “MONO L” and “MONO R”.

When **[2] (AUDIO)** is kept pressed for more than 1 second, the audio output is changed over at the intervals of 1 second.



Angle

You can select an angle if a multi-angle disc is loaded.

When **[3] (ANGLE)** is kept pressed for more than 1 second, the angle is changed over at the intervals of 1 second.

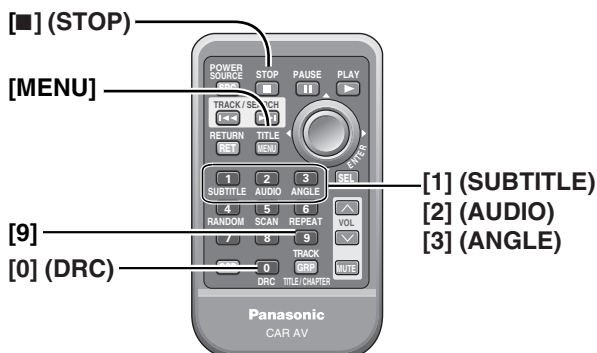

D.Range Compression

You can select a range of dynamic range compression. This function is effective for playback of Dolby Digital/Dolby Surround DVD video. The words of an actor hardly audible during playback at a low volume, for example, will become easier to listen to by selecting “MINIMUM”.

- ① Press and hold **[0] (DRC)** during playback for more than 2 seconds to activate the DRC selection mode.
- ② Press and hold **[0] (DRC)** for more than 2 seconds to select a range of DRC.

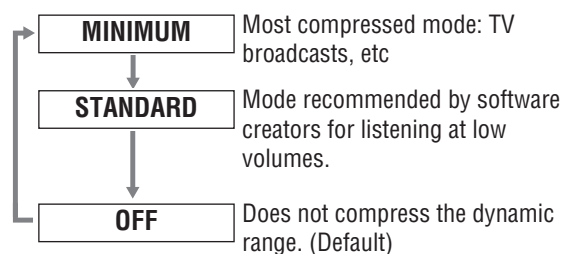

Conversation level

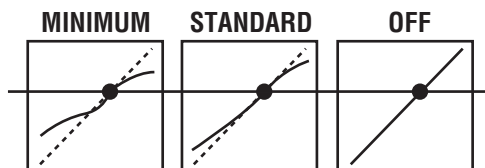

Caution

- The sound of DVD video covers a wide dynamic range of more than 100 dB. Thus, the reproduced sound volume of some DVD discs may be significantly low. When you increase the volume in this case, the sound may reach the peak level suddenly and it may lead to a traffic accident. To avoid such an accident, you can use this function.

OSD (On-Screen Display)

You can see OSDs (On-Screen Display) if the optional monitor (CY-VM7203N) is connected.

OSD (On-Screen Display)

(Only for remote control unit)

You can set up the optional monitor to display or hide the following information: title/artist name for CDs, album/title/artist name for MP3, playtime for VCDs/DivX and title/chapter/playtime for DVDs.

Each time you press [OSD], the display changes according to the disc type.

■ CD (Music CD)

Track play time

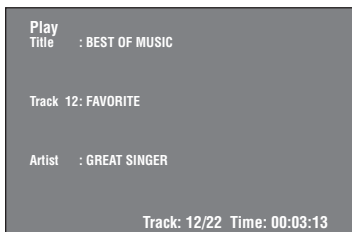

Total play time

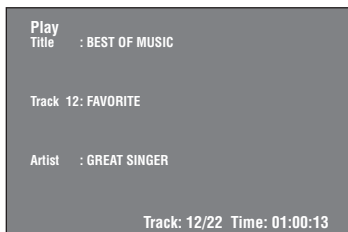

CD player mode

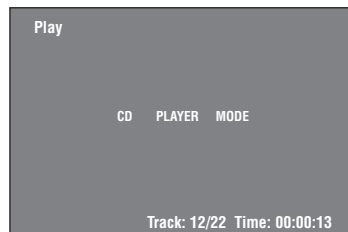

■ MP3

ID3 TAG ON

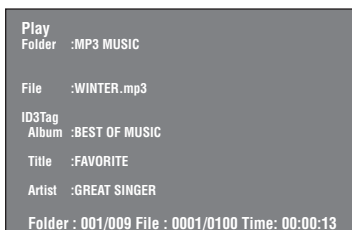

MP3 player mode

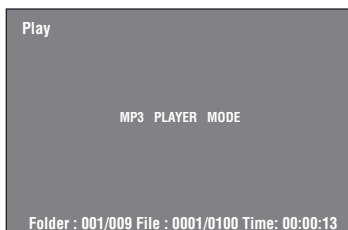

■ DivX

Text off



DivX player mode



■ DVD (DVD Video)

Text off



Chapter play time



Total play time



■ VCD (Video CD)

Text off



Play time



[OSD]

Notes on MP3/DivX

What is MP3/DivX?

MP3: MP3 (MPEG Audio Layer-3) is the compression format of digital audio. It is developed by MPEG (Motion Picture Experts Group). Using this compression format, you can record the contents of about 10 music CDs on a single CD (This figure refers to data recorded on a 650 MB CD-R or CD-RW at a fixed bit rate of 128 kbps and a sampling frequency of 44.1 kHz).

DivX: The video compression format developed by DivX, Inc. compresses video files without any considerable loss of video quality.

Note:

- MP3/DivX encoding and CD writing software programs are not supplied with this unit.

Points to remember when making MP3/DivX files

Common

- High bit rate and high sampling frequency are recommended for high quality sound.
- Selecting VBR (Variable Bit Rate) is not recommended because playing time is not displayed properly and sound may be skipped.
- The playback sound quality differs depending on the encoding circumstances. For details, refer to the instructions of your own encoding software and writing software.

MP3

- It is recommended to set the bit rate to “128 kbps or more” and “fixed”.

DivX

- DivX files greater than 2GB or having no index may not play properly on this unit.
- This unit supports all resolutions up to maximum of 720 x 480 (NTSC)/720 x 576 (PAL).
- You can select up to 8 types of audios and subtitles on this unit.
- GMC (Global Motion Compensation) is not supported.

Caution

- **Never put “.mp3” to other than MP3-formatted data or “.DIVX”, “.divx”, “.AVI”, and “.avi” to other than DivX-formatted data. This may not only produce noise from the speaker damage, but also damage your hearing.**

Display Information (on the Main Unit)

Displayed items

- **CD-TEXT**
 - Disc title
 - Track title
- **MP3/DivX**
 - Folder name
 - File name
- **MP3 (ID3 tag)**
 - Album name
 - Title and artist name

Displayable characters

- Displayable length of file name/folder name: within 64 characters. (Unicoded file and folder names are reduced by half in the number of displayable characters.)
- Name files and folders in accordance with the standard of each file system. Refer to the instructions of writing software for details.
- ASCII character set can be displayed.
- Some Cyrillic characters in the Unicode can be displayed.

ASCII character set

A to Z, a to z, digits 0 to 9, and the following symbols:
(space) ! " # \$ % & ' () * + , - . / : ; < = > ? @ [\] ^ _ ` { | } ~

Note:

- With some software in which MP3/DivX format files have been encoded, the character information may not be displayed properly.
- Undisplayable characters and symbols will be converted into an asterisk (*).
- It is recommended that the length of the file name is less than 8 (excluding the file extension).

Recording MP3/DivX files on a CD/DVD-media

- It is recommended not to use a disc holding two or more different format types of files.
- If CD-DA files are on the same disc as MP3 or DivX files, the songs and the movies may not play in the intended order, or some songs or movies may not play at all.
- When storing MP3 data and DivX data on the same disc, use different folders for each data.
- Do not record files other than MP3/DivX files and unnecessary folder on a disc.
- The name of an MP3/DivX file should be added by rules as shown in the following descriptions and also comply with the rules of each file system.
- The file extension “.mp3” should be assigned to MP3 files.
- The file extension “.DIVX”, “.divx”, “.AVI” or “.avi” should be assigned to DivX files.

- You may encounter trouble in playing MP3/DivX files or displaying the information of MP3/DivX files recorded with certain writing software or CD/DVD recorders.
- This unit does not have a play list function.
- Although Multi-session recording is supported, the use of Disc-at-Once is recommended.

Supported file systems

ISO 9660 Level 1/Level 2, Apple Extension to ISO 9660, Joliet, Romeo

Note:

- Apple HFS, UDF 1.50, Mix CD and CD Extra are not supported.

Audio compression formats (Recommendation: “Points to remember when making MP3/DivX files” on the previous page)

Compression method	Bit rate	VBR	Sampling frequency
MPEG 1 audio layer 3 (MP3)	32 k – 320 kbps	Yes	32, 44.1, 48 kHz
MPEG 2 audio layer 3 (MP3)	8 k – 160 kbps	Yes	16, 22.05, 24 kHz
DivX data created using ver.3.11, 4.x, 5.x*	8 k – 320 kbps	Yes	8 k – 48 kHz

* DivX video system/MP2, MP3

Note:

- VBR is not recommended.

Folder selection order/file playback order

Maximum number of files/folders

- Maximum number of files: 1200
- Maximum number of files in one folder: 1200
- Maximum depth of trees: 8
- Maximum number of folders: 255 (Root folder is included.)

Note:

- You can shorten the duration between data read and playback by decreasing the quantity of files or folders, or the depth of the hierarchy.
- This unit counts the number of folders irrespective of the presence or absence of an MP3/DivX file.
- If the selected folder does not contain any MP3/DivX files, the nearest MP3/DivX files in the order of playback will be played.
- Playback order may be different from other MP3/DivX players even if the same disc is used.
- “ROOT” appears when displaying the root folder name.

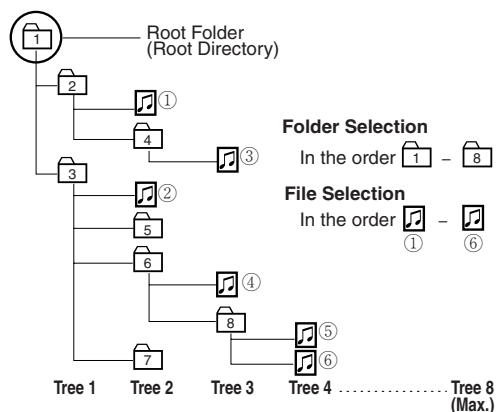

Copyright

It is prohibited by copyright laws to copy, distribute and deliver copyrighted materials such as music without the approval of copyright holder except enjoying yourself personally.

No warranty

The above description complies with our investigations as of May 2006. It has no warranty for reproducibility and displayability of MP3/DivX.

Audio Settings

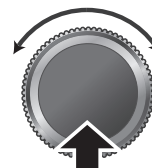
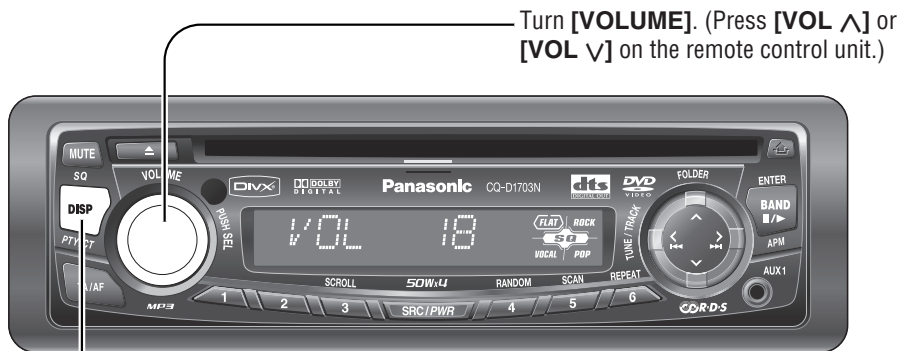

Press **[VOLUME]**
(PUSH SEL: select).
(Press **[SEL]** on the
remote control unit.)

[DISP] (Return to the regular mode)

Volume

Default: 18
Setting range: 0 to 40

Press **[VOLUME]** (**PUSH SEL**)
to open the menu.

VOL 18

Bass/Treble

You can adjust the bass and treble sounds.
Default: BAS (bass) 0 dB
TRE (treble) 0 dB
Setting range: -12 dB to +12 dB (by 2 dB)

Press **[VOLUME]** (**PUSH SEL**).

BASS

Press **[VOLUME]** (**PUSH SEL**).

TREBLE

Balance/Fader

You can adjust the sound level among the right, left, front and rear speakers.
Default: BAL (balance) CNT (centre)
FAD (fader) CNT (centre)
Setting range: 15 levels each and CNT (centre)

Press **[VOLUME]** (**PUSH SEL**).

BALANCE

Press **[VOLUME]** (**PUSH SEL**).

FADER

Audio Output Level (for P-MODE)

The audio output level to the rear monitor is adjustable when P-MODE is set to ON. (→ Page 38).
Default: MIN
Setting range: MIN (minimum), MID (middle) and MAX (maximum)

Press **[VOLUME]** (**PUSH SEL**).

REAR LV

(LV: LEVEL)

Regular mode

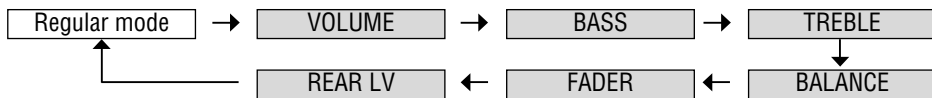

Note:

- To return to the regular mode, press **[DISP]**.
- If no operation takes place for more than 5 seconds in audio setting (2 seconds in the volume adjustment), the display returns to the regular mode.
- The volume can also be adjusted directly using **[VOLUME]** on the main unit. (⇒ Page 10)
- Balance/Fader is not selectable when P-MODE (private mode ⇒ Page 38) is set to ON. (“CAN’T SEL” appears.)

Turn **[VOLUME]**.

① : Up
② : Down

Turn **[VOLUME]**.

① : Up
② : Down

Turn **[VOLUME]**.

① : Up
② : Down

Turn **[VOLUME]**.

① : Right enhanced
② : Left enhanced

Turn **[VOLUME]**.

① : Front enhanced
② : Rear enhanced

Turn **[VOLUME]**.

① : Up
② : Down

Note:

- Adjust the audio volume of the rear monitor if necessary.

Function Settings

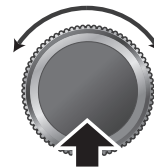
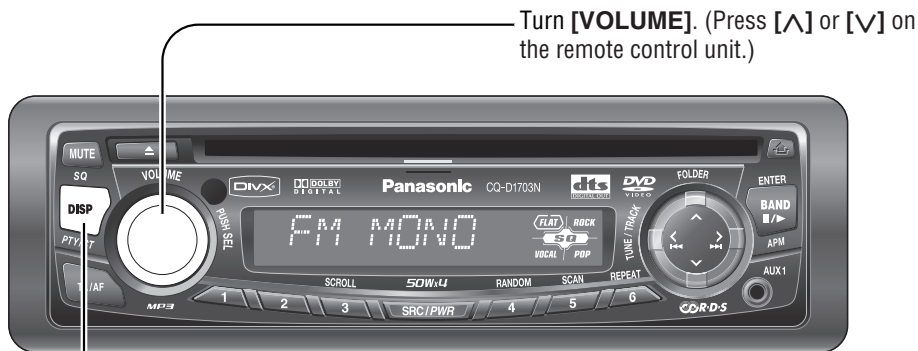

Press and hold [VOLUME] (PUSH SEL) for more than 2 seconds.

[DISP] (Return to the regular mode)

FM Monaural Reception (FM mode) MONO

Noise is significantly decreased when weak signals are received from an FM broadcast station.
Default: OFF

Press and hold [VOLUME] (PUSH SEL) for more than 2 seconds to open the menu.

FM MONO

Local Tuning (Radio mode) LOCAL

Only stations with good reception are detected in seek tuning.
Default: OFF

Press [VOLUME] (PUSH SEL).

FM LOCAL

AM LOCAL

Region (REG) Mode (FM mode)

Changes the selection range of AF, Best Station Research and PI seek.

Default: OFF

Note:

- When REG mode is switched from OFF to ON or vice versa, AF mode turns on automatically.

Press [VOLUME] (PUSH SEL).

REGION

PTY Language Selection (RDS mode)

Default: ENGLISH

Press [VOLUME] (PUSH SEL).

PTY LANG

(Page 38)

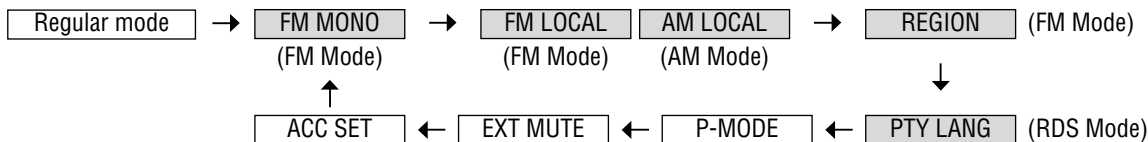

Note:

- To return to the regular mode, press **[DISP]**.
- If no operation takes place for more than 5 seconds in function setting, the display returns to the regular mode.

Turn **[VOLUME]**.

① **MONO ON** : MONO ON

↕

② **MONO OFF** : MONO OFF (Default)

Turn **[VOLUME]**.

① **LOC ON** : LOCAL ON

↕

② **LOC OFF** : LOCAL OFF (Default)

Turn **[VOLUME]**.

① **REG ON** : The frequency is changed only for programmes within the region.

↕

② **REG OFF** : The frequency is changed also for programmes outside the region. (Default)

Turn **[VOLUME]**.

① **ENGLISH** : English (Default)

↕

② **SVENSKA** : Swedish

Function Settings (continued)

Turn [VOLUME]. (Press [^] or [v] on the remote control unit.)

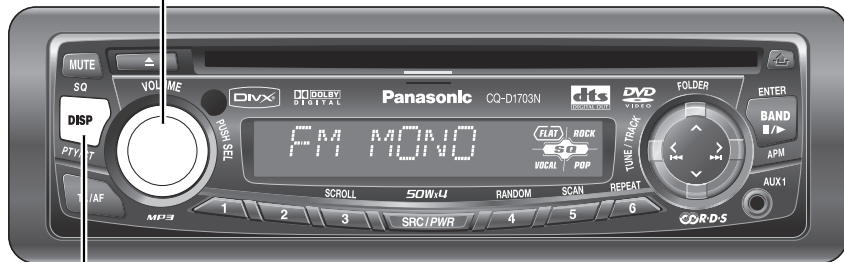

[DISP] (Return to the regular mode)

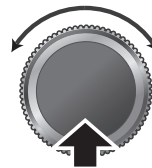

Press [VOLUME] (PUSH SEL: select).

Private Mode (P-MODE)

Private Mode can be toggled.

Default: OFF

P-MODE ON: Provides rear seat passengers with images and sounds of Discs. This setting selects Disc Player (CD/MP3/DVD/VCD/DivX) as a source for the rear monitor and decreases the audio output from the rear speakers to zero. Use of rear monitor's headphones with this setting can relax rear seat passengers.

P-MODE OFF: Provides passengers in both the front and rear seats with the same source.

Press [VOLUME] (PUSH SEL).

P-MODE

External Mute

Allows you to mute the current source while Panasonic navigation system provides voice guidance or car telephone conversation is in progress.

Default: 0

Setting range: 0 to 2, OFF

Press [VOLUME] (PUSH SEL).

EXT MUTE

ACC Selection

Default: OFF

Caution

- Be sure to select OFF when your car has no ACC position in the ignition switch. Failure to do this could cause the battery to go dead.

Press [VOLUME] (PUSH SEL).

ACC SET

(Page 36)

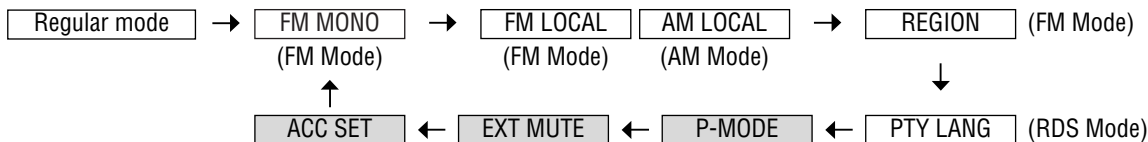

Note:

- To return to the regular mode, press **[DISP]**.
- If no operation takes place for more than 5 seconds in function setting, the display returns to the regular mode.

Turn **[VOLUME]**.

① **MODE ON** : P-MODE ON

② **MODE OFF** : P-MODE OFF

P-MODE (P-MODE) indicator

Note:

- Be sure to select P-MODE OFF when P-MODE is not used.
- P-MODE ON cannot be selected ("CAN'T SEL" displayed) when no disc is loaded in this unit.
- Ejection of the disc activates P-MODE OFF.

Turn **[VOLUME]**.

① **MUTE LVD** : No sound (Default)

② **MUTE LV1** : 15 steps decrease

③ **MUTE LV2** : 10 steps decrease

④ **MUTE OFF** : Unchanged

MUTING 0
When External Mute is activated.
(**Example:** MUTE LV 0)

Turn **[VOLUME]**.

① **ACC ON**
Set to ON if **your car has ACC position.**

② **ACC OFF**
Set to OFF if **your car has no ACC position.**
(Default)

ACC ON

- The power is turned on when a disc is inserted while the power is off.
- The Clock Time can be displayed while power is off.

User Settings

The following information explains the settings only about the disc player and displayed contents on the screen.
(Only for Remote Control Unit)

1 Display "Setup Menu".

Press [MENU].

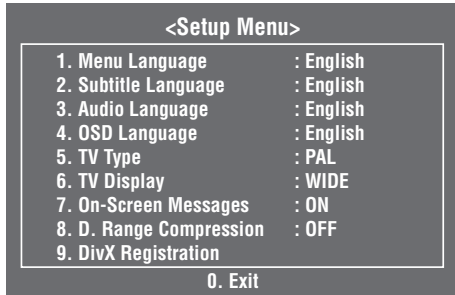

2 Select each setting menu.

Press one of the numeric buttons from [1] to [9].
(Example: "1. Menu Language")

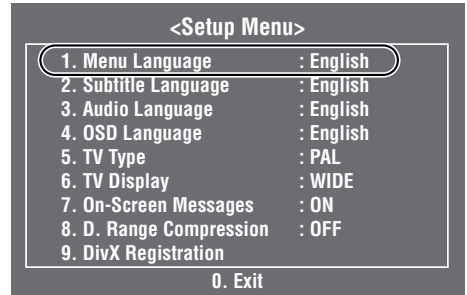

Note:

- Setup Menu has been arranged not for any DVD disc but for this unit.
- Setup Menu is operable only if the disc source has been selected. (No disc playing)

1. Menu Language

Disc menu language selection
Default: English

2. Subtitle Language

Default: English

3. Audio Language

Default: English

4. OSD Language

Default: English

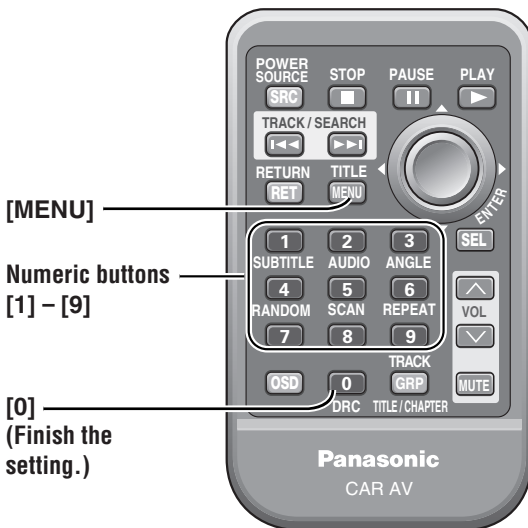

3 Select each item.

Press one of the numeric buttons from [1] to [9].
(Example: "1. English")

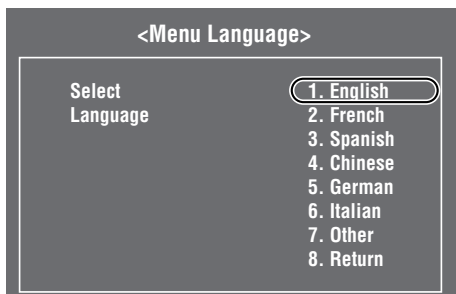

4 Finish the setting.

Press [0] (Exit). (The setting is completed.)

Note:

- To apply changes to the setting, be sure to press [0] (Exit) at the end.
- After the user settings have been changed and entered, the player returns to the start of the disc.
- When the disc has predetermined language or other settings, the user settings are not reflected.

- 1. English
- 2. French
- 3. Spanish
- 4. Chinese
- 5. German
- 6. Italian
- 7. Other (→ Page 44)
- 8. Return The display returns to "Setup Menu".

- 1. English
- 2. French
- 3. Spanish
- 4. Chinese
- 5. German
- 6. Italian
- 7. Other (→ Page 44)
- 8. Disp Off Subtitle language is not displayed.
- 9. Return The display returns to "Setup Menu".

Note:

- A disc supporting closed captioning and subtitles may overlap on the screen. In this case, turn the subtitle off.

- 1. English
- 2. French
- 3. Spanish
- 4. Chinese
- 5. German
- 6. Italian
- 7. Other (→ Page 44)
- 8. Return The display returns to "Setup Menu".

- 1. English
- 2. Chinese
- 3. Return The display returns to "Setup Menu".

User Settings (continued)

The following information explains the settings only about the disc player and displayed contents on the screen. (Only for Remote Control Unit)

1 Display "Setup Menu".

Press [MENU].

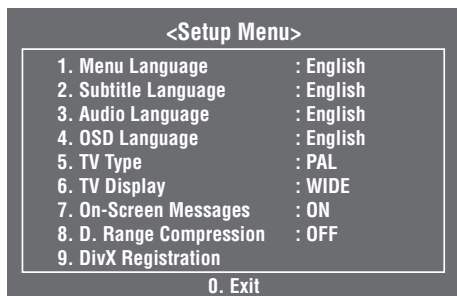

2 Select each setting menu.

Press one of the numeric buttons from [1] to [9]. (Example: "6. TV Display")

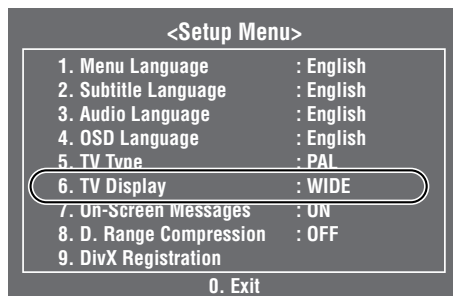

Note:

- Setup Menu has been arranged not for any DVD disc but for this unit.
- Setup Menu is operable only if the disc source has been selected. (No disc playing)

5. TV Type

TV standard format (PAL/NTSC) setting
Default: PAL

Note:

- Setting should be made to match the format of the connected monitor. Select NTSC if connections are made possible for both NTSC and PAL. If you select PAL, a picture may be partly omitted.
- This unit is not compatible with SECAM format.

6. TV Display

Display aspect setting
Default: WIDE

7. On-Screen Messages

This is to select On-screen Display messages which will be displayed when On-screen Display is turned off by pressing [OSD] (⇒ Page 30).
Default: ON

8. D. Range Compression

By compressing the range of the playback level (the dynamic range), it is possible to maintain the impact of audio even at low volumes.
This function only works with Dolby Digital encoded material.
Default: OFF

9. DivX Registration

(⇒ Page 28)

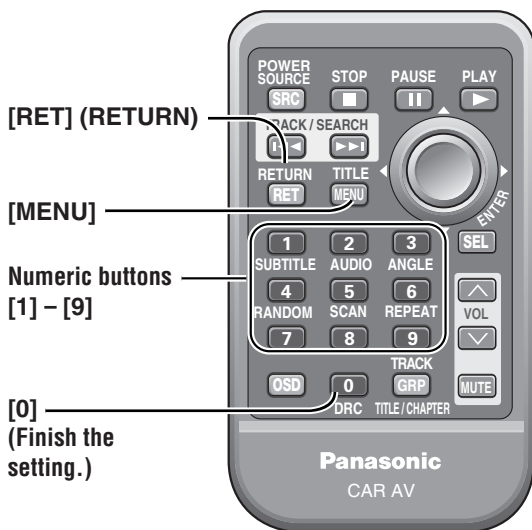

3 Select each item.

Press one of the numeric buttons from [1] to [4].
(Example: "2. Pan & Scan (4:3)")

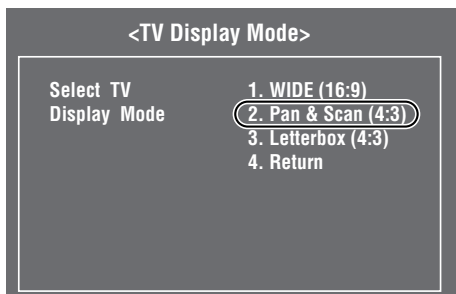

4 Finish the setting.

Press [0] (Exit). (The setting is completed.)

Note:

- To apply changes to the setting, be sure to press [0] (Exit) at the end.
- After the user settings have been changed and entered, the player returns to the start of the disc.
- When the disc has predetermined language or other settings, the user settings are not reflected.

- 1. NTSC** The unit transmits the NTSC formatted signal in either case, playing an NTSC formatted video or a PAL formatted video.
- 2. PAL** The unit transmits the PAL formatted signal in either case, playing an NTSC formatted video or a PAL formatted video.
- 3. Multi** The unit transmits the same video signal as the output of playing video software.
Note:
 - If the connected monitor cannot automatically select between NTSC and PAL according to the video signal of the disc to be reproduced, images on the screen may be distorted. Select NTSC or PAL at the monitor side depending to the disc to be reproduced.
- 4. Return** The display returns to "Setup Menu".

- 1. WIDE (16:9)** Plays in Wide mode when a wide-screen monitor is connected.
- 2. Pan & Scan (4:3)** Plays in Pan & Scan mode when a conventional monitor is connected.
- 3. Letterbox (4:3)** Plays in Letterbox mode when a conventional monitor is connected.
- 4. Return** The display returns to "Setup Menu".

Note:

- If "Pan & Scan" or "Letterbox" is already set in the software, this setting is ignored.

- 1. ON** When power is turned on, On-Screen Display message such as "Play" and "Pause" will be displayed on the screen for 5 seconds.
- 2. OFF** When power is turned on, On-Screen Display messages such as "Play" and "Pause" will not be displayed on the screen.
- 3. Return** The display returns to "Setup Menu".

- 1. Minimum** Most compressed mode: TV broadcasts ,etc
- 2. Standard** Mode recommended by software creators for listening at low volumes.
- 3. OFF** Does not compress the dynamic range.
- 4. Return** The display returns to "Setup Menu".

Note:

- When it is difficult to hear comparatively small sound (such as movie dialogue), setting "Minimum" will make those sounds easier to hear.

To return to the "Setup Menu" display, press [RET] (RETURN).

Language Code List

(Only for Remote Control Unit)

In “Other” cases (Menu Language, Subtitle Language, Audio Language) (→ Page 40)

- Press numeric buttons from [0] to [9] to input the 4 digit language code. (See below.)
 - To input the number again, press [RET] (RETURN).

- Press [ENTER] to finalize the selection.
 - Setting is finished and the display returns to “Setup Menu”.

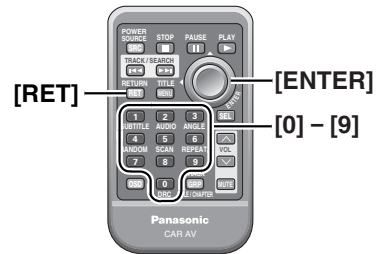

Code	Language Name
6565	Afar
6566	Abkhazian
6570	Afrikaans
6577	Ameharic
6582	Arabic
6583	Assamese
6589	Aymara
6590	Azerbaijani
6665	Bashkir
6669	Byelorussian
6671	Bulgarian
6672	Bihari
6678	Bengali; Bangla
6679	Tibetan
6682	Breton
6765	Catalan
6779	Corsican
6783	Czech
6789	Welsh
6865	Danish
6869	German
6890	Bhutani
6976	Greek
6978	English
6979	Esperanto
6983	Spanish
6984	Estonian
6985	Basque
7065	Persian
7073	Finnish
7074	Fiji
7079	Faroese
7082	French
7089	Frisian
7165	Irish
7168	Scots Gaelic
7176	Galician
7178	Guarani
7185	Gujarati
7265	Hausa
7273	Hindi
7282	Croatian
7285	Hungarian

Code	Language Name
7289	Armenian
7365	Interlingua
7378	Indonesian
7383	Icelandic
7384	Italian
7387	Hebrew
7465	Japanese
7473	Yiddish
7487	Javanese
7565	Georgian
7575	Kazakh
7576	Greenlandic
7577	Cambodian
7578	Kannada
7579	Korean
7583	Kashmiri
7585	Kurdish
7589	Kirghiz
7665	Latin
7678	Lingala
7679	Laothian
7684	Lithuanian
7686	Latvian, Lettish
7771	Malagasy
7773	Maori
7775	Macedonian
7776	Malayalam
7778	Mongolian
7779	Moldavian
7782	Marathi
7783	Malay
7784	Maltese
7789	Burmese
7865	Nauru
7869	Nepali
7876	Dutch
7879	Norwegian
7982	Oriya
8065	Punjabi
8076	Polish
8083	Pashto, Pushto
8084	Portuguese
8185	Quechua

Code	Language Name
8277	Rhaeto-Romance
8279	Romanian
8285	Russian
8365	Sanskrit
8368	Sindhi
8372	Serbo-Croatian
8373	Singhalese
8375	Slovak
8376	Slovenian
8377	Samoan
8378	Shona
8379	Somali
8381	Albanian
8382	Serbian
8385	Sundanese
8386	Swedish
8387	Swahili
8465	Tamil
8469	Telugu
8471	Tajik
8472	Thai
8473	Tigrinya
8475	Turkmen
8476	Tagalog
8479	Tonga
8482	Turkish
8484	Tatar
8487	Twi
8575	Ukrainian
8582	Urdu
8590	Uzbek
8673	Vietnamese
8679	Volapük
8779	Wolof
8872	Xhosa
8979	Yoruba
9072	Chinese
9085	Zulu

Definition of Terms

Digital audio output connector (Optical)

The digital audio output connector (optical) converts electrical signals into optical signals and transfers them to the amplifier. Consequently, it has a number of features including its immunity from electrical interference from external sources and its ability to prevent the generation of noise and its minimal effect on the external environment.

Dolby Digital

This fully discrete format divides the music signals into 5.1 channels: Front Left (L), Front Right (R), Centre (C), Left Surround (LS), Right Surround (RS) and Subwoofer (SW: 0.1 channel) for recording and playback. The number of channels that are recorded depends on the software. (1 to 5.1 channels)

Manufactured under license from Dolby Laboratories.
 "Dolby" and the double-D symbol are trademarks of Dolby Laboratories.
 Confidential unpublished works. Copyright 1992–1997 Dolby Laboratories. All rights reserved.

Interactive DVD

An interactive DVD is DVD software which includes multiple angles, multiple plot endings, etc.

Letterbox screen

This refers to a screen on which the playback picture of wide-screen DVDs or VCD (Video CD)s appears with black bands running along the top and bottom.

LPCM (Linear PCM audio)

In this format, the audio signal is converted to digital data and recorded in two channels without compression. Because the capacity of a DVD disc is large, it can store more data with better accuracy than a CD.

Pan & Scan screen

This refers to a screen on which the playback picture of wide-screen DVDs or VCD (Video CD)s is cut off at the left and right sides.

Playback control (VCD (Video CD))

If the VCD (Video CD) has "With Playback Control" or others written on the disc surface or on the jacket, the scenes or information to be viewed (or listened to) can be selected interactively with the screen by looking at the menu shown on the screen.

In these instructions, playback using the menu screen is referred to as the "menu play" for video CDs. This player supports Video CDs with playback control.

dts

This format requires more data than Dolby Digital, and provides higher quality surround playback.

Similar to Dolby Digital, this fully discrete format divides the music signals into 5.1 channels: Front Left (L), Front Right (R), Center (C), Left Surround (LS), Right Surround (RS) and Subwoofer (SW: 0.1 channel) for recording and playback.

DivX

DivX is a popular media technology created by DivX, Inc. DivX media files contain highly compressed video with high visual quality that maintains a relatively small file size. DivX files can also include advanced media features like menus, subtitles, and alternate audio tracks. Many DivX media files are available for download online, and you can create your own using your personal content and easy-to-use tools from DivX.com.

"DTS" and "DTS Digital Out" are trademarks of Digital Theater Systems, Inc.

This product incorporates copyright protection technology that is protected by U.S. patents and other intellectual property rights. Use of this copyright protection technology must be authorized by Macrovision, and is intended for home and other limited viewing uses only unless otherwise authorized by Macrovision. Reverse engineering or disassembly is prohibited.

Official DivX® Certified product
 Plays all versions of DivX® video (including DivX®6) with standard playback of DivX® media files
 DivX, DivX Certified, and associated logos are trademarks of DivX, Inc. and are used under license.

Anti-Theft System

This unit is equipped with a removable face plate. Removing this face plate makes the unit totally inoperable.

Remove the Face Plate

- 1 Switch off the power of the unit.
- 2 Press [] (Release) to remove the face plate. (The face plate disengages with a click when it is removed.)
- 3 Place the face plate into the case and take it with you when you leave the car.

Note:

- Be absolutely sure to turn off the power of the unit before removing the face plate.
- Do not install or remove the face plate while it is moving.

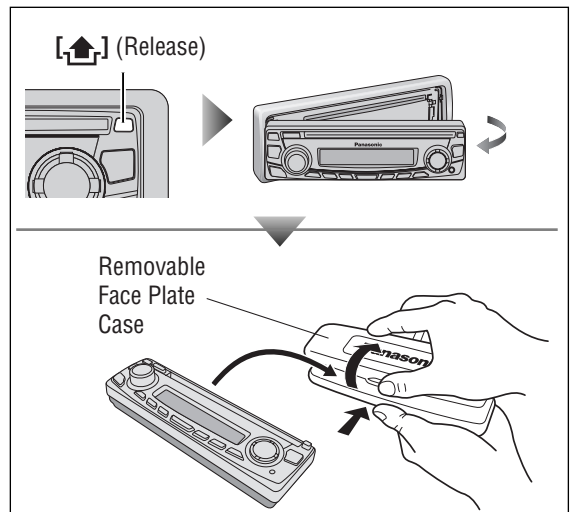

Install the Face Plate

- 1 Slide the left side of the face plate in place.
- 2 Press the right end of the face plate until a “click” is heard.

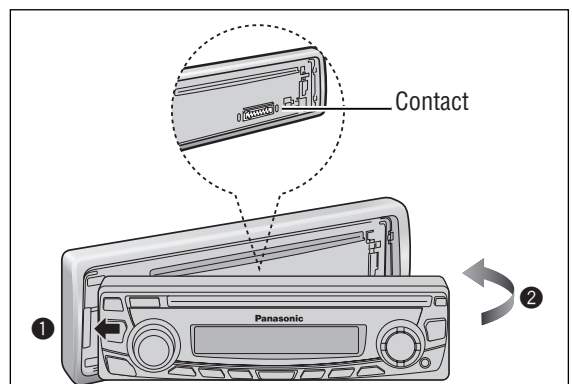

Caution

- This face plate is not waterproof. Do not expose it to water or excessive moisture.
- Do not remove the face plate while driving your car.
- Do not place the face plate on the dashboard or nearby areas where the temperature rises high.
- Do not touch the contacts on the face plate and on the main unit, since this may result in poor electrical contact.
- If dirt or other foreign substances get on the contacts, wipe them off with a clean and dry cloth.

Fuse

If the fuse blows out, consult your dealer, or your nearest authorized Panasonic Service Centre.

Warning

- Use fuses of the same specified rating (**15 A**). Using substitutes or fuses with higher ratings, or connecting the unit directly without a fuse could cause fire or damage to the unit. **If the replaced fuse fails, contact your nearest authorized Panasonic Service Centre.**

Maintenance

This unit is designed and manufactured to ensure the minimum of maintenance. Use a dry, soft cloth for routine exterior cleaning. Never use benzine, thinner, or other solvents.

Notes on Discs

How to hold a disc

- Do not touch the underside of a disc.
- Do not scratch a disc.
- Do not bend a disc.
- When not in use, keep a disc in a case.

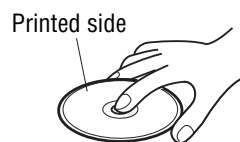

Do not use irregularly shaped discs.

Do not leave discs in the following places:

- In direct sunlight
- Near car heaters
- Dirty, dusty and damp areas
- On seats and dashboards



Labels created by a printer Irregularly shaped discs

Disc cleaning

Use a dry, soft cloth to wipe from the centre outward.

Do not attach any seals or labels to your discs.

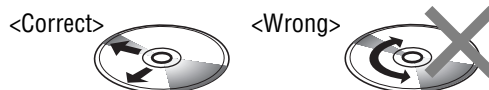

Do not write on the disc label with a ballpoint pen or other hard-point pens.

Notes on CD-Rs/RWs, DVD-Rs/RWs

- You may have trouble playing back some CD-R/RW, DVD-R/RW discs recorded using CD/DVD recorders (CD-R/RW, DVD-R/RW drives), either due to their recording characteristics or dirt, fingerprints, scratches, etc. on the disc surface.
- CD-R/RW, DVD-R/RW discs are less resistant to high temperatures and high humidity than ordinary music CDs/DVDs. Leaving them inside a car for extended periods may damage and make playback impossible.
- Some CD-Rs/RWs, DVD-Rs/RWs cannot be played back successfully due to incompatibility among writing software, a CD/DVD recorder (CD-R/RW, DVD-R/RW drive) and the discs.
- This player cannot play the CD-R/RW, DVD-R/RW discs if the session is not closed.
- Be sure to observe the instructions of the CD-R/RW, DVD-R/RW disc for handling it.
- This player cannot play the CD-R/RW discs which contain other than CD-DA or MP3/DivX data.
- This player cannot play DVD-Rs/RWs which contain other than DVD Video/MP3/DivX data.

Installation

Warning

□ This installation information is designed for professional installers with knowledge of automobile electrical safety systems and is not intended for non-technical, do-it-yourself individuals. It does not contain instructions on the electrical installation and avoidance of potential harm to air bag, anti-theft and ABS braking or other systems necessary to install this product. Any attempt to install this product in a motor vehicle by anyone other than a professional installer could cause damage to the electrical safety system and could result in serious personal injury or death.

□ If your car is equipped with air bag and/or anti-theft systems, specific procedures may be required for connection and disconnection of the battery to install this product. Before attempting installation of this electronic component against the manufacturer's recommendation, you must contact your car dealer or manufacturer to determine the required procedure and strictly follow their instructions.

FAILURE TO FOLLOW THE PROCEDURE MAY RESULT IN THE UNINTENDED DEPLOYMENT OF AIR BAGS OR ACTIVATION OF THE ANTI-THEFT SYSTEM RESULTING IN DAMAGE TO THE VEHICLE AND PERSONAL INJURY OR DEATH.

How to install the unit

Caution

- Wear gloves for safety
- Make sure that wiring is completed before installation.
- When this unit is installed in dashboard, ensure that there is sufficient air flow around the unit to prevent damage from overheating, do not block any ventilation holes on the unit.



Remove Mounting Collar ① and Trim Plate ④ from the main unit temporarily, which are already mounted at shipment.

1 Remove the cable from the battery negative terminal.

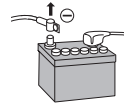

2 Mounting collar ① insertion. Bend appropriate tabs to secure the unit without backlash.

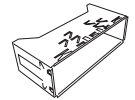

3 Connection of power connector ⑤.

4 Main unit securing
① Screw the Mounting bolt ② into the main unit.
② Secure to the fire wall.
③ Snap the right and left springs into each hole.

5 Trim plate ④ mounting

6 Battery Cable reconnection

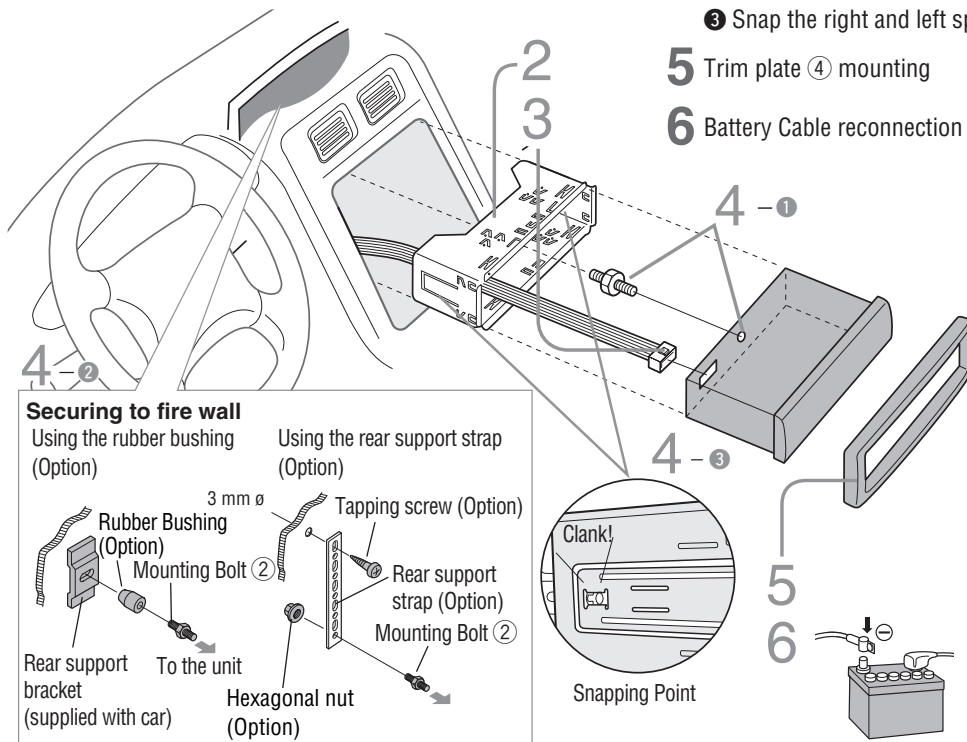

Consult a professional for installation.

Verify the radio using the antenna and speakers before installation.

Mounting Angle

side to side : horizontal
front to rear : 0 – 30°

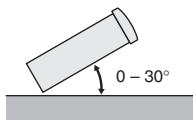

Mounting Space

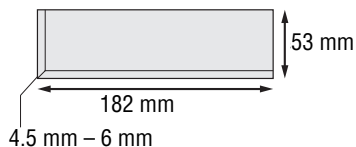

Supplied Hardware

No.	Item	Diagram	Q'ty	No.	Item	Diagram	Q'ty
①	Mounting Collar (YEFX0217263A)		1	④	Trim Plate (YEFC05657)		1
②	Mounting Bolt (5 mmø)	*	1	⑤	Power Connector (K1HY12YY0001)		1
③	ISO Antenna Adapter	*	1	⑥	Lock Cancel Plate	*	2
				⑦	Clip Connector	*	1

* ②, ③, ⑥ and ⑦ consist of a set. (YEP0FZ5725)

How to remove the unit

1 Remove the face plate.

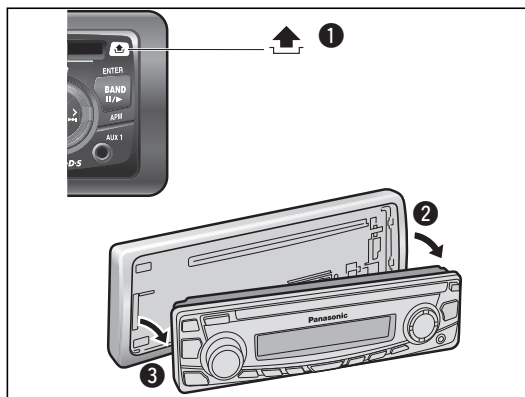

2 Remove the trim plate ④.

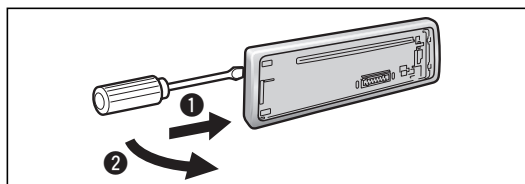

3 Lock release

- ① Insert the lock cancel plate ⑥ until you hear a click.
- ② Pull the main unit.

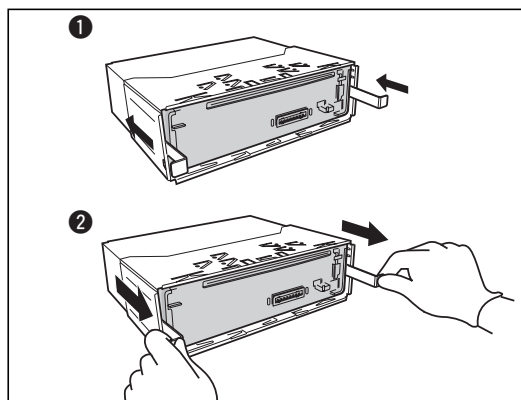

4 Pull out the unit with both hands.

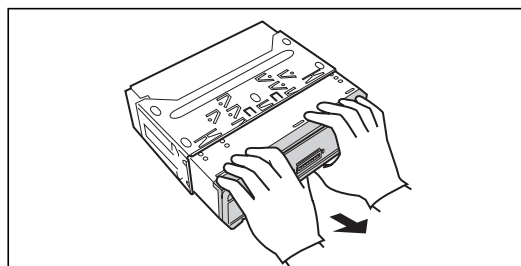

Wiring

Before Wiring

- Exclusively operated with 12 V battery with negative (–) ground.
- Connect the power lead (red) very last.
- Connect the battery lead (yellow) to the positive (+) terminal of the battery or fuse block terminal (BAT).
- Apply insulating tape to bare leads.
- Secure loosened leads.

Speaker Connection

Connect as follows

- Use ungrounded speakers only.
Allowable input: 50 W or more
Impedance: 4 – 8 Ω
- Distance between speaker and amplifier: 30 cm or more
- Do not use a 3-wire type speaker system having a common earth lead.

Caution

- Do not connect more than one speaker to one set of speaker leads. (except for connecting to a tweeter)

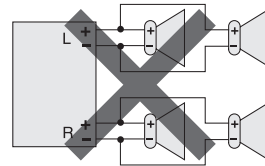

Connecting the Parking Brake Connection Lead

⚠ Caution

- For safety, be sure to ask your nearest professional installer to do this connection.

Hand brake

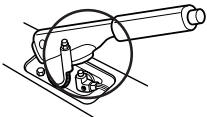

Foot brake

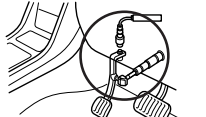

The parking brake switch position varies with the car model. For details on the exact location of the parking brake switch in your car, contact your dealer.

Parking Brake Lead

(Blue/yellow stripe)

When the parking brake lever is engaged, the unit is grounded by the chassis.

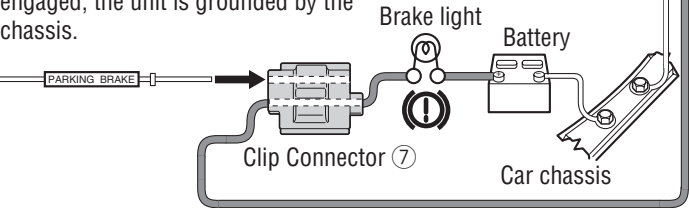

- 1 Attach a Clip Connector ⑦ to the end of the parking brake connection lead.

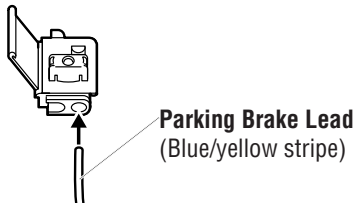

- 2 The Clip Connector ⑦ is connected to the power source side lead of the parking brake.

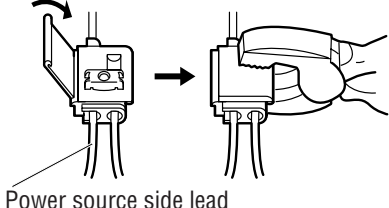

When connecting this unit to the rear monitor:

- The parking brake lead and grand lead should be connected to the same terminal.

Wiring (continued)

Caution

- Check the connectors provided on your car (see precaution below) before connecting the system.
- To prevent damage to the unit, be sure to follow the connection diagram.
- Strip about 5 mm of the lead ends for connection (only non-ISO connector cords).
- Do not insert the power connector into the unit until the wiring is completed.

Precautions (ISO Connector)

- The pin arrangement of the power connector conforms to ISO standard.
- The pin arrangement of ISO connectors in some cars may differ from the ISO standard.
- Please check that the pin arrangement of the connector in your car conforms to ISO standard.
- For car types A and B, change the wiring of the red and yellow leads as shown at below.
- After connection, insulate the portions marked (※) with insulating tape.

Note:

- For cars other than types A and B, please consult your local car shop.

ISO Standard ISO

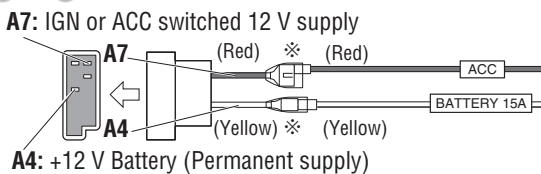

Car Type A

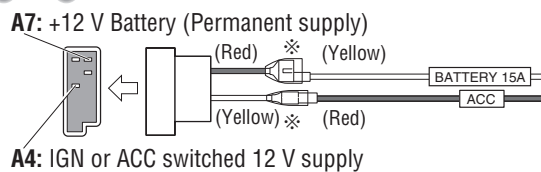

Car Type B

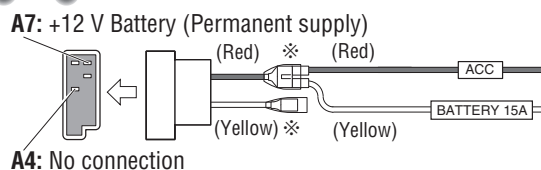

Basic Connection

ISO Antenna Adapter ③ (If needed)

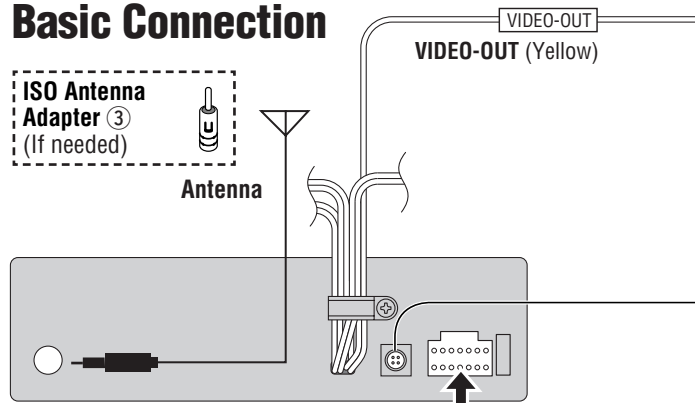

CQ-D1703N
DVD Player/Receiver

Power Connector

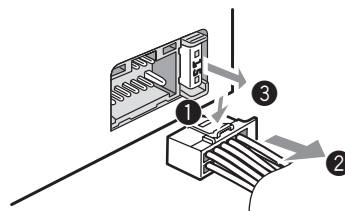

***Fuse (15 A)** Refer fuse replacement to your nearest authorized Panasonic Service Centre. Do not try fuse replacement by yourself.

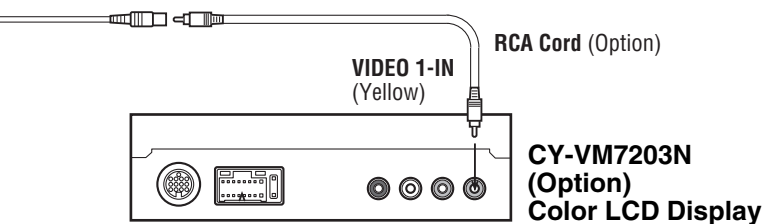

Optical Digital Output Connector

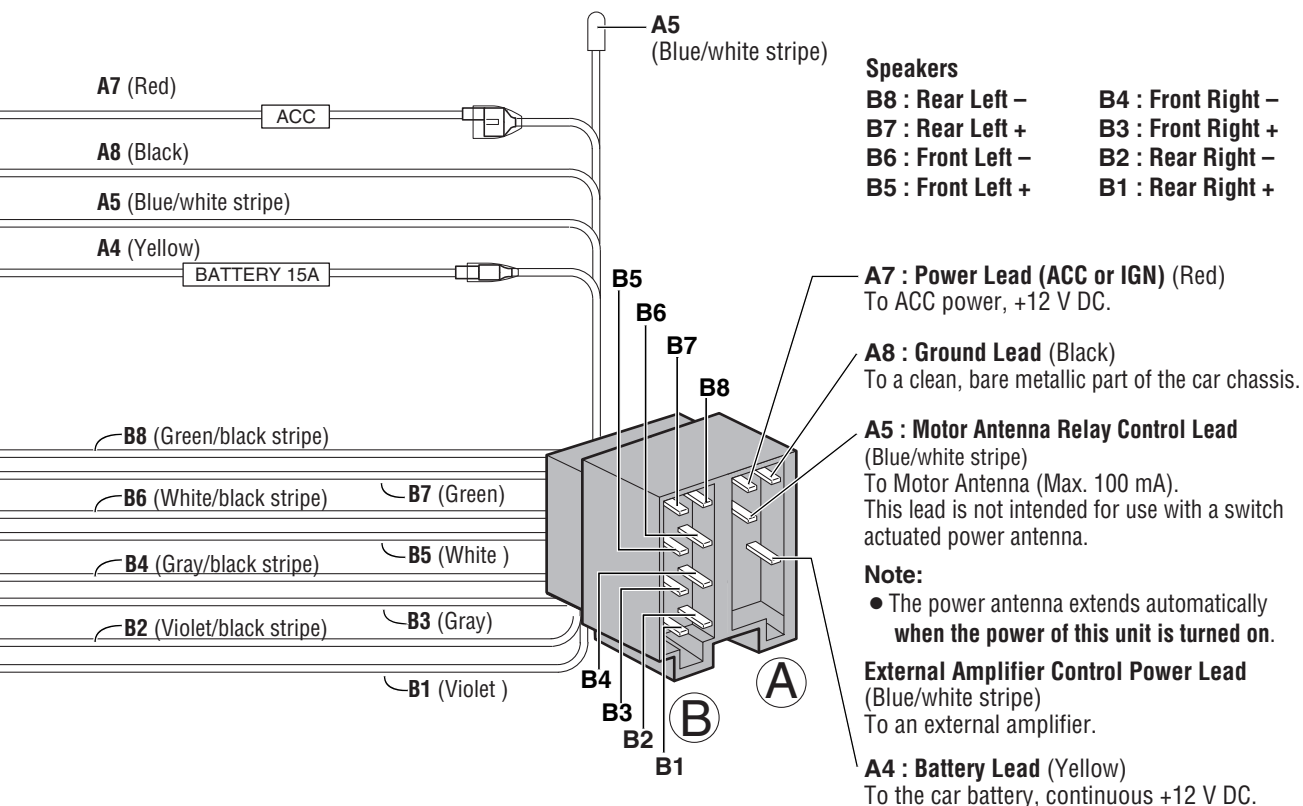
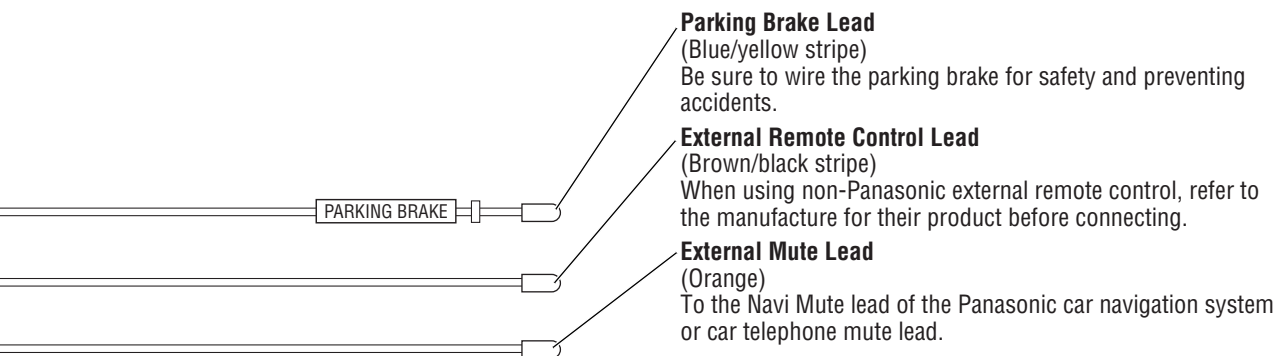

Wiring (continued)

Another Connection

Note:

- Refer to the operating instructions for the connected devices, in addition.

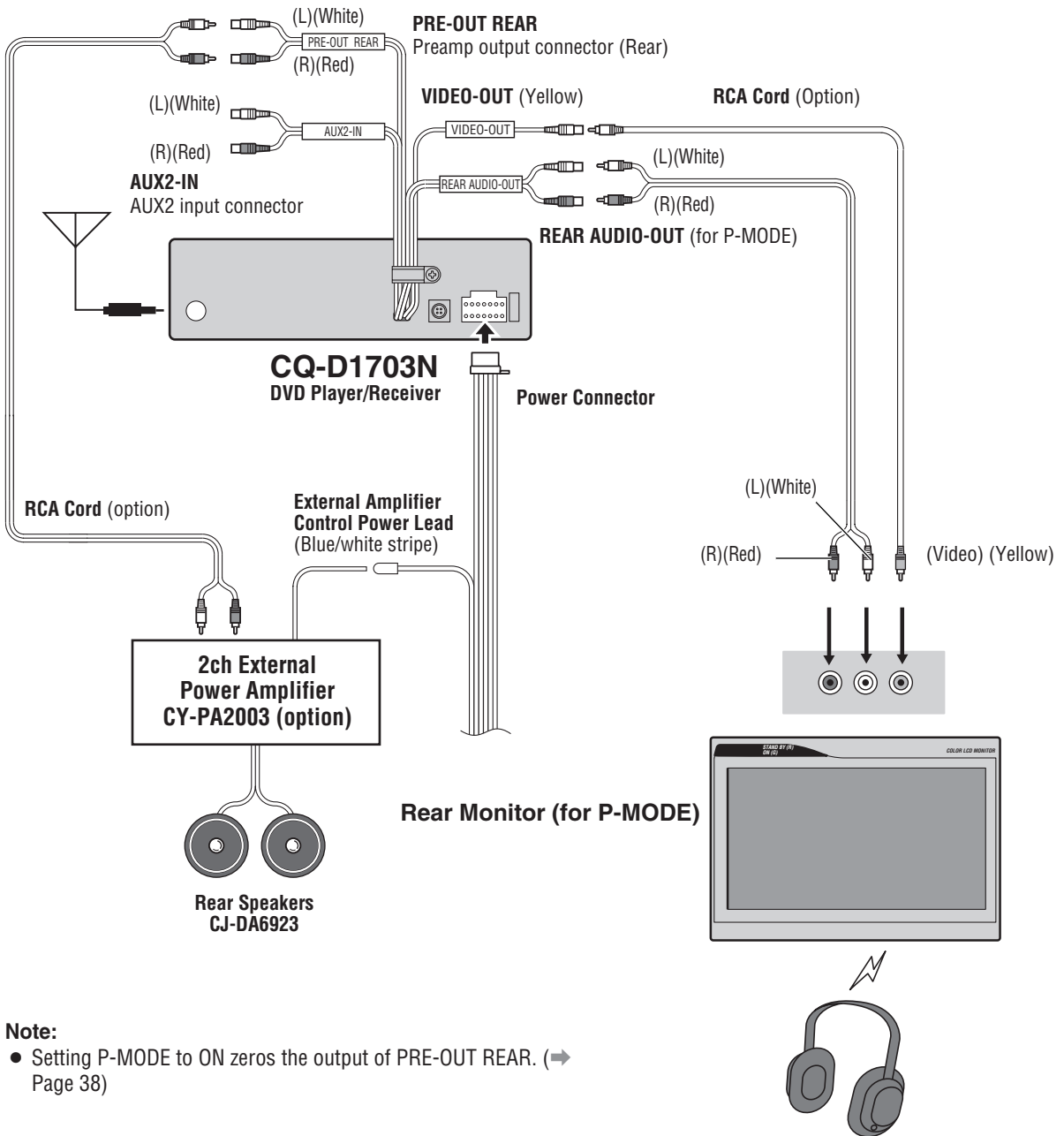

Note:

- Setting P-MODE to ON zeros the output of PRE-OUT REAR. (→ Page 38)

Final Installation

Lead Connections

Connect all wires, making sure that each connection is insulated and secure. Bundle all loose wires and fasten them with tape so they will not fall down later. Now insert the unit into the mounting collar.

Congratulations! After making a few final checks, you're ready to enjoy your new auto stereo system.

Final Check

1. Make sure that all wires are properly connected and insulated.
2. Make sure that the main unit is securely held in the mounting collar.
3. Turn on the ignition to check the unit for proper operation.

If you have difficulties, consult your nearest authorized professional installer for assistance.

Troubleshooting

If You Suspect Something Wrong

Check and take steps as described below.

If the described suggestions do not solve the problem, it is recommended to take the unit to your nearest authorized Panasonic Service Centre. The product should be serviced only by qualified personnel. Please refer the checking and the repair to professionals. Panasonic shall not be liable for any accidents arising out of neglect of checking the unit or your own repair after your checking.

Never take measures especially those other than indicated by *italic* letters in "Possible Solution" described below because those are too dangerous for users to handle themselves.

Warning

- Do not use the unit in an irregular condition, for example, without sound, or with smoke or a foul smell, which can cause ignition or electric shock. Immediately stop using the unit and consult your dealer.
- Never try to repair the unit by yourself because it is dangerous to do so.

Common

Problem	Possible cause → Possible solution
No power to the unit	<p>The power cord (battery, power and ground) is connected in the wrong way. → Check the wiring.</p> <p>Fuse blows out. → Eliminate the cause of fuse blowout and replace the fuse with new one. Consult your dealer.</p>
Sound is not generated.	<p>MUTE is set to ON. → Set MUTE to OFF.</p> <p>There is contact between the external mute lead and the chassis. → Connect the external mute lead correctly. If the lead is unused, insulate it.</p> <p>The wiring of speaker lines is not correct, or a break or poor contact arises. → Check the wiring in accordance with the wiring diagram. (→ Page 52)</p>
Noise	<p>There is an electromagnetic-wave generator such as a cellular phone near the unit or its electrical lines. → Keep the electromagnetic-wave generator such as a cellular phone away from the unit and the wiring of the unit. If noise cannot be eliminated due to the wiring harness of the car, consult your dealer.</p> <p>The contact of the ground lead is poor. → Make sure that the ground lead is connected to an unpainted part of the chassis securely.</p>
Noise is made in step with engine revolutions.	<p>Alternator noise comes from the car. → Change the wiring position of the ground lead. → Mount a noise filter on the power supply.</p>
Some operations are not executable.	<p>Some operations are not executable in particular modes such as menu mode. → Read the operating instructions carefully and cancel the mode. If the unit is still out of order, consult your dealer.</p>
No sound from speaker(s)	<p>Balance/fader setting is not appropriate. → Readjust Balance/fader.</p> <p>There is a break, a short circuit, poor contact or wrong wiring regarding the speaker wiring. → Check the speaker wiring.</p> <p>P-MODE is set to ON. → Set P-MODE to OFF.</p>

Common (continued)

Problem	Possible cause → Possible solution
The speaker channels are reversed between right and left.	The speaker wiring is reversed between right and left. → Perform the speaker wiring in accordance with the wiring diagram.
The sound field is not clear in the stereo mode. Central sound is not settled.	The plus and minus terminals at right and left channels of speakers are connected reversely. → Perform the speaker wiring in accordance with the wiring diagram.
The power of the unit fails unintentionally.	The safety device works. → Consult your dealer, or your nearest Panasonic Service Centre.

Radio

Problem	Possible cause → Possible solution
Poor reception or noise	Antenna installation or wiring of antenna cable is faulty. → Check whether the antenna mounting position and its wiring are correct. In addition, check to see whether the antenna ground is securely connected to the chassis. No power is supplied to the antenna amplifier (when using a film antenna, etc.). → Check the wiring of the antenna battery lead.
FM Stereo broadcast is received only in mono.	The MONO mode is active. → Cancel the MONO mode.
Only strong signal stations can be received.	The LOCAL mode is active. → Cancel the LOCAL mode.
The number of auto preset stations is less than 6.	The number of receivable stations is less than 6. → Move to an area where receivable stations number is maximum, and try presetting.
Preset stations cannot be stored.	The contact of the battery lead is poor, or the battery lead is not always powered. → Make sure that the battery lead is connected securely, and preset stations again.

Troubleshooting (continued)

RDS

Problem	Possible cause → Possible solution
PS does not appear even if an RDS station is tuned in to. ("NO PS" appears.)	A PS code cannot be received for the reason of bad receiving conditions, etc. → A PS code appears if it is received. Wait for a while until conditions change.
Receiving programs differs from PTY that was already set up.	When the station changed between programs, the unit could not receive the PTY code. → An appropriate programme is searched for and tuned in to after receiving a corresponding PTY code. Therefore, wait for a while.
"NONE" appears when selecting PTY.	Any specified PTY programs cannot be received. There is no desired programme being broadcast in your area. → Select another PTY, or wait until a desired programme starts.
The clock time (CT) is not accurate.	The unit received a station broadcasting time that is not appropriate for you, or the unit is receiving a station that does not broadcast time. → Receive a station broadcasting time that is appropriate for your area, or adjust CT manually.
An AF station cannot be received even if AF indicator lights.	There is little difference in receiving conditions between the current station and AF stations. Update of the AF list ended in failure. → Wait until the AF list is successfully updated. For unstable reception, tune in to a stable station by the hand.

CD

Problem	Possible cause → Possible solution
No playback or disc ejected	The disc is inserted upside down. → Insert a disc correctly.
	There is a flaw or foreign object on the disc. → Remove the foreign object, or use a flawless disc.
Sound skipping or noise	There is a flaw or foreign object on the disc. → Remove the foreign object, or use a flawless disc.
Sound skipping due to vibration	The unit is not sufficiently secured. → Secure the unit to the console box.
	The unit is tilted at over 30° in the front-to-end direction. → Make the angle 30° or less.
Disc unejectable	Something such as a peeled label obstructs the disc coming out. → Consult your dealer.
	The microcontroller in the unit operates abnormally due to noise or other factors. → Unplug the power cord and plug it again. In case the unit is still out of order, consult your dealer.

■ MP3/DivX

Problem	Possible cause ⇒ Possible solution
No playback or disc ejected	The disc has unplayable formatted data. ⇒ Refer to the description about MP3/DivX for playable formats.
The CD-Rs/RWs/DVD-Rs/RWs that are playable on other devices are not playable on this unit.	The playability of some CD-Rs/RWs/DVD-Rs/RWs may depend on the combination of media, recording software and recorder to be used even if these CD-Rs/RWs/DVD-Rs/RWs are playable on other devices such as a PC. ⇒ Make CD-Rs/RWs/DVD-Rs/RWs in a different combination of media, recording software and recorder after referring to the description about MP3/DivX.
Sound skipping or noise	There is a flaw or foreign objects on the disc. ⇒ Remove the foreign objects, or use a flawless disc. For MP3/DivX, refer to the description about MP3/DivX. Playing VBR (Variable Bit Rate) files may cause sound skipping. ⇒ Play Non-VBR files.
The picture stops.	The picture may stop if the DivX files are greater than 2 GB. ⇒ Keep the file size under 2 GB.

Note:

- Refer to "Notes on MP3/DivX". (⇒ Page 32)

■ Remote control unit

Problem	Possible cause ⇒ Possible solution
No response to pressing buttons	The battery is inserted in the wrong direction. A wrong battery is inserted. ⇒ Insert a correct battery in the correct direction.
	The battery is weak. ⇒ Replace the battery with new one.
	The aiming direction of the remote control unit is wrong. ⇒ Aim the remote control unit at the sensor of the unit and press buttons.
	The sensor is exposed to direct sunlight. (The remote control unit may not be operable when the sensor is exposed to direct sunlight. In such a case, the system is not faulty.) ⇒ Block off sunlight to the sensor.

Troubleshooting (continued)

DVD/VCD



Problem	Possible cause → Possible solution
No playback or disc ejected	<p>There is a flaw or foreign objects on the disc. → Remove the foreign objects, or use a flawless disc.</p> <p>The disc has unplayable formatted data. → Refer to the description about available disc types.</p>
Sound skipping or noise	<p>There is a flaw or foreign objects on the disc. → Remove the foreign objects, or use a flawless disc.</p>
Sound skipping due to vibration	<p>The unit is not sufficiently secured. → Secure the unit to the console box.</p> <p>The unit is tilted at over 30° in the front-to-end direction. → Make the angle 30° or less.</p>
Disc unejectable	<p>The microcontroller in the unit operates abnormally due to noise or other factors. → Unplug the power cord and plug it again. In case the unit is still out of order, consult your dealer.</p>
The picture does not appear on the monitor.	<p>Cables are not correctly connected. → Connect cables correctly. → Stop the car and apply the parking brake.</p>
The picture appears incorrectly.	<p>The video signal setting of this unit (NTSC/PAL) does not match with the video signal setting of the connected monitor. → Make the same setting between this unit and the monitor.</p>
Video CD menu playback does not work.	<p>→ Video CD menu playback works only when playing a video CD that has the playback control feature.</p>
The picture becomes distorted while fast forwarding or reversing.	<p>→ A certain amount of distortion is normal.</p>
No subtitles appear.	<p>Subtitle must be recorded on the disc, or they will not appear. → Refer to the guide provided with your disc.</p>
It is difficult to hear small sounds. (Dolby Digital DVD software only)	<p>→ Set "D.Range Compression" to "Minimum".</p>
Cannot switch the audio language/subtitle language/angle.	<p>It is not possible to switch if the disc does not have multiple audio languages/subtitle languages/angles recorded on it. → Refer to the guide provided with your disc. → Some discs permit switching through a menu screen. → Sometimes, switching angle is possible only with certain scenes.</p>
The audio/subtitle language selected in the user settings is not used.	<p>If audio or subtitles in that language are not recorded on the disc, the audio or subtitles do not switch to that language. (Some discs permit switching through a menu screen.) → Refer to the guide provided with your disc.</p>
A DVD-R or DVD-RW is not playable.	<p>The disc is still unfinalized. → Finalize the disc. Refer to "Discs that can be Played Back" (→ Page 8) or "Notes on Discs" (→ Page 47) for other cases.</p>

Note:

- Refer to "Discs that can be Played Back". (→ Page 8)

Error Display Messages

■ CD/MP3/DivX

Display	Possible cause → Possible solution
	<p>The disc is dirty. The disc has scratches. ⇒ Eject the disc. (⇒ Page 22)</p>
	<p>No operation by some cause. ⇒ Eject the disc. If the disc is not ejected when you press [▲] (eject), unplug the power cord and plug it again. In case the unit is still out of order, consult your dealer. (⇒ Page 22, 52)</p>
	<p>The disc is upside down. The player for some reason cannot read the file you are trying to play. (File recorded in an unsupported file system, compression scheme, data format, file name extension, damaged data, etc.) ⇒ Eject the disc. Select a file that the player can read. Check the type of data recorded on the disc. Create a new disc if necessary. (⇒ Page 22, 32)</p>

■ DivX VOD (displayed on connected monitor)

Display	Possible cause → Possible solution
<p>Authorization Error</p> <p>This player is not authorized to play this video.</p> <p>ENTER: Continue STOP: Stop</p>	<p>You are trying to play the DivX VOD content that was purchased with a different registration code. ⇒ Purchase the DivX VOD content with the registration code of this unit. (⇒ Page 28)</p>
<p>Rental Expired</p> <p>ENTER: Continue STOP: Stop</p>	<p>The DivX VOD content has no available play count. ⇒ Purchase again the content or play another content. (⇒ Page 28)</p>

Troubleshooting (continued)

Error Display Messages (continued)

DVD/VCD

Display	Possible cause → Possible solution
	The disc is dirty. The disc has scratches. → Eject the disc. (⇒ Page 22)
	No operation by some cause. → Eject the disc. If the disc is not ejected when you press [▲] (eject), unplug the power cord and plug it again. In case the unit is still out of order, consult your dealer. (⇒ Page 22, 52)
	The disc is upside down. The player for some reason cannot read the file you are trying to play. (File recorded in an unsupported file system, compression scheme, data format, file name extension, damaged data, etc.) → Eject the disc. Select a file that the player can read. Confirm the type of data recorded on the disc. Create a new disc if necessary. (⇒ Page 8, 22)
	This disc may not be played in your region. TR 546. An attempt was made to play a disc with a region number that was not "2", "5" or "ALL". → Eject the disc. (⇒ Page 22)

Sales and Support Information

For UK and Ireland customers only.

Customer Care Centre

- For customers within the UK: 08705 357357
- For customers within the Republic of Ireland: 01 289 8333
- Visit our website for product information
- E-mail: customer.care@panasonic.co.uk

Direct Sales at Panasonic UK

- Order accessories and consumable items for your product with ease and confidence by phoning our Customer Care Centre Monday - Thursday 9:00am - 5:30pm, Friday 9:30am - 5:30pm. (Excluding public holidays).
- Or go on line through our Internet Accessory ordering application at www.panasonic.co.uk.
- Most major credit and debit cards accepted.
- All enquiries, transactions and distribution facilities are provided directly by Panasonic UK Ltd.
- It couldn't be simpler!
- Also available through our Internet is direct shopping for a wide range of finished products, so take a browse on our website for further details.

Specifications

General		FM Stereo Radio	
Power supply	: DC 12 V (11 V – 16 V), test voltage 14.4 V, negative ground	Frequency range	: 87.5 MHz – 108 MHz
Current consumption	: Less than 2.3 A (CD mode, 0.5 W 4-channels)	Usable sensitivity	: 6 dB/μV (S/N 30 dB)
Maximum power output	: 50 W x 4 (at 4 Ω)	Stereo separation	: 35 dB (at 1 kHz)
Power output	: 22 W x 4 (DIN 45 324, at 4 Ω)	AM (MW) Radio	
Video Signal system	: NTSC/PAL 1.0 Vp-p 75 Ω RCA pin jack	Frequency range	: 531 kHz – 1 602 kHz
Speaker impedance	: 4 – 8 Ω	Usable sensitivity	: 27 dB/μV (S/N 20 dB)
Tone adjustment range	: Bass: ± 12 dB (at 100 Hz) Treble: ± 12 dB (at 10 kHz)	AM (LW) Radio	
Pre-amp output voltage	: 2.5 V (CD mode)	Frequency range	: 153 kHz – 279 kHz
Pre-amp output impedance	: 200 Ω	Usable sensitivity	: 32 dB/μV (S/N 20 dB)
Audio output voltage	: 2.5 V	Disc Player	
Dimensions (W x H x D)	: 178 x 50 x 160 mm	DA converter	: 1 bit DAC System
Weight	: 1.6 kg	Pick-up type	: Astigma 3-beam
AUX (AUX1/2) input		Light source	: Semiconductor laser
Input impedance	: 10 kΩ	Frequency response	: 20 Hz – 20 kHz (CD) : 20 Hz – 22 kHz (DVD video 48 kHz sampling)
Allowable external input	: 2.0 V		: 20 Hz – 44 kHz (DVD video 96 kHz sampling)
Connector (AUX1)	: 3.5 mm ø Stereo mini-pin	Signal to noise ratio	: 95 dB (IHF, A)
		Wow and flutter	: Below measurable limits

Discs played

(1) DVD-Video disc

- 12 cm single-sided, single-layer/double-layer
- 12 cm double-sided, single-layer/double-layer
- 8 cm single-sided, single-layer/double-layer
- 8 cm double-sided, single-layer/double-layer

(2) Compact disc (CD-DA, Video CD, CD-R, CD-RW)

- 12 cm disc
- 8 cm disc

Digital audio output

Disc	Sounds recording format	Optional digital audio output from connector
DVD	Dolby Digital	Dolby Digital bitstream (1 – 5.1ch)
	DTS	DTS bitstream (1 – 5.1ch)(The analog portion is not output)
	Linear PCM (48 kHz 16/20/24 bit)	Linear PCM (2 ch) (48 kHz sampling/16 bit)
Video CD	MPEG 1	MPEG 1 bitstream
	Linear PCM	Linear PCM (2 ch) (44.1 kHz sampling/16 bit)
CD	Linear PCM	Linear PCM (2 ch) (44.1 kHz sampling/16 bit)
	DTS*	DTS bitstream (1 – 5.1ch) (The analog portion is not output)
MP3	MP3	Linear PCM (2ch) (32 kHz/44.1 kHz/48 kHz sampling/16 bit)
DivX	MP3	Linear PCM (2 ch) (32 kHz/44.1 kHz/48 kHz sampling/16 bit)

*DTS only works optical outputs.

Note:

- Specifications and design are subject to modification without notice due to improvements.
- Some figures and illustrations in this manual may be different from your product.

Matsushita Electric Industrial Co., Ltd.
Web Site : <http://panasonic.net>

YEFM285852A NT0506-1066 Printed in China

Free Manuals Download Website

<http://myh66.com>

<http://usermanuals.us>

<http://www.somanuals.com>

<http://www.4manuals.cc>

<http://www.manual-lib.com>

<http://www.404manual.com>

<http://www.luxmanual.com>

<http://aubethermostatmanual.com>

Golf course search by state

<http://golfingnear.com>

Email search by domain

<http://emailbydomain.com>

Auto manuals search

<http://auto.somanuals.com>

TV manuals search

<http://tv.somanuals.com>