

Panasonic®

Operating Instructions

Blu-ray Disc Player

Model No. **DMP-BD50**

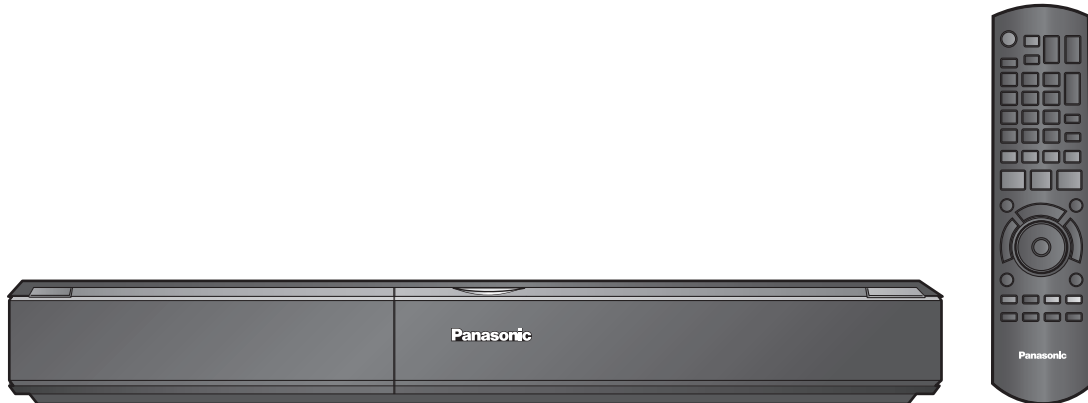

Dear customer

Thank you for purchasing this product.
For optimum performance and safety, please read these instructions carefully.

Before connecting, operating or adjusting this product, please read the instructions completely. Please keep this manual for future reference.



Region management information

BD-Video

This unit plays BD-Video marked with labels containing the region code A.

Example:



DVD-Video

This unit plays DVD-Video marked with labels containing the region number "1" or "ALL".

Example:



As an ENERGY STAR® Partner,*
Panasonic has determined that
this product meets the ENERGY STAR®
guidelines for energy efficiency.

* For Canada only: The word "Participant" is used in place of the word "Partner".

If you have any questions contact

U.S.A.: 1-800-211-PANA(7262)
Canada: 1-800-561-5505

U.S.A.: The warranty can be found on page 37.
Canada: The warranty can be found on page 38.

La referencia rápida en español se puede encontrar en la página 39.

IMPORTANT SAFETY INSTRUCTIONS

Read these operating instructions carefully before using the unit. Follow the safety instructions on the unit and the applicable safety instructions listed below. Keep these operating instructions handy for future reference.

- 1) Read these instructions.
- 2) Keep these instructions.
- 3) Heed all warnings.
- 4) Follow all instructions.
- 5) Do not use this apparatus near water.
- 6) Clean only with dry cloth.
- 7) Do not block any ventilation openings. Install in accordance with the manufacturer's instructions.
- 8) Do not install near any heat sources such as radiators, heat registers, stoves, or other apparatus (including amplifiers) that produce heat.
- 9) Do not defeat the safety purpose of the polarized or grounding-type plug. A polarized plug has two blades with one wider than the other. A grounding-type plug has two blades and a third grounding prong. The wide blade or the third prong are provided for your safety. If the provided plug does not fit into your outlet, consult an electrician for replacement of the obsolete outlet.

- 10) Protect the power cord from being walked on or pinched particularly at plugs, convenience receptacles, and the point where they exit from the apparatus.
- 11) Only use attachments/accessories specified by the manufacturer.
- 12) Use only with the cart, stand, tripod, bracket, or table specified by the manufacturer, or sold with the apparatus. When a cart is used, use caution when moving the cart/apparatus combination to avoid injury from tip-over.
- 13) Unplug this apparatus during lightning storms or when unused for long periods of time.
- 14) Refer all servicing to qualified service personnel. Servicing is required when the apparatus has been damaged in any way, such as power-supply cord or plug is damaged, liquid has been spilled or objects have fallen into the apparatus, the apparatus has been exposed to rain or moisture, does not operate normally, or has been dropped.



WARNING:
TO REDUCE THE RISK OF FIRE, ELECTRIC SHOCK OR PRODUCT DAMAGE,
 • DO NOT EXPOSE THIS APPARATUS TO RAIN, MOISTURE, DRIPPING OR SPLASHING AND THAT NO OBJECTS FILLED WITH LIQUIDS, SUCH AS VASES, SHALL BE PLACED ON THE APPARATUS.
 • USE ONLY THE RECOMMENDED ACCESSORIES.
 • DO NOT REMOVE THE COVER (OR BACK); THERE ARE NO USER SERVICEABLE PARTS INSIDE. REFER SERVICING TO QUALIFIED SERVICE PERSONNEL.

CAUTION!
DO NOT INSTALL OR PLACE THIS UNIT IN A BOOKCASE, BUILT-IN CABINET OR IN ANOTHER CONFINED SPACE. ENSURE THE UNIT IS WELL VENTILATED. TO PREVENT RISK OF ELECTRIC SHOCK OR FIRE HAZARD DUE TO OVERHEATING, ENSURE THAT CURTAINS AND ANY OTHER MATERIALS DO NOT OBSTRUCT THE VENTILATION VENTS.

CAUTION!
THIS PRODUCT UTILIZES A LASER. USE OF CONTROLS OR ADJUSTMENTS OR PERFORMANCE OF PROCEDURES OTHER THAN THOSE SPECIFIED HEREIN MAY RESULT IN HAZARDOUS RADIATION EXPOSURE. DO NOT OPEN COVERS AND DO NOT REPAIR YOURSELF. REFER SERVICING TO QUALIFIED PERSONNEL.

CAUTION
 Danger of explosion if battery is incorrectly replaced. Replace only with the same or equivalent type recommended by the manufacturer. Dispose of used batteries according to the manufacturer's instructions.

The socket outlet shall be installed near the equipment and easily accessible. The mains plug of the power supply cord shall remain readily operable.
 To completely disconnect this apparatus from the AC Mains, disconnect the power supply cord plug from AC receptacle.

THE FOLLOWING APPLIES ONLY IN THE U.S.A.
FCC Note:
 This equipment has been tested and found to comply with the limits for a Class B digital device, pursuant to Part 15 of the FCC Rules. These limits are designed to provide reasonable protection against harmful interference in a residential installation. This equipment generates, uses and can radiate radio frequency energy and, if not installed and used in accordance with the instructions, may cause harmful interference to radio communications. However, there is no guarantee that interference will not occur in a particular installation. If this equipment does cause harmful interference to radio or television reception, which can be determined by turning the equipment off and on, the user is encouraged to try to correct the interference by one or more of the following measures:
 • Reorient or relocate the receiving antenna.
 • Increase the separation between the equipment and receiver.
 • Connect the equipment into an outlet on a circuit different from that to which the receiver is connected.
 • Consult the dealer or an experienced radio/TV technician for help.
 Any unauthorized changes or modifications to this equipment would void the user's authority to operate this device.
 This device complies with Part 15 of the FCC Rules. Operation is subject to the following two conditions: (1) This device may not cause harmful interference, and (2) this device must accept any interference received, including interference that may cause undesired operation.
 Responsible Party:
 Panasonic Corporation of North America
 One Panasonic Way
 Secaucus, NJ 07094
 Support Contact:
 Panasonic Consumer Electronics Company
 Telephone No.: 1-800-211-PANA (7262)

CAUTION

**RISK OF ELECTRIC SHOCK
DO NOT OPEN**

CAUTION: TO REDUCE THE RISK OF ELECTRIC SHOCK, DO NOT REMOVE SCREWS. NO USER-SERVICEABLE PARTS INSIDE. REFER SERVICING TO QUALIFIED SERVICE PERSONNEL.

The lightning flash with arrowhead symbol, within an equilateral triangle, is intended to alert the user to the presence of uninsulated "dangerous voltage" within the product's enclosure that may be of sufficient magnitude to constitute a risk of electric shock to persons.

The exclamation point within an equilateral triangle is intended to alert the user to the presence of important operating and maintenance (servicing) instructions in the literature accompanying the appliance.

DANGER - VISIBLE AND INVISIBLE LASER RADIATION WHEN OPEN. AVOID DIRECT EXPOSURE TO BEAM. FDA 21 CFR Class IIb	
CAUTION	CLASS 3B VISIBLE AND INVISIBLE LASER RADIATION WHEN OPEN. AVOID EXPOSURE TO THE BEAM. IEC60825-1 +A2/Class 3B
ATTENTION	RAYONNEMENT LASER VISIBLE ET INVISIBLE. CLASSE 3B, EN CAS D'OUVERTURE, EVITER UNE EXPOSITION AU FAISCEAU.
FORSIGTIG	SYNLIG OG USYNLIG LASERSTRÅLING KLASSE 3B. NÅR LÅGET ER ÅBENT, UNDGÅ AT BLIVE UDSAT FOR STRÅLEN.
VARO	AVATTAESSA OLET ALLITAIN LUOKAN 3B NÄKYVÄÄ JA NÄKYMÄTÖNTÄ LASERSATELIÄ, VARO ALTISTUMISTA SÄTEELLE.
VARNING	KLASS 3B SYNLIG OCH OSYNLIG LASERSTRÅLNING NÄR DENNA DEL ÄR ÖPPNAD. UNDVIK EXPONERING FÖR STRÅLEN.
VORSICHT	SICHTBARE UND UNSICHTBARE LASERSTRÄHLUNG KLASSE 3B. WENN ABDECKUNG GEÖFFNET, NICHT DEM STRAHL AUSSETZEN.
注意	一 打开时有可见及不可见激光辐射。避免光束照射。
注意	一 ここを開くと可視及び不可視レーザー光が出ます。ビームを見たり、触れたりしないでください。 VQL1J70

(Inside of product)

Table of contents

Getting started

IMPORTANT SAFETY INSTRUCTIONS.....	2
Accessory information	3
Disc and card information.....	4
Using the remote control.....	5
Connection	6
Firmware updating.....	9
Control reference guide.....	10
Easy Setting.....	11
Setting the television and amplifier/receiver operation.....	11
Network settings	12

Playback

Basic play (Playing video contents).....	14
Enjoying BD-LIVE™ or BONUSVIEW™ in BD-Video.....	16
Enjoying High Bit rate Audio and Video of BD-Video.....	17
Chapter playback.....	18
Playing still pictures	18
Playing DivX videos.....	20
Playing music.....	21
Showing FUNCTIONS menu.....	21
About MP3/JPEG/DivX files.....	22
Linked operations with the TV (VIERA Link™ “HDAVI Control™”).....	23

Settings

Changing settings with the on-screen menu	24
Changing the unit's settings.....	26

Reference

Frequently asked questions.....	30
Troubleshooting guide	30
Messages	34
Specifications.....	36
Disc and card handling.....	36
Maintenance	36
To dispose or transfer this unit	36
Limited Warranty (ONLY FOR U.S.A.)	37
Limited Warranty (ONLY FOR CANADA)	38
Product Service.....	38
<i>Referencia rápida en español (Spanish Quick Reference).....</i>	<i>39</i>
Glossary	40
Index.....	41

Accessory information

Please check and identify the supplied accessories. Use numbers indicated in parentheses when asking for replacement parts. (Product numbers correct as of April 2008. These may be subject to change.)



Only for U.S.A.: To order accessories, refer to “Accessory Purchases” on page 37.
Only for Canada: To order accessories, call the dealer from whom you have made your purchase.



1 Remote control
(N2QAYB000184)



1 Audio/Video cable
(K2KA6BA00004)

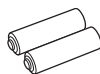

2 Batteries
for remote control

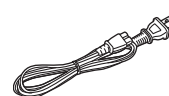

1 AC power supply cord
(K2CB2CB00022)
 • For use with this unit only. Do not use it with other equipment.
 Also, do not use cords from other equipment with this unit.

**(ONLY FOR U.S.A.)
 Product Registration Card**





Please complete and return the included product registration card, or register via the Internet at: <http://www.prodreg.com/panasonic/>





The enclosed Canadian French label sheet corresponds to the English display on the front and back side of the unit.

Disc and card information

Packaged discs

This chart shows the different type of retail/commercial discs you can use, and also includes the industry-standard logos that should appear on the discs and/or packaging.















Type of media/ Logo	Features	Indicated as
BD-Video  	High Definition (HD) movie and music discs <ul style="list-style-type: none"> Discs supporting BD-Live (BD-ROM version 2 Profile 2) that allows interactive functions to be used when this unit is connected to the Internet in addition to the BONUSVIEW function.  <ul style="list-style-type: none"> Discs supporting BONUSVIEW (BD-ROM version 2 Profile 1 version 1.1/ Final Standard Profile) that allows Virtual packages or Picture-in-Picture functions to be used. BONUSVIEW™	 











Type of media/ Logo	Features	Indicated as
DVD-Video  	High quality movie and music discs	
CD 	Compact Discs (CD's) that contain audio and music <ul style="list-style-type: none"> Operation and sound quality of CDs that do not conform to CD-DA specifications (copy control CDs, etc.) cannot be guaranteed. 	

Recorded discs

This chart shows the different type of discs recorded with DVD recorders, DVD video cameras, personal computers, etc. that you can use.

Finalized This mark means you must finalize the disc with the DVD recorder, etc. before playback. For details about finalizing, refer to the operating instructions for your equipment.

Type of media/ Logo	Formats	Indicated as
BD-RE 	<ul style="list-style-type: none"> Version 3 of the BD-RE Recording Format JPEG format 	 
BD-R 	<ul style="list-style-type: none"> Version 2 of the BD-R Recording Format 	
DVD-RAM 	<ul style="list-style-type: none"> Version 1.1 of the DVD Video Recording Format JPEG format AVCHD format 	  
DVD-R/RW Finalized  	<ul style="list-style-type: none"> DVD-Video Format Version 1.1 of the DVD Video Recording Format AVCHD format DivX format (DVD-RW is not supported) 	   

Type of media/ Logo	Formats	Indicated as
DVD-R DL Finalized  R DL	<ul style="list-style-type: none"> DVD-Video Format Version 1.2 of the DVD Video Recording Format AVCHD format DivX format 	   
+R/+RW/+R DL Finalized	<ul style="list-style-type: none"> +VR (+R/+RW Video Recording) Format AVCHD format 	 
CD-R/RW Finalized	<ul style="list-style-type: none"> CD-DA format MP3 format JPEG format DivX format 	   

- It may not be possible to play the above discs in some cases due to the type of discs, the condition of the recording, the recording method and how the files were created.
- When a disc recorded in the AVCHD format is being played, the video may be paused for a few seconds at portions spliced, due to deletion or editing.

SD cards

This chart shows the different type of cards recorded with Panasonic High Definition Video Camera or personal computers, etc. that you can use.

Type of media	Formats	Indicated as
SD Memory Card* (from 8 MB to 2 GB) SDHC Memory Card (from 4 GB to 32 GB)	<ul style="list-style-type: none"> • JPEG format • AVCHD format 	<div style="border: 1px solid black; padding: 2px; display: inline-block;"> JPEG AVCHD </div>

* Including miniSD Card and microSD Card

- When using from 4 GB to 32 GB SD cards, only SD cards that display the SDHC logo can be used.
- This unit is compatible with SD Memory Cards that meet SD Card Specifications FAT12 and FAT16 formats, as well as SDHC Memory Cards in FAT32 format.
- In these operating instructions, the cards shown in the table (⇒ above) are comprehensively called SD cards.

- A miniSD Card and a microSD Card must be used with the attached adaptor that comes with the card.
- Useable memory is slightly less than the card capacity.
- If the SD card is formatted on a PC, you may not be able to use it on this unit.
- We recommend using a Panasonic SD card.
- Keep the Memory Card out of reach of children to prevent swallowing.
- When a card recorded in the AVCHD format is being played, the video may be paused for a few seconds at portions spliced, due to deletion or edition.
- Switch the write-protect switch to the "LOCK" position to protect the content from accidental erasure.



Regarding BD-Video

- Please enjoy BD-Live functions (⇒ 16), such as the network connection. The various functions differ depending on the disc.
- **Regarding high bit rate audio of BD-Video such as Dolby Digital Plus, Dolby TrueHD, DTS-HD High Resolution Audio and DTS-HD Master Audio (⇒ 17)**
This unit can output the high bit rate audio adopted in BD-Video to your amplifier/receiver in bitstream format. In addition, even if your amplifier/receiver cannot decode the high bit rate audio, you can enjoy BD-Video's high-quality audio by decoding the high bit rate audio with this unit.

Note about using a DualDisc

The digital audio content side of a DualDisc does not meet the technical specifications of the Compact Disc Digital Audio (CD-DA) format so play may not be possible.

Discs that cannot be played

- BD-RE with the cartridge
- 2.6 GB and 5.2 GB DVD-RAM
- 3.95 GB and 4.7 GB DVD-R for Authoring
- DVD-RAM that cannot be removed from their cartridges
- Version 1.0 of DVD-RW
- +R 8 cm (3"), DVD-ROM, CD-ROM, CDV, SACD, Photo CD, MV-Disc and PD
- DVD-Audio
- Video CD and SVCD
- WMA discs
- PAL discs
- HD DVD
- BD-Video discs recorded at a rate of 50 field per second
- Other discs that are not specifically supported

Using the remote control

Batteries

Insert so the poles (+ and -) match those in the remote control. When closing the lid, insert it from the - (minus) side.

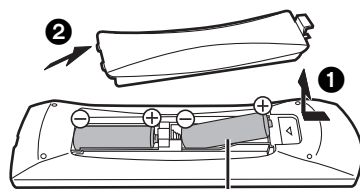

R6/LR6, AA

- Do not use rechargeable type batteries.
 - Do not mix old and new batteries.
 - Do not use different types at the same time.
 - Do not heat or expose to flame.
 - Do not leave the battery(ies) in an automobile exposed to direct sunlight for a long period of time with doors and windows closed.
 - Do not take apart or short circuit.
 - Do not attempt to recharge alkaline or manganese batteries.
 - Do not use batteries if the covering has been peeled off.
- Mishandling of batteries can cause electrolyte leakage which can damage items the fluid contacts and may cause a fire. Remove batteries if the remote control is not going to be used for a long period of time. Store in a cool, dark place.

Use

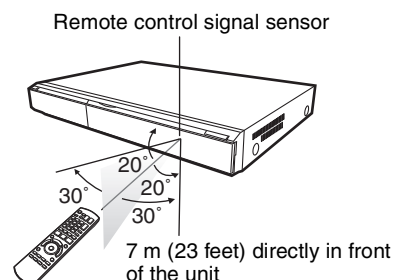

If you cannot operate the unit or other equipment using the remote control after changing the batteries, please re-enter the codes (⇒ 11, 33).

Connection

- Do not place the unit on amplifiers or equipment that may become hot. The heat can damage the unit.
- **Do not connect through the video cassette recorder.** Due to copy guard protection, the picture may not display properly.
- Turn off all equipment before connection and read the appropriate operating instructions.

- **Non-HDMI-compliant cables cannot be utilized.**
- **Please use High Speed HDMI Cables that have the HDMI logo (as shown on the cover). It is recommended that you use Panasonic's HDMI cable.**
Recommended part number:
RP-CDHG10 (1.0 m/3.3 ft), RP-CDHG15 (1.5 m/4.9 ft.), RP-CDHG20 (2.0 m/6.6 ft), RP-CDHG30 (3.0 m/9.8 ft.), RP-CDHG50 (5.0 m/16.4 ft.), etc.
- When outputting 1080p signal, please use HDMI cables 5.0 meters or less.

Connecting to a television

A Connecting to HDMI AV OUT terminal

You can enjoy high quality, digital video and audio.

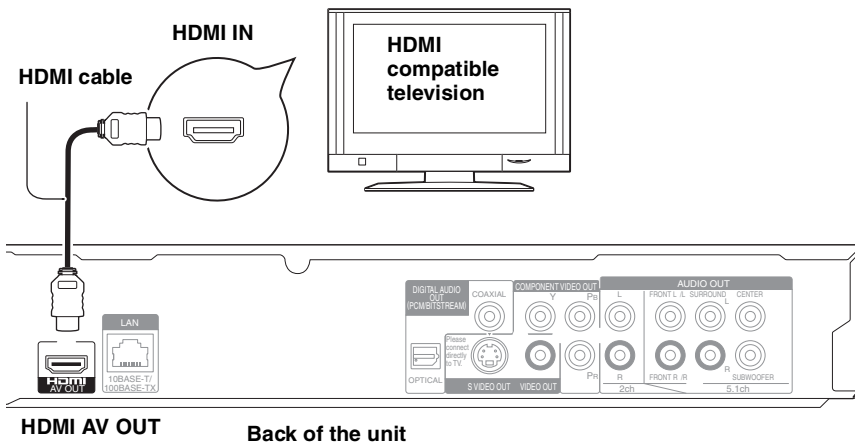

NECESSARY SETTINGS

- "HDMI Video Mode" and "HDMI Audio Output" : "On" (⇒ 28)



To enjoy a richer sound

- Use connections **E**, **F** or **G** (⇒ 7, 8) additionally.
In case of the connection **F** or **G**, set "HDMI Audio Output" to "Off" (⇒ 28)

With this connection, you can use VIERA Link "HDAVI Control" (⇒ 23).

B Connecting to COMPONENT VIDEO OUT terminal

You can enjoy high definition images by connecting to a component video terminals that supports 720p (750p) and 1080i (1125i) signals.

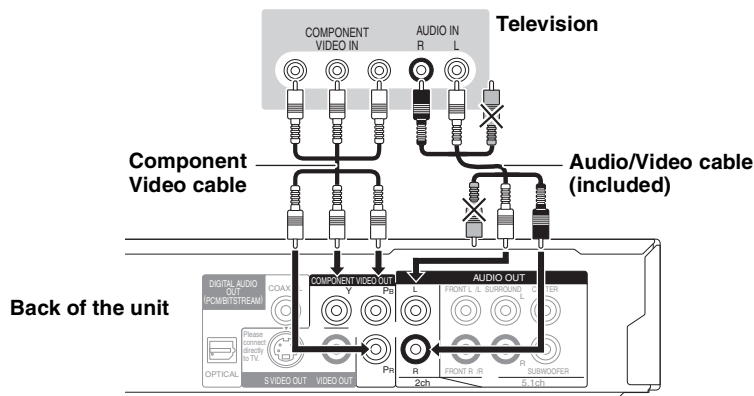

- Connect terminals of the same color.
- Unplug the yellow plug of Audio/Video cable.
- Set "Black Level Control" to "Darker". (⇒ 26)
- The video output resolution is restricted to "480p" when DVD-Video is output from the COMPONENT VIDEO OUT terminals.



To enjoy high definition/ progressive video

- Connect to a television that supports 480p or higher.
- Set "Component Video Resolution" to "480p", "720p" or "1080i". (⇒ 28)
- Set "HDMI Video Mode" to "Off". (⇒ 28)
Otherwise, the video is output as 480i.

C Connecting to S VIDEO OUT terminal

The S VIDEO OUT terminal provides a more vivid picture than the VIDEO OUT terminal.

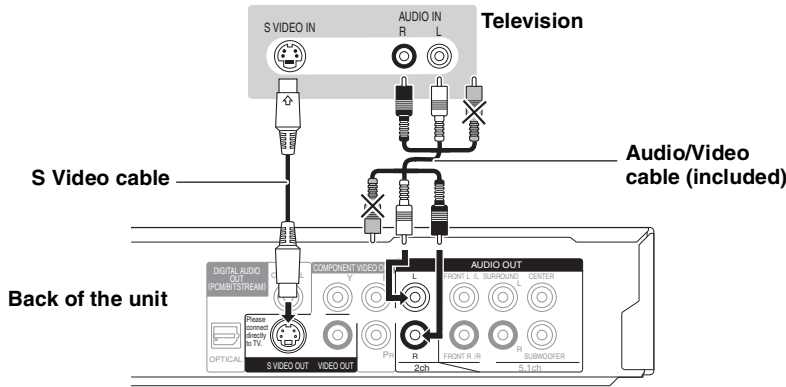

- NOTE**
- High definition video cannot be output with this connection. Use connection **A** or **B** (⇒ 6) for high definition video.
 - Unplug the yellow plug of Audio/Video cable.
 - Actual video quality depends on the television.

D Connecting to VIDEO OUT terminal

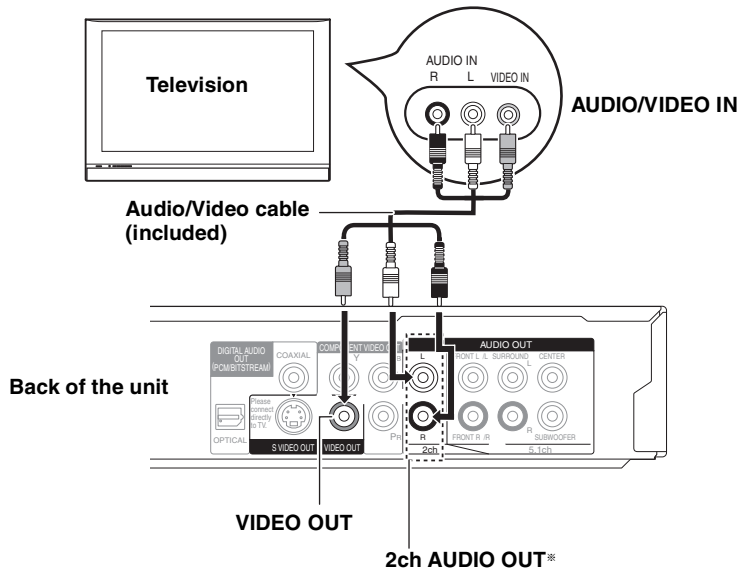

- NOTE**
- Connect terminals of the same color.
 - High definition video cannot be output with this connection. Use connection **A** or **B** (⇒ 6) for high definition video.



- TIPS**
- * With audio cables, connect the AUDIO OUT terminals to the two-channel audio input terminals of an analog amplifier/receiver or system component in place of a television to enjoy stereo sound.

To improve picture quality

- Use connections **B** (⇒ 6) or **C**.

To enjoy a richer sound

- Use connections **F** or **G** (⇒ 8). (Unplug the red and white plugs.)

Connecting an amplifier/receiver

E Connecting to HDMI AV OUT terminal

When connected to a compatible amplifier/receiver, you can enjoy surround sound recorded with Dolby Digital Plus, Dolby TrueHD or DTS-HD.

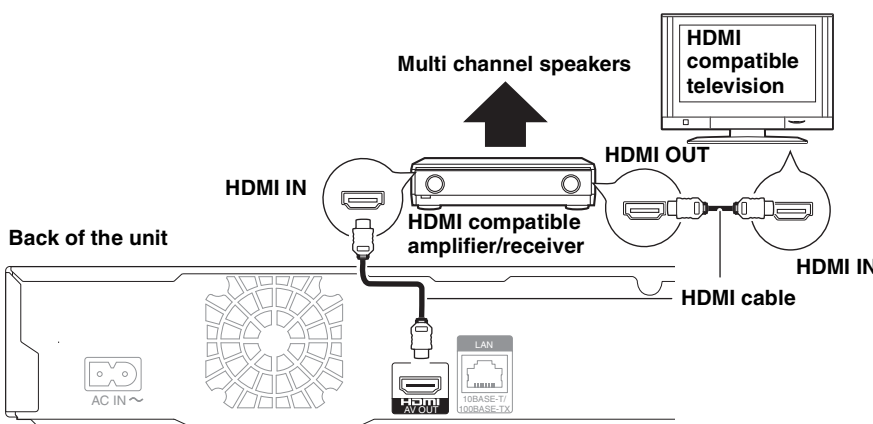

NECESSARY SETTINGS

- "HDMI Video Mode" and "HDMI Audio Output" : "On" (⇒ 28)
- "Speaker" : "Multi Channel" (⇒ 28)
- "Digital Audio Output" : Depending on the connected amplifier/receiver (⇒ 27)



- TIPS**
- With this connection, you can use VIERA Link "HDAVI Control" (⇒ 23).

F Connecting to 5.1ch AUDIO OUT terminal

When connected to a compatible amplifier/receiver using the 5.1ch AUDIO OUT terminals, you can enjoy surround sound.

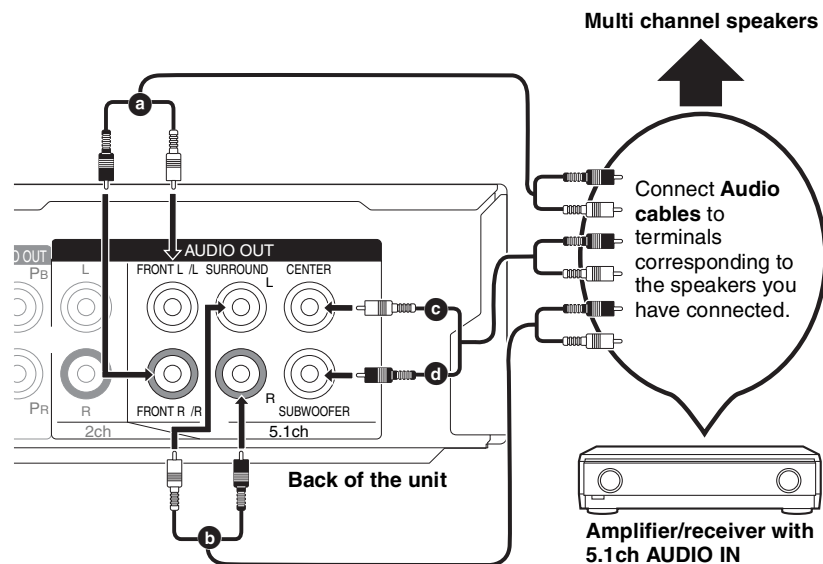

Cable connections

- a Front speaker (L/R)
- b Surround speaker (L/R)
- c Center speaker
- d Subwoofer



NOTE

NECESSARY SETTINGS

- "Speaker" : "Multi Channel" (⇒ 28)
- 7.1 channel disc is mixed down to 5.1 channel audio.

When connected to HDMI compatible television (⇒ 6, A) or other device.

- "HDMI Audio Output" : "Off" (⇒ 28) (Otherwise, the sound is output from the television and when the original audio comes in six channels or more, the audio is output as two channels only.)
- Depending on how the disc was recorded, the audio may not be output properly on the number of channels desired.

G Connecting to DIGITAL AUDIO OUT terminal

You can enjoy surround sound, when connected to an amplifier/receiver using the COAXIAL or OPTICAL terminal.

With COAXIAL

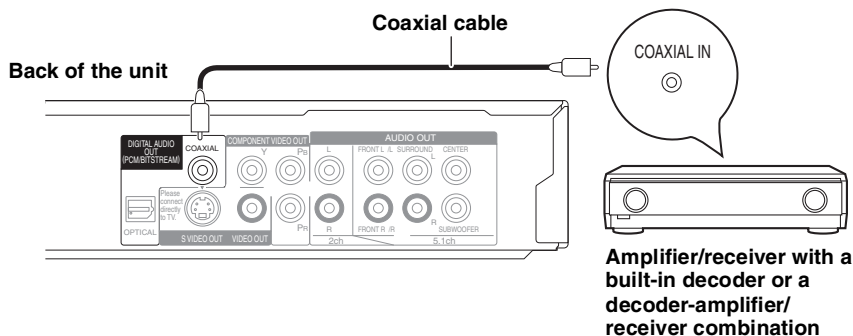

NOTE

NECESSARY SETTINGS

- "Digital Audio Output" : Depending on the connected amplifier/receiver (⇒ 27)

When connected to an HDMI compatible television (⇒ 6, A)

- "HDMI Audio Output" : "Off" (⇒ 28) (Otherwise, the sound may not be output with the desired settings.)

With OPTICAL

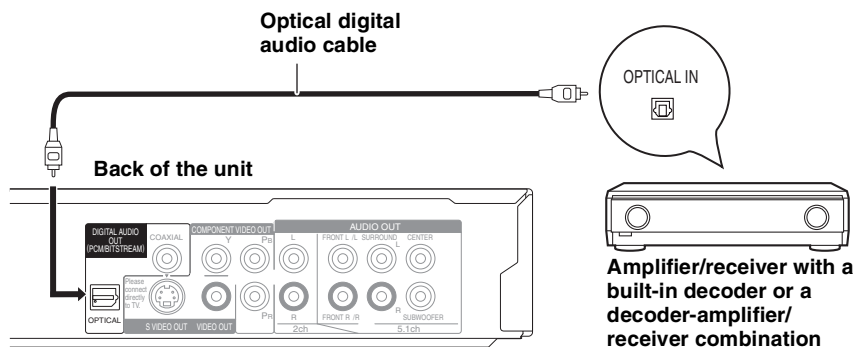

Connecting AC power supply cord

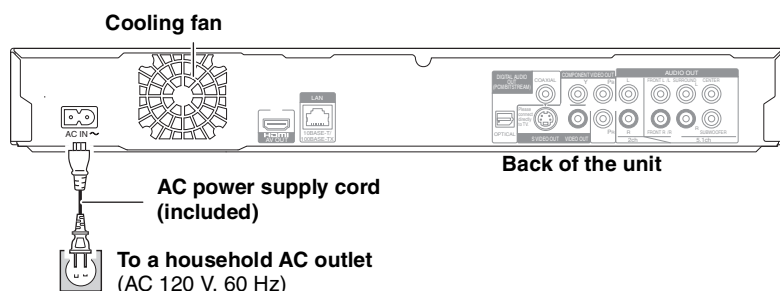

NOTE

Connect only after all other connections are complete.



TIPS

Conserving power

This unit consumes a small amount of power even when it is turned off (less than 1 W). To save power when the unit is not to be used for a long time, unplug it from the household AC outlet.

Network connection

With LAN

By connecting the unit to broadband Internet, you can use a disc that offers BD-Live function. (⇒ 16)
This connection also allows you to automatically check for the latest firmware version. (⇒ below)



- After connecting to the Internet, perform necessary settings. (⇒ 12)
- Inserting any cable other than a LAN cable in the LAN terminal can damage the unit.

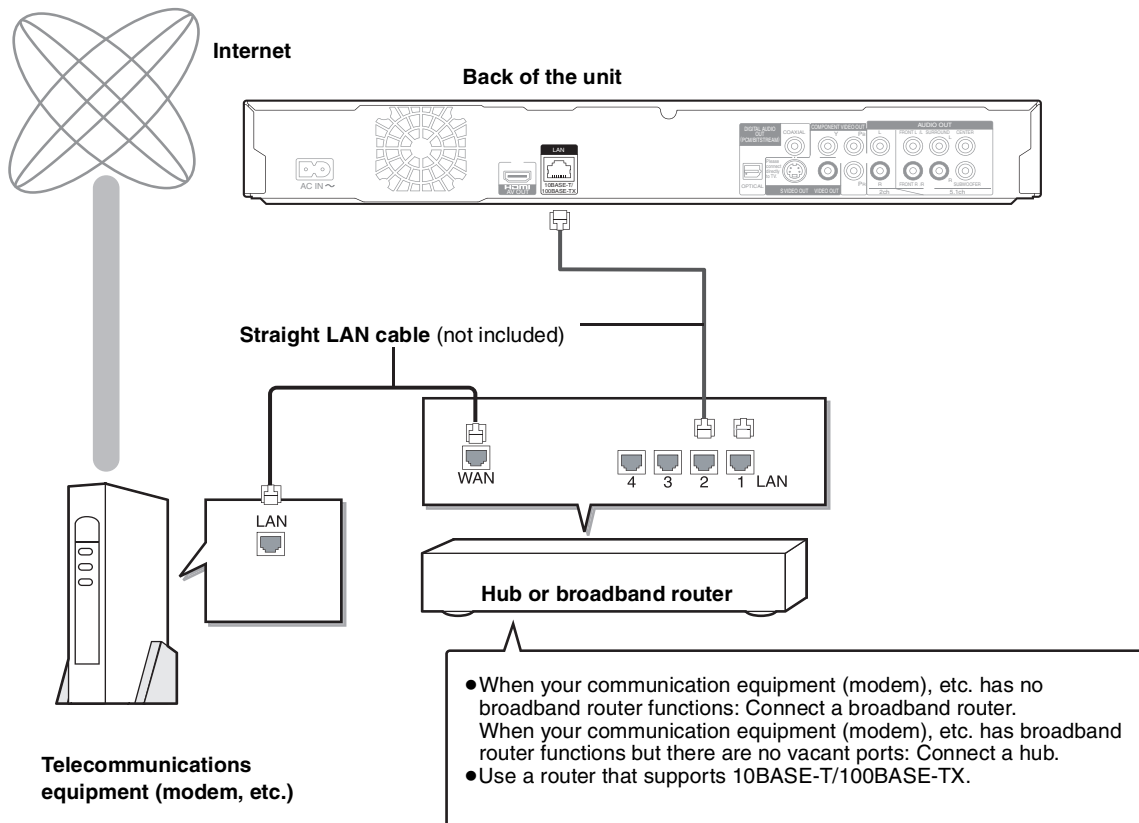

Firmware updating

When this unit remains connected to the Internet, it will automatically check for the latest firmware version when it is turned on.

When latest firmware version is available, the following screen is displayed. Select "Yes" or "No".

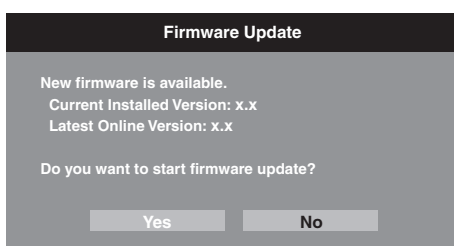

- If "Yes" is selected, then follow the on-screen instructions.
- If "No" is selected, then manually update the firmware later. (⇒ right)

After the latest firmware is downloaded, the system will be restarted and the firmware will be updated.

When the system is restarted, the screen display disappears and "START" is displayed on the unit's display.



After the firmware is updated and the system is restarted, the following screen indicates that the firmware update has been completed.

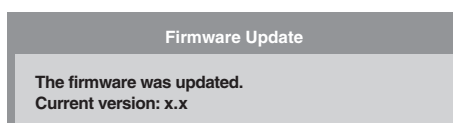

- During the update process, no other operations can be performed. Serious damage may occur if you turn the power off and/or press any buttons.



NOTE

- Downloading will require several minutes. It may take longer or the Internet may not be connected depending on the connection environment. It is required that you use a broadband connection.



TIPS

- If downloading on this unit fails or this unit is not connected to the Internet, then you can download the latest firmware from the following website and burn it to a CD-R to update the firmware.
<http://panasonic.net/support/>
- When the unit is connected to the Internet, communication charges may be generated.
- If you do not want to check for the latest firmware version when the unit is turned on, set "Automatic Update" to "Off". (⇒ 29)

Manually updating the firmware

If the firmware update is not carried out when the unit is turned on, a message is displayed when displaying the FUNCTIONS menu.

New firmware version available.
Please update from Setup.

You can manually update the firmware.

- 1) Press [SETUP].
- 2) Press [▲, ▼] to select "Others" and press [OK].
- 3) Press [▲, ▼] to select "Firmware Update" and press [OK].
- 4) Press [▲, ▼] to select "Update Now" and press [OK].
- 5) Press [◀, ▶] to select "Yes" and press [OK].

Control reference guide

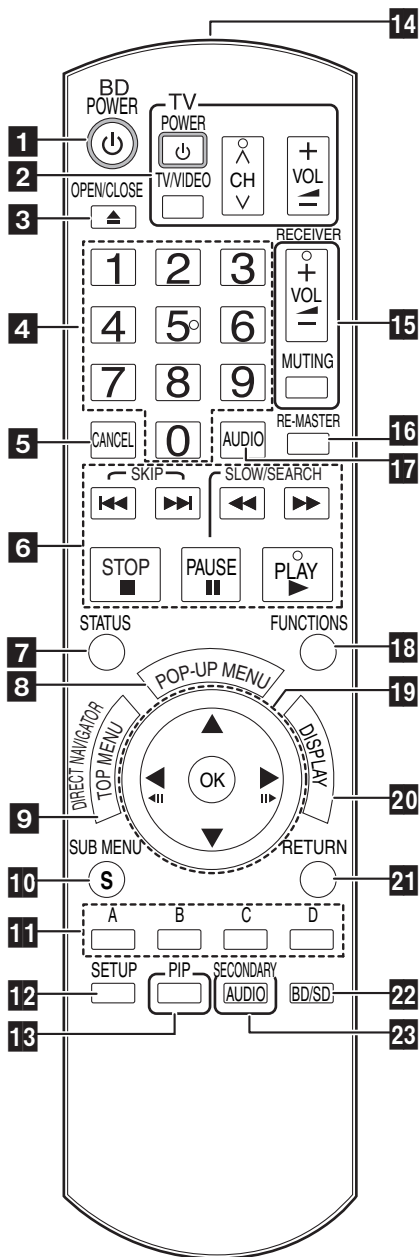

- 1** Turn the unit on and off (⇒ 11)
- 2** **TV operation buttons** (⇒ 11)
You can operate the TV through the unit's remote control.
[TV POWER] : Turn the television on and off
[TV/VIDEO] : Switch the input channel
[^ v CH] : Channel select
[+ - VOL] : Adjust the volume
- 3** Open or close the disc tray (⇒ 14)
- 4** **Numbered buttons**
Select title numbers, etc./Enter numbers (⇒ 15)
- 5** Cancel
- 6** **Basic playback control buttons** (⇒ 14, 15)
- 7** Show status messages (⇒ 15)
- 8** Show Pop-up menu (⇒ 14)
- 9** Show Top menu/Direct Navigator (⇒ 14)
- 10** Show sub menu (⇒ 18)
- 11** These buttons are used when operating a BD-Video disc that includes Java™ applications (BD-J). For more information about operating this kind of disc, please read the instructions that came with the disc.
The [A] and [B] buttons are also used with the "Title View", "Picture View" and "Album View" screens (⇒ 18).
- 12** Show Setup menu (⇒ 26)
- 13** Switch on/off Secondary Video (Picture-in-picture) (⇒ 16)
- 14** Transmit the remote control signal
- 15** **Receiver operation buttons** (⇒ 11)
You can operate an amplifier/receiver through the unit's remote control.
[+ - VOL] : Adjust the volume
[MUTING] : Mute the sound
- 16** Reproduce more natural audio (⇒ 15)
- 17** Select audio (⇒ 15)
- 18** Show FUNCTIONS menu (⇒ 21)
- 19** Selection/OK, Frame-by-frame (⇒ 15)
- 20** Show on-screen menu (⇒ 24)
- 21** Return to previous screen
- 22** Select disc drive or SD card drive (⇒ 14)
- 23** Switch on/off Secondary Audio (⇒ 16)

CAUTION

Do not place objects in front of the unit. The disc tray may collide with objects when it is opened, and this may cause injury.

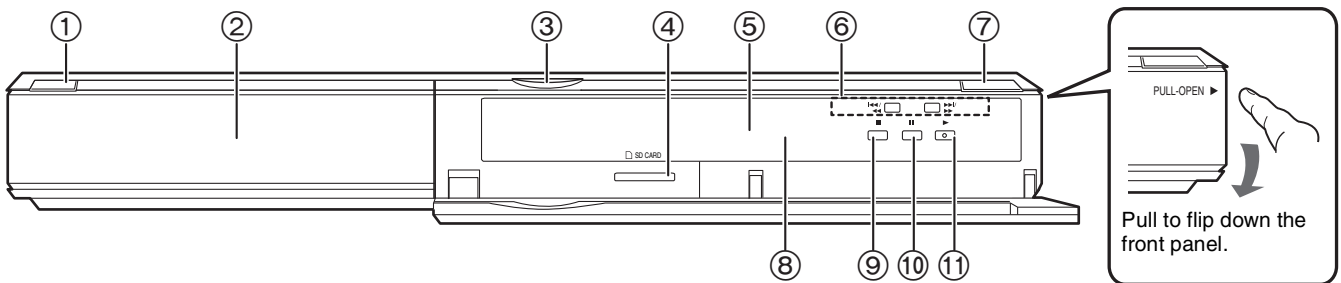

- 1** **POWER button (POWER ⏻/⏻)** (⇒ 11)
Press to switch the unit from on to standby mode or vice versa. In standby mode, the unit is still consuming a small amount of power.
- 2** Disc tray (⇒ 14)
- 3** SD Card LED
• It is possible to set the LED to turn on/off. (⇒ 27, SD Card LED Control)
- 4** SD card slot (⇒ 18)
- 5** Display



The indicator blinks when reading data from a disc or card, or writing data to a card.

- 6** Search/Slow-motion/Skip (⇒ 15)
Search: Press and hold (During play)
Slow-motion: Press and hold (During pause)
Skip: Press
- 7** Open or close the disc tray (⇒ 14)
- 8** Remote control signal sensor (⇒ 5)
- 9** Stop (⇒ 15)
- 10** Pause (⇒ 15)
- 11** Start play (⇒ 14)

Rear panel terminals (⇒ 6-9)

Easy Setting

After connecting your new player and pressing the power button, a screen for the basic settings will appear.

Preparation

Turn on the television and select the appropriate video input on the television.

1 Press [⏻ BD POWER].

Setup screen appears.

• If this unit is connected to a Panasonic TV (VIERA) supporting HDAVI Control 2 or HDAVI Control 3 via an HDMI cable, then the "On-screen Language" and "TV Aspect" setting information on the TV are captured from the TV.

2 Follow the on-screen instructions and make the settings with [▲, ▼] and [OK].

"On-screen Language" and "TV Aspect" are set. (⇒ 27, 28)

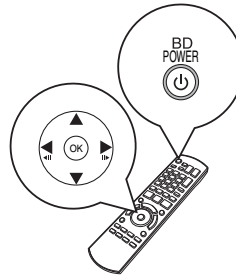

TIPS

- You can perform this setup anytime by selecting "Easy Setting" in the Setup menu. (⇒ 29)
- You can also change these settings individually. (⇒ 27, 28)

Setting the television and amplifier/receiver operation

You can operate the TV or amplifier/receiver using the unit's remote control.

Point the remote control at the television or amplifier/receiver.

1 For televisions

Input the 4-digit code with the numbered buttons while pressing [⏻ TV POWER].

For amplifiers/receivers

Input the 4-digit code with the numbered buttons while pressing [MUTING].

e.g., 0001: [0] ⇒ [0] ⇒ [0] ⇒ [1]

2 Test by turning on the television or adjusting the volume of the amplifier/receiver.



NOTE

- If your television or amplifier/receiver brand has more than one code listed, select the one that allows correct operation.
- If your television or amplifier/receiver brand is not listed or if the code listed for them does not allow control of your television or amplifier/receiver, this remote control is not compatible with them. Use their remote control.
- When audio is muted, press [MUTING] again.

Brand	TV Code
Panasonic	0051/0055/0250/0650
ADVENT	0761/0783/0815/0817/0842
AKAI	0030/0098/0672/0702/0812
AMERICA ACTION	0180
AOC	0003/0019/0030/0052/0137/0185
APEX DIGITAL	0748/0765/0767/0879/0890
AUDIOVOX	0003/0092/0180/0451/0623/0802/0875/1937
AXION	1937
BANG & OLUFSEN	0620/1620
BROKSONIC	0003/0236/0463
CASIO	0611/1205
DAEWOO	0019/0039/0066/0067/0091/0092/0451/0623/0661/0672/1661
EMERSON	0019/0038/0039/0154/0158/0171/0177/0178/0179/0180/0181/0182/0183/0185/0236/0270/0280/0282/0463/0623
ENVISION	0030/0813
EPSON	0833/0840
FISHER	0154/0159
FUJITSU	0179/0186/0683/0809/0853
GE	0021/0027/0029/0047/0051/0055/0135/0138/0174/0178/0251/0279/0282/0451/0747/1347/1447
GOLDSTAR	0019/0030/0032/0106/0178/0317/0409/0442/0457/0700/0856/1178/1265
GO VIDEO	0886
HAIER	0768/1034
HANNSPREE	1348/1351/1352
HEWLETT PACKARD	1088/1089/1101/1494/1502
HISENSE	0748
HITACHI	0016/0032/0038/0056/0095/0097/0145/0151/0173/0227/0279/0409/0413/1145
INFOCUS	0736/0738/0741/0752/0781/1164/1516
JVC	0036/0053/0069/0160/0169/0182/0731/1253
KLH	0765/0767
LG	0019/0030/0032/0106/0178/0317/0409/0442/0457/0700/0856/1178/1265
LOEWE	0136
MAGNAVOX	0020/0024/0028/0030/0036/0054/0096/0179/0186/0187/0230/0386/0706/0802/1254/1454
MARANTZ	0030/0054/0444/0704/0854/0855/1154
MEMOREX	0016/0106/0150/0154/0178/0179/0463

Brand	TV Code
MITSUBISHI	0014/0019/0093/0098/0150/0155/0178/0331/0358/0836/0868/1250
NORCENT	0748/0824/1089
OPTOMA	0887
ORION	0179/0236/0463/1463
PHILIPS	0054/0690/1154/1454
PHILIPS MAGNAVOX	0020/0024/0028/0030/0036/0054/0096/0179/0186/0187/0230/0386/0690/0706/0802/1154/1254/1454
PIONEER	0038/0166/0172/0679/0866
POLAROID	0765/0865/1262/1276/1314/1316/1326/1327/1328/1341/1498/1523
PROSCAN	0047/0747/1347/1447
PROVIEW	0835/1401/1498
RCA	0018/0019/0029/0038/0047/0090/0135/0174/0278/0679/0747/1047/1147/1247/1347/1447/1547
RUNCO	0017/0030/0251/0497/0603
SAMPO	0030/0032/0039/0052/0100/0110/1755
SAMSUNG	0019/0030/0032/0056/0060/0178/0329/0408/0427/0587/0702/0766/0812/0814/1060
SANSUI	0463
SANYO	0088/0107/0146/0154/0159/0232/0484/0799/0893
SHARP	0039/0093/0153/0157/0165/0220/0281/0386/0398/0491/0688/0818/0851
SONY	0000/0011/0080/0111/0273/0353/0810/0834/0867/1100
SVA	0587/0748/0768/0865/0870/0871/0872
SYLVANIA	0020/0028/0030/0054/0065/0096/0171/0381
SYMPHONIC	0171/0180
SYNTAX-BRILLIAN	1007/1144/1240/1255/1257/1258/1331
TATUNG	0003/0049/0055/0396/1101/1756
THOMSON	0209/0210/0047
TOSHIBA	0036/0060/0149/0154/0156/0650/0832/0845/1156/1164/1256/1265/1356/1656/1704
ULTRA	0391
VIEWSONIC	0857/0864/0885/1755
WESTINGHOUSE	0885/0889/0890/1282/1577
YAMAHA	0019/0030/0769/0833/0839
ZENITH	0016/0017/0092/0178/0463/1265

Brand	Amplifier Code	Receiver Code
Panasonic	0308	1308/0039/0367/1641/2001/2002
TECHNICS	0308	1308/0039/0208
BOSE	0674	1229/0639/1253/1933
DENON		1360/0004/0121/0273/1142/1306/1311
HARMAN		0110/0189/1289/1306
KARDON		0110/0189/1289/1306
KENWOOD		1313/0027/0042/0077/0186
KLH		1390/1412/1428
LINN		0189
MARANTZ		1189/1269/0039/0189/0128/1120/1289
MCINTOSH	0251	1289
NAD		0320
ONKYO		0135/0380/1298/1320
PHILIPS		1189/1269/0189/0391/1120/1266/1368
PIONEER	0823	1023/0150/0244/0531/0630/1343/1384
QUASAR		0039
RCA	0823	1023/1609/1254/0054/0530/0531/074/1390/1511
SAMSUNG		1295
SANYO		1251/1469/1801
SHARP		0186/1361
SHERWOOD		0491/0502/1077/1423/1517/1653
SONY	0815/1126	1622/0158/0168/0474/1367/1529/1658/1758
TEAC		0463/1074/1390
TOSHIBA		0135
YAMAHA	0354	1023/0176/0186/1331

Network settings

These settings are used if you will connect this unit to the Internet.

- The connection to the Internet may take time or the Internet may not be connected depending on the connection environment. (⇒ 28)
It is required that you use a broadband connection.

Preparation

- Connect to the network. (⇒ 9)

Testing the connection

Always test the connection when a LAN cable is connected or when new “IP Address/DNS Settings” have been made.

- 1 Press [SETUP].
- 2 Press [▲, ▼] to select “Network” and press [OK].
- 3 Press [▲, ▼] to select “IP Address/DNS Settings” and press [OK].
- 4 Press [▲, ▼] to select “Connection Test” and press [OK].

IP Address/DNS Settings

Connection Test	---
IP Address Auto Configuration (DHCP)	On
IP Address	---
Subnet Mask	---
Default Gateway	---
DNS Auto Configuration (DHCP)	On
Primary DNS	---
Secondary DNS	---
Auto Detect Connection Speed	On
Connection Speed Setting	---

OK RETURN

“Testing”: The test is in progress.

“Pass”: The connection is completed.

“Fail”: Please check the connection and settings.

- If the connection test fails, it may be necessary to change your router’s MAC address settings. The MAC address can be displayed by pressing [SETUP] and selecting “Network”.

Network

IP Address/DNS Settings
Proxy Server Settings

MAC Address: xx-xx-xx-xx-xx-xx

OK RETURN

Setting the IP address

In most cases, default settings can normally be used without making any changes.

Set the IP address only when the router has no DHCP server functions or when the router’s DHCP server function is disabled.

After performing steps 1–3 (⇒ above)

- 4 Press [▲, ▼] to select “IP Address Auto Configuration (DHCP)” and press [◀, ▶] to select “Off”.
- 5 Press [▲, ▼] to select “IP Address”, “Subnet Mask” or “Default Gateway” and press [OK].
- 6 Enter numbers with the numbered buttons and press [OK].
 - After checking the specifications for your broadband router, enter each number.
 - If the number is unknown, then check the number of other devices such as personal computers connected via a LAN cable. Assign a different number from those of other devices for the “IP Address” and the same number for others.
 - If a wrong number is entered, then press [CANCEL].

Note

- The numeric input range is between 0 and 255.

Setting the DNS-IP

In most cases, default settings can normally be used without making any changes.

When setting an assigned DNS server from your Internet service provider, perform the following settings.

After performing steps 1–3 (⇒ left)

- 4 Press [▲, ▼] to select “DNS Auto Configuration (DHCP)” and press [◀, ▶] to select “Off”.
- 5 Press [▲, ▼] to select “Primary DNS” or “Secondary DNS” and press [OK].
- 6 Enter numbers with the numbered buttons and press [OK].

- Follow the instructions given by your Internet service provider and enter the numbers.
If the number is unknown, then check the number of other devices such as personal computers connected via a LAN cable and assign the same number.
- If a wrong number is entered, then press [CANCEL].

Primary DNS

Please input Primary DNS and press [OK]. Press [CANCEL] to delete the selected character. To clear setting, delete all characters, then press [OK].

192 . 1 . . .

0 - 9 Number

Note

- The numeric input range is between 0 and 255.

Setting the connection speed

When the connection test results in “Fail” after the IP and DNS-IP addresses are assigned, perform the following settings.

After performing steps 1–3 (⇒ left)

- 4 Press [▲, ▼] to select “Auto Detect Connection Speed” and press [◀, ▶] to select “Off”.
- 5 Press [▲, ▼] to select “Connection Speed Setting” and press [◀, ▶] to select a connection speed.

- Select a connection speed in accordance with the environment of the network connected.
- When the settings are changed, the network connection may be disabled depending on the device.

Setting the proxy server

In most cases, default settings can normally be used without making any changes.

Please use this setting when instructed to by your Internet service provider.

- 1 Press [SETUP].
- 2 Press [▲, ▼] to select "Network" and press [OK].
- 3 Press [▲, ▼] to select "Proxy Server Settings" and press [OK].

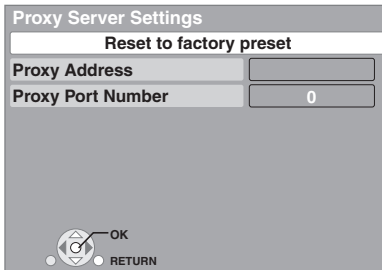

- 4 Press [▲, ▼] to select "Proxy Address" and press [OK].
 - The text entry screen is displayed.

Text field: shows the text you have entered

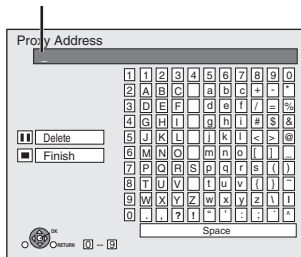

- 5 Press [▲, ▼, ◀, ▶] to select a character and press [OK].
Repeat this step to enter other characters.
 - Press [Delete] to delete.
- 6 Press [Finish] when you complete the entry.
- 7 Press [▲, ▼] to select "Proxy Port Number" and press [OK].
- 8 Enter numbers with the numbered buttons and press [OK].

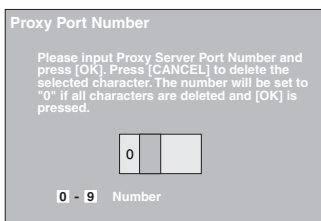

- 9 Press [◀, ▶] to select "Yes" and press [OK].



TIPS

- The specified ports may be blocked and not be able to be used depending on the network environment.

In order to restore the default settings

After performing steps 1-3

- 1) Press [▲, ▼] to select "Reset to factory preset" and press [OK].
- 2) Press [◀, ▶] to select "Yes" and press [OK].

Using the numbered buttons to enter characters
e.g., entering the letter "F"

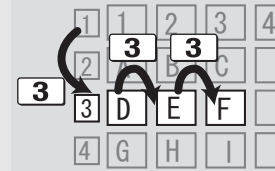

- 1) Press [3] to move to the 3rd row.
- 2) Press [3] twice to highlight "F".
- 3) Press [OK].

Basic play (Playing video contents)

Instructions for operations are generally described using the remote control in these operating instructions.

Preparation

Turn on the television and select the appropriate video input on the television.

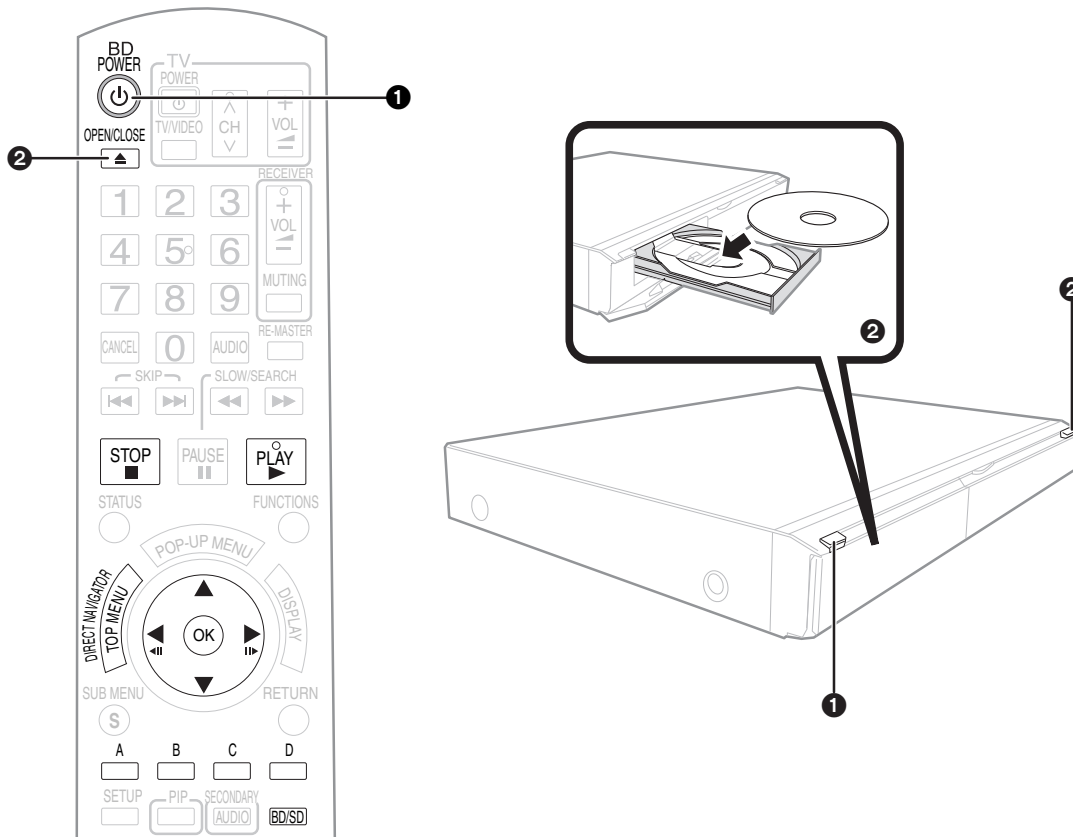
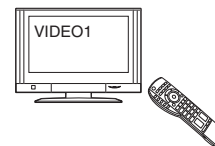

- 1 Press [BD POWER] to turn on the unit.
- 2 Press [OPEN/CLOSE] to open the disc tray and load the disc.

- Press the button again to close the tray.
- Load double-sided discs so the label for the side you want to play is facing up.
- DVD-RAM: Remove discs from their cartridges before use.



Play starts.

- If a disc with data in different file formats is inserted, the file selection menu is displayed. Press [▲, ▼] to select the desired file format and press [OK].
- If play does not start, press [▶] (PLAY).

e.g., **BD-V**

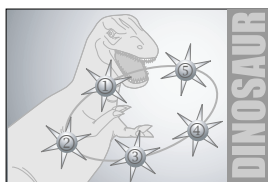

e.g., **DVD-VR**

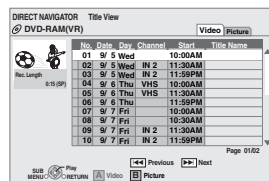

- If the menu is displayed, press [▲, ▼, ◀, ▶] to select the item and press [OK].
- If the screen prompting you to use the color buttons appears, continue to operate with the color buttons on the remote control.



NOTE

- DISCS CONTINUE TO ROTATE WHILE MENUS ARE DISPLAYED. Press [■] when you have finished playback to protect the unit's motor, your television screen and so on.



TIPS

To switch drives

- Press [BD/SD] to select "BD" to play a disc.
- If a disc or an SD card is inserted while the unit is stopped, the drive switches automatically depending on the inserted media.

To display menus

BD-V AVCHD DVD-VR DVD-V
Press [TOP MENU/DIRECT NAVIGATOR].

To show Pop-up menu **BD-V**

The Pop-up menu is a special feature available with some BD-Video discs. This menu may vary with discs. For the operating method, refer to the instructions for the disc.

- 1) Press [POP-UP MENU].
- 2) Press [▲, ▼, ◀, ▶] to select the item and press [OK].

- Pop-up menu also appears by pressing [SUB MENU] and selecting "Pop-up Menu".
- Press [POP-UP MENU] to exit the screen.

- The producers of the disc can control how discs are played. So you may not always be able to control play as described in these operating instructions. Read the disc's instructions carefully.
- When playing a set of two or more BD-Video discs, the menu screen may continue to display even if the disc has been ejected.
- It may take time to read BD-Video discs that include BD-J (⇒ 40).



TIPS

- You can play data in AVCHD format recorded on an SD card.

Other operations during play (These functions may not work depending on the disc.)



Stop

The stopped position is memorized.

Resume play function

Press [▶] (PLAY) to restart from this position.

- The position is cleared if the tray is opened or you press [■] several times to display "STOP" on unit's display.
- **BD-V**: On BD-Video discs including BD-J (⇒ 40), the resume play function does not work.
- **CD** **MP3** **DivX**: The position is cleared if the unit is turned off.



Pause

- Press [||] again or [▶] (PLAY) to restart play.

SLOW/SEARCH



Search/Slow-motion

The speed increases up to 5 steps.

- Press [▶] (PLAY) to revert to normal playback speed.
- For some discs, the speed may not change.

Search

While playing, press [◀◀] or [▶▶].

- Press and hold [◀◀/▶▶] or [▶▶/▶▶] on the main unit.

BD-V AVCHD DVD-VR DVD-V

Audio is heard during first level of forward search.

- **DivX**: Audio is not heard during all levels of search.

- **CD** **MP3**: The speed is fixed to a single step.

Slow-motion

While paused, press [◀◀] or [▶▶].

- Press and hold [◀◀/▶▶] or [▶▶/▶▶] on the main unit.

- **BD-V** **AVCHD**: Forward direction [▶▶] only.

- **DVD-VR** If continued for approx. 5 minutes, slow-motion play pauses automatically.

SKIP



Skip

Skip to the title, chapter or track you want to play.

- Each press increases the number of skips.
- **DivX**: Backward direction [◀◀] only.

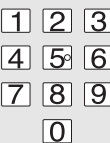

Starting from a selected item

Play starts from the selected title or chapter.

BD-V AVCHD

e.g., 5: [0] ⇒ [0] ⇒ [5]
15: [0] ⇒ [1] ⇒ [5]

DVD-V

e.g., 5: [0] ⇒ [5]
15: [1] ⇒ [5]

- While stopped (the image on the right is displayed on the screen), the title is designated. While playing, the chapter is designated.



Frame-by-frame

While paused, press [◀] (◀◀) or [▶] (▶▶).

Each press shows the next frame.

- Press and hold to change in succession forward or backward.
- Press [▶] (PLAY) to revert to normal playback speed.
- **BD-V** **AVCHD**: Forward direction [▶] (▶▶) only.

Screen Aspect

When black bars are shown at the top, bottom, left, and right sides of the screen, you can enlarge the image to fill the screen.

- 1 Press [SUB MENU].
- 2 Press [▲, ▼] to select "Screen Aspect" and press [OK].
- 3 Press [◀, ▶] to select "Side cut" or "Zoom".

Normal: Normal output

Side cut: The black bars on the right and left sides of the 16:9 image disappear and the image is enlarged. Please note that the right and left sides of the image are cut off when the black bar is not displayed.

Zoom: The black bars on the top and bottom sides of the 4:3 image disappear and the image is enlarged. Please note that the top and bottom sides of the image are cut off when the black bar is not displayed.

- When "TV Aspect" (⇒ 28) is set to "4:3 Pan & Scan" or "4:3 Letterbox", the "Zoom" effect is disabled.

STATUS



Status messages

The status messages give you information about what is currently being played. Each time you press [STATUS], the information displayed will change.

e.g. **BD-V** Type of disc Play status

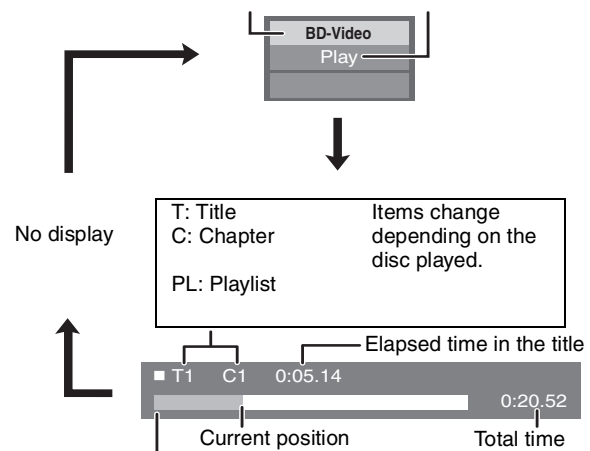

No display

No display

Depending on the kind of disc or the playback status, this display may not appear.



Changing audio during play

BD-V **AVCHD** **DVD-V**

e.g. **DVD-V**



English is selected.

You can change the audio channel number each time you press the button. This allows you to change the soundtrack language (⇒ 24, Soundtrack), etc.

DVD-VR **DivX**

AudioLR → AudioL → Audio R

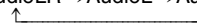

"AudioLR" is selected

RE-MASTER



Reproducing more natural audio (Discs recorded at 48 kHz or less)

This feature gives you a more natural sound by adding higher frequency signals not recorded on the track.

Press [RE-MASTER] to select "Re-master 1", "Re-master 2" or "Re-master 3".

Select the one that you like best.

Setting	When playing LPCM sound Type of music	Other types of sound Effect level
Re-master 1	High tempo (e.g., pop and rock)	Light
Re-master 2	Various tempos (e.g., jazz)	Medium
Re-master 3	Low tempo (e.g., classical)	Strong
Off	Off	Off

- This function is effective for audio from the HDMI terminal or the DIGITAL AUDIO OUT terminal only when "Digital Audio Output" is set to "PCM". (However, in this case, audio is output as 2ch from the DIGITAL AUDIO OUT terminal.)

Enjoying BD-LIVE™ or BONUSVIEW™ in BD-Video BD-V

This unit allows you to enjoy functions such as picture-in-picture, secondary audio and Virtual packages, etc., with BD-Video supporting BONUSVIEW (BD-ROM version 2 Profile 1 version 1.1/Final Standard Profile). In addition to the BONUSVIEW function, BD-Video supporting BD-Live (BD-ROM version 2 Profile 2) that has a network extension function allows you to enjoy more functions such as online games by connecting this unit to the Internet.

- These discs may not be on sale in certain regions.

Playing secondary video (picture-in-picture) and secondary audio

Secondary video can be played from a disc compatible with the picture-in-picture function.

For the playback method, refer to the instructions for the disc.

To turn on/off secondary video Press [PIP].

Secondary video is played.

- "PiP ON" is displayed.
- Press the button to turn it ON and OFF.

To turn on/off audio with the secondary video Press [SECONDARY AUDIO].

The secondary audio is played.

- "Secondary Audio ON" is displayed.
- Press the button to turn it ON and OFF.

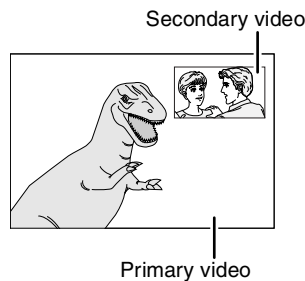

NOTE

- Discs may not always be played back according to the settings on this unit, as certain playback formats are prioritized on certain discs.
- Only the primary video is played during search/slow-motion or frame-by-frame.
- When "BD-Video Secondary Audio" in "Digital Audio Output" is set to "Off", secondary audio will not be played even if [SECONDARY AUDIO] is pressed. Please check that "BD-Video Secondary Audio" is set to "On" (⇒ 27).
- When the secondary video is turned off, the secondary audio does not play.

Virtual package

For a disc compatible with the virtual package (⇒ 40), data is copied to other media (⇒ 40, Local storage) from the Internet or disc to use the different functions while playing the data.

For this unit, data is copied to an SD card.

The methods for copy and playback and the required available capacity on the card may vary with the disc. For details, refer to the instructions for the disc.

To use the above functions, it is recommended that you format the card on this unit. Format the card using the following procedures. BD-Video data, such as secondary video recorded on the card, can also be erased with the following procedures.

Formatting SD cards/Deleting data

- 1) Insert an SD card (⇒ 18).
- 2) Press [FUNCTIONS].
- 3) Press [▲, ▼] to select "Other Functions" and press [OK].
- 4) Press [▲, ▼] to select "Card Management" and press [OK].
- 5) Press [▲, ▼] to select "BD-Video Data Erase" or "Format SD Card" and press [OK].
- 6) Press [◀, ▶] to select "Yes" and press [OK].
- 7) Press [◀, ▶] to select "Start" and press [OK].

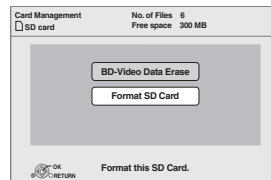

NOTE

- If the SD card is removed from this unit when using data that was copied with the virtual package function, disc playback stops.
- Images and audio may freeze momentarily during playback.
- Data cannot be copied in the following cases.
 - The card is protected.
 - Available capacity on the card is too small. Delete unnecessary data or use a new card.
- When the function fails to work properly, even if the data is copied, format the card again with this unit. (In this case, all data will be erased.)



TIPS

- If an SD card with files in different formats is used, images and audio may not play back properly. It is recommended that you use an SD card with no data or an SD card formatted on this unit.



NOTE

- It is impossible to restore data after formatting the card or erasing the data. Once a card is formatted, all data including those recorded on the PC is erased as well, even if the data were protected with other equipment. Confirm whether the card can be formatted.

Enjoying BD-Live discs with Internet

Preparation

- Connect to the network. (⇒ 9)

This unit supports BD-Live, a new BD-Video function that allows you to use the following interactive functions when connected to the Internet.

(The usable functions and the operating method may vary with each disc. For details, refer to the instructions for the disc.)

- Additional contents such as movie's trailer, subtitles and BD-J (⇒ 40), etc. can be downloaded to SD cards (⇒ 40, Local storage) to play them.
- Special video data, etc. may be played back while they are being downloaded to an SD card.

■ AACS Online

When discs supporting BD-Live are played back, the player or disc IDs may be sent to the content provider via the Internet.

Services and functions to be provided differ depending on the disc.

- You can be introduced to other similar movies if you record your viewing history on the server by using these IDs.
- Game score histories can be saved.



NOTE

- The unit must be connected to the Internet and set up (⇒ 12) to use the BD-Live functions. "BD-Live Internet Access" may need to be changed for certain discs (⇒ 26).

- The connection to the Internet may not be connected depending on the connection environment. It is required that you use a broadband connection.

- The unit is connected to the Internet when BD-Live functions are used, generating communication charges.

- Special video data, etc. may be played back while they are being downloaded to an SD card using one function of BD-Live. The playback may be paused depending on the communication environment.

- Some functions may be disabled to prevent skipping to sections that have not been downloaded, etc.



TIPS

Enjoying High Bit rate Audio and Video of BD-Video BD-V

Regarding High Bit rate Audio

This unit supports high bit rate audio (Dolby Digital Plus, Dolby TrueHD, DTS-HD High Resolution Audio and DTS-HD Master Audio) adopted in BD-Video.

In order to enjoy these audio formats, connect this unit to your amplifier/receiver supporting HDMI Ver. 1.3 using a High Speed HDMI cable (⇒ 6) and set "Audio Priority Preset" (⇒ 27) to "Quality".

However, there are the following restrictions.

- The clicking sound on the menu and audio with secondary video in picture-in-picture mode (⇒ 16) cannot be output.
- Any audio format not decoded by the connected amplifier/receiver cannot be output properly.
If you want to output the audio properly, set "Audio Priority Preset" to "Secondary" or "Custom".

■ Differences in audio output by setting

The output audio type can be changed depending on the menu settings.

Set "Digital Audio Output" (⇒ 27) in accordance with your favorite audio with reference to the following table.

Secondary

To enjoy secondary audio

Original audio	Dolby Digital Plus	Dolby TrueHD	DTS-HD High Resolution Audio	DTS-HD Master Audio
	↓	↓	↓	↓
Audio formats are output as:	PCM			

- "BD-Video Secondary Audio" is set to "On", and "Digital Audio Output" is fixed to "PCM".
- Data of 6 channels or more will be output in 5.1 channels.

Quality

To enjoy high bit rate audio

Select this mode if your amplifier/receiver is equipped with these decoders.

Original audio	Dolby Digital Plus	Dolby TrueHD	DTS-HD High Resolution Audio	DTS-HD Master Audio
	↓	↓	↓	↓
Audio formats are output as:	Dolby Digital Plus	Dolby TrueHD	DTS-HD High Resolution Audio	DTS-HD Master Audio

- "Digital Audio Output" is set to "Bitstream", and "BD-Video Secondary Audio" is fixed to "Off".
The clicking sound on the menu and audio with secondary video in picture-in-picture mode is not outputted.

Custom

To set the high bit rate audio and secondary audio individually

	"BD-Video Secondary Audio": "On"		"BD-Video Secondary Audio": "Off"	
	PCM	Bitstream	PCM	Bitstream
Maximum 5.1ch PCM		Dolby Digital	Maximum 7.1ch original PCM	The original format

Note
Enjoying 7.1ch LPCM
Connect this unit to your amplifier/receiver using an HDMI cable, and select "Quality" or "Custom" and then set "BD-Video Secondary Audio" to "Off".

When the unit is connected using the DIGITAL AUDIO OUT terminal, there are restrictions for high bit rate audio.

Original audio	PCM	Bitstream	
		"BD-Video Secondary Audio": "On"	"BD-Video Secondary Audio": "Off"
Dolby Digital Plus/Dolby TrueHD (7.1ch)	Down-mixed 2ch PCM	Dolby Digital	Dolby Digital
DTS-HD High Resolution Audio/DTS-HD Master Audio (7.1ch)	Down-mixed 2ch PCM	Dolby Digital	DTS Digital Surround
7.1ch LPCM	Down-mixed 2ch PCM	Down-mixed 2ch PCM	Down-mixed 2ch PCM

- When "Secondary" is selected, the audio is output in the formats enclosed in bold frames.
- When "Quality" is selected, the audio is output in the formats shown in the shaded area.

Regarding 24p output

Many BD-Video movie contents are recorded in 24 frames/second in accordance with the film materials. However, they will normally be output in 60 frames/second in accordance with the display format.

These can be output in 24p as the original. Therefore, high-quality video can be enjoyed, such as the improved clarity, enhanced perspective, etc.

NECESSARY CONNECTIONS

- Connect to a TV supporting 1080/24p input via an HDMI cable.

NECESSARY SETTINGS

- "24p Output": "On" (⇒ 28)

Chapter playback DVD-VR

- ❶ Insert a disc (⇒ 14).
- ❷ While “Title View” screen is displayed
Press [▲, ▼] to select the title and press [SUB MENU].

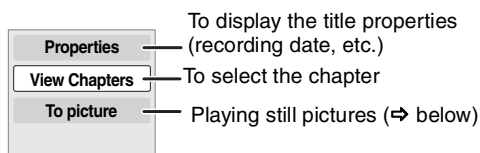

- ❸ Press [▲, ▼] to select “View Chapters” and press [OK].
- ❹ Press [◀, ▶] to select the chapter and press [OK].

Playing still pictures JPEG

You can play still pictures recorded onto a BD-RE, DVD-RAM, CD-R/RW and an SD card.

- ❶ Insert a disc (⇒ 14) or an SD card (⇒ right).

- If a disc or an SD card containing data in different file formats is inserted, the file selection menu may be displayed.

SD card:

Press [▲, ▼] to select “Picture (JPEG) Navigator” and press [OK].

CD-R/RW:

Press [▲, ▼] to select “Pictures” and press [OK].

BD-RE, DVD-RAM

“Album View” screen is displayed

e.g.,

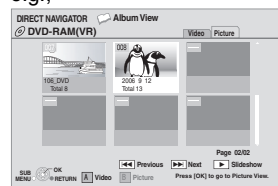

- When the “Title View” screen is displayed, press the [B] button to switch to the “Album View” screen.

- ❷ Press [▲, ▼, ▶, ◀] to select the album and press [OK].

e.g.,

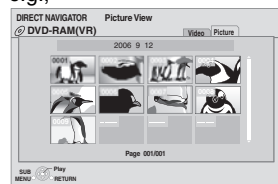

- ❸ Press [▲, ▼, ▶, ◀] to select the still picture and press [OK].

e.g.,



e.g.,

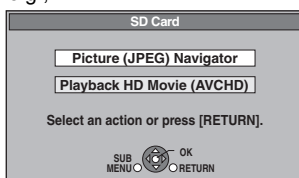

CD-R/RW, SD card

“Picture View” screen is displayed

⇒ Go to step ❸

e.g.,

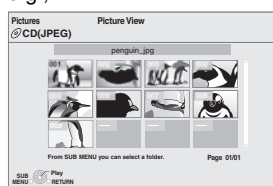

Inserting a card

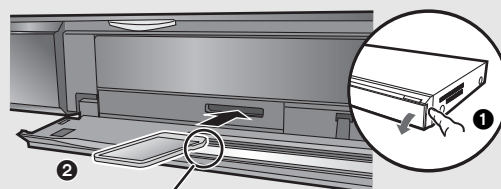

Insert the card label up with the cut-off corner on the right.

- ❶ Pull to flip down the front panel.
- ❷ Insert the SD card into the SD card slot.
 - Press on the center of the card until it clicks into place.

Removing the card

Press on the center of the card and pull it straight out.



TIPS

- Press [◀, ▶] to display the previous or next still picture.
- Press [◀◀, ▶▶] to show other pages.

To return to the previous screen

Press [RETURN].

To exit the screen

Press [DIRECT NAVIGATOR].

CD-R/RW

Discs containing data in different file formats. To switch from the MP3 or DivX menu to JPEG menu, perform steps below.

- 1) Press [FUNCTIONS].
- 2) Press [▲, ▼] to select “Menu” and press [OK].
- 3) Press [▲, ▼] to select “Pictures” and press [OK].



NOTE

- Small-sized still pictures are displayed with a frame.

Useful functions during still picture play

Start Slideshow

You can display still pictures one by one at a constant interval.

BD-RE, DVD-RAM

- While the "Album View" screen is displayed
Press [▲, ▼, ◀, ▶] to select the album and press [SUB MENU].
 - Press [▲, ▼] to select "Start Slideshow" and press [OK].
- You can also start slideshow by pressing [▶] (PLAY) after selecting the album.

CD-R/RW, SD card

- While the "Picture View" screen is displayed
Press [SUB MENU].
- Press [▲, ▼] to select "Start Slideshow" and press [OK].

To stop slideshow

Press [■].

Slideshow with music

SD card only

If a music CD is inserted in the disc tray while playing slideshows, the music CD starts playing automatically as background music.

- You cannot search or skip on a music CD.
- When the slideshow stops, playback of the music CD also stops.
- MP3**: This function will not operate.

Slideshow settings

In step ② in "Start Slideshow" above,

- Press [▲, ▼] to select "Slideshow settings" and press [OK].
- To change the display interval
Press [▲, ▼] to select "Display Interval" and press [◀, ▶] to select the interval ("Long", "Normal" or "Short").
 - When a still picture with large number of pixels is played, the display interval may become longer. Even if the setting is changed, the display interval may not become shorter.**To repeat slideshow**
Press [▲, ▼] to select "Repeat Play" and press [◀, ▶] to select "On" or "Off".
- Press [▲, ▼, ◀, ▶] to select "Set" and press [OK].

Rotate

- While playing (except for slideshows)
Press [SUB MENU].
 - Press [▲, ▼] to select "Rotate Right" or "Rotate Left" and press [OK].
- The rotation information will be stored until the unit is turned off or the media is removed.

Zoom out

This function is only available for small-sized still pictures.

- While playing (except for slideshows)
Press [SUB MENU].
 - Press [▲, ▼] to select "Zoom out" and press [OK].
- To cancel "Zoom out", press [▲, ▼] to select "Zoom in" in step ② and press [OK].
 - The zoom-out information will not be stored.

To select the still pictures in another folder

BD-RE, DVD-RAM

To switch to another higher folder

(Only if there is a multiple number of higher folders recognizable)

- While the "Album View" screen is displayed
Press [SUB MENU].
- Press [▲, ▼] to select "Select Root folder" and press [OK].

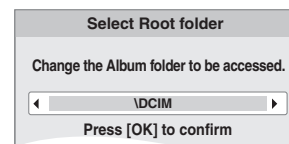

- Press [◀, ▶] to select the higher folder and press [OK].

CD-R/RW

- While the "Picture View" screen is displayed
Press [SUB MENU].
- Press [▲, ▼] to select "Select Folder" and press [OK].
- Press [▲, ▼] to select a folder and press [OK].
The "Picture View" screen for the folder appears.

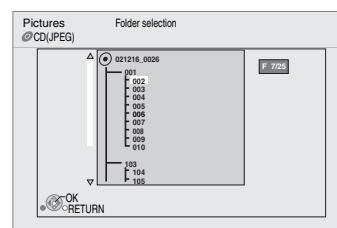

To show the picture properties

While playing
Press [STATUS] twice.

e.g. JPEG on DVD-RAM
Shooting date



To exit, press [STATUS].

Playing DivX videos DivX

You can play DVD-R, DVD-R DL and CD-R/CD-RW discs which contain DivX video contents that have been recorded on a personal computer.

● Because DivX format can use many different codecs, there is no guarantee that all DivX files will play. (⇒ 22, “About MP3/JPEG/DivX files”)

1 Insert a disc. (⇒ 14)

- If a disc containing data in different file formats is inserted, the file selection menu may be displayed. Press [▲, ▼] to select “DivX” and press [OK].

e.g.,

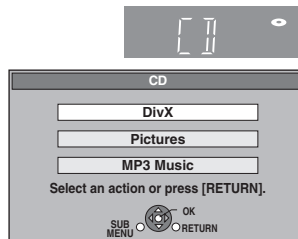

2 Press [▲, ▼] to select the title and press [OK].

Play starts on the selected title.

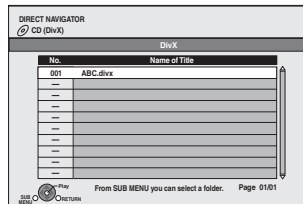

NOTE

- The picture sizes set for recording may prevent the unit from showing pictures in the proper aspect. You may be able to adjust the aspect through the TV.
- Successive play is not possible.



TIPS

- You can use search and skip functions. (⇒ 15)
- Press [◀◀, ▶▶] to show other pages.

CD-R/RW

Discs containing data in different file formats.

To switch from the JPEG or MP3 menu to DivX menu, perform steps below.

- 1) Press [FUNCTIONS].
- 2) Press [▲, ▼] to select “Menu” and press [OK].
- 3) Press [▲, ▼] to select “DivX” and press [OK].

Playing a title in another folder

- 1 While the “DIRECT NAVIGATOR” is displayed Press [SUB MENU], press [▲, ▼] to select “Select Folder” and press [OK].

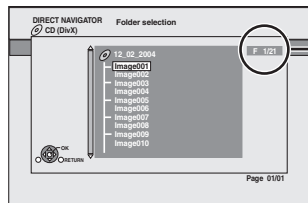

Selected folder No. /Total folders

If the folder has no title, “- -” is displayed as folder number.



NOTE

- You cannot select folders that contain no compatible files.



TIPS

To return to the previous screen
Press [RETURN].

- 2 Press [▲, ▼] to select a folder and press [OK].
The “DIRECT NAVIGATOR” for the folder appears.

Regarding DivX VOD content

DivX Video-on-Demand (VOD) content is encrypted for copyright protection. In order to play DivX VOD content on this unit, you first need to register the unit.

Follow the on line instructions for purchasing DivX VOD content to enter the unit’s registration code and register the unit. For more information about DivX VOD, visit www.divx.com/vod

Display the unit’s registration code.

(⇒ 29, “DivX Registration” in “Others”)



8 alphanumeric characters

- After playing DivX VOD content for the first time, another registration code is then displayed in “DivX Registration”. Do not use this registration code to purchase DivX VOD content. If you use this code to purchase DivX VOD content, and then play the content on this unit, you will no longer be able to play any content that you purchased using the previous code.
- If you purchase DivX VOD content using a registration code different from this unit’s code, you will not be able to play this content. (“Authorization Error” is displayed.)

Regarding DivX content that can only be played a set number of times
Some DivX VOD content can only be played a set number of times. When you play this content, the remaining number of plays is displayed. You cannot play this content when the number of remaining plays is zero. (“Rental Expired.” is displayed.)

When playing this content

- The number of remaining plays is reduced by one if
 - you press [⏻ BD POWER].
 - you press [■].
 - you press [DIRECT NAVIGATOR].
 - you press [◀◀] or [▶▶] etc. and arrive at another content or the start of the content being played.
 - you press [BD/SD] to change the drive.
- Resume functions do not work.

Displaying subtitles text (⇒ 24, Subtitle)

You can display subtitles text onto the DivX video disc on this unit. This function has no relation to the subtitles specified in DivX standard specifications and has no clear standard. Depending on the methods used to create the file, the following functions may not work.

- DivX video files that do not display “Text” do not contain subtitles text.
Subtitles text cannot be displayed.

Subtitles text language settings

If the subtitles text are not displayed correctly, try changing the language settings.

After playing back a DivX video file containing subtitles text

- 1 While stopped Press [SETUP].
- 2 Press [▲, ▼] to select “Disc” and press [OK].
- 3 Press [▲, ▼] to select “DivX Subtitle Text” and press [OK].
- 4 Press [▲, ▼] to select “Latin1”, “Latin2”, or “Cyrillic” then press [OK].

To exit the screen
Press [SETUP].

Playing music CD MP3

You can play generally available music CD or MP3 files recorded onto a CD-R/RW.

1 Insert a disc. (⇒ 14)

- If a disc containing data in different file formats is inserted, the file selection menu may be displayed. Press [▲, ▼] to select "MP3 Music" and press [OK].

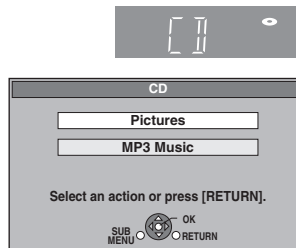

2 Press [▲, ▼] to select the track and press [OK].

Play starts on the selected track.

e.g. CD

"🎵" indicates the track currently playing.

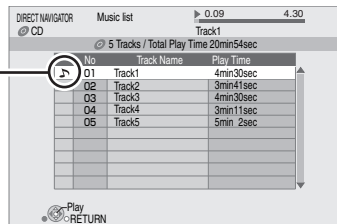

MP3 Playing a track in another folder

- While the "Music list" is displayed Press [SUB MENU], press [▲, ▼] to select "Select Folder" and press [OK].

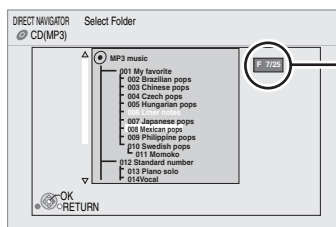

Selected folder No. /Total folders
If the folder has no track, "—" is displayed as folder number.

- Press [▲, ▼] to select a folder and press [OK]. The "Music list" for the folder appears.

Playing music continuously even after turning off power to the television

When the unit is connected to a Panasonic TV (VIERA) that supports HDAVI Control 2 or HDAVI Control 3 and an amplifier/receiver supports VIERA Link, the unit is turned off if the power to the television is turned off, since "Power off link" (⇒ 23) operates.

The following operations make it possible to keep the power of the unit ON and to play music continuously.

- While playing music Press [SUB MENU].
- Press [▲, ▼] to select "TV Power" and press [OK].



TIPS

- Discs containing data in different file formats.

To switch from the JPEG or DivX menu to MP3 menu, perform steps below.

- 1 Press [FUNCTIONS].
- 2 Press [▲, ▼] to select "Menu" and press [OK].
- 3 Press [▲, ▼] to select "MP3 Music" and press [OK].

- You can use search and skip functions. (⇒ 15)
- When the "Screen Saver Function" is set to "On" (⇒ 27), the screen switches to Screen Saver mode if there is no operation for 10 minutes after starting playback. (Playback continues.)



NOTE

- You cannot select folders that contain no compatible tracks.



TIPS

To return to the previous screen
Press [RETURN].



NOTE

- Sound may be discontinued for several seconds when the power to the television is turned off.
- If the operation mentioned left is executed while audio is output from the television, the sound may not be output from the amplifier/receiver. It is recommended to set the amplifier/receiver beforehand so that audio will be output from the amplifier/receiver.

Showing FUNCTIONS menu

Some functions of this unit can be operated from the FUNCTIONS menu.

1 Press [FUNCTIONS].

- Items to be displayed may vary with the media.

2 Press [▲, ▼] to select the item and press [OK].

- **Top Menu**
- **Menu**
- **Playback**
- **SD card**
- **BD/DVD/CD**
- **Other Functions**

Switches to the SD drive.

Switches to the disc drive.

"Playlists":

You can play playlists created on DVD-VR.

Press [▲, ▼, ◀, ▶] to select the playlist and press [OK].

"Setup" (⇒ 26)

"Card Management" (⇒ 16)

e.g.,

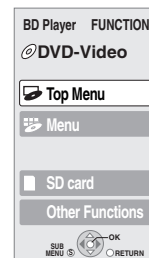

About MP3/JPEG/DivX files

File format	MP3	JPEG
Playable media	CD-R/RW*1	CD-R/RW*1, DVD-RAM*2, BD-RE*3, SD card
Extension	Files must have the extension “.mp3” or “.MP3”.	Files must have the extension “.jpg” or “.JPG”.
Picture resolution	—	between 34×34 and 5120×3840 pixels (sub sampling is 4:2:2 or 4:2:0)
Compression rate	32 kbps to 320 kbps	—
Sampling rate	44.1 kHz/48 kHz	—
Reference	ID3 tags: version 1, 2.2, 2.3, 2.4 ID3 is a tag embedded in MP3 track to provide information about the track. This unit supports the versions listed above but only titles and the names of artists can be displayed. ● If there is a large amount of still picture data etc. within a MP3 file, play may not be possible.	JPEG conforming DCF*4 is supported. Thawing Time: approx. 2 sec. (7M pixels) ● MOTION JPEG is not supported

File format	DivX	Subtitles text file of DivX
Playable media	CD-R/RW*1, DVD-R*5, DVD-R DL*5	CD-R/RW*1, DVD-R*5, DVD-R DL*5
File format	—	MicroDVD, SubRip, or TMLayer
Extension	Files must have the extension “.DIVX”, “.divx”, “.AVI” or “.avi”.	Files must have the extension “.SRT”, “.srt”, “.SUB”, “.sub”, “.TXT”, or “.txt”
Picture resolution	between 32×32 and 720×576 pixels	—
Reference	<ul style="list-style-type: none"> Plays all versions of DivX video (including DivX 6) with standard playback of DivX media files. Certified to the DivX Home Theater Profile. Video <ul style="list-style-type: none"> Number of stream: Up to 1 Codec: DIV3, DIV4, DIVX, DV50, DIV6 FPS (Frame Per Second): Up to 30 fps Audio <ul style="list-style-type: none"> Number of stream: Up to 8 Format: MP3, MPEG, AC3 Multi channel: AC3 is possible. MPEG multi is 2 ch conversion. GMC (Global Motion Compensation) is not supported. 	<ul style="list-style-type: none"> The DivX video file and subtitles text file are inside the same folder, and the file names are the same except for the file extensions. If there are more than one subtitles text files inside the same folder, they are displayed in the following order of priority: “.srt”, “.sub”, “.txt”. In the following situations, the subtitles cannot be displayed as recorded. Furthermore, depending on the methods used to create the file or the state of the recording, only parts of the subtitles may be displayed, or the subtitles may not be displayed at all. <ul style="list-style-type: none"> When special text or characters are included in the subtitles text. When the file size is larger than 256 KB. When characters with specified styling are included in the subtitle data. Codes that specify the character style within files are displayed as subtitle characters. When data with a different format exists within the subtitle data. If the file name of the DivX video file is not displayed correctly on the menu screen (the file name is displayed as “_”), the subtitles text may not be displayed correctly. Depending on the disc, the subtitles text cannot be displayed when search and other such operations are being performed.

- English alphabet and Arabic numerals are displayed correctly. Other characters may not be displayed correctly.
- The display order on this unit may differ from how the order is displayed on a computer.
- Depending on how you create the media (writing software), files and folders may not play in the order you numbered them.
- This unit is not compatible with packet-write format.
- Depending on the recording conditions, the media may not play.
- Operation may take time to complete when there are many files and/or folders and some files may not display or be playable.

*1 ISO9660 level 1 or 2 (except for extended formats), Joliet

This unit is compatible with multi-session.

This unit is not compatible with packet writing.

*2 Discs must conform to UDF 2.0.

*3 Discs must conform to UDF 2.5.

*4 Design rule for Camera File system: unified standard established by Japan Electronics and Information Technology Industries Association (JEITA).

*5 Discs must conform to UDF bridge (UDF 1.02/ISO9660).

This unit is not compatible with multi-session.

The default session only is played.

Structure of MP3, still pictures (JPEG) and DivX folders

You can play MP3, still pictures (JPEG) and DivX with this unit by making folders on disc as shown (⇒ right).

- Folder structure created on a DVD-RAM, BD-RE or an SD card is not displayed.

MP3 files and folders in CD-R/RW

Prefix with 3-digit numbers in the order you want to play them.

Still pictures (JPEG) in CD-R/RW

Files inside a folder are displayed in the order they were updated or taken.

When the highest level folders are “DCIM” folders, they are displayed first on the tree.

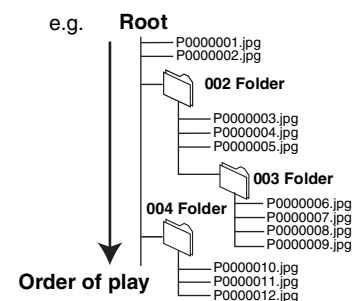

Linked operations with the TV

(VIERA Link™ “HDAVI Control™”)

What is VIERA Link “HDAVI Control”?

VIERA Link™ is a new name for EZ Sync™.

VIERA Link “HDAVI Control” is a convenient function that offers linked operations of this unit, and a Panasonic TV (VIERA) or amplifier/receiver under “HDAVI Control”.

You can use this function by connecting the equipment with an HDMI cable. See the operating instructions for connected equipment for operational details.

● VIERA Link “HDAVI Control”, based on the control functions provided by HDMI which is an industry standard known as HDMI CEC (Consumer Electronics Control), is a unique function that we have developed and added. As such, its operation with other manufacturers' equipment that supports HDMI CEC cannot be guaranteed.

● This unit supports “HDAVI Control 3” function.

“HDAVI Control 3” is the newest standard (current as of April, 2008) for Panasonic's HDAVI Control compatible equipment. This standard is compatible with Panasonic's conventional HDAVI equipment.

● Please refer to individual manuals for other manufacturers' equipment supporting VIERA Link function.

Preparation

- 1) Connect this unit to your TV or amplifier/receiver with an HDMI cable (⇒ 6–7).
- 2) Set “VIERA Link” to “On” (⇒ 28).
(The default setting is “On”.)
- 3) Set the “HDAVI Control” operations on the connected equipment (e.g., TV).
 - When using HDMI2 terminal of VIERA as “HDAVI Control”, set the input channel to HDMI2 on VIERA.
- 4) Turn on all “HDAVI Control” compatible equipment and select this unit's input channel on the connected TV so that the “HDAVI Control” function works properly.
Also when the connection or settings are changed, repeat this procedure.

What you can do with “HDAVI Control”

Automatic input switching

When the following operations are performed, the television will automatically switch the input channel and display the corresponding action.

- When play starts on the unit
- When an action that uses the display screen is performed (e.g., Direct Navigator screen)

Power on link

When the television is off and the following operations are performed, the television will automatically turn on and display the corresponding action.

- When play starts on the unit
- When an action that uses the display screen is performed (e.g., Direct Navigator screen)

Power off link

All connected equipment compatible with “HDAVI Control”, including this unit, automatically turns off when you switch the television off.

- This unit automatically turns off even during playback or any other operation.

Playing music continuously even after turning off power to the television (⇒ 21)



NOTE

- When [▶] (PLAY) is pressed on this unit for “Automatic input switching” or “Power on link”, the playback image is not immediately displayed on the screen and it may not be possible to watch the contents from where playback started.
In this case, press [◀◀] or [◀◀] to go back to where playback started.

Easy control only with VIERA remote control

If you connect this unit to a TV that has “HDAVI Control 2” or “HDAVI Control 3” function with an HDMI cable, you can operate this unit using the following buttons on the TV remote control.

[▲], [▼], [◀], [▶], [OK], [RETURN], [EXIT], [SUB MENU] and colored buttons ([EXIT]: Exit the screen)

Use the remote control for this unit to operate any other buttons (numbered buttons, etc.) that are not listed above.

● Refer to the TV operating instructions for operating TV.

Using the FUNCTIONS menu to operate this unit

By using the TV remote control, you can play media using the FUNCTIONS menu.

1 Press the button for VIERA Link on the remote control.

2 Select the player.

- The FUNCTIONS menu is displayed.



Using the sub menu to operate this unit

By using the TV remote control, you can play discs using the “Control Panel” and display the Top Menu (for BD-Video and DVD-Video) or Pop-up Menu (for BD-Video).

e.g.,

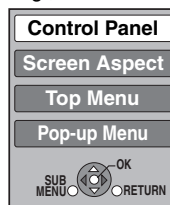

1 Press [SUB MENU].

This can also be displayed by using the VIERA menu screen.

Note You cannot use the sub menu while the Top Menu for BD-Video or DVD-Video is displayed.

2 Select an item, then press [OK].

Control Panel	Control Panel is displayed. Follow the indications on the screen.
Screen Aspect	(⇒ 15)
Top Menu	Top menu is displayed.
Menu	Menu is displayed.
Pop-up Menu	Pop-up menu is displayed.
Rotate Right	Rotate the still picture.
Rotate Left	
Zoom in	Enlarge or reduce the still picture.
Zoom out	

When you want to leave the TV on and set only this unit to standby mode

Press [BD POWER] on this unit's remote control and set to standby mode.

When not using “HDAVI Control”

Set “VIERA Link” in the Setup menu to “Off”. (⇒ 28)

Changing settings with the on-screen menu

On-screen menu operations

- 1 Press [DISPLAY].
- 2 Press [▲, ▼] to select the menu and press [▶].
- 3 Press [▲, ▼] to select the item and press [▶].
- 4 Press [▲, ▼] to select the setting.

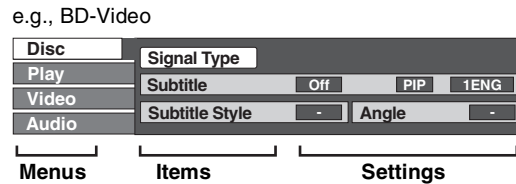

NOTE

• Depending on the condition of the unit (playing, stopped, etc.) and disc contents, there may be some items that you cannot select or change.



TIPS

• Some items can be changed by pressing [OK].

To exit the on-screen menu
Press [DISPLAY].

What you can change with the on-screen menu

Menus	Items	Settings and details
Disc	Signal Type	BD-V <ul style="list-style-type: none"> ● Primary Video Video: The video recording method appears. (⇒ below, Video recording method) Soundtrack: Select the type of audio or language. (⇒ below, Language, Audio attribute) ● Secondary Video Video: Select on/off of images. The video recording method appears. (⇒ below, Video recording method) Soundtrack: Select on/off of audio and the language. (⇒ below, Language, Audio attribute)
	Video	AVCHD The video recording method appears. (⇒ below, Video recording method)
	Soundtrack	AVCHD DVD-V Select the type of audio or language. (⇒ below, Language, Audio attribute) DVD-VR The audio attributes appear. (⇒ below, Audio attribute) DivX Select the soundtrack number. • Soundtrack numbers are displayed even when there is only one audio type.
	Subtitle	BD-V AVCHD DVD-V Turn the subtitle on/off and select the language. (⇒ below, Language) DVD-VR (Only discs that contain subtitle on/off information) Turn the subtitle on/off. DivX Turn the subtitle on/off and select the subtitle number. • Subtitle numbers are displayed even if there are not multiple subtitles.
	Subtitle Style	BD-V Select the subtitle style.
	Audio channel	DVD-VR DivX (⇒ 15, Changing audio during play)
	Angle	BD-V DVD-V Select the number of the angle.

Some items may be changed only on the disc specific menu. (⇒ 14)

Language		
ENG: English	DAN: Danish	THA: Thai
FRA: French	POR: Portuguese	POL: Polish
DEU: German	RUS: Russian	CES: Czech
ITA: Italian	JPN: Japanese	SLK: Slovak
ESP: Spanish	CHI: Chinese	HUN: Hungarian
NLD: Dutch	KOR: Korean	FIN: Finnish
SVE: Swedish	MAL: Malay	*: Others
NOR: Norwegian	VIE: Vietnamese	

Audio attribute	
LPCM/□□ Digital/□□ Digital+/ □□ TrueHD/DTS/DTS-HD	Signal type
ch (channel)	Number of channels
k (kHz)	Sampling frequency
b (bit)	Number of bits

Video recording method	
MPEG-2	This is a standard for compressing and decompressing color motion pictures efficiently. This compression method is used for DVDs, etc.
MPEG-4 AVC VC-1	These are standards for compressing and decompressing color motion pictures more efficiently than MPEG-2 and used for Blu-ray Discs, etc.

Menus	Items	Settings and details
Play	Repeat Play	<p>(Only when the elapsed time is being displayed on the unit's display.) Selects the item which you want to repeat. The items displayed differ depending on the type of disc.</p> <ul style="list-style-type: none"> ● All tracks All tracks ● Chapter Chapter ● Playlists Playlist ● Title Title ● One track Track ● Off <p>Select "Off" to cancel.</p>
	Random	<p>CD MP3</p> <p>While playing, press [▲, ▼] to select "On". Random playback starts from the next track.</p> <ul style="list-style-type: none"> ● On ● Off
Video	Picture	<p>BD-V AVCHD DVD-VR DVD-V DivX</p> <p>Select the picture quality mode during play.</p> <ul style="list-style-type: none"> ● Normal: Default setting ● Soft: Soft picture with fewer video artifacts ● Fine: Details are sharper ● Cinema: Mellows movies, enhances detail in dark scenes. ● User: You can make further adjustments. (⇒ below) <p>① Press [▶] to select "Picture Adjustment" and press [OK]. ② Select the item using [▲, ▼] and adjust it with [◀, ▶].</p> <p>Contrast: Increases the contrast between light and dark parts of the picture (-7 to +7).</p> <p>Brightness: Brightens the picture (0 to +15).</p> <p>Sharpness: Adjusts the sharpness of the edges of the horizontal lines (-6 to +6).</p> <p>Color: Adjusts the shade of the picture's color (-7 to +7).</p> <p>Gamma: Adjusts the brightness of dark portions of the screen (0 to +5).</p> <p>3D NR: Reduces the rough noise in the background to give a greater feeling of depth (0 to +4). When "24p Output" is set to "On", this function may not operate. (⇒ 28)</p> <p>Integrated NR: Smooths block noise and reduces the smudging that appears around contrasting sections of the picture (0 to +3).</p>
	Progressive	<p>Select the method of conversion for progressive output to suit the type of material being played (⇒ 40, Film and video).</p> <ul style="list-style-type: none"> ● Auto: Automatically detects the film and video content, and appropriately converts it. ● Video: Select when using "Auto", and the content is distorted.
	24p DVD-V	<p>[Only when you have selected "On" in "24p Output" (⇒ 28)]</p> <ul style="list-style-type: none"> ● On ● Off
Audio	Sound Effects*	<p>Re-master (⇒ 15)</p> <ul style="list-style-type: none"> ● Re-master 1 ● Re-master 2 ● Re-master 3 ● Off <p>V. Surround</p> <p>BD-V AVCHD DVD-VR DVD-V DivX (2 channels or more only)</p> <p>Enjoy a surround-like effect if you are using two front speakers only. – Turn V. Surround off if it causes distortion. – Do not use in combination with surround effects on other equipment. – V. Surround does not work for bilingual recordings.</p> <ul style="list-style-type: none"> ● V. Surround 1 ● V. Surround 2 ● Off
	Dialog Enhancer*	<p>BD-V AVCHD DVD-VR DVD-V (3 channels or more only, including a center channel)</p> <p>The volume of the center channel is raised to make dialog easier to hear.</p> <ul style="list-style-type: none"> ● On ● Off

* This function is effective for audio from the HDMI terminal or the DIGITAL AUDIO OUT terminal only when "Digital Audio Output" is set to "PCM". (However, in this case, audio is output as 2ch from the DIGITAL AUDIO OUT terminal.)

Changing the unit's settings

Change the unit's settings if necessary. The settings remain intact even if you switch the unit to standby.

Setup menu operations

- 1 While stopped
Press [SETUP].
- 2 Press [▲, ▼] to select the menu and press [OK].
- 3 Press [▲, ▼] to select the item and press [OK].
If there are any other items, repeat these steps.
- 4 Press [▲, ▼, ◀, ▶] to select the option and press [OK].

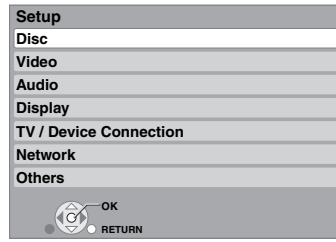

NOTE

• There may be differences in operation methods. If this happens, follow the on-screen instructions for the operation.



TIPS

To return to the previous screen
Press [RETURN].

To exit the screen
Press [SETUP].

Summary of settings

Underlined items are the factory presets.

“Disc”

DVD-Video Ratings Set a ratings level to limit DVD-Video play.	Follow the on-screen instructions. Enter a 4-digit password with the numbered buttons when the password screen is shown. It will be the common password for both “DVD-Video Ratings” and “BD-Video Ratings”. •Do not forget your password.	<ul style="list-style-type: none"> • <u>8 No Limit</u>: All DVD-Video can be played. • 1 to 7: Prohibits play of DVD-Video with corresponding ratings recorded on them. • 0 Lock All: Prohibits play of all DVD-Video.
BD-Video Ratings Set an age limit of BD-Video play.	<ul style="list-style-type: none"> • <u>No Limit</u>: All BD-Video can be played. • 0 to 254 year(s): Prohibits play of BD-Video with corresponding ratings recorded on them. 	<ul style="list-style-type: none"> • <u>Unlock Player</u> • <u>Change Level</u> • <u>Change Password</u> • <u>Temporary Unlock</u>
Audio Language	Choose the language for audio, subtitle and disc menus. BD-V DVD-V	<ul style="list-style-type: none"> • <u>English</u> • <u>French</u> • <u>Spanish</u> • <u>Original</u>: The original language of each disc will be selected. • <u>Other ****</u>
Subtitle Language	<ul style="list-style-type: none"> • Some discs start in a certain language despite any changes you make here. • When the selected language is not available on the disc, the default language is played. There are discs where you can only switch the language from the menu screen. (⇒ 14) 	<ul style="list-style-type: none"> • <u>Automatic</u>: If the language selected for “Audio Language” is not available, subtitles of that language will automatically appear if available on that disc. • <u>English</u> • <u>French</u> • <u>Spanish</u> • <u>Other ****</u>
Menu Language	<ul style="list-style-type: none"> • Enter a code (⇒ 35) with the numbered buttons when you select “Other ****”. 	<ul style="list-style-type: none"> • <u>English</u> • <u>French</u> • <u>Spanish</u> • <u>Other ****</u>
BD-Live Internet Access BD-V (⇒ 16)	You can restrict Internet access when BD-Live functions are used.	<ul style="list-style-type: none"> • <u>Allow (ALL)</u>: Internet access is permitted for all BD-Live contents. • <u>Allow (Limited)</u>: Internet access is permitted only for BD-Live contents which have content owner certificates. Internet access and AACS Online functions (⇒ 16) are prohibited for all BD-Live contents without a certificate. • <u>Prohibit</u>: Internet access is prohibited for all BD-Live contents.

“Video”

Still Mode (paused video) BD-V AVCHD DVD-V Select the type of picture shown when you pause playback (⇒ 40, Frames and fields).	<ul style="list-style-type: none"> • <u>Auto</u> • <u>Field</u>: Select if jittering occurs when “Auto” is selected. (The picture is coarser.) • <u>Frame</u>: Select if small text or fine patterns cannot be seen clearly when “Auto” is selected. (The picture is clearer and finer.)
Seamless Play DVD-VR Select the play mode between playlist chapter segments and partially deleted titles.	<ul style="list-style-type: none"> • <u>On</u>: The chapters in playlists are played seamlessly. This does not work while searching or when there are several audio types included on the playlist. Additionally, the positioning of chapter segments may change slightly. • <u>Off</u>: The points where chapters in playlists change are played accurately, but the picture may freeze for a moment.
Black Level Control Select lighter or darker for adjusting the black level control to the desired setting for picture enhancement.	<ul style="list-style-type: none"> • <u>Lighter</u>: When video is output from VIDEO OUT or S VIDEO OUT terminal. • <u>Darker</u>: When video is output from COMPONENT VIDEO OUT terminal.

“Audio”

Dynamic Range Compression BD-V AVCHD DVD-V DivX (Dolby Digital, Dolby Digital Plus and Dolby TrueHD only) Change the dynamic range (⇒ 40) for late night viewing.	<ul style="list-style-type: none"> ● On ● Off ● Auto: Effective only when Dolby TrueHD is played.
Digital Audio Output ● Press [OK] to show the following settings.	
Audio Priority Preset ● Select priority items for “Digital Audio Output”.	<ul style="list-style-type: none"> ● Secondary: “BD-Video Secondary Audio” is set to “On”, and “Digital Audio Output” is fixed to “PCM”. ● Quality: “Digital Audio Output” is set to “Bitstream”, and “BD-Video Secondary Audio” is fixed to “Off”. – If the connected equipment can only decode Dolby Digital or DTS, Dolby Digital Plus, Dolby TrueHD, and DTS-HD will be output as Dolby Digital or DTS. – If the connected equipment can only decode one of either Dolby Digital or DTS, please select “Custom” and set desire audio formats that cannot be decoded. ● Custom: Items in “Digital Audio Output” can be set individually. (⇒ 17)
Dolby D/Dolby D +/ Dolby TrueHD DTS/DTS-HD	Select whether Dolby Digital, Dolby Digital Plus, Dolby TrueHD, DTS Digital Surround, DTS-HD High Resolution Audio or DTS-HD Master Audio is output in “Bitstream” or “PCM” format. Note <ul style="list-style-type: none"> ● Not making the proper settings may result in noise. ● If the unit is connected with the HDMI AV OUT terminal, the specifications of the connected equipment take preference over this unit and audio selected in these items may not be output (e.g., when a television is connected, the HDMI audio output of this unit is limited to down-mixed 2ch.)
BD-Video Secondary Audio BD-V Turn on/off the clicking sound on the menu and audio with secondary video in picture-in-picture mode. (⇒ 16)	<ul style="list-style-type: none"> ● On: The primary audio and secondary audio are mixed and output. The sampling frequency is converted to 48 kHz. ● Off: The clicking sound on the menu and secondary audio are not output.
PCM Down Conversion Select how to output audio with a sampling frequency of 96 kHz. ● Signals are converted to 48 kHz despite the settings across in the following cases: – when the signals have a sampling frequency of over 96 kHz – when the disc has copy protection – when “BD-Video Secondary Audio” is set to “On”	<ul style="list-style-type: none"> ● On: Signals are converted to 48 kHz. (Choose when the connected equipment cannot process signals with sampling frequency of 96 kHz.) ● Off: Signals are output as 96 kHz. (Choose when the connected equipment can process signals with sampling frequency of 96 kHz.)
Downmix Switch the downmix system for playing back multi-channel surround sound. ● When “Digital Audio Output” is set to “Bitstream”, there are no downmix effects for the outputted audio. ● The audio will be outputted in “Stereo” in the following cases. – AVCHD playback – Playback of clicking sound on the menu and audio with secondary video in picture-in-picture mode	<ul style="list-style-type: none"> ● Stereo: When connected to equipment that does not support the virtual surround function. ● Surround encoded: When connected to equipment that supports the virtual surround function (Dolby Pro Logic, DTS Neo: 6, etc.)

“Display”

Status Messages Choose whether to show status messages automatically.	<ul style="list-style-type: none"> ● Automatic ● Off
On-screen Language Choose the language for these menus and on-screen messages.	<ul style="list-style-type: none"> ● English ● Français ● Español
Screen Saver Function This is to prevent burn-in on the screen. ● When this is set to “On”, the masked-off area on the screen becomes gray. [Only when connecting with an HDMI cable or a component video cable and “HDMI Resolution” (⇒ 28) is set to any other mode than “480p”, or “Component Video Resolution” (⇒ 28) is set to “720p” or “1080i”]	<ul style="list-style-type: none"> ● On: If there is no operation for 10 minutes or more, the displayed screen switches to the other states automatically. – When the Direct Navigator or FUNCTIONS menu is displayed, the display returns to the screen saver mode. – When CD or MP3 is played, the display returns to the screen saver mode. (Playback continues.) – When still pictures are shown (except for slideshows), the display returns to the Direct Navigator screen. ● Off
FL Display Changes the brightness of the unit’s display.	<ul style="list-style-type: none"> ● Bright ● Dim: The display is dimmed. ● Auto: The display is dimmed during playback and bright except playback.
SD Card LED Control Set the lighting method for the lamp on the SD card slot.	<ul style="list-style-type: none"> ● On ● SD inserted: When this unit is turned on and SD card is inserted, the lamp is lighted. ● Off
License	Information about the software used by this unit is displayed.

“TV/Device Connection”

TV Aspect Set to match the type of television connected.	When connected to a 4:3 aspect television: ● 4:3 Pan & Scan: Video recorded for a widescreen is played as Pan & Scan (unless prohibited by the producer of the disc). When playing BD-Video, video is output as “4:3 Letterbox”. ● 4:3 Letterbox: Video recorded for a widescreen is played in the letterbox style. When connected to a 16:9 widescreen television: ● 16:9: Video recorded for 4:3 aspect screen is displayed as a 4:3 ratio image in the center of the screen. ● 16:9 Full: Video recorded for 4:3 aspect screen is displayed as a horizontally stretched 16:9 image.
HDMI Connection ● Press [OK] to show the following settings.	
HDMI Video Mode Select “On” when video is output from HDMI AV OUT terminal.	● On: Images are output from the HDMI terminal in the resolution set in “HDMI Resolution”. Video from COMPONENT VIDEO OUT terminal is output as “480i”. ● Off: Images are output in the resolution set in “Component Video Resolution”.
HDMI Resolution The items supported by the connected devices are indicated on the screen as “*”. When any item without “*” is selected, the images may be distorted.	● Auto: Automatically selects the output resolution best suited to the connected television (1080p, 1080i, 720p or 480p). ● 480p ● 1080i ● 720p ● 1080p –When the unit is connected to an amplifier/receiver that does not support the resolution set on the unit, the video cannot be output properly. In this case, use the HDMI cable to connect the unit to the TV and then connect the unit to the amplifier/receiver using a cable other than HDMI. –To enjoy high definition video up-converted to 1080p, you need to connect the unit directly to 1080p compatible HDTV (High Definition Television). If this unit is connected to an HDTV through other equipment, it must also be 1080p compatible.
24p Output BD-V DVD-V When this unit is connected to a TV supporting 1080/24p output via an HDMI cable, this unit displays each frame at 1/24 second intervals – the same interval originally shot with the film camera. ● When playing DVD-Video, set to “On” and then set “24p” in “Video” (⇒ 25) to “On”	● On: Images in 24p are output in 24p as they are. However, –when video is being output at 24 frames, images from any other terminal than the HDMI terminal may not be output properly. – BD-V : when images other than 24p are played, images are output at 60p. ● Off
HDMI RGB Output Range Effective when connected to a device that only supports RGB output.	● Standard: The video is output as it is. ● Enhanced: When the black and white contrast of a video is low, the signal is enhanced to reproduce clear video.
HDMI Audio Output This setting selects whether or not to output audio from HDMI.	● On: ● Off: When the TV is connected to this unit using an HDMI cable, and this unit is also connected to other devices, such as an amplifier/receiver using an optical digital audio cable or a coaxial cable.
VIERA Link Set to use “HDAVI Control” function when connected with an HDMI cable to a device that supports “HDAVI Control”.	● On: ● Off: Select when you do not want to use “HDAVI Control”.
Component Video Resolution This sets the video output resolution when using the component video terminal.	● 480i ● 480p ● 720p ● 1080i Even if you select “720p” or “1080i”, the video output resolution is restricted to “480p” when images of DVD-Video discs are output from the COMPONENT VIDEO OUT terminals.
Speaker You can set the unit to output the best possible sound for your speakers.	● Multi Channel: When using 3 or more speakers. (⇒ 29) ● 2 Channel: When using two speakers. 2ch down-mix audio are output from Front L and Front R.

“Network”

IP Address/DNS Settings (⇒ 12) ● Press [OK] to show the following settings.	
Connection Test	_ _ _ _ _
IP Address Auto Configuration (DHCP)	● On ● Off
IP Address	_ _ _ . _ _ _ . _ _ _ . _ _ _
Subnet Mask	_ _ _ . _ _ _ . _ _ _ . _ _ _
Default Gateway	_ _ _ . _ _ _ . _ _ _ . _ _ _
DNS Auto Configuration (DHCP)	● On ● Off
Primary DNS	_ _ _ . _ _ _ . _ _ _ . _ _ _
Secondary DNS	_ _ _ . _ _ _ . _ _ _ . _ _ _
Auto Detect Connection Speed	● On ● Off
Connection Speed Setting This is enabled only when “Auto Detect Connection Speed” is turned “Off”.	● 10BASE Half Duplex ● 10BASE Full Duplex ● 100BASE Half Duplex ● 100BASE Full Duplex
Proxy Server Settings (⇒ 13) ● Press [OK] to show the following settings.	
Reset to factory preset	
Proxy Address	(The initial setting is blank.)
Proxy Port Number	(The initial setting is “0”.)

“Others”

Off Timer Select how long the unit remains on when it is not being used.	● 2 Hours ● 6 Hours ● Off
Remote Control Code (⇒ 33)	● Set Code 1 ● Set Code 2 ● Set Code 3
Easy Setting You can execute basic settings (On-screen Language, TV Aspect).	● Yes ● No
Restore Default Settings This returns all values in the Setup menu and the on-screen menu, except for “Remote Control Code”, “On-screen Language”, “IP Address/DNS Settings”, “Proxy Server Settings”, “DVD-Video Ratings” and “BD-Video Ratings” to the default settings.	● Yes ● No
DivX Registration (⇒ 20) You need this registration code to purchase and play DivX Video-on-Demand (VOD) content.	
Firmware Update (⇒ 9) ● Press [OK] to show the following settings.	
Automatic Update When this equipment remains connected to the Internet, it will check for the latest firmware version when it is turned on and you can update it if necessary.	● On ● Off
Update Now	You can update the firmware manually.

Changing the speaker setting to suit your speakers

When connecting to an amplifier/receiver to enjoy multi-channel surround sound, use the following settings on this unit if they cannot be set on the amplifier/receiver.

The settings are not effective when outputting bitstream signals.

Preparation

Set “Speaker” to “Multi Channel”. (⇒ 28)

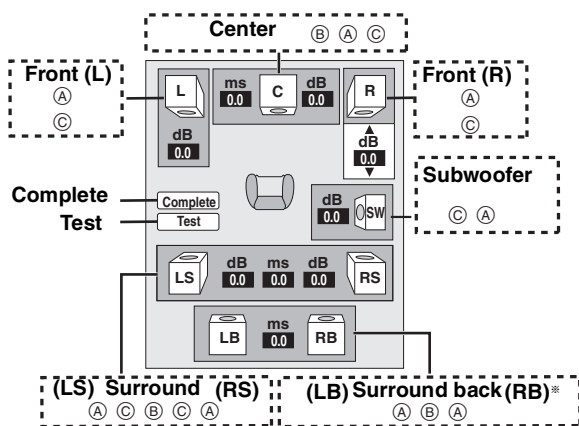

* Surround back channel is enabled only when the unit is connected to an amplifier/receiver supporting HDMI 7.1 channel audio.

BD-V: If the original audio is 5.1ch DTS-HD or DTS, the remapping function is activated to divide it to 7.1ch.

Speaker presence and size (A)

- Press [▲, ▼, ◀, ▶] to select the speaker icon (A) and press [OK].
- Press [▲, ▼] to select the setting and press [OK].

Icon examples:

- Surround speaker (LS)
- **Large:** Select when the speaker supports low-frequency (under 100 Hz) reproduction.
 - **Small:** Select when the speaker does not support low-frequency reproduction.

In order to make an ideal listening environment, settings of speaker sizes may be automatically adjusted.

For example, if the subwoofer is set to “No”, the front speakers will automatically be set to “Large”. (In this case, we recommend connecting a speaker that can reproduce bass below 100 Hz.)

Delay time (B)

For optimum listening with 7.1/5.1-channel sound, all the speakers, except for the subwoofer, should be the same distance from the seating position.

If you have to place the center, surround and surround back speakers closer to the seating position, adjust the delay time to make up for the difference.

If either distance (D) or (F) is less than (E), find the difference in the relevant table and change to the recommended setting.

- Press [▲, ▼, ◀, ▶] to select the delay time box (B) and press [OK].
- Press [▲, ▼] to select the setting and press [OK].

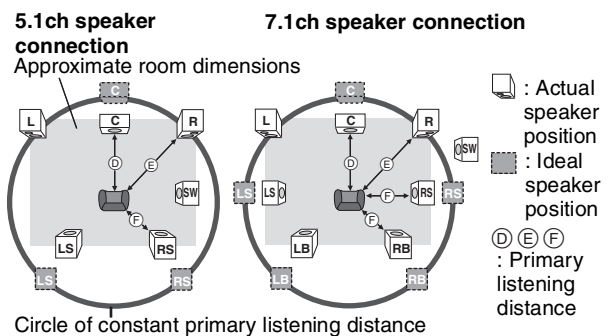

(D) Center speaker

Difference	Setting
Approx. 34 cm (1 ft. 1 in.)	1.0 ms
Approx. 68 cm (2 ft. 2 in.)	2.0 ms
Approx. 102 cm (3 ft. 4 in.)	3.0 ms
Approx. 136 cm (4 ft. 5 in.)	4.0 ms
Approx. 170 cm (5 ft. 6 in.)	5.0 ms

(F) Surround/Surround back speakers

Difference	Setting
Approx. 170 cm (5 ft. 6 in.)	5.0 ms
Approx. 340 cm (11 ft. 1 in.)	10.0 ms
Approx. 510 cm (16 ft. 8 in.)	15.0 ms

Channel balance (C)

This does not work when connected with the HDMI terminal and “HDMI Audio Output” (⇒ 28) is set to “On”.

- Select “Test” and press [OK].

A test signal is output.

Front (L) → Center → Front (R) → Surround (RS)

↑ Surround (LS) ← Surround Back (LB)* ← Surround Back (RB)*

*Test signal is output only when the unit is connected using HDMI AV OUT terminal.

- While listening to the test signal, press [▲, ▼] to adjust the volume of each speaker
Front speakers: 0.0 to -6.0 dB
Center and surround speakers: 0.0 to -12.0 dB
● You cannot adjust the volume of surround back speakers.
- Press [OK].
The test signal stops.
● No signal is output for the subwoofer. To adjust its volume, play something, then return to this screen to adjust to suit your taste.
- Press [OK].

Frequently asked questions

Setup		Page
What do I need to play multi channel surround sound?	<ul style="list-style-type: none"> Connect the appropriate amplifier/receiver to the HDMI terminal, the DIGITAL AUDIO OUT terminal (OPTICAL, COAXIAL), or the 5.1ch AUDIO OUT terminal on this unit. 	7, 8
How do I set this unit to play 7.1ch surround sound?	<ul style="list-style-type: none"> After connecting this unit to an amplifier/receiver supporting HDMI Ver. 1.3 and compatible with Dolby Digital Plus, Dolby TrueHD, DTS-HD and 7.1ch LPCM using a High Speed HDMI cable, set the items in the Setup menu as follows. <ul style="list-style-type: none"> –“Audio Priority Preset”: “Quality” –“Speaker”: “Multi Channel” 	27, 28
Can headphones and speakers be directly connected to this unit?	<ul style="list-style-type: none"> You cannot directly connect them to this unit. Connect through the amplifier/receiver, etc. 	7, 8
My television has S VIDEO IN terminal, COMPONENT VIDEO IN terminals and HDMI IN terminal. Which should I connect with?	<ul style="list-style-type: none"> The different levels of picture quality input are listed below in order from highest to lowest. HDMI IN→COMPONENT VIDEO IN→S VIDEO IN→VIDEO IN. However, it will take longer for the picture output to start up when this unit is connected with the HDMI IN terminal. 	—

Disc		
Can I play BD-Video and DVD-Video bought in another country?	<ul style="list-style-type: none"> You can play them if the video standard is NTSC, however, you cannot play: <ul style="list-style-type: none"> –BD-Video discs that do not include your region code. –DVD-Video discs that do not include your region number or “ALL”. Refer to the cover of these operating instructions for more information about your region code and number. Refer to the disc's jacket for more information. 	Cover
Can BD-Video/DVD-Video that does not have a region code/number be played?	<ul style="list-style-type: none"> The region management information for BD-Video/DVD-Video indicates that the disc conforms to industry standards. You cannot play discs that do not conform to industry standards or do not have a region code or number. 	—
Please tell me about disc compatibility with this unit.	<ul style="list-style-type: none"> Refer to “Disc and card information” and “About MP3/JPEG/DivX files”. You cannot write to a disc with this unit. 	4, 22 —

SD card		
What kinds of operations are available on the SD card slot on this unit?	<ul style="list-style-type: none"> The following operations are available. <ul style="list-style-type: none"> –Playback JPEG data recorded with a digital camera etc. –Playback AVCHD motion pictures recorded with Panasonic High Definition Video Camera If a BD-Video disc supporting BD-Live or BONUSVIEW is used, it is possible to copy secondary video, etc. from the Internet or disc to the card and play it back together with the images on the disc, etc. 	— — 16
What kinds of cards can be used?	<ul style="list-style-type: none"> SD Memory Cards (from 8 MB to 2 GB), SDHC Memory Cards (from 4 GB to 32 GB), miniSD Cards*, and microSD Cards* can be used. * A miniSD Card and a microSD Card must be used in the adaptor included with the memory card. Please confirm the latest information on the following website. http://panasonic.co.jp/pavc/global/cs (This site is in English only.) BD-V To play the virtual package, it is recommended that you use a card that supports SD Speed Class Rating Class 2 and has 1 GB or more free space. 	5 —

Troubleshooting guide

Before requesting service, make the following checks. If you are in doubt about some of the check points, or if the solutions indicated in the chart do not solve the problem, refer to “Customer Services Directory” on page 37 if you reside in the U.S.A., or refer to “Product information” on page 38 if you reside in Canada.

The following do not indicate a problem with this unit:

- Regular disc rotating sounds.
- Image disturbance during search.

To reset this unit		Page
To restore the unit if it freezes due to one of the safety devices being activated	<ul style="list-style-type: none"> Press and hold [POWER \odot/I] on the main unit for 3 seconds. (The settings remain unchanged.) 	—
To return all settings other than some settings to the factory preset	<ul style="list-style-type: none"> Select “Yes” in “Restore Default Settings” in the Setup menu. This returns all values in the Setup menu and the on-screen menu, except for “Remote Control Code”, “On-screen Language”, “IP Address/DNS Settings”, “Proxy Server Settings”, “DVD-Video Ratings” and “BD-Video Ratings” to the default settings. 	29
To return to the factory preset (No setting)	<ul style="list-style-type: none"> Reset the unit as follows: <ol style="list-style-type: none"> Press [POWER \odot/I] on the unit to turn off the unit. Press and hold [▶▶/▶▶], [▲ OPEN/CLOSE] and [■] on the unit at the same time for more than 5 seconds until “HELLO” is displayed on the unit. The power is turned on and then turned off automatically. 	—

Power		Page
No power.	● Insert the AC power supply cord securely into a known active AC outlet.	8
The unit switches to standby mode.	● This is a power saving feature. It can be changed if desired using “Off Timer” in the Setup menu. ● One of the unit’s safety devices is activated. Press [POWER ⏻/I] on the main unit to turn the unit on.	29 —

Operation

Cannot operate the television or amplifier/receiver.	● Change the manufacturer code. Some televisions or amplifier/receiver cannot be operated even if you change the code.	11
	● It may be necessary to set the manufacturer code again after changing the batteries.	11
The remote control doesn't work properly.	● The remote control and main unit are using different codes. Change the code on the remote control. Press and hold [OK] and the indicated number button at the same time for more than 5 seconds.	33
	● The batteries are depleted. Replace them with new ones.	5
	● You are not pointing the remote control at the main unit's remote control signal sensor during operation.	5
	● Colored glass may obstruct the signal reception/transmission.	—
	● Don't place the signal sensor in direct sunlight or in areas that may be subject to sunlight exposure. ● It may be necessary to set the code on the remote control again after changing the batteries.	— 11, 33
The unit is on but cannot be operated.	● Confirm the correct drive is selected.	14
	● Some operations may be prohibited by the disc.	—
	● The unit is hot (“U59” appears on the display). Wait for “U59” to disappear.	34
	● One of the unit's safety devices may have been activated. Reset the unit as follows: 1 Press [POWER ⏻/I] on the main unit to switch the unit to standby. If the unit doesn't switch to standby, press and hold [POWER ⏻/I] on the main unit for about 3 seconds. The unit is forcibly switched to standby. Alternatively, disconnect the AC power supply cord, wait one minute, then reconnect it. 2 Press [POWER ⏻/I] on the main unit to switch it on. If the unit still cannot be operated, consult the dealer.	—
Play fails to start even when [▶] (PLAY) is pressed. Play starts but then stops immediately.	● Insert the disc correctly with the label facing up.	14
	● The disc is dirty. ● You tried to play a blank disc or unplayable disc on this unit. ● DivX If playing DivX VOD content, refer to the homepage where you purchased it.	36 4, 5 20
Cannot eject disc.	● The unit may have a problem. While the unit is off, press and hold [■] and [▶▶/▶▶] on the main unit at the same time for about 5 seconds. Remove the disc and consult the dealer.	—
Startup is slow. When the unit is turned on, audio and video output takes a long time. It takes time before play starts.	● Startup takes time in the following situations. – Immediately after a power failure or the AC power supply cord is connected. – When the unit is connected with an HDMI cable.	—
	● DivX This is normal on DivX video.	—
Cannot set “On” in “24p Output”.	● Only when the unit is connected to the HDMI terminal of a TV supporting 24p you can select “On”. In some cases where the unit is connected to a TV via an amplifier/receiver through the HDMI terminals, you may not be able to select “On”. In this case, connect the unit to a TV through the HDMI terminal and connect it to the amplifier/receiver through any terminal other than HDMI.	28

Displays

The display is dim.	● Change “FL Display” in the Setup menu.	27
The elapsed time displayed is actually less than the play time.	● The displayed play time is converted from the number of frames at 29.97 frames (equal to 0.999 seconds) to one second. There will be a slight difference between the time displayed and the actual elapsed time (e.g., actual one-hour elapsed time may display as approximately 59 minutes 56 seconds).	—

TV screen and video

The images from this unit do not appear on the television.	● Make sure that the television is connected to the VIDEO OUT terminal, S VIDEO OUT terminal, COMPONENT VIDEO OUT terminals or HDMI AV OUT terminal on this unit.	6, 7
	● Make sure that the television's input setting (e.g., VIDEO 1) is correct.	—
Picture is distorted.	● An incorrect resolution is selected in “Component Video Resolution”, when the television is connected to COMPONENT VIDEO OUT terminals. While stopped, press and hold [■] and [▶] (PLAY) on the main unit at the same time for more than 5 seconds to cancel this setting. Set the item again.	28
	● If “24p Output” is set to “On” when the unit is connected to a TV through any terminal other than HDMI, images may not display properly. In this case, set “24p Output” to “Off”.	28
	● DivX Images may not be output due to how files were created.	—
Picture stops.	● DivX Picture may stop if the DivX files are greater than 2 GB.	—
The screen changes automatically.	● When the “Screen Saver Function” in the Setup menu is set to “On”, the display may return to the screen saver mode automatically if there is no operation for 10 minutes or more.	27
Video is not output in high definition.	● High definition video cannot be output through the VIDEO OUT or S VIDEO OUT terminals.	—
	● Confirm that the “HDMI Video Mode”, “HDMI Resolution”, and “Component Video Resolution” in the Setup menu are set properly.	28
	● The video output resolution is restricted to “480p” when DVD-Video is output from the COMPONENT VIDEO OUT terminals.	—
Status messages do not appear.	● Select “Automatic” in “Status Messages” in the Setup menu.	27

(Continued on the next page)

The 4:3 aspect ratio picture expands left and right. Screen size is wrong.	<ul style="list-style-type: none"> Use the television to change the aspect. Refer to your television's operating instructions. When using a component video cable, set "Progressive" to "Video". If the situation is not restored after that, set "TV Aspect" to "4:3 Pan & Scan". 	— 25, 28
There is a lot of after-image when playing video.	<ul style="list-style-type: none"> Turn "3D NR" or "Integrated NR" off if it is on. 	25
There is no apparent change in picture quality when adjusted with the "Video" menu in the on-screen menu.	<ul style="list-style-type: none"> The effect is less perceivable with some types of video. 	—
The masked-off area is masked in gray.	<ul style="list-style-type: none"> If the "Screen Saver Function" in the Setup menu is set to "Off", the masked-off area is displayed in black. 	27

Sound

No sound. Low volume. Distorted sound. Cannot hear the desired audio type.	<ul style="list-style-type: none"> Check the connections and the "Digital Audio Output" settings. Check the input mode on the amplifier/receiver if you have connected one. Press [AUDIO] to select the audio. Turn off "V. Surround" in the following cases. <ul style="list-style-type: none"> When using discs that do not have surround sound effects such as Karaoke discs. When playing bilingual broadcast programs. Match the speaker settings with the connected equipment. Change multi channel speaker settings by selecting "Multi Channel" in "Speaker". The sound effects (Re-master, V. Surround, etc.) will not work when the bitstream signal is output from the HDMI AV OUT terminal or the DIGITAL AUDIO OUT terminal. When "BD-Video Secondary Audio" is set to "Off", Dolby Digital Plus, Dolby TrueHD and DTS-HD are output from the DIGITAL AUDIO OUT terminal as Dolby Digital or DTS Digital Surround bitstream. DivX Audio may not be output depending on how files were created. 	6-7, 27 15 25 28 — 17, 27 —
Cannot switch audio.	<ul style="list-style-type: none"> There are discs for which audio cannot be changed because of how the disc was created. When connecting an amplifier/receiver using a coaxial cable, optical digital audio cable or an HDMI cable, you cannot switch the audio if "Digital Audio Output" is set to "Bitstream". Set "Digital Audio Output" to "PCM" or connect using audio cables. 	— 7, 8, 27

HDMI connections

The images from this unit do not appear on the television.	<ul style="list-style-type: none"> Press [■] and [▶] (PLAY) simultaneously on the unit for more than 5 seconds to shift to more compatible mode with HDMI equipment. However, Dolby Digital Plus, Dolby TrueHD, and DTS-HD audio are not output in bitstream. To output the bitstream, select "Restore Default Settings" to restore the factory presets and make proper settings. 	29
Picture is distorted.	<ul style="list-style-type: none"> To output video from a device connected with an HDMI cable, set "HDMI Video Mode" to "On" in the Setup menu. 	28
Jittering occurs.	<ul style="list-style-type: none"> Picture may not be seen when more than 4 devices are connected with HDMI cables. Reduce the number of connected devices. When "24p Output" is set to "On", HDMI authentication takes place where 24p images switch to other images, and a black screen is displayed. When "24p Output" is set to "On", jittering may occur while playing DVD-Video. In this case, turn "24p Output" to "Off". 	— 28 28
The 4:3 aspect ratio picture expands left and right. Screen size is wrong.	<ul style="list-style-type: none"> Change "TV Aspect" type to "16:9". 	28
When playing DVD-Video using progressive output, one part of the picture momentarily appears to be doubled up.	<ul style="list-style-type: none"> When you use the HDMI AV OUT terminal for video output, follow the steps below for setting. <ol style="list-style-type: none"> Connect this unit to the TV with any cable except the HDMI cable. When you connect with the Component Video cable, set "HDMI Video Mode" to "Off" and "Component Video Resolution" to "480i" in the Setup menu. 	28
No sound. Low volume. Distorted sound. Cannot hear the desired audio type.	<ul style="list-style-type: none"> Audio may not be heard when more than 4 devices are connected with HDMI cables. Reduce the number of connected devices. The sound effects will not work when the bitstream signal is output from the HDMI AV OUT terminal or the DIGITAL AUDIO OUT terminal. To output audio from a device connected with an HDMI cable, set "HDMI Audio Output" to "On" in the Setup menu. If the sound is distorted when the unit is connected to an amplifier/receiver with an HDMI cable, adjust the settings in "Speaker" in the Setup menu to match the connection. Depending on the connected equipment, the sound may be distorted if this unit is connected with an HDMI cable. When "BD-Video Secondary Audio" is set to "On", Dolby Digital Plus, Dolby TrueHD, and DTS-HD are converted to 48 kHz Dolby Digital and output. LPCM 7.1 channel audio is converted to 5.1 channel audio. In this case, set the "BD-Video Secondary Audio" to "Off". 	— — 28 28 — 27

The capacity of the SD card decreased.	<ul style="list-style-type: none"> When a BD-Video that supports the virtual package is used, and an SD card is in the slot, data may be written to the SD card. Erase the data by using "BD-Video Data Erase", format the card or use a new card. 	16
MPEG-2 motion pictures and music on an SD card cannot be played.	<ul style="list-style-type: none"> Data that can be played from an SD card are AVCHD and JPEG data. 	5
The contents of the card cannot be read.	<ul style="list-style-type: none"> The card is not compatible or the contents on the card may be damaged. Turn off and then turn on the unit again. 	5 —

Network

I can't connect to the network.	<ul style="list-style-type: none"> Has the LAN cable come unplugged? Check that the LAN cable is properly connected. 	9
	<ul style="list-style-type: none"> Have you plugged in a modular cable for use with a telephone into the LAN terminal on this unit? Connect with a straight LAN cable. 	9
	<ul style="list-style-type: none"> Is the power for the modem or broadband router turned on? Turn the power on for each device. 	—
	<ul style="list-style-type: none"> Is there a mistake in the network settings? Follow any instructions you may have received from your ISP (Internet Service Provider) and make changes to the settings. 	—
	<ul style="list-style-type: none"> Are the broadband router settings correct? Read the operating instructions for the broadband router. 	—
	<ul style="list-style-type: none"> Is the broadband router and/or modem correctly connected? Check the operating instructions for each device and connect accordingly. 	—
	<ul style="list-style-type: none"> Check the "Network" and "BD-Live Internet Access" settings. 	26, 28
While using my PC, I cannot connect to the network.	<ul style="list-style-type: none"> Does your Internet Service Provider (ISP) or service contract prevent multiple terminals connecting at the same time? Check the content of your contract. 	—

Other difficulties with playback

Audio and video momentarily pause.	<ul style="list-style-type: none"> This occurs between playlist chapters or scenes (AVCHD). When playing a title recorded on both layers, the unit automatically switches between layers and plays the title in the same way as a normal program. However, video and audio may momentarily cut out when the unit is switching layers. 	— —
BD-Video or DVD-Video is not played.	<ul style="list-style-type: none"> Ensure the disc is for the correct BD-Video region code or DVD-Video region number, and is not defective. You have set a ratings level to limit BD-Video or DVD-Video play. Change this setting. Some BD-Video can only be output with HDMI. 	Cover 26 —
Picture-in-picture is not played with BD-Video.	<ul style="list-style-type: none"> Confirm whether the disc supports picture-in-picture. 	—
The virtual package is not played with BD-Video.	<ul style="list-style-type: none"> Confirm whether the disc supports the virtual package. The inserted SD card does not have sufficient available capacity. The SD card is write-protected. Sub contents copied to an SD card are provided by the disc producer as a part of the BD-Video content. Even if you record images and audio onto an SD card, it cannot be played as a virtual package. 	16 — 5 16
Alternative soundtrack and subtitles cannot be selected.	<ul style="list-style-type: none"> The languages are not recorded on the disc. You may not be able to use the on-screen menu to change the soundtrack and subtitles on some discs. Use the disc's menus to make changes. 	— 14
No subtitles.	<ul style="list-style-type: none"> Subtitles are not recorded on the disc. Turn the subtitles on. Set "Subtitle" on the on-screen menu to "On". When progressive output is on, closed captions cannot be displayed. 	— 24 —
The subtitles overlap closed captions recorded on discs.	<ul style="list-style-type: none"> Turn off the subtitles or turn off the closed caption setting on the TV. 	24
Angle cannot be changed.	<ul style="list-style-type: none"> Angles can only be changed during scenes where different angles are recorded. 	—
The resume play function does not work.	<ul style="list-style-type: none"> Memorized positions are canceled when <ul style="list-style-type: none"> pressing [■] several times. opening the disc tray. The resume play function may not work depending on the disc. BD-V: On BD-Video discs including BD-J, the resume play function does not work. 	— — —

When other Panasonic products respond to this remote control

Change the remote control code on the main unit and the remote control (the two must match) if you place other Panasonic products close together.

- Press [SETUP].
- Press [▲, ▼] to select "Others" and press [OK].
- Press [▲, ▼] to select "Remote Control Code" and press [OK].
- Press [▲, ▼] to select the code (1, 2, or 3) and press [OK].
- To change the code on the remote control
While pressing [OK], press and hold the numbered button ([1], [2] or [3]) for more than 5 seconds.
- Press [OK].

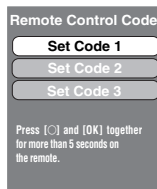

NOTE

When the following indicator appears on the unit's display and you are unable to operate the unit



The unit's remote control code
Press and hold [OK] and the indicated number button at the same time for more than 5 seconds.

Messages

The following messages or service numbers appear on the television or unit's display when something unusual is detected during startup and use.

On the television		Page
Authorization Error This unit is not authorized to play this title.	● You are trying to play the DivX VOD content that was purchased with a different registration code. You cannot play the content on this unit.	20
Cannot play.	● You inserted an incompatible disc (Discs recorded in PAL video, etc.).	4, 5
Cannot display on this unit.	● You tried to play a non-compatible image. ● Confirm "SD" on the unit's display is not blinking and re-insert the card.	5, 22 —
No disc is inserted.	● The disc may be upside down.	—
Rental Expired.	● The DivX VOD content has zero remaining plays. You cannot play it.	20
⊘ This operation is currently disabled.	● The operation is prohibited by the unit or disc.	—
Cannot connect. Please check the connection of the LAN cable.	● When a hub is used but its Link lamp does not light up, check the cable connection, LAN terminal connection, cable itself (a cross cable may be used by mistake), etc.	9
IP address is not set.	● The "IP Address" in "IP Address/DNS Settings" is "----, ---, ---, ---". Set the "IP Address", "Subnet Mask", and "Default Gateway". (Select the automatic address acquisition if necessary.)	12
Cannot obtain IP address using DHCP. Please check the connection or router settings.	● If you use a hub, then check the connection between the hub and the router. – Use the UPLINK port of the hub to connect to a router. – Check whether or not the hub's Link lamp lights up. If it does not light up, then check the cable connection, LAN terminal connection, cable itself (a cross cable may be used by mistake), etc. ● If the above conditions are OK, then the router may not operate in DHCP mode. Check the router settings and operation. You may reset the router to restore it to normal.	9
This IP address is already in use. Please check the IP address setting.	● This unit's IP address is used by another device. Check the IP addresses of this unit, personal computers, and routers, etc. If necessary, reconfigure them to avoid IP addresses from being duplicated.	—
Unable to perform Connection Test. Please try again.	● Turn the unit off. Remove the power cord and reconnect it and try again. If the same symptom persists, then consult your dealer.	—
IP address not set correctly.		
Connection Test was unsuccessful. No reply from host. Please check the connection or router settings.	● If you use a hub, then check the connection between the hub and the router. – Use the UPLINK port of the hub to connect to a router. – If the hub's Link lamp does not light up, then check the cable connection, LAN terminal connection, cable itself (a cross cable may be used by mistake), etc. ● Check the "IP Address", "Subnet Mask", and "Default Gateway" in the "IP Address/DNS Settings". ● If the MAC address information is required, then press [SETUP] to display the "Network" menu.	9 12 12
Network connection refused. Please confirm Setup "BD-Live Internet Access"	● When you set "BD-Live Internet Access" to "Allow (Limited)" and play BD-Live contents which do not have a content owner certificate, the Internet access of the content is not allowed. If you allow the content to connect to Internet, set "BD-Live Internet Access" to "Allow (ALL)".	26

On the unit's display

F99	● The unit fails to operate properly. Press [POWER ⏻/I] on the main unit to switch the unit to standby for 3 seconds. Now press [POWER ⏻/I] on the main unit again to turn the unit on.	—
HDMI ONLY	● Some BD-Video discs can only be output with HDMI.	—
No PLAY	● There is a viewing restriction on a BD-Video or DVD-Video.	26
No READ	● The disc is dirty or badly scratched. The unit cannot play.	—
PLEASE WAIT	● Displayed when the unit is started and turned off. This is not a malfunction. ● The unit is carrying out its recovery process. You cannot operate the unit while "PLEASE WAIT" is displayed.	— —
SET □ ("□" stands for a number.)	● The remote control and main unit are using different codes. Change the code on the remote control.  Press and hold [OK] and the indicated number button at the same time for more than 5 seconds.	33
UNFORMAT	● You inserted an unformatted DVD-RAM, DVD-RW, +RW, an unused +R, +R DL or DVD-RW (DVD-Video format).	—
UNSUPPORT	● You have inserted a disc the unit cannot play.	4, 5
U59	● The unit is hot. The unit switches to standby for safety reasons. Wait for about 30 minutes until the message disappears. Select a position with good ventilation when installing the unit. Do not block the cooling fan on the rear of the unit.	—
U72 U73	● The HDMI connection acts unusually. – The connected equipment is not HDMI compatible. – Please use HDMI cables that have the HDMI logo (as shown on the cover). – The HDMI cable is damaged.	—

H□□ or F□□	<ul style="list-style-type: none"> There is something unusual. (The service number displayed after H and F depends on the unit's condition.) Check the unit using the troubleshooting guide. If the service number does not disappear, do the following. <ol style="list-style-type: none"> Disconnect the plug from the AC outlet, wait a few seconds, then reconnect it. Press [POWER ⏻/I] to turn the power on. (The unit may be fixed.) If the service number does not disappear despite doing the above, request service from the dealer. Inform the dealer of the service number when requesting service. 	— 30–33
START	•The system is being restarted during the firmware update. Please do not turn off power.	9
UPD□/□	•The firmware is being updated.	9
FINISH	•The firmware update is complete.	9

Java and all Java-based trademarks and logos are trademarks or registered trademarks of Sun Microsystems, Inc. in the United States and other countries.
Manufactured under license from Dolby Laboratories. Dolby and the double-D symbol are trademarks of Dolby Laboratories.
"DTS" is a registered trademark of DTS, Inc. and "DTS-HD Master Audio Essential" is a trademark of DTS, Inc
U.S. Patent Nos. 6,836,549; 6,381,747; 7,050,698; 6,516,132; and 5,583,936.
This product incorporates copyright protection technology that is protected by U.S. patents and other intellectual property rights. Use of this copyright protection technology must be authorized by Macrovision, and is intended for home and other limited viewing uses only unless otherwise authorized by Macrovision. Reverse engineering or disassembly is prohibited.
HDMI, the HDMI logo and High-Definition Multimedia Interface are trademarks or registered trademarks of HDMI Licensing LLC.
This product is licensed under the AVC patent portfolio license and VC-1 patent portfolio license for the personal and non-commercial use of a consumer to (i) encode video in compliance with the AVC Standard and VC-1 Standard ("AVC/VC-1 Video") and/or (ii) decode AVC/VC-1 Video that was encoded by a consumer engaged in a personal and non-commercial activity and/or was obtained from a video provider licensed to provide AVC/VC-1 Video. No license is granted or shall be implied for any other use. Additional information may be obtained from MPEG LA, LLC. See http://www.mpegla.com .
HDAVI Control™ is a trademark of Matsushita Electric Industrial Co., Ltd.
VIERA Link™ is a trademark of Matsushita Electric Industrial Co., Ltd.
EZ Sync™ is a trademark of Matsushita Electric Industrial Co., Ltd.
"AVCHD" and the "AVCHD" logo are trademarks of Matsushita Electric Industrial Co., Ltd. and Sony Corporation.
SDHC Logo is a trademark.
Portions of this product are protected under copyright law and are provided under license by ARIS/SOLANA/4C.
Official DivX® Certified product. Plays all versions of DivX® video (including DivX®6) with standard playback of DivX® media files. DivX, DivX Certified, and associated logos are trademarks of DivX, Inc. and are used under license.

"Blu-ray Disc" is trademark.
"BD-LIVE" logo is trademark of Blu-ray Disc Association.
"BONUSVIEW" is trademark of Blu-ray Disc Association.

Language code list Enter the code with the numbered buttons.

Abkhazian: 6566	Catalan: 6765	Gujarati: 7185	Lingala: 7678	Rhaeto-Romance: 8277	Tamil: 8465
Afar: 6565	Chinese: 9072	Hausa: 7265	Lithuanian: 7684	Romanian: 8279	Tatar: 8484
Afrikaans: 6570	Corsican: 6779	Hebrew: 7387	Macedonian: 7775	Russian: 8285	Telugu: 8469
Albanian: 8381	Croatian: 7282	Hindi: 7273	Malagasy: 7771	Samoan: 8377	Thai: 8472
Ameharic: 6577	Czech: 6783	Hungarian: 7285	Malay: 7783	Sanskrit: 8365	Tibetan: 6679
Arabic: 6582	Danish: 6865	Icelandic: 7383	Malayalam: 7776	Scots Gaelic: 7168	Tigrinya: 8473
Armenian: 7289	Dutch: 7876	Indonesian: 7378	Maltese: 7784	Serbian: 8382	Tonga: 8479
Assamese: 6583	English: 6978	Interlingua: 7365	Maori: 7773	Serbo-Croatian: 8372	Turkish: 8482
Aymara: 6589	Esperanto: 6979	Irish: 7165	Marathi: 7782	Shona: 8378	Turkmen: 8475
Azerbaijani: 6590	Estonian: 6984	Italian: 7384	Moldavian: 7779	Sindhi: 8368	Twi: 8487
Bashkir: 6665	Faroese: 7079	Japanese: 7465	Mongolian: 7778	Singhalese: 8373	Ukrainian: 8575
Basque: 6985	Fiji: 7074	Javanese: 7487	Nauru: 7865	Slovak: 8375	Urdu: 8582
Bengali, Bangla: 6678	Finnish: 7073	Kannada: 7578	Nepali: 7869	Slovenian: 8376	Uzbek: 8590
Bhutani: 6890	French: 7082	Kashmiri: 7583	Norwegian: 7879	Somali: 8379	Vietnamese: 8673
Bihari: 6672	Frisian: 7089	Kazakh: 7575	Oriya: 7982	Spanish: 6983	Volapük: 8679
Breton: 6682	Galician: 7176	Kirghiz: 7589	Pashto, Pushto: 8083	Sundanese: 8385	Welsh: 6789
Bulgarian: 6671	Georgian: 7565	Korean: 7579	Persian: 7065	Swahili: 8387	Wolof: 8779
Burmese: 7789	German: 6869	Kurdish: 7585	Polish: 8076	Swedish: 8386	Xhosa: 8872
Byelorussian: 6669	Greek: 6976	Laotian: 7679	Portuguese: 8084	Tagalog: 8476	Yiddish: 7473
Cambodian: 7577	Greenlandic: 7576	Latin: 7665	Punjabi: 8065	Tajik: 8471	Yoruba: 8979
	Guarani: 7178	Latvian, Lettish: 7686	Quechua: 8185	Zulu: 9085	

Reference

Specifications

Signal system: NTSC
Operating temperature range: +5 to +35 °C (+41 to +95 °F)
Operating humidity range: 10 to 80 % RH (no condensation)
Playable disc:
BD-Video
BD-ROM: Version 2
BD-RE: Version 3 (Single Layer, Dual Layer), JPEG*6
BD-R Version 2 (Single Layer, Dual Layer)
DVD-RAM: DVD Video Recording format, AVCHD format*8, JPEG*4
DVD-R/DVD-R DL: DVD-Video format*1, DVD-Video Recording format, AVCHD format*1,8, DivX*7
DVD-RW: DVD-Video format*1, DVD-Video Recording format, AVCHD format*1,8
+R/+RW/+R DL: Video*1, AVCHD format*1,8
DVD-VIDEO: DVD-Video format
CD-Audio: CD-DA
CD-R/RW: CD-DA, JPEG*5, MP3, DivX*7

SD card:
SD Memory Card*2 formatted FAT12, FAT16, FAT32*3:
JPEG*4, AVCHD format*8

Video output:
Output level: 1.0 Vp-p (75 Ω)
Output connector: Pin jack (1 system)

S-video output:
Y output level: 1.0 Vp-p (75 Ω)
C output level: 0.286 Vp-p (75 Ω) at Burst
Output connector: S terminal (1 system)

Component video output: (1080i/720p/480p/480i)
Y output level: 1.0 Vp-p (75 Ω)
P_B output level: 0.7 Vp-p (75 Ω)
P_R output level: 0.7 Vp-p (75 Ω)
Output connector: Pin jack (Y: green, P_B: blue, P_R: red) (1 system)

Audio output:
Output level: 2 Vrms (1 kHz, 0 dB)
Output connector: Pin jack
Number of connectors: 2 channel: 1 system
5.1 channel discrete output: 1 system

Audio performance:
Frequency response:
• DVD (linear audio): 4 Hz to 22 kHz (48 kHz sampling)
4 Hz to 44 kHz (96 kHz sampling)
• CD-Audio: 4 Hz to 20 kHz
S/N ratio: 115 dB
Dynamic range: 100 dB
Total harmonic distortion: 0.003 %

Digital audio output:
Optical digital output: Optical terminal
Coaxial digital output: Pin jack

HDMI AV output
Output format: 480p (525p)/1080i (1125i)/720p (750p)/1080p (1125p)
Output Connector: Type A (19 pin)
HDMI™ (Deep color, High Bit rate Audio)
• This unit supports "HDAVI Control 3" function.

SD card slot:
Output connector: 1 system
Ethernet:
10BASE-T/100BASE-TX: 1 system

Optical pick-up: System with 2 lenses
Wave length: 782 nm (CDs)/662 nm (DVDs)/405 nm (BDs)

LASER Specification
Class I LASER Product:
Wave length: 782 nm (CDs)/662 nm (DVDs)/405 nm (BDs)
Laser power:
No hazardous radiation is emitted with the safety protection

Power supply: AC 120 V, 60 Hz
Power consumption: approx. 25 W

Power consumption in standby mode: **less than 1 W**

Dimensions (W×D×H)
Excluding the projecting parts: 430 mm×313 mm×59 mm
(Approx. 16 15/16"×12 5/16"×2 5/16")
Including the projecting parts: 430 mm×320 mm×59 mm
(Approx. 16 15/16"×12 5/8"×2 5/16")

Mass (Weight): approx. 3.3 kg (7.3 lbs)

Note
Specifications are subject to change without notice.

- *1 Finalizing is necessary.
 - *2 Includes SDHC card
Includes miniSD Cards (need a miniSD Adaptor)
Includes microSD Cards (need a microSD Adaptor)
 - *3 Does not support long file name
 - *4 The total combined maximum number of recognizable picture contents and folders: 3000 picture contents and 300 folders.
 - *5 The total combined maximum number of recognizable picture contents and folders: 999 picture contents and 99 folders.
 - *6 The total combined maximum number of recognizable picture contents and folders: 9999 picture contents and 300 folders.
 - *7 The total combined maximum number of recognizable picture contents and folders: 200 file contents and 300 folders.
 - *8 AVCHD format V1.0
- Useable capacity will be less. (SD Card)

Disc and card handling

Clean discs



Wipe with a damp cloth and then wipe dry.

Disc and card handling precautions

- Handle discs by the edges to avoid inadvertent scratches or fingerprints on the disc.
- Do not attach labels or stickers to discs (This may cause disc warping, rendering it unusable).
- Do not write on the label side with a ball-point pen or other writing instrument.
- Do not use record cleaning sprays, benzene, thinner, static electricity prevention liquids or any other solvent.
- Do not use scratch-proof protectors or covers.
- Clean any dust, water, or foreign matter from the terminals on the rear side of the card.
- Do not use the following discs:
 - Discs with exposed adhesive from removed stickers or labels (rented discs etc).
 - Discs that are badly warped or cracked.
 - Irregularly shaped discs, such as heart shapes.

Maintenance

Clean this unit with a soft, dry cloth

- Never use alcohol, paint thinner or benzene to clean this unit.
- Before using chemically treated cloth, carefully read the instructions that came with the cloth.

Observe the following points to ensure continued listening and viewing pleasure.

Dust and dirt may adhere to the unit's lens over time, making it impossible to play discs.

Use the lens cleaner (not included) about once every year, depending on frequency of use and the operating environment. Carefully read the lens cleaner's instructions before use.

Lens cleaner: RP-CL720PP
• This lens cleaner is sold as specific for DIGA, but can be used without problem on this unit as well.

To dispose or transfer this unit

This unit may record information of your operating procedures. If you discard this unit either by disposal or transfer, then follow the procedures to return all the settings to the factory presets to delete the recorded information. (⇒ 30, "To return to the factory preset")
• When BD-Video is played back, the operation history may be recorded in the memory of this unit. The recorded contents differ depending on the disc.

Limited Warranty (ONLY FOR U.S.A.)

Panasonic Consumer Electronics Company,
Division of Panasonic Corporation of North America
One Panasonic Way Secaucus, New Jersey 07094

Panasonic Puerto Rico, Inc.
Ave. 65 de Infantería, Km. 9.5
San Gabriel Industrial Park, Carolina, Puerto Rico 00985

Panasonic Blu-ray Disc Player Limited Warranty

Limited Warranty Coverage

If your product does not work properly because of a defect in materials or workmanship, Panasonic Consumer Electronics Company or Panasonic Puerto Rico, Inc. (collectively referred to as "the warrantor") will, for the length of the period indicated on the chart below, which starts with the date of original purchase ("Limited Warranty period"), at its option either (a) repair your product with new or refurbished parts, or (b) replace it with a new or a refurbished product. The decision to repair or replace will be made by the warrantor.

Product or Part Name	Parts	Labor
Blu-ray Disc Player	One (1) Year	One (1) Year

During the "Labor" Limited Warranty period there will be no charge for labor. During the "Parts" warranty period, there will be no charge for parts. You must mail-in your product during the warranty period. If non-rechargeable batteries are included, they are not warranted. This Limited Warranty only applies to products purchased and serviced in the United States or Puerto Rico. This Limited Warranty is extended only to the original purchaser and only covers product purchased as new. A purchase receipt or other proof of original purchase date is required for Limited Warranty service.

For assistance in Puerto Rico call Panasonic Puerto Rico, Inc. (787)-750-4300 or fax (787)-768-2910.

When shipping the unit carefully pack and send it prepaid, adequately insured and preferably in the original carton. Include a letter detailing the complaint and provide a day time phone and/or email address where you can be reached.

IF REPAIR IS NEEDED DURING THE LIMITED WARRANTY PERIOD THE PURCHASER WILL BE REQUIRED TO FURNISH A SALES RECEIPT/PROOF OF PURCHASE INDICATING DATE OF PURCHASE, AMOUNT PAID AND PLACE OF PURCHASE. CUSTOMER WILL BE CHARGED FOR THE REPAIR OF ANY UNIT RECEIVED WITHOUT SUCH PROOF OF PURCHASE.

Limited Warranty Limits And Exclusions

This Limited Warranty ONLY COVERS failures due to defects in materials or workmanship, and DOES NOT COVER normal wear and tear or cosmetic damage. The Limited Warranty ALSO DOES NOT COVER damages which occurred in shipment, or failures which are caused by products not supplied by the warrantor, or failures which result from accidents, misuse, abuse, neglect, mishandling, misapplication, alteration, faulty installation, set-up adjustments, misadjustment of consumer controls, improper maintenance, power line surge, lightning damage, modification, or commercial use (such as hotel, office, restaurant, or other business), rental use of the product, or service by anyone other than a Factory Servicenter or other Authorized Servicer, or damage that is attributable to acts of God.

THERE ARE NO EXPRESS WARRANTIES EXCEPT AS LISTED UNDER "LIMITED WARRANTY COVERAGE". THE WARRANTOR IS NOT LIABLE FOR INCIDENTAL OR CONSEQUENTIAL DAMAGES RESULTING FROM THE USE OF THIS PRODUCT, OR ARISING OUT OF ANY BREACH OF THIS WARRANTY. (As examples, this excludes damages for lost time, cost of having someone remove or re-install an installed unit if applicable, travel to and from the servicer, loss of or damage to media or images, data or other recorded content. The items listed are not exclusive, but are for illustration only.)

ALL EXPRESS AND IMPLIED WARRANTIES, INCLUDING THE WARRANTY OF MERCHANTABILITY, ARE LIMITED TO THE PERIOD OF THE LIMITED WARRANTY.

Some states do not allow the exclusion or limitation of incidental or consequential damages, or limitations on how long an implied Limited Warranty lasts, so the exclusions may not apply to you.

This Limited Warranty gives you specific legal rights and you may also have other rights which vary from state to state. If a problem with this product develops during or after the Limited Warranty period, you may contact your dealer or Servicenter. If the problem is not handled to your satisfaction, then write to the warrantor's Consumer Affairs Department at the addresses listed for the warrantor.

PARTS AND SERVICE, WHICH ARE NOT COVERED BY THIS LIMITED WARRANTY, ARE YOUR RESPONSIBILITY.

Customer Services Directory

Obtain Product Information and Operating Assistance; purchase Parts, Accessories, or obtain Literature by visiting our Web Site at:

<http://www.panasonic.com/consumersupport>

or, contact us via the web at:

<http://www.panasonic.com/contactinfo>

You may also contact us directly at:

1-800-211-PANA (7262),

Monday-Friday 9 am-9 pm; Saturday-Sunday 10 am-7 pm, EST.

For hearing or speech impaired TTY users, TTY: 1-877-833-8855

Accessory Purchases

Purchase Parts, Accessories and Instruction Books online for all Panasonic Products by visiting our Web Site at:

<http://www.pstc.panasonic.com>

or, send your request by E-mail to:

npcparts@us.panasonic.com

You may also contact us directly at:

1-800-332-5368 (Phone) 1-800-237-9080 (Fax Only) (Monday – Friday 9 am to 9 pm, EST.)

Panasonic Service and Technology Company

20421 84th Avenue South, Kent, WA 98032

(We Accept Visa, MasterCard, Discover Card, American Express, and Personal Checks)

For hearing or speech impaired TTY users, TTY : 1-866-605-1277

Product Repairs

MAIL TO:

Centralized Factory Servicenter

Panasonic Service and Technology Company

410B Airport Road

Elgin, IL 60123-9333

Attention: BD/DVD Repair

Please carefully pack and ship, prepaid and insured, to the Elgin Centralized Factory Servicenter. Customers in Puerto Rico, please ship or carry in to location below ("Service in Puerto Rico").

Service in Puerto Rico

Panasonic Puerto Rico, Inc.

Ave. 65 de Infantería, Km. 9.5, San Gabriel Industrial Park, Carolina, Puerto Rico 00985

Phone (787)750-4300, Fax (787)768-2910

Limited Warranty (ONLY FOR CANADA)

Panasonic Canada Inc.

PANASONIC PRODUCT—LIMITED WARRANTY

Panasonic Canada Inc. warrants this product to be free from defects in material and workmanship and agrees to remedy any such defect for a period as stated below from the date of original purchase.

Technics Audio Product	One (1) year, parts and labour
Panasonic Portable/Clock Radio (without Tape, CD, MD)	One (1) year, parts and labour
Panasonic Audio/SD Audio Product	One (1) year, parts and labour
Panasonic BD/DVD Product	One (1) year, parts and labour
Panasonic Combination DVD Player/VCR	One (1) year, parts and labour
Panasonic Combination DVD Recorder/VCR	One (1) year, parts and labour
Accessories including rechargeable batteries	Ninety (90) days

LIMITATIONS AND EXCLUSIONS

This warranty does not apply to products purchased outside Canada or to any product which has been improperly installed, subjected to usage for which the product was not designed, misused or abused, damaged during shipping, or which has been altered or repaired in any way that affects the reliability or detracts from the performance, nor does it cover any product which is used commercially. Dry cell batteries are also excluded from coverage under this warranty.

This warranty is extended to the original end user purchaser only. A purchase receipt or other proof of date of original purchase is required before warranty service is performed.

THIS EXPRESS, LIMITED WARRANTY IS IN LIEU OF ALL OTHER WARRANTIES, EXPRESS OR IMPLIED, INCLUDING ANY IMPLIED WARRANTIES OF MERCHANTABILITY AND FITNESS FOR A PARTICULAR PURPOSE.

IN NO EVENT WILL PANASONIC CANADA INC. BE LIABLE FOR ANY SPECIAL, INDIRECT OR CONSEQUENTIAL DAMAGES.

In certain instances, some jurisdictions do not allow the exclusion or limitation of incidental or consequential damages, or the exclusion of implied warranties, so the above limitations and exclusions may not be applicable.

WARRANTY SERVICE

FOR PRODUCT OPERATION ASSISTANCE, please contact:

Our Customer Care Centre: Telephone #: (905) 624-5505
1-800 #: 1-800-561-5505
Fax #: (905) 238-2360
Email link: "Customer support" on www.panasonic.ca

FOR PRODUCT REPAIRS, please locate your nearest Authorized Servicentre at www.panasonic.ca :

Link : "Servicentres™ locator" under "Customer support"

IF YOU SHIP THE PRODUCT TO A SERVICENTRE

Carefully pack and send prepaid, adequately insured and preferably in the original carton.

Include details of the defect claimed, and proof of date of original purchase.

Product Service

- 1. Damage requiring service**—The unit should be serviced by qualified service personnel if:
 - (a) The AC power supply cord or AC adaptor has been damaged; or
 - (b) Objects or liquids have gotten into the unit; or
 - (c) The unit has been exposed to rain; or
 - (d) The unit does not operate normally or exhibits a marked change in performance; or
 - (e) The unit has been dropped or the cabinet damaged.
- 2. Servicing**—Do not attempt to service the unit beyond that described in these operating instructions. Refer all other servicing to authorized servicing personnel.

- 3. Replacement parts**—When parts need replacing ensure the servicer uses parts specified by the manufacturer or parts that have the same characteristics as the original parts. Unauthorized substitutes may result in fire, electric shock, or other hazards.
- 4. Safety check**—After repairs or service, ask the servicer to perform safety checks to confirm that the unit is in proper working condition.

Product information

For product information or assistance with product operation:

In the U.S.A., refer to "Customer Services Directory" on page 37. In Canada, contact the Panasonic Canada Inc. Customer Care Centre at 1-800-561-5505, or visit the website (www.panasonic.ca), or an authorized Servicentre closest to you.

The model number and serial number of this product can be found on either the back or the bottom of the unit. Please note them in the space provided below and keep for future reference.

MODEL NUMBER _____ DMP-BD50 _____
SERIAL NUMBER _____

User memo:

DATE OF PURCHASE _____
DEALER NAME _____
DEALER ADDRESS _____
TELEPHONE NUMBER _____

Referencia rápida en español

Conexiones básicas

A Conexión a un televisor compatible con HDMI

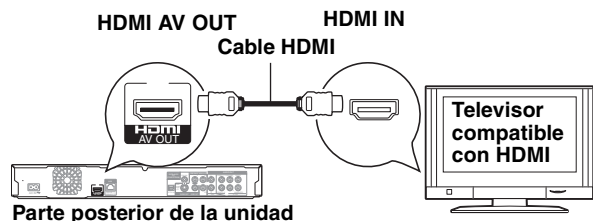

B Conexión a un televisor con un cable para audio/vídeo

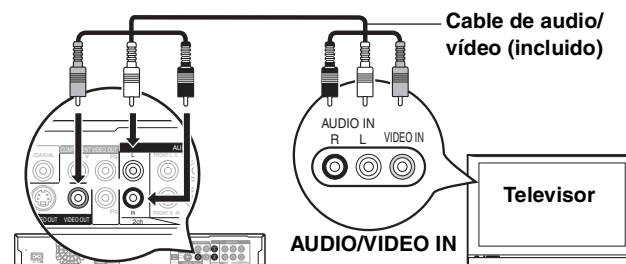

Parte posterior de la unidad

- Esta conexión no permite la salida de vídeo de alta definición. Utilice la conexión **A** o **C** para obtener vídeo de alta definición.

C Conexión a un televisor compatible con HDMI y a un amplificador/receptor compatible con HDMI

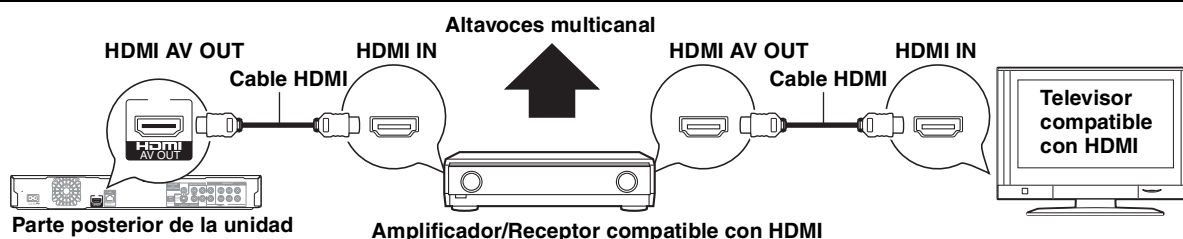

Conecte el cable de alimentación de CA por último

A una toma de corriente doméstica (CA 120 V, 60 Hz)

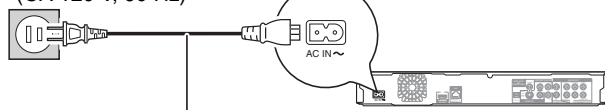

Cable de alimentación de CA (incluido)

Conéctelo cuando haya realizado el resto de conexiones.

Ahorro de energía

Esta unidad consume una pequeña cantidad de energía aunque esté ajustada en el modo de espera (aprox. 1 W). Para ahorrar energía cuando no vaya a utilizar la unidad durante mucho tiempo, desenchúfela de la toma de corriente.

Reproducción básica

Preparación

Encienda el televisor y seleccione la entrada de vídeo adecuada en el televisor.

1 Pulse [**BD POWER**] para encender la unidad.

Después de conectar su nuevo reproductor y pulsar el botón de encendido, aparecerá la pantalla de la configuración básica.

2 Pulse [**OPEN/CLOSE**] para abrir la bandeja del disco, cargue el disco.

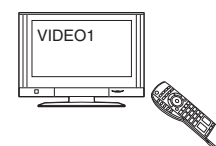

Inicia la reproducción



Parada

La posición de detención se memoriza.

Función de reanudación de la reproducción

Pulse [**▶**] (PLAY) para reiniciar la reproducción desde esta posición.

• La posición se borra si se abre la bandeja o se pulsa [**■**] varias veces para visualizar "STOP" en el visor de la unidad.

• **BD-V**: En los discos BD-Video incluidos los BD-J, la función de reanudación de la reproducción no funciona.

• **CD** **MP3** **DivX**: La posición se borra si apaga la unidad.



Pausa

• Pulse [**||**] otra vez o [**▶**] (PLAY) para reiniciar la reproducción.

SLOW/SEARCH



Búsqueda/
Cámara lenta

La velocidad aumenta hasta 5 pasos.

- Pulse [**▶**] (PLAY) para recuperar la velocidad de reproducción normal.
- Para algunos discos, la velocidad podría no cambiar.

Búsqueda

Durante la reproducción, pulse [**◀◀**] o [**▶▶**].

• Pulse y mantenga pulsado en la unidad principal [**◀◀/◀◀**] o [**▶▶/▶▶**].

• **BD-V** **AVCHD** **DVD-VR** **DVD-V**:

El audio se oye durante la búsqueda en avance de primer nivel.

• **DivX**: El sonido no se oye durante todos los niveles de búsqueda.

• **CD** **MP3**: La velocidad está fija en un paso.

Cámara lenta

Durante la pausa, pulse [**◀◀**] o [**▶▶**].

• Pulse y mantenga pulsado en la unidad principal [**◀◀/◀◀**] o [**▶▶/▶▶**].

• **BD-V** **AVCHD**: Sólo dirección en avance [**▶▶**].

• **DVD-VR**: Si continúa durante aprox. 5 minutos, la reproducción en cámara lenta se para automáticamente.



Salto

• Salta hasta el título, capítulo o pista que desee reproducir.

• Cada pulsación aumenta el número de saltos.

• **DivX**: Solo dirección hacia atrás [**◀◀**].

Glossary

AVCHD

AVCHD is a new format (standard) for high definition video cameras that can be used to record and play high-resolution HD images.

BD-J

Some BD-Video discs contain Java applications, and these applications are called BD-J. You can enjoy various interactive features in addition to playing normal video.

BD-Live

This is a BD-Video (BD-ROM version 2 Profile 2) that supports the new functions such as Internet connection, etc. in addition to the BONUSVIEW function.

Bitstream

This is the digital form of multi-channel audio data (e.g., 5.1 channel) before it is decoded into its various channels.

BONUSVIEW (Final Standard Profile)

This is a BD-Video (BD-ROM version 2 Profile 1 version 1.1) that supports the new functions such as Picture-in-picture, Secondary Audio, and Virtual Package, etc.

DivX

DivX is a popular media technology created by DivX, Inc. DivX media files contain highly compressed video with high visual quality that maintains a relatively small file size.

DNS Server

A server which acts like a telephone directory and translates Internet domain names into IP addresses.

Dolby Digital

This is a method of coding digital signals developed by Dolby Laboratories. Apart from stereo (2-channel) audio, these signals can also be multi-channel audio.

Dolby Digital Plus

Multi-channel audio and higher audio quality is made possible using Dolby Digital Plus. BD-Video supports up to 7.1 channel output.

Dolby TrueHD

Dolby TrueHD is a very high quality audio format that reproduces the studio master audio. BD-Video supports up to 7.1 channel output.

Down-mixing

This is the process of remixing the multi-channel audio found on some discs into fewer channels.

DTS (Digital Theater Systems)

This surround system is used in many movie theaters. There is good separation between the channels, so realistic sound effects are possible.

DTS-HD

DTS-HD is a high-quality, sophisticated audio format used in movie theaters. Previous DTS Digital Surround-compatible equipment can play DTS-HD as DTS Digital Surround audio. BD-Video supports up to 7.1 channel output.

Dynamic range

Dynamic range is the difference between the lowest level of sound that can be heard above the noise of the equipment and the highest level of sound before distortion occurs.

Dynamic range compression means reducing the gap between the loudest and softest sounds. This means you can listen at low volumes but still hear dialog clearly.

Film and video

DVD-Video are recorded using either film or video. This unit can determine which type has been used, then uses the most suitable method of progressive output.

Film: Recorded at 24 frames per second. (Recorded at 30 frames per second as well). Generally appropriate for motion picture films.

Video: Recorded at 30 frames/60 fields per second. Generally appropriate for TV drama programs or animation.

Frames and fields

Frames refer to the single images that constitute the video you see on your television. Each frame consists of two fields.



Frame

Field

Field

- A frame still shows two fields, so there may be some blurring, but picture quality is generally better.
- A field still shows less picture information so it may be rougher, but there is no blurring.

Gateway

IP address of the electronic device providing Internet access. Usually called a router IP address. (e.g., 192.168.0.1)

HDMI (High-Definition Multimedia Interface)

HDMI is a digital interface for consumer electronic products. Unlike conventional connections, it transmits uncompressed digital video and audio signals on a single cable.

Hub

Used for connecting more than one device to the network.

IP address

A set of numbers which distinguish each device on the network when, for example, connected to the Internet. When using a PC in a LAN to access a PC or device that is not included in the LAN, the IP address is called the local IP address. (e.g., 192.168.0.10)

JPEG (Joint Photographic Experts Group)

This is a system used for compressing/decoding color still pictures. If you select JPEG as the storage system on digital cameras, etc., the data will be compressed to 1/10–1/100 of its original size. The benefit of JPEG is less deterioration in picture quality considering the degree of compression.

LAN (Local Area Network)

A group of linked devices in a company, school or home. Indicates the boundaries of a particular network.

Local storage

This storage area is used as a destination for sub contents for playing virtual packages on BD-Video.

LPCM (Linear PCM)

These are a kind of PCM format. These are uncompressed digital signals, similar to those found on CDs.

MP3 (MPEG Audio Layer 3)

An audio compression method that compresses audio to approximately one tenth of its size without any significant loss of audio quality.

Pan&Scan/Letterbox

In general, DVD-Video are produced with the intention that they be viewed on a widescreen television (16:9 aspect ratio), so images often don't fit regular (4:3 aspect ratio) televisions. Two styles of picture, "Pan & Scan" and "Letterbox", deal with this problem.

Pan&Scan: The sides are cut off so the picture fills the screen.



Letterbox: Black bands appear at the top and bottom of the picture so the picture itself appears in an aspect ratio of 16:9.



PCM (Pulse Code Modulation)

This is one format for converting analog audio into digital audio, enabling you to enjoy digital audio with no hassle.

Picture-in-picture

This is a new function of BD-Video that plays the primary video and secondary video simultaneously. For instance, the function is capable of playing the original movie as the primary video while playing video commentary from the film director on a small screen as a secondary video.

Progressive/Interlace

The video signal standard of NTSC has 480 interlaced (i) scan lines, whereas progressive (p) scanning uses twice the number of scan lines, and this is referred to as 480p. Using progressive output, you can enjoy watching high resolution video.

Router

Distinguishes the IP address assigned to each device, such as the PC, and relays the flow of data within the network.

Sampling frequency

Sampling is the process of converting the heights of sound wave (analog signal) samples taken at set periods into digits (digital encoding). Sampling frequency is the number of samples taken per second, so larger numbers mean more faithful reproduction of the original sound.

Subnet mask

Enables efficient network use. A set of numbers which identify which part of the IP address allocated to every device connected to the router is the network portion.

Virtual package

Some BD-Video discs copy data to other media (local storage) and then play the secondary video, secondary audio, and subtitles (sub contents) simultaneously.

These functions are called virtual packages. Sub contents are automatically recorded to other media from the Internet or disc prior to playing the virtual package. The playback methods vary depending on discs.

1080i (1125i)

In one high definition image, 1080 (1125) alternating scan lines pass to create an interlaced image. Because 1080i (1125i) more than doubles current television broadcasts of 480i, the detail is much clearer and creates a more realistic and rich image.

1080p (1125p)

In one high definition image, 1080 (1125) scan lines pass at the same time to create a progressive image. Since progressive video does not alternate scan lines like interlace, there is a minimal amount of screen flicker.

24p

This is a progressive image recorded at a rate of 24 frames per second.

720p (750p)

In one high definition image, 720 (750) scan lines pass at the same time to create a progressive image. Since progressive video does not alternate scan lines like interlace, there is a minimal amount of screen flicker.

Index

A Angle.....24	F Finalize.....4	P PCM Down Conversion.....27
Audio	Firmware.....9	Picture-in-picture.....16
Attribute.....24	Format.....16	Playlist.....21
Changing audio.....15	H HDMI.....6, 7, 40	Pop-up Menu.....14
Channel.....24	I IP address.....12, 40	Progressive.....25, 40
Language.....24, 26	J JPEG.....18, 22, 40	Properties
AVCHD40	L LAN.....9, 40	Chapter.....18
B BD-J.....40	Language	Still picture.....19
BD-Live.....16, 40	Audio.....24, 26	Proxy Server13
BD-Video Ratings.....26	Code list.....35	R Ratings level.....26
BONUSVIEW (Final Standard Profile)	On-screen.....27	Re-master.....15, 25
.....16, 40	Soundtrack.....24	Remote control code.....33
C Chapter.....18	Subtitle.....24, 26	Repeat play.....25
Cleaning	Local storage40	Restore Default Settings.....29
Disc.....36	LPCM40	Resume play function.....15
Lens.....36	M Maintenance.....36	S SD card.....5, 16
Main unit.....36	Menu	Setup menu.....26
Connection	On-screen.....24	Slideshow.....19
Amplifier/Receiver.....7, 8	Pop-up.....14	Soundtrack.....24
HDMI.....6, 7	Setup.....26	Status Message.....15
D Dialog Enhancer.....25	MP321, 22, 40	Still pictures.....18
Direct Navigator.....14	N Noise reduction (NR)	Subtitle.....24
DivX.....20, 22, 40	Integrated NR.....25	V V. Surround.....25
DNS Server.....12, 40	3D NR.....25	VIERA Link™ “HDAVI Control™”23
Dolby Digital.....27, 40	O Off Timer.....29	Virtual package.....16
Dolby Digital Plus.....17, 27, 40	On-screen	24p.....25, 28
Dolby TrueHD.....17, 27, 40	Language.....27	
DTS.....27, 40	Menu.....24	
DTS-HD.....17, 27, 40	Status messages.....15	

-If you see this symbol-

Information on Disposal in other Countries outside the European Union



This symbol is only valid in the European Union. If you wish to discard this product, please contact your local authorities or dealer and ask for the correct method of disposal.

For U.S.A.

Panasonic Consumer Electronics Company, Division of Panasonic Corporation of North America
 One Panasonic Way Secaucus,
 New Jersey 07094
<http://www.panasonic.com>

Panasonic Puerto Rico, Inc.
 Ave. 65 de Infantería, Km. 9.5
 San Gabriel Industrial Park, Carolina,
 Puerto Rico 00985

For Canada

Panasonic Canada Inc.
 5770 Ambler Drive
 Mississauga, Ontario
 L4W 2T3
www.panasonic.ca

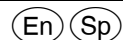

Free Manuals Download Website

<http://myh66.com>

<http://usermanuals.us>

<http://www.somanuals.com>

<http://www.4manuals.cc>

<http://www.manual-lib.com>

<http://www.404manual.com>

<http://www.luxmanual.com>

<http://aubethermostatmanual.com>

Golf course search by state

<http://golfingnear.com>

Email search by domain

<http://emailbydomain.com>

Auto manuals search

<http://auto.somanuals.com>

TV manuals search

<http://tv.somanuals.com>