

Panasonic

DVD/Video CD/CD Player

Operating Instructions

Model No.

DVD-A320U



Before attempting to connect, operate or adjust this player, please read these instructions completely. Please save this manual.

Dear Customer

May we take this opportunity to thank you for purchasing this Panasonic DVD/Video CD/CD Player.

We strongly recommend that you carefully study the Operating Instructions before attempting to operate the player and that you note the listed precautions.



This manual was printed with soy based ink.

VQT8107

Safety information

Note

This player can be used only where the power supply is AC 120 V, 60 Hz. It cannot be used elsewhere.

CAUTION:

DVD/VIDEO CD/CD PLAYER IS A CLASS I LASER PRODUCT. HOWEVER THIS DVD/VIDEO CD/CD PLAYER USES A VISIBLE LASER BEAM WHICH COULD CAUSE HAZARDOUS RADIATION EXPOSURE IF DIRECTED. BE SURE TO OPERATE THE DVD/VIDEO CD/CD PLAYER CORRECTLY AS INSTRUCTED.

WHEN THIS DVD/VIDEO CD/CD PLAYER IS PLUGGED TO THE WALL OUTLET, DO NOT PLACE YOUR EYES CLOSE TO THE OPENING OF THE DISC TRAY AND OTHER OPENINGS TO LOOK INTO THE INSIDE OF THIS PLAYER.

USE OF CONTROLS OR ADJUSTMENTS OR PERFORMANCE OF PROCEDURES OTHER THAN THOSE SPECIFIED HEREIN MAY RESULT IN HAZARDOUS RADIATION EXPOSURE.

DO NOT OPEN COVERS AND DO NOT REPAIR YOURSELF. REFER SERVICING TO QUALIFIED PERSONNEL.

WARNING:

TO REDUCE THE RISK OF FIRE OR ELECTRIC SHOCK, DO NOT EXPOSE THIS PLAYER TO RAIN OR MOISTURE.

TO REDUCE THE RISK OF FIRE OR ELECTRIC SHOCK, AND ANNOYING INTERFERENCE, USE THE RECOMMENDED ACCESSORIES ONLY.

THIS PLAYER IS INTENDED FOR CONTINUOUS OPERATION!

CAUTION:

TO PREVENT ELECTRIC SHOCK, DO NOT USE THIS (POLARIZED) PLUG WITH AN EXTENSION CORD, RECEPTACLE OR OTHER OUTLET UNLESS THE BLADES CAN BE FULLY INSERTED TO PREVENT BLADE EXPOSURE.

FCC NOTE:

This equipment has been tested and found to comply with the limits for a Class B digital device, pursuant to Part 15 of the FCC Rules. These limits are designed to provide reasonable protection against harmful interference in a residential installation. This equipment generates, uses and can radiate radio frequency energy and, if not installed and used in accordance with the instructions, may cause harmful interference to radio communications. However, there is no guarantee that interference will not occur in a particular installation. If this equipment does cause harmful interference to radio or television reception, which can be determined by turning the equipment off and on, the user is encouraged to try to correct the interference by one or more of the following measures:



CAUTION
RISK OF ELECTRIC SHOCK
DO NOT OPEN



CAUTION: TO REDUCE THE RISK OF ELECTRIC SHOCK, DO NOT REMOVE COVER (OR BACK). NO USER-SERVICEABLE PARTS INSIDE. REFER SERVICING TO QUALIFIED SERVICE PERSONNEL.



The lightning flash with arrowhead symbol, within an equilateral triangle, is intended to alert the user to the presence of uninsulated "dangerous voltage" within the product's enclosure that may be of sufficient magnitude to constitute a risk of electric shock to persons.



The exclamation point within an equilateral triangle is intended to alert the user to the presence of important operating and maintenance (servicing) instructions in the literature accompanying the appliance.

CAUTION	-LASER RADIATION WHEN OPEN. DO NOT STARE INTO BEAM.
ATTENTION	-RAYONNEMENT LASER EN CAS D'OUVERTURE. NE PAS REGARDER DANS LE FAISCEAU.
VORSICHT	-LASERSTRAHLUNG, WENN ABDECKUNG GEÖFFNET. NICHT IN DEN STRAHL BLICKEN.
ADVARSEL	-LASERSTRÅLING VED ÅBNING. SE IKKE IND I STRÅLEN.
ADVARSEL	-LASERSTRÅLING NÅR DEKSEL ÅPNES. STIRR IKKE INN I STRÅLEN.
VARNING	-LASERSTRÅLNING NÅR DENNA DEL ÅR ÖPPNAD. STIRRA EJ IN I STRÅLEN.
VARO!	-AVATTAESSA OLET ALTTIINA LASERSÄTELYLLE. ÄLÄ TUJOTA SÄTEESEEN.
注意	- 当打开这里会出现激光, 请不要直视激光。
注意	- ここを開くとレーザー光が出ます。 レーザー光をのぞき込まないでください。

(Inside of player)

- Reorient or relocate the receiving antenna.
- Increase the separation between the equipment and receiver.
- Connect the equipment into an outlet on a circuit different from that to which the receiver is connected.
- Consult the dealer or an experienced radio/TV technician for help.

FCC Caution: To assure continued compliance, follow the attached installation instructions and use only shielded cables when connecting to other devices. Also, any changes or modifications not expressly approved by the party responsible for compliance could void the user's authority to operate this equipment.

Precautions

Please read these precautions before operating this player.

■ AC cord protection

To avoid malfunctions and to protect against electric shock, fire or personal injury, please observe the following:

- Hold the plug firmly when connecting or disconnecting the AC cord.
- Do not connect or disconnect the AC cord with wet hands.
- Keep the AC cord away from heating appliances.
- Do not put heavy objects on the AC cord.
- Do not attempt to repair or reconstruct the AC cord in any way.
- Remove dust, dirt, etc. from the plug regularly.
- If the player has been dropped or damaged in any way, set the player to the standby mode and disconnect the AC cord.
- If smoke, odors or noises are emitted from the player, set the player to the standby mode and disconnect the AC cord.

■ Placement

- Do not place in direct sunlight, near radiators, or in closed automobiles.
- Avoid high temperature [over 95°F (35°C)] and high humidity (over 90%).
- Avoid excessive dust.
- Do not place where it can be exposed to vibration or impacts.
- Avoid placing on an inclined surface.

■ Non-use periods

When the player is not being used, set to standby mode. When left unused for a long period of time, the player should be unplugged from the household AC outlet.

■ No fingers or other objects inside

- Touching internal parts of this player is dangerous, and may cause serious damage to the player. Do not attempt to disassemble the player.
- Do not put any object other than discs on the disc tray.

■ Keep away from water and magnets.

- Keep the player away from flower vases, tubs, sinks, etc. If liquids are spilled into the player, serious damage could occur.
- Keep magnetic objects such as speakers, at a distance from the player.

■ Stacking

- Place the player in a horizontal position, and do not place anything heavy on it.
- Do not place the player on amplifiers or other equipment which may become hot.

■ Condensation

Moisture may form on the lens in the following conditions:

- immediately after a heater has been turned on.
- in a steamy or very humid room.
- when the player is moved from a cold environment to a warm one.

If moisture forms inside this player, it may not operate properly. In this case, turn on the power and wait about one hour for the moisture to evaporate.

■ If there is interference on the TV while a broadcast is being received

Depending on the reception condition of the TV, interference may occur if the player is left on. This is not a malfunction of the player or the TV. To watch a TV broadcast, set the player to the standby mode.

The model number and serial number of this player can be found on either the back or the bottom of the player. Please note them in the space provided below and retain this booklet as a permanent record of your purchase to aid identification in the event of theft.

MODEL NUMBER _____
SERIAL NUMBER _____

Accessories

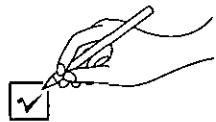

Please check and identify the supplied accessories. To order accessories, call PASC Accessory Dept. 1-888-PANA-DVD (1-888-726-2383).

Optional accessories

S video cable
Optical digital audio cable
Coaxial audio cable

Remote control 1
(Part No. VEQ2250)

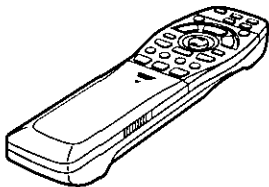

Batteries 2
for remote control
(R6, AA, UM-3)

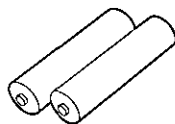

AC cord 1
(Part No. VJA1094)

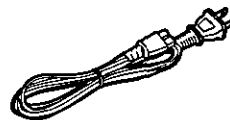

Audio/video cable 1
(Part No. VJA1062)

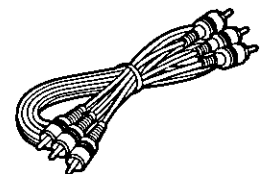

Service Center list 1
 Warranty card 1
 Safety Instructions card 1

Product information card 1
 Setup Guide (Spanish) 1
 Operating Instructions 1

Features

■ High picture quality

● 10 bit video D/A converter

Reproduces fine images faithfully.

● Component video output

When used with a compatible monitor, a video connection via the component video output jacks of your DVD/Video CD/CD player enables precise color reproduction.

● An array of picture quality modes yielded by digital processing

Signal deterioration is kept to minimum by processing the data digitally.

This feature can be used to tailor picture quality for DVD playback.

– Digital picture mode (See pages 15 and 21.)

Using the On-Screen Menu Icons allows you to adjust picture quality to suit the kind of software you are viewing.

– User selection (See page 21.)

Using the On-Screen Menu Icons, the contrast, color hue, equalizer and brightness can be adjusted to suit your own preference.

– Monitor selector (See page 35.)

Once the type of TV used [Standard (Direct View TV), CRT Projector, LCD Projector, Projection TV] has been selected when the initial setting operations are performed, the optimum picture quality for the type of TV concerned will be automatically selected.

■ High sound quality

● 96 kHz/24 bit audio D/A converter

This player enables 96 kHz/24 bit linear PCM signals, the highest specifications in DVD standards, to be reproduced faithfully. To support 96 kHz sampling/24 bit sound, the shaping noise of this multi-level digital sigma type D/A converter is kept flat up to 44 kHz, thus preventing the audio signals from being affected in any way. This means sound is reproduced faithfully.

● Virtual battery operation power supply circuit

By radically cutting down the amount of noise from the power supply and digital circuits and delivering a clean supply of power free from undesirable signal components (noise, ripple components, etc.), this feature gives the bass range a tangible depth and yields a clear resolution in the midrange and treble ranges.

● Advanced Dolby Digital (AC-3)/dts (digital theater systems) 5.1ch surround decoder (See pages 10 and 37.)

The advanced Dolby Digital (AC-3)/dts 5.1ch surround decoder incorporated in this player comes with speaker mode settings which support the low-range reproduction capability of the speakers, speaker level settings, delay time adjustment*, audio dynamic range suppression, and other features.

*Delay time adjustment is effective only for Dolby Digital DVDs (center and surround channels).

● Dolby Digital (AC-3)/dts (digital theater systems) digital output (See page 12.)

By connecting a Dolby Digital/dts decoder or an amplifier incorporating a Dolby Digital/dts decoder, you can enjoy high quality digital surround sound from Dolby Digital/dts discs.

■ Advanced Virtual Surround Sound (VSS) function (See page 28.)

Even when two front speakers are being used, simply press the VSS (Virtual Surround Sound) button during playback of a Dolby Digital DVD (2 channel or over) to provide a rear surround effect. This effect also works while listening with headphones connected to an amplifier or other equipment. (This does not work with Karaoke DVDs. The effect depends on the kind of DVD used.)

■ Dialogue Enhancer (See pages 15 and 21.)

During playback of Dolby Digital/dts DVDs (2 channel or over) with the dialogue contained in the center channel, this function will boost the sound level of the center channel so that it is easier to hear the dialogue on movie software.

■ On-Screen Menu Icons (See page 18.)

By simply pressing the DISPLAY button on the remote control, information on the DVD/Video CD/CD player and disc can be displayed on the TV screen for easy identification. The player's operations and settings can be easily accessed by operating the joystick on the remote control while monitoring the TV screen. The color and position of the On-Screen Menu Icons can be changed.

■ Marker function (See page 23.)

This player can store a maximum of 5 positions in memory for convenient access.

■ Versatile DVD features

● Multi-audio function (See page 26.)

The audio soundtrack can be heard in up to 8 languages. (The number of languages depends on the software.)

● Multi-subtitle function (See page 27.)

Subtitles may be displayed in one of 32 languages. (The number of languages depends on the software.)

● Multi-angle function (See page 27.)

This function allows you to choose the camera angle of scenes shot from different angles. (Limited to DVDs recorded with multiple camera angles.)

● Parental lock function (See page 31.)

This function can prevent playback of DVD software which may be unsuitable for some audiences (especially for children). (Limited to DVDs encoded with specific rating level.)

■ Disc formats supported by this player

The player can playback discs bearing any of the following marks:



DVD

[3" (8 cm) disc/
5" (12 cm) disc]



Video CD

[3" (8 cm) disc/
5" (12 cm) disc]



CD

[3" (8 cm) disc/
5" (12 cm) disc]

■ Discs which cannot be played with this player

● DVD with Region No. other than "1" or "ALL"

- | | | |
|-----------------|---------|-------------------|
| ● PAL discs | ● VSD | ● DVD+RW |
| ● DVD-ROM | ● CDV | ● CVD |
| ● DVD-R/DVD-RAM | ● CD-G | ● SVCD |
| ● CD-ROM | ● CD-RW | ● Divx Video Disc |

etc.

● Do not try to play Photo CD or CD-R.

(Data on the disc may be damaged.)

■ Region Management Information

This player is designed to respond to the Region Management Information recorded on DVDs. The region number of this player is "1". If the region number described on the DVD does not correspond to the region number of this player, this player cannot play this disc. This player will play DVDs made for "ALL" regions.

This player will play DVDs marked with labels containing the region number "1" or "ALL":

Example:



Table of contents

Getting Started

Safety information	2
Precautions	3
Accessories	3
Features	4
Control reference guide	6
•Player	6
•Remote control	6
Front panel FL (Fluorescent Light) display	7
Basic connection	8
•Connecting to a TV set with video input connector or S video input connector	8
•Connecting to a TV set or monitor with component video input connectors	9
Optional audio connections	9
•Connecting to audio equipment	9
•Connecting to an AV amplifier with 5.1ch input connectors supporting Dolby Digital (AC-3) or dts (digital theater systems)	10
•Enjoying digital audio output from the digital audio output connector	11
•Connecting to a decoder with Dolby Digital (AC-3) or dts (digital theater systems) processing	12
Remote control preparations	13
•Battery installation	13
•Remote control operation range	13

Basic Operations

Basic play	14
•Before enjoying DVD/Video CD/CD	14
•Basic play	14
•Stopping play	15
Skipping chapters or tracks	16
Still picture (Pause)	16
Rapid advance (Rapid reverse)	17
Frame advance (Frame reverse) [DVD/Video CD]	17
Slow-motion play [DVD/Video CD]	17
Canceling playback control [Video CD]	17

Operations Using On-Screen Menu Icons

General information about On-Screen Menu Icons	18
•Common procedures	18
Detailed descriptions of On-Screen Menu Icons	19
•Screen for disc information (For DVD)	19
•Screen for disc information (For Video CD/CD)	20
•Screen for player information	21
•Shuttle screen	21

Advanced Operations

Repeat play	22
•Repeat viewing (listening)	22
•Repeating sections between two specific points (A-B repeat)	23
Storing markers in memory to be viewed (listened to) again	23
•Storing a marker in the memory	23
•Recalling/clearing a marker	23
Program play [Video CD/CD]	24
Random play [Video CD/CD]	25
Changing audio soundtrack language [DVD]	26
Switching vocals ON or OFF for Karaoke discs [DVD/Video CD]	26
Changing subtitle language [DVD]	27
Viewing from another angle [DVD]	27
Reproducing an Advanced Virtual Surround Sound (VSS) effect [Dolby Digital (AC-3) DVD (2 channel or over)]	28
Using a title menu [DVD]	29
Using a DVD menu [DVD]	29

Initial Settings

Initial settings	30
•Common procedures	30
•Selecting disc languages [DVD]	31
•Selecting rating level [DVD]	31
•Selecting On-Screen Display menu language	33
•Selecting On-Screen Display format	33
•Selecting FL display brightness	34
•Selecting TV screen type	35
•Selecting digital output	35
•Speaker setting	37
•Other settings	39
Language code list	41
How images appear on your TV (aspect ratios of the screen)	42

For Your Reference

Using the remote control with your TV set	43
Troubleshooting	44
•Self-diagnosis display function	46
Disc handling	47
Maintenance	47
Specifications	48

Control reference guide

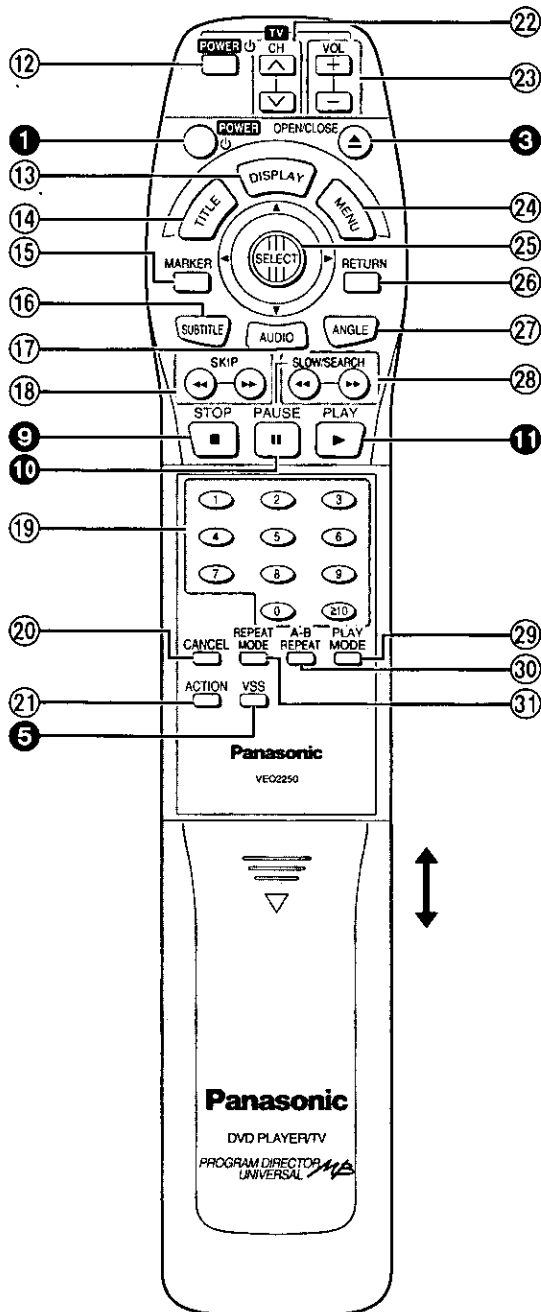
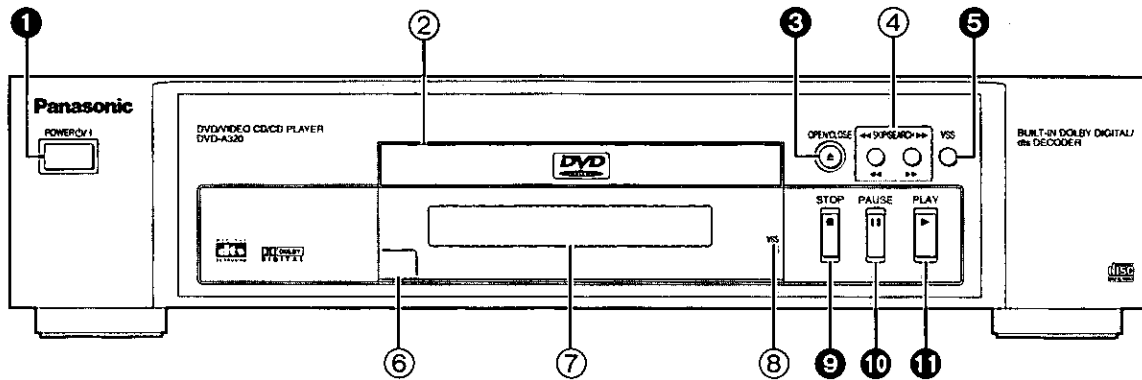

Player

Page

1 POWER button (⏻/⏷)	14
Press to switch the player from on to standby mode or vice versa. In standby mode, the player is still consuming a small amount of power.	
2 Disc tray	14
3 OPEN/CLOSE button (⏏)	14
4 SKIP/SEARCH buttons (⏮, ⏭/⏪, ⏩)	16, 17
5 VSS (Virtual Surround Sound) button	28
6 Remote control signal sensor	13
7 FL Display	7
8 VSS indicator	28
9 STOP button (■)	15
10 PAUSE button (⏸)	16
11 PLAY button (▶)	14

Remote control

Page

12 TV POWER button (⏻)	43
13 DISPLAY button	18
14 TITLE button	29
15 MARKER button	23
16 SUBTITLE button	27
17 AUDIO button	26
18 SKIP buttons (⏮, ⏭)	16
19 Numeric buttons	15
•To select a 2-digit number	
Example: To select track 23	
Press "≧10", "2" and then "3".	
20 CANCEL button	23, 25
21 ACTION button	30
22 TV CH buttons (⏶, ⏷)	43
23 TV VOL buttons (+, -)	43
24 MENU button	29
25 Joystick/SELECT button	15
26 RETURN button	15, 30
27 ANGLE button	27
28 SLOW/SEARCH buttons (⏮, ⏭)	17
29 PLAY MODE button	24, 25
30 A-B REPEAT button	23
31 REPEAT MODE button	22

Buttons such as **1** function in exactly the same way as the buttons on the player.

Front panel FL (Fluorescent Light) display

- ①  Rotates during play.
Rotates fast clockwise or counterclockwise during rapid advance (reverse). (See page 17.)
Rotates slowly clockwise or counterclockwise during slow-motion play.
[DVD/Video CD] (See page 17.)



Illuminates in the stop mode.

- ② Illuminates during playback.
Flashes when the RESUME function is ON.
(See page 15.)
- ③ Illuminates during repeat play. (See page 22.)
- ④ Illuminates in the still picture (pause) mode.
(See page 16.)
- ⑤ Title/chapter number [DVD]
Track number [Video CD/CD]
- ⑥ Elapsed playing time from the start of the title/track during play
- ⑦ Audio channel information recorded in the disc being played back (e.g. 2ch or 5.1ch)

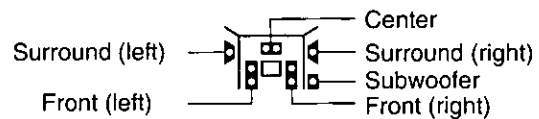

- ⑧ A DVD is loaded.
- ⑨ It is possible to switch the angle.
[DVD] (See page 27.)
- ⑩ Illuminates during program play. [Video CD/CD]
(See page 24.)
- ⑪ Linear PCM of 96 kHz sampling is being played.
- ⑫ Linear PCM of 24 bit is being played.
- ⑬ The disc tray is open.
- ⑭ The disc tray is being closed (retracted).
- ⑮ Display during play of a DVD
- ⑯ Display during play of an interactive DVD*
- ⑰ Display during play of a Karaoke DVD
- ⑱ Display during play of an interactive Karaoke DVD*
- ⑲ Display during play of a Video CD
- ⑳ Display during play of a Video CD with playback control
- ㉑ Display during play of a CD
- ㉒ Display when selecting tracks for program play.
[Video CD/CD] (See page 25.)
- ㉓ Scrolls after a dts CD is detected (total number of tracks and total playing time displayed when finished scrolling).
- ㉔ Playback is impossible.
 - DVD for which playback is prohibited by the initial settings "2 Ratings". (See page 31.)
 - DVD with Region No. other than "1" or "ALL".
(See page 4.)
 - PAL discs
- ㉕ No disc is loaded.

*An interactive DVD is DVD software which includes multiple angles, multiple plot endings, etc.

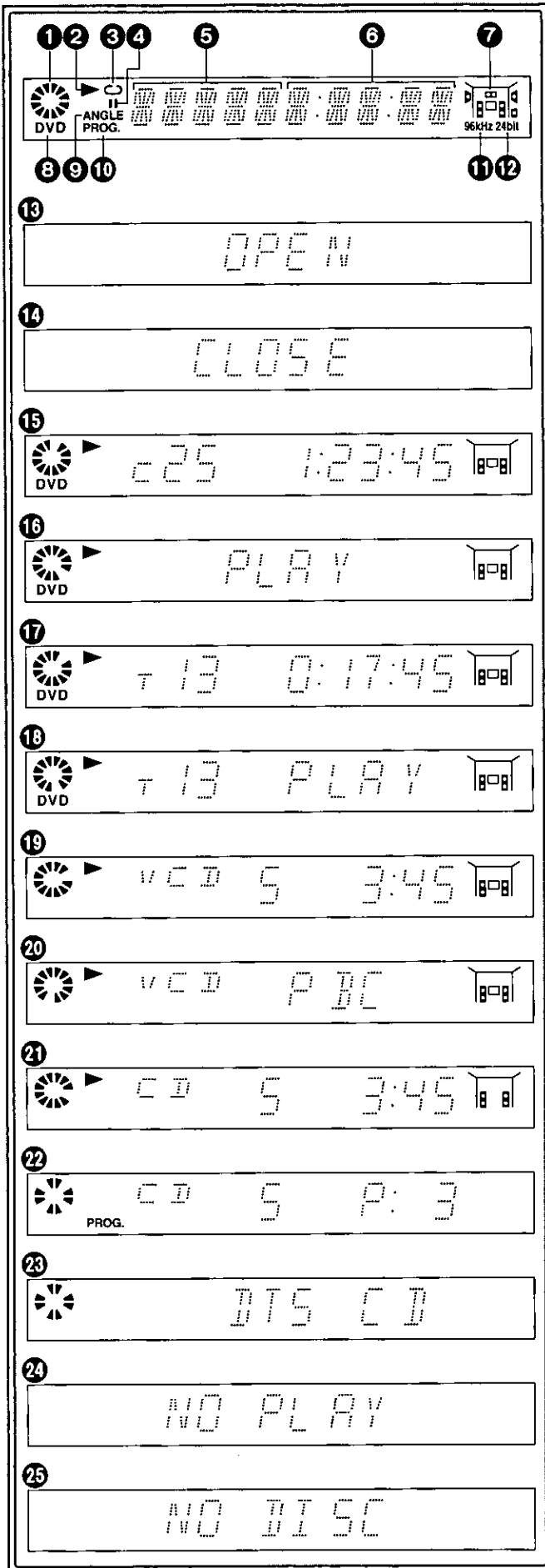

Basic connection

- Ensure that this player and other equipment to be connected are set to the standby mode or off and disconnect the AC cord before commencing connection.
- Do not block ventilation holes of any of the equipment and arrange them so that air can circulate freely.
- Read through the instructions before connecting other equipment.
- Ensure that you observe the color coding when connecting audio and video cables.
- Select the appropriate screen type at the initial setting "6 TV Aspect" according to your TV set [4:3/16:9 and Standard (Direct View TV)/CRT Projector/LCD Projector/Projection TV]. (See page 35.)

Note

- Peripheral equipment and optional cables sold separately unless otherwise indicated.
- During DVD play, the TV volume may be at a lower level than during TV broadcasts, etc. If this is the case, adjust the volume to the desired level.

Connect Your DVD/Video CD/CD Player Directly To Your TV Set.

If the DVD/Video CD/CD player is connected to the TV through a video cassette recorder, the picture may not be played back correctly with some DVDs. So we strongly recommend you do not connect the DVD/Video CD/CD player to your video cassette recorder when setting up your home entertainment system.

Do not place the player on amplifiers or other equipment which may become hot.

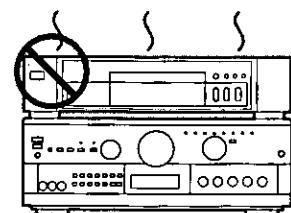

Connecting to a TV set with video input connector or S video input connector

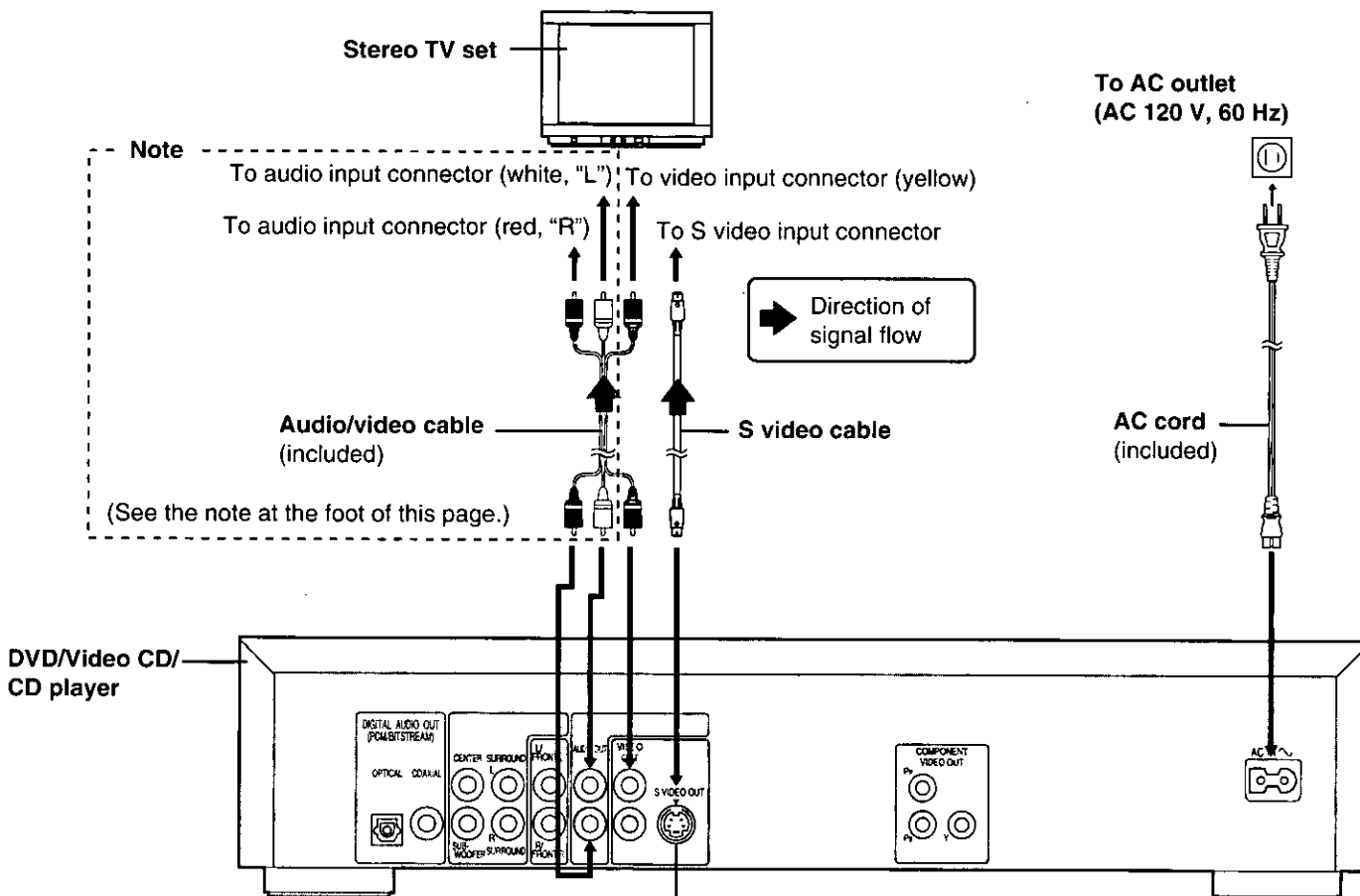

Note

To audio input connector (white, "L")
 To audio input connector (red, "R")
 To video input connector (yellow)
 To S video input connector

Direction of signal flow

Audio/video cable (included)
 S video cable

(See the note at the foot of this page.)

S video output connector

The S (separate) video output connector separates the color (C) and luminance (Y) signals before transmitting them to the TV set in order to achieve a sharper picture. Use the S video cable when connecting the player to a TV set equipped with an S video input connector for the best picture clarity possible.

Note

- If your TV is monaural, use a stereo-monaural audio cable instead of the supplied audio/video cable. The video part of the cable (yellow) can still be used if required.

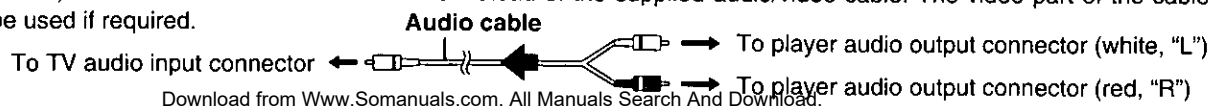

Connecting to a TV set or monitor with component video input connectors

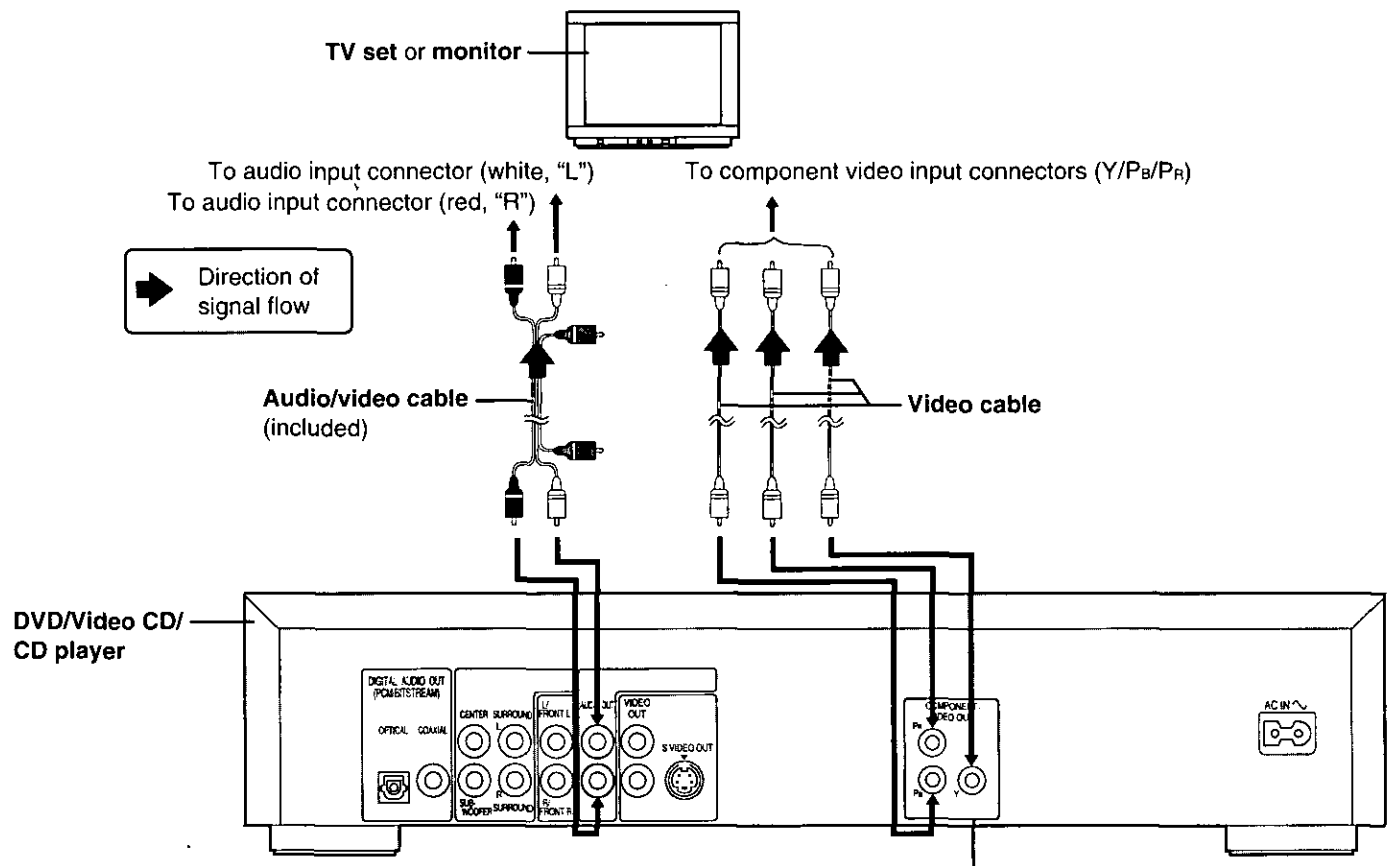

Component video output connectors (Y/P_B/P_R)
 The component video output connector outputs the color difference signals (P_B/P_R) and luminance signal (Y) separately in order to achieve high fidelity in reproducing colors.
 •The description of the component video input connectors depends on the TV set or monitor (e.g. Y/P_B/P_R, Y/B-Y/R-Y, Y/C_B/C_R and so on). Refer to the instruction manual of your TV set for details.

Optional audio connections

Connecting to audio equipment

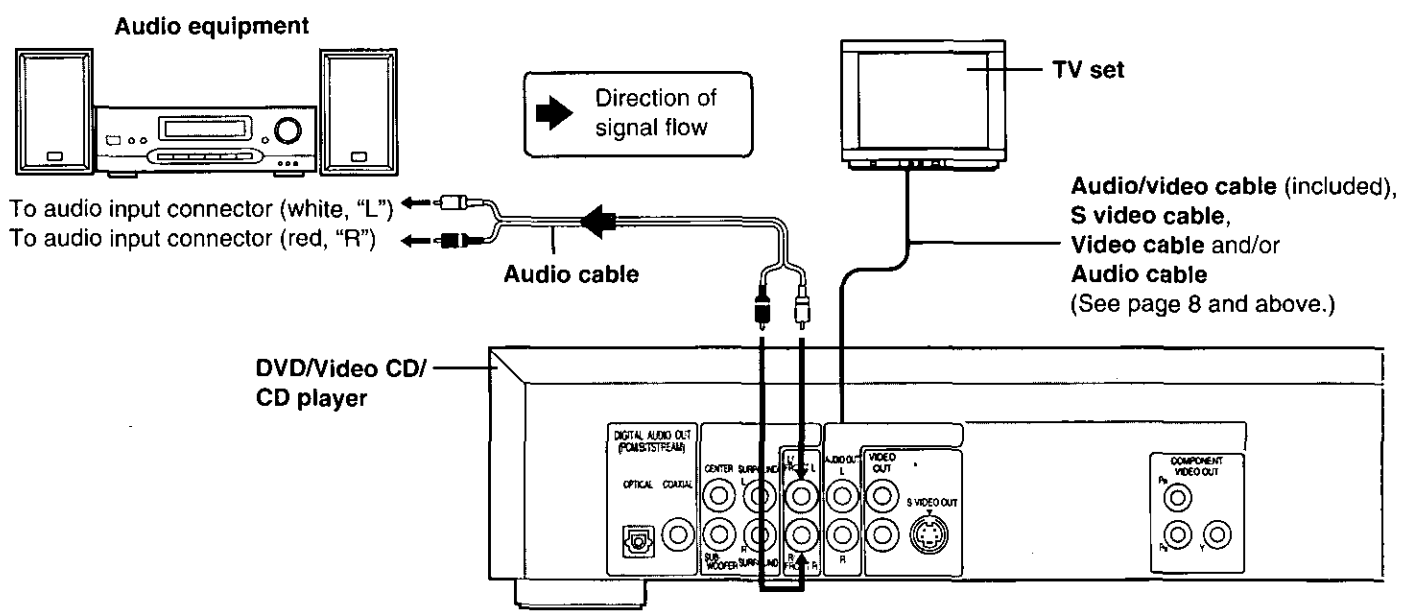

Optional audio connections

Connecting to an AV amplifier with 5.1ch input connectors supporting Dolby Digital (AC-3) or dts (digital theater systems)

This player contains a Dolby Digital (AC-3) decoder and dts decoder. This enables playback of DVDs recorded in Dolby Digital or dts without the need for an external decoder with Dolby Digital or dts processing. When the player is connected to an AV amplifier with 5.1ch input connectors, you can enjoy theater-quality audio in your own home when playing DVDs recorded in Dolby Digital or dts.

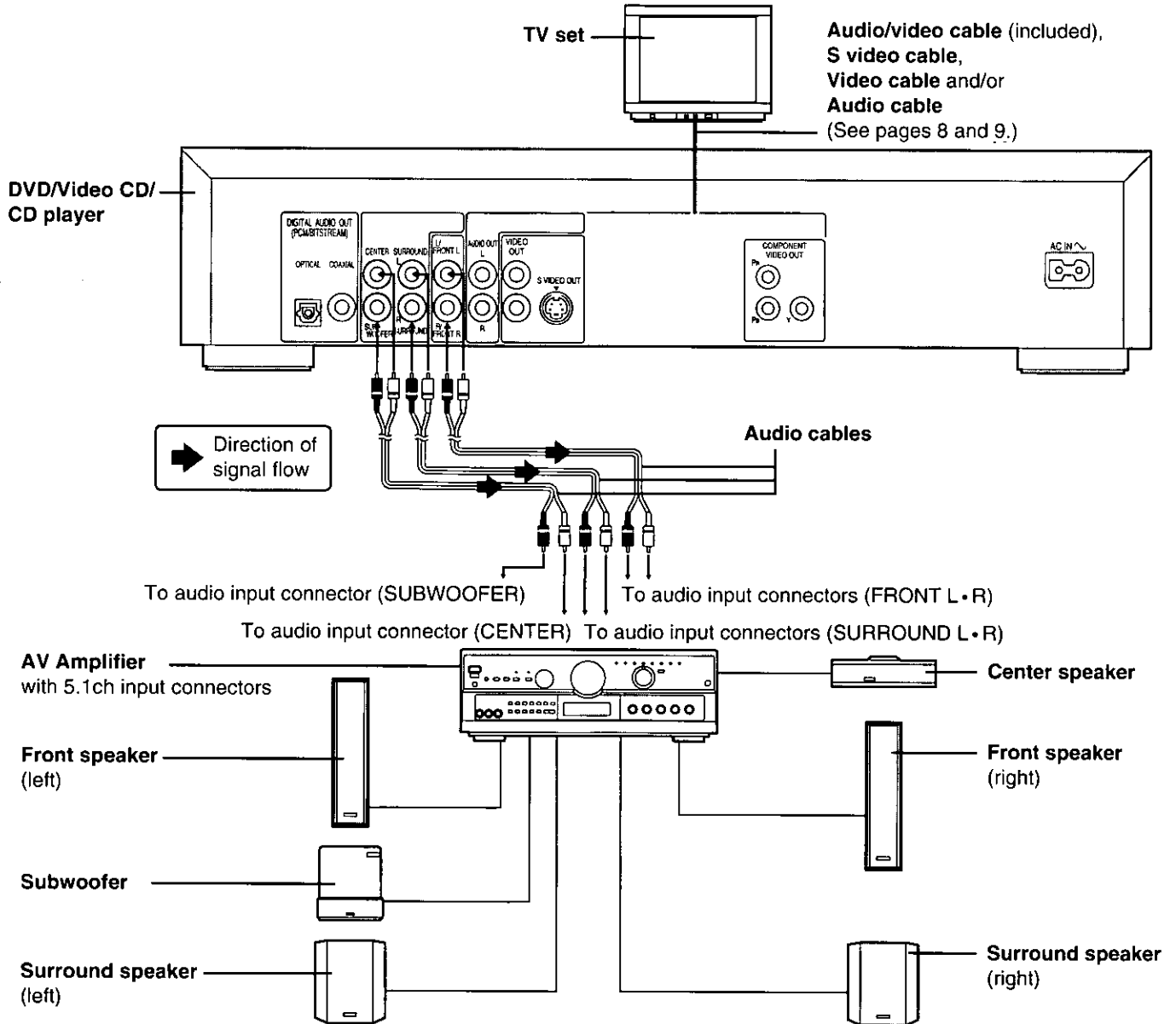

Note

- After connection is made, set the "8 Speaker Setting" (such as Yes/No and Large/Small) according to your speaker system. (See page 37.)
- Turn Virtual Surround Sound (VSS) or Headphone VSS off if you are using more than just the two front speakers (see page 28). Sound will only come from the front speakers if VSS or Headphone VSS is turned on.

For your reference:

- This player can play CDs recorded in dts. When the player is connected to an AV amplifier with 5.1ch input connectors, you can enjoy multi-channel audio of CDs recorded in dts as well as DVDs.

Enjoying digital audio output from the digital audio output connector

Note when connecting the optical digital audio cable

- Remove the dust protection cap from the optical digital audio output connector and connect the cable firmly so that the configurations of both the cable and the connector match.
- Keep the dust protection cap and reattach when not using the connector.

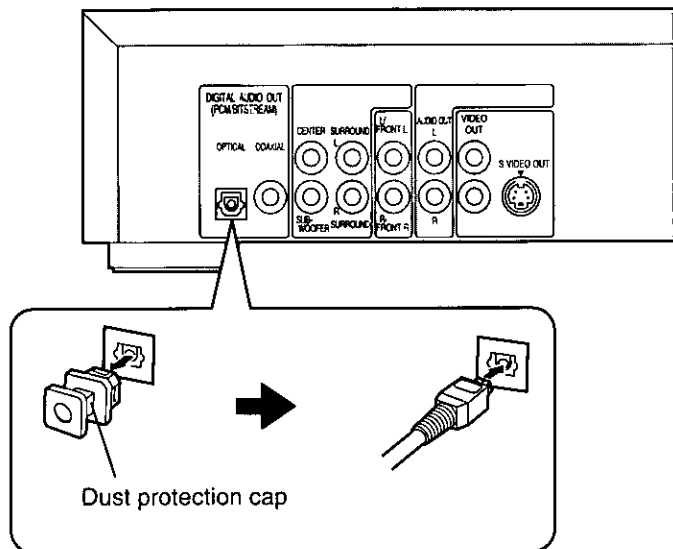

Concerning the audio output from the player's optical/coaxial digital audio output connector

Disc	Sound recording format	Optical/coaxial digital audio output from connector
DVD	Dolby Digital (AC-3)	Dolby Digital bitstream (1–5.1ch) or PCM (2ch) (48 kHz/16 bit)*1*2
	Linear PCM (48/96 kHz 16/20/24 bit)	Linear PCM (2ch) (48 kHz sampling/16 bit only) or no output*1
	dts	PCM (2ch) (48 kHz/16 bit)*2 or dts bitstream (1–5.1ch)*1
Video CD	MPEG 1	PCM (44.1 kHz sampling)*2
CD	Linear PCM	Linear PCM (44.1 kHz sampling)
	dts*3	PCM (2ch) (44.1 kHz/16 bit)*2 or dts bitstream (1–5.1ch)*1

*1The type of audio output from the connector can be selected by "7 Digital Audio Output" of the initial settings. (See page 35.)

*2Compressed sound converted to PCM will be output.

*3The settings and connections necessary to enjoy CDs recorded in dts are the same as for DVDs recorded in dts.

Note

- Some dts decoders which do not support DVD-dts interface may not work properly with the DVD/Video CD/CD player.

For your reference:

- Dolby Digital (AC-3) is a digital sound compression technique developed by the Dolby Laboratories, Inc. Supporting 5.1-channel surround sound, as well as stereo (2-channel) sound, this technique enables a large quantity of sound data to be efficiently recorded on a disc.
- The digital theater systems (dts) is a 5.1-channel surround sound system, which is widely used in movie theaters around the world. It allows the bit rate to be increased in order to provide good sound quality without excessively compressing the data.
- Linear PCM is a signal recording format used in a CD. While a CD is recorded in 44.1 kHz/16 bit, a DVD is recorded in 48 kHz/16 bit up to 96 kHz/24 bit.
- If you have a Dolby Pro Logic Surround decoder, you will obtain the full benefit of Pro Logic from the same DVD movies that provide full 5.1-channel Dolby Digital soundtracks, as well as from titles with the Dolby Surround mark.
- The digital audio output connector (optical) converts electrical signals into optical signals and transfers them to an amplifier. These optical signals are immune from electrical interference, and they also have minimal effect on other equipment.

Caution for the optical/coaxial digital audio output connector:

- When connecting an amplifier (with an optical/coaxial digital input connector) which does not contain a Dolby Digital (AC-3) or dts decoder, be sure to select "PCM" at the "2 Dolby Digital" and at the "3 dts" of the initial setting "7 Digital Audio Output". (See page 35.)
- If "Bitstream" is selected, any attempt to play DVDs (or CDs recorded in dts) may cause such a high level of noise that it may be harmful to your ears and damage your speakers.
- Video CDs and CDs can be played as normal.

Manufactured under license from Dolby Laboratories. "Dolby", "AC-3", "Pro Logic" and the double-D symbol are trademarks of Dolby Laboratories. Confidential Unpublished Works. © 1992–1997 Dolby Laboratories, Inc. All rights reserved.

Manufactured under license from Digital Theater Systems, Inc. US Pat. No. 5,451,942 and other world-wide patents issues and pending. "DTS" and "DTS Digital Surround" are trademarks of Digital Theater Systems, Inc. © 1996 Digital Theater Systems, Inc. All rights reserved.

Optional audio connections

Connecting to a decoder with Dolby Digital (AC-3) or dts (digital theater systems) processing

When DVDs recorded in Dolby Digital or dts are played, Dolby Digital bitstream or dts bitstream is output from the player's OPTICAL digital audio output connector or COAXIAL digital audio output connector. When the player is connected to a Dolby Digital decoder or dts decoder, you can enjoy theater-quality audio in your home. [An optical digital audio cable or coaxial audio cable is required when an optional Dolby Digital decoder or dts decoder is used.]

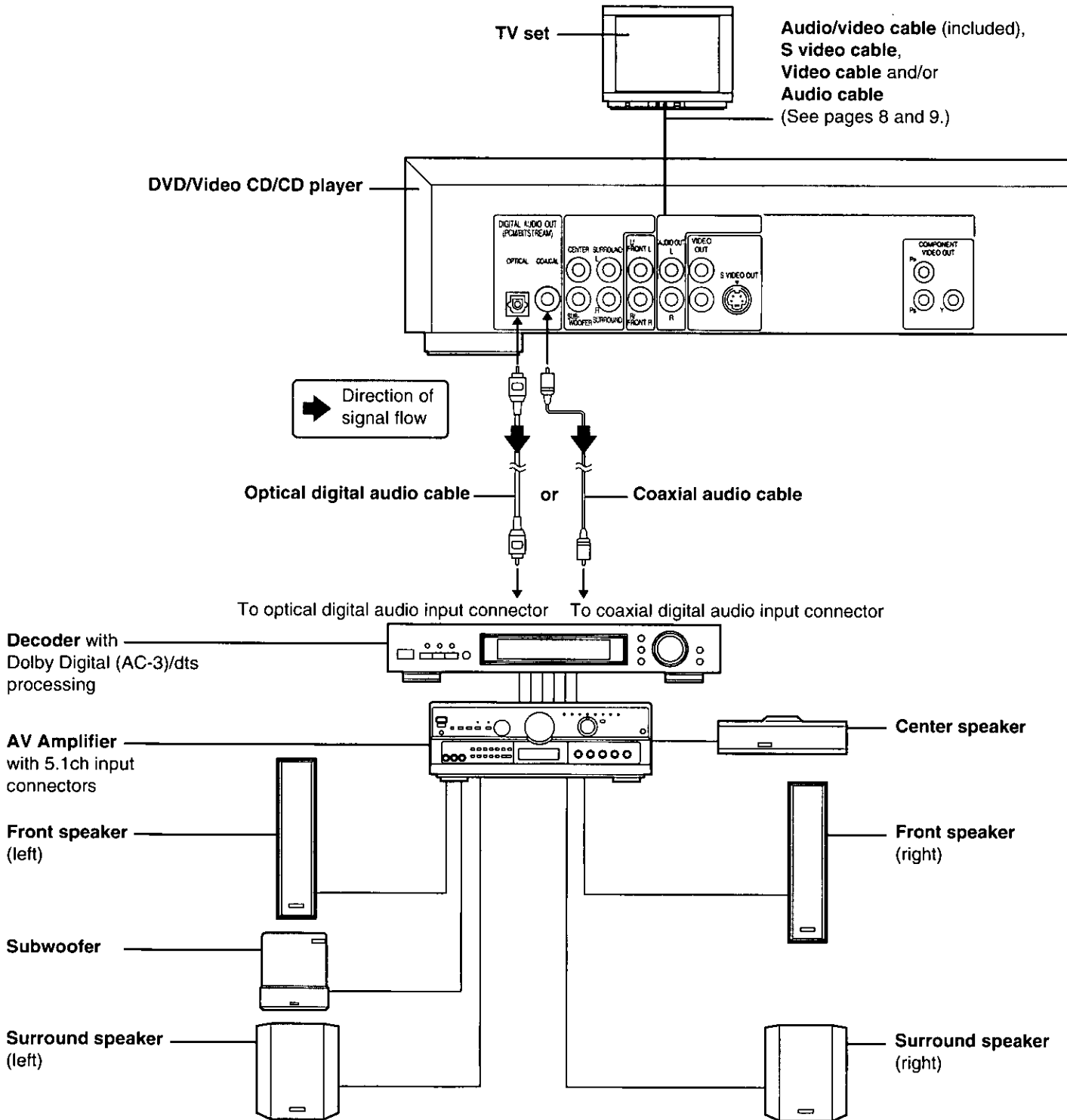

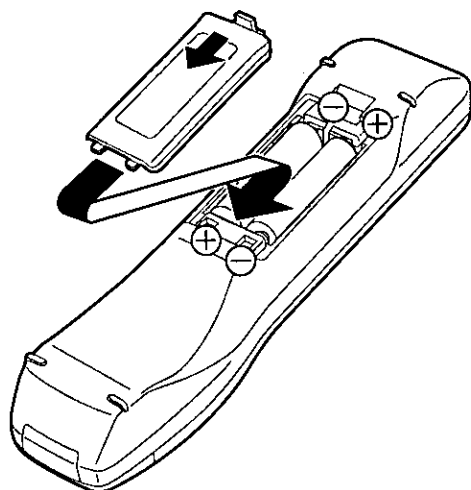
A**B**

Remote control signal sensor

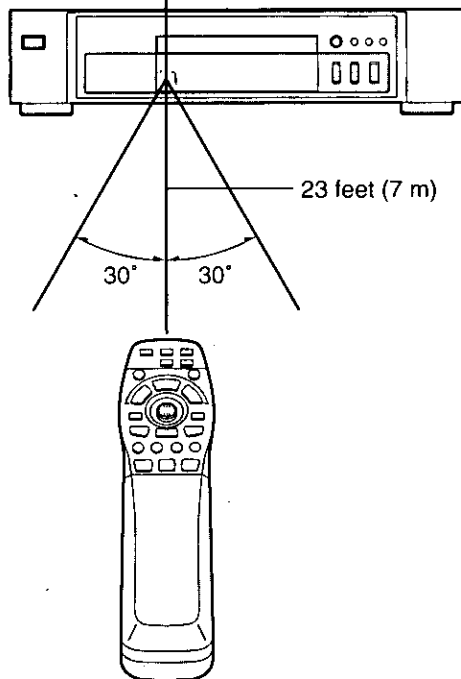

Remote control preparations

Battery installation

Insert the batteries while observing polarities (+ and -) as illustrated.

Service life of batteries

- The batteries normally last for about one year although this depends on how often, and for what operations, the remote control is used.
- If the remote control fails to work, even when it is operated near the player, replace the batteries.
- Use size "R6, AA, UM-3" batteries.

Note

- Do not use rechargeable (Ni-Cd) batteries.
- Do not attempt to charge, short-circuit, disassemble, heat or throw the batteries into a fire.
- Do not drop, step on or otherwise impact the remote control. This may damage the parts or lead to malfunction.
- Do not mix old and new batteries.
- If the remote control is not going to be used for a long time, remove the batteries. Otherwise, electrolyte may leak which may lead, not only to malfunction, but also to burns if contact is made with the electrolyte.
- Wipe away any electrolyte leaking inside the remote control, and install new batteries.
- If any electrolyte should come into contact with parts of your body, wash it off thoroughly with water.

Remote control operation range

Use the remote control within 23 feet (7 m) of the sensor. Use it within a 60° angle directly in front of the sensor.

- The distance varies with the brightness of the room.

Note

- Do not point bright lights at the sensor.
- Do not place objects between the remote control and the sensor.
- Do not use this remote control while operating the remote control of other equipment.

Basic play

Before enjoying DVD/Video CD/CD

The On-Screen menu language of your player has been factory preset to English.

You can change the menu language to French or Spanish. Refer to "Selecting On-Screen Display menu language" on page 33.

In the explanations given below it is assumed that English has been selected as the menu language.

Preparations

- Confirm that the TV set or the audio equipment (if connected) is properly connected to the player.
- Confirm that the power for the TV set or the audio equipment (if connected) is turned on.
- Confirm that the input setting for the TV set or the audio equipment (if connected) is properly selected. (Example: Select "VCR 2" on the TV set if this player has been connected to TV input connector [2].)

Basic play

1 Press **POWER** to switch on the power.

2 Press **OPEN/CLOSE** to open the disc tray.

Open

3 Place the disc on the disc tray with the label side to be played facing upwards. (If the disc has a label)

Hold the disc without touching either of its surfaces, position it with the label side to be played facing upwards, align it with the guides, and place it in position.

- a** 3" (8 cm) disc
- b** 5" (12 cm) disc

4 Press **PLAY**.

Close

Reading

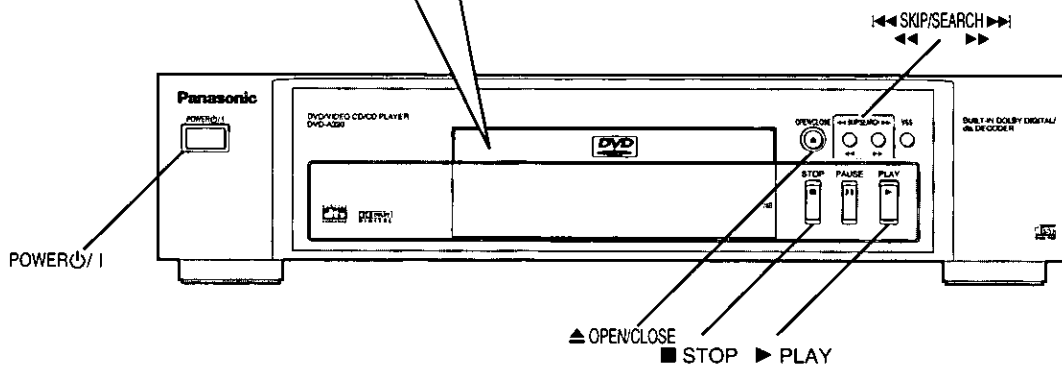
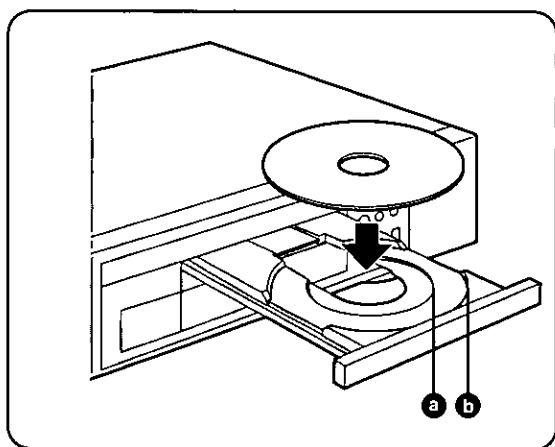
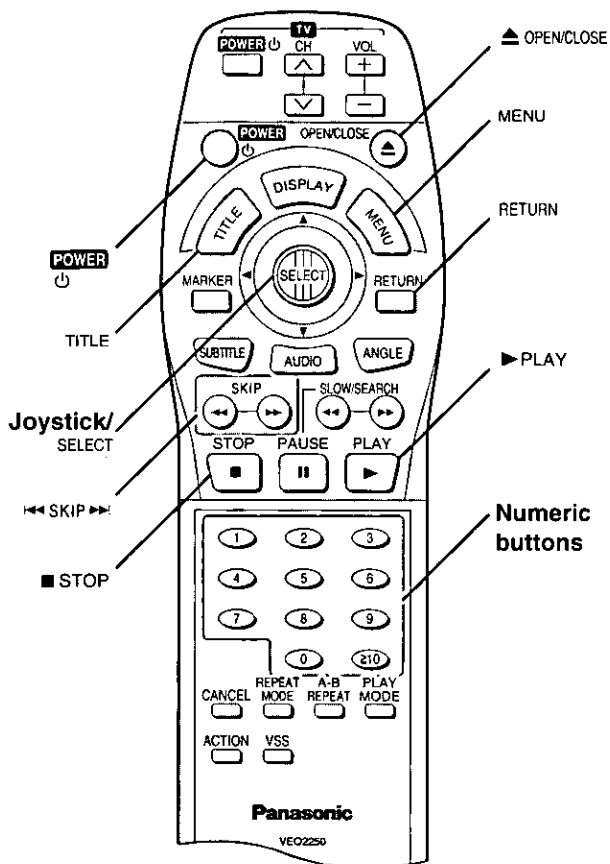

The disc tray is automatically closed and play begins.

•When the disc tray is closed by pressing OPEN/CLOSE, press PLAY to start play.

•**When a menu screen appears on the TV monitor**

In the case of many movie DVDs, an interactive DVD or Video CD with playback control, a menu screen appears on the TV monitor. Perform step 5 to start play.

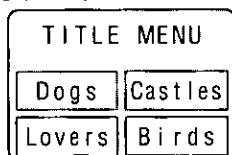

(Example of DVD)

5 Tilt the joystick (▲, ▼, ◀, ▶) and press SELECT, or press the numeric buttons, to select the item.

•The joystick is not effective for selecting items for Video CDs.

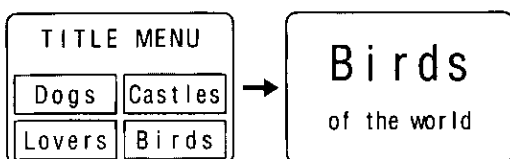

(Example)

Play of the selected item now begins.

While watching movies

•**Adjusting picture quality for movie viewing**

Using the On-Screen Menu Icons (for player information) will select the optimum picture quality for movies. This setting gives a gentler feel to videos, producing more detail in darker scenes and helping to reduce noise. (See page 21.)

•**Raising dialogue volume**

The volume for the dialogue can be raised by displaying the On-Screen Menu Icons (for player information) and setting "Dialogue Enhancer" to "ON". (See page 21.)

This setting takes effect only for discs which are recorded with Dolby Digital (AC-3)/dts (2 channel or over) and with the dialogue contained in the center channel.

When the menu continues onto another screen

After step 4 on page 14, press SKIP (▶▶) [in case of the player, SKIP/SEARCH (▶▶/▶▶)].

•To return to the previous menu screen

Press SKIP (◀◀) [in case of the player, SKIP/SEARCH (◀◀/◀◀)].

•Due to the design of some software titles, SKIP (◀◀, ▶▶) or SKIP/SEARCH (◀◀, ▶▶/◀◀, ▶▶) may not always work. For operation, refer also to the jacket of the disc concerned.

Stopping play and returning to the menu screen

Press TITLE, MENU or RETURN (for DVD), or RETURN (for Video CD).

Play is suspended, and the menu screen is displayed.

•The buttons may not work depending on the disc used.

After operation

When the player is not in use, remove the disc and press POWER to set the player to the standby mode.

The player is automatically set to the standby mode after 30 minutes or so have elapsed in the stop mode.

(Auto power-off function)

What is playback control?

If a Video CD has "playback control" written on its disc or jacket, it means that particular scenes or information can be selected for viewing interactively with the TV monitor using the menu screen.

Note

•The disc continues to rotate while the menu is displayed even after the player has finished playing a particular item. When no further selections are to be played, be sure to press STOP to clear the menu display.

•If the disc is put in upside down (and it is a single sided disc), the FL display will indicate "NO PLAY".

For your reference:

•When ⊘ appears on the TV monitor when a button is pressed, the operation is prohibited by the player or disc.

Stopping play

Press STOP during play.

RESUME function

The player records the point where STOP was pressed during play. "▶" flashes on the player's FL display when this function is activated.

•Press PLAY again while "▶" is flashing, and play will resume from this point.

•When the tray is opened or STOP is pressed again while "▶" is flashing, the RESUME function will be cleared.

The RESUME function works only with titles for which the elapsed playing time appears on the player's FL display during playback.

This feature remains active if the player is set to the standby mode and then turned back ON.

Chapter preview function (DVD only)

When PLAY is pressed while "▶" is flashing, the message shown on the right is briefly displayed.

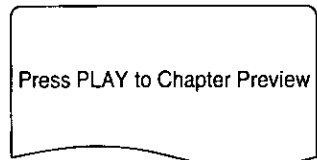

If PLAY is pressed again while the above message is displayed on the screen, the first few seconds of each chapter from the beginning of the title up to the point where operation was stopped will be played. This makes it possible to review previous chapters. Normal playback will commence from the point where operation was stopped.

Note

•Canceling the RESUME function will also clear the chapter preview function.

•The chapter preview function may not work with some DVDs.

Skipping chapters or tracks

With the remote control

Press **SKIP** (◀◀, ▶▶) during play.



Reverse Forward

On the player

Press **SKIP/SEARCH** (◀◀, ▶▶/◀◀, ▶▶) during play.



Reverse Forward

For your reference:

- A chapter (DVD) or a track (Video CD/CD) is skipped each time the button is pressed.
- When SKIP (◀◀) [in case of the player, SKIP/SEARCH (◀◀/◀◀)] is pressed once midway through a chapter/track, play returns to the start of that chapter/track. When it is pressed again, a chapter/track is skipped each time the button is pressed.
- When SKIP (◀◀, ▶▶) [in case of the player, SKIP/SEARCH (◀◀, ▶▶/◀◀, ▶▶)] is pressed during menu play of Video CDs with playback control, a menu screen may sometimes be recalled.

Still picture (Pause)

Press **PAUSE** during play.

- DVD/Video CD: The player will be placed in the still picture mode.
- CD: The player will be placed in the pause mode.
- Normal play is resumed when PLAY is pressed.

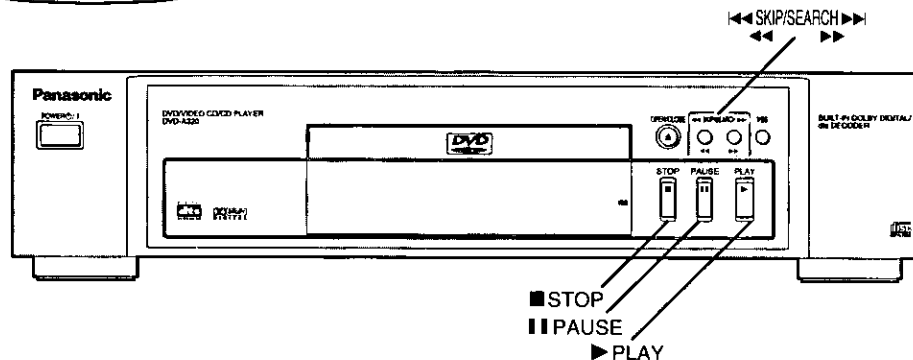
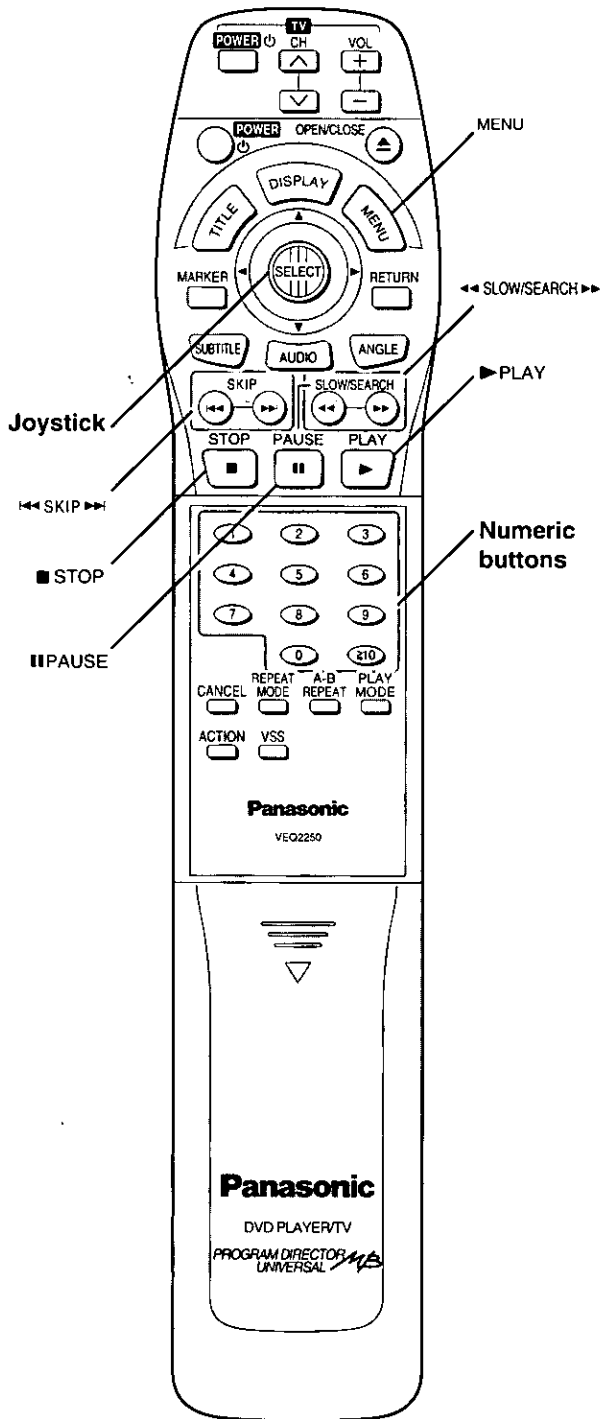

Rapid advance (Rapid reverse)

With the remote control

Press **SLOW/SEARCH** (◀◀, ▶▶) during play.

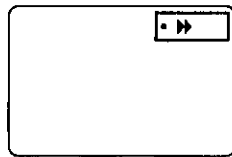
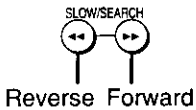

(Example)

- The speed of advance (reverse) is relatively slow at first. When the button is pressed again, the speed increases up to 5 steps.

On the player

Press and hold **SKIP/SEARCH** (|◀◀, ▶▶|/◀◀, ▶▶) during play.



- The speed is maintained even after the button is released.

- Normal play is resumed when **PLAY** is pressed.

For your reference:

- When **SLOW/SEARCH** (◀◀, ▶▶) or **SKIP/SEARCH** (|◀◀, ▶▶|/◀◀, ▶▶) is used during menu play of Video CDs with playback control, a menu screen may sometimes be recalled.
- For DVDs and Video CDs, audio will be heard during scanning (forward direction only) at the initial scan speed. (See page 39.) For CDs, audio will be heard during scanning at every scan speed (1 to 5). (For dts CDs, audio will not be heard at any speed.)

Frame advance (Frame reverse)

[DVD/Video CD]

Tilt the joystick (◀, ▶) in the still picture mode.

(See page 16.)

- ◀: Reverse
- ▶: Forward
- The disc is advanced (reversed) by one frame each time the joystick (◀, ▶) is tilted.
- When the joystick (◀, ▶) is kept tilted, consecutive frame advance (reverse) works.
- Normal play is resumed when **PLAY** is pressed.

Note

- For Video CDs, frame reverse is not possible.

For your reference:

- Pressing **PAUSE** also activates frame advance.
- Whether the pictures are advanced by a "Frame" or "Field" is automatic. (See page 39.)

Slow-motion play [DVD/Video CD]

With the remote control

Press **SLOW/SEARCH** (◀◀, ▶▶) in the still picture mode. (See page 16.)

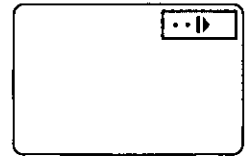
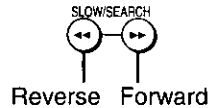

(Example)

- The speed of slow-motion is slow at first. When the button is pressed again, the speed increases up to 5 steps.

On the player

Press and hold **SKIP/SEARCH** (|◀◀, ▶▶|/◀◀, ▶▶) in the still picture mode. (See page 16.)

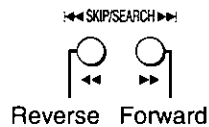

- The speed is maintained even after the button is released.

- Normal play is resumed when **PLAY** is pressed.

Note

- For Video CDs, slow-motion playback in reverse direction is not possible.

Canceling playback control

[Video CD]

1. Press **STOP** after the menu screen appears (after step 4 on page 14). ("PBC" will be cleared from the player's FL display.)
2. Press the numeric buttons to select a track. (Play begins.)
 - Refer to the jacket etc. of the disc concerned for the track numbers.
 - Press "1" to start play from the beginning of the disc.

To return to menu play

Press **STOP** to stop playback and press **MENU**.

("PBC" will light up on the player's FL display and the menu screen is resumed.)

Perform step 5 on page 15.

General information about On-Screen Menu Icons

This player features On-Screen Menu Icons providing various functions. A "banner" will be displayed on the TV when DISPLAY button on the remote control is pressed.

Operating the joystick/SELECT button on the remote control will show disc information (title/chapter/track number, elapsed playing time, audio/subtitle language, and angle) and player information (repeat play, play mode, marker, picture mode, Virtual Surround Sound, master volume, etc.).

Some icons allow the settings to be changed.

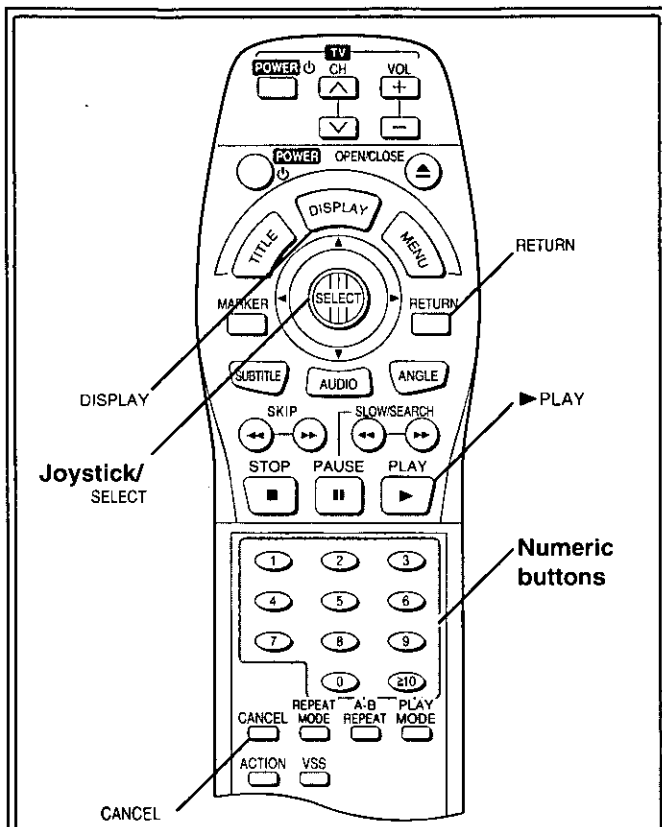

Common procedures

1 Press DISPLAY during play or in the stop mode.

Each time this button is pressed, the TV monitor changes as shown below.

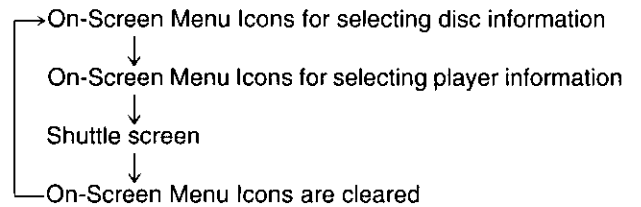

• Some functions cannot be accessed from the stop mode.

2 Tilt the joystick (◀, ▶) to select the item.

• The currently selected item is indicated by the yellow frame on the On-Screen Menu Icons.

3 Tilt the joystick (▲, ▼) to select the setting.

• For some functions, the setting will be registered immediately; for others, SELECT or PLAY must be pressed.

• When numbers are displayed (e.g. title No.), the numeric buttons are also effective for setting instead of the joystick (▲, ▼). When numbers are entered with numeric buttons, press SELECT to register the setting.

Press RETURN or CANCEL to clear the On-Screen Menu Icons.

Examples of On-Screen Menu Icons

See **A**, **B** and **C** for detailed illustration.

The screens depend on the disc contents.

For your reference:

• The On-Screen Menu Icons may not be displayed when playing some kinds of DVD software, or if the television's automatic picture zoom function is on.

If this is the case, change the position of the icons in "4 On-Screen Messages". (See page 33.)

• The color (blue, violet or green) of the On-Screen Menu Icons can be changed. (See page 33.)

A DVD

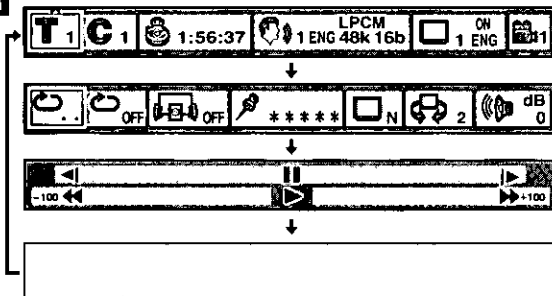

B Video CD

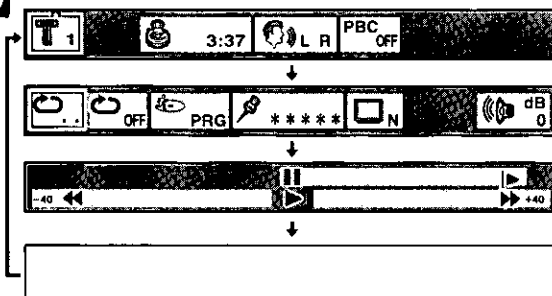

C CD

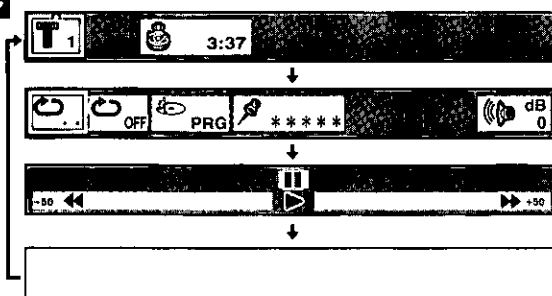

Detailed descriptions of On-Screen Menu Icons

Screen for disc information (For DVD)

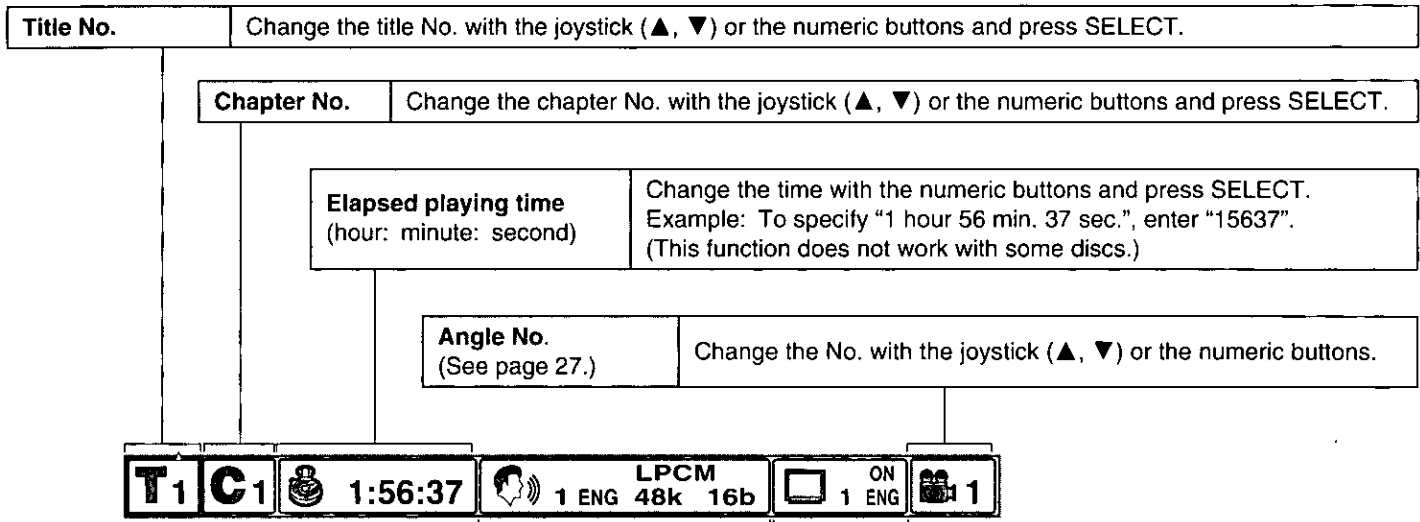

Audio soundtrack language No. (See page 26.)		Change the No. with the joystick (▲, ▼) or the numeric buttons.		
Audio soundtrack language		ENG: English POR: Portuguese FRA: French RUS: Russian DEU: German JPN: Japanese ITA: Italian CHI: Chinese ESP: Spanish KOR: Korean NLD: Dutch MAL: Malay SVE: Swedish VIE: Vietnamese NOR: Norwegian THA: Thai DAN: Danish *: Others		
Audio attribute	LPCM	96k or 48k	16b 20b 24b Linear PCM ("k" stands for kHz and "b" stands for bit.)	
	Digital	1ch-3/2.1ch*	Dolby Digital (AC-3)	
	DTS	1ch-3/2.1ch*	dts	
	Vocal	--- (OFF)	ON	DVD Karaoke (Solo)
		--- (OFF)	V1+V2 V1 V2	DVD Karaoke (Duet)

Subtitle language No. (See page 27.)	Change the No. with the joystick (▲, ▼) or the numeric buttons.	
Subtitle language	ENG: English POR: Portuguese FRA: French RUS: Russian DEU: German JPN: Japanese ITA: Italian CHI: Chinese ESP: Spanish KOR: Korean NLD: Dutch MAL: Malay SVE: Swedish VIE: Vietnamese NOR: Norwegian THA: Thai DAN: Danish *: Others	
Subtitle on/off	Select "ON" or "OFF" with the joystick (▲, ▼).	
	OFF	Subtitles cleared.
	ON	Subtitles displayed.

※The display on the On-Screen Menu Icons indicates the number of channels recorded on the disc.

Example:
3/2.1ch

0: No low frequency effect (for subwoofer)
.1: Low frequency effect (for subwoofer)

0: No surround
1: Mono surround
2: Stereo surround (left/right)

1: Center
2: Front left+Front right
3: Front left+Front right+Center

For your reference:

•"▲ ▼" around the icon means that the item can be changed with the joystick (▲, ▼).



Screen for disc information (For Video CD/CD)

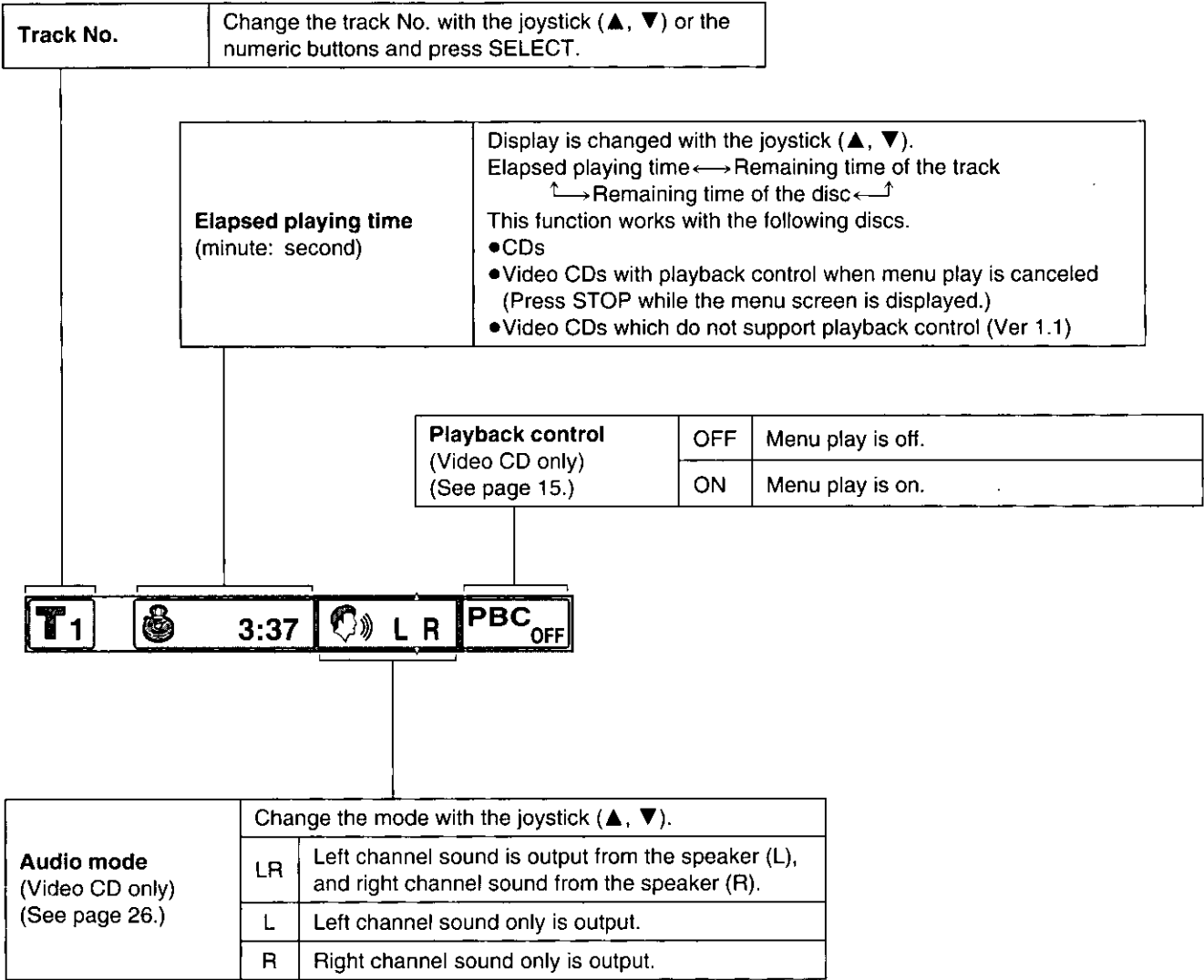

Note

- Track No. and the elapsed playing time are not displayed during menu play of Video CDs with playback control.
- It is not possible to turn playback control ON or OFF using the On-Screen Menu Icons.

For your reference:

- "▲ ▼" around the icon means that the item can be changed with the joystick (▲ ▼).



Screen for player information

A-B repeat play (See page 23.)

Press SELECT during play to store location A and press SELECT again to store location B. Repeat play between the two locations starts. Press SELECT again to return to normal play.

Repeat play (See page 22.)

Select the mode during play with the joystick (▲, ▼).

OFF	Normal play	DVD
C	Chapter repeat play	
T	Title repeat play	
OFF	Normal play	Video CD/ CD
T	Track repeat play	
A	Disc repeat play	

Marker (See page 23.)

Press SELECT during play and press SELECT again at the preferred point to store a marker. (Marker no. replaces “*”.)

- To recall a marker, select the marker no. with the joystick (◀, ▶) and enter the selection with the joystick (▲).
- To clear a marker, select the marker no. with the joystick (◀, ▶) and press CANCEL.

•DVD Dialogue Enhancer (See page 15.)



Select the mode during play with the joystick (▲, ▼).

OFF	Normal volume
ON	Louder volume

•Video CD/CD Play mode (See pages 24 and 25.)



PRG	Program play
RND	Random play
---	Normal play

Virtual Surround Sound (VSS) (Dolby Digital DVD only) (See page 28.)

Select the mode during play with the joystick (▲, ▼).



VSS



Headphone VSS

Select the level during play with the joystick (▲, ▼).

OFF	VSS off
1	VSS natural effect
2	VSS emphasized effect

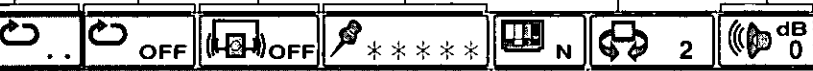

Master volume

Adjust the master volume with the joystick (▲, ▼).
0 to -127 dB or -∞

Digital picture mode

Select the mode during play with the joystick (▲, ▼).

N	Normal mode	F	Fine mode
S	Soft mode	C	Cinema mode

User selection mode (Adjust the picture quality as you like.)
When “U” is selected and SELECT is pressed, the icons as shown below appear.



Contrast (+7 to -7) Color Hue (+7 to -7) Equalizer (+1/0/-1) Brightness (0 to 15)
Select the item with the joystick (◀, ▶) and select the value with the joystick (▲, ▼).

Note

- Repeat play and marker functions do not work with an interactive DVD or during menu play of a Video CD with playback control.
- A-B repeat play does not work with an interactive DVD.
- It is not possible to change the play mode using the On-Screen Menu Icons.
- The master volume can be set and stored separately for DVD, Video CD and CD.

Shuttle screen

Slow-motion play (Backward)	Tilt the joystick (◀). (DVD only)	Still/Pause	Tilt the joystick (▲).	Slow-motion play (Forward)	Tilt the joystick (▶). (DVD/Video CD only)
---------------------------------------	--------------------------------------	--------------------	------------------------	--------------------------------------	---

Rapid reverse	Tilt the joystick (◀).	Play	Tilt the joystick (▼).	Rapid advance	Tilt the joystick (▶).
----------------------	------------------------	-------------	------------------------	----------------------	------------------------

For your reference:

- Each time the joystick (◀, ▶) is tilted, the speed of rapid reverse/advance and slow-motion play increases up to 5 steps.
- The figures appearing at both ends of the shuttle screen stand for the maximum speeds of rapid reverse and rapid advance.
(DVD: +100/-100, Video CD: +40/-40, CD: +50/-50)

Repeat play

Repeat viewing (listening)

Press **REPEAT MODE** during play.

Each time this button is pressed, the TV monitor changes as shown below and the disc will repeat a chapter or title (DVD) or a track (Video CD/CD).

•DVD

Normal play

Repeat of chapter being played

Repeat of title being played

Cancel repeat mode
(Normal play)

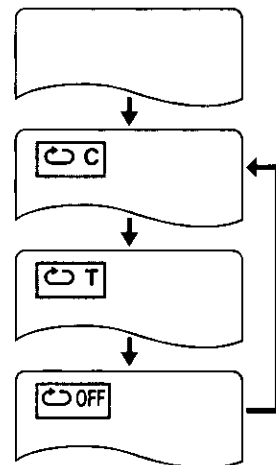

•Video CD/CD

Normal play

Repeat of track being played

Repeat of entire disc contents

Cancel repeat mode
(Normal play)

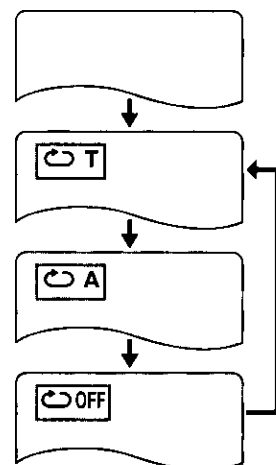

To return to normal play

Press **REPEAT MODE** until "OFF" is displayed.

Note

- Repeat play may not work correctly with some DVDs.
- Repeat play does not work with an interactive DVD or during menu play of a Video CD with playback control.

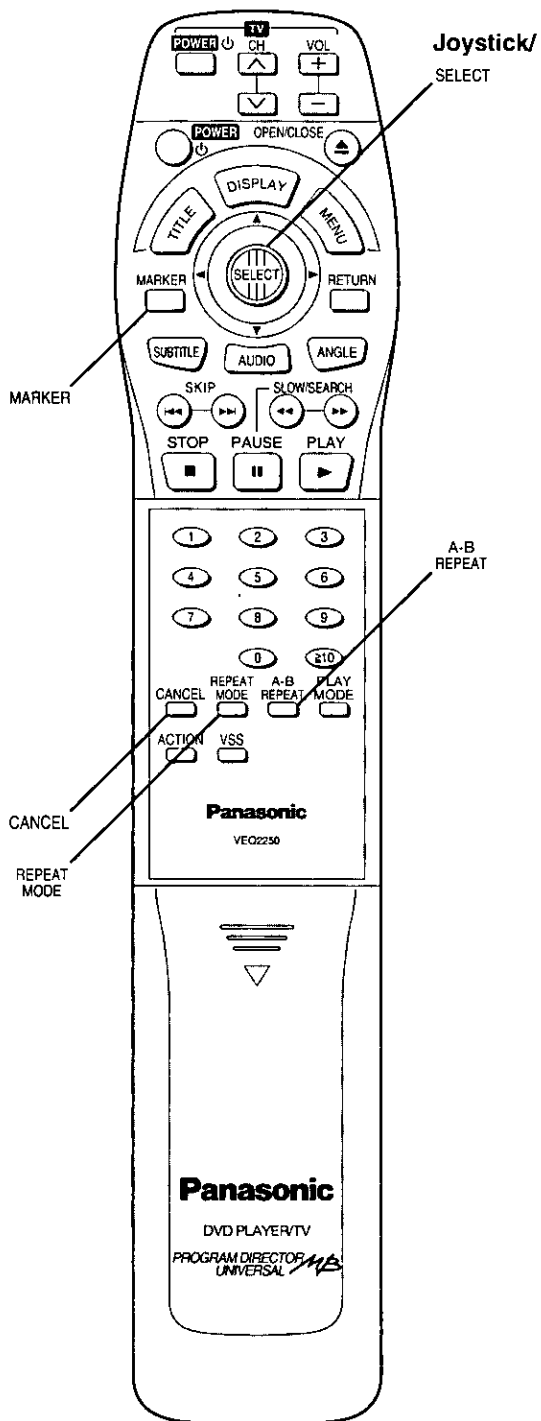

To enjoy program repeat play

If REPEAT MODE is pressed during program play (see page 24), the display changes as follows:

Program play

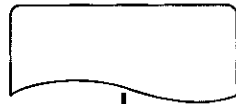

Repeat of programmed track being played

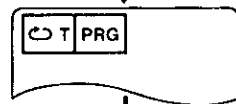

Repeat of all programs

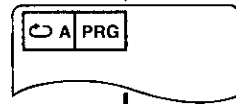

Cancel repeat mode (Program play)

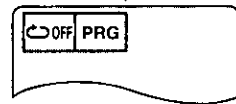

To return to program play

Press REPEAT MODE until "OFF" is displayed.

Repeating sections between two specific points (A-B repeat)

- 1 Press A-B REPEAT during play at the point where repeat play is to start (A).

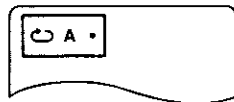

- 2 Press A-B REPEAT at the point where repeat play is to be concluded (B).



Repeat play of the section between points A and B starts.

To return to normal play

Press A-B REPEAT until "••" is displayed.

Note

- A-B repeat play does not work with an interactive DVD.
- Some subtitles recorded around point A or B may fail to appear (DVD).
- A-B repeat play works only within a title (DVD) or a track (Video CD/CD).

For your reference:

- The end of a track or title is automatically determined as point B.

Storing markers in memory to be viewed (listened to) again

Storing a marker in the memory

- 1 Press MARKER during play.

The marker screen appears on the TV monitor.

"*" indicates no marker has been stored yet.

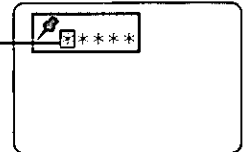

- 2 Press SELECT during play at the starting point to be viewed (listened to) again.

Indicates "MARKER 1" is stored in the memory. (If SELECT is pressed where any number is already displayed, the previous starting point will be replaced by the new one.)

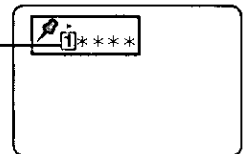

- Tilt the joystick (▶) and press SELECT to store the next marker.
- Up to 5 markers can be stored in the memory.
- Press MARKER to clear the display.

Recalling/clearing a marker

- 1 Press MARKER during play.

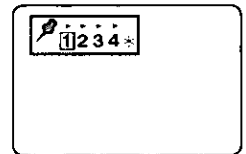

- 2 Tilt the joystick (◀, ▶) to select the marker to be recalled/cleared.

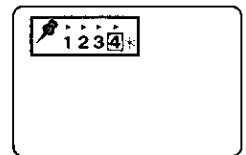

- 3 Tilt the joystick (▲) to recall a marker.
or
Press CANCEL to clear a marker.

Play resumes from the point corresponding to the selected marker.

or

The selected marker is cleared.

Note

- Some subtitles recorded around the marker may fail to appear. [DVD]
- These operations do not work with an interactive DVD or during menu play of a Video CD with playback control.

For your reference:

- All the markers are cleared when the player is set to the standby mode or turned off, or OPEN/CLOSE is pressed.

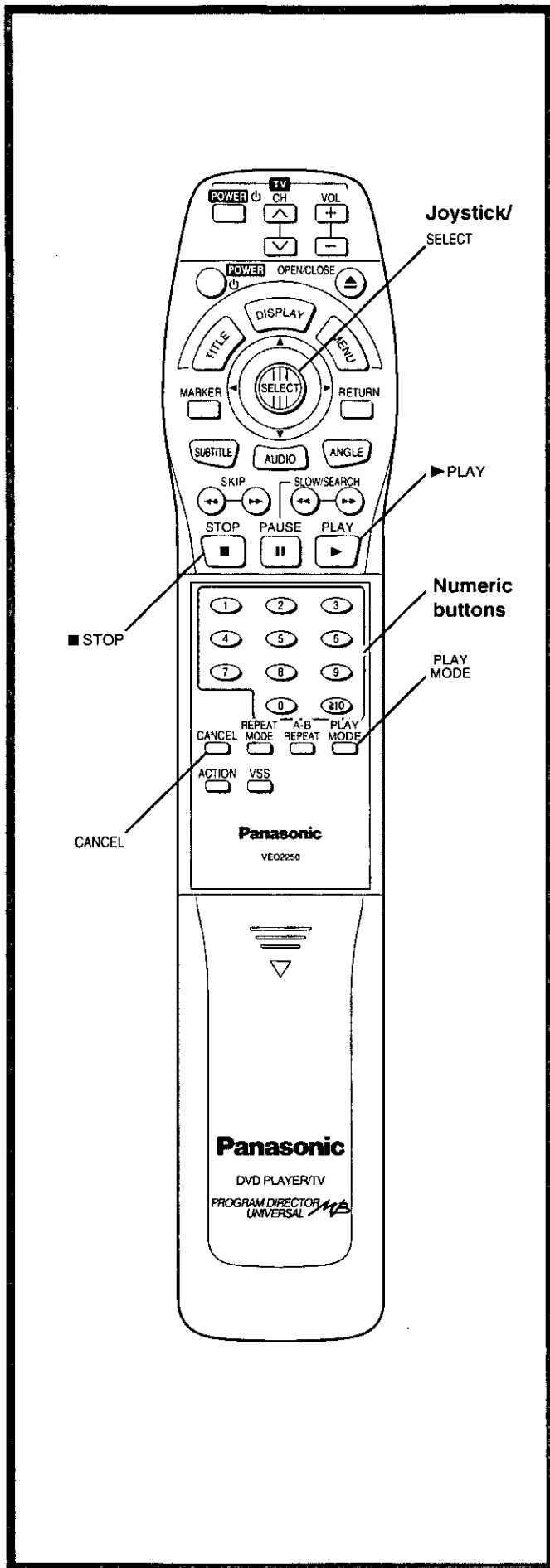

Program play [Video CD/CD]

The player plays the tracks on the disc in an order you specify.

1 Press PLAY MODE in the stop mode.

The program playback screen appears on the TV monitor.

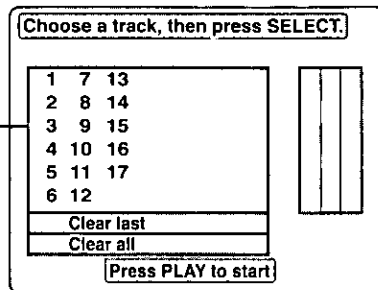

Example: a disc including 17 tracks

•To exit the screen

Press PLAY MODE twice.

2 Tilt the joystick (▲, ▼, ◀, ▶) to select the track.

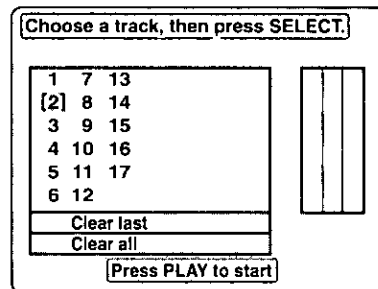

3 Press SELECT.

The selected track is stored in the memory.

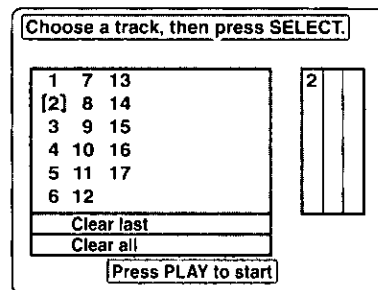

•Repeat steps 2 and 3 to select another track.

•Up to 18 tracks can be programmed.

4 Press PLAY.

Play now begins in the programmed sequence.

After playback

Play stops after the last programmed track.

Random play [Video CD/CD]

The player plays the tracks on the disc in random order.

- 1 Press PLAY MODE twice in the stop mode.**
The random playback screen appears on the TV monitor.

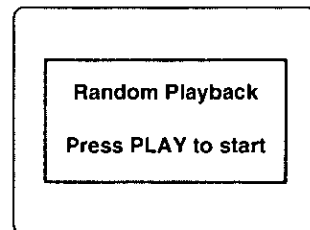

- **To exit the screen**
Press PLAY MODE once.

2 Press PLAY.

Play now begins in random order.

After playback

Play stops and the random playback screen is displayed.

To return to normal play

1. Press STOP. (Random play is suspended.)
2. Press PLAY MODE once.
3. Press PLAY.
Normal play begins from the beginning of the disc.

To return to normal play

1. Press STOP. (Program play is suspended.)
 2. Press PLAY MODE twice.
 3. Press PLAY.
Normal play begins from the beginning of the disc.
- The program is retained in the memory.

Clearing the program

When the program playback screen is displayed

- **To clear the last program one by one**
Move to "Clear last" and press SELECT.
(Pressing CANCEL on the remote control also clears the last program.)
- **To clear the whole program**
Move to "Clear all" and press SELECT.
(The program is also cleared when the player is set to the standby mode or turned off, or OPEN/CLOSE is pressed.)

Programming track numbers while monitoring the player's FL display

This function works with the following discs.

- CDs
- Video CDs with playback control when menu play is canceled
(Press STOP while the menu screen is displayed.)
- Video CDs which do not support playback control (Ver 1.1)

1. Press PLAY MODE once in the stop mode.

In the case of a CD



2. Press the numeric buttons to select the track.
The selected track is stored in the memory.



- Repeat step 2 to select another track.
3. Press PLAY.
Program play starts.

Changing audio soundtrack language [DVD]

It is possible to change the audio soundtrack language to a different language from the one selected at the initial settings if available. (See page 31.)

This operation works only with discs on which multiple audio soundtrack languages are recorded.

1 Press AUDIO during play.

- When no audio soundtrack is recorded, “-” will be displayed instead of the language number.

Number of the audio soundtrack language being played back

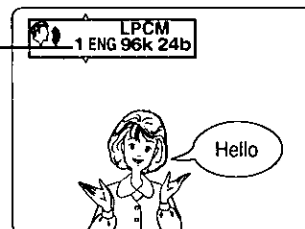

2 Tilt the joystick (▲, ▼) to select the language.

Pressing the numeric buttons also changes the audio soundtrack language.



- Press AUDIO or SELECT to clear the display.

For your reference:

- When the preferred language is not selected, even after tilting the joystick (▲, ▼) several times, it means that language is not available on the disc.
- When the power is turned on, or the disc is removed, the language heard is the one selected at the initial settings. If this language is not recorded on the disc, only the available language on the disc will be heard.

Switching vocals ON or OFF for Karaoke discs [DVD/Video CD]

1 Press AUDIO during play.

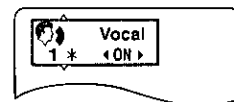

2 Tilt the joystick (▲, ▼, ◀, ▶) to select the setting.

- DVD Karaoke (Solo) (◀, ▶)
---(OFF) ↔ ON

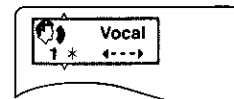

- DVD Karaoke (Duet) (◀, ▶)
---(OFF) ↔ 1+2 (ON) ↔ V1 (ON) ↔ V2 (ON)

- Video CD (▲, ▼)
LR ↔ L ↔ R



- Press AUDIO or SELECT to clear the display.

Note

- This operation does not work with CDs.

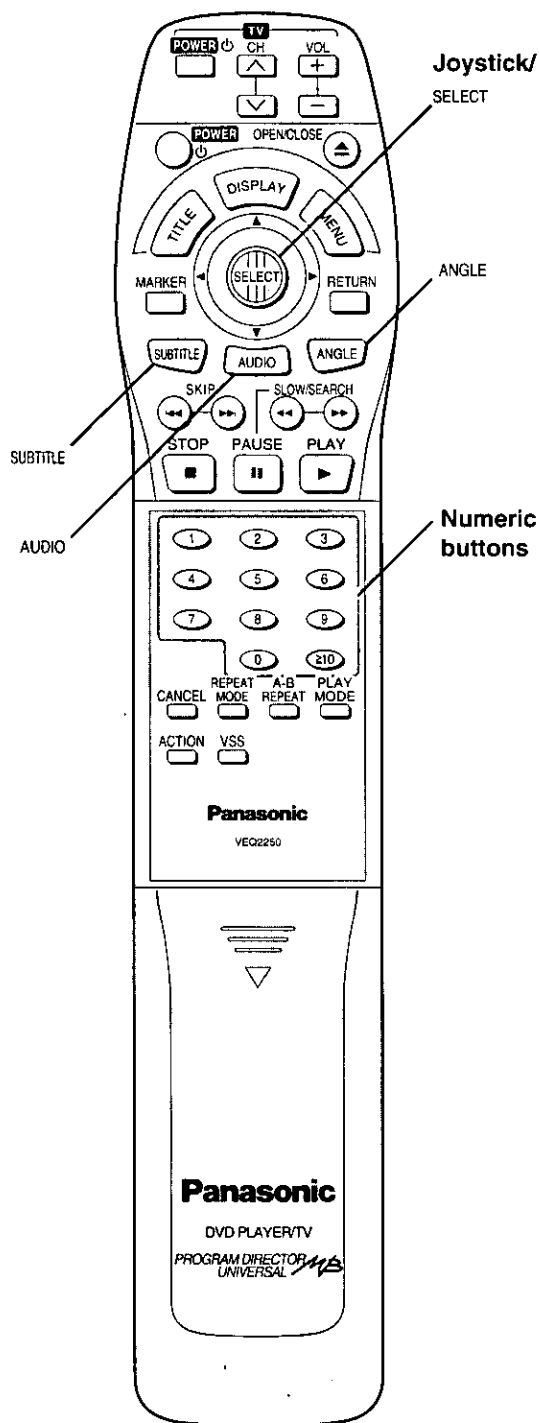

Changing subtitle language [DVD]

It is possible to change the subtitle language to a different language from the one selected at the initial settings if available. (See page 31.)

This operation works only with discs on which multiple subtitle languages are recorded.

1 Press SUBTITLE during play.

- When no subtitles are recorded, "—" will be displayed instead of the language number.

Number of the subtitle language being played back

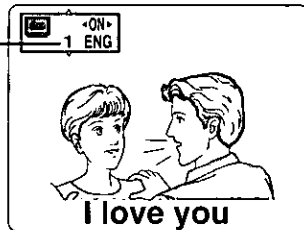

2 Tilt the joystick (▲, ▼) to select the language.

Pressing the numeric buttons also changes the subtitle language.



- Press SUBTITLE or SELECT to clear the display.

To clear/display the subtitles

Tilt the joystick (◀, ▶) to select ON or OFF at step 2.

Note

- In some cases, the subtitle language is not changed to the selected one immediately.
- When a disc supporting the closed caption is played, the subtitles and the closed caption may overlap each other on the TV monitor. In this case, turn the subtitles off.

For your reference:

- When the preferred language is not selected even after tilting the joystick (▲, ▼) several times, it means that the language is not available on the disc.
- When the power is turned on or the disc is removed, subtitles appear in the language selected at the initial settings. If this language is not recorded on the disc, they appear in the disc's priority language.

Viewing from another angle [DVD]

Some DVDs contain scenes which have been shot simultaneously from a number of different angles. For these discs, the same scene can be viewed from these different angles with the ANGLE button. (The angles depend on the disc used.)

1 Press ANGLE during play.

Number of angle being played back

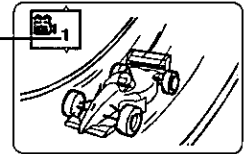

2 Tilt the joystick (▲, ▼) to select the angle.

Pressing the numeric buttons also changes the angle.

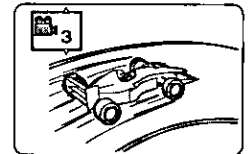

- Press ANGLE or SELECT to clear the display.

Note

- This function only works for titles having scenes recorded at different angles.

For your reference:

- "ANGLE" lights up on the player's FL display at scenes recorded at different angles to indicate that angle switching is possible.
- The angle number can be programmed beforehand with some DVDs; the angle will be switched to the selected number when "ANGLE" lights up.

Reproducing an Advanced Virtual Surround Sound (VSS) effect

[Dolby Digital (AC-3) DVD (2 channel or over)]

There are two types of Virtual Surround Sound effects available with this player; VSS (for external speakers) and Headphone VSS.

•VSS

Use this mode if you only have two front speakers. The speakers sound further apart and sound can also appear to come from the left and right of the listening position.

•Headphone VSS

Use this mode when listening through headphones connected to an amplifier or other equipment. Sound appears to come from front and surround speakers.

Use the On-Screen Menu Icons (for player information) to select the VSS effect (see page 21).

Press VSS during play.

Each time this button is pressed, the player's FL display changes:

•In the case of VSS

VSS 1 (Natural effect)

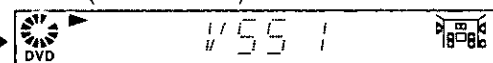

VSS 2 (Emphasized effect)

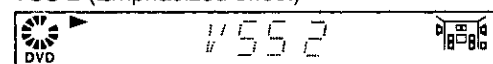

VSS is canceled

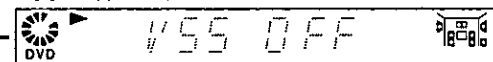

•In the case of Headphone VSS

Headphone VSS 1 (Natural effect)

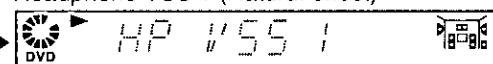

Headphone VSS 2 (Emphasized effect)

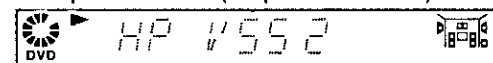

Headphone VSS is canceled

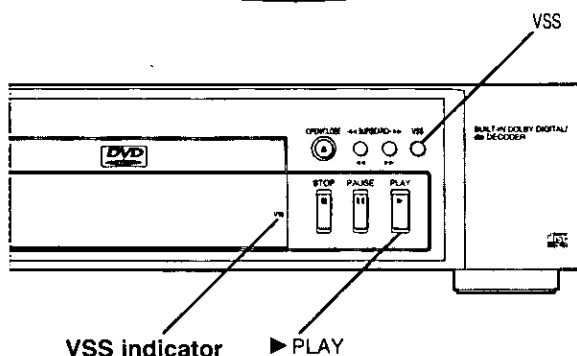
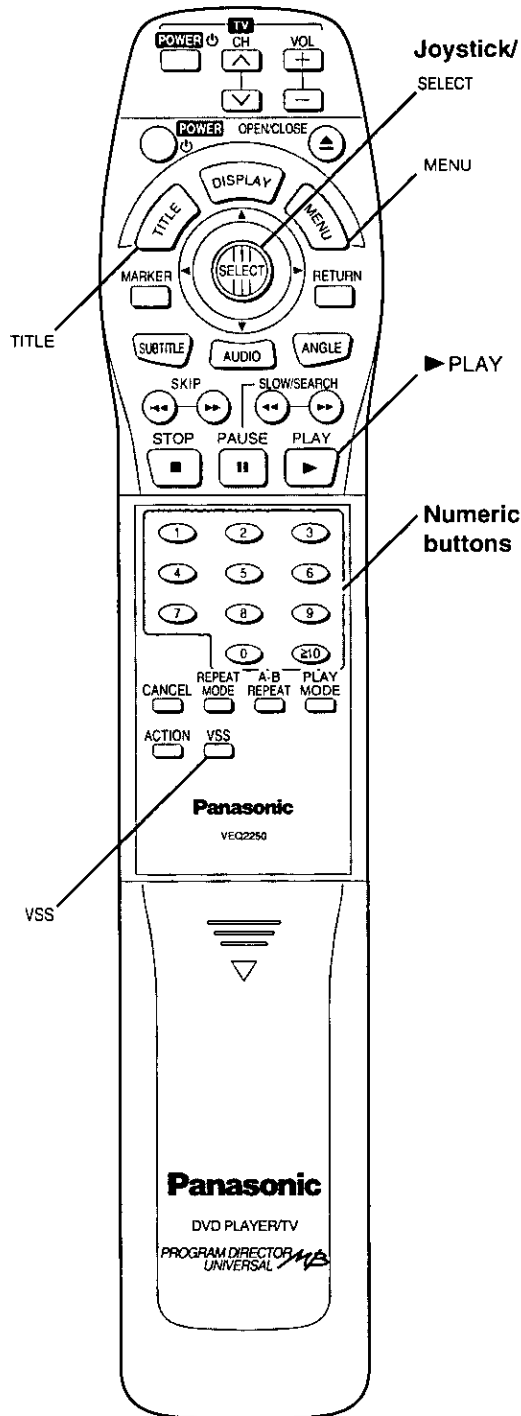
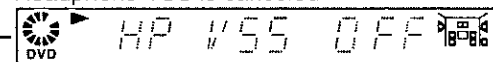

Using a title menu [DVD]

Some movie discs may have two or more titles. If the disc has a title menu recorded on it, the TITLE button can be used to select the movie title.

(The details of operation depend on the disc used.)

Note

- The virtual surround sound effect does not work with Karaoke DVDs.
- The virtual surround sound effect may not work with some Dolby Digital 2.1ch or 3.1ch DVDs. Additionally, this effect may not work properly with some Dolby Digital DVDs other than 2.1ch or 3.1ch, depending on the software.
- Turn off the TV surround sound and other surround sound effects when using this virtual surround sound effect.

For your reference:

- The VSS indicator lights up when the Dolby Digital DVD is played back with the virtual surround sound effect.
- For optimum effect, it is recommended that the distance between the TV set and the listening position be about 3 to 4 times the distance between the right and left front speakers (only in the case of VSS for external speakers).

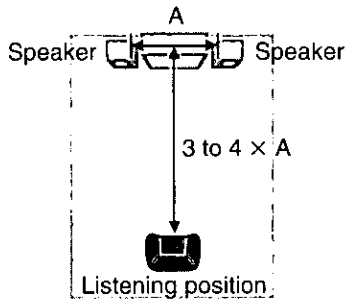

•Difference between "VSS 1" and "VSS 2"

	VSS 1	VSS 2
Dolby Digital DVD (2ch)	The front speakers sound like they are further apart.	The front speakers sound like they are even further apart than in VSS 1.
Dolby Digital DVD (3-5.1ch) (Surround signal recorded)	Surround sound seems to come from the left and right of the listening position.	Surround sound seems to come from the left and right of the listening position and the front speakers sound like they are even further apart than in VSS 1.

•Difference between "Headphone VSS 1" and "Headphone VSS 2"

Headphone VSS 1	Headphone VSS 2
Sound appears to come from front and surround speakers.	The effect is broader.

1 Press TITLE during play.

A list of the titles on the disc is now displayed.

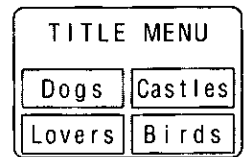

(Example)

- Pressing TITLE again resumes play from the scene when TITLE was first pressed.

2 Tilt the joystick (▲, ▼, ◀, ▶) and press SELECT or PLAY, or press the numeric buttons, to select the title.

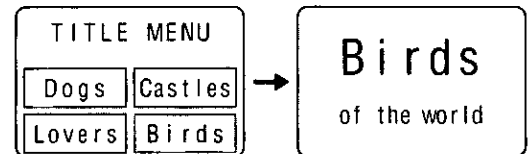

(Example)

The selected title now starts playing.

Using a DVD menu [DVD]

Some DVDs have unique menus. These menus can be for language selection, audio output selection and/or subtitle language selection, etc. Although the DVD menu's contents and operation differ from disc to disc, the following explains basic operation when this feature is used.

1 Press MENU during play.

The DVD menu available on the disc is now displayed.

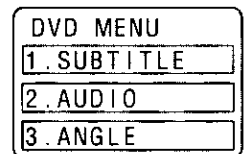

(Example)

- Pressing MENU again resumes play from the scene when MENU was first pressed.

2 Tilt the joystick (▲, ▼, ◀, ▶) and press SELECT, or press the numeric buttons, to select the item.

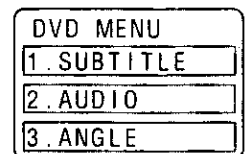

(Example)

The selected item is now executed.

When the menu continues onto another screen
Repeat step 2.

Initial settings

Once the initial settings have been completed, the player can always be operated under the same conditions (especially DVDs).

The settings will be retained in the memory, until the settings are changed, even after switching to standby mode.

Common procedures

1 Press ACTION in the stop mode.

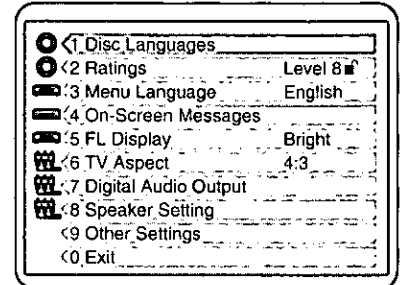

2 Tilt the joystick (▲, ▼) to select the item and press SELECT.

Each screen for setting the value is displayed.

- 1 Disc Languages (see page 31)
- 2 Ratings (see page 31)
- 3 Menu Language (see page 33)
- 4 On-Screen Messages (see page 33)
- 5 FL Display (see page 34)
- 6 TV Aspect (see page 35)
- 7 Digital Audio Output (see page 35)
- 8 Speaker Setting (see page 37)
- 9 Other Settings (see page 39)

3 Tilt the joystick (▲, ▼) to select the setting and press SELECT.

- Some items require additional steps. (See the respective page.)

Setting is finished and the initial settings screen is displayed.

To cancel during setup operation

Press RETURN or select "0". (The previous screen is displayed.)

To clear the initial settings screen

Tilt the joystick (▲, ▼) to select "0" and press SELECT. (Pressing ACTION or RETURN also clears the initial settings screen.)

Note

- After the player is set to the "Lock All" setting in "2 Ratings", none of the initial settings, including "2 Ratings", can be changed if a DVD is left inside the player. In this case, remove the disc, and unlock the player.

For your reference:

- The numeric buttons can also be used instead of the joystick (▲, ▼) for selecting items or values. Pressing SELECT is not necessary.

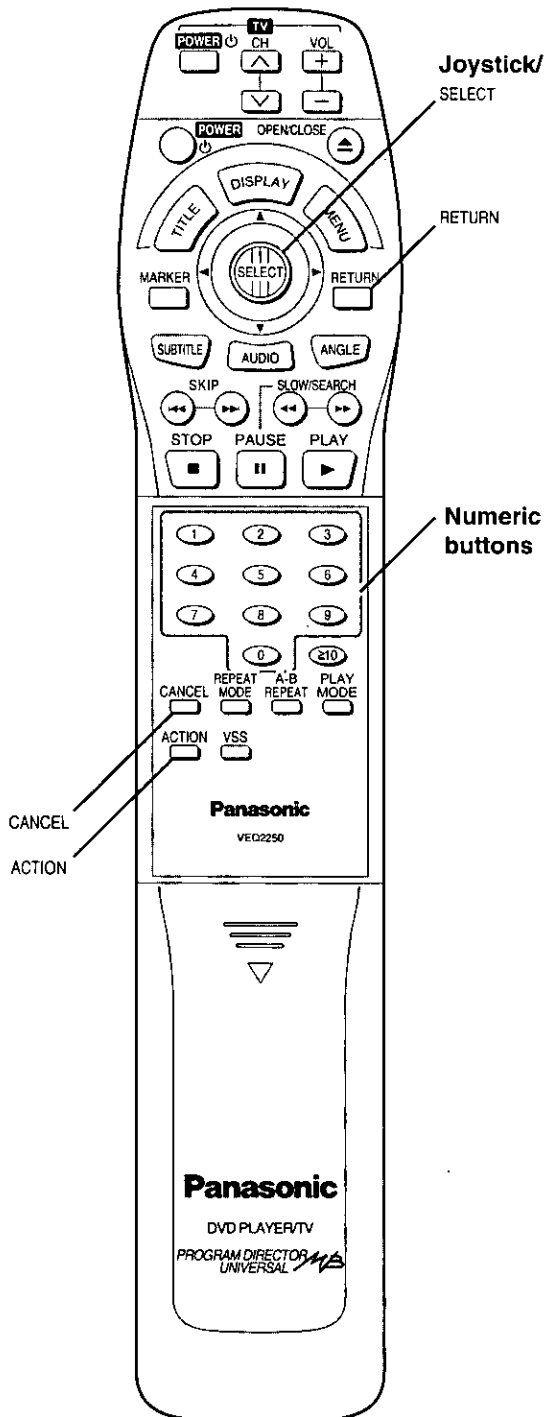

Selecting disc languages [DVD]

This is to select the audio soundtrack language, subtitle language and the language used in title menus or DVD menus which will always be used for every disc to be played back.

- 1 At the initial settings screen (on page 30)
Tilt the joystick (▲, ▼) to select "1 Disc Languages" and press SELECT.

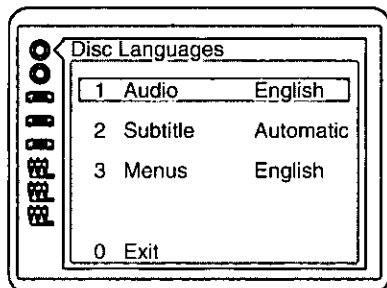

- 2 Tilt the joystick (▲, ▼) to select the item and press SELECT.

- 1 **Audio:**
To select the audio soundtrack language.
- 2 **Subtitle:**
To select the subtitle language.
- 3 **Menus:**
To select the language used in title menus or DVD menus.

- 3 Tilt the joystick (▲, ▼) to select the language and press SELECT.

When "1 Audio" is selected

- 1 **English:** English is selected. (Factory preset)
- 2 **French/3 Spanish:**
The language is selected.
- 4 **Original:** The original language of each disc will be selected.
- 5 **Other ****:** Another language can be selected. (Refer to the language codes on page 41. Press CANCEL if an incorrect language code is entered.)

When "2 Subtitle" is selected

- 1 **Automatic:** Subtitle language will automatically be selected in accordance with the audio soundtrack language. (Factory preset)
 - If the language selected for the "1 Audio" is actually used during playback, the subtitles will not appear.
 - If another language is used during playback, the subtitles will appear in the language selected at the setup "1 Audio".
- 2 **English/3 French/4 Spanish:**
The language is selected.
- 5 **Other ****:** Another language can be selected. (Refer to the language codes on page 41. Press CANCEL if an incorrect language code is entered.)

When "3 Menus" is selected

- 1 **English:** English is selected. (Factory preset)
- 2 **French/3 Spanish:**
The language is selected.
- 4 **Other ****:** Another language can be selected. (Refer to the language codes on page 41. Press CANCEL if an incorrect language code is entered.)

The screen illustrated in step 1 is displayed. Select "0" with the joystick (▲, ▼) and press SELECT to return to the initial settings screen.

Also refer to "Common procedures" on page 30.

Note

- If the language selected is not available on the disc, the language designated by each disc will be selected.

Selecting rating level [DVD]

This is to disable the playing of some DVDs which are unsuitable for some audiences, for example, children.

- Some DVDs are encoded with a specific rating level. If the rating level of the disc is higher than that preset in the initial settings operation, playback of the disc will be prohibited.

- 1 At the initial settings screen (on page 30)
Tilt the joystick (▲, ▼) to select "2 Ratings" and press SELECT.

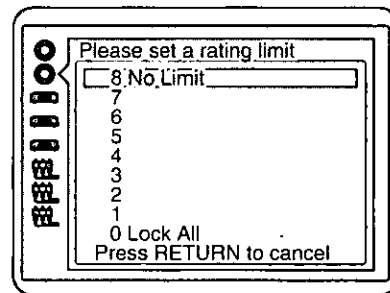

(Continued on the next page)

Initial settings

2 Tilt the joystick (▲, ▼) to select the level and press SELECT.

- Level 8:** All DVDs can be played back.
(Factory preset)
- Level 7 to 2:** DVDs for general audiences/children can be played back.
(DVDs for adults are prohibited.)
- Level 1:** DVDs for children can be played back.
(DVDs for adults/general audiences are prohibited.)
- Level 0:** Playback of all DVDs is prohibited (e.g. to prohibit playback of DVDs for adults which are not encoded with rating level information).

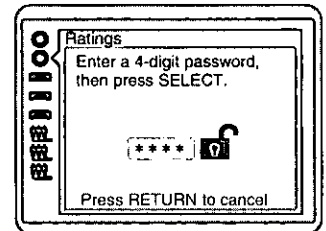
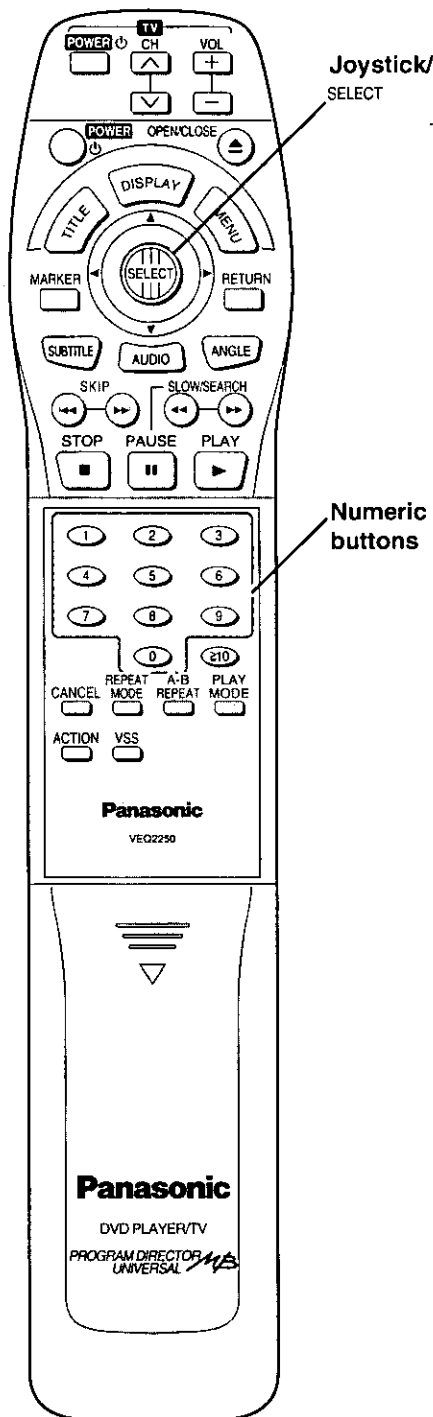

3 When level 7 or lower is selected Input a 4-digit password with the numeric buttons and press SELECT.

The lock symbol appears closed to show the rating is locked.

Example: "4343"

Do not forget your password.

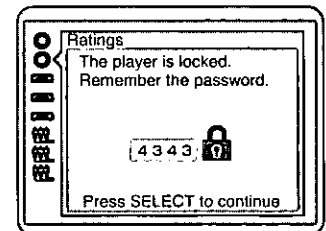

4 Press SELECT.

Setting is finished and the initial settings screen is displayed.

- The rating is locked. Any discs with a higher rating than the setting cannot be played back unless the password is entered.

When the player is locked

The following screen appears when "2 Ratings" is selected at the initial settings screen.

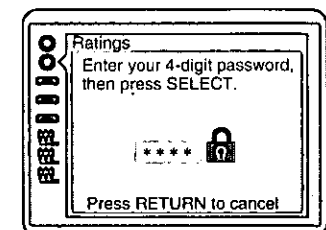

1. Input your 4-digit password and press SELECT.

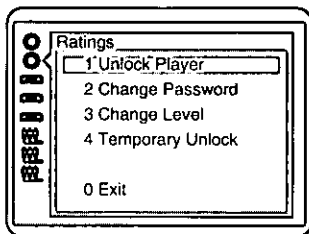

2. To unlock the player

Press "1" and then press SELECT.

To change the password

Press "2", enter a new 4-digit password and press SELECT, then press SELECT again.

To change the rating level

Press "3", select a new level with the joystick (▲, ▼), then press SELECT.

To unlock the player temporarily

Press "4" and then press SELECT.

•The rating is unlocked temporarily only for the current disc. The player is locked again when OPEN/CLOSE is pressed or the player is set to the standby mode.

To finish setting without changing the rating level

Press "0".

Setting is finished and the initial settings screen is displayed.

Also refer to "Common procedures" on page 30.

Note

•Some discs may not be encoded with specific rating level information though its disc jacket says that it is for "adults". For those discs, the age restriction will not work.

Selecting On-Screen Display menu language

This is to select the language to be used in the On-Screen Display menus which the player will show on the TV monitor.

1 At the initial settings screen (on page 30)
Tilt the joystick (▲, ▼) to select "3 Menu Language" and press SELECT.

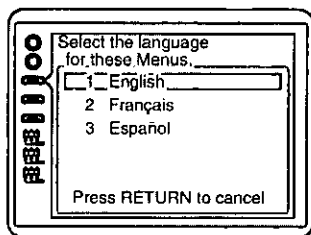

2 Tilt the joystick (▲, ▼) to select the language and press SELECT.

1 English:

English is selected. (Factory preset)

2 Français/3 Español:

The language is selected.

Setting is finished and the initial settings screen is displayed.

Also refer to "Common procedures" on page 30.

Selecting On-Screen Display format

You can select whether "Play", "Still" and other displays will be displayed or not, and the color and position of "Play", "Still" and other displays as well as On-Screen Menu Icons.

1 At the initial settings screen (on page 30)
Tilt the joystick (▲, ▼) to select "4 On-Screen Messages" and press SELECT.

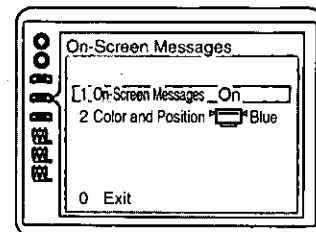

2 Tilt the joystick (▲, ▼) to select the item and press SELECT.

1 On-Screen Messages:

To select whether "Play", "Still" and other displays are displayed or not.

2 Color and Position:

To select the color (Blue/Violet/Green) and position (above/slightly below) of "Play", "Still" and other displays as well as On-Screen Menu Icons.

3 Tilt the joystick (▲, ▼) to select the setting and press SELECT.

When "1 On-Screen Messages" is selected

1 On: "Play", "Still" and other displays will always appear on the TV screen. (Factory preset)

2 Off: "Play", "Still" and other displays will not appear on the TV screen.

When "2 Color and Position" is selected

The colors and positions are set as follows:

1 > < Blue (Factory preset)

2 > < Violet

3 > < Green

4 > < Blue

5 > < Violet

6 > < Green

(Continued on the next page)

Initial settings

The screen illustrated in step 1 is displayed. Select "0" with the joystick (▲, ▼) and press SELECT to return to the initial settings screen.

Also refer to "Common procedures" on page 30.

For your reference:

- When  is selected, "Play", "Still" and other displays as well as On-Screen Menu Icons will be displayed at a little lower position than the factory setting. It is recommended to choose this setting if the screen is only partially displayed.

Selecting FL display brightness

This is to select the brightness of the player's FL display.

- 1 At the initial settings screen (on page 30) Tilt the joystick (▲, ▼) to select "5 FL Display" and press SELECT.

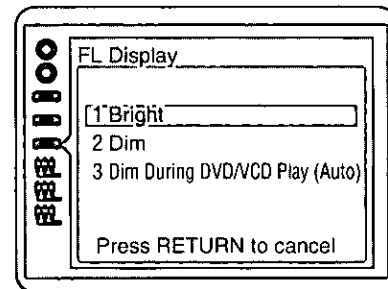

- 2 Tilt the joystick (▲, ▼) to select the item and press SELECT.

- 1 **Bright:**
The FL display will always be bright. (Factory preset)
- 2 **Dim:**
The FL display will always be dimmed.
- 3 **Dim During DVD/VCD Play (Auto):**
The FL display will be dimmed during playback of DVDs and Video CDs.

Setting is finished and the initial settings screen is displayed.

Also refer to "Common procedures" on page 30.

For your reference:

- Even if "3 Dim During DVD/VCD Play (Auto)" is selected, the display resumes brightness when a button for special play such as SLOW/SEARCH and PAUSE is pressed.

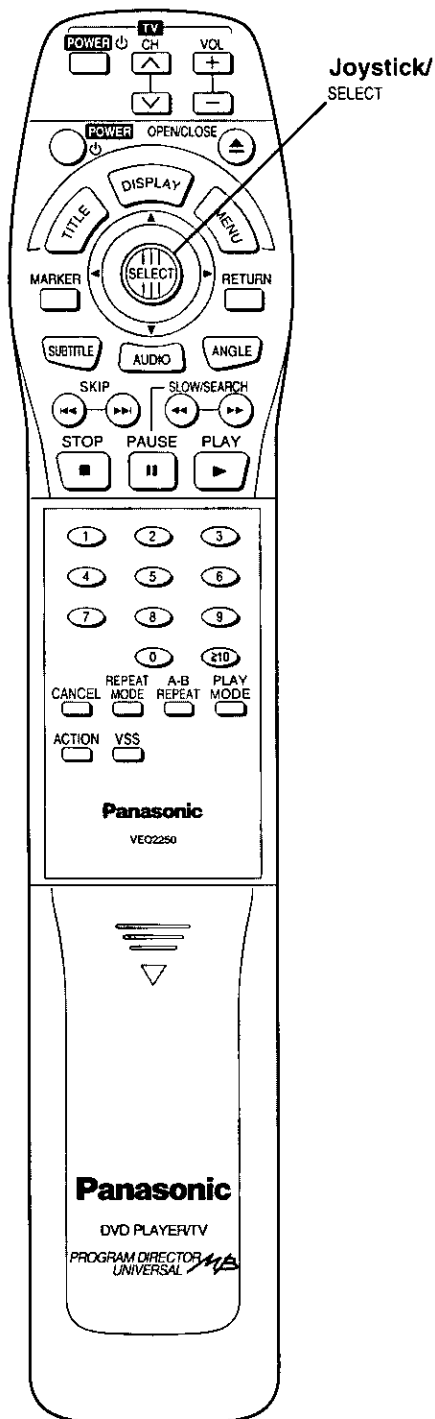

Selecting TV screen type

Select the TV aspect, conventional size screen (4:3) or wide-screen (16:9), and the TV type according to your TV set.

- 1 At the initial settings screen (on page 30)
Tilt the joystick (▲, ▼) to select "6 TV Aspect" and press SELECT.

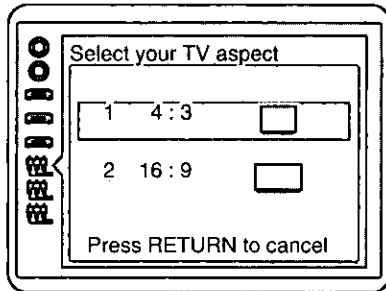

- 2 Tilt the joystick (▲, ▼) to select the TV aspect and press SELECT.

- 1 **4:3:**
Select when a conventional TV set is connected.
(Factory preset)
- 2 **16:9:**
Select when a wide-screen TV set is connected.

- 3 Tilt the joystick (▲, ▼) to select the TV type and press SELECT.

When "4:3" is selected

When "16:9" is selected

The following TV types can be selected in both cases.

- 1 **Standard (Direct View TV):**
Select when a standard TV (Direct view) is connected.
(Factory preset)
- 2 **CRT Projector:**
Select when a CRT projector is connected.
- 3 **LCD Projector:**
Select when a LCD projector is connected.
- 4 **Projection TV:**
Select when a projection TV is connected.

Setting is finished and the initial settings screen is displayed.

Also refer to "Common procedures" on page 30.

For your reference:

- For further details on the images which appear on the TV screen (aspect ratios of the screen), see page 42.

Selecting digital output

Select the digital output to be output from the optical/coaxial digital audio output connector of the player.

- 1 At the initial settings screen (on page 30)
Tilt the joystick (▲, ▼) to select "7 Digital Audio Output" and press SELECT.

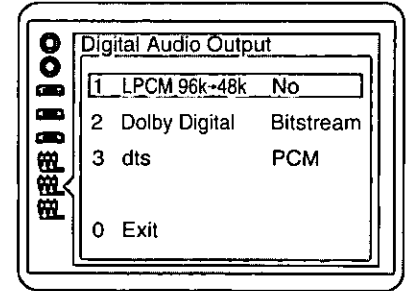

- 2 Tilt the joystick (▲, ▼) to select the item and press SELECT.

- 1 **LPCM 96k→48k:**
To select whether digital audio converted to 48 kHz/16 bit is output from the optical/coaxial digital audio output connector or no digital audio is output during playback of DVDs recorded in 96 kHz Linear PCM. (If the DVD is recorded in 48 kHz Linear PCM, digital audio converted to 48 kHz/16 bit is output irrespective of the setting.)
- 2 **Dolby Digital:**
To select the signal format (Bitstream or PCM) to be output from the optical/coaxial digital audio output connector during playback of DVDs recorded in Dolby Digital (AC-3).
- 3 **dts:**
To select the signal format (PCM or Bitstream) to be output from the optical/coaxial digital audio output connector during playback of DVDs recorded in dts.

(Continued on the next page)

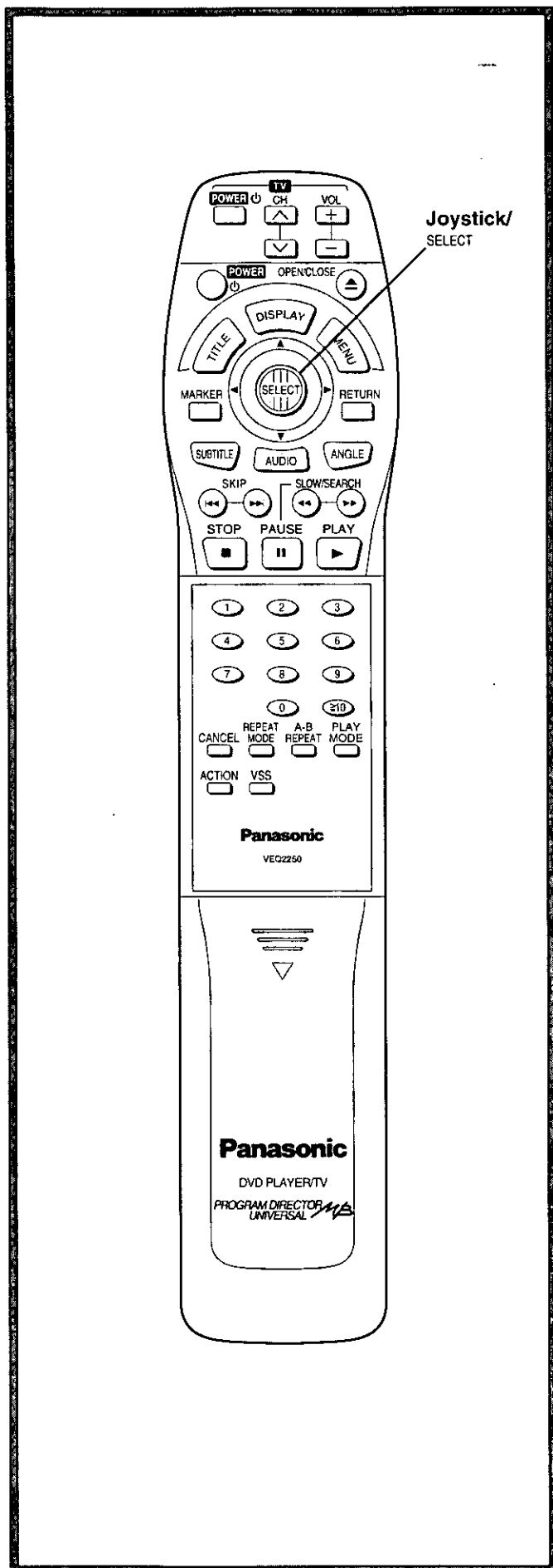

Initial settings

3 Tilt the joystick (▲, ▼) to select the setting and press SELECT.

When "1 LPCM 96k→48k" is selected

- 1 **No:** Digital audio of 48 kHz/16 bit is output during playback of DVDs recorded in 48 kHz Linear PCM. No digital audio is output during playback of DVDs recorded in 96 kHz Linear PCM. However, audio will be output using the original audio recording system if the DVD has not been copyright-protected. (Factory preset)
- 2 **Yes:** During playback of DVDs recorded in 48 kHz or 96 kHz Linear PCM, digital audio converted to 48 kHz/16 bit is output. (Digital output of PCM audio is restricted to 48 kHz/16 bit or below for copyright protection.)

When "2 Dolby Digital" is selected

- 1 **Bitstream*1:** Dolby Digital (AC-3) bitstream (1ch–5.1ch) is output during playback of DVDs recorded in Dolby Digital (AC-3). (Factory preset)
Select this setting when the player is connected to a Dolby Digital (AC-3) decoder.
- 2 **PCM:** Digital audio converted to 48 kHz/16 bit PCM (2ch) is output during playback of DVDs recorded in Dolby Digital (AC-3).

When "3 dts" is selected

- 1 **PCM:** Digital audio converted to 48 kHz/16 bit PCM (2ch) is output during playback of DVDs recorded in dts. (Factory preset)
- 2 **Bitstream*1:** dts bitstream is output during playback of DVDs recorded in dts. Select this setting when the player is connected to a dts decoder.

The screen illustrated in step 1 is displayed. Select "0" with the joystick (▲, ▼) and press SELECT to return to the initial settings screen.

Also refer to "Common procedures" on page 30.

Recommended setting of "Digital Audio Output"

Make settings as shown in table below depending on the kind of equipment that is connected to the optical/coaxial digital audio output connector.

Type of equipment connected	Recommended setting		
	1 LPCM 96k→48k	2 Dolby Digital	3 dts
No equipment is connected	No	<u>Bitstream</u>	<u>PCM</u>
AV amplifier (with digital audio input connector) without Dolby Digital/dts decoder	Yes*2	PCM*1	<u>PCM</u> *1
Dolby Digital (AC-3) decoder (See page 12.)	Yes*2	<u>Bitstream</u>	<u>PCM</u>
Dolby Digital (AC-3)/dts decoder (See page 12.)	Yes*2	<u>Bitstream</u>	Bitstream

• Underlined items are factory preset.

*1 When connecting an amplifier (with an optical/coaxial digital input connector) which does not contain a Dolby Digital (AC-3) or dts decoder, be sure to select "PCM" at the "2 Dolby Digital" and at the "3 dts". If "Bitstream" is selected, any attempt to play DVDs (or CDs recorded in dts) may cause such a high level of noise that it may be harmful to your ears and damage your speakers.

*2 96 kHz LPCM sound is converted to 48 kHz 16 bit sound when this player is connected with an optical digital audio cable or coaxial audio cable.

Do the following if you wish to take advantage of high quality 96 kHz sound.

Select "1 No" and connect this player's audio output connector to an amplifier's audio input connector with the audio/video cable (included) or an audio cable (not included).

Note that LPCM, Dolby Digital and dts signals will all be output in 2 channel, analog form.

Speaker setting

- At the initial settings screen (on page 30) Tilt the joystick (▲, ▼) to select "8 Speaker Setting" and press SELECT.

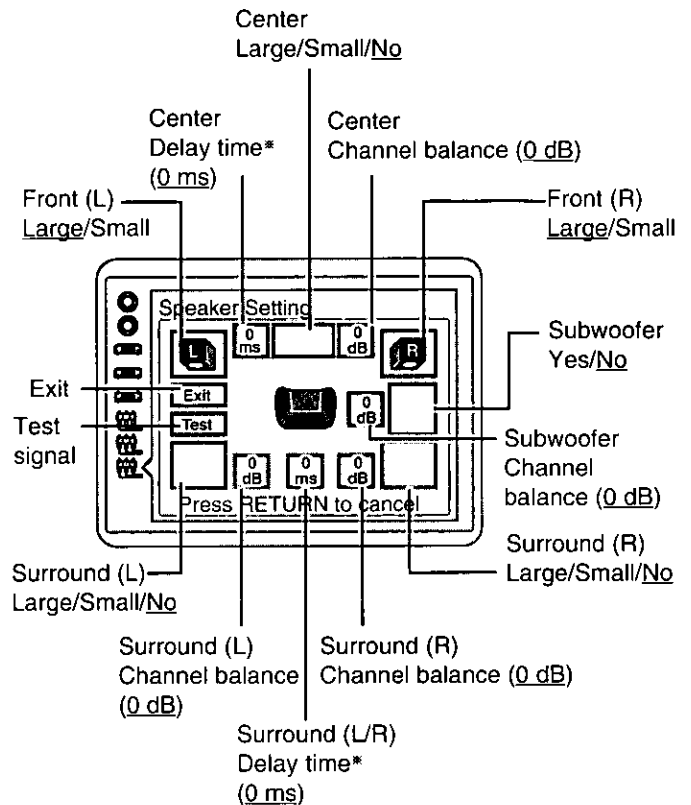

• Underlined items are factory preset.

*Delay time adjustment is effective only for DVDs recorded in Dolby Digital (AC-3).

- Tilt the joystick (▲, ▼, ◀, ▶) to select the item and press SELECT.

- Tilt the joystick (▲, ▼) to select the setting and press SELECT.

Speaker icons:

- If the speaker is connected, display the icon with the joystick (▲, ▼) and press SELECT.
- If the speaker supports low-frequency (under 100 Hz) reproduction, select the large icon. If the speaker does not support low-frequency reproduction, select the small icon. [When a subwoofer is not connected, be sure to select "Large" for the front speakers (L/R).]

In case of surround speaker (L)

No



Large/Yes



Small/Yes



(Continued on the next page)

Initial settings

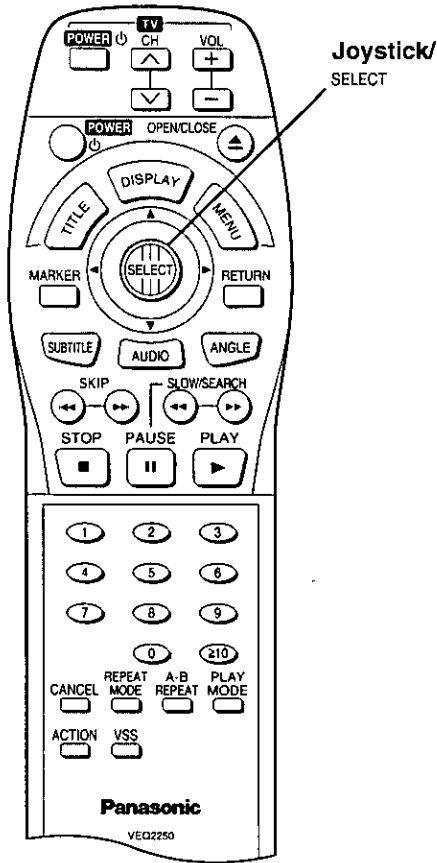

Delay time [only for Dolby Digital (AC-3) discs] (A):

If the surround speakers or the center speaker can't be installed at an equal distance to the front speakers from the listening position, change the delay time to get better surround effect.

• When D2 or D3 is equal to or larger than D1, no setting is necessary. Otherwise, change the setting according to the table below.

Speaker	Difference between D1 and D2/D3	Delay time
Center speaker (D2)	approx. 1½ feet (50 cm)	1.3 ms
	approx. 3 feet (100 cm)	2.6 ms
	approx. 5 feet (150 cm)	3.9 ms
	approx. 6 feet (200 cm)	5.3 ms
Surround speakers (D3)	approx. 6 feet (200 cm)	5.3 ms
	approx. 12 feet (400 cm)	10.6 ms
	approx. 18 feet (600 cm)	15.9 ms

To adjust the channel balance using the test signal (B)

1. Select "Test" with the joystick (▲, ▼, ◀, ▶), and then press SELECT.
(Test signals will be output clockwise from each speaker except the subwoofer consecutively.)
2. While listening to the test signal, tilt the joystick (▲, ▼) to adjust the volume of each speaker until the test signal is heard at a similar level from all speakers.
3. Press SELECT. (The test signals are stopped.)

Note

• Test signal is not output from the subwoofer. Subwoofer volume should be adjusted to suit the material being played.

4 Tilt the joystick (▲, ▼, ◀, ▶) to select "Exit" and press SELECT.

Setting is finished and the initial settings screen is displayed.

Also refer to "Common procedures" on page 30.

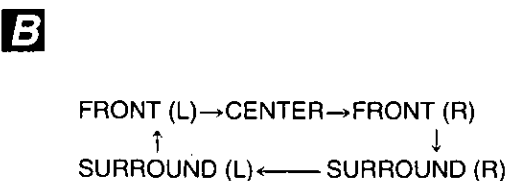
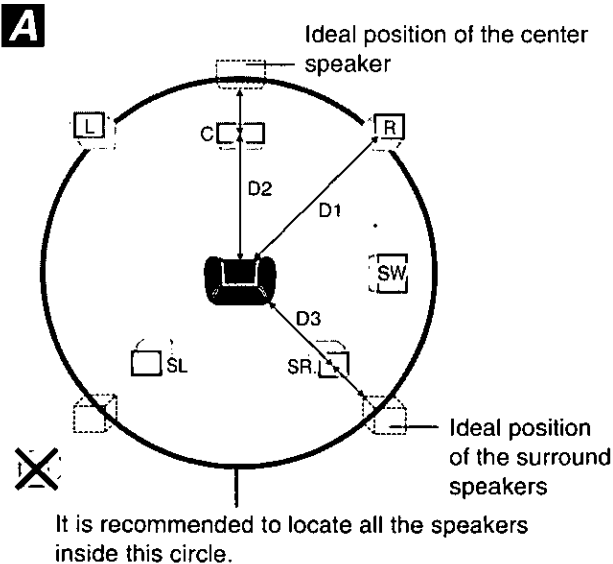

Other settings

Compression of the sound's dynamic range and other special settings can be performed.

- 1 At the initial settings screen (on page 30) Tilt the joystick (▲, ▼) to select "9 Other Settings" and press SELECT.

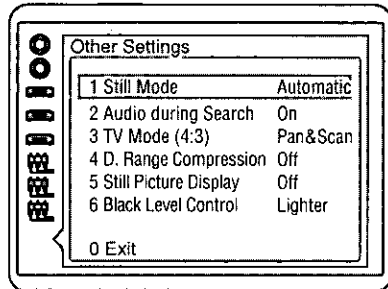

- 2 Tilt the joystick (▲, ▼) to select the item and press SELECT.

1 Still Mode:

Select either "Field still" or "Frame still" to prevent jittering or improve the video quality of small text or fine patterns in the still picture mode.

2 Audio during Search:

To select whether audio is heard during search (forward direction) at the initial scan speed or not.

3 TV Mode (4:3):

To select whether wide-screen video material will be played back in the pan and scan style or in the letterbox style on a conventional size TV.

4 D. (Dynamic) Range Compression:

To select the dynamic range during playback.

5 Still Picture Display:

To display the picture type, I, P or B in the still picture mode.

6 Black Level Control:

To select the black level of the picture, "Lighter" or "Darker".

- 3 Tilt the joystick (▲, ▼) to select the setting and press SELECT.

When "1 Still Mode" is selected

- 1 **Automatic:** "Field still" and "Frame still" are automatically selected in the still picture mode. (Factory preset)
- 2 **Field:** "Field still" is always selected. Select this setting when jittering occurs when "1 Automatic" is selected.
- 3 **Frame:** "Frame still" is always selected. Select this setting when small text or fine patterns cannot be seen clearly when "1 Automatic" is selected.

When "2 Audio during Search" is selected

- 1 **On:** Audio will be heard during search at the initial scan speed. (Factory preset)
- 2 **Off:** Select this setting when audio during search at the initial scan speed is not desired.

When "3 TV Mode (4:3)" is selected

- 1 **Pan & Scan:** Wide-screen video material will be played back in the pan and scan style on a conventional size TV. (Factory preset)
 - Video material not formatted in the pan and scan style will be played back in the letterbox style. (See page 42.)
- 2 **Letterbox:** Wide-screen video material will be played back in the letterbox style on a conventional size TV.

When "4 D. (Dynamic) Range Compression" is selected

- 1 **Off:** Normal audio range is selected. (Factory preset)
- 2 **On:** Select this setting to enjoy dynamic sound at low volume. Dynamic range is the difference in volume between the quietest and loudest sounds. Dynamic Compression limits level for listening at low volume. This is useful late at night. This function only works with Dolby Digital (AC-3) DVD.

When "5 Still Picture Display" is selected

- 1 **Off:** The picture type (I/P/B) will not be displayed on the TV screen in the still picture mode. (Factory preset)
- 2 **On:** The picture type (I/P/B) will be displayed on the TV screen in the still picture mode. Since I-Picture features the best picture quality, it is recommended that the screen be frozen with I-Picture when the picture quality is to be adjusted.

When "6 Black Level Control" is selected

- 1 **Lighter:** The black level of the picture is made lighter. Select this setting normally when the player is connected to a TV set through the VIDEO OUT connector or S VIDEO OUT connector. (Factory preset)
- 2 **Darker:** The black level of the picture is made darker. Select this setting normally when the player is connected to a TV set through the COMPONENT VIDEO OUT (Y/P_B/P_R) connector.

(Continued on the next page)

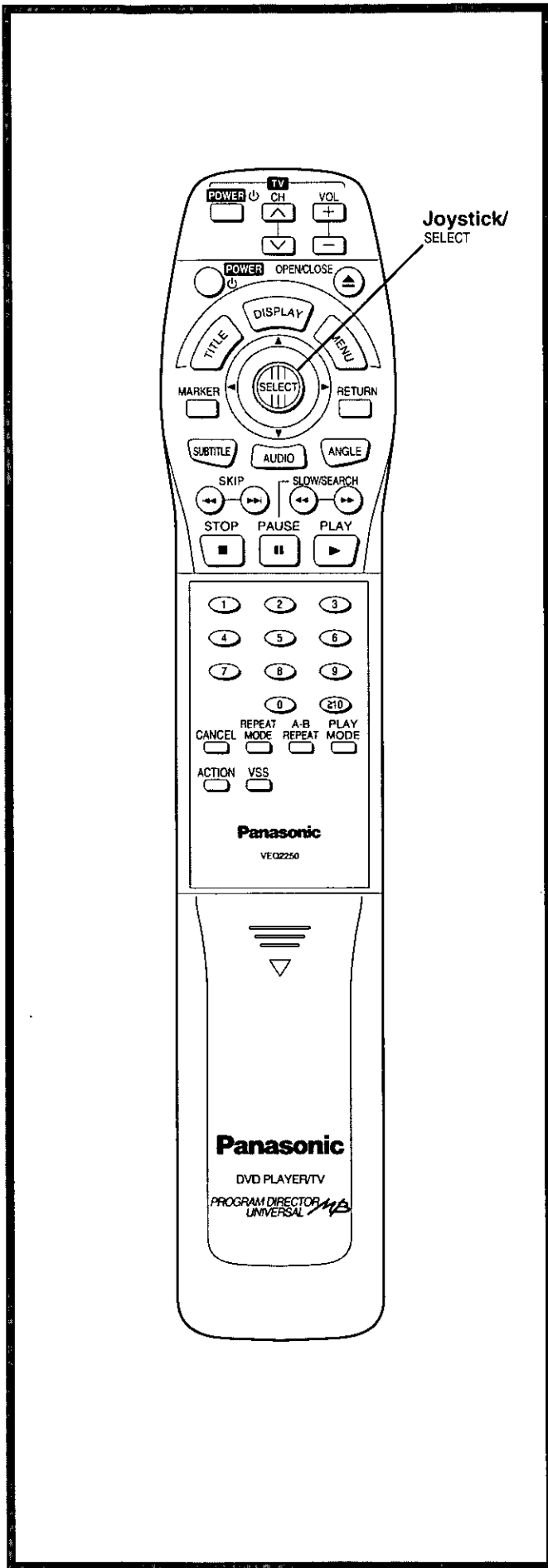

Initial settings

The screen illustrated in step 1 is displayed. Select "0" with the joystick (▲, ▼) and press SELECT to return to the initial settings screen.

Also refer to "Common procedures" on page 30.

For your reference:

- When the "2 On" is selected at the "5 Still Picture Display", the following screen is displayed in the still picture mode;

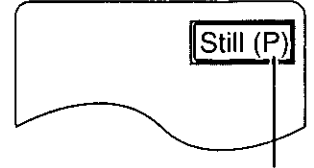

Example: P-Picture

• Field

Half of the video information (video signal) in a frame is called a field. With conventional TV systems, a signal frame (a single screen) consists of two fields.

• Field still

Only one field (half of the video information) is displayed on the TV screen, so the apparent resolution is low. However, there is no blurring on the screen.

• Frame

Individual images in a video or on the TV are called frames.

• Frame still

The two fields are displayed, alternately, on the TV screen, so the image is blurry. However, the image quality is better than field images.

• I/P/B

The MPEG 2 standard adopted for DVD uses the following 3 picture types for the coding of each picture (frame) on the TV screen.

I: I-Picture (Intra coded picture)

This is the standard picture type, and each picture is coded separately.

P: P-Picture (Predictive coded picture)

This picture type is computed on the basis of a past I-Picture or P-Picture.

B: B-Picture (Bidirectionally-predictive coded picture)

This picture type is computed by comparing the previous and subsequent I-Picture or P-Picture. It has the lowest volume of information.

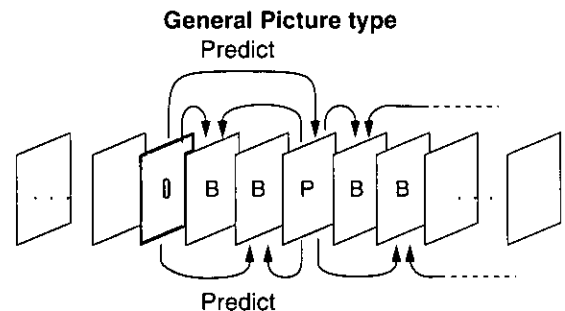

















Language code list

Enter the appropriate code number for the initial settings "Audio", "Subtitle" and/or "Menus" (see page 31).

Code	Language	Code	Language	Code	Language	Code	Language
6565	Afar	7079	Faroese	7678	Lingala	8375	Slovak
6566	Abkhazian	7082	French	7679	Laotian	8376	Slovenian
6570	Afrikaans	7089	Frisian	7684	Lithuanian	8377	Samoaan
6577	Ameharic	7165	Irish	7686	Latvian, Lettish	8378	Shona
6582	Arabic	7168	Scots Gaelic	7771	Malagasy	8379	Somali
6583	Assamese	7176	Galician	7773	Maori	8381	Albanian
6588	Aymara	7178	Guarani	7775	Macedonian	8382	Serbian
6590	Azerbaijani	7185	Gujarati	7776	Malayalam	8385	Sundanese
6665	Bashkir	7265	Hausa	7778	Mongolian	8386	Swedish
6669	Byelorussian	7273	Hindi	7779	Moldavian	8387	Swahili
6671	Bulgarian	7282	Croatian	7782	Marathi	8465	Tamil
6672	Bihari	7285	Hungarian	7783	Malay	8469	Telugu
6678	Bengali; Bangla	7289	Armenian	7784	Maltese	8471	Tajik
6679	Tibetan	7365	Interlingua	7789	Burmese	8472	Thai
6682	Breton	7378	Indonesian	7865	Nauru	8473	Tigrinya
6765	Catalan	7383	Icelandic	7869	Nepali	8475	Turkmen
6779	Corsican	7384	Italian	7876	Dutch	8476	Tagalog
6783	Czech	7387	Hebrew	7879	Norwegian	8479	Tonga
6789	Welsh	7465	Japanese	7982	Oriya	8482	Turkish
6865	Danish	7473	Yiddish	8065	Punjabi	8484	Tatar
6869	German	7487	Javanese	8076	Polish	8487	Twi
6890	Bhutani	7565	Georgian	8083	Pashto, Pushto	8575	Ukrainian
6976	Greek	7575	Kazakh	8084	Portuguese	8582	Urdu
6978	English	7576	Greenlandic	8185	Quechua	8590	Uzbek
6979	Esperanto	7577	Cambodian	8277	Rhaeto-Romance	8673	Vietnamese
6983	Spanish	7578	Kannada	8279	Romanian	8679	Volapük
6984	Estonian	7579	Korean	8285	Russian	8779	Wolof
6985	Basque	7583	Kashmiri	8365	Sanskrit	8872	Xhosa
7065	Persian	7585	Kurdish	8368	Sindhi	8979	Yoruba
7073	Finnish	7589	Kirghiz	8372	Serbo-Croatian	9072	Chinese
7074	Fiji	7665	Latin	8373	Singhalese	9085	Zulu

How images appear on your TV (aspect ratios of the screen)

The images on the TV screen depend on the type of software and the TV set.

Type of software	TV set (Screen mode)			
	4:3	16:9 ("FULL" mode)	16:9 ("ZOOM" mode)	16:9 ("AUTO" mode)
Wide-screen (pan and scan format) 	Right and left edges are cut off. 	Full screen 	Top and bottom edges are cut off. 	Full screen 
Wide-screen (not pan and scan format) 	Letterbox (with black bands at top and bottom) 			
Software (4:3) 	Full screen 	Screen horizontally enlarged 	Top and bottom edges are cut off. 	Full screen (with black bands at right and left) 
Software (4:3, Letterbox) 	Letterbox (with black bands at top and bottom) 	Screen horizontally enlarged (with black bands at top and bottom) 	Full screen 	Screen in which the picture at the far left and far right only is extended horizontally (with black bands at top and bottom) 

•The images which appear on the TV screen, and what each screen mode is called, depend on the manufacturer of the TV set and type of TV set. Consult the instruction manual provided with your TV set.

For your reference:

•Letterbox

Black bands are inserted at the top and bottom of the screen to fill in the gaps where the size of the picture is smaller than the screen.

•Pan and scan

Part of the wide-screen picture (either at both sides or one side of the screen) is automatically eliminated so that the picture fills the whole screen.

Using the remote control with your TV set

Preparations

Enter the two digit code for your TV (refer to the table) so it can be operated by the remote control. There may be some models where operation is not possible.

Press and hold the POWER button for the player and press the numeric buttons.

Try the different codes for the manufacturer of your TV to find one that works if there are two or more listed.

Code	Manufacturer	Code	Manufacturer
00	GE (OLD)	08	TOSHIBA 2
01	RCA	09	SAMSUNG
02	ZENITH	10	JVC
03	SONY	11	PANASONIC 1
04	MAGNAVOX	12	MITSUBISHI
05	TOSHIBA 1/ SANYO	13	SHARP
		14	HITACHI
06	CURTIS MATHES	15	PANASONIC 2
07	SEARS		

Note

- This operation must be repeated when the batteries are replaced.

Operation

To turn the TV on and off
Press **TV** POWER (⏻).

To select channels
Press **TV** CH ^ (to increase channel) or ∨ (to decrease channel).

To control the TV's volume
Press **TV** VOL + (to increase volume) or - (to decrease volume).

Note

- Not all TV models and brands can be operated with the universal remote control supplied.

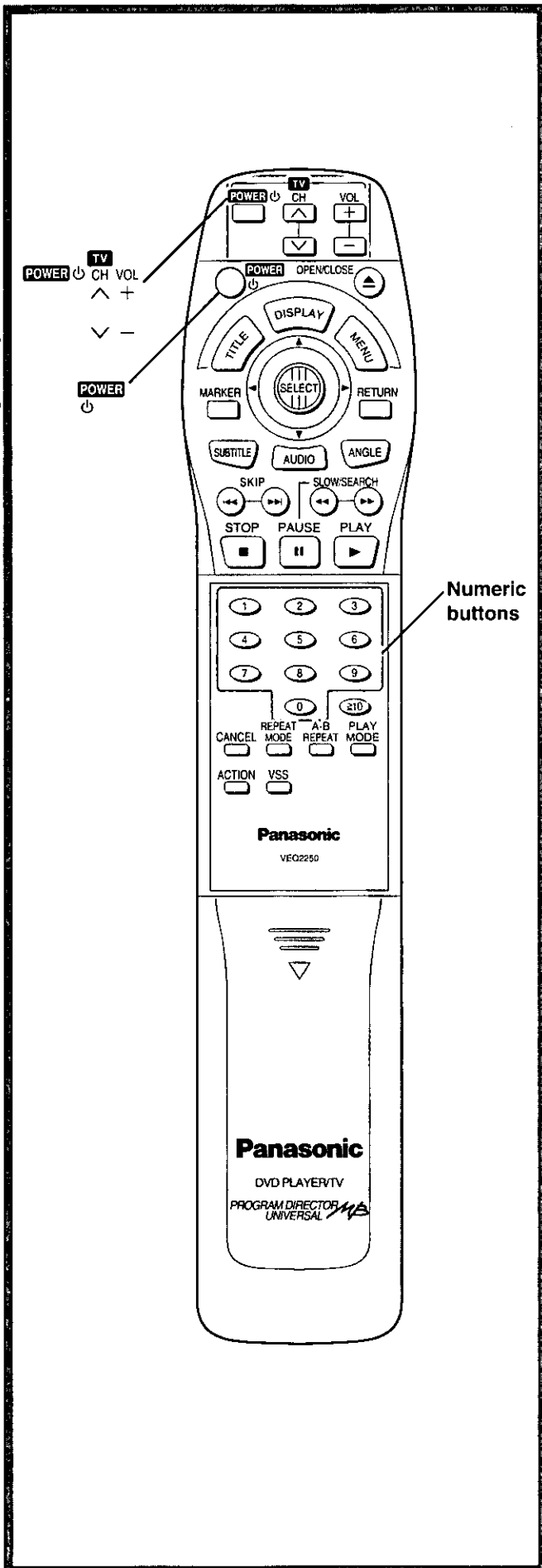

Troubleshooting

Before requesting service for this player, check the chart below for a possible cause of the problem you are experiencing. Some simple checks or a minor adjustment on your part may eliminate the problem and restore proper operation.

If you are in doubt about some of the check points, or if the remedies indicated in the chart do not solve the problem, consult your dealer for instructions.

[Consult PASC Authorized Servicers for detailed instructions, call 1-888-PANA-DVD (1-888-726-2383) or visit our home address www.panasonic.com/dvd for the address of an authorized factory servicer.]

Symptom (Common)	Remedy	Reference page
No power.	Insert the AC plug securely into the AC outlet.	8
The player is automatically set to the standby mode.	To conserve power, the player is automatically set to the standby mode after approx. 30 minutes have elapsed in the stop mode (Auto power-off function). Turn the power back to ON.	—
<ul style="list-style-type: none"> ● Play fails to start even when PLAY is pressed. ● Play starts but then stops immediately. 	<ul style="list-style-type: none"> ● Condensation has formed: wait about 1 to 2 hours for it to evaporate. ● This player cannot play discs other than DVD, Video CD and CD. ● The disc may be dirty and may require cleaning. ● Ensure that the disc is installed with the label of the side to be played facing upwards. 	— 4 47 14
No picture.	<ul style="list-style-type: none"> ● Ensure that the equipment is connected properly. ● Ensure that the input setting for the TV is Video. 	8, 9 —
<ul style="list-style-type: none"> ● No sound. ● Distorted sound. 	<ul style="list-style-type: none"> ● Ensure that the equipment is connected properly. ● Ensure that the input settings for the TV and stereo system are correct. ● Adjust the master volume using the On-Screen Menu Icons for player information. 	8–12 — 21
Picture is distorted during rapid advance or rapid reverse.	The picture will be somewhat distorted at times: this is normal.	—
No key operation (by the player and/or the remote control) is effective.	<ul style="list-style-type: none"> ● Some operations may be prohibited by the disc. ● Press POWER to set the player to the standby mode and then back to ON. Alternatively, press POWER to set the player to the standby mode, disconnect the AC cord and then reconnect it. (The player may not be operating properly due to lightning, static electricity or some other external factor.) 	— —
No 4:3 (16:9) picture.	Choose the setup "6 TV Aspect" item matching the TV set.	35
No on-screen display.	The "Off" setting is selected for "1 On-Screen Messages" in "4 On-Screen Messages": select "On".	33
No operations can be performed with the remote control.	<ul style="list-style-type: none"> ● To conserve power, the player is automatically set to the standby mode after approx. 30 minutes have elapsed in the stop mode (Auto power-off function). Turn the power back to ON. ● Check the batteries are installed with the correct polarities (+ and -). ● The batteries are depleted: replace them with new ones. ● Point the remote control at the remote control sensor and operate. ● Operate the remote control at a distance of not more than 23 feet (7 m) from the remote control sensor. ● Remove the obstacles between the remote control and remote control sensor. 	— 13 13 13 13 13

Symptom (Common)	Remedy	Reference page
TV set cannot be operated by the remote control.	Not all TV models and brands can be operated with the universal remote control supplied.	43
On-Screen Menu Icons not displayed or only partially displayed on the TV screen.	Change the position of the On-Screen Menu Icons using "2 Color and Position" in "4 On-Screen Messages" of the initial settings.	33
If you cannot solve your problem.	For customer service, please contact the Panasonic Customer Call Center at 1-888-PANA-DVD (1-888-726-2383) or visit our home address www.panasonic.com/dvd for further assistance.	—

Symptom (DVD)	Remedy	Reference page
No subtitles.	<ul style="list-style-type: none"> •Subtitles appear only with discs which contain them. •Subtitles are cleared from the TV monitor. Display the subtitles. 	— 27
Alternative audio soundtrack (or subtitle) languages fail to be selected.	<ul style="list-style-type: none"> •An alternative language is not selected with discs which do not contain more than one language. •In the case of some discs, the alternative language cannot be selected by operating the AUDIO or SUBTITLE button. Try selecting it from the DVD menu if one is available. 	— 29
Angle cannot be changed.	This function is dependent on software availability. Even if a disc has a number of angles recorded, these angles may be recorded for specific scenes only (when "ANGLE" lights up on the player's FL display).	—
Play does not start even when title is selected.	Confirm the "2 Ratings" setting.	31
Audio soundtrack and/or subtitle language is not the one selected at the initial settings.	If the audio soundtrack and/or subtitle language does not exist on the disc, the language selected at the initial settings will not be seen/heard.	—
The menu is displayed in French (example).	The setup "3 Menus" of "1 Disc Languages" is set to French: select English.	31
No surround sound.	<ul style="list-style-type: none"> •Choose the setting at "8 Speaker Setting" which matches your speaker system. •No surround sound is output when the virtual surround effect is activated ("VSS 1", "VSS 2", "Headphone VSS 1" or "Headphone VSS 2"). Select "VSS OFF" or "Headphone VSS OFF". 	37 28
The password for rating level has been forgotten. Reset all the settings to Factory Preset.	While the player is in the stop mode, hold the player's SKIP/SEARCH (◀◀/◀◀) button and the PAUSE button down simultaneously and then hold the OPEN/CLOSE button down for longer than 3 seconds (until "Initialized" disappears from the TV monitor). All initial settings will return to the default values. If you have selected "Lock All" in "2 Ratings", you must remove the DVD from the player before performing this operation. (See the note at the foot of page 30.)	— 30

Symptom (Video CD)	Remedy	Reference page
No menu play.	This function works only for Video CDs with playback control.	15

Troubleshooting

Self-diagnosis display function

When an error or trouble is detected during operation, a service number appears in the FL display.
When a service number has appeared, check out the details given below.

Service number	Player status	Remedy
U 1 1	Disc is dirty.	Wipe the disc clean.
H □ □ □ □ stands for a number.	Trouble is likely to have occurred. The number following "H" differs depending on the status of the player.	Press POWER to set the player to the standby mode and then back to ON. Alternatively, press POWER to set the player to the standby mode, disconnect the AC cord, and then reconnect it.

- If the service number fails to be cleared even when remedial action is taken, ask a service technician to repair the player.

Product service

Do not attempt to remove the cover(s) or repair the player yourself. Refer servicing to qualified personnel only.

Product information

For product service, product information or assistance with product operation, refer to the service center directory.

If you ship the product

Carefully pack and send it prepaid, adequately insured and preferably in the original carton. Attach a postage-affixed letter, detailing the complaint, to the outside of the carton. *DO NOT send the product to the Executive or Regional Sales offices. They are NOT equipped to make repairs.*

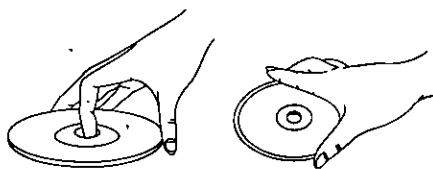
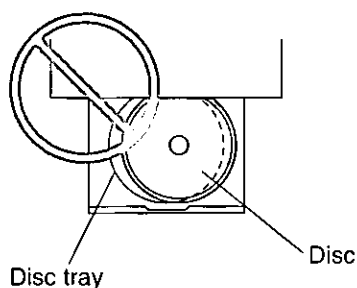
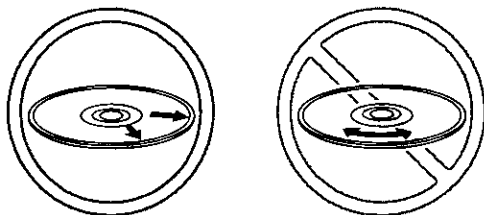
A**B****C**

Disc handling

Handling precautions

- Hold the disc by the edges so the surface will not be soiled with fingerprints. **(A)**
Fingerprints, dirt and scratches can cause skipping and distortion.
- Do not write on the label side.
- Do not use record cleaning sprays, benzene, thinner, static electricity prevention liquids or any other solvent.
- Be careful not to drop or bend the disc.
- Do not install more than 1 disc on the disc tray.
- Do not close the disc tray if the disc is not installed properly. **(B)**
- Store the disc in its case when not in use.

If the surface is soiled **(C)**

Wipe gently with a soft, damp (water only) cloth.
When wiping discs, always wipe from the center toward the outer edge.
(If you wipe using a circular motion, circular scratches can occur, which will cause noise.)

If the disc is brought from a cold to a warm environment, moisture may form on the disc

Wipe with a soft, dry, lint-free cloth before using the disc.

Improper disc storage

You can damage discs if you store them in the following places:

- Areas exposed to direct sunlight
- Humid or dusty areas
- Areas directly exposed to a heat outlet or heating appliance

Discs which cannot be played with this player

- DVD with Region No. other than "1" or "ALL"
- PAL discs
- DVD-ROM
- DVD-R/DVD-RAM
- CD-ROM
- VSD
- CDV
- CD-G
- CD-RW
- DVD+RW
- CVD
- SVCD
- Divx Video Disc
- etc.
- Do not try to play Photo CD or CD-R.
(Data on the disc may be damaged.)

Maintenance

- Be sure to press POWER to set the player to the standby mode and disconnect the AC cord before cleaning the player.
- Wipe this player with a dry, soft cloth.
If the surfaces are extremely dirty, wipe clean with a cloth which has been dipped in a weak soap-and-water solution and wrung out thoroughly, and then wipe again with a dry cloth.
- Never use alcohol, benzene, thinner, cleaning fluid or other chemicals. Do not use compressed air to remove dust.

Specifications

Power requirements: AC 120 V, 60 Hz
Power consumption: 20 W (approx. 1.7 W when set to the standby mode using either the power button or the remote control unit)

Signal system: NTSC
Weight: 7.0 lb. (3.2 kg)
Dimensions: 16¹⁵/₁₆" (W) × 10⁹/₁₆" (D) × 3¹⁵/₁₆" (H)
[430 (W) × 268 (D) × 99 (H) mm]
(excluding protrusions)

Operating temperature range:
+41 to +95°F (+5 to +35°C)

Operating humidity range:
5 to 90% RH (no condensation)

Discs played:

(1) DVD-VIDEO disc

5" (12 cm) single-sided, single-layer
5" (12 cm) single-sided, dual-layer
5" (12 cm) double-sided, single-layer
3" (8 cm) single-sided, single-layer
3" (8 cm) single-sided, dual-layer
3" (8 cm) double-sided, single-layer

(2) Compact disc (CD-DA, VIDEO CD)

5" (12 cm) disc
3" (8 cm) disc

Video output:

Output level: 1 Vp-p (75Ω)
Output connector: Pin jack
Number of connectors: 2 systems

S video output:

Y output level: 1 Vp-p (75Ω)
C output level: 0.286 Vp-p (75Ω)
Output connector: S terminal
Number of connectors: 1 system

Component video output:

Y output level: 1 Vp-p (75Ω)
P_B output level: 0.7 Vp-p (75Ω)
P_R output level: 0.7 Vp-p (75Ω)
Output connector: Pin jack
(Y: green, P_B: blue, P_R: red)

Audio output:

Output level: 2 Vrms (1 kHz, 0 dB)
Output connector: Pin jack
5.1ch mixed output (2ch): 1 system
5.1ch discrete output (5.1ch):
1 system

Audio signal output characteristics:

- (1) Frequency response:
 - DVD (linear audio): 2 Hz–22 kHz (48 kHz sampling)
2 Hz–44 kHz (96 kHz sampling)
 - CD audio: 2 Hz–20 kHz (EIAJ)
- (2) S/N ratio:
 - CD audio: 115 dB (EIAJ)
- (3) Dynamic range:
 - DVD (linear audio): 106 dB
 - CD audio: 100 dB (EIAJ)
- (4) Total harmonic distortion:
 - CD audio: 0.002% (EIAJ)

Digital audio output:

Optical digital output: Optical connector
Coaxial digital output: Pin jack

Pickup: Wave length: 665 nm
Laser power: CLASS II

Specifications are subject to change without notice.
Weight and dimensions are approximate.

Apparatus Claims of U.S. Patent Nos. 4,631,603, 4,577,216, and 4,819,098, licensed for limited viewing uses only.

This product incorporates copyright protection technology that is protected by method claims of certain U.S. patents and other intellectual property rights owned by Macrovision Corporation and other rights owners. Use of this copyright protection technology must be authorized by Macrovision Corporation, and is intended for home and other limited viewing uses only unless otherwise authorized by Macrovision Corporation. Reverse engineering or disassembly is prohibited.

Panasonic Consumer Electronics Company,
Division of Matsushita
Electric Corporation of America
One Panasonic Way Secaucus,
New Jersey 07094
<http://www.panasonic.com>

Panasonic Sales Company,
Division of Matsushita Electric of
Puerto Rico, Inc. ("PSC")
Ave. 65 de Infantería, Km. 9.5
San Gabriel Industrial Park, Carolina,
Puerto Rico 00985

© 1999 Matsushita Electric Industrial Co., Ltd.

Printed in Japan



VQT8107
F0799MF0 (D)

Free Manuals Download Website

<http://myh66.com>

<http://usermanuals.us>

<http://www.somanuals.com>

<http://www.4manuals.cc>

<http://www.manual-lib.com>

<http://www.404manual.com>

<http://www.luxmanual.com>

<http://aubethermostatmanual.com>

Golf course search by state

<http://golfingnear.com>

Email search by domain

<http://emailbydomain.com>

Auto manuals search

<http://auto.somanuals.com>

TV manuals search

<http://tv.somanuals.com>