

Panasonic

DVD/VIDEO CD/CD PLAYER

Operating Instructions



The photographs show DVD-CV40.

Model No. **DVD-CV40**
DVD-CV35

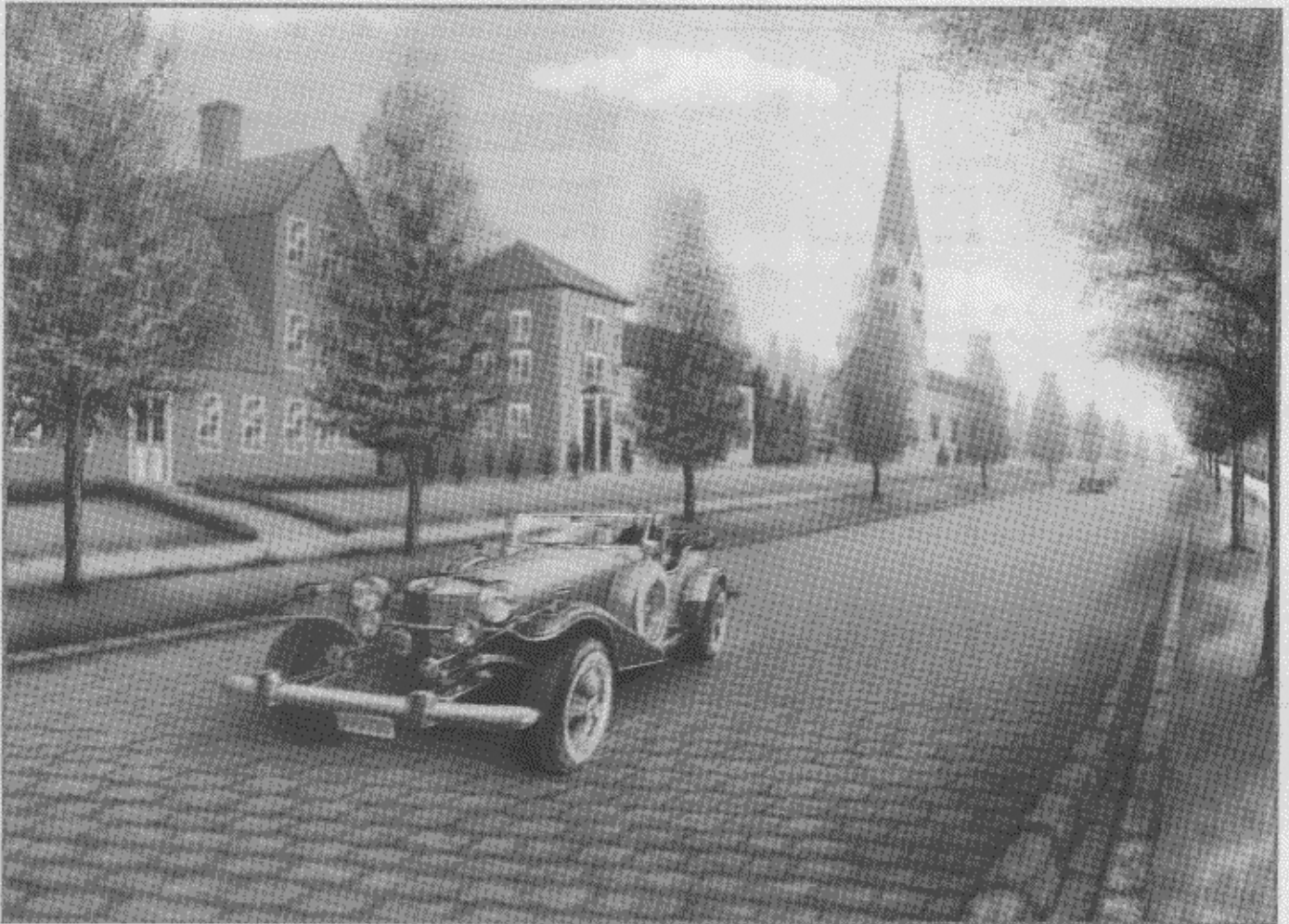

Before connecting, operating or adjusting this product, please read these instructions completely.
Please keep this manual for future reference.

U



This manual was printed with soy based ink.

RQT5613-P

Dear customer

Thank you for purchasing this product.
For optimum performance and safety, please read these instructions carefully.

Marks used in these operating instructions

- DVD**: indicates features applicable to DVD only.
- VCD**: Video CD only.
- CD**: CD only.

Accessories



Please check and identify the supplied accessories.
Use numbers indicated in parentheses when asking for replacement parts.

To order accessories contact 1-800-332-5368 or web site (<http://www.panasonic.com>).



- Remote control 1
(RAK-DV964WK)

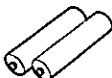

- Batteries 2
for remote control



- AC power supply cord 1
(RJA0065-A)

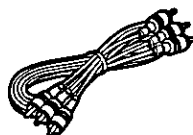

- Audio/video cable 1
(VJA0788-D)

Optional accessories

S video cable (⇒ page 9)
Optical digital audio cable (⇒ pages 34 and 35)

Note

- The included AC power supply cord is for use with this unit only.
Do not use it with other equipment.

User memo:

DATE OF PURCHASE _____
 DEALER NAME _____
 DEALER ADDRESS _____

 TELEPHONE NUMBER _____

The model number and serial number of this product can be found on either the back or the bottom of the unit.
Please note them in the space provided below and keep for future reference.

MODEL NUMBER _____
 SERIAL NUMBER _____

Table of contents

Getting Started

Accessories	2
SAFETY INFORMATION	3
PRECAUTIONS	4
Remote control preparations	5
Control reference guide	6
Disc information	8
Connection to a television	9

Basic Operations

Basic play	11
When a menu screen appears on the TV monitor	12
Stopping play	12
Skipping discs	13
Other methods of play	14
Still picture (Pause)/Skipping chapters or tracks/ Frame advance (Frame reverse)	14
Slow-motion play/Rapid advance (Rapid reverse)	15
Canceling playback control/Using menus to play	16

Advanced Operations

Advanced operations	17
Changing soundtrack language	17
Changing subtitle language	18
Viewing from another angle	18
Repeat play	19
Repeating sections between two specific points (A-B repeat)	19
Changing picture quality for movie viewing	20
Raising dialogue volume	20
Reproducing an advanced Virtual Surround Sound (V.S.S.) effect	21
Program play	22
Random play	23
Using On-Screen Menu Icons	24
Common procedures	24
Detailed descriptions of each icon	25
Changing initial settings	27
Common procedures	27
1 Disc Languages	28
2 Ratings	29
3 Menu Language/4 On-Screen Messages/5 FL Display ..	30
9 Other Settings	31
How different kinds of software appear on your television	32

Home Theater

Home theater	33
Connecting an amplifier with a built-in decoder	34
Connecting audio equipment with digital audio input terminals	35
Connecting audio equipment with 2-channel audio input terminals	35
Selecting digital output	36

For Your Reference

Troubleshooting Guide	38
Product Service	40
Before moving the unit	40
Maintenance	40
Disc handling	41
Servicenter List	42
Specifications	43

SAFETY INFORMATION

CAUTION!

THIS PRODUCT UTILIZES A LASER.
USE OF CONTROLS OR ADJUSTMENTS OR PERFORMANCE OF PROCEDURES OTHER THAN THOSE SPECIFIED HEREIN MAY RESULT IN HAZARDOUS RADIATION EXPOSURE.
DO NOT OPEN COVERS AND DO NOT REPAIR YOURSELF. REFER SERVICING TO QUALIFIED PERSONNEL.

WARNING:

TO REDUCE THE RISK OF FIRE, ELECTRIC SHOCK OR PRODUCT DAMAGE, DO NOT EXPOSE THIS APPLIANCE TO RAIN, SPLASHING, DRIPPING OR MOISTURE.

CAUTION:

TO PREVENT ELECTRIC SHOCK MATCH WIDE BLADE OF PLUG TO WIDE SLOT, FULLY INSERT.

FCC NOTE:

This equipment has been tested and found to comply with the limits for a Class B digital device, pursuant to Part 15 of the FCC Rules. These limits are designed to provide reasonable protection against harmful interference in a residential installation. This equipment generates, uses and can radiate radio frequency energy and, if not installed and used in accordance with the instructions, may cause harmful interference to radio communications. However, there is no guarantee that interference will not occur in a particular installation. If this equipment does cause harmful interference to radio or television reception, which can be determined by turning the equipment off and on, the user is encouraged to try to correct the interference by one or more of the following measures:

- Reorient or relocate the receiving antenna.
- Increase the separation between the equipment and receiver.
- Connect the equipment into an outlet on a circuit different from that to which the receiver is connected.
- Consult the dealer or an experienced radio/TV technician for help.

FCC Caution: To assure continued compliance, follow the attached installation instructions and use only shielded cables when connecting to other devices. Also, any changes or modifications not expressly approved by the party responsible for compliance could void the user's authority to operate this equipment.

DANGER	LASER RADIATION WHEN OPEN AVOID DIRECT EXPOSURE TO BEAM.	(Inside of product)
DANGERS	RADIATION LASER LORSQVE OUVERT, EVITER TOUTE EXPOSITION AU FAISCEAU.	(Intérieur de l'appareil)
ADVARSEL	LASERSTRÅLING VED ÅBNING. NÅR SIKKERHEDSÅBRYDERE ER UDE AF FUNKTION. UNDGÅ UDSÆTTELSE FOR STRÅLING.	(Indersiden af apparatet)
VARO!	AVAITAESSA JA SUJALUKUTUS OHITETTAESSA OLET ALTUINA LASERSÄTELYLLE. ÄLÄ KATSO SÄTESEEN.	(Tuotteen sisällä)
VARNING	LASERSTRÅLING NÅR DENNA DEL ÄR ÖPPNAD OCH SPARREN ÄR URKOPPLAD. BETRÄKTA EJ STRÅLEN.	(Apparatens insida)
ADVARSEL	LASERSTRÅLING NÅR DEKSEL ÅPNES OG SIKKERHEDSLÅS BRYTES. UNNGÅ EKSPONERING FOR STRÅLEN.	(Produktets innsida)
VORSICHT	LASERSTRAHLUNG, WENN ABDECKUNG GEÖFFNET. NICHT DEM STRAHL AUSSETZEN.	(Im Inneren des Gerätes)





CAUTION

**RISK OF ELECTRIC SHOCK
DO NOT OPEN**



CAUTION: TO REDUCE THE RISK OF ELECTRIC SHOCK, DO NOT REMOVE SCREWS. NO USER-SERVICEABLE PARTS INSIDE. REFER SERVICING TO QUALIFIED SERVICE PERSONNEL.

 The lightning flash with arrowhead symbol, within an equilateral triangle, is intended to alert the user to the presence of uninsulated "dangerous voltage" within the product's enclosure that may be of sufficient magnitude to constitute a risk of electric shock to persons.

 The exclamation point within an equilateral triangle is intended to alert the user to the presence of important operating and maintenance (servicing) instructions in the literature accompanying the appliance.

PRECAUTIONS

Before using this unit please read these operating instructions carefully. Take special care to follow the warnings indicated on the unit itself as well as the safety suggestions listed below. Afterwards keep them handy for future reference.

Safety

- 1. Power Source**—The unit should be connected to a power supply only of the type described in the operating instructions or as marked on the unit. If you are not sure of the type of power supply to your home, consult your appliance dealer or local power company.
- 2. Polarization**—If the unit is equipped with a polarized AC power plug (a plug having one blade wider than the other), that plug will fit into the AC outlet only one way. This is a safety feature. If you are unable to insert the plug fully into the outlet, try reversing the plug. If the plug should still fail to fit, contact your electrician to replace your obsolete outlet. Do not defeat the safety purpose of the polarized plug.
- 3. Power Cord Protection**—AC power supply cords should be routed so that they are not likely to be walked on or pinched by items placed upon or against them. Never take hold of the plug or cord if your hand is wet, and always grasp the plug body when connecting or disconnecting it.
- 4. Overloading**—Do not overload wall outlets and extension cords as this can result in a risk of fire or electric shock.
- 5. Nonuse Periods**—When the unit is not being used, turn the power off. When left unused for a long time, the unit should be unplugged from the household AC outlet.
- 6. Attachments**—Do not use attachments not recommended by the unit manufacturer as they may cause hazards.

Installation

Environment

- 1. Water and Moisture**—Do not use this unit near water—for example, near a bathtub, washbowl, swimming pool, or the like. Damp basements should also be avoided.
- 2. Condensation**—Moisture may form on the lens in the following conditions...
 - immediately after a heater has been turned on.
 - in a steamy or very humid room.
 - when the unit is suddenly moved from a cold environment to a warm one.If moisture forms inside this unit, it may not operate properly. To correct this problem, turn on the power and wait about one hour for the moisture to evaporate.
- 3. Heat**—The unit should be situated away from heat sources such as radiators and the like. It also should not be placed in temperatures less than 5 °C (41 °F) or greater than 35 °C (95 °F).

Placement

- 1. Ventilation**—The unit should be situated so that its location or position does not interfere with its proper ventilation. Allow 10 cm (4") clearance from the rear of the unit.
- 2. Foreign Material**—Care should be taken so that objects do not fall into and liquids are not spilled into the unit. Do not subject this unit to excessive smoke, dust, mechanical vibration, or shock.
- 3. Carts and Stands**—The unit should be used only with a cart or stand that is recommended by the manufacturer. The unit and cart combination should be moved with care. Quick stops, excessive force, and uneven surfaces may cause the unit and cart combination to overturn.
- 4. Mounting**—Any mounting of the appliance should follow the manufacturer's instructions, and should use a mounting accessory recommended by the manufacturer.



Maintenance

Disconnect this unit from the AC outlet before cleaning. Clean the cabinet, panel and controls with a soft cloth lightly moistened with a mild detergent solution. Do not use any type of abrasive pad, scouring powder or solvent such as alcohol or benzene.

Service

- 1. Damage Requiring Service**—The unit should be serviced by qualified service personnel when:
 - (a) The AC power supply cord or the plug has been damaged; or
 - (b) Objects have fallen or liquid has been spilled into the unit; or
 - (c) The unit has been exposed to water; or
 - (d) The unit does not appear to operate normally or exhibits a marked change in performance; or
 - (e) The unit has been dropped, or the enclosure damaged.
- 2. Servicing**—The user should not attempt to service the unit beyond that described in the operating instructions. All other servicing should be referred to an authorized service personnel.

For the address of an authorized servicer:
*In the U.S.A., call 1-800-211-7262,
e-mail consumerproducts@panasonic.com,
or visit www.panasonic.com
In Canada, call 1-800-561-5505
or visit www.panasonic.ca*
- 3. Replacement parts**—When parts need replacing, ensure the servicer uses parts specified by the manufacturer or parts that have the same characteristics as the original parts. Unauthorized substitutes may result in fire, electric shock, or other hazards.
- 4. Safety check**—After repairs or service, ask the servicer to perform safety checks to confirm that the unit is in proper working condition.

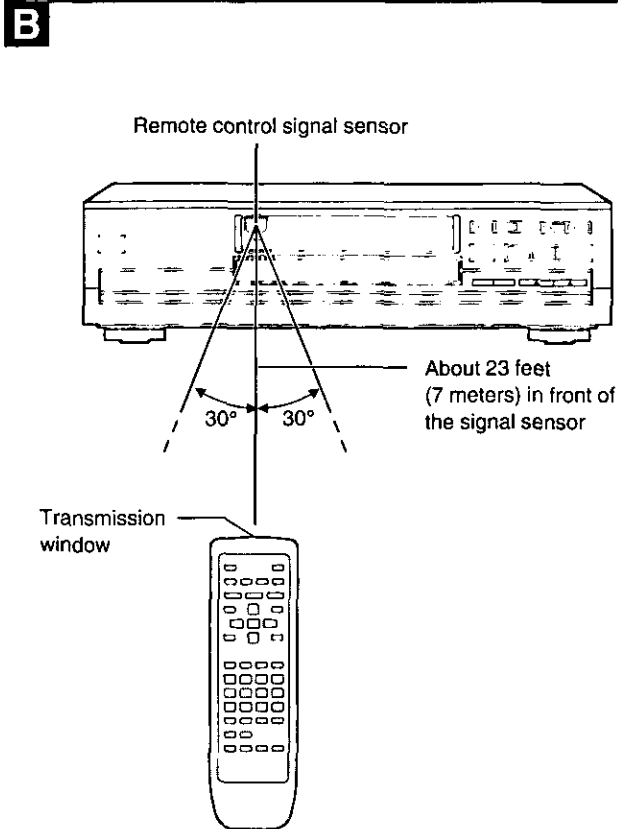
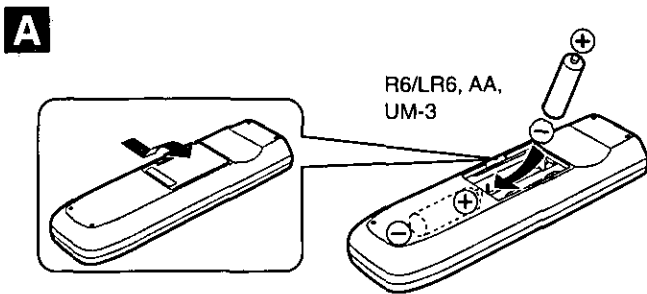

A Battery installation

Use of batteries

- Align the poles (+ and -) properly when inserting the batteries.
- Do not mix old and new batteries or different types of batteries.
- Do not recharge ordinary dry cell batteries.
- Do not heat or disassemble the batteries. Do not allow them to contact flame or water.
- Remove the batteries if the unit is not to be used for a long time.
- Do not keep together with metallic objects such as necklaces.
- Do not use rechargeable type batteries.
- Do not use batteries if the covering has been peeled off.

Mishandling of batteries can cause electrolyte leakage which can damage items the fluid contacts and may cause a fire.

If electrolyte leaks from the batteries, consult your dealer.

Wash thoroughly with water if electrolyte comes in contact with any part of your body.

B Correct method of use

Operation notes

- Do not place obstacles between the remote control signal sensor and remote control unit.
- Do not expose the remote control signal sensor to direct sunlight or to the bright light of a fluorescent light.
- Take care to keep the remote control signal sensor and end of the remote control unit free from the dust.
- If this system is installed in a rack with glass doors, the glass doors' thickness or color might make it necessary to use the remote control a shorter distance from the system.

To prevent damage

- Never place heavy items on top of the unit.
- Do not disassemble or reconstruct the unit.
- Do not spill water or other liquids into the unit.

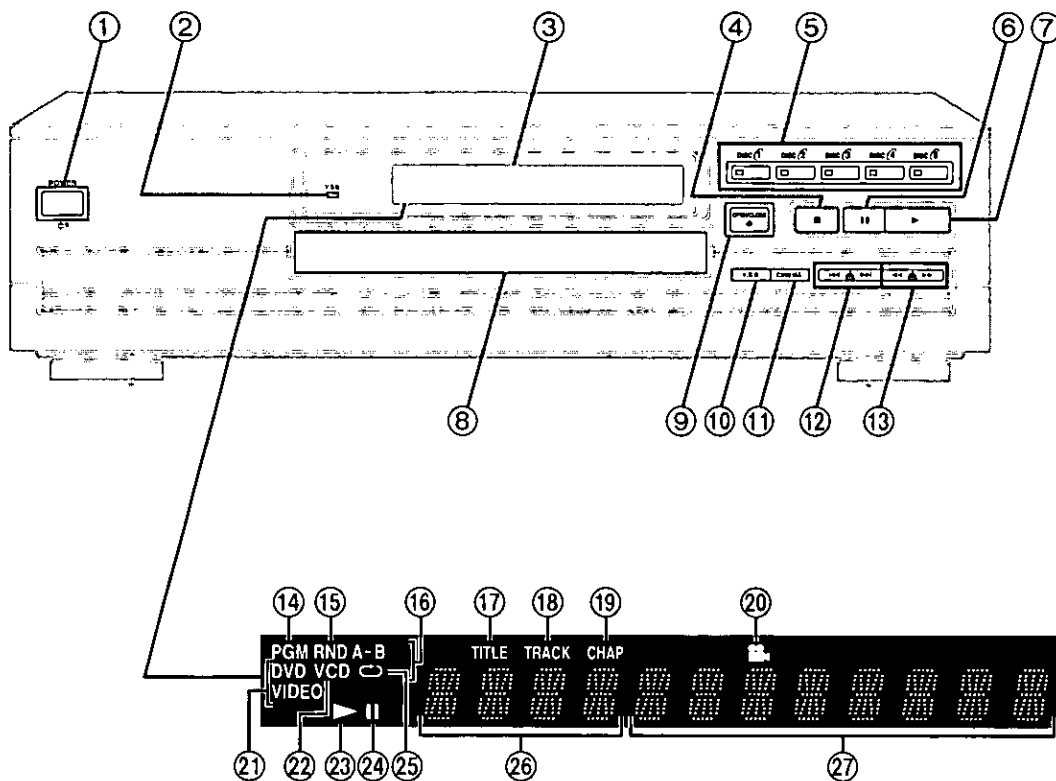

Main unit



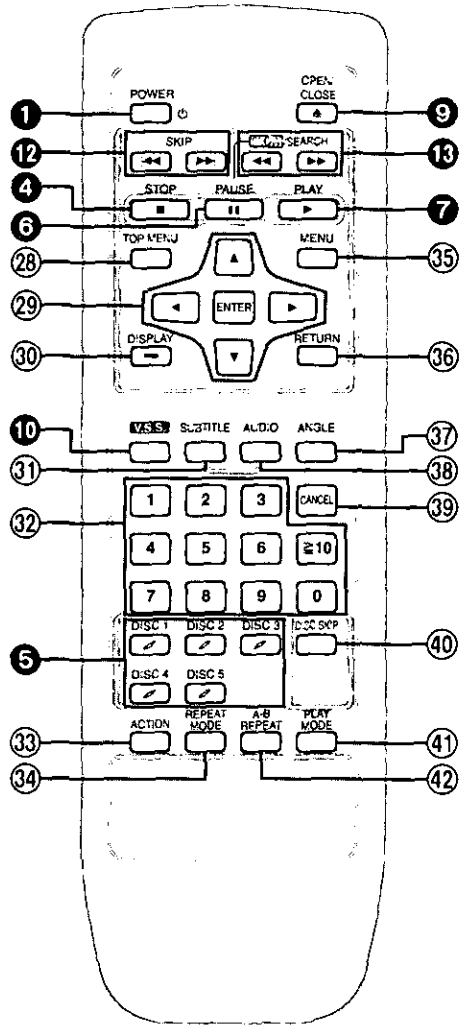

Page

- | | | |
|--|--------|---|
| ① Standby/on button (POWER, ⏻) | 11 | ⑭ Illuminates during program play. [VCD] [CD] |
| Press to switch the unit from on to standby mode or vice versa.
In standby mode, the unit is still consuming a small amount of power. | | ⑮ Illuminates during random play. [VCD] [CD] |
| ② Virtual Surround Sound indicator (V.S.S.) | 21 | ⑯ Illuminates during A-B repeat play. |
| ③ FL display | | ⑰ Illuminates during play of a title. [DVD] |
| ④ Stop button (\blacksquare) | 12 | ⑱ Illuminates during play of a track. [VCD] [CD] |
| ⑤ Disc 1-5 buttons/indicators (DISC 1-5) | 11, 13 | ⑲ Illuminates during play of a chapter. [DVD] |
| ⑥ Pause button (⏸) | 14 | ⑳ Illuminates when you can change the angle. [DVD] |
| ⑦ Play button (\blacktriangleright) | 11 | ㉑ Illuminates when the unit reads a DVD. |
| ⑧ Disc tray | 11 | ㉒ Illuminates when the unit reads a Video CD or CD. |
| ⑨ Disc tray open/close button (\blacktriangle OPEN/CLOSE) | 11 | ㉓ Illuminates during play.
Flashes when the RESUME function is ON. |
| ⑩ Virtual Surround Sound button (V.S.S.) | 21 | ㉔ Illuminates in the still picture (pause) mode. |
| ⑪ Cinema button (CINEMA) | 20 | ㉕ Illuminates during repeat play. |
| ⑫ Skip buttons (\blacktriangleleft , \blacktriangleright) | 12, 14 | ㉖ Shows the Title/chapter number [DVD] |
| ⑬ Search buttons (\blacktriangleleft , \blacktriangleright) | 15 | Shows the Track number [VCD] [CD] |
| | | ㉗ Shows the elapsed play time from the start of the title/track during play |



Buttons such as 1 function in exactly the same way as the buttons on the main unit.

28	Top menu button (TOP MENU)	12, 16
29	Cursor buttons (▲, ▼, ◀, ▶)/ Enter button (ENTER)	10, 12
30	Display button (DISPLAY)	24
31	Subtitle button (SUBTITLE)	18
32	Numeric buttons (1-9, 0, ≧10)	12
	•To select a 2-digit number	
	Example: To select track 23	
	Press [≧10], then [2] and [3].	
33	Action button (ACTION)	27
34	Repeat mode button (REPEAT MODE)	19
35	Menu button (MENU)	12, 16
36	Return button (RETURN)	10
37	Angle button (ANGLE)	18
38	Audio button (AUDIO)	17
39	Cancel button (CANCEL)	23
40	Disc skip button (DISC SKIP)	11, 13
41	Play mode button (PLAY MODE)	22
42	A-B repeat button (A-B REPEAT)	19

 Discs supported by this unit	 Discs not supported by this unit
DVD-Video  3" (8 cm) disc/ 5" (12 cm) disc	<ul style="list-style-type: none"> ● Do not try to play Photo CD or CD-R. (Data on the disc may be damaged.) ● DVD with region number other than "1" or "ALL" ● PAL discs ● DVD-ROM ● DVD-R ● DVD-RW ● CVD ● CDV etc. <ul style="list-style-type: none"> ● CD-G ● CD-RW ● DVD-RAM ● SVCD ● SACD <ul style="list-style-type: none"> ● Divx Video Disc ● DVD-Audio ● DVD+RW ● CD-ROM ● VSD
Video CD  3" (8 cm) disc/ 5" (12 cm) disc	
Audio CD  3" (8 cm) disc/ 5" (12 cm) disc	

For the purpose of these operating instructions, "DVD" stands for DVD-Video and "CD" stands for Audio CD.

■ Region number supported by this player

Region numbers are allocated to DVD players and software according to where they are sold.

- The region number of this unit is "1".
- The unit will play DVDs marked with labels containing the region number "1" or "ALL".

Example:



■ Terms used in these operating instructions

● Title/Chapter [DVD]

DVDs are divided up into large sections, titles, and smaller sections, chapters. The numbers allocated to these sections are called title numbers and chapter numbers.

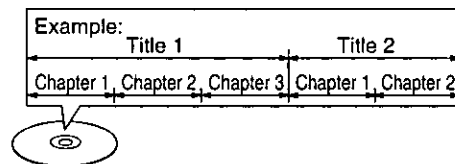

■ Playing DVDs and Video CDs

The producer of the material can control how these discs are played. This means that you may not be able to control play of a disc with some operations described in these operating instructions. Read the disc's instructions carefully.

Example: ● "⊙" appears when you press the skip buttons to move to the next section.

- Resume, repeat play, and markers may not work during play of interactive DVDs and menu play of Video CDs with playback control.
- After showing the Karaoke menu, tracks are played successively without returning to the menu (Video CD with playback control).

● Track [VCD] [CD]

Video CDs and CDs are divided up into sections called tracks, and the numbers allocated to these sections are called track numbers.

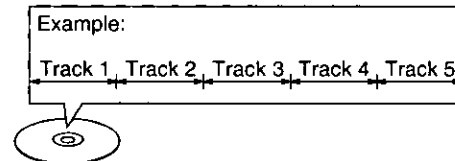

● Playback control [VCD]

If a Video CD has "playback control" written on its disc or jacket, it means that particular scenes or information can be selected for viewing interactively with the TV monitor using the menu screen. This unit can play Video CDs with playback control. Using menus to control play of a Video CD is called "menu play" in these operating instructions.

Display during menu play of a Video CD with playback control

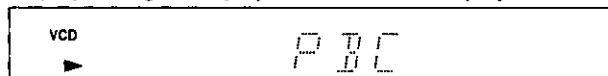

● Interactive DVD [DVD]

An interactive DVD is DVD software which includes multiple angles, multiple plot endings, etc. The elapsed play time of some of these DVDs is not shown.

Display during play of an interactive DVD

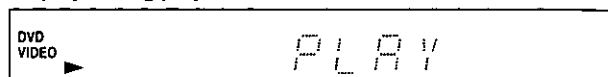

Connection to a television

- Ensure that this unit and other equipment to be connected are switched to the standby mode or off and disconnect the AC power supply cord before commencing connection.
- Do not block ventilation holes of any of the equipment and arrange them so that air can circulate freely.
- Read through the instructions before connecting other equipment.
- Ensure that you observe the color coding when connecting audio and video cables.
- See page 33 for information about how to upgrade your system with other audio/visual equipment.

Note

- Peripheral equipment and optional cables sold separately unless otherwise indicated.
- TV volume may be lower when playing DVDs than during television broadcasts. Turn the volume up while playing DVDs and reduce it to the previous level **before** switching the source back to television to avoid sudden changes in volume.
- When you have finished connection, select the appropriate screen type at the initial setting "6 TV Aspect" according to your television (4:3/16:9) (→ page 10). No changes are needed if you connect the unit to a conventional television (4:3).
- If the unit is connected to a switched outlet on an AV amplifier and the amplifier is turned off, the unit is effectively disconnected from the AC power supply. We recommend that you connect the unit directly to an household AC outlet.

Conserving power

- The unit consumes approx. 2.0 W even when it is turned off with [POWER \odot /I]. To save power when the unit is not to be used for a long time, unplug it from the household AC outlet.

Connect Your Unit Directly To Your Television.

If the unit is connected to the television through a video cassette recorder, the picture may not be played correctly due to the copy guard. So we strongly recommend you do not connect the unit to your video cassette recorder when setting up your home entertainment system.

- Connect to the television section if you connect the unit to a combined television-video player.

Do not place the unit on amplifiers or other equipment which may become hot.

The heat can damage the unit.

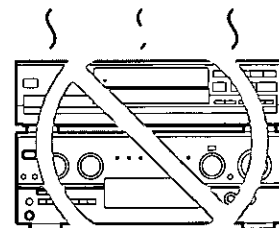

Connecting to a television with video input terminal or S video input terminal

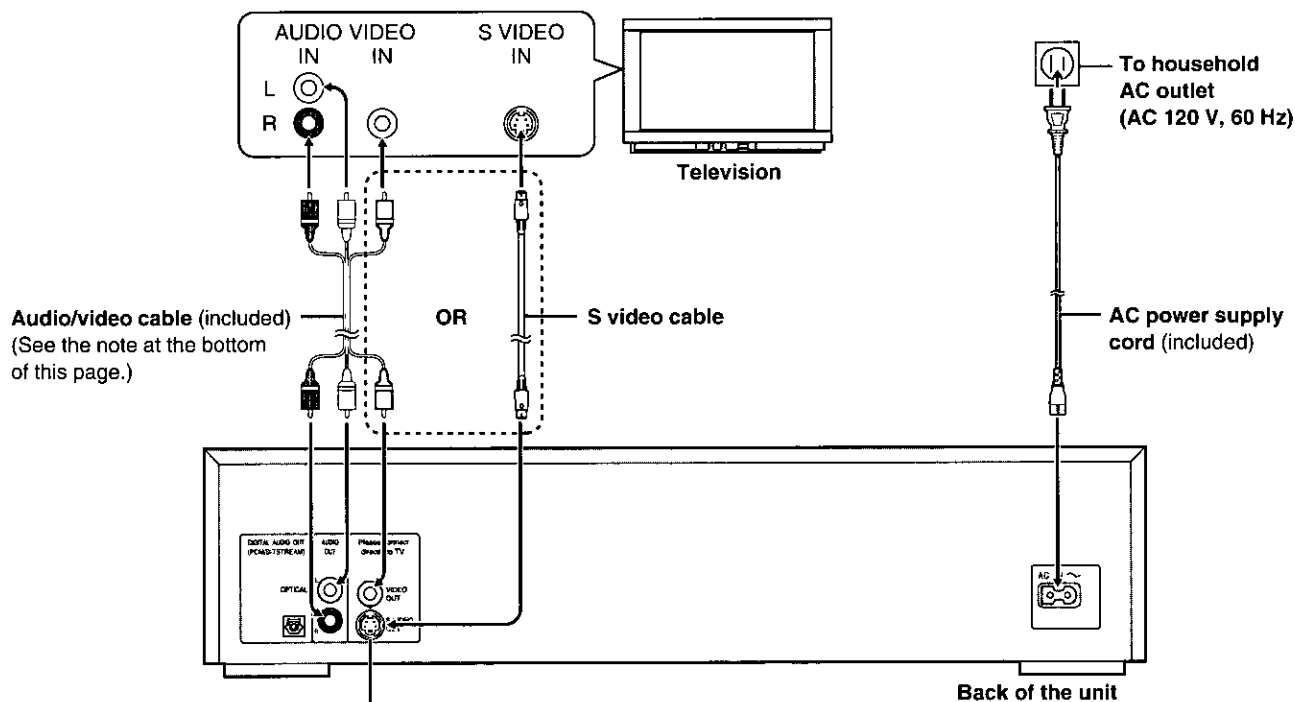

S video output terminal

The S (separate) video output terminal achieves a clearer picture than the video output terminal by separating the chrominance (C) and luminance (Y) signals before transmitting them to the television. (Actual results depend on the television.)

Note

- If your television is monaural, use a stereo-monaural audio cable instead of the supplied audio/video cable. The video part of the cable (yellow) can still be used if required.

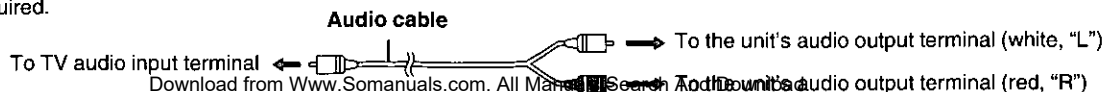

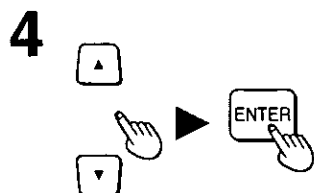
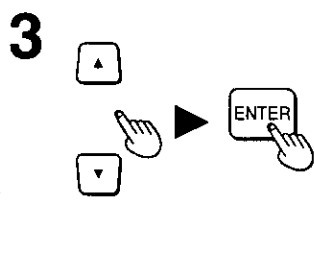
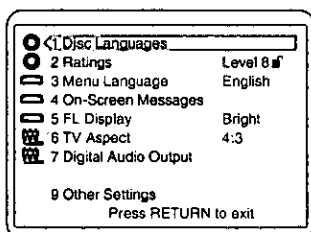
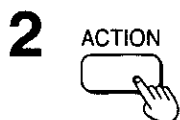
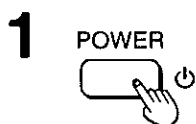
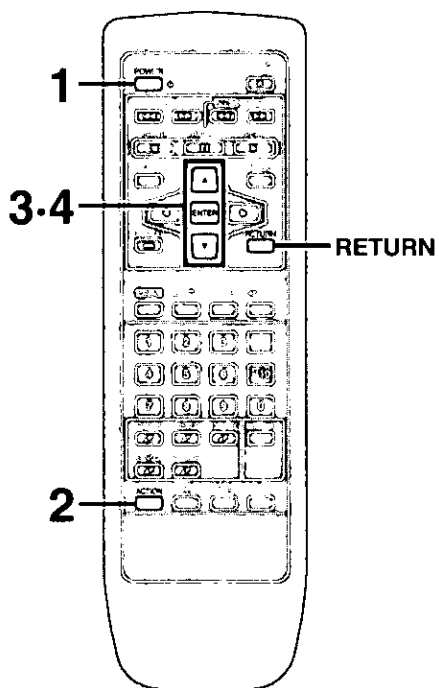

Connection to a television

■ Before enjoying DVD/Video CD/CD

The menu language for this unit has been set to English, but you can change the language to French or Spanish (→ "3 Menu Language", page 30). English has been used in the examples shown.

Selecting TV screen type

Select the TV aspect, conventional size screen (4:3) or widescreen (16:9) according to your television.

Preparations

- Ensure connections to your television and audio equipment are correct.
- Turn on your television and other equipment.
- Switch the video input mode on the television to suit the type of connection you have made (e.g., VCR 2).

1 Press [POWER] to switch on the power.

2 Press [ACTION] in the stop mode.
The initial settings screen is displayed.

3 Press the cursor buttons [], [] to select "6 TV Aspect" and press [ENTER].

4 Press the cursor buttons [], [] to select a TV aspect and press [ENTER].

- 1 4:3 (Factory preset)
Select when a conventional television is connected.
- 2 16:9
Select when a widescreen television is connected.

Setting is finished and the initial settings screen in step 2 is displayed.

To cancel during setup operation

Press [RETURN]. (The previous screen is displayed.)

To exit the initial settings screen

Press [ACTION] or [RETURN].

For your reference

For further details on the images which appear on the TV screen, see page 32.

Basic play

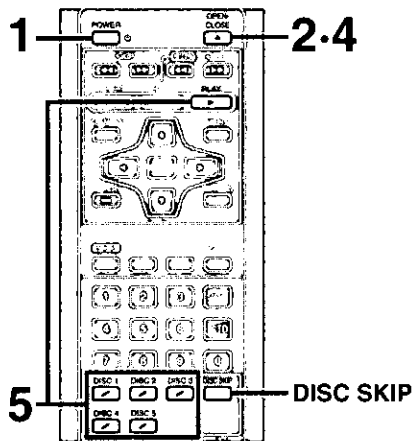
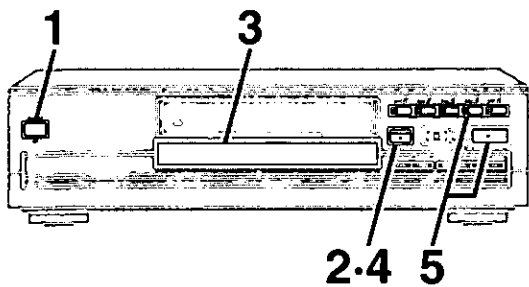

Preparations

- Ensure connections to your television and audio equipment are correct.
- Turn on your television and other equipment.
- Switch the video input mode on the television to suit the type of connection you have made (e.g., VCR 2).

1 Press [POWER \odot /I] to switch on the power.
The disc indicator in the play position lights.

2 Press [\blacktriangle OPEN/CLOSE] to open the disc tray.
The disc indicator flashes.

3 Place the disc on the disc tray.

- Insert inside the guides.
- Do not load more than one disc.

4 Press [\blacktriangle OPEN/CLOSE] to close the disc tray.

- The closed tray is in the play position (its disc indicator lights).
- Some discs start playing automatically.

Note

- Do not close the disc tray by hand.

5 To start play from the disc in the play position, Press [\blacktriangleright].

or

To start play from another disc,
Press [DISC 1–5] to select the disc.
Example: To play disc 1, press [DISC 1].

Play begins.

■ To load other trays

Press [DISC 1–5] to select another tray and press [\blacktriangle OPEN/CLOSE] to open the tray.

Note

- All the discs loaded in the disc trays will be played sequentially. Pressing [DISC SKIP] may be necessary to proceed to the next disc after play of DVDs and Video CDs with playback control.
- When a menu screen appears on the TV monitor, see page 12.

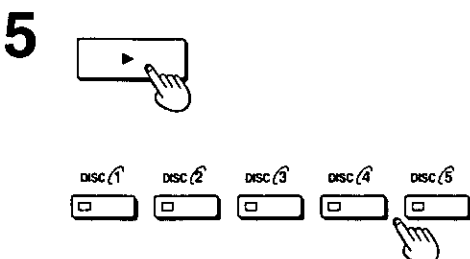
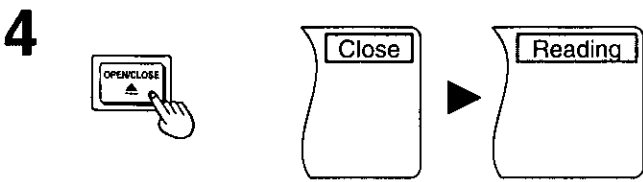
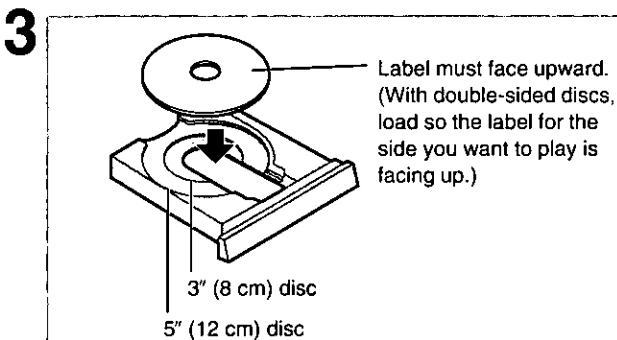
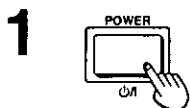

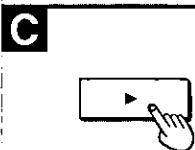
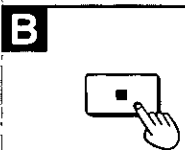
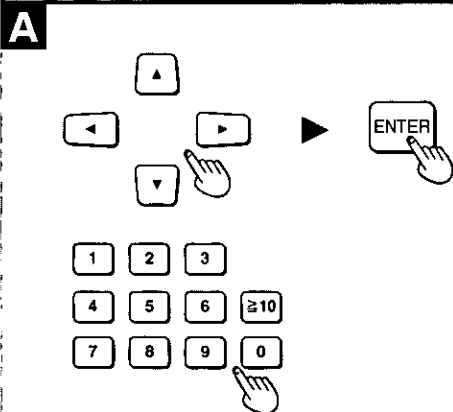
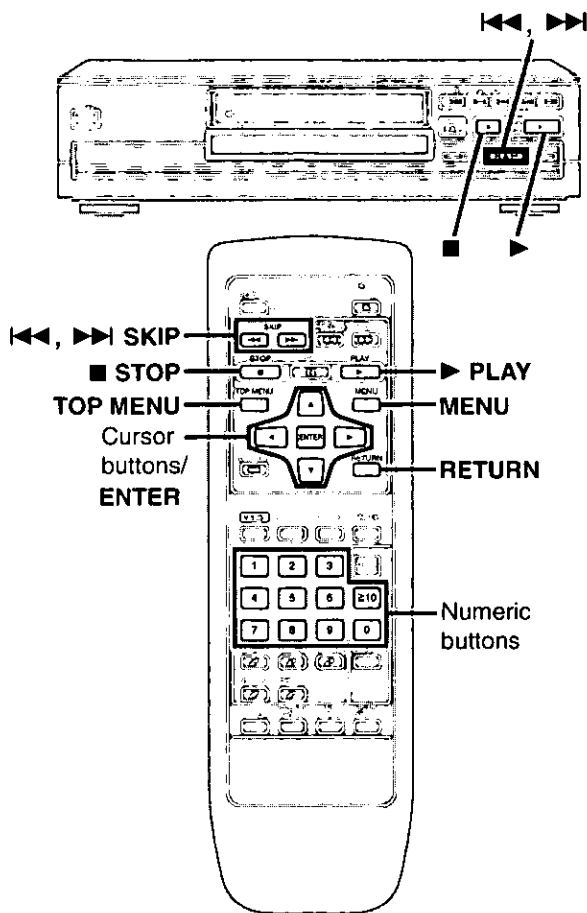

Basic play

A When a menu screen appears on the TV monitor

DVD VCD

Press the cursor buttons [\blacktriangle , \blacktriangledown , \blacktriangleleft , \blacktriangleright] and press [ENTER], or press the numeric buttons, to select the item.

Play of the selected item now begins.

- The cursor buttons are not effective for selecting items on Video CDs.

To select a 2-digit number using numeric buttons

Example: To select track 23

Press [\blacktriangleright 10], then [2] and [3].

Other buttons used to operate menus

Read the disc's instructions for further details about operation.

[\blacktriangleright SKIP]: Shows the next menu.

[\blacktriangleleft SKIP]: Shows the previous menu.

[RETURN]: Shows the menu screen.

[TOP MENU]: Shows the first menu screen. [DVD]

[MENU]: Shows the menu screen. [DVD]

Note

- "NO PLAY" is displayed on the FL display if you load the following kinds of discs:
 - DVD for which play is prohibited by the initial settings "2 Ratings" (\Rightarrow page 29).
 - DVD with a region number other than "1" or "ALL" (\Rightarrow page 8).
- If " \odot " appears on the TV monitor when a button is pressed, the operation is prohibited by the unit or disc.

B Stopping play

Press [■] during play.

- The unit records the point where [■] was pressed during play. (" \triangleright " flashes on the unit's FL display.)

C To resume play from where you stopped (RESUME function)

Press [\blacktriangleright] while " \triangleright " is flashing on the FL display.

Play will resume from the point where [■] was pressed.

To clear the RESUME function

Press [■] again while " \triangleright " is flashing on the FL display.

Note

- The RESUME function works only with titles for which the elapsed play time appears on the unit's FL display during play.
- This feature remains active if the unit is switched to the standby mode and then turned back ON, but is cleared if the AC power supply cord is disconnected unless you were playing a disc on tray 1.

POWER Disc 1-5 buttons/indicators

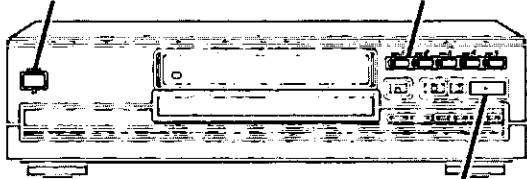

1.2

POWER

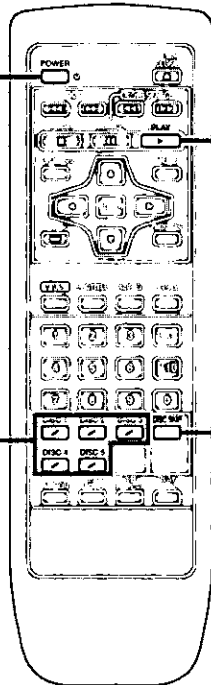

1.2

DISC 1-5

DISC SKIP

A Chapter preview function

DVD

This function plays the first few seconds of each chapter from the beginning of the title up to the point where operation was stopped. This makes it possible to review previous chapters.

1. Press [▶] while "▷" is flashing on the FL display. (The message illustrated is briefly displayed.)
2. Press [▶] again while the message is displayed on the screen.

Normal play will commence from the point where operation was stopped.

Note

- Canceling the RESUME function will also clear the chapter preview function.
- The chapter preview function may not work with some DVDs.

After operation

When the unit is not in use, remove the discs and press [POWER] to switch the unit to the standby mode.

The unit is automatically switched to the standby mode after approx. 30 minutes have elapsed in the stop mode.

(Auto power-off function)

Note

- The disc in the play position continues to rotate while the menu is displayed even after the unit has finished playing a particular item. Stop the unit when you finish viewing to preserve the unit's motor and your television screen.

B Skipping discs

Press [DISC SKIP] during play or in the stop mode.

The next disc indicator lights.

- Each time you press the button, the next tray is selected.

When you press [DISC SKIP]

During play

- The next tray is selected and play begins from the beginning of the disc. The unit skips empty trays.

In the stop mode

- The next tray is selected even if it is not loaded. (If the disc on the tray is an interactive DVD or a Video CD with playback control, play begins.)

For your reference

- You can also use [DISC 1-5] buttons to skip the discs. (Play begins automatically.)
- When you press [DISC SKIP] during play of disc 5, play of disc 1 will start.

A
1

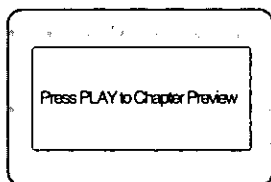

2



B

DISC SKIP



Example:

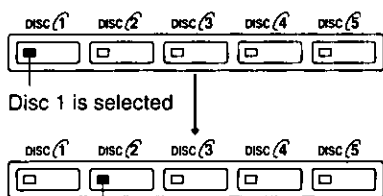

(Disc 1-5 buttons/indicators)

Other methods of play

Features on the next few pages are accessed primarily by using the remote control.

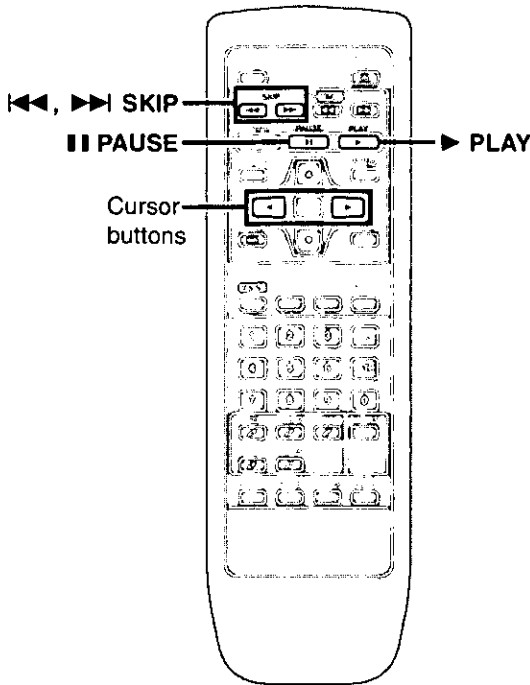

A Still picture (Pause)

Press [|| PAUSE] during play.

To return to normal play
Press [▶ PLAY].

B Skipping chapters or tracks

Press [◀◀, ▶▶ SKIP] during play or while paused.

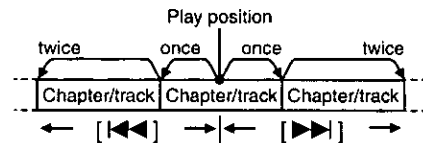

Note

- You can skip only within the disc currently in play.

For your reference

- When [◀◀, ▶▶ SKIP] is pressed during menu play of Video CDs with playback control, a menu screen may be recalled.

C Frame advance (Frame reverse)

DVD **VCD**

Press the cursor buttons [◀, ▶] while paused.

- The disc is advanced (reversed) by one frame each time the cursor buttons [◀, ▶] are pressed.
- When the cursor buttons [◀, ▶] are held, consecutive frame advance (reverse) is activated.

To return to normal play
Press [▶ PLAY].

Note

- For Video CDs, frame reverse is not an available function.

For your reference

- Pressing [|| PAUSE] also activates frame advance.
- Whether the pictures are advanced by a "Frame" or "Field" is automatic, but you can change the initial settings to choose how the picture is advanced (⇒ "1 Still Mode" in "9 Other Settings", page 31).

A

PAUSE



B

SKIP

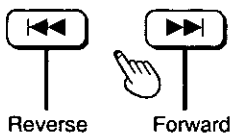

Reverse

Forward

C



Reverse
(DVD only)

Forward

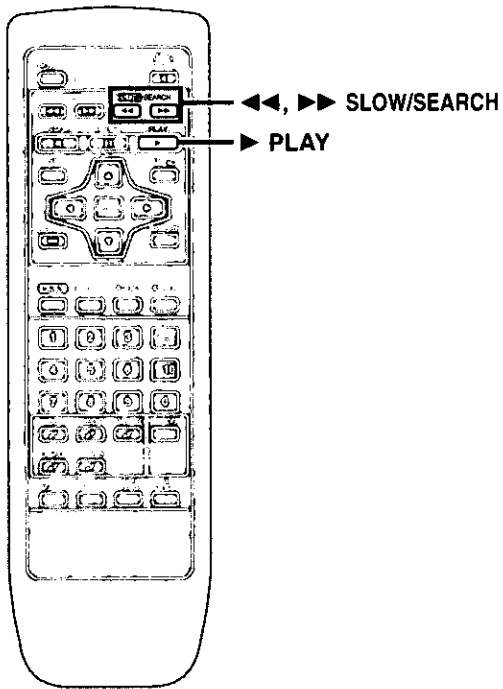

A Slow-motion play

DVD **VCD**

Press [**◀◀, ▶▶ SLOW/SEARCH**] while paused.

- Each press increases the speed of slow-motion.

- There are 5 speeds of slow-motion.

To return to normal play

Press [**▶ PLAY**].

Note

- For Video CDs, slow-motion play in reverse is not an available function.

For your reference

- When [**◀◀, ▶▶ SLOW/SEARCH**] is pressed during menu play of Video CDs with playback control, a menu screen may sometimes be recalled.

B Rapid advance (Rapid reverse)

Press [**◀◀, ▶▶ SLOW/SEARCH**] during play.

- Each press increases the speed of the search.

- There are 5 speeds of advance (reverse).

To return to normal play

Press [**▶ PLAY**].

Note

- You can search forward and backward only within the disc currently in play.

For your reference

- When [**◀◀, ▶▶ SLOW/SEARCH**] is pressed during menu play of Video CDs with playback control, a menu screen may sometimes be recalled.
- For DVDs and Video CDs, audio will be heard during searching (forward direction only) at the initial search speed (To turn audio off, → "2 Audio during Search" in "9 Other Settings", page 31).

A

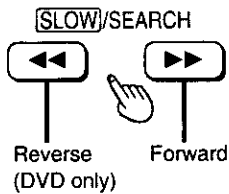

B

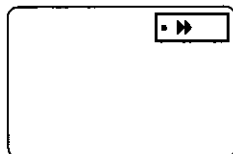
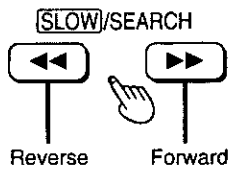

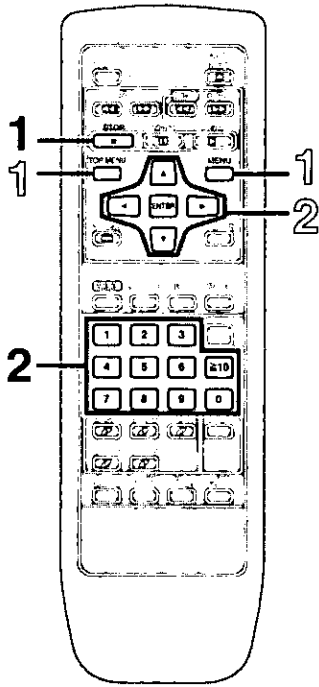

A

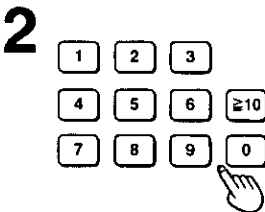

B

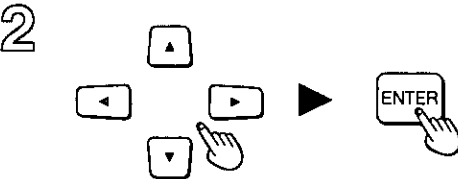

C

Example: If you press the buttons while you are playing title 2

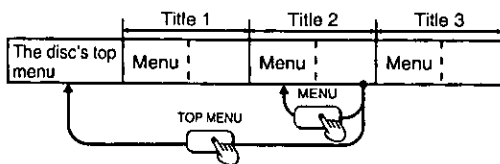

A Canceling playback control

VCD

- 1 Press [■ STOP].**
"PBC" will be cleared from the unit's FL display.
- 2 Press the numeric buttons to select a track.**
Play begins.
 - Refer to the jacket of the disc for the track numbers.
 - Press [1] to start play from the beginning of the disc.

To select a 2-digit number
Example: To select track 23
Press [≧10], then [2] and [3].

To return to menu play
Press [■ STOP] to stop play, press [MENU], and press the numeric buttons to select an item.
"PBC" lights on the unit's FL display.

B Using menus to play

DVD

By calling up menus during play, you can start play from a specific title or chapter, or change the soundtrack and subtitle languages.

- 1 Press [TOP MENU] or [MENU] during play to display the menu.**
• Press again to return to what you were watching.
- 2 Press the cursor buttons [▲, ▼, ◀, ▶] to select an item and press [ENTER].**
The selected item is confirmed.
• Repeat if other menus are shown.

DVDs can have several menus. The menu displayed when you press [TOP MENU] may be different from the menu displayed when you press [MENU]. **G**

For your reference

- Menu content depends on the disc. These operating instructions describe basic steps.
- Both buttons take you to the same menu if the disc has only one menu.

A Changing soundtrack language

DVD

Some DVDs have more than one soundtrack language recorded on them, and you can change soundtrack language during play.

Press [AUDIO] during play to display the current language number.

The number changes each time you press the button.

- You can also use the cursor buttons [▲, ▼] or the numeric buttons to change the language number.

To clear the display

Press [ENTER].

For your reference

- You can only select languages or sound formats if they have been recorded on the disc you are playing.
- If the RESUME function (⇒ page 12) is canceled or if you stop play of an interactive DVD, the soundtrack languages revert to the initial settings (⇒ page 28).
- Some discs allow changes to soundtrack languages only by using the disc's menus.

B Switching vocals ON or OFF for Karaoke discs

DVD VCD

1. Press [AUDIO] during play.

2. Press the cursor buttons [▲, ▼, ◀, ▶] or press [AUDIO] to change the setting.

DVD Karaoke [◀, ▶]

• Solo

---: Vocal OFF

ON: Vocal ON

• Duet

---: Vocal OFF

1+2: Vocal 1, 2 ON

V1: Vocal 1 only ON

V2: Vocal 2 only ON

• Choose "---" for Karaoke.

• Choose "V1" or "V2" to duet with the unit.

Video CD ([▲, ▼] or [AUDIO])

LR: Vocals (Vocals seem to come from the right)

L: No Vocals

R: Vocals (Vocals seem to come from both left and right)

• Choose "L" for Karaoke.

To clear the display

Press [ENTER].

For your reference

• Karaoke discs may show a menu after each track. Some will have a menu that allows you to play all the tracks.

• Some discs require different operations from those described. Read the disc's instructions for details.

A

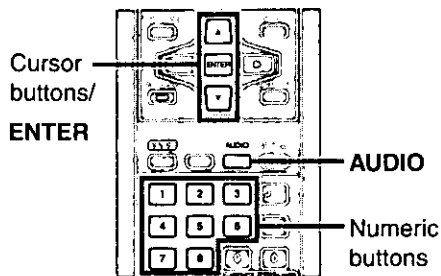

AUDIO



Soundtrack language number being played ("—" indicates a sound track is not recorded.)

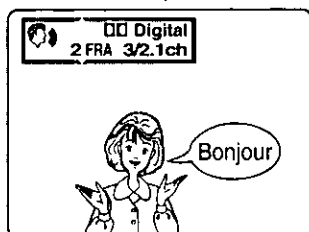
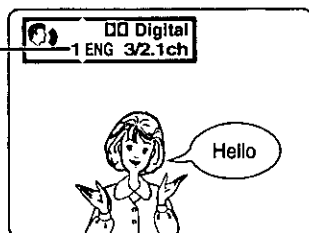

B

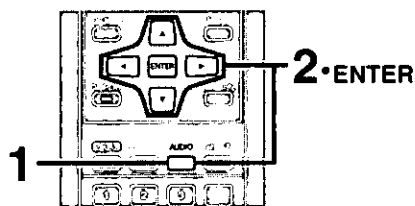

1

AUDIO



2

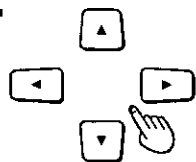

AUDIO



DVD

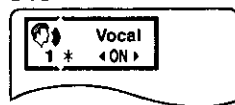

Video CD



A

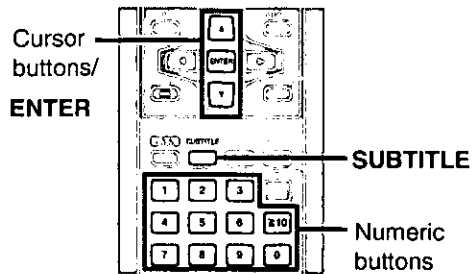

SUBTITLE



Subtitle language number being played

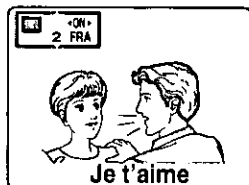
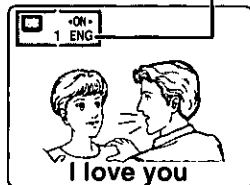

B

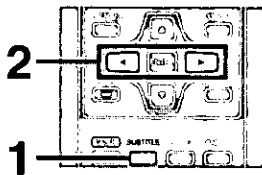

1 SUBTITLE



2



C

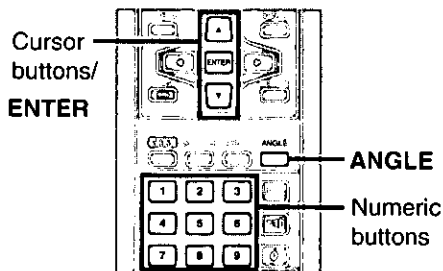

ANGLE



Angle number being played

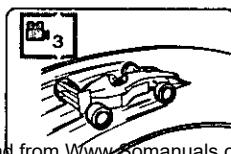
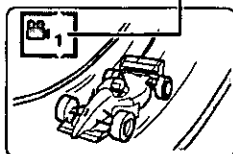

Advanced operations

A Changing subtitle language

DVD

Some DVDs have more than one subtitle language recorded on them, and you can change subtitle language during play.

Press [SUBTITLE] during play to display the current language number.

The number changes each time you press the button.

- You can also use the cursor buttons [▲, ▼] or the numeric buttons to change the language number.
- "—" is displayed in circumstances such as when subtitles are not recorded on the disc.

To clear the display

Press [ENTER].

B To clear/display the subtitles

1. Press [SUBTITLE].
2. Press the cursor buttons [◀, ▶] to select "ON" or "OFF".

Note

- In some cases, the subtitle language is not changed to the selected one immediately.
- When a disc supporting closed captions is played, the subtitles and closed captions may overlap each other on the TV monitor. In this case, turn the subtitles off.

For your reference

- You can only select languages if they have been recorded on the disc you are playing.
- If the RESUME function (⇒ page 12) is canceled or if you stop play of an interactive DVD, the subtitle languages revert to the initial settings (⇒ page 28).
- Some discs allow changes to subtitle languages only by using the disc's menus.

C Viewing from another angle

DVD

Some DVDs allow you to view the same scene from different angles. "FL" lights on the FL display to indicate that the feature is available.

Press [ANGLE] during play to display the current angle number.

The number changes each time you press the button.

- You can also use the cursor buttons [▲, ▼] or the numeric buttons to change the angle.

To clear the display

Press [ENTER].

For your reference

- You can only select angles if they have been recorded on the disc you are playing.
- Some discs allow you to set angles before multi-angle scenes are played.
- Some discs allow changes to angles only by using the disc's menus.

A Repeat play

Press [REPEAT MODE] during play.

Each time you press the button, the TV monitor changes as illustrated.

•During play of a DVD

- (a) Normal play
- (b) Repeat of chapter being played
- (c) Repeat of title being played
- (d) Repeat of all discs (DVDs/Video CDs/CDs)*
- (e) Cancel repeat mode (Normal play)

•During play of a Video CD/CD

- (f) Normal play
- (g) Repeat of track being played
- (h) Repeat of all the tracks on the disc being played
- (i) Repeat of all discs (DVDs/Video CDs/CDs)*
- (j) Cancel repeat mode (Normal play)

Repeat play starts when the display changes.

※A menu screen appears when playing interactive DVDs or Video CDs with playback control. To play these discs, see "When a menu screen appears on the TV monitor" (⇒ page 12). After play, press [DISC SKIP] to proceed to the next disc.

To return to normal play

Press [REPEAT MODE] until "OFF" is displayed.

Note

- Repeat play may not work as desired with some DVDs.
- Repeat play does not work with interactive DVDs or during menu play of a Video CD with playback control.

B To enjoy program repeat play

VCD CD

If you press [REPEAT MODE] during program play (⇒ page 22), the display changes as illustrated.

- (k) Program play
- (l) Repeat of the current programmed item
- (m) Repeat of all programmed items
- (n) Cancel repeat mode (Program play)

To return to program play

Press [REPEAT MODE] until "OFF" is displayed.

C Repeating sections between two specific points (A-B repeat)

1 Press [A-B REPEAT] during play at the point where repeat play is to start (A).

2 Press [A-B REPEAT] at the point where repeat play is to be concluded (B).

Repeat play of the section between points A and B starts.

To return to normal play

Press [A-B REPEAT] until "••" is displayed.

Note

- A-B repeat play does not work with interactive DVDs.
- Some subtitles recorded around point A or B may fail to appear (DVD).
- A-B repeat play works only within a title (DVD) or a track (Video CD/CD).

For your reference

- The unit automatically determines the end of a title/track as point B when the end of the title/track is reached.

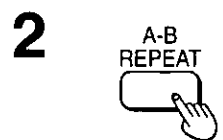
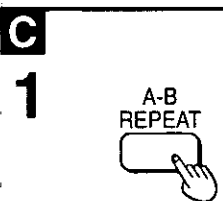
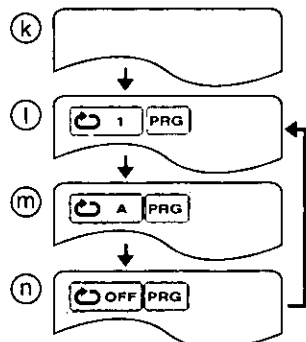
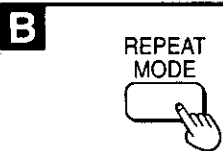
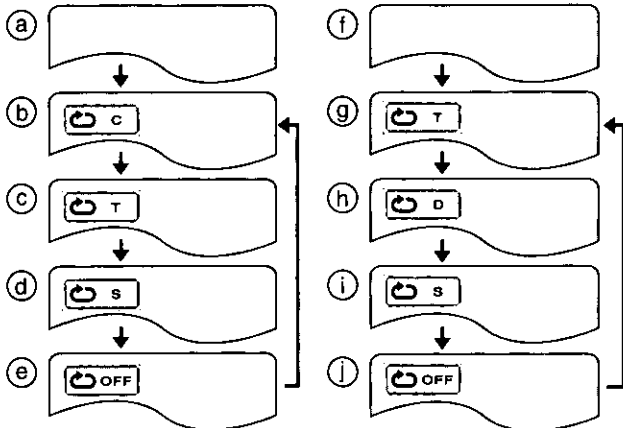
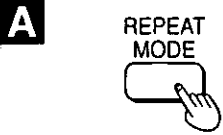
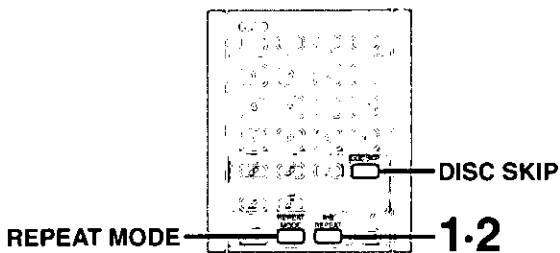

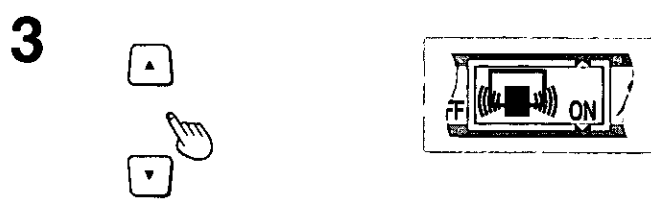
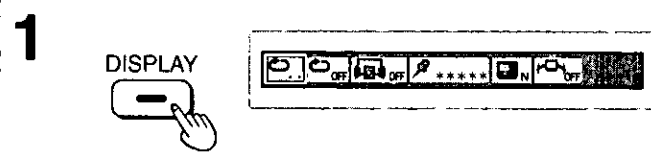
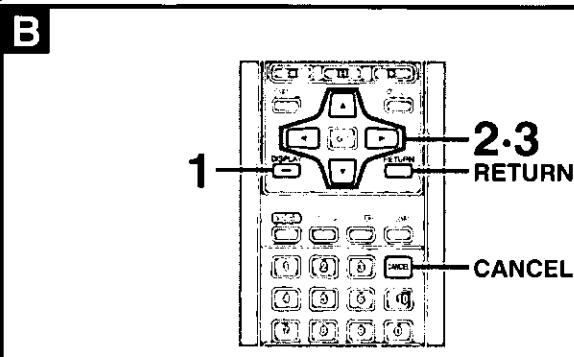
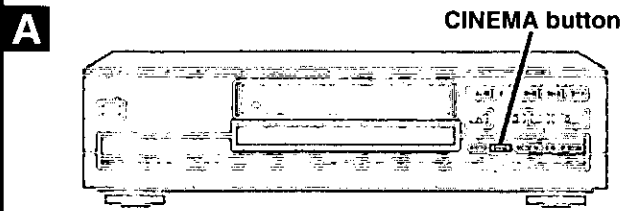

Advanced operations

A Changing picture quality for movie viewing

DVD **VCD**
Press [CINEMA] on the unit during play.
 Cinema screen is displayed.

Each time you press the button:
N: Normal mode

↓
C: Cinema mode (Cinema position)

Mellows movies and enhances detail in dark scenes.

To restore the standard picture mode
 Press [CINEMA].

For your reference
 • You can also use the On-Screen Menu Icons (⇒ "Ⓢ Cinema mode", page 26).

B Raising dialogue volume

DVD
 This mode makes the dialogue in movies easier to hear (⇒ "Ⓢ Dialogue Enhancer", page 26).
 This function is effective with Dolby Digital, 3 channels or over, where the dialogue is recorded in the center channel.

1 Press [DISPLAY] during play until the illustrated screen appears.
 The On-Screen Menu Icons for unit information (⇒ page 26) are displayed.

2 Press the cursor buttons [◀, ▶] to select the icon.

3 Press the cursor buttons [▲, ▼] to select the mode.

OFF: Normal volume
ON: Louder volume for dialogue

To clear the On-Screen Menu Icons
 Press [RETURN] or [CANCEL].

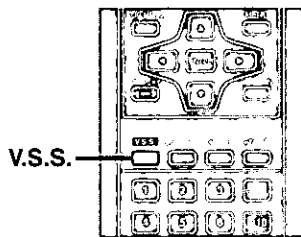
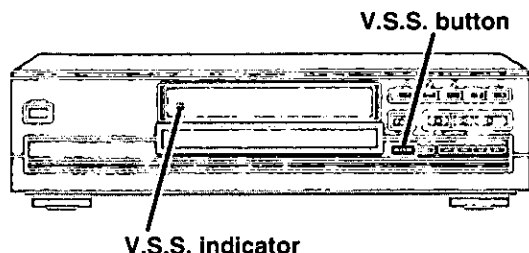

A

V.S.S.

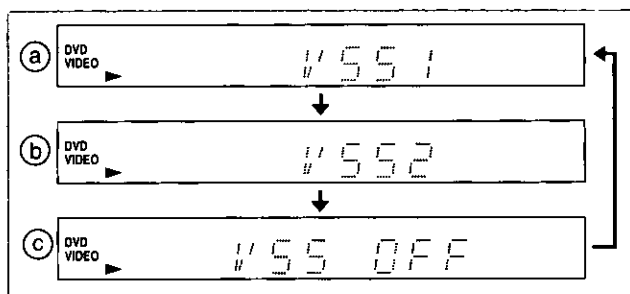

B

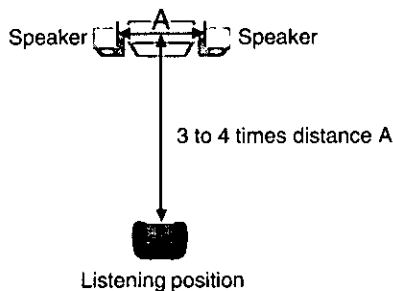

A Reproducing an advanced Virtual Surround Sound (V.S.S.) effect

DVD (Dolby Digital, 2-channel or over only)

Use this feature to enjoy a surround-like effect if you are using 2 front speakers.

Press [V.S.S.] during play.

Each time you press the button, the unit's FL display changes:

- Ⓐ V.S.S. 1 (Natural effect)
- Ⓑ V.S.S. 2 (Emphasized effect)
- Ⓒ V.S.S. is canceled

• The V.S.S. indicator lights up when V.S.S. is on.

Note

- V.S.S. does not work with Karaoke DVDs.
- V.S.S. will not work or will have less effect with some discs.
- Turn off the TV surround sound and other surround sound effects when using this effect.

For your reference

- For optimum effect, it is recommended that the distance between the television and the listening position be about 3 to 4 times the distance between the right and left front speakers. **B**
- You can also change the V.S.S. level with the On-Screen Menu Icons [⏏] "Ⓜ Virtual Surround Sound (V.S.S.)", page 26].

• V.S.S. effects

	V.S.S. 1	V.S.S. 2
Stereo discs	The front speakers sound farther apart.	The surround-like effect in V.S.S. 1 is enhanced.
Surround signal recorded discs	Surround sound seems to come from the side.	

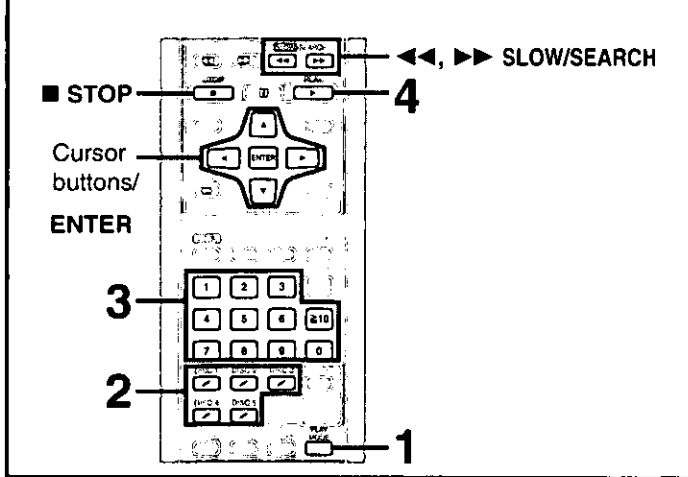

Advanced operations

Program play

VCD CD
 You can program up to 32 items (discs or tracks) to play in the order you choose.

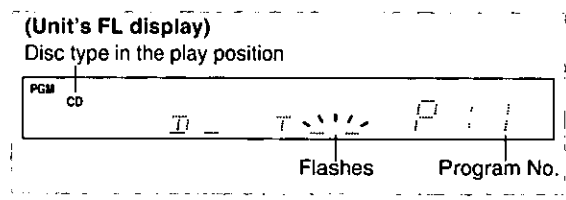
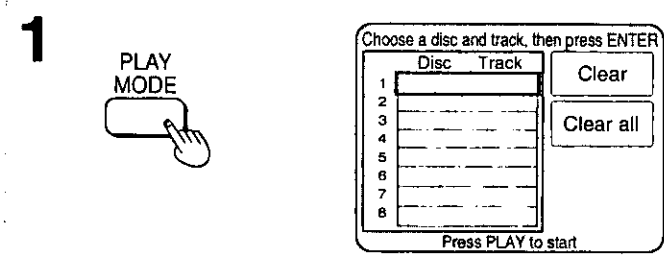

- 1 Press [PLAY MODE] while stopped.**
The illustrated screen appears.
- 2 Press [DISC 1-5] to select the disc.**
 - Track 1 on the disc is automatically selected.
 - To enter the disc as one item, press the cursor buttons [▲, ▼] to select "All" and press [ENTER].
- 3 Press the numeric buttons to select the track** (→ item ② on page 7 for number entry).
 - Repeat steps 2 and 3 to enter other discs and tracks.
 - To select tracks on the same disc, simply press the numeric buttons to select the next track.
- 4 Press [▶ PLAY].**
The items are played in the programmed sequence.

Note

- You can enter tracks and discs the unit cannot find, or DVDs, if the unit has not read the disc, but these are cleared during play.
- If you enter a 33rd item, it replaces item 32.
- Empty trays can be entered in the program but are cleared during play.
- You cannot start play by pressing [DISC 1-5] while in the program mode.

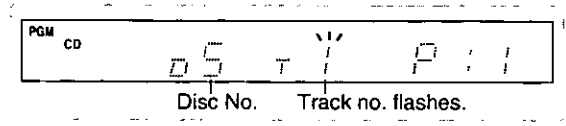
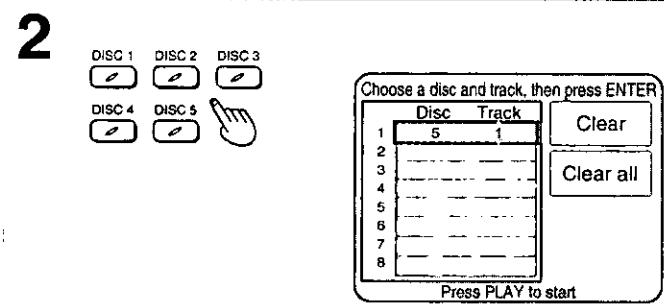

To exit the screen
 Press [PLAY MODE] twice.

For your reference
 You can also program items with the cursor buttons.

1. Press [PLAY MODE] while stopped.
2. Press [ENTER].
3. Press the cursor buttons [▲, ▼] to select the disc and press [ENTER].
4. Press the cursor buttons [▲, ▼] to select the track and press [ENTER].

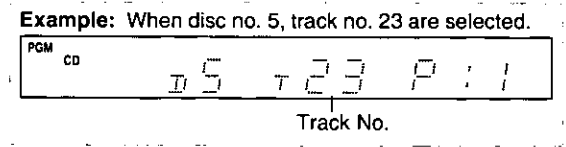
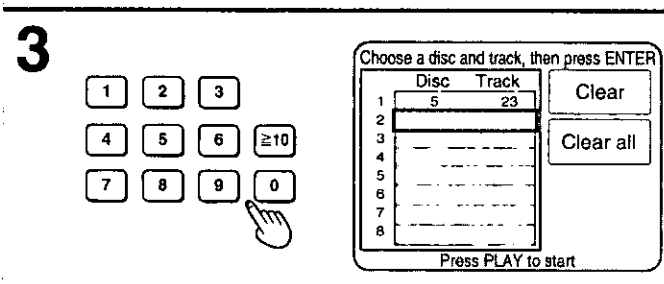

Repeat steps 2 to 4 to program other items.

5. Press [▶ PLAY].

To add or change items

1. Press [■ STOP] twice during play to show the program play screen.
2. Press the cursor buttons [▲, ▼] to select an available item, then repeat program play steps 2 and 3 above.

Press [◀, ▶ SLOW/SEARCH] to turn the program list pages to make the selection faster.



To return to normal play

1. Press [■ STOP] twice during program play.
(Program play is suspended.)
2. Press [PLAY MODE] twice.
3. Press [▶ PLAY].

- The program is retained in memory.

Operation by observing the unit's FL display

- Use [DISC 1-5] and the numeric buttons to enter items.
- To check the program, press the cursor buttons [▲, ▼] while stopped. Each time you press the cursor buttons [▲, ▼], the program contents (disc/track/program number) will be displayed.

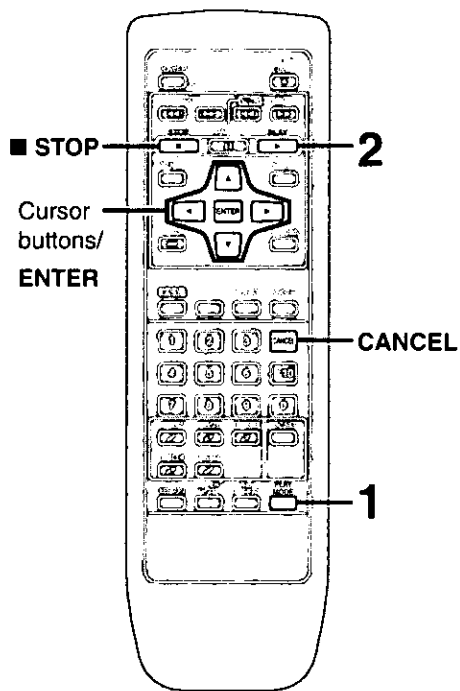

Clearing the program

When the program play screen is displayed

- **To clear the programmed items one by one**
Select the item, move to "Clear" with the cursor buttons [▲, ▼, ◀, ▶] and press [ENTER]. (Selecting the item, then pressing [CANCEL] also clears the programmed item.)
- **To clear the whole program**
Move to "Clear all" with the cursor buttons [▲, ▼, ◀, ▶] and press [ENTER]. (The program is also cleared when the unit is switched to the standby mode or turned off.)

Random play

VCD CD

The unit plays the tracks on all the Video CDs and CDs in random order.

- 1 Press [PLAY MODE] while stopped until the illustrated screen appears.**
- 2 Press [▶ PLAY].**
Play now begins in random order.

Note

- This function skips empty disc trays.
- If the disc is a Video CD with playback control, menu play is automatically canceled during random play.
- You cannot start play by pressing [DISC 1-5] while in the random mode.

To exit the screen

Press [PLAY MODE] once.

To return to normal play

1. Press [■ STOP] twice during random play. (Random play is suspended.)
2. Press [PLAY MODE] once.
3. Press [▶ PLAY].

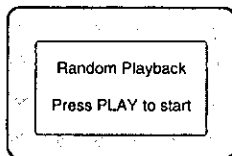
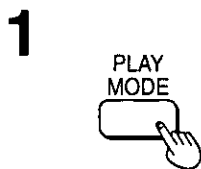

Using On-Screen Menu Icons

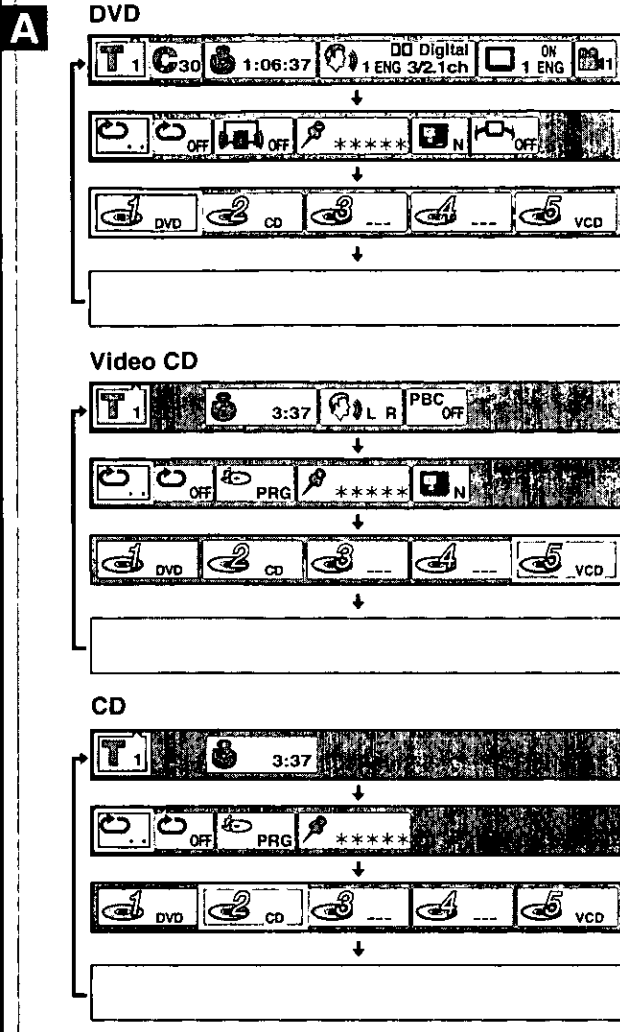

On-Screen Menu Icons

On-Screen Menu Icons are long thin menus that contain information about the disc or unit. These menus allow you to perform operations by changing this information.

Examples of On-Screen Menu Icons **A**

The screens depend on the disc contents.

B Common procedures

1 Press [DISPLAY] during play or in the stop mode.

Each time you press the button, the TV monitor changes as follows:

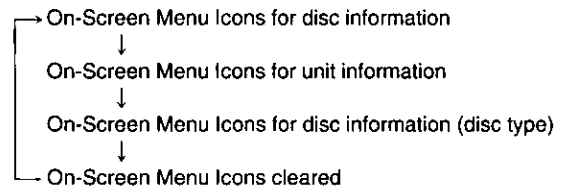

•Some functions cannot be accessed from the stop mode.

2 Press the cursor buttons [◀, ▶] to select the item.

The item is highlighted in yellow.

3 Press the cursor buttons [▲, ▼] to select the setting.

•For some functions, the setting will be registered immediately; for others, [ENTER] or [▶ PLAY] must be pressed.

•When numbers are displayed (e.g. title No.), both the numeric buttons and the cursor buttons [▲, ▼] are also effective for setting. When numbers are entered with numeric buttons, press [ENTER] to register the setting.

To clear the On-Screen Menu Icons

Press [RETURN] or [CANCEL].

For your reference

•The On-Screen Menu Icons may not be displayed when playing some kinds of DVD software, or if the television's automatic picture zoom function is on. Change the position of the On-Screen Menu Icons in "4 On-Screen Messages" if this occurs (⇒ page 30).

•The color (blue, violet or green) of the On-Screen Menu Icons can be changed (⇒ page 30).

•"▲, ▼" around the icon means that the item can be changed using the cursor buttons [▲, ▼].

Advanced Operations

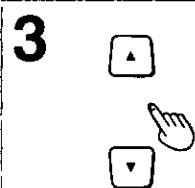
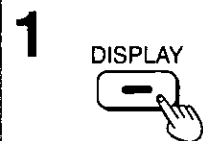
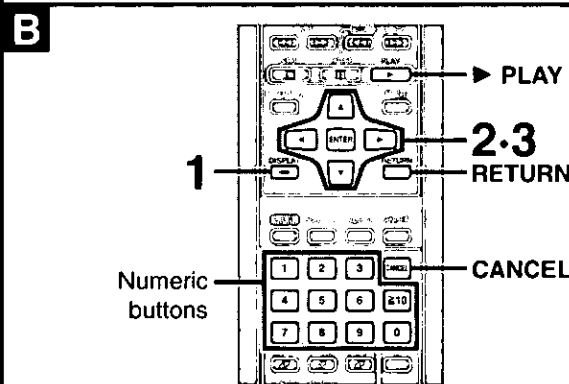

Detailed descriptions of each icon

Screen for disc information

■ DVD

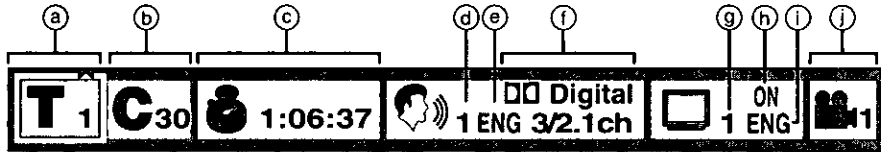

Ⓐ Title No.

Change the No. with the cursor buttons [▲, ▼] or the numeric buttons and press [ENTER].

Ⓑ Chapter No.

Change the No. with the cursor buttons [▲, ▼] or the numeric buttons and press [ENTER].

Ⓒ Time

(hour:minute:second)

Enter the time from which you want to start play and press [ENTER].

Example: To specify "1 hour 6 min. 37 sec.", enter "10637".

Ⓓ Soundtrack language No.

Change the No. with the cursor buttons [▲, ▼] or the numeric buttons.

Ⓔ Soundtrack language

ENG: English	SVE: Swedish	CHI: Chinese
FRA: French	NOR: Norwegian	KOR: Korean
DEU: German	DAN: Danish	MAL: Malay
ITA: Italian	POR: Portuguese	VIE: Vietnamese
ESP: Spanish	RUS: Russian	THA: Thai
NLD: Dutch	JPN: Japanese	*: Others

Ⓕ Audio attribute

Shows the audio attributes of the selected soundtrack (cannot be changed).

LPCM/□□ Digital/DTS: Signal type

k: Sampling frequency (kHz)

b: Number of bits (bit)

ch: Number of channels*

Vocal: Vocals indication

• You can switch vocals ON or OFF with the cursor buttons [▲, ▼].

[DVD Karaoke (Solo)]: --- (OFF) or ON

[DVD Karaoke (Duet)]: --- (OFF), V1+V2, V1 or V2

Ⓖ Subtitle language No.

Change the No. with the cursor buttons [▲, ▼] or the numeric buttons.

Ⓗ Subtitle on/off

Select "ON" or "OFF" with the cursor buttons [▲, ▼].

OFF: Subtitle is cleared.

ON: Subtitle is displayed.

Ⓖ Subtitle language

See the table under the item Ⓓ.

Ⓖ Angle No.

Change the No. with the cursor buttons [▲, ▼] or the numeric buttons.

■ Video CD/CD

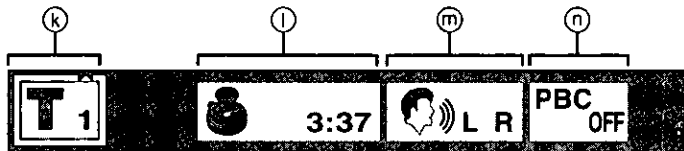

Ⓕ Track No.

Change the No. with the cursor buttons [▲, ▼] or the numeric buttons and press [ENTER].

Ⓖ Time

(minute:second)

Display is changed each time the cursor buttons [▲, ▼] are pressed. (The times cannot be changed)

Elapsed playing time ← → Remaining time of the track

↑ → Remaining time of the disc ← →

Ⓖ Audio mode **VCD**

Change the mode with the cursor buttons [▲, ▼].

LR: Left channel sound is output from the left speaker (L), and right channel sound is output from the right speaker (R).

L: Left channel sound only is output from the speakers (L/R).

R: Right channel sound only is output from the speakers (L/R).

Ⓖ Playback control **VCD**

Shows whether menu play is on or off (cannot be changed here).

OFF: Menu play is OFF.

ON: Menu play is ON.

Note

- Actual information displayed depends on the disc.
- During program and random play of Video CDs and CDs, the remaining time of the disc is not displayed.

※ Example:

3/2 .1ch

.1: Subwoofer signal
(not displayed if there is no subwoofer signal)

0: No surround
1: Mono surround
2: Stereo surround (left/right)

1: Center
2: Front left+ Front right
3: Front left+ Front right+ Center

Detailed descriptions of each icon

Screen for unit information

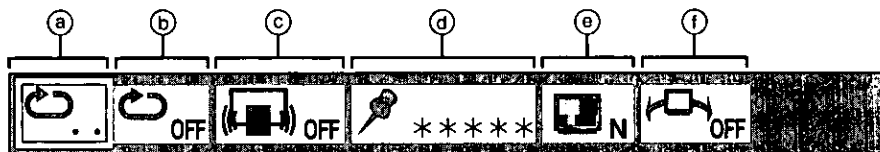
**a A-B repeat play**

Press [ENTER] during play to store location A and press [ENTER] again to store location B. Repeat play between the two locations starts. Press [ENTER] again to return to normal play.

b Repeat play

Select the mode during play with the cursor buttons [▲, ▼].

[DVD]

OFF: Normal play

C: Chapter repeat play

T: Title repeat play

S: Sequential repeat play

[VCD] [CD]

OFF: Normal play

T: Track repeat play

D: Disc repeat play

S: Sequential repeat play

c Dialogue Enhancer

[DVD] (⇒ page 20)

Select the mode during play with the cursor buttons [▲, ▼].

OFF: Normal volume

ON: Louder volume for dialogue

Play mode

[VCD] [CD] (⇒ pages 22 and 23)

The current play mode is shown (cannot be changed here).

PRG: Program play

RND: Random play

----: Normal play

d Marker (Marking parts you want to watch or listen to again)

Press [ENTER] during play and press [ENTER] again at the preferred point to store a marker. (Marker no. replaces "*".) Up to 5 markers can be stored in memory.

To store the next marker, press the cursor button [▶].

•To recall a marker

Select the marker No. with the cursor buttons [◀, ▶] and press [ENTER].

•To clear a marker

Select the marker No. with the cursor buttons [◀, ▶] and press [CANCEL].

•Some subtitles recorded around the marker may fail to appear.

•All the markers are cleared when the other disc is selected, the unit is switched to the standby mode or turned off.

e Cinema mode [DVD] [VCD]

Select the mode during play with the cursor buttons [▲, ▼].

N: Normal mode

C: Cinema mode (Cinema position): Picture for viewing movies

f Virtual Surround Sound (V.S.S.)

[DVD] (Dolby Digital, 2-channel or over only) (⇒ page 21)

Select the level during play with the cursor buttons [▲, ▼].

OFF: V.S.S. off

1: V.S.S. natural effect

2: V.S.S. emphasized effect

Note

- A-B repeat play does not work with an interactive DVD.
- Repeat play and marker functions do not work with an interactive DVD or during menu play of a Video CD with playback control.
- Dialogue Enhancer is effective with Dolby Digital, 3 channels or over, where the dialogue is recorded in the center channel.

Screen for disc information (disc type)

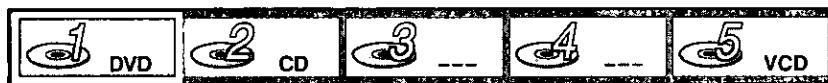
**Disc information**

This screen shows the kinds of discs loaded on the trays.

----: The unit has not determined the kind of disc, or there is no disc on the tray.

•Playing discs using the disc information screen

Press the cursor buttons [◀, ▶] to select the disc you want to play and press [ENTER].

Changing initial settings

Change the initial settings to suit your preference and to suit the unit to the environment in which it is being used.

Common procedures

- 1 Press [ACTION] in the stop mode.**
The initial settings screen is displayed.
- 2 Press the cursor buttons [▲, ▼] to select the item and press [ENTER].**
Each item that can be modified is displayed.

- 1 Disc Languages (⇒ page 28)**
Change the soundtrack language, subtitle language and the language used in the disc's menu to be used for every disc played.
- 2 Ratings (⇒ page 29)**
Change the ratings level to prevent play of discs, skip violent scenes, or replace scenes with others by entering a password. This is also called a parental lock.
- 3 Menu Language (⇒ page 30)**
Change the language used for the on-screen displays and initial settings menus.
- 4 On-Screen Messages (⇒ page 30)**
Choose whether "Play", "Still" and other displays will be displayed or not, and the color and position of these displays as well as On-Screen Menu Icons.
- 5 FL Display (⇒ page 30)**
Change the brightness for the FL display.
- 6 TV Aspect (⇒ page 10)**
Change the settings to suit the type of television you have connected.
- 7 Digital Audio Output (⇒ page 36)**
Change the settings to suit the type of digital equipment you have connected.
- 9 Other Settings (⇒ page 31)**
Choose the kind of picture shown when play is paused, and adjust various other settings to enhance your viewing experience.

- 3 Press the cursor buttons [▲, ▼] to select the setting and press [ENTER].**
•Some items require additional steps.
(See the respective pages.)
Setting is finished and the initial settings screen is displayed.

To cancel during setup operation

Press [RETURN]. (The previous screen is displayed.)

To exit the initial settings screen

Press [ACTION] or [RETURN].

Note

- There is no No.8 in the initial settings menu of this unit.

For your reference

- The numeric buttons can also be used instead of the cursor buttons [▲, ▼] for selecting items or settings. Pressing [ENTER] is not necessary.

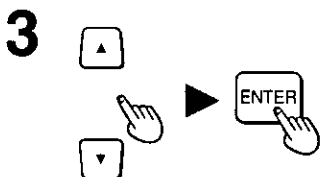
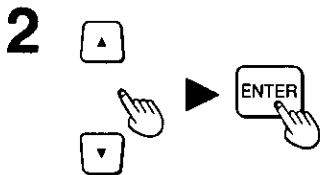
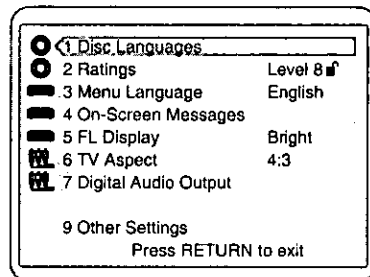
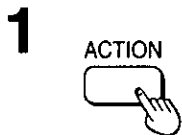
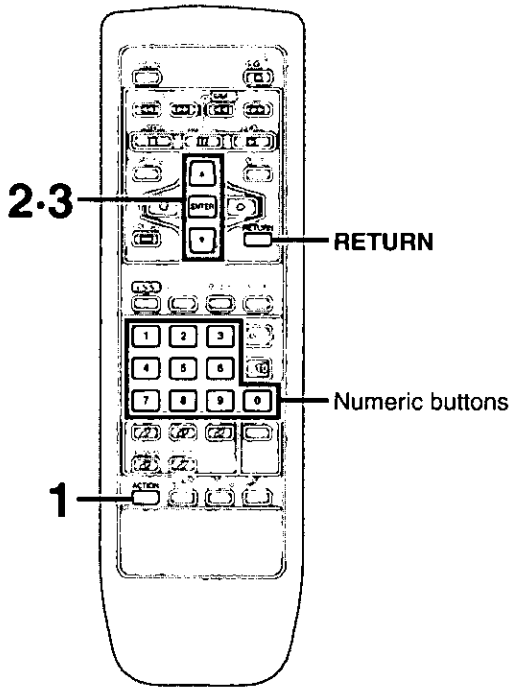

1 Disc Languages

DVD

See page 27 for operation.

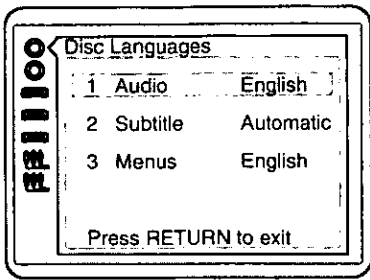

1 Audio	<p>1 English (Factory preset) 2 French 3 Spanish 4 Original The original language of each disc will be selected. 5 Other **** Another language can be selected.*</p>
2 Subtitle	<p>1 Automatic (Factory preset) Subtitle language will automatically be selected in accordance with the soundtrack language. • If the language selected in "1 Audio" is actually used during play, the subtitles will not appear. • If another language is used during play, the subtitles will appear in the language selected in "1 Audio". 2 English 3 French 4 Spanish 5 Other **** Another language can be selected.*</p>
3 Menus	<p>1 English (Factory preset) 2 French 3 Spanish 4 Other **** Another language can be selected.*</p>

*Enter the language code if you select "Other". (See the language code list below.) Press [CANCEL] if you enter the wrong number.

Note

- If the language selected is not available on the disc, the language designated by each disc will be selected.
- There are cases where the selected language is recorded but the disc designates another language.

Language code list

6565: Afar	6890: Bhutani	7285: Hungarian	7679: Laotian	8084: Portuguese	8471: Tajik
6566: Abkhazian	6976: Greek	7289: Armenian	7684: Lithuanian	8185: Quechua	8472: Thai
6570: Afrikaans	6978: English	7365: Interlingua	7686: Latvian, Lattish	8277: Rhaeto-Romance	8473: Tigrinya
6577: Ameharic	6979: Esperanto	7378: Indonesian	7771: Malagasy	8279: Romanian	8475: Turkmen
6582: Arabic	6983: Spanish	7383: Icelandic	7773: Maori	8285: Russian	8476: Tagalog
6583: Assamese	6984: Estonian	7384: Italian	7775: Macedonian	8365: Sanskrit	8479: Tonga
6588: Aymara	6985: Basque	7387: Hebrew	7776: Malayalam	8368: Sindhi	8482: Turkish
6590: Azerbaijani	7065: Persian	7465: Japanese	7778: Mongolian	8372: Serbo-Croatian	8484: Tatar
6665: Bashkir	7073: Finnish	7473: Yiddish	7779: Moldavian	8373: Singhalese	8487: Twi
6669: Byelorussian	7074: Fiji	7487: Javanese	7782: Marathi	8375: Slovak	8575: Ukrainian
6671: Bulgarian	7079: Faroese	7565: Georgian	7783: Malay	8376: Slovenian	8582: Urdu
6672: Bihari	7082: French	7575: Kazakh	7784: Maltese	8377: Samoan	8590: Uzbek
6678: Bengali; Bangla	7089: Frisian	7576: Greenlandic	7789: Burmese	8378: Shona	8673: Vietnamese
6679: Tibetan	7165: Irish	7577: Cambodian	7865: Nauru	8379: Somali	8679: Volapük
6682: Breton	7168: Scots Gaelic	7578: Kannada	7869: Nepali	8381: Albanian	8779: Wolof
6765: Catalan	7176: Galician	7579: Korean	7876: Dutch	8382: Serbian	8872: Xhosa
6779: Corsican	7178: Guarani	7583: Kashmiri	7879: Norwegian	8385: Sundanese	8979: Yoruba
6783: Czech	7185: Gujarati	7585: Kurdish	7982: Oriya	8386: Swedish	9072: Chinese
6789: Welsh	7265: Hausa	7589: Kirghiz	8065: Punjabi	8387: Swahili	9085: Zulu
6865: Danish	7273: Hindi	7665: Latin	8076: Polish	8465: Tamil	
6869: German	7282: Croatian	7678: Lingala	8083: Pashto, Pushto	8469: Telugu	

Advanced Operations

2 Ratings

DVD

See page 27 for operation.

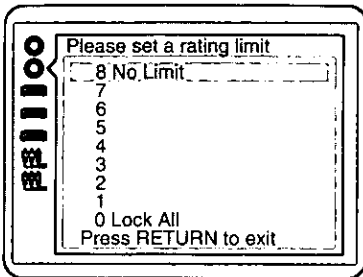

Level 8 (Factory preset)
All DVDs can be played.

Level 7 to 1

Prevents play of DVDs with ratings recorded on them (those that contain adult or violent scenes).

Level 0

Play of all DVDs is prohibited (e.g. to prohibit play of adult DVDs which are not encoded with rating information).

Note

- The rating method differs from disc to disc. There are discs designed for adults that do not have these ratings recorded on them. These discs can be played as normal. To prevent play of these discs, set the rating limit to "0 Lock All".

Setting ratings (When the level is "8")

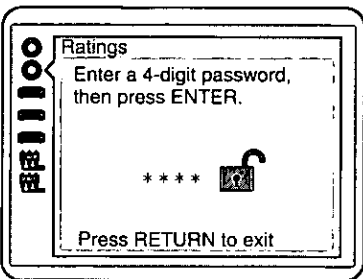

1 Select the level with the cursor buttons [▲, ▼] and press [ENTER].

2 Enter the 4-digit password with the numeric buttons and press [ENTER].

- Press [CANCEL] if you enter the number incorrectly.

The lock symbol appears closed to show the rating is locked.

Do not forget your password.

3 Press [ENTER].

Setting is finished and the initial settings screen is displayed.

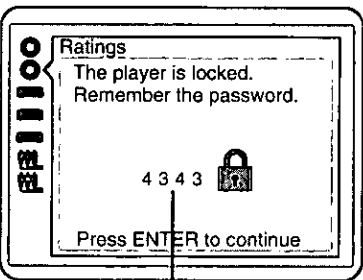

Example: "4343"

Now, when you play a DVD that exceeds the ratings limit you set, a message appears on the television. If you want to play the disc, select "Yes" and enter your password. The unit will unlock temporarily, locking again when:

- the unit is turned off, or
- the unit is switched to standby, or
- the disc in the play position is exchanged for another disc that exceeds the ratings limit you set.

Your selection exceeds the player's rating limit. Do you want to change the limit?

Yes
No

Changing ratings (When the level is "0" to "7")

Changes to the settings also requires a password.

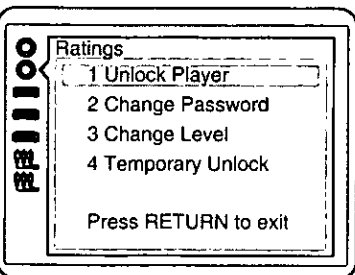

1 Press the cursor buttons [▲, ▼] to select "2 Ratings" in the initial settings screen and press [ENTER].

2 Enter your 4-digit password with the numeric buttons and press [ENTER].

3 Press the cursor buttons [▲, ▼] to select the item.

To unlock the unit (the rating level returns to 8)

Select "1" and then press [ENTER].

To change the password

Select "2" and press [ENTER]. Enter a new 4-digit password and press [ENTER], then press [ENTER] again.

To change the rating level

Select "3" and press [ENTER]. Select a new level with the cursor buttons [▲, ▼], then press [ENTER].

To unlock the unit temporarily

Select "4" and then press [ENTER].

- The unit unlocks for the DVD in the play position. It locks again when you select another tray,

3 Menu Language

See page 27 for operation.

Example: If you selected "2 Français"

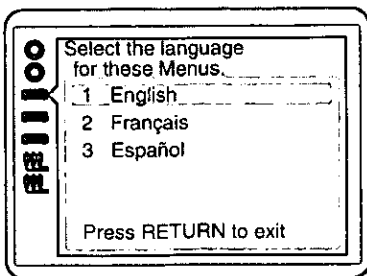

- 1 English (Factory preset)
- 2 Français
- 3 Español

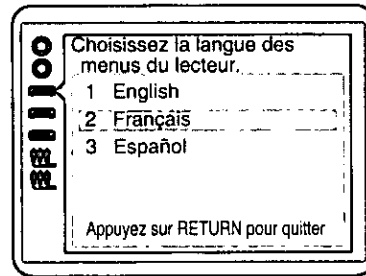

4 On-Screen Messages

See page 27 for operation.

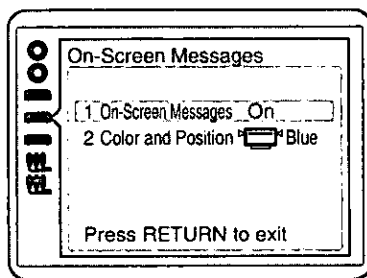

1 On-Screen Messages	1 On (Factory preset) 2 Off
2 Color and Position	<ul style="list-style-type: none"> 1 Blue (Factory preset) 2 Violet 3 Green 4 Blue 5 Violet 6 Green <div style="margin-left: 150px;"> <p>— Shown slightly lower. Select if the top of the screen is cut off.</p> </div>

5 FL Display

See page 27 for operation.

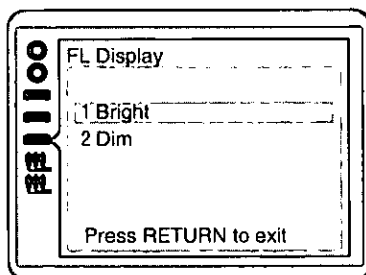

- 1 Bright (Factory preset)
- 2 Dim

Advanced Operations

9 Other Settings

See page 27 for operation.

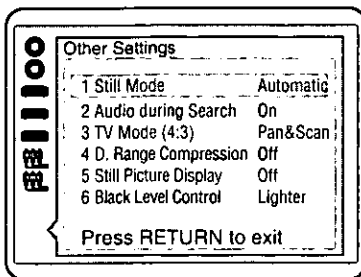

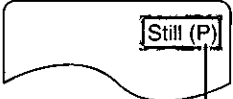
<p>1 Still Mode Select either "Field still" or "Frame still" in the still picture mode.</p>	<p>1 Automatic (Factory preset) 2 Field Select this setting when jittering occurs in the still picture mode when "1 Automatic" is selected. 3 Frame Select if small text or fine patterns cannot be seen clearly in the still picture mode when "1 Automatic" is selected.</p>
<p>2 Audio during Search To select whether audio is heard or not during search (forward direction) at the initial search speed.</p>	<p>1 On (Factory preset) 2 Off</p>
<p>3 TV Mode (4:3) To select whether widescreen material is played in the pan and scan style or in the letterbox style on a conventional TV (4:3).</p>	<p>1 Pan & Scan (Factory preset) Widescreen video material will be played in the pan and scan style (the picture is shown with either one or both sides cut off) on a conventional television (4:3). ●Video material not formatted in the pan and scan style will be played in the letterbox style. 2 Letterbox Widescreen video material will be played in the letterbox style (black bands appear at the top and bottom of the screen) on a conventional television (4:3).</p>
<p>4 D.(Dynamic) Range Compression To compress the dynamic range (the difference between the loudest sound and the softest sound), making it easier to hear dialogue even at low volume. This function only works with Dolby Digital DVD.</p>	<p>1 Off (Factory preset) The dynamic range remains as it was recorded on the disc. 2 On Dynamic range is compressed by augmenting soft sounds and reducing loud sounds. Select when playing discs at low volume, such as late at night.</p>
<p>5 Still Picture Display To display the picture type (DVD), I, P or B in the still picture mode.</p>	<p>1 Off (Factory preset) 2 On</p>  <p>Example: P-picture</p>
<p>6 Black Level Control To select the black level of the picture, "Lighter" or "Darker".</p>	<p>1 Lighter (Factory preset) Usually, select this setting. 2 Darker Select when the darker black level is desired.</p>

Note

- Audio is heard at any speed when playing CDs, regardless of any settings at "2 Audio during Search".
- Audio is not heard at any speed when playing CDs encoded with DTS, regardless of any settings at "2 Audio during Search".

(Continued on next page)

For your reference

● I/P/B

To efficiently store video on DVD, common elements among frames are used in common, and different elements are recorded with each individual frame. The frame that contains the common elements is called an I-picture, a complete frame in itself. A P-picture is calculated from past I or P-pictures. The frame that fills in the spaces between the I-and P-pictures is called the B-picture.

I-pictures have the best picture quality, so they should be used when making picture adjustments.

● Frame

Individual images in a video or on the television are called frames.

● Field

Half of the video information (video signal) in a frame is called a field. With conventional TV systems, a single frame (a single screen) consists of two fields.

● Frame still

The two fields are displayed alternately on the TV screen, so the image may be blurry. However, the image quality is better than field images.

● Field still





















Only one field (half of the video information) is displayed on the TV screen, so the apparent resolution is low. However, there is no blurring on the screen.

How different kinds of software appear on your television

DVD software is recorded in a variety of picture formats, and how they appear on your TV depends on the software, the kind of TV you have, and the picture mode your TV is set to.

● Letterbox refers to pictures where black bands appear at the top and bottom.

● Pan and scan refers to pictures where part of the picture is cut off so it fills the whole screen.

Television and picture mode \ Software format	4:3	16:9 full mode	16:9 zoom mode	16:9 auto mode
Widescreen, pan and scan 	Edges cut off 	Full screen 	Top and bottom cut off 	Full screen 
Widescreen, non-pan and scan 	Letterbox 			
Regular (4:3) 	Full screen 	Screen stretched horizontally 	Top and bottom cut off 	Full screen with black bands at right and left 
Regular (4:3) letterbox 	Letterbox 	Letterbox with screen stretched horizontally 	Full screen 	Letterbox with extremities of picture stretched 

The names given to the television picture modes depends on your television. There may also be slight differences in how the pictures appear on the screen. Refer to your television's operating instructions for details.

■ Upgrading your audio equipment

Setup chart				
Equipment and settings Types of connection	Equipment	Speakers	Settings in "7 Digital Audio Output"	Page
To enjoy the 5.1-channel surround sound found on DVDs using the decoder in another unit	Amplifier with built-in decoder or a separate decoder-amplifier combination*1	<ul style="list-style-type: none"> • Front speakers (L/R) • Subwoofer • Surround speakers (L/R) • Center speaker 	<ul style="list-style-type: none"> • PCM Down Conversion ⇒ "Yes" • Dolby Digital/DTS Digital Surround ⇒ Settings depend on your decoding equipment 	A 34
To enjoy stereo through a digital amplifier*2	Audio equipment with digital audio input terminals	Front speakers (L/R)	<ul style="list-style-type: none"> • PCM Down Conversion ⇒ "Yes" • Dolby Digital ⇒ "PCM" • DTS Digital Surround ⇒ "Off" 	B 35
To enjoy stereo through an analogue amplifier*2	Analogue amplifier or system component with 2-channel audio input terminals	Front speakers (L/R)	PCM Down Conversion ⇒ "No"	C 35

※1 Connect speakers if necessary and make the speaker settings on the amplifier.

※2 If you have connected an amplifier with Dolby Pro Logic decoder, you may need to connect center and surround speakers.

■ Upgrading your television

- You can connect CRT projectors, LCD projectors, and projection televisions.
- See "Connection to a television" (⇒ page 9) for details on connection.

Note

- The equipment connections described are examples.
- Peripheral equipment and optional cables sold separately unless otherwise indicated.

A Connecting an amplifier with a built-in decoder

You can enjoy the 5.1-channel surround sound found on DVD recorded with Dolby Digital or DTS Digital Surround by connecting an amplifier with a built-in decoder or a separate decoder-amplifier combination.

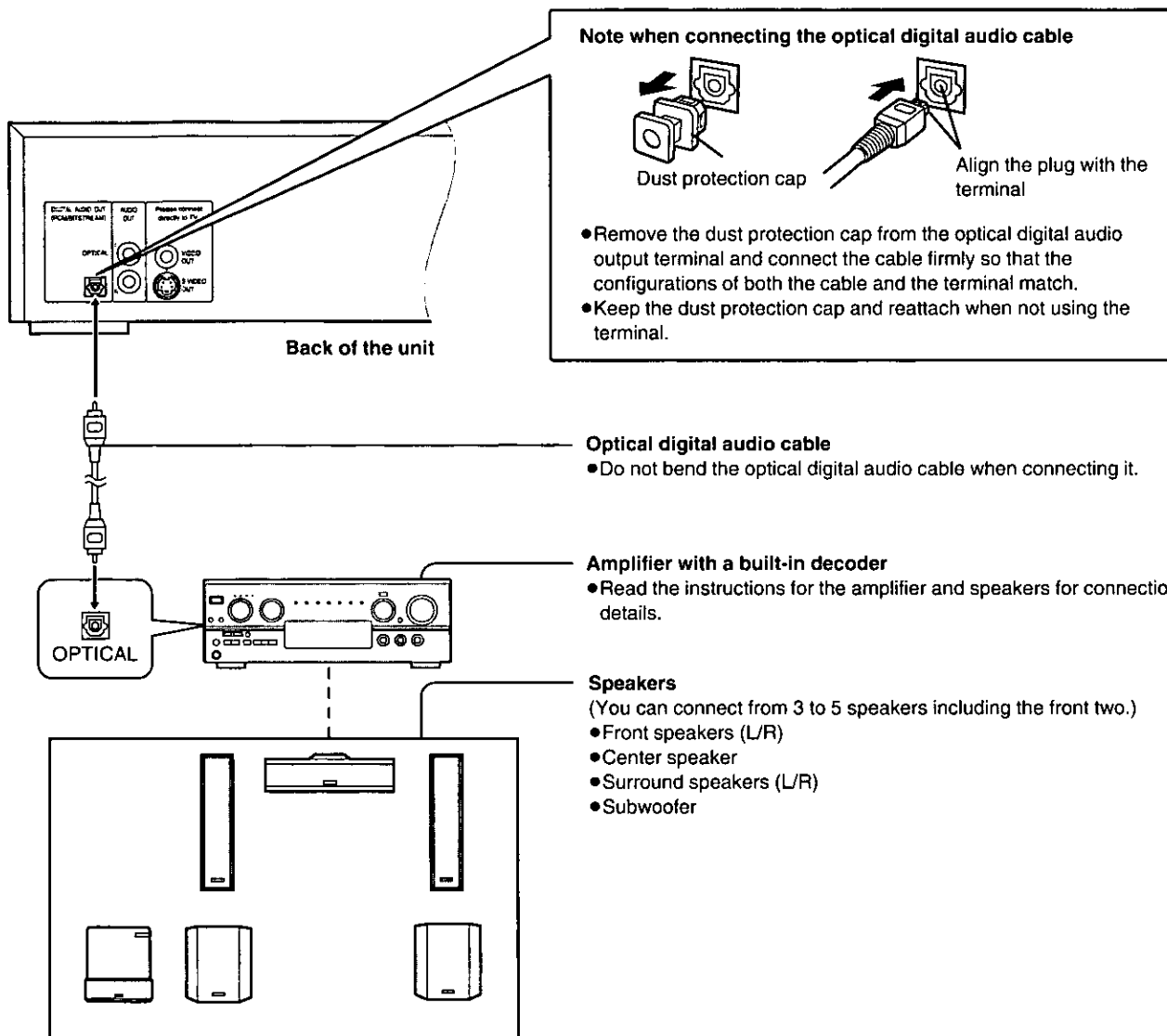

When you have finished connection

Make changes to "7 Digital Audio Output" to suit your decoder (= page 36).

Item	Decoder		
	Dolby Digital decoder	DTS Digital Surround decoder	Dolby Digital/ DTS Digital Surround decoder
PCM Down Conversion	Yes*	Yes*	Yes*
Dolby Digital	Bitstream	PCM	Bitstream
DTS Digital Surround	Off	Bitstream	Bitstream

※If this is set to "No", no audio will be output when DVDs recorded in 96 kHz linear PCM are played. (Audio will be output as it is if the DVD does not have copyright protection recorded on it.)

●These changes to digital audio output must be made, otherwise bitstream signals the decoder cannot handle will be output. If these signals are output, "noise" will be output which can cause harm to your ears and speakers.

Note

●You cannot use DTS Digital Surround decoders not suited to DVD.

B Connecting audio equipment with digital audio input terminals

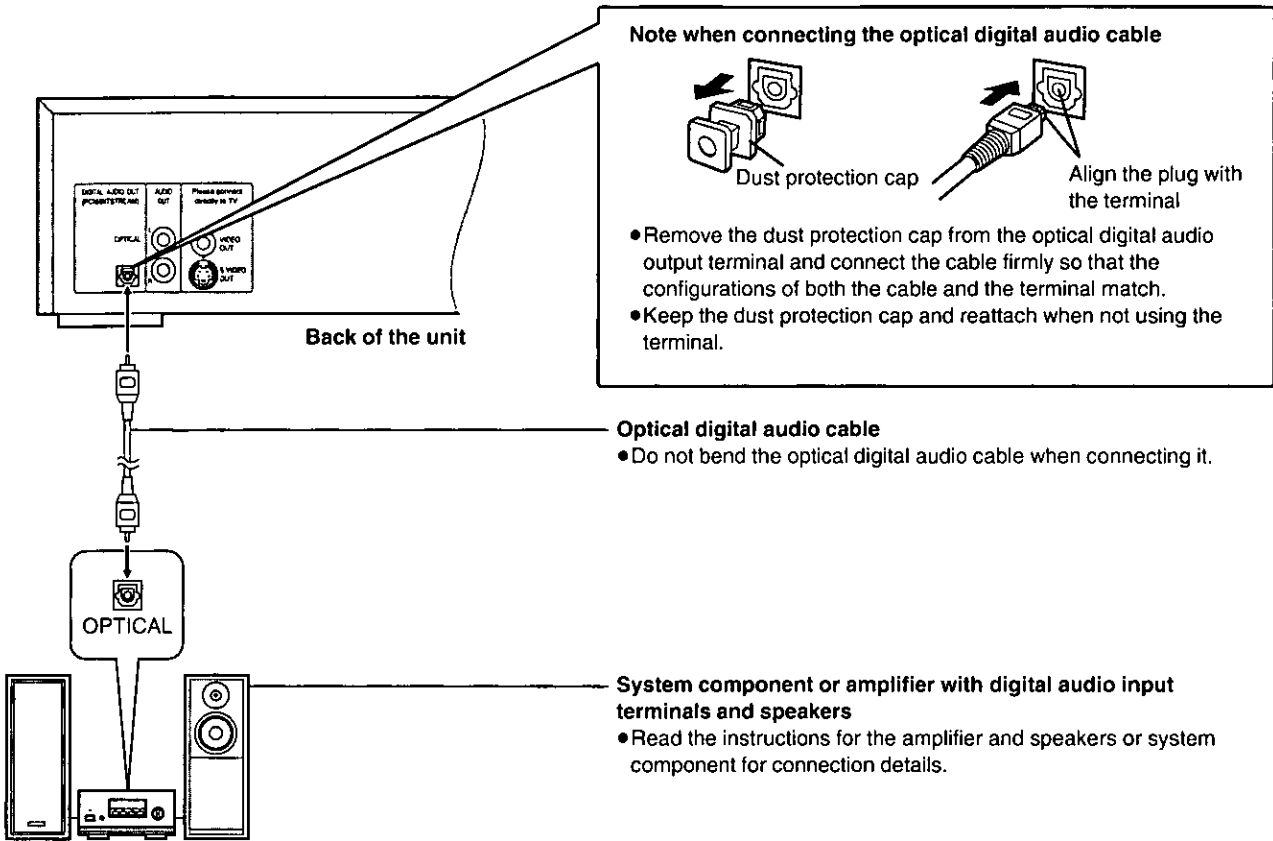

When you have finished connection

- Make changes to "7 Digital Audio Output" as shown (⇒ page 36).

PCM Down Conversion	Yes*
Dolby Digital	PCM
DTS Digital Surround	Off

※ If this is set to "No", no audio will be output when DVDs recorded in 96 kHz linear PCM are played. (Audio will be output as it is if the DVD does not have copyright protection recorded on it.)

- These changes to digital audio output must be made, otherwise signals the equipment cannot handle, bitstream, will be output. If the signals are output as bitstream, "noise" will be output which can cause harm to your ears and speakers.

C Connecting audio equipment with 2-channel audio input terminals

You can enjoy stereo sound if you connect an amplifier or system component that has 2-channel audio input terminals.

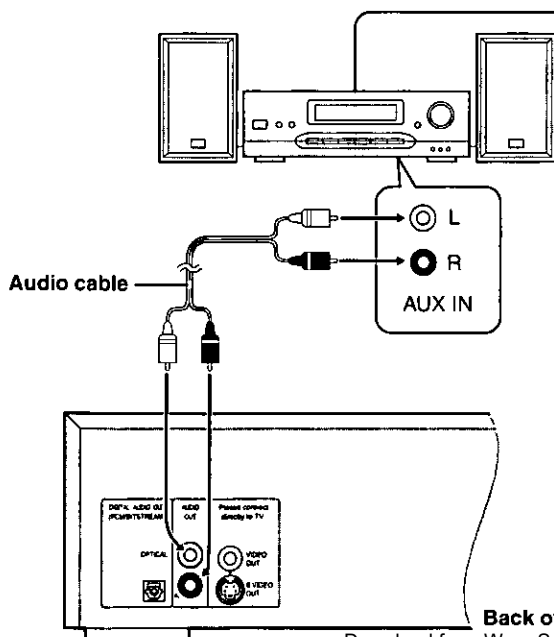

Amplifier and speakers or system component

- Read the instructions for the amplifier and speakers or system component for connection details.

To enjoy Dolby Pro Logic

- If you connect an amplifier with Dolby Pro Logic decoder, you will also need to connect center and surround speakers to enjoy surround sound. Read the instructions for the equipment for connection details.
- Turn V.S.S. off (⇒ page 21). Dolby Pro Logic decoder will not function correctly if V.S.S. is on.

When you have finished connection

- Go to "7 Digital Audio Output" and set "1 PCM Down Conversion" to "No" (⇒ page 36).

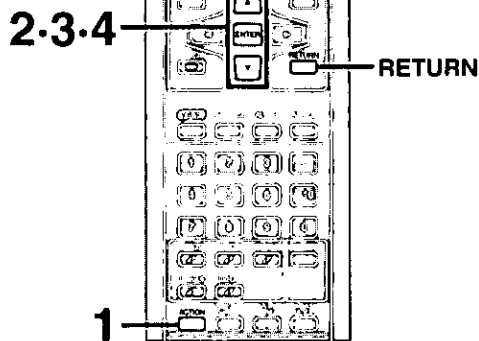

Selecting digital output

Select the digital output to be output from the optical digital audio output terminal of the unit.

- 1** Press [ACTION] in the stop mode.
The initial settings screen is displayed.
- 2** Press the cursor buttons [▲, ▼] to select "7 Digital Audio Output" and press [ENTER].
- 3** Press the cursor buttons [▲, ▼] to select the item and press [ENTER].

- 1 PCM Down Conversion**
Select whether to output audio on DVD recorded in 96 kHz linear PCM as is (No) or to convert it to 48 kHz for output (Yes).
- 2 Dolby Digital**
To select the signal format (Bitstream or PCM) to be output from the optical digital audio output terminal during play of DVDs recorded in Dolby Digital.
- 3 DTS Digital Surround**
To select whether DTS Digital Surround bitstream is output from the optical digital audio output terminal or no digital audio is output during play of DVDs recorded in DTS Digital Surround.

- 4** Press the cursor buttons [▲, ▼] to select the setting and press [ENTER].

When "1 PCM Down Conversion" is selected

- 1 No** (Factory preset)
No digital audio is output during play of DVDs recorded in 96 kHz linear PCM.
 - If the DVD is recorded in 48 kHz linear PCM, digital audio converted to 48 kHz/16 bit is output regardless of the setting.
 - Audio will be output using the original audio recording system if the DVD has not been copyright-protected.
- 2 Yes*1**
During play of DVDs recorded in 48 kHz or 96 kHz linear PCM, digital audio converted to 48 kHz/16 bit is output. (Digital output of PCM audio is restricted to 48 kHz/16 bit or below for copyright protection.)

When "2 Dolby Digital" is selected

- 1 Bitstream*2** (Factory preset)
Dolby Digital bitstream (1ch–5.1ch) is output during play of DVDs recorded in Dolby Digital.
- 2 PCM**
Digital audio converted to 48 kHz/16 bit PCM (2ch) is output during play of DVDs recorded in Dolby Digital.

When "3 DTS Digital Surround" is selected

- 1 Off** (Factory preset)
No digital audio is output during play of DVDs recorded in DTS Digital Surround.
- 2 Bitstream*2**
DTS Digital Surround bitstream (1ch–5.1ch) is output during play of DVDs recorded in DTS Digital Surround.

The screen illustrated in step 2 is displayed.

To cancel during setup operation

Press [RETURN]. (The previous screen is displayed.)

To exit the initial settings screen

Press [ACTION] or [RETURN].

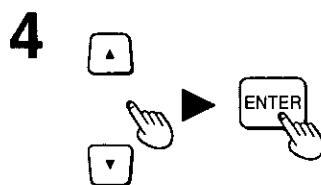
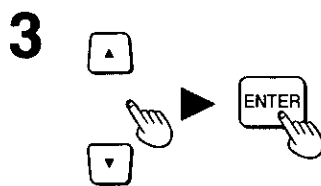
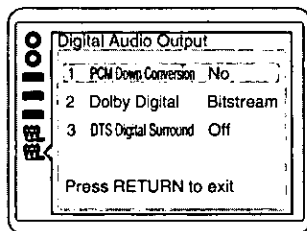
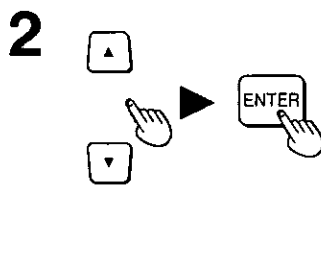
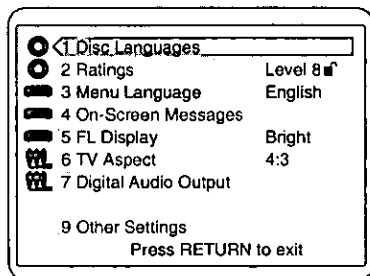
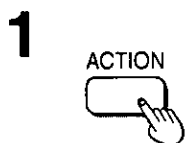

For your reference

- Dolby Digital is a digital sound compression technique developed by Dolby Laboratories. Supporting 5.1-channel surround sound, as well as stereo (2-channel) sound, this technique enables a large quantity of sound data to be efficiently recorded on a disc.
- DTS Digital Surround is a 5.1-channel surround sound system, which is widely used in movie theaters around the world. The separation between channels is good and provides a very real surround effect.
- Linear PCM is an uncompressed digital audio signal. While a CD is recorded in 44.1 kHz/16 bit, a DVD is recorded in 48 kHz/16 bit up to 96 kHz/24 bit. Therefore, the sound reproduced with these signals is potentially better than that found on CDs. This unit reproduces linear PCM in two channels.
- Bitstream is a compressed digital audio signal. This signal can be decoded into different channels to produce, for instance, 5.1-channel surround sound.
- The digital audio output terminal (optical) converts electrical signals into optical signals and transfers them to an amplifier. These optical signals are immune to electrical interference, and they also have minimal effect on other equipment.

Manufactured under license from Dolby Laboratories. "Dolby", "Pro Logic" and the double-D symbol are trademarks of Dolby Laboratories. Confidential unpublished works. © 1992–1997 Dolby Laboratories. All rights reserved.

"DTS" and "DTS Digital Surround" are trademarks of Digital Theater Systems, Inc.

Recommended setting of "Digital Audio Output"

Adjust settings as shown in the table below depending on the kind of equipment that is connected to the optical digital audio output terminal.

Type of equipment connected	Recommended setting		
	1 PCM Down Conversion	2 Dolby Digital	3 DTS Digital Surround
No equipment is connected	No	<u>Bitstream</u>	<u>Off</u>
Digital audio equipment (no decoder) (⇒ page 35) B	Yes*1	PCM*2	<u>Off</u> *2
Dolby Digital decoder (⇒ page 34) A	Yes*1	<u>Bitstream</u>	<u>Off</u>
DTS Digital Surround decoder (⇒ page 34) A	Yes*1	PCM	Bitstream
Dolby Digital/DTS Digital Surround decoder (⇒ page 34) A	Yes*1	<u>Bitstream</u>	Bitstream

●Underlined items are factory preset.

※1 If it is set to "Yes", the unit converts linear PCM to 48 kHz even during analogue output.

Do the following if you wish to take advantage of high quality 96 kHz sound.

Select "No" and connect this unit's audio output terminal to an amplifier's audio input terminal with the audio/video cable (included) or an audio cable (not included).

※2 When connecting an amplifier (with an optical digital input terminal) which does not contain a Dolby Digital or DTS Digital Surround decoder, be sure to select "PCM" at "2 Dolby Digital" and "Off" at "3 DTS Digital Surround". If "Bitstream" is selected, any attempt to play DVDs (or CDs encoded with DTS) may cause a high level of noise that can injure your ears and damage your speakers.

Troubleshooting Guide

Before requesting service for this unit, check the chart below for a possible cause of the problem you are experiencing. Some simple checks or a minor adjustment on your part may eliminate the problem and restore proper operation.

If you are in doubt about some of the check points, or if the remedies indicated in the chart do not solve the problem, refer to the directory of Authorized Service Centers (enclosed with this unit) to locate a convenient service center, or consult your dealer for instructions.

For detailed instructions, contact an authorized servicenter in the U.S.A. and Panasonic Canada Inc. Customer Care Centre in Canada. In the U.S.A., call 1-800-211-7262, e-mail consumerproducts@panasonic.com, or visit www.panasonic.com. In Canada, call 1-800-561-5505 or visit www.panasonic.ca

Reference pages are shown as black circled numbers ❸.

Common Problems

No power.	Insert the AC power supply cord securely into the household AC outlet. ❸
The unit is automatically switched to the standby mode.	To conserve power, the unit automatically switches to the standby mode after approximately 30 minutes elapse in the stop mode (Auto power-off function). Turn the power back to ON.
Play fails to start even when [▶ PLAY] is pressed. Play starts but then stops immediately.	Condensation has formed: Wait about 1 to 2 hours for it to evaporate. This unit cannot play discs other than DVD, Video CD and CD. ❸ DVDs with a region number other than "1" or "ALL" cannot be played. DVDs with multiple region numbers including "1" can be played. ❸ The disc may be dirty and may require cleaning. ❹ Ensure that the disc is installed with the label of the side to be played facing upwards. ❶ A disc or foreign object has fallen inside the unit. Open the disc tray and remove the object.
No picture.	Ensure that the equipment is connected properly. ❸ Ensure the television's video input setting (e.g. VCR 2) is correct.
No sound. Distorted sound.	Ensure that the equipment is connected properly. ❸ ❸❸–❸❹ Ensure that the input settings for the television and stereo system are correct. Turn V.S.S. off if it is on. ❷ ❷❹
Picture distorted during rapid advance or rapid reverse.	The picture will be somewhat distorted at times: This is normal.
No key operation (by the main unit and/or the remote control) is effective.	Some operations may be prohibited by the disc. Press [POWER ⏻/⏻] to switch the unit to the standby mode and then back to ON. Alternatively, press [POWER ⏻/⏻] to switch the unit to the standby mode, disconnect the AC power supply cord and then reconnect it. (The unit may not be operating properly due to lightning, static electricity or some other external factor.)
The picture shown on the television is not normal. (The sides of the picture are cut off or black bands appear at the top and bottom of the screen.)	Go to the initial settings menu "6 TV Aspect" and change the setting to suit your television. You may also need to change the screen mode on the television itself. ❶ ❷❷
No on-screen display.	"Off" is selected for "1 On-Screen Messages" in "4 On-Screen Messages": Select "On". ❸❶
On-Screen Menu Icons not displayed or only partially displayed on the TV screen.	Change the position of the On-Screen Menu Icons using "2 Color and Position" in "4 On-Screen Messages" of the initial settings. ❸❶
The language for the unit's menus and on-screen messages is wrong.	Go to the initial settings menu "3 Menu Language" and change the language. ❸❶
No operations can be performed with the remote control.	To conserve power, the unit automatically switches to the standby mode after approximately 30 minutes elapse in the stop mode (Auto power-off function). Turn the power back ON. Check the batteries are installed with the correct polarities (+ and -). ❸ The batteries are depleted: Replace them with new ones. ❸ Point the remote control at the remote control sensor and operate. ❸ Operate the remote control at a distance of not more than 23 feet (7 m) from the remote control sensor. ❸ Remove the obstacles between the remote control and remote control sensor. ❸

For Your Reference

DVD

No subtitles.	Subtitles appear only with discs which contain them. Subtitles are cleared from the TV monitor. Display the subtitles. ⑬ ⑮
Alternative soundtrack (or subtitle) languages fail to be selected.	An alternative language is not selected with discs which do not contain more than one language. In the case of some discs, the alternative language cannot be selected by operating the [AUDIO] or [SUBTITLE]. Try selecting it from the disc's menu if one is available. ⑩
Angle cannot be changed.	This function is dependent on software availability. Even if a disc has a number of angles recorded, these angles may be recorded for specific scenes only (when " " lights up on the unit's FL display). ⑬
Soundtrack and/or subtitle language is not the one selected at the initial settings.	If the soundtrack and/or subtitle language does not exist on the disc, the language selected at the initial settings will not be seen/heard.
The disc's menu is displayed in French (example).	The setup "3 Menu" of "1 Disc Languages" is set to French: Select English. ⑳
Sound does not come from a speaker.	Check the connections. ⑨ ⑳-㉓ If you have connected this unit to an amplifier (with built-in decoder) through the digital audio output terminal, go to the initial settings menu "7 Digital Audio Output" and change the settings to "Bitstream" for "2 Dolby Digital" or "3 DTS Digital Surround". ㉔
You have forgotten your ratings password. Reset all the settings to Factory Preset.	While stopped, press and hold [◀] and [▶] on the unit and then also press and hold [▲ OPEN/CLOSE] on the unit until "Initialized" disappears from the television (after approx. 3 seconds). All initial settings will return to the default values.
The vocals cannot be turned off.	You have selected an audio channel that includes a vocal channel. Read the disc's jacket to choose the correct channel. ⑰
There are no vocals while playing Karaoke DVD.	When you have connected this unit to other equipment through the DIGITAL AUDIO OUT terminal, go to "7 Digital Audio Output" in the initial settings and change the setting for "2 Dolby Digital" to "PCM". ㉓ ㉔ ㉕ ⑰
A menu is shown after playing each song on a Karaoke DVD.	Most Karaoke DVDs are designed to do this. Some discs have an item in the menu that allows you to play all the songs. ⑰

Video CD

No menu play.	This function works only for Video CDs with playback control. ⑥
----------------------	---

Self-diagnosis display function

When an error or trouble is detected during operation, a message appears in the FL display.
When a message has appeared, check the details given below.

Message	Unit status	Remedy
CHECK THE DISC	Disc is dirty.	Wipe the disc clean. ①
H□□ □□ stands for a number.	Trouble is likely to have occurred. The number following "H" depends on the status of the unit.	Press [POWER ⏻/⏻] to switch the unit to the standby mode and then back to ON. Alternatively, press [POWER ⏻/⏻] to switch the unit to the standby mode, disconnect the AC power supply cord, and then reconnect it.

•If the message fails to be cleared, even when remedial action is taken, ask a service technician to repair the unit.

Product Service

Do not attempt to remove the cover(s) or repair the unit yourself. Refer servicing to qualified personnel only.

Product information

For product service, product information or assistance with product operation, refer to the servicer directory.

If you ship the product

Carefully pack and send it prepaid, adequately insured and preferably in the original carton. Attach a postage-affixed letter, detailing the complaint, to the outside of the carton. **DO NOT send the product to the Executive or Regional Sales offices. They are NOT equipped to make repairs.**

Before moving the unit

CAUTION:

Before moving the unit, do the following to ensure the disc trays are empty. Failure to do so will risk severely damaging the discs and the unit.

- 1 Remove all the discs.**
- 2 Press [POWER ⏻/⏻] to turn the unit off.**
- 3 Disconnect the AC power supply cord.**

Maintenance

To clean this unit, wipe with a soft, dry cloth.

If the surfaces are extremely dirty, use a soft cloth dipped in a soap-and-water solution or a weak detergent solution.

- Never use alcohol, paint thinner or benzine to clean this unit.
- Before using chemically treated cloth, read the instructions that came with the cloth carefully.

Disc handling

A



Choose discs with these marks **A**

However, do not use irregularly shaped discs, such as heart-shaped. (Discs of this sort can damage the unit.) **B**

■ How to hold a disc

Do not touch the recorded surface. **C**

■ If the surface is dirty

Wipe it with a damp cloth and then wipe dry. **D**

■ If the disc is brought from a cold to a warm environment, moisture may form on the disc

Wipe with a soft, dry, lint-free cloth before using the disc.

■ Handling precautions

- Do not write on the label side with a ball-point pen or other writing instrument.
- Do not use record cleaning sprays, benzene, thinner, static electricity prevention liquids or any other solvent.
- Do not attach labels or stickers to discs. (Do not use discs with exposed adhesive from tape or left over peeled-off stickers.)
- Do not use scratch-proof protectors or covers other than those specified for use with this unit.

■ Do not place or store discs in the following places

- Locations exposed to direct sunlight
- Humid or dusty locations
- Locations directly exposed to a heat vent or heating appliance

B

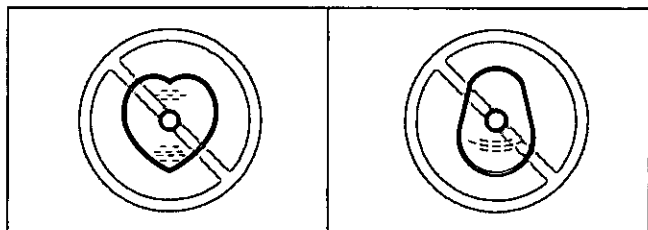

C

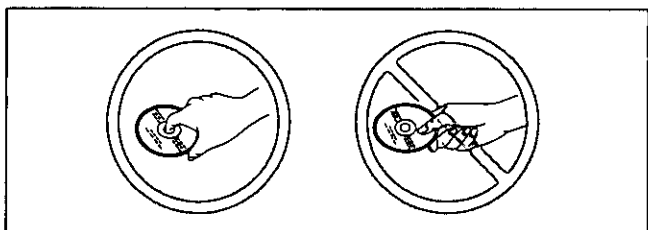

D

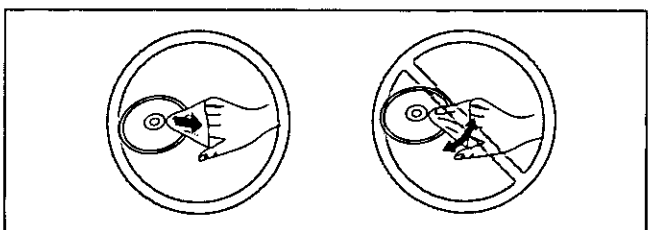

Panasonic

Technics

Quasar

*For Product Information, Operating Assistance, Literature Request, Dealer Locations, and all Customer Service inquiries please contact:
1-800-211-PANA (7262), Monday-Friday 9 am-9 pm; Saturday-Sunday 9 am-7 pm, EST.*

*Web Site: <http://www.panasonic.com>
You can purchase parts, accessories or locate your nearest servicenter by visiting our Web Site.*

Accessory Purchases:

1-800-332-5368 (Customer Orders Only)
Panasonic Services Company 20421 84th Avenue South, Kent, WA 98032
(6 am to 5 pm Monday-Friday; 6 am to 10:30 am Saturday; PST)
(Visa, MasterCard, Discover Card, American Express, Check)

Factory Servicenters Locations

CALIFORNIA
6550 Katella Avenue
Cypress, CA 90630

800 Dubuque Avenue
S. San Francisco
CA 94080

20201 Sherman Way
Suite 102
Canoga Park, CA 91306

3878 Ruffin Road
Suite A
San Diego, CA 92123

COLORADO
1640 South Abilene Street
Suite D
Aurora, CO 80012

FLORIDA
3700 North 29th Avenue
Suite 102
Hollywood, FL 33020

GEORGIA
8655 Roswell Road
Suite 100
Atlanta, GA 30350

ILLINOIS
9060 Golf Road
Niles, IL 60714

1703 North Randall Road
Elgin, IL 60123
(Pick-up/Drop-off only)

MARYLAND
62 Mountain Road
Glen Burnie, MD 21061

MASSACHUSETTS
60 Glacier Drive
Suite G
Westwood, MA 02090

MICHIGAN
37048 Van Dyke Avenue
Sterling Heights, MI 48312

MINNESOTA
7850-12th Avenue South
Airport Business Center
Bloomington, MN 55425

OHIO
2236 Waycross Road
Civic Center Plaza
Forest Park, OH 45240

PENNSYLVANIA
2221 Cabot Blvd. West
Suite B
Langhorne, PA 19047

TEXAS
13615 Welch Road
Suite 101
Farmers Branch
TX 75244

WASHINGTON
20425-84th Avenue South
Kent, WA 98032

HAWAII
99-859 Iwaiwa Street
Aiea, Hawaii 96701
Phone (808) 488-1996
Fax (808) 486-4369

For Your Reference

Service in Puerto Rico

*Matsushita Electric of Puerto Rico, Inc. Panasonic Sales Company/Factory Servicenter:
Ave. 65 de Infanteria, Km. 9.5, San Gabriel Industrial Park, Carolina, Puerto Rico 00985
Phone (787) 750-4300 Fax (787) 768-2910*

F04030 As of APR '00

Specifications

Power requirements: AC 120 V, 60 Hz
Power consumption: 16 W
Dimensions: 16^{15/16}" (W) × 11^{3/16}" (D) × 4^{1/2}" (H)
[430 (W) × 284 (D) × 114 (H) mm]
(excluding protrusions)
Mass: 8.8 lb. (4.0 kg)
Signal system: NTSC
Operating temperature range:
+41 to +95 °F (+5 to +35 °C)
Operating humidity range: 5–90 % RH (no condensation)

Discs played:

(1) DVD-Video disc:

5" (12 cm) single-sided, single-layer
5" (12 cm) single-sided, dual-layer
5" (12 cm) double-sided, single-layer
3" (8 cm) single-sided, single-layer
3" (8 cm) single-sided, dual-layer
3" (8 cm) double-sided, single-layer

(2) Compact disc (CD-DA, Video CD):

5" (12 cm) disc
3" (8 cm) disc

Video output:

Output level: 1 Vp-p (75 Ω)
Output terminal: Pin jack (1 system)

S video output:

Y output level: 1 Vp-p (75 Ω)
C output level: 0.286 Vp-p (75 Ω)
Output terminal: S terminal (1 system)

Audio output:

Output level: 2 Vrms (1 kHz, 0 dB)
Output terminal: Pin jack (1 system)

Audio signal output characteristics:

- (1) Frequency response:
• DVD (linear audio): 4 Hz–22 kHz (48 kHz sampling)
4 Hz–44 kHz (96 kHz sampling)
• CD audio: 4 Hz–20 kHz (EIAJ)
- (2) S/N ratio:
• CD audio: 115 dB (EIAJ)
- (3) Dynamic range:
• DVD (linear audio): 102 dB
• CD audio: 98 dB (EIAJ)
- (4) Total harmonic distortion:
• CD audio: 0.0025 % (EIAJ)

Digital audio output:

Optical digital output: Optical terminal
Pickup: Wave length: 665 nm
Laser power: CLASS II

Power consumption in standby mode: approx. 2.0 W

Note

Specifications are subject to change without notice.
Mass and dimensions are approximate.

Apparatus Claims of U.S. Patent Nos. 4,631,603, 4,577,216, and 4,819,098, licensed for limited viewing uses only.

This product incorporates copyright protection technology that is protected by method claims of certain U.S. patents and other intellectual property rights owned by Macrovision Corporation and other rights owners. Use of this copyright protection technology must be authorized by Macrovision Corporation, and is intended for home and other limited viewing uses only unless otherwise authorized by Macrovision Corporation. Reverse engineering or disassembly is prohibited.

**Panasonic Consumer Electronics
Company, Division of Matsushita
Electric Corporation of America**

One Panasonic Way Secaucus,
New Jersey 07094

<http://www.panasonic.com>

**Panasonic Sales Company,
Division of Matsushita Electric of
Puerto Rico, Inc. ("PSC")**

Ave. 65 de Infantería, Km. 9.5
San Gabriel Industrial Park, Carolina,
Puerto Rico 00985

En

© 2000 Matsushita Electric Industrial Co., Ltd.

Printed in Japan

RQT5613-P
F0600MS0

Free Manuals Download Website

<http://myh66.com>

<http://usermanuals.us>

<http://www.somanuals.com>

<http://www.4manuals.cc>

<http://www.manual-lib.com>

<http://www.404manual.com>

<http://www.luxmanual.com>

<http://aubethermostatmanual.com>

Golf course search by state

<http://golfingnear.com>

Email search by domain

<http://emailbydomain.com>

Auto manuals search

<http://auto.somanuals.com>

TV manuals search

<http://tv.somanuals.com>