

DVD/CD PLAYER

Operating Instructions

Model No. **DVD-F87/DVD-F86/DVD-F84**



The illustration shows DVD-F87 for U.S.A. and Canada.

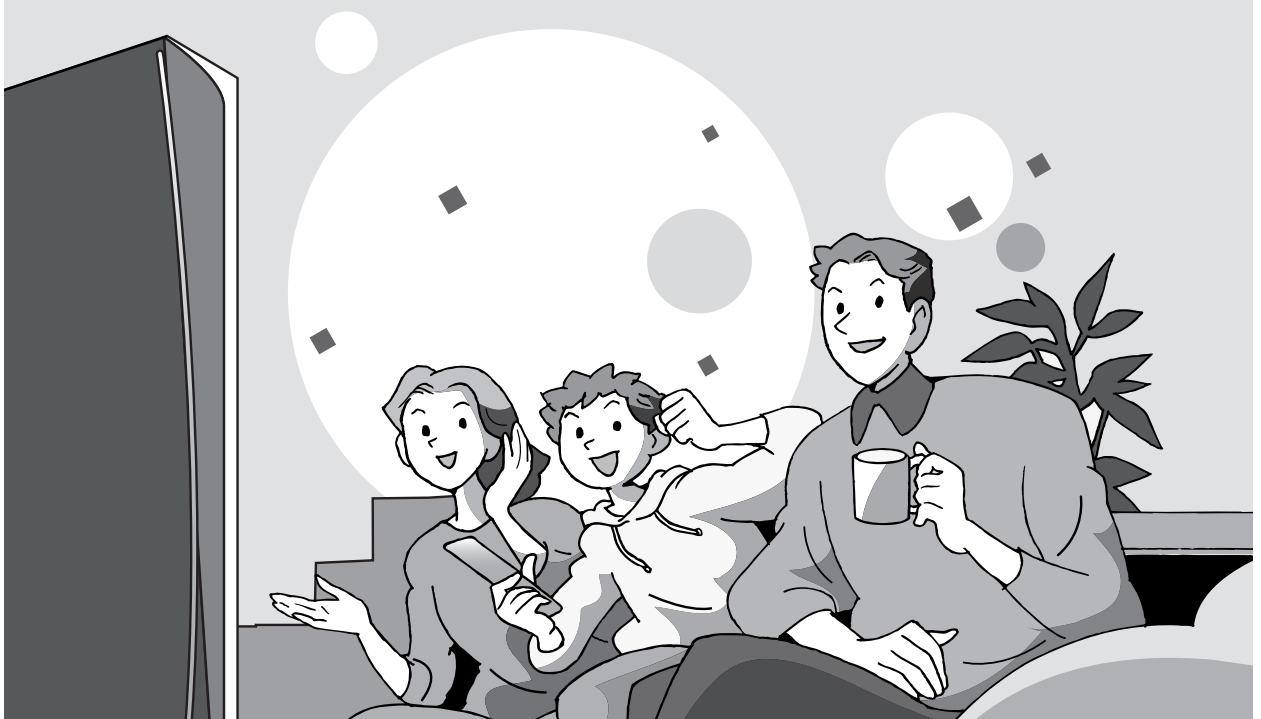

Dear customer

Thank you for purchasing this product. For optimum performance and safety, please read these instructions carefully before connecting, operating or adjusting this product. Please keep this manual for future reference.



Region number

The player plays DVD-Video marked with labels containing the region number or "ALL".

Region	Number
U.S.A. and Canada	1
Asia	3
Australia and N.Z.	4

Example: **U.S.A. and Canada**



Unless otherwise indicated, illustrations in these operating instructions are DVD-F87 for U.S.A. and Canada.

Table of contents

Getting started

IMPORTANT SAFETY INSTRUCTIONS	2
Accessories/Discs that can be played	3
STEP 1 Connection to a television	4
STEP 2 The remote control	5
STEP 3 QUICK SETUP	5
Main unit and disc caution	5

Operations

Basic play	6
Changer functions	7
Enjoying higher quality audio and video	7
Using navigation menus	8
Changing the play sequences	9
Using On-Screen Menus	10
Changing the player settings	12
Convenient functions	14

Reference

Specifications/Maintenance	15
Troubleshooting guide	16
Product Service	17
Limited Warranty (ONLY FOR U.S.A.)	18
Referencia rápida en español	19

Main feature index

Back cover

CAUTION!

THIS PRODUCT UTILIZES A LASER. USE OF CONTROLS OR ADJUSTMENTS OR PERFORMANCE OF PROCEDURES OTHER THAN THOSE SPECIFIED HEREIN MAY RESULT IN HAZARDOUS RADIATION EXPOSURE. DO NOT OPEN COVERS AND DO NOT REPAIR YOURSELF. REFER SERVICING TO QUALIFIED PERSONNEL.

WARNING:

TO REDUCE THE RISK OF FIRE, ELECTRIC SHOCK OR PRODUCT DAMAGE, DO NOT EXPOSE THIS APPARATUS TO RAIN, MOISTURE, DRIPPING OR SPLASHING AND THAT NO OBJECTS FILLED WITH LIQUIDS, SUCH AS VASES, SHALL BE PLACED ON THE APPARATUS.

CAUTION!

- **DO NOT INSTALL OR PLACE THIS UNIT IN A BOOKCASE, BUILT-IN CABINET OR IN ANOTHER CONFINED SPACE. ENSURE THE UNIT IS WELL VENTILATED. TO PREVENT RISK OF ELECTRIC SHOCK OR FIRE HAZARD DUE TO OVERHEATING, ENSURE THAT CURTAINS AND ANY OTHER MATERIALS DO NOT OBSTRUCT THE VENTILATION VENTS.**
- **DO NOT OBSTRUCT THE UNIT'S VENTILATION OPENINGS WITH NEWSPAPERS, TABLECLOTHS, CURTAINS, AND SIMILAR ITEMS.**
- **DO NOT PLACE SOURCES OF NAKED FLAMES, SUCH AS LIGHTED CANDLES, ON THE UNIT.**
- **DISPOSE OF BATTERIES IN AN ENVIRONMENTALLY FRIENDLY MANNER.**

For the U.S.A. and Canada

CAUTION:

TO PREVENT ELECTRIC SHOCK MATCH WIDE BLADE OF PLUG TO WIDE SLOT, FULLY INSERT.

Before moving the unit, ensure the disc trays are empty.
Failure to do so will risk severely damaging the discs and the unit.

THE FOLLOWING APPLIES ONLY IN THE U.S.A.



CAUTION:

This equipment has been tested and found to comply with the limits for a Class B digital device, pursuant to Part 15 of the FCC Rules. These limits are designed to provide reasonable protection against harmful interference in a residential installation. This equipment generates, uses and can radiate radio frequency energy and, if not installed and used in accordance with the instructions, may cause harmful interference to radio communications. However, there is no guarantee that interference will not occur in a particular installation. If this equipment does cause harmful interference to radio or television reception, which can be determined by turning the equipment off and on, the user is encouraged to try to correct the interference by one or more of the following measures:

- Reorient or relocate the receiving antenna.
 - Increase the separation between the equipment and receiver.
 - Connect the equipment into an outlet on a circuit different from that to which the receiver is connected.
 - Consult the dealer or an experienced radio/TV technician for help.
- Any unauthorized changes or modifications to this equipment would void the user's authority to operate this device.

This device complies with Part 15 of the FCC Rules. Operation is subject to the following two conditions: (1) This device may not cause harmful interference, and (2) this device must accept any interference received, including interference that may cause undesired operation.

THE FOLLOWING APPLIES ONLY IN THE U.S.A. AND CANADA

	CAUTION RISK OF ELECTRIC SHOCK DO NOT OPEN	
<p>CAUTION: TO REDUCE THE RISK OF ELECTRIC SHOCK, DO NOT REMOVE SCREWS. NO USER-SERVICEABLE PARTS INSIDE. REFER SERVICING TO QUALIFIED SERVICE PERSONNEL.</p>		



The lightning flash with arrowhead symbol, within an equilateral triangle, is intended to alert the user to the presence of uninsulated "dangerous voltage" within the product's enclosure that may be of sufficient magnitude to constitute a risk of electric shock to persons.



The exclamation point within an equilateral triangle is intended to alert the user to the presence of important operating and maintenance (servicing) instructions in the literature accompanying the appliance.

IMPORTANT SAFETY INSTRUCTIONS

Read these operating instructions carefully before using the unit. Follow the safety instructions on the unit and the applicable safety instructions listed below. Keep these operating instructions handy for future reference.

- 1) Read these instructions.
- 2) Keep these instructions.
- 3) Heed all warnings.
- 4) Follow all instructions.
- 5) Do not use this apparatus near water.
- 6) Clean only with dry cloth.
- 7) Do not block any ventilation openings. Install in accordance with the manufacturer's instructions.
- 8) Do not install near any heat sources such as radiators, heat registers, stoves, or other apparatus (including amplifiers) that produce heat.
- 9) Do not defeat the safety purpose of the polarized or grounding-type plug. A polarized plug has two blades with one wider than the other. A grounding-type plug has two blades and a third grounding prong. The wide blade or the third prong are provided for your safety. If the provided plug does not fit into your outlet, consult an electrician for replacement of the obsolete outlet.
- 10) Protect the power cord from being walked on or pinched particularly at plugs, convenience receptacles, and the point where they exit from the apparatus.
- 11) Only use attachments/accessories specified by the manufacturer.
- 12) Use only with the cart, stand, tripod, bracket, or table specified by the manufacturer, or sold with the apparatus. When a cart is used, use caution when moving the cart/apparatus combination to avoid injury from tip-over.
- 13) Unplug this apparatus during lightning storms or when unused for long periods of time.
- 14) Refer all servicing to qualified service personnel. Servicing is required when the apparatus has been damaged in any way, such as power-supply cord or plug is damaged, liquid has been spilled or objects have fallen into the apparatus, the apparatus has been exposed to rain or moisture, does not operate normally, or has been dropped.



Accessories

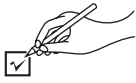

(Only for U.S.A.) To order accessories contact 1-800-332-5368 or the website (<http://www.pasc.panasonic.com>). (For other areas) To order accessories, call the dealer from whom you have made your purchase.

Use numbers when asking for replacement parts.



- 1 Remote control (N2QAJB000092)
- 1 AC Power supply cord (RJA0065-A)
U.S.A. and Canada (K2CJ2DA00008)
Australia and N.Z. (RJA0019-2X)
Asia
- 1 Audio/video cable (K2KA6CA00001)
- 2 Remote control batteries

Note

The included AC power supply cord is for use with this unit only. Do not use it with other equipment.

The model number and serial number of this product can be found on either the back or the bottom of the unit. Please note them in the space provided below and keep for future reference.

MODEL NUMBER _____
SERIAL NUMBER _____

User memo:

DATE OF PURCHASE _____
DEALER NAME _____
DEALER ADDRESS _____
TELEPHONE NUMBER _____

Accessories/Discs that can be played

Discs that can be played

Disc	Logo	Indication in these operating instructions	Remarks
DVD-RAM		RAM	Recorded using Version 1.1 of the Video Recording Format (a unified video recording standard). <ul style="list-style-type: none">Recorded with DVD video recorders, DVD video cameras, personal computers, etc.Remove discs from their cartridges before use.
		JPEG	Recorded using the DCF (Design rule for Camera File system) standard. <ul style="list-style-type: none">Recorded with Panasonic DVD-Video recordersTo play JPEG files, select "Play as Data Disc" in Other Menu (→ page 11).
DVD-Audio		DVD-A	—
		DVD-V	Some DVD-Audio discs contain DVD-Video content. To play DVD-Video content, select "Play as DVD-Video" in Other Menu (→ page 11).
DVD-Video		DVD-V	—
DVD-R		DVD-V	Panasonic DVD-R recorded and finalized* on a Panasonic DVD-Video recorders or DVD-Video cameras are played as DVD-Video on this unit.
Video CD		VCD	—
SVCD			Conforming to IEC62107
CD		CD	This unit is compatible with HDCD. HDCD-encoded CDs sound better because they are encoded with 20 bits, as compared with 16 bits for all other CDs. <ul style="list-style-type: none">During HDCD play, "HDCD" lights on the unit's display.This unit can play CD-R/RW (audio recording disc) recorded with the formats on the left. Close the sessions or finalize* the disc after recording.HighMAT discs WMA, MP3 or JPEG files only. To play without using the HighMAT function, select "Play as Data Disc" in Other Menu (→ page 11).
CD-R CD-RW	—	WMA MP3 JPEG CD VCD	

*A process that allows play on compatible equipment.

• It may not be possible to play the above discs in all cases due to the type of disc or condition of the recording.

Discs that cannot be played

DVD-ROM, CD-ROM, CDV, CD-G, DVD+R, +RW, DVD-RW, SACD, Divx Video Discs and Photo CD, DVD-RAM that cannot be removed from their cartridge, 2.6-GB and 5.2-GB DVD-RAM, and "Chaoji VCD" available on the market including CVD, DVCD and SVCD that do not conform to IEC62107.

Audio format of DVDs

You can play discs with these symbols.



HighMAT™ and the HighMAT logo are either trademarks or registered trademarks of Microsoft Corporation in the United States and/or other countries.

STEP 1 Connection to a television

- Do not place the unit on amplifiers or equipment that may become hot. The heat can damage the unit.
- **Do not connect through the video cassette recorder.** Due to copy guard protection, the picture may not display properly.
- Turn off all equipment before connection and read the appropriate operating instructions.
- Connect the terminals of the same color.

Connection to a television

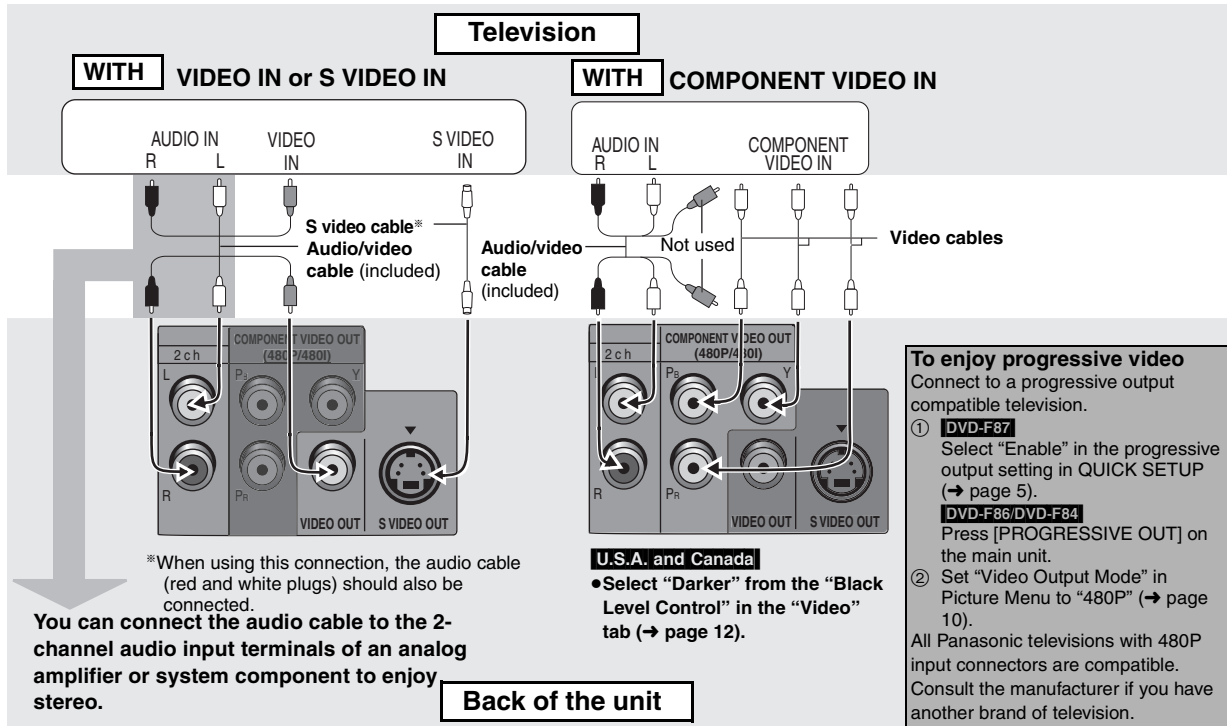

Enjoying multi-channel surround sound

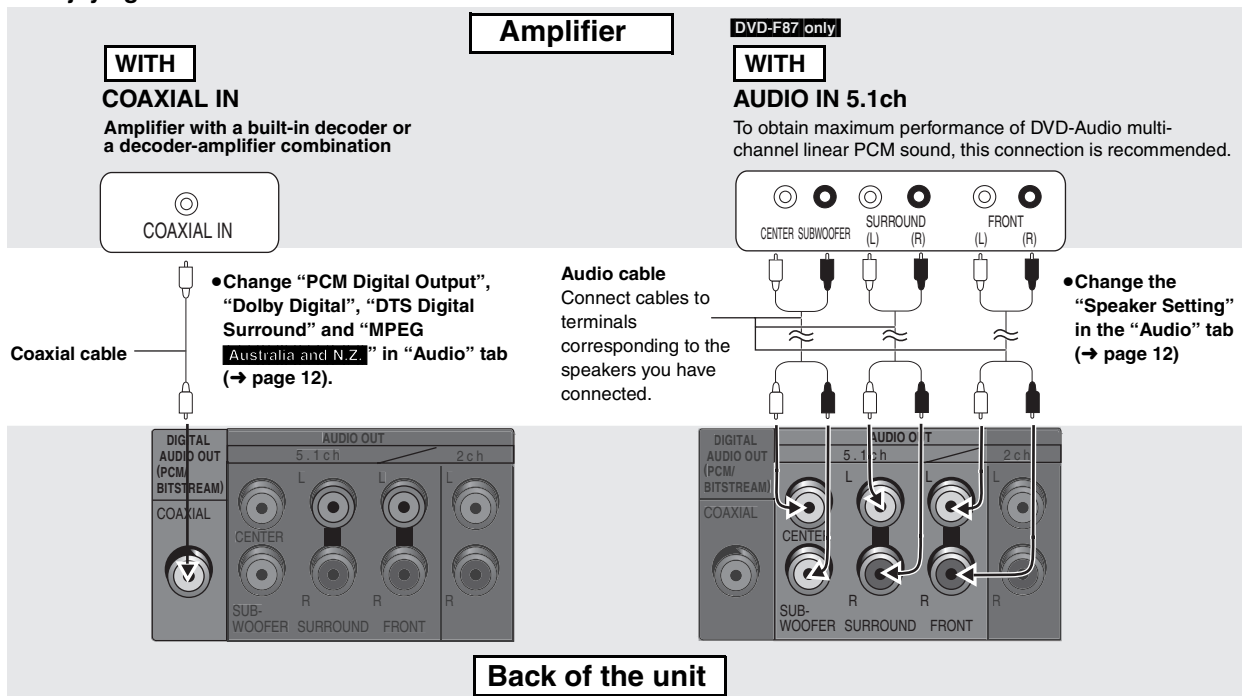

Connect the AC power supply cord last

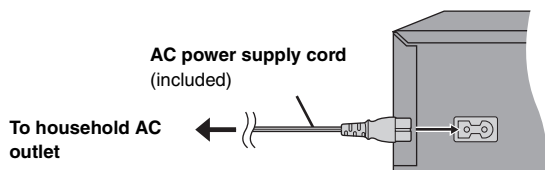

Conserving power

This unit consumes a small amount of power, even when it is turned off (approx. 0.7 W).
To save power when the unit is not to be used for a long time, unplug it from the household AC outlet.

STEP 2 The remote control

Batteries

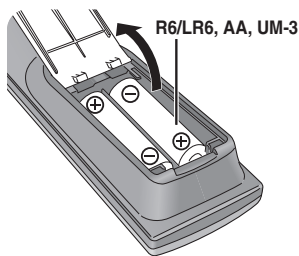

- Insert so the poles (+ and -) match those in the remote control.
- Do not use rechargeable type batteries.

Do not:

- mix old and new batteries.
- use different types at the same time.
- heat or expose to flame.
- take apart or short circuit.
- attempt to recharge alkaline or manganese batteries.
- use batteries if the covering has been peeled off.

Mishandling of batteries can cause electrolyte leakage which can damage items the fluid contacts and may cause a fire.

Remove if the remote control is not going to be used for a long period of time. Store in a cool, dark place.

Use

Aim at the remote control sensor, avoiding obstacles, at a maximum range of 7 m (23 feet) directly in front of the unit.

STEP 3 QUICK SETUP

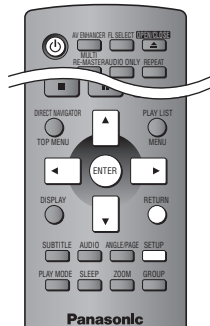

Turn on the television and select the appropriate video input on the television.

1 Power ON.	2 Shows QUICK SETUP screen.	3 Follow the message and make the settings.	4 Press to finish QUICK SETUP.	5 Press to exit.
---------------------------	---	---	--	--------------------------------

To change these settings later

Select "QUICK SETUP" in "Others" tab (→ page 13).

Main unit and disc caution

To prevent damage

- Do not;
 - load more than one disc per tray.
 - touch the drawer or the carousel while they are in motion
 - rotate the carousel by hand.
 - close the drawer by hand.

To clean discs

DVD-A DVD-V VCD CD

Wipe with a damp cloth and then wipe dry.

RAM DVD-R

- Clean with an optional DVD-RAM/PD disc cleaner (LF-K200DCA1, where available).
- Never use cloths or cleaners for CDs etc.

Disc handling precautions

- Do not attach labels or stickers to discs (This may cause disc warping, rendering it unusable).
- Do not write on the label side with a ball-point pen or other writing instrument.
- Do not use record cleaning sprays, benzene, thinner, static electricity prevention liquids or any other solvent.
- Do not use scratch-proof protectors or covers.
- Do not use the following discs:
 - Discs with exposed adhesive from removed stickers or labels (rented discs etc).
 - Discs that are badly warped or cracked.
 - Irregularly shaped discs, such as heart shapes.

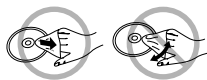

Manufactured under license from Dolby Laboratories. "Dolby", "Pro Logic" and the double-D symbol are trademarks of Dolby Laboratories.

Manufactured under license from Dolby Laboratories. "Dolby" and the double-D symbol are trademarks of Dolby Laboratories.

"DTS" and "DTS Digital Surround" are registered trademarks of Digital Theater Systems, Inc.

"DTS" and "DTS 2.0 + Digital Out" are trademarks of Digital Theater Systems, Inc.

Apparatus Claims of U.S. Patent Nos. 4,631,603, 4,577,216, and 4,819,098, licensed for limited viewing uses only.

This product incorporates copyright protection technology that is protected by method claims of certain U.S. patents and other intellectual property rights owned by Macrovision Corporation and other rights owners. Use of this copyright protection technology must be authorized by Macrovision Corporation, and is intended for home and other limited viewing uses only unless otherwise authorized by Macrovision Corporation. Reverse engineering or disassembly is prohibited.

MPEG Layer-3 audio decoding technology licensed from Fraunhofer IIS and Thomson multimedia.

Windows Media, and the Windows logo are trademarks, or registered trademarks of Microsoft Corporation in the United States and/or other countries.



WMA is a compression format developed by Microsoft Corporation. It achieves the same sound quality as MP3 with a file size that is smaller than that of MP3.

HD CD®, HD CD®, High Definition Compatible Digital® and Pacific Microsonics™ are either registered trademarks or trademarks of Pacific Microsonics, Inc. in the United States and/or other countries.

HD CD system manufactured under license from Pacific Microsonics, Inc. This product is covered by one or more of the following: In the USA : 5,479,168, 5,638,074, 5,640,161, 5,808,574, 5,838,274, 5,854,600, 5,864,311, 5,872,531, and in Australia: 669114, with other patents pending.



1 Power ON.
POWER

2 Open the drawer and place the disc(s).

- Load double-sided discs so the label for the side you want to play is facing up.
- To load discs on the other trays, press [DISC SKIP] on the main unit.
- Play will start from the disc in the front-left position.

3 Close the drawer.
The disc indicators light when there are discs in the trays.

4 Start play.

▶

When the disc finishes playing
If the next disc doesn't start playing, select the disc (→ page 7, Disc selection).

Press to skip.
Press and hold to
–search.
–slow-motion.

Disc select buttons/indicators

DISC SKIP

Remote control signal sensor

Stop		<p>The position is memorized when "▶" flashes on the display.</p> <ul style="list-style-type: none"> • Press [▶] (PLAY) to resume. • DVD-V To review the previous chapters (→ page 14, Position memory) • Press [■] to clear the position. 	
Pause		<ul style="list-style-type: none"> • Press [▶] (PLAY) to restart play. 	
Skip		(Group skip WMA MP3 JPEG)	
Search (during play)		<ul style="list-style-type: none"> • Up to 5 steps • Press [▶] (PLAY) to start play. • VCD Slow motion, forward direction only 	
Slow-motion (during pause)			
Frame-by-frame (during pause)		• VCD forward direction only	
On-screen item select		Select Register	
Enter number		<p>RAM DVD-A DVD-V VCD CD</p> <p>e.g. To select 12: [≥10] → [1] → [2]</p> <p>VCD with playback control While stopped, press the numbered buttons.</p> <p>WMA MP3 JPEG</p> <p>e.g. To select 123: [1] → [2] → [3] → [ENTER]</p> <ul style="list-style-type: none"> • Press [CANCEL] to cancel the number(s). 	
Disc menu		<p>DVD-A DVD-V Shows a disc top menu</p> <p>DVD-V Shows a disc menu</p> <p>VCD Shows a disc menu</p>	
Return to previous screen			
Main unit display		Number display ↑ ↓ Time display	
Information screen		WMA MP3 JPEG Turns the information screen on/off	

Note

- "D.MIX" on the display indicates that a multi-channel soundtrack can be down-mixed to two channels.
- Discs continue to rotate while menus are displayed. Press [■] when you finish to preserve the unit's motor and your television screen.

If you are experiencing problems, refer to troubleshooting (→ page 16, 17)

Asia, Australia and N.Z.

■ **Standby/on switch** (⏻/⏻)

Press to switch the unit from on to standby mode or vice versa. In standby mode, the unit is still consuming a small amount of power.

Standby/on indicator (⏻)

When the unit is connected to the AC mains supply, this indicator lights up in standby mode and goes out when the unit is turned on.

Changer functions

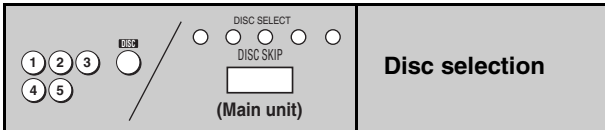

Selecting the disc directly

Press **Disc select** buttons.

Selecting the disc from the Disc information menu

1 Press **[DISC]** to show the Disc information menu.

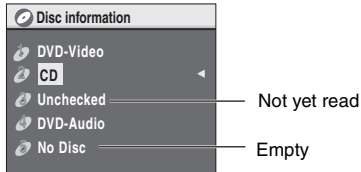

2 Press the numbered buttons (**[DISC1]** – **[DISC5]**).

To clear the screen

Press **[DISC]**.

Skipping to the next disc tray

While the drawer is closed

Press **[DISC SKIP]**.

Each time you press the button, the carousel moves clockwise by one tray.

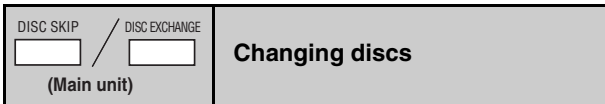

Changing the other discs without interrupting play

1 Press **[▲OPEN/CLOSE]** to open the drawer.

2 Press **[DISC SKIP]**.

The carousel moves one tray clockwise and each subsequent press moves it two trays in alternate directions.

Exchanging the discs in the play position

1 Press **[DISC EXCHANGE]**.

The drawer opens and the disc in the play position comes to the front-left position.

2 Change the disc in the front-left position.

3 Press **[DISC EXCHANGE]**.

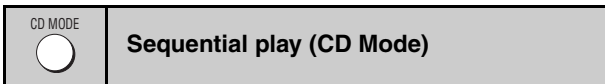

VCD **CD** **WMA** **MP3**

Press **[CD MODE]** to play all loaded discs (except for DVDs and JPEG files).

(CD Mode button on the main unit lights on.)

- HighMAT menus and Video CD playback control are disabled.
- You cannot change the mode during program or random play.
- CD Mode turns off when you switch the unit to standby.

Enjoying higher quality audio and video



By pressing just one button the disc type is automatically determined and the best audio and video settings are configured.

Press **[AV ENHANCER]** to select “On”.



When AV Enhancer is on, you cannot change the settings indicated below.

Audio settings:

Multi Re-master (→ below), Dolby Pro Logic II (→ below), Advanced Surround (→ page 11), Dialogue Enhancer (→ page 11)

Video settings:

Picture Mode (→ page 10)



RAM **DVD-V** (Discs recorded with 48 kHz only)

DVD-A (Discs recorded with 44.1 kHz and 48 kHz only)

VCD **CD**

- During 2ch output of these discs, this feature gives you a more natural sound by adding the higher frequency signals not recorded on the disc.
- During multi-channel output of these discs, this feature reproduces the frequencies lost during recording to give you a sound closer to the original.

WMA **MP3** (Disc recording is other than 8 kHz, 16 kHz, 32 kHz)

This feature reproduces the higher frequencies lost during recording to give you a sound closer to the original.

Press **[MULTI RE-MASTER]** to select “1” “2” or “3”.



Setting	DVD-A DVD-V CD (LPCM/PPCM) Type of music	Other discs Effect level
1	High tempo (e.g., pop and rock)	Light
2	Various tempos (e.g., jazz)	Medium
3	Low tempo (e.g., classical)	Strong
Off	Off	Off

- The actual output sampling frequency depends on “PCM Digital Output” setting in “Audio” tab (→ page 12).



Dolby Pro Logic II is an advanced decoder that derives 5 channel surround (Left and Right Front, Center, Left and Right Surround) from any stereo program material, whether or not it has been specifically Dolby Surround encoded.

Press **[DOLBY PRO LOGIC II]**.

Movie: Movie software, recorded in Dolby Surround.

Music: Stereo sources.

- This does not work when playing multi-channel audio.



You can enjoy higher quality audio by stopping the video output.

During play

Press **[AUDIO ONLY]**.

- **AUDIO ONLY** is canceled if you press **[AUDIO ONLY]** again or switch the unit to standby.

- There is output to the screen only when:
 - the disc is stopped.
 - performing operations such as searching.
 - on screen display is displayed.

The above indicated features may not work depending on the discs recording.

Using navigation menus

Playing data discs **WMA** **MP3** **JPEG** **CD** (CD-text only)

WMA **MP3** **JPEG**

You can play JPEG files on DVD-RAM or play HighMAT discs without using the HighMAT function (→ page 11, "Play as Data Disc" in Other Menu).

■ **Using playback menus** (except JPEG files on DVD-RAM)
While the menu is displayed
 Press [▲ ▼] to select "All", "Audio", or "Picture" and press [ENTER].

● **To display/exit the screen**
 Press [TOP MENU].

■ **Using navigation menus**

- 1 Press [MENU].
- 2 Press [▲ ▼ ◀ ▶] to select the group or audio/picture content and press [ENTER].

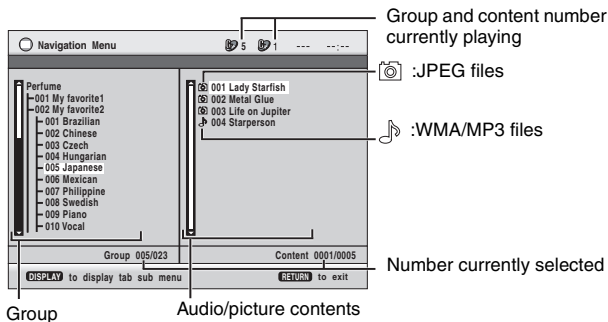

- **To enjoy listening to WMA/MP3 contents while showing a JPEG image on the screen**
 Select a JPEG file first, and then select tracks.
 (The opposite order is not effective.)
- **To exit the screen**
 Press [MENU].

To use the contents screen to find a track **CD** (CD-text only)

While the menu is displayed
 Press [▲ ▼] to move through the tracks and press [ENTER].

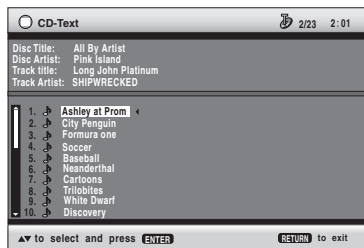

- Press [ANGLE/PAGE] to skip 10 lines at a time.

Tips for making WMA/MP3 and JPEG discs (For CD-R/CD-RW)

- Discs must conform to ISO9660 level 1 or 2 (except for extended formats).
- This unit is compatible with multi-session but if there are a lot of sessions it takes more time for play to start. Keep the number of sessions to a minimum to avoid this.

Naming folders and files

At the time of recording, prefix folder and file names with 3-digit numbers in the order you want to play them (this may not work at times).
 Files must have the extension:
 ".WMA" or ".wma"
 ".MP3" or ".mp3"
 ".JPG", ".jpg", ".JPEG" or ".jpeg"

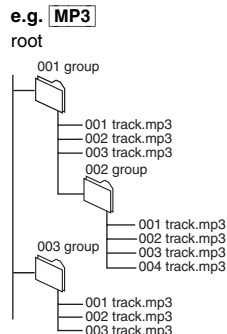

Using the submenu **WMA** **MP3** **JPEG**

- 1 While the menu is displayed, press [DISPLAY]

Multi	Groups and content
List	Contents only
Tree	Groups only
Thumbnail	Thumbnail images JPEG
Next group	To go to next groups WMA MP3
Previous group	To go to previous groups WMA MP3
All	WMA/MP3 and JPEG files
Audio	WMA/MP3 files only
Picture	JPEG files only
Help display	To switch between guide messages and the elapsed play time indicator
Find	To search by content or group title (→ see below)

- 2 Press [▲ ▼] to select the submenu and press [ENTER].

■ **Searching by content or group title** **WMA** **MP3** **JPEG**
 Place the cursor on the group title to search a group, or place the cursor on the content title to search contents.

- 1 Select "Find" (→ see above).



- 2 Press [▲ ▼] to select a character and press [ENTER].
 - Repeat to enter another characters.
 - Lower case is also searched.
 - Press [◀▶] to skip between A, E, I, O and U.
 - Press [←] to erase a character.
 - Erase the asterisk (*) to search for the titles starting with that character.
- 3 Press [▶] to select "Find" and press [ENTER].
 The search result screen appears.
- 4 Press [▲ ▼] to select the content or group and press [ENTER].

WMA

- You cannot play WMA files that are copy protected.

MP3

- This unit is not compatible with ID3 tags.
- Compatible sampling rate: 8, 11.02, 12, 16, 22.05, 24, 32, 44.1, and 48 kHz

JPEG

- To view JPEG files on this unit:
 - Take them on a digital camera that meets the DCF Standard (Design rule for Camera File system) Version 1.0. Some digital cameras have functions that are not supported by the DCF Standard Version 1.0 like automatic picture rotation which may render a picture unviewable.
 - Do not alter the files in any way or save them under a different name.
- This unit cannot display moving pictures, MOTION JPEG and other such formats, still pictures other than JPEG (e.g. TIFF) or play associated sound.

Changing the play sequences



While the menu is displayed
Select the item following the on-screen instructions.



Menu: Takes you to the next menu which shows play lists or another menu
Play list: play starts

To change the menu background

Press [DISPLAY].

The background changes to the one recorded on the disc.

To display/exit the screen

Press [TOP MENU].

Selecting from the list

- 1 Press [MENU].
- 2 Press [◀] then [▲ ▼] to switch among Playlist, Group and Content lists.
- 3 Press [▶] then [▲ ▼] to select an item and press [ENTER].

• Press [ANGLE/PAGE] to skip 10 lines at a time.

• To exit the screen
Press [MENU].

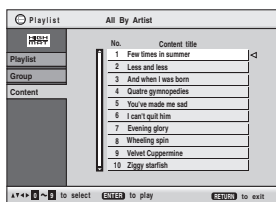

While stopped, press [PLAY MODE].

Each time you press the button:

Program → Random
← Off (Normal play) ←

- Disable HighMAT disc play to use random and program play. Select "Play as Data Disc" in Other Menu (→ page 11).

Program play (up to 32 items)

When CD Mode is on (→ page 7)

VCD CD WMA MP3

You can program all the items on all the discs.

When CD Mode is off (→ page 7)

DVD-A DVD-V VCD CD WMA MP3 JPEG

You can program all the items on a disc in the play position.

- 1 When CD Mode is on (→ page 7)
Press the numbered buttons to select a disc.
- 2 Press the numbered buttons to select the items (WMA MP3 JPEG) then press [ENTER].
Repeat this step to program other items.
- 3 Press [▶] (PLAY).

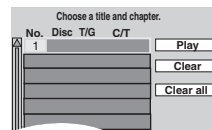

Selecting all the items on the disc or group (Except DVD-A DVD-V)

When CD Mode is off (→ page 7)

Press [ENTER] and [▲ ▼] to select "ALL", then press [ENTER] again to register.

Changing the program

Press [▲ ▼] to select an item.

-To change an item, repeat step 1 and 2.

-To clear an item, press [CANCEL] (or select "Clear" and press [ENTER]).

- Press [ANGLE/PAGE] to skip 8 lines at a time.

Clearing the whole program

Select "Clear all" and press [ENTER]. The whole program is also cleared when the disc is moved out of the play position while the CD Mode is off or the unit is turned off.

Random play

When CD Mode is on (→ page 7)

VCD CD WMA MP3

You can play all the items on all the discs in random order.

When CD Mode is off (→ page 7)

VCD CD

You can play all the items on a disc in the play position in random order.

DVD-A DVD-V WMA MP3 JPEG

You can play selected item(s) on a disc in the play position in random order.

- 1 (DVD-A DVD-V WMA MP3 JPEG)
Press the numbered buttons to select a group (WMA MP3 JPEG) then press [ENTER] or a title.
- 2 Press [▶] (PLAY).

e.g. DVD-V



To exit the program or random mode

Press [PLAY MODE] several times while stopped.

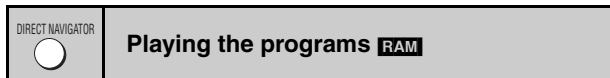

1 Press [DIRECT NAVIGATOR].

- Titles appear only if you have entered them.
- You cannot change program and disc titles.

2 Press [▲ ▼] or the numbered buttons to select the program.

• Press [ANGLE/PAGE] to skip 5 lines at a time.

• To select a 2-digit number
e.g. 23: [≥10] → [2] → [3]

• Press [▶] to show the contents of the program.

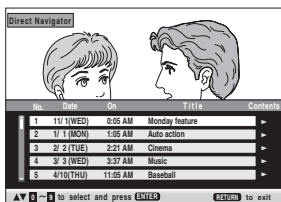

(Only when the disc contains a play list)

1 Press [PLAY LIST]. 2 Press [▲ ▼] or the numbered buttons to select the play list.

• Press [ANGLE/PAGE] to skip 10 lines at a time.

• To select a 2-digit number
e.g. 23: [≥10] → [2] → [3]

3 Press [ENTER].





(Only when the elapsed play time can be displayed)

JPEG: Works with all JPEG content.)

Press [REPEAT] several times to select an item to be repeated.

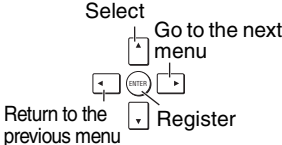

<p>1</p>  <p>Press once. [DVD-F87/DVD-F86] When pressed twice, the elapsed play time indicator appears. → page 11)</p>	<p>2</p>  <p>Select the menu.</p>	<p>3</p>  <p>Make the settings.</p>	<p>4</p>  <p>Press to exit.</p>
---	---	---	---

Items shown differ depending on the type of software.

Main menus

Program Group	To start from a specific item	Still Picture	To switch still picture
Title		Thumbnail	To show thumbnail images
Chapter		Subtitle	(→ page 14)
Track		Marker(VR)	To recall a marker recorded on DVD-Video recorders
Playlist		Angle	(→ page 14)
Content		Rotate Picture	
Time	To skip incrementally or decrementally (Time Slip for play only) 1. Press [ENTER] twice to show Time Slip indicator. 2. Press [▲ ▼] to enter the time and press [ENTER]. ● Press and hold [▲ ▼] to alter faster. To start from a specific time (Time Search) To change remaining/elapsed time display	Slideshow	To turn on/off slideshow To change the slideshow timing (0–30 sec)
Audio	(→ page 14) To display the current bitrate or sampling frequency		

Other settings

Play Speed	[RAM DVD-V] To change play speed –from ×0.6 to ×1.4 (in 0.1 units) ● After you change the speed –Digital output switches to PCM-2ch. –Sampling frequency of 96 kHz is converted to 48 kHz.
AV Enhancer	(→ page 7)

■ Play Menu

(Only when the elapsed play time can be displayed)

[JPEG]: Works with all JPEG content.)

Repeat	(→ page 9)
Except [JPEG] [RAM] (still picture part) A-B Repeat	To repeat a specified section Press [ENTER] at the starting and ending points. Press [ENTER] again to cancel.
Marker	To mark up to 5 positions to play again [ENTER] (The unit is now ready to accept markers.) To mark a position: [ENTER] (at the desired point) To mark another position: [◀ ▶] → [ENTER] To recall a marker: [◀ ▶] → [ENTER] To erase a marker: [◀ ▶] → [CANCEL] ● This feature doesn't work during program and random play.

■ Picture Menu

Picture Mode	Normal Cinema1 : Mellows images and enhances detail in dark scenes. Cinema2 : Sharpens images and enhances detail in dark scenes. Animation Dynamic User (Press [ENTER] to select "Picture Adjustment") (→ below) Picture Adjustment Contrast Brightness Sharpness Color Gamma (Adjusts the brightness of dark parts.) Depth Enhancer ● Reduce the rough noise in the background to give a greater feeling of depth.
Video Output Mode	480I (Interlace) ↔ 480P (Progressive)
Transfer Mode	If you have chosen "480P" (→ above), select the method of conversion for progressive output to suit the type of material. Auto 1 (normal): For viewing film material Auto 2 : For viewing film material (the same as Auto 1, but able to convert 30-frame-per-second progressive video) Video : For video material

■ Audio Menu

Dolby Pro Logic II	(→ page 7)
Advanced Surround	<p>RAM DVD-V VCD (2 or more channels) SP (Speaker) 1 Natural SP 2 Enhanced HP (Headphone) 1 Natural HP 2 Enhanced Off</p> <ul style="list-style-type: none"> When using discs recorded with surround sound, sound seems to come from speakers on either side of you. When using headphones from the connected equipment, select "HP 1" or "HP 2" Optimum seating position is 3 to 4 times the distance between the front left and right speakers or the width of the television if using the television's speakers. Do not use in combination with surround effects on other equipment.
Dialogue Enhancer	<p>To make the dialogue in movies easier to hear DVD-V (Dolby Digital, DTS, MPEG, 3-channel or over, with the dialogue recorded in the center channel) On ↔ Off</p>
Multi Re-master	(→ page 7)
Attenuator	<p>Switch on if sound is distorted. (For 2 ch or 5.1 ch AUDIO OUT connections) On ↔ Off</p>

■ Display Menu

Information	On ↔ Off (JPEG) : Off , Date , Details)
Subtitle Position	0 to -60 (in 2 units)
Subtitle Brightness	Auto, 0 to -7
4:3 Aspect	<p>To select how to show images made for 4:3 aspect screens on a 16:9 aspect television.</p> <p>Normal: Laterally stretches images.</p> <p>Auto: Expands 4:3 letterbox images to fill more of the screen. Other images appear in full in the center of the screen.</p> <p>Shrink: Images appear in the center of the screen.</p> <p>Zoom: Expands all images to fill the screen.</p> <p>If your television has a similar feature, use it instead for a better effect.</p>
Just Fit Zoom	(→ page 14)
Manual Zoom	(→ page 14)
Bitrate Display	RAM DVD-V VCD On ↔ Off
GUI See-through	On ↔ Off
GUI Brightness	-3 to +3

■ Other Menu

Sleep	(→ page 14)
Play as DVD-Video or Play as DVD-Audio	<p>While stopped</p> <ul style="list-style-type: none"> Select "Play as DVD-Video" to play DVD-Video contents on DVD-Audio.
Play as DVD-VR Play as HighMAT or Play as Data Disc	<p>While stopped</p> <ul style="list-style-type: none"> Select "Play as Data Disc" to play JPEG files on DVD-RAM or to play HighMAT disc without using the HighMAT function.

DVD-F87/DVD-F86

■ Elapsed play time indicator

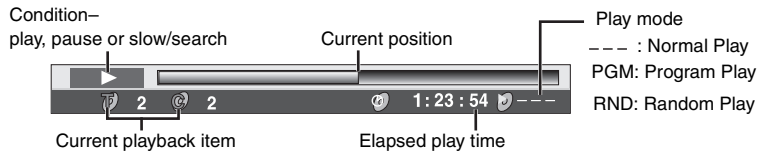

Changing the player settings

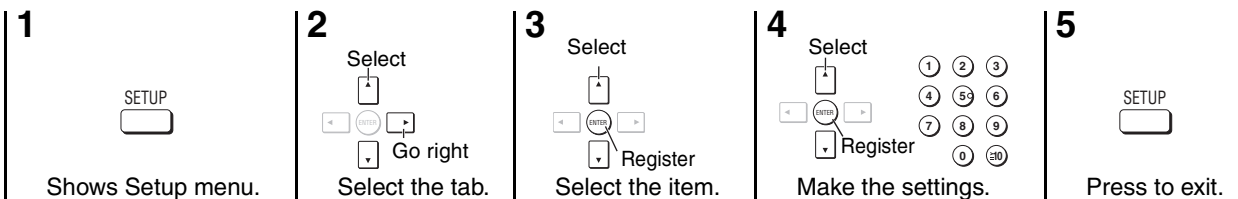

• The settings remain intact even if you switch the unit to standby.
 • Underlined items are the factory preset.

The QUICK SETUP enables successive settings of the items in the shaded area.

■ “Disc” tab

Audio Choose the audio language.	<ul style="list-style-type: none"> • <u>English</u> • (Language options)*¹ • Original*² • Other* * * * *
Subtitle Choose the subtitle language.	<ul style="list-style-type: none"> • <u>Automatic</u>*⁴ • English • (Language options)*¹ • Other* * * * *
Menus Choose the language for disc menus.	<ul style="list-style-type: none"> • <u>English</u> • (Language options)*¹ • Other* * * * *
Ratings Set a ratings level to limit DVD-Video play. • Follow the on-screen instructions.	Setting ratings (When level 8 is selected) <ul style="list-style-type: none"> • <u>8 No Limit</u> • 1 to 7 • 0 Lock All: To prevent play of discs without ratings levels. Changing ratings (When level 0-7 is selected) <ul style="list-style-type: none"> • <u>Unlock Player</u> • Change Password • Change Level • Temporary Unlock.

■ “Video” tab

TV Aspect Choose the setting to suit your television and preference.	<ul style="list-style-type: none"> • <u>4:3 Pan&Scan</u>: Regular aspect television (4:3) The sides of the widescreen picture are cut off so it fills the screen (unless prohibited by the disc). • 4:3 Letterbox: Regular aspect television (4:3) Widescreen picture is shown in the letterbox style. 	
DVD-F87 only Progressive Out (Component)	<ul style="list-style-type: none"> • <u>Disable</u>: Interlace output • <u>Enable</u>*⁵ or • <u>Enable</u>*⁶*⁷ (NTSC Disc Only): Progressive output 	
TV Type Select to suit the type of television.	<ul style="list-style-type: none"> • <u>Standard (Direct View TV)</u> • CRT Projector • LCD TV/Projector • Projection TV • Plasma TV 	
Time Delay When connected with an AV amplifier and Plasma display, adjust if you notice the audio is out of sync with the video.	<ul style="list-style-type: none"> • <u>0 ms</u> • 20 ms • 40 ms • 60 ms • 80 ms • 100 ms 	
Still Mode Specify the type of picture shown when paused.	<ul style="list-style-type: none"> • <u>Automatic</u> • <u>Field</u>: The picture is not blurred, but picture quality is lower. • <u>Frame</u>: Overall quality is high, but the picture may appear blurred. 	
Black Level Control * ⁵ Change the black level of the picture if you connected a television through the COMPONENT VIDEO OUT terminals.	<ul style="list-style-type: none"> • <u>Lighter</u>: When connected through VIDEO OUT or S VIDEO OUT. • <u>Darker</u>: When connected through COMPONENT VIDEO OUT. 	
NTSC Disc Output * ⁶ * ⁷ Choose PAL 60 or NTSC output when playing NTSC discs.	<ul style="list-style-type: none"> • <u>PAL60</u>: When connected to a PAL television • <u>NTSC</u>: When connected to an NTSC television (Asia: “NTSC” is the factory preset.) 	

■ “Audio” tab

PCM Digital Output Check the digital input limitations of the equipment you connect using COAXIAL terminal and select the maximum sampling frequency of PCM digital output.	Off : When not connected digitally Up to 48 kHz : When connected to equipment compatible with 44.1 or 48 kHz Up to 96 kHz : When connected to equipment compatible with 88.2 or 96 kHz Up to 192 kHz : When connected to equipment compatible with 176.4 or 192 kHz • Signals that exceed the set maximum frequency and signals from copy-protected discs are converted to 48 or 44.1 kHz. • Some equipment cannot handle sampling frequencies of 88.2 kHz, even if they can handle 96 kHz. Read your equipment’s operating instructions for details.	
Dolby Digital	<ul style="list-style-type: none"> • <u>Bitstream</u> • PCM 	Select “ Bitstream ” when the equipment can decode the bitstream (digital form of multi-channel data). Otherwise, select “ PCM ”. • If the bitstream is output to the equipment without a decoder, high levels of noise can be output and may damage your speakers and hearing.
DTS Digital Surround	<ul style="list-style-type: none"> • <u>PCM</u> • Bitstream 	
MPEG * ⁷	<ul style="list-style-type: none"> • <u>PCM</u> • Bitstream 	
Dynamic Range Compression	<ul style="list-style-type: none"> • <u>Off</u> • <u>On</u>: Adjusts for clarity even when the volume is low through compressing the range of the lowest sound level and the highest sound level. Convenient for late night viewing. (Only works with Dolby Digital) 	
Audio during Search	<ul style="list-style-type: none"> • <u>On</u> • Off 	
DVD-F87 only Speaker Setting Choose the settings to suit your audio system and the listening environment (→ page 13, Changing the speaker setting to suit your speakers).	<ul style="list-style-type: none"> • <u>Multi-channel</u>: when 3 or more speakers are connected. • <u>2-channel</u>: when 2 speakers are connected. If you select Multi-channel <ul style="list-style-type: none"> • Speaker presence and size • Delay time • Channel balance 	

■ “Display” tab

Menu Language	<ul style="list-style-type: none"> *5 ● English ● Français ● Español *6 ● English ● 中文 *7 ● English ● Français ● Deutsch ● Italiano ● Español ● Português ● Svenska ● Nederlands
On-Screen Messages	<ul style="list-style-type: none"> ● On ● Off

■ “Others” tab

FL Dimmer Changes the brightness of the unit's display.	<ul style="list-style-type: none"> ● Bright ● Dim ● Auto: The display is dimmed during play, but brightens when you perform some operations.
Auto Power Off	<ul style="list-style-type: none"> ● On: The unit switches to standby mode after about 30 minutes in the stop mode, irrespective of the SLEEP setting. ● Off
HighMAT	<ul style="list-style-type: none"> ● Enable ● Disable (Unable to use the HighMAT function.)
QUICK SETUP	<ul style="list-style-type: none"> ● Yes ● No
Re-initialize Setting This returns all values in the Setup menus to the default settings.	<ul style="list-style-type: none"> ● Yes: The password screen is shown if “Ratings” (→ page 12) are set. Please enter the same password. After “INIT” on the display disappears, turn the unit off and on again. ● No

*1 Language options

U.S.A. and Canada : French and Spanish

Asia : Chinese

Australia and N.Z. :

French, German, Italian, Spanish, Portuguese, Swedish and Dutch

*2 The original language designed on the disc is selected.

*3 Input a code number referring to the table on page 15.

*4 If the language selected for “Audio” is not available, subtitle appear in that language (If available on the disc).

*5 **U.S.A. and Canada**

*6 **Asia**

*7 **Australia and N.Z.**

DVD-F87 only

Changing the speaker setting to suit your speakers

When you connect with AUDIO OUT 5.1 ch (→ page 4) and select “Multi-channel”(→ page 12, “Speaker Setting” in “Audio” tab)

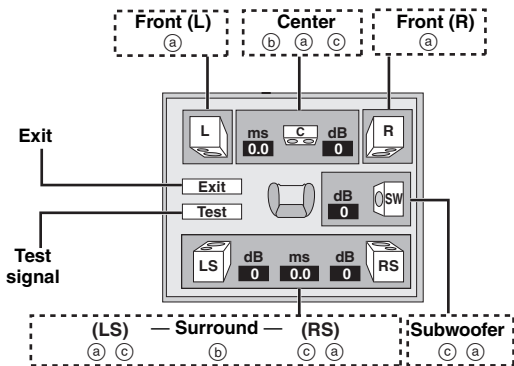

Speaker presence and size (a)

Icon examples:

Surround speaker (LS)



Large



Small



No

- **Large:** Select when the speaker supports low-frequency (under 100 Hz) reproduction.
- **Small:** Select when the speaker does not support low-frequency reproduction.

If the subwoofer is set to “No”, the front speakers will automatically be set to “Large”.

Delay time (b)

(Effective when playing multi-channel audio)

If either distance (d) or (f) is less than (e), find the difference in the relevant table and change to the recommended setting.

□ : Recommended placement

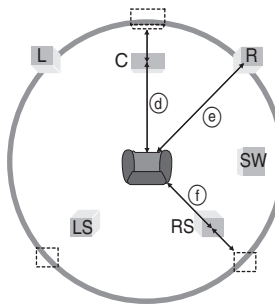

④ Center speaker

Difference	Setting
Approx. 34 cm (1 ¹ / ₁₀ feet)	1.0 ms
Approx. 68 cm (2 ¹ / ₂ feet)	2.0 ms
Approx. 102 cm (3 ³ / ₁₀ feet)	3.0 ms
Approx. 136 cm (4 ² / ₅ feet)	4.0 ms
Approx. 170 cm (5 ¹ / ₂ feet)	5.0 ms

⑤ Surround speakers

Difference	Setting
Approx. 170 cm (5 ¹ / ₂ feet)	5.0 ms
Approx. 340 cm (11 feet)	10.0 ms
Approx. 510 cm (16 ¹ / ₂ feet)	15.0 ms

Channel balance (c)

1. Select “Test” and press [ENTER].

A test signal is output.

Front (L) → Center → Front (R)

↑ Surround (LS) ← Surround (RS)

2. While listening to the test signal, press [▲ ▼] to adjust the volume of the center and surround speakers so they are the same apparent volume as the front speakers (−6 to +6). (The front speakers cannot be adjusted here.)
3. Press [ENTER].
The test signal stops.
 - No signal is output for the subwoofer. To adjust its volume, play something, then return to this screen to adjust to suit your taste.

To finish the speaker setting

Press [▲ ▼ ◀ ▶] to select “Exit” and press [ENTER].

Convenient functions

ZOOM

RAM DVD-V VCD

This feature expands the letterbox picture to fit the screen.

Press [ZOOM] several times to select the preset aspect ratio or "Auto". (Just Fit Zoom)

Fine adjustments (Manual Zoom)

Press [◀ ▶].

–from ×1.00 to ×1.60 (in 0.01 units)

–from ×1.60 to ×2.00 (in 0.02 units)



QUICK REPLAY

Except JPEG

(Only when the elapsed play time can be displayed)

Press [QUICK REPLAY] to skip back a few seconds.

POSITION MEMORY

(Only when the elapsed play time can be displayed)

JPEG: Works with all JPEG content.)

This position is memorized even after turning off the unit or moving the disc out of the play position.

Press [POSITION MEMORY].



- Up to 5 discs.
- When the sixth disc is memorized, the earliest position is replaced.
- You cannot recall the position in CD Mode (→ page 7).

When the unit is turned on or the disc comes to the play position, "▷" flashes on the display.

Press [▶] (PLAY) to start play from that position.

To review the previous chapters DVD-V

Press [▶] (PLAY) while the following message is displayed.

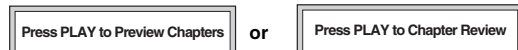

Do not press [▶] (PLAY) if you want to cancel review.

AUDIO

DVD-A DVD-V (with multiple soundtracks) RAM VCD

Press [AUDIO] several times to select the soundtrack.

RAM VCD

You can use this button to select "L", "R" or "LR".

DVD-V (Karaoke discs)

Press [◀ ▶] to select "On" or "Off" of vocals.

Read the discs instructions for details.



Signal type/data

LPCM/PPCM/Digital/DTS/MPEG: Signal type
kHz (Sampling frequency)/bit/ch (Number of channels)
Example: 3/2, 1ch

- 1: Low frequency effect
(not displayed if there is no signal)
- 0: No surround
- 1: Mono surround
- 2: Stereo surround (left/right)
- 1: Center
- 2: Front left+ Front right
- 3: Front left+ Front right+ Center

SUBTITLE

DVD-V (with multiple subtitles) VCD (SVCD only)

RAM (On/Off only)

Press [SUBTITLE] several times to select the subtitle language.

To clear/display the subtitles

Press [◀ ▶] to select "On" or "Off".



GROUP

DVD-A WMA MP3 JPEG

A folder on WMA/MP3 and JPEG discs is treated as a "Group".

- 1 Press [GROUP].
- 2 Press [▲ ▼] to select the item and press [ENTER].



ANGLE/PAGE

Press [ANGLE/PAGE] several times to select the angle or rotate/advance the still picture.

DVD-V (with multiple angles)–Angle select

DVD-A –Still picture advance

JPEG –Still picture rotation

SLEEP

Press [SLEEP] to select the time to turn off (60 min, 90 min, 120 min) or "Auto".

Auto:

–Turns the unit off 5 minutes after play finishes.

–Also works with DVDs that show a menu after play finishes.

–Does not work if you stop play or show a disc menu. It is activated again when you restart play.

To confirm the remaining time

Press [SLEEP] again.



Specifications

Signal system:

U.S.A. and Canada NTSC
Others PAL 625/50, PAL525/60, NTSC

Operating temperature range: +5 to +35 °C (+41 to +95 °F)
Operating humidity range: 5 to 90 % RH (no condensation)

Discs played [8 cm (3 ") or 12 cm (5 ")]:

- (1) DVD-RAM (DVD-VR compatible, JPEG formatted discs)
- (2) DVD-Video
- (3) DVD-Audio (4) DVD-R (DVD-Video compatible)
- (5) CD-Audio (CD-DA) (6) Video CD
- (7) SVCD (Conforming to IEC62107)
- (8) CD-R/CD-RW (CD-DA, Video-CD, SVCD, MP3, WMA, JPEG formatted discs)
- (9) MP3/WMA*1
 - Compatible compression rate:
 - MP3: between 32 kbps and 320 kbps
 - WMA: between 48 kbps and 320 kbps
- (10) JPEG*1
 - Exif Ver 2.1 JPEG Baseline files
 - Picture resolution: between 320×240 and 6144×4096 pixels (Sub sampling is 4:2:2 or 4:2:0)
- (11) HighMAT Level 2 (Audio and Image)

Video output:

Output level: 1 Vp-p (75 Ω)
 Output connector: Pin jack (1 system)

S-video output:

Y output level: 1 Vp-p (75 Ω)
 C output level:

U.S.A. and Canada NTSC; 0.286 Vp-p (75 Ω)
Others NTSC; 0.286 Vp-p (75 Ω)
 PAL; 0.300 Vp-p (75 Ω)
 S terminal (1 system)

Output connector:

Component video output:

U.S.A. and Canada (NTSC: 480P/480I)
Others (NTSC: 480P/480I, PAL: 576I)
 Y output level: 1 Vp-p (75 Ω)
 P_B output level: 0.7 Vp-p (75 Ω)
 P_R output level: 0.7 Vp-p (75 Ω)
 Output connector: Pin jack (Y: green, P_B: blue, P_R: red)
 Number of connectors: 1 system

Audio output:

Output level: 2 Vrms (1 kHz, 0 dB)
 Output connector: Pin jack
 Number of connectors:
DVD-F87 5.1-channel discrete output (5.1 channel): 1 system
DVD-F86/DVD-F84 2 channel: 1 system

Audio performance:

- (1) Frequency response:
 - DVD (linear audio): 4 Hz–22 kHz (48 kHz sampling)
 - 4 Hz–44 kHz (96 kHz sampling)
 - DVD-Audio: 4 Hz–88 kHz (192 kHz sampling)
 - CD Audio: 4 Hz–20 kHz
- (2) S/N ratio:
 - CD Audio: 115 dB
- (3) Dynamic range:
 - DVD (linear audio): 100 dB
 - CD Audio: 98 dB
- (4) Total harmonic distortion:
 - CD Audio: 0.0025 %

Digital audio output:

Coaxial digital output: Pin jack

Pickup:

Wave length: 662 nm/785 nm
 Laser power:

U.S.A. CLASS IIa/CLASS I
Others CLASS 2/CLASS 3A

Power supply:

U.S.A. and Canada AC 120 V, 60 Hz
Australia and N.Z. AC 220–240 V, 50 Hz
Asia AC 220–240 V, 50/60 Hz

Power consumption:

10 W

Power consumption in standby mode:

approx. 0.7 W

Dimensions:

430 (W)×412.9 (D)×68 (H) mm
 [16 ¹⁵/₁₆" (W)×16 ¹/₄" (D)×2 ¹¹/₁₆" (H)]

Mass:

approx. 4.0 kg (8.9 lb.)

Note

Specifications are subject to change without notice. Mass and dimensions are approximate.

*1The total combined maximum number of recognizable audio and picture contents and groups: 4000 audio and picture contents and 400 groups.

Maintenance

Clean this unit with a soft, dry cloth.

- Never use alcohol, paint thinner or benzine to clean this unit.
- Before using chemically treated cloth, read the instructions that came with the cloth carefully.

Language code list

Abkhazian: 6566	Chinese: 9072	Hausa: 7265	Lithuanian: 7684	Romanian: 8279	Telugu: 8469
Afar: 6565	Corsican: 6779	Hebrew: 7387	Macedonian: 7775	Russian: 8285	Thai: 8472
Afrikaans: 6570	Croatian: 7282	Hindi: 7273	Malagasy: 7771	Samoan: 8377	Tibetan: 6679
Albanian: 8381	Czech: 6783	Hungarian: 7285	Malay: 7783	Sanskrit: 8365	Tigrinya: 8473
Ameharic: 6577	Danish: 6865	Icelandic: 7383	Malayalam: 7776	Scots Gaelic: 7168	Tonga: 8479
Arabic: 6582	Dutch: 7876	Indonesian: 7378	Maltese: 7784	Serbian: 8382	Turkish: 8482
Armenian: 7289	English: 6978	Interlingua: 7365	Maori: 7773	Serbo-Croatian: 8372	Turkmen: 8475
Assamese: 6583	Esperanto: 6979	Irish: 7165	Marathi: 7782	Shona: 8378	Twi: 8487
Aymara: 6588	Estonian: 6984	Italian: 7384	Moldavian: 7779	Sindhi: 8368	Ukrainian: 8575
Azerbaijani: 6590	Faroese: 7079	Japanese: 7465	Mongolian: 7778	Singhalese: 8378	Urdu: 8582
Bashkir: 6665	Fiji: 7074	Javanese: 7487	Nauru: 7865	Slovak: 8375	Uzbek: 8590
Basque: 6985	Finnish: 7073	Kannada: 7578	Nepali: 7869	Slovenian: 8376	Vietnamese: 8673
Bengali; Bangla: 6678	French: 7082	Kashmiri: 7583	Norwegian: 7879	Somali: 8379	Volapük: 8679
Bhutani: 6890	Frisian: 7089	Kazakh: 7575	Oriya: 7982	Spanish: 6983	Welsh: 6789
Bihari: 6672	Galician: 7176	Kirghiz: 7589	Pashto, Pushto: 8083	Sundanese: 8385	Wolof: 8779
Breton: 6682	Georgian: 7565	Korean: 7579	Persian: 7065	Swahili: 8387	Xhosa: 8872
Bulgarian: 6671	German: 6869	Kurdish: 7585	Polish: 8076	Swedish: 8386	Yiddish: 7473
Burmese: 7789	Greek: 6976	Laotian: 7679	Portuguese: 8084	Tagalog: 8476	Yoruba: 8979
Byelorussian: 6669	Greenlandic: 7576	Latin: 7665	Punjabi: 8065	Tajik: 8471	Zulu: 9085
Cambodian: 7577	Guarani: 7178	Latvian, Lettish: 7686	Quechua: 8185	Tamil: 8465	
Catalan: 6765	Gujarati: 7185	Lingala: 7678	Rhaeto-Romance: 8277	Tatar: 8484	

Troubleshooting guide

Before requesting service, make the following checks. If you are in doubt about some of the check points, or if the remedies indicated in the chart do not solve the problem, see "Product information" on page 17 for assistance.

Power

		Page
No power.	<ul style="list-style-type: none"> Insert the AC power supply cord securely into the household AC outlet. 	4
The unit is automatically switched to the standby mode.	<ul style="list-style-type: none"> When "Auto Power Off" is set to "On", the unit automatically switches to standby after approximately 30 minutes in the stop mode. The Sleep timer functioned. 	13 14

No operation

No response when any buttons pressed.	<ul style="list-style-type: none"> This unit cannot play discs other than the ones listed in these operating instructions. The unit may not be operating properly due to lightning, static electricity or some other external factor. Turn the unit off and then back to ON. Alternatively, turn the unit off, disconnect the AC power supply cord, and then reconnect it. Condensation has formed: Wait 1 to 2 hours for it to evaporate. 	3 — —
No response when remote control buttons pressed.	<ul style="list-style-type: none"> Check that the batteries are installed correctly. The batteries are depleted: Replace them with new ones. Point the remote control at the remote control sensor and operate. 	5 5 6
No picture or sound.	<ul style="list-style-type: none"> Check the video or audio connection. Check the power or input setting of the connected equipment. Check that the DVD-RAM has something recorded on it. 	4 — —
You have forgotten your ratings password. Reset all the settings to Factory Preset.	<ul style="list-style-type: none"> While stopped, press and hold [◀◀/▶▶] and [■] on the unit and then also press and hold [▲] on the unit until "Initialized" disappears from the television. Turn the unit off and on again. All settings will return to the default values. 	—

Specific operation impossible or incorrect

It takes time before play starts. MP3	<ul style="list-style-type: none"> Play may take time to begin when an MP3 track has still picture data. Even after the track starts, the correct play time will not be displayed, however this is normal. 	—
Programmed items are not played. DVD-V	<ul style="list-style-type: none"> Some items cannot be played even if you have programmed them. 	—
A menu screen appears during skip or search. VCD	<ul style="list-style-type: none"> This is normal for Video CDs. 	—
The on-screen menu shows "2" as a soundtrack option when [AUDIO] is pressed, but the audio does not change. DVD-A	<ul style="list-style-type: none"> Even if a second soundtrack isn't recorded, two numbers will normally be shown. 	—
Play restarts from the beginning of the track when soundtrack is changed. DVD-A	<ul style="list-style-type: none"> This is normal on DVD-Audio. 	—

Subtitle

Subtitle position is wrong.	<ul style="list-style-type: none"> Adjust the position. ("Subtitle Position" in Display Menu) 	11
No subtitles.	<ul style="list-style-type: none"> Display the subtitles. 	14
The subtitles overlap closed captions recorded on discs.	<ul style="list-style-type: none"> Clear the subtitles. 	14

A-B repeat

Point B is automatically set.	<ul style="list-style-type: none"> The end of an item becomes point B when it is reached. 	—
A-B repeat is automatically canceled.	<ul style="list-style-type: none"> A-B repeat is canceled when you press [QUICK REPLAY]. 	—

Picture incorrect

Picture distorted.	<ul style="list-style-type: none"> Ensure that the unit is connected directly to the television, and is not connected through a video cassette recorder. 	4
Picture size doesn't fit the screen.	<ul style="list-style-type: none"> Change "TV Aspect" in "Video" tab. Use the television to change the aspect. If your television does not have that function, change "4:3 Aspect" in Display Menu. Change the Zoom setting. 	12 11 14
The television may display incorrectly or colors appear faded.	<ul style="list-style-type: none"> The unit and television are using different video systems. U.S.A., Canada and Asia Use a multi-system or NTSC television. Australia and N.Z. Use a multi-system or PAL television. The system used on the disc doesn't match your television. U.S.A. and Canada —PAL discs cannot be played. —This unit converts DVD-Audio recorded in PAL to NTSC for play, however, play may not function properly. Asia, Australia and N.Z. —PAL discs cannot be correctly viewed on an NTSC television. —This unit can convert NTSC signals to PAL 60 for viewing on a PAL television ("NTSC Disc Output" in "Video" tab). This may happen when turning AUDIO ONLY on or off, but this is normal. 	— — — — 12 7
Menu not displayed correctly.	<ul style="list-style-type: none"> Restore the zoom ratio to × 1.00. Set "Subtitle Position" in Display Menu to "0". Set "4:3 Aspect" in Display Menu to "Normal". 	14 11 11
Auto zoom function does not work well.	<ul style="list-style-type: none"> Turn off TV's zoom function. Use the other preset aspect ratios or manual adjustment. Zoom function may not work well, especially in dark scenes and may not work depending on the type of disc. 	— 14 —

Progressive video

Page

There is ghosting when progressive output is on.	<ul style="list-style-type: none"> Change "Video Output Mode" in Picture Menu to "480i". This problem is caused by the editing method or material used on DVD-Video, but should be corrected if you use interlace output. 	10
Pictures not in progressive output.	<ul style="list-style-type: none"> If the unit is connected to the television through VIDEO OUT or S VIDEO OUT, output will be interlace. DVD-F87 Select "Enable" in "Progressive Out (Component)" in "Video" tab. Then, select "480P" in "Video Output Mode" in Picture Menu. DVD-F86/DVD-F84 Press [PROGRESSIVE OUT] on the main unit. Then, select "480P" in "Video Output Mode" in Picture Menu. 	– 12, 10
Closed captions not displayed.	<ul style="list-style-type: none"> When progressive output is on, closed captions will not be displayed. 	10 –

Sound incorrect

Sound distorted.	<ul style="list-style-type: none"> Select "Off" in "Advanced Surround" in Audio Menu. 	11
	<ul style="list-style-type: none"> Select "On" in "Attenuator" in Audio Menu if it causes distortion with 2 ch or 5.1ch AUDIO OUT connections. Noise may occur when playing WMA files. If the "D.MIX" indicator on the display goes out while playing a multi-channel DVD-Audio disc, sound will only be output from speakers specified by the disc. Read the disc's instructions for details. 	11 – –
	<ul style="list-style-type: none"> If you have connected a digital amplifier which does not include decoder, be sure to select "PCM" in "Dolby Digital", "DTS Digital Surround" or "MPEG*" in "Audio" tab. 	12
Piercing noise comes from the speakers.	<ul style="list-style-type: none"> If you have connected a digital amplifier which does not include decoder, be sure to select "PCM" in "Dolby Digital", "DTS Digital Surround" or "MPEG*" in "Audio" tab. 	12
Effects do not work.	<ul style="list-style-type: none"> None of the audio effects work when the unit is outputting bitstream signals from the DIGITAL AUDIO OUT terminal. In this case, connect with the AUDIO OUT terminal. 	4
	<ul style="list-style-type: none"> Some audio effects do not work or have less effect with some discs. 	–
	<ul style="list-style-type: none"> Multi Re-master, Advanced surround and Dolby Pro Logic II do not work if you have changed the play speed. 	–

Recording

Cannot record to digital recording equipment. (Incorrect sound recorded.)	<ul style="list-style-type: none"> You cannot record WMA/MP3. 	–
	<ul style="list-style-type: none"> You cannot record DVDs that have protection preventing digital recording. 	–
	<ul style="list-style-type: none"> You cannot record DVDs if the recording equipment cannot handle signals with a sampling frequency of 48 kHz. 	–
	<ul style="list-style-type: none"> Make the following settings: <ul style="list-style-type: none"> Advanced Surround: Off PCM Digital Output: Up to 48 kHz Dolby Digital/DTS Digital Surround/MPEG*: PCM 	11
		12
	12	

Unit displays

"NOPLAY"	<ul style="list-style-type: none"> You inserted a disc the unit cannot play; insert one it can. You inserted a blank disc. 	3 –
"U11"	<ul style="list-style-type: none"> Disc is dirty: Wipe it clean. 	5
"U15"	<ul style="list-style-type: none"> You inserted a DVD-R that has not been finalized. 	3
"H□□" □□ stands for a number.	<ul style="list-style-type: none"> Trouble may have occurred. The number following "H" depends on the status of the unit. Turn the unit off and then back to ON. Alternatively, turn the unit off, disconnect the AC power supply cord, and then reconnect it. If the service numbers fail to clear, note the service number and contact a qualified service person. 	– –
"NODISC"	<ul style="list-style-type: none"> You haven't inserted a disc: Insert one. You haven't inserted the disc correctly: Insert it correctly. 	– 6

Television displays

"Ⓢ"	<ul style="list-style-type: none"> The operation is prohibited by the unit or disc. 	–
"Cannot display group xx, content xx"	<ul style="list-style-type: none"> You are trying to display incompatible contents. 	8
DVD-F87 "The progressive out is set to "Disable""	<ul style="list-style-type: none"> Select "Enable" in "Progressive Out (Component)" in "Video" tab. 	12
"This disc may not be played in your region"	<ul style="list-style-type: none"> You can only play DVD-Video if their region number is the same or includes the same region number as the unit or if the DVD-Video is marked "ALL". Confirm the region number for the unit on the rear panel. 	Cover
No on-screen display.	<ul style="list-style-type: none"> Select "On" in "On-Screen Messages" in "Display" tab. 	13

*MPEG: **Australia and N.Z.**

Product Service

- Damage requiring service**—The unit should be serviced by qualified service personnel if:
 - The AC power supply cord or AC adaptor has been damaged; or
 - Objects or liquids have gotten into the unit; or
 - The unit has been exposed to rain; or
 - The unit does not operate normally or exhibits a marked change in performance; or
 - The unit has been dropped or the cabinet damaged.
- Servicing**—Do not attempt to service the unit beyond that described in these operating instructions. Refer all other servicing to authorized servicing personnel.
- Replacement parts**—When parts need replacing ensure the servicer uses parts specified by the manufacturer or parts that have the same characteristics as the original parts. Unauthorized substitutes may result in fire, electric shock, or other hazards.

- Safety check**—After repairs or service, ask the servicer to perform safety checks to confirm that the unit is in proper working condition.

Product information

For product information or assistance with product operation:

In the U.S.A., contact the Panasonic Customer Call Center at 1-800-211-7262, or the website <http://www.panasonic.com/contactinfo>, or the website (<http://www.panasonic.com/support>).

In Canada, contact the Panasonic Canada Inc. Customer Care Centre at 1-800-561-5505, or visit the website (www.panasonic.ca), or an authorized Servicecentre closest to you.

In other areas, consult your dealer.

Download from [Www.Somanuals.com](http://www.Somanuals.com). All Manuals Search And Download.

Limited Warranty (ONLY FOR U.S.A.)

Panasonic Consumer Electronics Company,
Division of Matsushita Electric Corporation of America
One Panasonic Way Secaucus, New Jersey 07094

Panasonic Sales Company, Division of Matsushita Electric
of Puerto Rico, Inc.,
Ave. 65 de Infantería, Km. 9.5
San Gabriel Industrial Park, Carolina, Puerto Rico 00985

Panasonic DVD Player Limited Warranty

Limited Warranty Coverage

If your product does not work properly because of a defect in materials or workmanship, Panasonic Consumer Electronics Company or Panasonic Sales Company (collectively referred to as "the warrantor") will, for the length of the period indicated on the chart below, which starts with the date of original purchase ("Limited Warranty period"), at its option either (a) repair your product with new or refurbished parts, or (b) replace it with a new or a refurbished product. The decision to repair or replace will be made by the warrantor.

Product or Part Name	Parts	Labor
DVD Player	One (1) Year	Ninety (90) Days
Rechargeable Batteries (in exchange for defective item)	Ten (10) Days	Not Applicable

During the "Labor" Limited Warranty period there will be no charge for labor. During the "Parts" warranty period, there will be no charge for parts. You must mail-in your product during the warranty period. If non-rechargeable batteries are included, they are not warranted. This Limited Warranty only applies to products purchased and serviced in the United States or Puerto Rico. This Limited Warranty is extended only to the original purchaser and only covers product purchased as new. A purchase receipt or other proof of original purchase date is required for Limited Warranty service.

Mail-In Service

For assistance in the continental U.S.A. in obtaining repairs please ship the product to:

**Panasonic Services Company
Customer Servicer
Suite B
4900 George McVay Drive
McAllen, TX 78503**

For assistance in Puerto Rico call Panasonic Sales Company (787)-750-4300 or fax (787)-768-2910.

When shipping the unit carefully pack and send it prepaid, adequately insured and preferably in the original carton. Include a letter detailing the complaint and provide a day time phone and/or email address where you can be reached.

IF REPAIR IS NEEDED DURING THE LIMITED WARRANTY PERIOD THE PURCHASER WILL BE REQUIRED TO FURNISH A SALES RECEIPT/PROOF OF PURCHASE INDICATING DATE OF PURCHASE, AMOUNT PAID AND PLACE OF PURCHASE. CUSTOMER WILL BE CHARGED FOR THE REPAIR OF ANY UNIT RECEIVED WITHOUT SUCH PROOF OF PURCHASE.

Limited Warranty Limits And Exclusions

This Limited Warranty ONLY COVERS failures due to defects in materials or workmanship, and DOES NOT COVER normal wear and tear or cosmetic damage. The Limited Warranty ALSO DOES NOT COVER damages which occurred in shipment, or failures which are caused by products not supplied by the warrantor, or failures which result from accidents, misuse, abuse, neglect, mishandling, misapplication, alteration, faulty installation, set-up adjustments, misadjustment of consumer controls, improper maintenance, power line surge, lightning damage, modification, or commercial use (such as hotel, office, restaurant, or other business), rental use of the product, or service by anyone other than a Factory Servicer or other Authorized Servicer, or damage that is attributable to acts of God.

THERE ARE NO EXPRESS WARRANTIES EXCEPT AS LISTED UNDER "LIMITED WARRANTY COVERAGE". THE WARRANTOR IS NOT LIABLE FOR INCIDENTAL OR CONSEQUENTIAL DAMAGES RESULTING FROM THE USE OF THIS PRODUCT, OR ARISING OUT OF ANY BREACH OF THIS WARRANTY. (As examples, this excludes damages for lost time, cost of having someone remove or re-install an installed unit if applicable, travel to and from the servicer, loss of or damage to media or images, data or other recorded content. The items listed are not exclusive, but are for illustration only.) **ALL EXPRESS AND IMPLIED WARRANTIES, INCLUDING THE WARRANTY OF MERCHANTABILITY, ARE LIMITED TO THE PERIOD OF THE LIMITED WARRANTY.**

Some states do not allow the exclusion or limitation of incidental or consequential damages, or limitations on how long an implied Limited Warranty lasts, so the exclusions may not apply to you.

This Limited Warranty gives you specific legal rights and you may also have other rights which vary from state to state. If a problem with this product develops during or after the Limited Warranty period, you may contact your dealer or Servicer. If the problem is not handled to your satisfaction, then write to the warrantor's Consumer Affairs Department at the addresses listed for the warrantor.

PARTS AND SERVICE, WHICH ARE NOT COVERED BY THIS LIMITED WARRANTY, ARE YOUR RESPONSIBILITY.

Customer Services Directory

Obtain Product Information and Operating Assistance; locate your nearest Dealer or Servicer; purchase Parts and Accessories; or make Customer Service and Literature requests by visiting our Web Site at:

<http://www.panasonic.com/support>

or, contact us via the web at:

<http://www.panasonic.com/contactinfo>

You may also contact us directly at:

1-800-211-PANA (7262),
Monday-Friday 9 am-9 pm; Saturday-Sunday 10 am-7 pm, EST.

For hearing or speech impaired TTY users, TTY: 1-877-833-8855

Accessory Purchases

Purchase Parts, Accessories and Instruction Books online for all Panasonic Products by visiting our Web Site at:

<http://www.pasc.panasonic.com>

or, send your request by E-mail to:

npcparts@panasonic.com

You may also contact us directly at:

1-800-332-5368 (Phone) 1-800-237-9080 (Fax Only) (Monday – Friday 9 am to 8 pm, EST.)

Panasonic Services Company

20421 84th Avenue South, Kent, WA 98032

(We Accept Visa, MasterCard, Discover Card, American Express, and Personal Checks)

For hearing or speech impaired TTY users, TTY: 1-866-605-1277

Service in Puerto Rico

Matsushita Electric of Puerto Rico, Inc. Panasonic Sales Company

Factory Servicer:

Ave. 65 de Infantería, Km. 9.5, San Gabriel Industrial Park, Carolina, Puerto Rico 00985

Phone (787)750-4300, Fax (787)768-2910

F1003

Conexiones

Conexión a un televisor

A una toma de CA

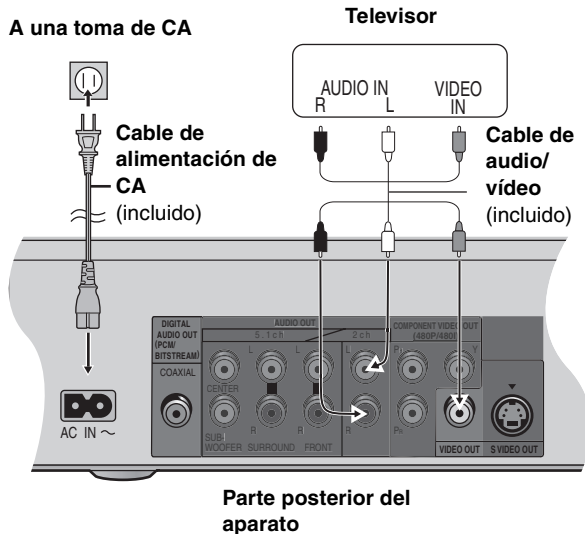

- Conecte el cable de alimentación de CA el último.

PREPARACIÓN RÁPIDA

Encienda el televisor y seleccione la entrada de vídeo apropiada en el mismo.

- 1 [⏻] Encienda.
- 2 [SETUP] Muestra la pantalla QUICK SETUP.
- 3 [▲ ▼ ◀ ▶] Pulse [▲ ▼] para seleccionar "Español" y pulse [ENTER]. Siga el mensaje y haga los ajustes.
- 4 [ENTER] Pulse para terminar PREPARACIÓN RÁPIDA.
- 5 [SETUP] Pulse para salir.

Reproducción básica

- 1 [⏻] Encienda.
- 2 [▲] Abre el cajón.
- 3 Introduzca el disco.
- 4 [▶] (PLAY) Inicie la reproducción.



Parada [■]

La posición se memoriza cuando "▷" parpadea en el visualizador.

- Pulse [▶] (PLAY) para proseguir.
- Pulse [■] para borrar la posición.

Pausa [||]

- Pulse [▶] (PLAY) para reiniciar la reproducción.

Salto [◀▶▶▶]

(Salto de grupo **WMA** **MP3** **JPEG** [▲ ▼])

Búsqueda

(durante la reproducción)
[◀▶▶▶]

- Hasta 5 pasos
- Pulse [▶] (PLAY) para iniciar la reproducción.
- **VCD** Cámara lenta, sentido de avance solamente

Cámara lenta

(durante la pausa)
[◀▶▶▶]

Cuadro a cuadro
(durante la pausa)
[◀▶]

- **VCD** Sentido de avance solamente

Selección de elemento en pantalla
[▲ ▼ ◀ ▶]
[ENTER]

Introduzca número **RAM** **DVD-A** **DVD-V** **VCD** **CD**
Botones numerados

Ej.: Para seleccionar 12:
[≥10] → [1] → [2]

VCD con control de reproducción
Durante la parada, pulse los botones numerados.

WMA **MP3** **JPEG**

Ej.: Para seleccionar 123:
[1] → [2] → [3] → [ENTER]

- Pulse [CANCEL] para cancelar el(los) número(s).

Menú de disco

[TOP MENU]

DVD-A **DVD-V**

Muestra un menú inicial de disco

[MENU]

DVD-V

Muestra un menú de disco

[RETURN]

VCD

Muestra un menú de disco

Vuelta a la pantalla anterior
[RETURN]

Aparato principal solamente

Salto de discos
[DISC SKIP]

Selección de disco Pulse para seleccionar directamente los discos.
(○ ○ ○ ○ ○)

CAUTION	- LASER RADIATION WHEN OPEN. DO NOT STARE INTO BEAM. FDA 21 CFR / Class II
CAUTION	- VISIBLE AND INVISIBLE LASER RADIATION WHEN OPEN. AVOID EXPOSURE TO BEAM. IEC60825-1 / Class 3b
VARNING	- SYNLIIG OCH OSYNLIIG LASERSTRÅLNING NÄR DENNA DEL ÄR ÖPPNAD. BETRÄKTA EJ STRÅLEN.
ADVARSEL	- SYNLIIG OG OSYNLIIG LASERSTRÅLING VED ÅBNING. UNDGÅ UDSÆTTELSE FOR STRÅLING.
ADVARSEL	- SYNLIIG OG OSYNLIIG LASERSTRÅLING NÄR DEKSEL ÅPNEAS. UNNGÅ EKSPOSERING FÖR STRÅLEN.
VARO!	- AVATTAESSA OLET ALTTIINA NÄKYVÄÄ JA NÄKYMÄTÖN LASERSÄTELYVÄ. ÄLÄ KATSO SÄTEELYÄ.
VORSICHT	- SICHTBARE UND UNSICHTBARE LASERSTRAHLUNG. WENN ABDECKUNG GEÖFFNET, NICHT DEM STRAHL AUSSETZEN.
ATTENTION	- RAYONNEMENT LASER VISIBLE ET INVISIBLE EN CAS D'OUVERTURE. EXPOSITION DANGEREUSE AU FAISCEAU.
注意	- 打开時有可见及不可见激光辐射。避免激光照射。
注意	- ここを開くと可視及び不可視レーザー光が出ます。ビームを見たり、触れたりしないで下さい。 ROLXS0054

(Inside of product)

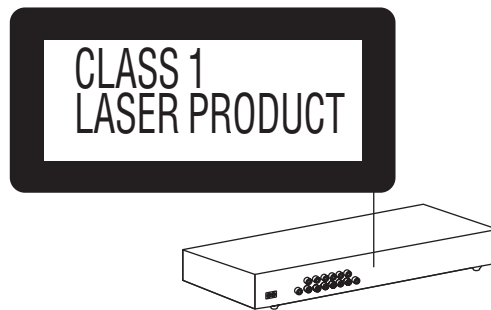

The laser product label has not been attached to products for the U.S.A. and Canada

For U.S.A.



As an ENERGY STAR® Partner, Panasonic has determined that this product meets the ENERGY STAR® guidelines for energy efficiency.

Asia

THIS UNIT IS INTENDED FOR USE IN TROPICAL CLIMATES.

Australia and N.Z.

THIS UNIT IS INTENDED FOR USE IN MODERATE CLIMATES.

This product may receive radio interference caused by mobile telephones during use. If such interference is apparent, please increase separation between the product and the mobile telephone.

Except for U.S.A. and Canada

The socket outlet shall be installed near the equipment and easily accessible or the mains plug or an appliance coupler shall remain readily operable.

Main feature index

Recalls **recommended audio/video setting** (→page 7)

Reproduces **high quality audio** (→page 7)

Selects discs to play (→page 7)

Shows a **disc top menu** (→page 6)
Shows a **program list** (→page 9)

Shows **On-Screen Menus** (→page 10)

Changes **subtitles** (→page 14)

Changes **soundtracks** (→page 14)

Program/random play (→page 9)

Sleep timer (→page 14)



Changes the **unit's display** (→page 6)

Audio only (→page 7)

Repeat play (→page 9)

Shows a **disc type screen** (→page 7)

Sequential play (→page 7)

Memorizes the position during play (→page 14)

Skips back a few seconds (→page 14)

Shows a **disc menu** (→page 6, 8)
Shows a **play list** (→page 9)

Changes **angles/rotates pictures** (→page 14)

Selects groups to play (→page 14)

Changes the **zoom ratio** (→page 14)

For U.S.A.

Panasonic Consumer Electronics Company, Division of Matsushita Electric Corporation of America
One Panasonic Way Secaucus, New Jersey 07094
<http://www.panasonic.com>

Panasonic Sales Company, Division of Matsushita Electric of Puerto Rico, Inc. ("PSC")

Ave. 65 de Infantería, Km. 9.5
San Gabriel Industrial Park, Carolina, Puerto Rico 00985

© 2003 Matsushita Electric Industrial Co., Ltd.

Printed in Singapore

For Canada

Panasonic Canada Inc.
5770 Ambler Drive
Mississauga, Ontario L4W 2T3
www.panasonic.ca

For others

Matsushita Electric Industrial Co., Ltd.
Web Site: <http://www.panasonic.co.jp/global/>

En Sp

RQT7292-1P
F1203NS1123

Free Manuals Download Website

<http://myh66.com>

<http://usermanuals.us>

<http://www.somanuals.com>

<http://www.4manuals.cc>

<http://www.manual-lib.com>

<http://www.404manual.com>

<http://www.luxmanual.com>

<http://aubethermostatmanual.com>

Golf course search by state

<http://golfingnear.com>

Email search by domain

<http://emailbydomain.com>

Auto manuals search

<http://auto.somanuals.com>

TV manuals search

<http://tv.somanuals.com>