

Panasonic

DVD/VIDEO CD/CD Player

Operating Instructions

DVD-P10D



Dear Customers

May we take this opportunity to thank you for purchasing this Panasonic DVD/VIDEO CD/CD player.

We strongly recommend that you carefully study the Operating Instructions before attempting to operate the unit and that you note the listed precautions.

Before attempting to connect, operate or adjust this product, please read these instructions completely. Please save this manual.

Safety information

Note:

This unit can be used only where the power supply is AC 120 V, 60 Hz. It cannot be used elsewhere.

CAUTION:

DVD/VIDEO CD/CD PLAYER IS A CLASS I LASER PRODUCT. HOWEVER THIS DVD/VIDEO CD/CD PLAYER USES A VISIBLE/INVISIBLE LASER BEAM WHICH COULD CAUSE HAZARDOUS RADIATION EXPOSURE IF DIRECTED. BE SURE TO OPERATE THE DVD/VIDEO CD/CD PLAYER CORRECTLY AS INSTRUCTED.

WHEN THIS DVD/VIDEO CD/CD PLAYER IS PLUGGED TO THE WALL OUTLET, DO NOT PLACE YOUR EYES CLOSE TO THE OPENING OF THE DISC LID AND OTHER OPENINGS TO LOOK INTO THE INSIDE OF THIS PLAYER.

USE OF CONTROLS OR ADJUSTMENT OR PERFORMANCE OF PROCEDURES OTHER THAN THOSE SPECIFIED HEREIN MAY RESULT IN HAZARDOUS RADIATION EXPOSURE.

DO NOT OPEN COVERS AND DO NOT REPAIR YOURSELF. REFER SERVICING TO QUALIFIED PERSONNEL.

WARNING:

TO REDUCE THE RISK OF FIRE OR ELECTRIC SHOCK, DO NOT EXPOSE THIS EQUIPMENT TO RAIN OR MOISTURE.

TO REDUCE THE RISK OF FIRE OR ELECTRIC SHOCK, AND ANNOYING INTERFERENCE, USE ONLY THE RECOMMENDED ACCESSORIES.

THIS DEVICE IS INTENDED FOR CONTINUOUS OPERATION!

CAUTION: (Canada Only)

TO PREVENT ELECTRIC SHOCK, DO NOT USE THIS (POLARIZED) PLUG WITH AN EXTENSION CORD, RECEPTACLE OR OTHER OUTLET UNLESS THE BLADES CAN BE FULLY INSERTED TO PREVENT BLADE EXPOSURE.

CAUTION -LASER RADIATION WHEN OPEN.
DO NOT STARE INTO BEAM.

ATTENTION-RAYONNEMENT LASER EN CAS D'OUVERTURE.
NE PAS REGARDER DANS LE FAISCEAU.

(Bottom of unit)

Marking sign is located on bottom of the DVD/VIDEO CD/CD Player.



CAUTION
RISK OF ELECTRIC SHOCK
DO NOT OPEN



CAUTION: TO REDUCE THE RISK OF ELECTRIC SHOCK, DO NOT REMOVE COVER (OR BACK). NO USER-SERVICEABLE PARTS INSIDE. REFER SERVICING TO QUALIFIED SERVICE PERSONNEL.



The lightning flash with arrowhead symbol, within an equilateral triangle, is intended to alert the user to the presence of uninsulated "dangerous voltage" within the product's enclosure that may be of sufficient magnitude to constitute a risk of electric shock to persons.



The exclamation point within an equilateral triangle is intended to alert the user to the presence of important operating and maintenance (servicing) instructions in the literature accompanying the appliance.

FCC NOTE: (U.S.A. Only)

This equipment has been tested and found to comply with the limits for a Class B digital device, pursuant to Part 15 of the FCC Rules. These limits are designed to provide reasonable protection against harmful interference in a residential installation. This equipment generates, uses and can radiate radio frequency energy and, if not installed and used in accordance with the instructions, may cause harmful interference to radio communication. However, there is no guarantee that interference will not occur in a particular installation. In this equipment does cause harmful interference to radio or television reception, which can be determined by turning the equipment off and on, the user is encouraged to try to correct the interference by one or more of the following measures:

- Reorient or relocate the receiving antenna.
- Increase the separation between the equipment and receiver.
- Connect the equipment into an outlet on a circuit different from that to which the receiver is connected.
- Consult the dealer or an experienced radio/TV technician for help.

FCC Caution: To assure continued compliance, follow the attached installation instructions and use only shielded cables when connecting to other devices. Also, any changes or modifications not expressly approved by the party responsible for compliance could void the user's authority to operate this equipment.

Compact Size DVD/VIDEO CD/CD Player

**Compatible with Video CD
and CD as well DVD**

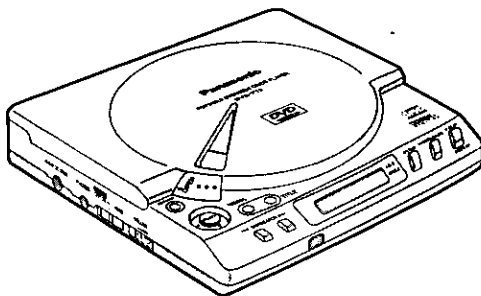

Compact Size

This compact, lightweight DVD/Video CD/CD player measures 6 $\frac{5}{16}$ " (160 mm) (W) × 6 $\frac{5}{16}$ " (160 mm) (D) × 1 $\frac{7}{16}$ " (36 mm) (H) and weighs only 1.4 lbs. (620 g), making it easy to carry around so that you can enjoy DVD wherever there is a TV set.

High-Resolution Video and High-Quality Sound

This DVD/Video CD/CD player includes a 10-bit video D/A converter for the sharp reproduction of high-resolution DVD images. In addition, the 96 kHz/24-bit audio D/A converter allows faithful reproduction of linear PCM 96 kHz/24-bit audio, the highest DVD audio specifications.

Virtual Surround Sound (V.S.S.) effect (See page 50.)

This player can reproduce a virtual surround sound effect which provides a sound as if heard from non-existent rear speakers even when only a 2-channel stereo system is connected [for playback of Dolby Digital (AC-3) / 5.1ch DVD software only]. (The virtual surround sound effect may work differently depending on the DVDs.)

On-Screen Menu Icons (See pages 32–37.)

On-Screen Menu Icons show the disc information or player information and provide access to many major functions of the player.

Multi-audio function

(See page 45.)

The audio soundtrack can be heard in up to 8 languages. (The number of audio languages depends on the software.)

Multi-subtitle function

(See page 46.)

Subtitles may be displayed in one of a maximum of 32 languages. (The number of subtitle languages depends on the software.)

Multi-angle function

(See page 47.)

This function allows you to choose the viewing angle of scenes which were shot from a number of different angles. (Limited to DVDs recorded with multiple camera angles.)

Marker function

(See pages 40 and 41.)

This player can store a maximum of 5 scenes in memory, which can be recalled when you like.

Parental lock function

(See pages 54–57.)

This can prevent the playback of DVDs that are unsuitable for children.

■ Disc formats supported by this player



DVD

[5" (12 cm) disc/3" (8 cm) disc]



Video CD

[5" (12 cm) disc/3" (8 cm) disc]



CD

[5" (12 cm) disc/3" (8 cm) disc]

■ Discs which cannot be played with this player

- DVD with Region No. other than "1" or "ALL"
- Discs of PAL system
- DVD-ROM ● DVD-R/DVD-RAM
- CD-ROM ● CDV
- CD-G ● Photo CD
- CD-R

■ Marks used in these instructions (pages 27–50)



...This gives details on a function which can be enjoyed with DVD.



...This gives details on a function which can be enjoyed with Video CD.



...This gives details on a function which can be enjoyed with CD.

Region Management Information



Region Management Information: This DVD/VIDEO CD/CD player is designed and manufactured to respond to the Region Management Information that is recorded on a DVD disc. If the Region number described on the DVD disc does not correspond to the Region number of this DVD/VIDEO CD/CD player, this DVD/VIDEO CD/CD player cannot play this disc.

The Region number for this DVD/VIDEO CD/CD player is 1.

The model number and serial number of this product can be found on either the back or the bottom of the unit. Please note them in the space provided below and retain this booklet as a permanent record of your purchase to aid identification in the event of theft.

MODEL NUMBER _____

SERIAL NUMBER _____

Accessories



Please check and identify the supplied accessories.

(Only for U.S.A.)

To order accessories, call PASC Accessory Dept. 1-888-PANA-DVD (1-888-726-2383).

(Only for Canada)

To order accessories, call the dealer from whom you have made your purchase.

- Remote control unit** 1
(Part No. VEQ2015)

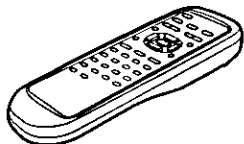

- Batteries** 2
for remote control unit
(size "AA")

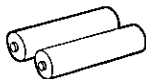

- AC adaptor** 1
(Part No. VSK0531)

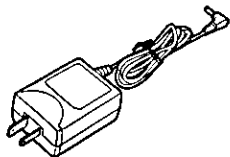

- Video/audio cable** 1
(Part No. VJA1065)

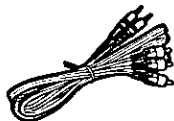

Table of contents

Getting Started:

Safety information	2
Accessories	6
Safety precautions	8

Preparations:

Connection	18
•Connecting to a stereo TV set	18
•Connecting to audio equipment	19

Basic Operation:

Basic play	26
•Stopping play	28
•Rapid advance/Rapid reverse	29
•Skipping ahead or back	29
•Still picture/Pause	30

Advanced Operations:

Operation using the On-Screen Menu Icons	32
•Detailed descriptions of each icon [Screen for disc information]	34
•Detailed descriptions of each icon [Screen for player information]	36
•Detailed descriptions of each icon [Shuttle screen]	37

For Your Reference:

Changing the initial settings	51
•When "1 Disc Languages" is selected	52
•When "2 Ratings" is selected	54
•When "3 Menu Language" is selected	58

Operating precautions	9
• Handling precautions	9
• Maintenance	10
Disc handling	11
Control reference guide	12

• Connecting headphones (optional)	19
• Connecting to a decoder with Dolby Digital (AC-3) processing	20

Remote control preparation	22
• Battery (supplied) installation	22
• Remote control operation range	23
• Remote control operational notes	23
Inserting/Removing discs	24
• Inserting discs	24
• Removing discs	25

• Frame advance (DVD/Video CD only)	30
• Slow-motion play (DVD/Video CD only)	31
• Enjoying Video CD playback without using menus (Video CD only)	31

Repeat play	38
• Repeat viewing (listening)	38
• Repeating sections between two specific points (A-B repeat)	39
Storing markers in memory to be viewed (heard) again	40
• Storing a marker in memory	40
• Recalling a marker	41
• Clearing a marker	41
Program play	42

Random play	44
Changing audio soundtrack language	45
Changing subtitle language	46
Viewing from another angle	47
Using a menu	48
• Using a title menu	49
• Using a DVD menu	49
Reproducing a Virtual Surround Sound (V.S.S.) effect	50

• When "4 On-Screen Messages" is selected	59
• When "5 TV Aspect" is selected	59
• When "6 Digital Audio Output" is selected	60
• When "9 Other Settings" is selected	62

Language code list	64
Troubleshooting	65
Self-diagnosis display function	68
Index	69
Definition of terms	70
Specifications	Back cover

Safety precautions

Please read these precautions before operating this player.

■ AC adaptor protection

To avoid any malfunctions of the player, and to protect against electric shock, fire or personal injury, please observe the following.

- Hold the plug firmly when connecting or disconnecting the AC adaptor to this player.
- Do not connect or disconnect the AC adaptor when your hands are wet.
- Keep the AC adaptor away from heating appliances.
- Never put any heavy objects on the AC adaptor.
- Do not attempt to repair or reconstruct the AC adaptor in any way.
- Remove dust, dirt, etc. on the plug at regular intervals.
- If liquids or foreign objects have been spilled into the player or AC adaptor, turn off the power and disconnect the AC adaptor.
- If the player has been dropped or otherwise damaged, turn off the power and disconnect the AC adaptor.
- If smoke, malodors or noises are emitted from the player or AC adaptor, turn off the power and disconnect the AC adaptor.

- Do not touch the AC adaptor or the metal part of the player during a thunderstorm.
- Do not use the player above the established ratings of the power outlet and power distributor or supply an AC voltage other than 120 V.
- Do not scratch or mark the AC adaptor, rework it, place it in proximity to a heating appliance, forcibly bend it, twist it, pull it, place heavy objects on top of it, bunch it together with other wires or units, or put a cloth over it.
- Insert the power plug securely until its prongs are completely housed inside the power outlet.
- Use only the AC adaptor provided.

■ Do NOT disassemble or remodel this player.

■ Placement

Avoid placing the player or AC adaptor in areas of:

- direct sunlight or heating radiators, or closed automobiles
- high temperature [over 95°F (35°C)] or high humidity (over 90%)
- excessive dust or oily smoke
- vibration, impact or where the surface is tilted
- in a poorly ventilated location as the internal parts may be seriously damaged.

■ No fingers or other objects inside

- Touching internal parts of this player is dangerous, and may cause serious damage to the player. Do not attempt to disassemble the player.
- Do not put any foreign object inside the player or AC adaptor.
- Do not insert metal or inflammable objects inside the player or AC adaptor.
- Take care not to catch your fingers when you close the disc lid.

Operating precautions

Handling precautions

■ Keep away from water and magnets.

- Keep the player or AC adaptor away from flower vases, tubs, sinks, etc. If liquids are spilled into the player or AC adaptor, serious damage could occur.
- Keep magnetic objects such as speakers, at a distance from this player.

■ Stacking

- Place the player in a horizontal position, and do not place anything heavy on it.
- Do not place the player on amplifiers or other equipment which may become hot.

■ Do not use cracked or warped discs.

■ If there is noise interference on the TV while a broadcast is being received

Depending on the reception condition of the TV, interference may appear on the TV screen while you are watching a TV broadcast if the player is left on. This is not a malfunction of the player or the TV. To watch a TV broadcast, turn off this player.

■ When installing the player

- Avoid shelves and other high locations.

■ When operating the player

- Do not expose the player to the sprays from volatile insecticides, etc. (Doing so may deform the external cabinet or cause the paint to peel off.)
- After the player is used for many hours, the surface of the player becomes hot; this is normal, not a malfunction.
- Do not touch the pickup unit (the lens in particular) inside the disc lid with your hands or other objects. (Doing so may cause a malfunction.)
- Do not insert objects into the opening hole area of the pickup unit. (Doing so may cause a malfunction.)
- Do not push the disc lid downward during playback. (Doing so may damage the disc inside.)
- Do not subject the player to impact during playback. (Doing so may damage the disc inside.)
- Do not set the player down on a sofa for operation. (Doing so may increase the temperature inside the player and cause damage to the player.)

Operating precautions

Handling precautions

■ Condensation

Moisture may form on the lens in the following conditions...

- immediately after a heater has been turned on.
- in a steamy or very humid room.
- when the player is moved from a cold environment to a warm one.

If moisture forms inside this player, it may not operate properly. In this case, turn on the power and wait about 1 to 2 hours for the moisture to evaporate.

■ When bringing the player into a hospital

- The electromagnetic waves emitted by the player may interfere with the medical equipment in the hospital. Follow the instructions given by the medical personnel.

■ When bringing the player inside a car

- Do not use the car's cigarette lighter socket to supply power to the player. (Doing so may cause a malfunction.)
- Do not leave the player in areas of extremely high temperature [over approx. 140°F (60°C)] such as inside of the car in hot summer or in the car trunk or of extremely low temperature [under approx. 4°F (-20°C)]. (Doing so may cause cabinet deformation.)

■ When moving or transporting the player

- When moving the player, remove the disc if one is inside, and disconnect the AC adaptor and other cords.
- When transporting the player for relocation, place the player in its original packing carton.
- Do not drop the player or bump it into objects when moving or transporting it.

■ When the player is not going to be used for a long time

- To conserve power, turn off the power, and disconnect the AC adaptor from the power outlet. (Even when the player's power switch is turned off, power equivalent to about 0.8 W will be consumed unless the AC adaptor is disconnected.)
- Be sure to close the disc lid. (Dust may settle on the lens or other parts, which may cause a malfunction.)

Maintenance

- Be sure to turn the power off and disconnect the AC adaptor before maintaining the player.
- Wipe this player with a dry, soft cloth. If the surfaces are extremely dirty, wipe clean with a cloth which has been slightly moistened with in a weak soap-and-water solution and wrung out thoroughly, and then wipe again with a dry cloth.
- Never use alcohol, benzine, thinner, cleaning fluid or other chemicals. And do not use compressed air to remove dust.

■ Maintenance of the lens

- If dust has settled on the lens, remove dust carefully with an air blower for camera lenses (optional).
Be careful not to touch the lens with your fingers.

Disc handling

■ Handling precautions

- Hold the disc by the edges so the surface will not be soiled with fingerprints. Fingerprints, dirt and scratches can cause skipping and distortion.

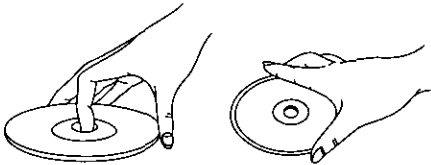

- Do not write on the label side with a ball-point pen or other writing utensils.
- Do not use record cleaning sprays, benzene, thinner, static electricity prevention liquids or any other solvent.
- Be careful not to drop or bend the disc.
- Do not insert more than 1 disc.
- Do not try to close the disc lid when the disc is not inserted properly.
- Be sure to store the disc in its case when not in use.

■ If the surface is soiled

Wipe gently with a soft, damp (water only) cloth.

When wiping discs, always move the cloth from the center hole toward the outer edge. (If you wipe the discs using a circular motion, circular scratches are likely to occur, which will cause noise.) Ensure that the disc is dry before inserting into the player.

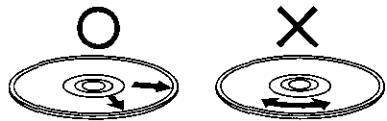

■ If the disc is brought from a cold to a warm environment, moisture may form on the disc

Wipe this moisture off with a soft, dry, lint-free cloth before using the disc.

■ Improper disc storage

You can damage discs if you store them in the following places:

- Areas exposed to direct sunlight
- Humid or dusty areas
- Areas directly exposed to a heat outlet or heating appliance

Control reference guide

Main unit (Front view)

RETURN button [RETURN]

Press to return to the previous menu. (See pages 26, 32 and 52–62.)

OPEN button [▲OPEN]

Press to open the disc lid.
(See pages 24 and 25.)

MENU button [MENU]

When pressed during play, the DVD menu recorded on the disc will be displayed. (See page 49.)
When pressed in the stop mode, the initial settings screen will be displayed. (See pages 51–62.)

Disc lid

(See pages 24 and 25.)

TITLE button [TITLE]

Press to show the title menu recorded on the disc. (See pages 26 and 49.)

STOP button [■STOP]

Press to stop playback. (See page 28.)

STILL/PAUSE button [▶▶ STILL/PAUSE]

Press to place the player in the still picture/pause mode or to advance the disc by one frame. (See pages 29–31.)

Display window
(See page 14.)

Remote control signal sensor

Point the remote control unit at the sensor when operating the player. (See page 23.)

Joystick/SELECT button [SELECT]

Make the selection by tilting the joystick forward, backward or to the left or right, and then press SELECT to enter the selection. (See page 27.)

SKIP/SEARCH buttons

[|◀◀ SKIP/SEARCH ▶▶|]

Press for rapid advance/reverse or skipping ahead/back (see page 29) or for slow-motion play (see page 31).

◀◀: Backward

▶▶: Forward

PLAY/DISPLAY button

[▶ PLAY/DISPLAY]

When pressed in the stop mode, playback starts. (See page 27.)
When pressed during playback, the On-Screen Menu Icons will be displayed. (See page 33.)

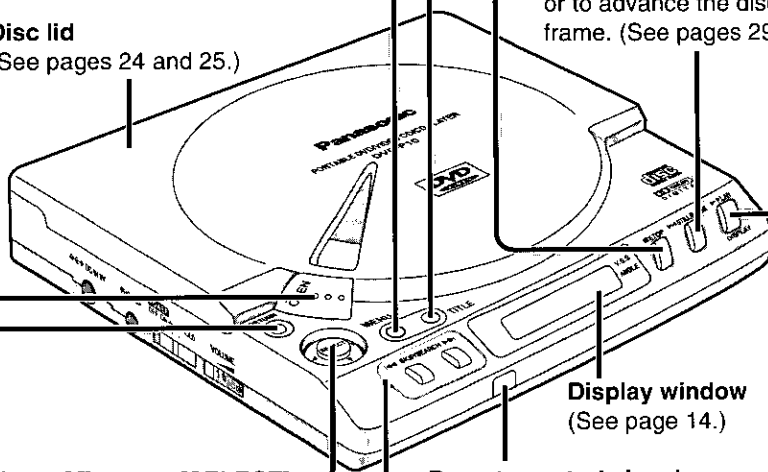

Main unit (Rear view)

Video output connector [VIDEO]
 Connect the video/audio cable (supplied).
 (See pages 18 and 19.)

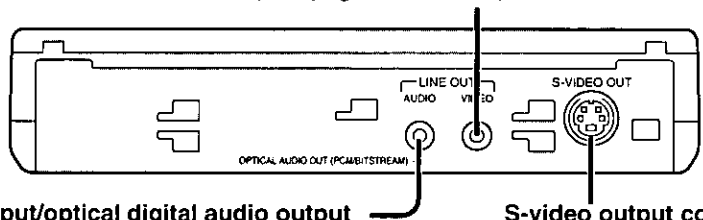

Audio output/optical digital audio output connector [AUDIO]
 Connect the video/audio cable (supplied) or optical digital audio cable (optional). The type of the output signal will be automatically selected according to the cord or cable that is connected. (See pages 18–21.)

S-video output connector [S-VIDEO OUT]
 Connect the S-video cable (optional). (See page 18.)

Main unit (Side view)

DC input connector
 [⚡ DC IN 9V]
 Connect the DC plug of the AC adaptor (supplied). (See page 18.)

Headphone jack [PHONES]
 Connect the headphones (optional) with a 1/8" (3.5 mm) stereo plug. (See page 19.)

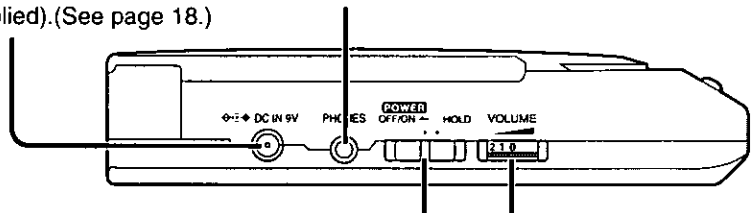

Power switch [POWER OFF/ON ←] / HOLD switch [HOLD]
 ● When this switch is slid toward the direction of [**POWER OFF/ON ←**] for more than 1 second, the power will be turned OFF or ON.
 ● The HOLD function (for preventing errors in operation) is activated when the switch is slid to the HOLD position.

Volume level [VOLUME]
 Turn to adjust the volume level output from the headphones. (See page 19.)
 0: No sound is heard
 10: Maximum

HOLD function:

The hold function ensures that even when a function button is inadvertently pressed, the function corresponding to the button will not be acknowledged. (It prevents the function buttons from being pressed during operation, the picture and/or sound from being terminated, etc.)

When a function button is pressed while the hold function is working, "Hold" appears in the player's display window. (See page 15.)

Control reference guide

Main unit (Display window)

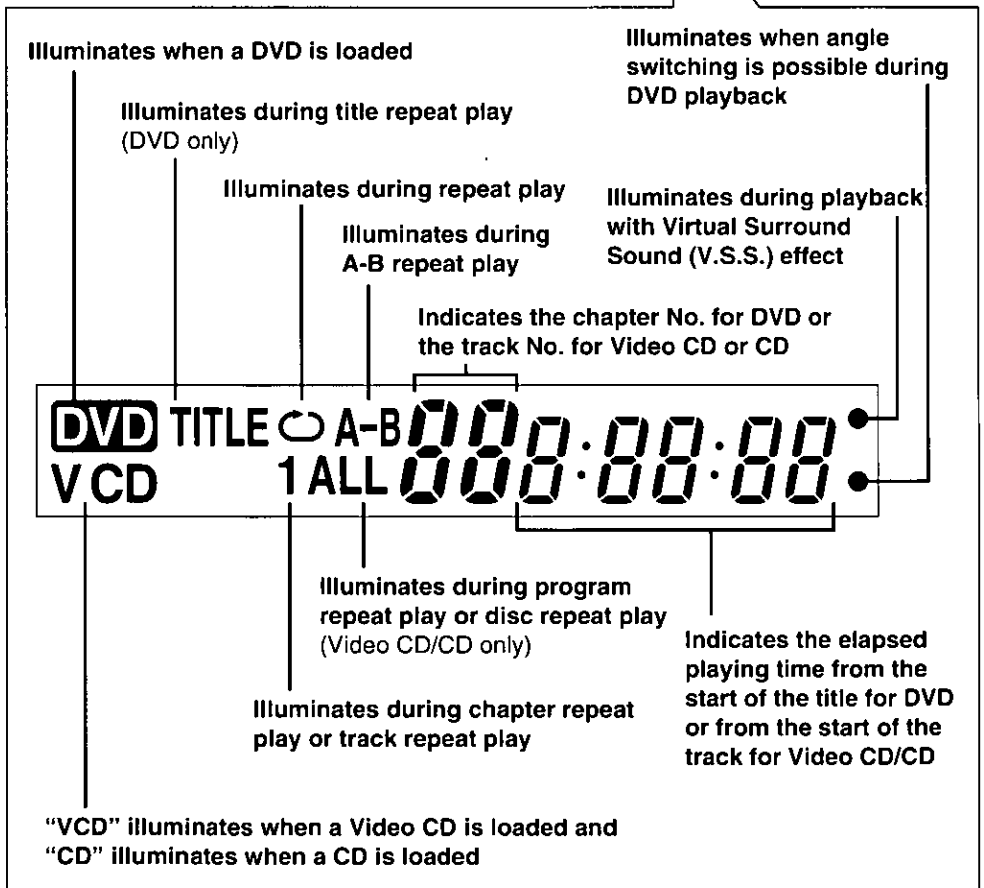
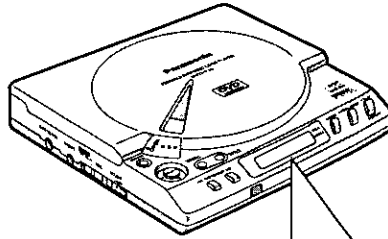

Player status

When the disc lid is open

When no disc is loaded

When a DVD or a Karaoke DVD is played

When an interactive DVD is played

When a Video CD is played

When a Video CD with playback control is played

When a CD is played

When any button is pressed while the HOLD function is activated

When the AC adaptor (supplied) is connected and the power switch of the player is turned off (Standby mode)

When playback is impossible

Display

VCD TITLE A-B 00:00:00
VCD 1 ALL

VCD TITLE A-B 00:00:00
VCD 1 ALL

DVD TITLE A-B 25:23:45
VCD 1 ALL

Chapter 25 is played Elapsed playing time of title

DVD TITLE A-B 00:00:00
VCD 1 ALL

VCD TITLE A-B 05:02:45
VCD 1 ALL

Track 5 is played Elapsed playing time of track

VCD TITLE A-B 00:00:00
VCD 1 ALL

VCD TITLE A-B 05:02:45
VCD 1 ALL

Track 5 is played Elapsed playing time of track

VCD TITLE A-B 00:00:00
VCD 1 ALL

DVD TITLE A-B 00:00:00
VCD 1 ALL

DVD TITLE A-B 00:00:00
VCD 1 ALL

- DVDs for which playback is prohibited by the initial settings "2 Ratings" (See pages 54–57.)
- DVDs with Region No. other than "1" or "ALL"
- DVDs of PAL system

Control reference guide

Remote control unit

Buttons used for basic operation

POWER button

Press to turn the power ON or OFF. (See page 27.)

STOP button

Press to stop playback. (See page 28.)

SKIP buttons

Press for skipping ahead/back. (See pages 26 and 29.)

◀◀: Backward

▶▶: Forward

TITLE button

Press to show the title menu recorded on the disc. (See pages 26 and 49.)

DISPLAY button

Press to show the On-Screen Menu Icons. (See page 33.)

Cursor buttons

Press ▲▼◀▶ to select the item. (See page 27.)

SELECT button

Press to enter the item selected by the cursor buttons (▲▼◀▶). (See page 27.)

STILL/PAUSE button

Press to place the player in the still picture/pause mode or to advance the disc by one frame. (See pages 29–31.)

PLAY button

Press to start playback. (See page 27.)

SLOW/SEARCH buttons

Press for rapid advance/reverse (see page 29) or for slow-motion play (see page 31).

◀◀: Backward

▶▶: Forward

MENU button

When pressed during play, the DVD menu recorded on the disc will be displayed. (See page 49.) When pressed in the stop mode, the initial settings screen will be displayed. (See pages 51–62.)

RETURN button

Press to return to the previous menu. (See pages 26, 32 and 52–62.)

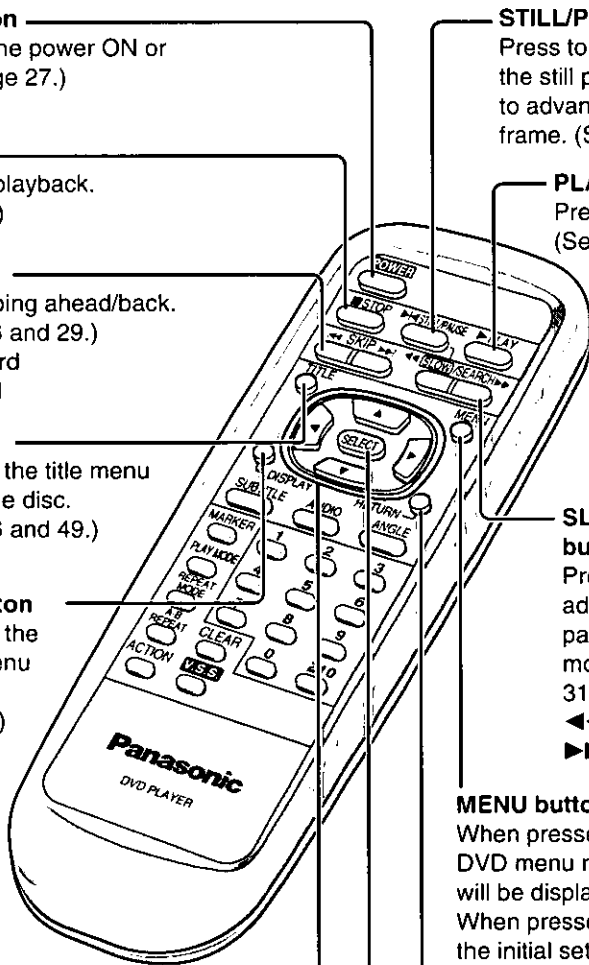

Buttons used for advanced operations

SUBTITLE button

Press to change the subtitle language. (See page 46.)

MARKER button

Press to store markers in memory to be viewed (heard) again. (See pages 40 and 41.)

PLAY MODE button

Press to select "Normal play", "Program play" or "Random play". (See pages 43 and 44.)

REPEAT MODE button

Press for repeat play. (See pages 38 and 39.)

ACTION button

Press to show the initial settings screen. (See pages 51–62.)

A-B REPEAT button

Press to repeat sections between two specific points. (See page 39.)

AUDIO button

Press to change the audio soundtrack language for DVD, to switch the vocal mode for DVD Karaoke, or to select "LR", "L" or "R" for Video CD. (See page 45.)

ANGLE button

Press to view from another angle. (See page 47.)

Numeric buttons

Press to enter numbers. (See page 27.)
To enter a number "10" or higher, use the ≥ 10 button.
Example: To enter "25"

≥ 10 \Rightarrow 2 \Rightarrow 5

CLEAR button

Press to clear the entered numbers. (See pages 32, 41 and 43.)

Virtual Surround Sound (V.S.S.) button

Press to activate the Virtual Surround Sound effect. (This effect works only during playback of DVDs recorded in Dolby Digital/5.1ch Surround Sound.) (See page 50.)

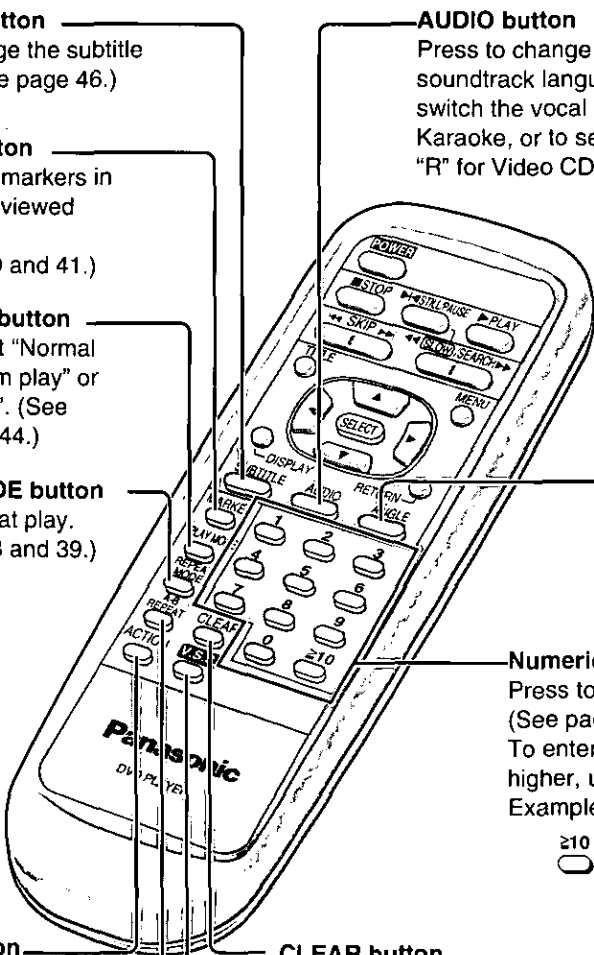

Connection

- Ensure that the power of the player and other equipment to be connected is turned off before commencing connection.
- Do not block ventilation holes of any of the equipment and arrange them so that air can circulate freely.
- Read through the instructions before connecting other equipment.
- Ensure that you observe the color coding when connecting audio and video cables.
- Select the appropriate screen type at the initial setting "5 TV Aspect" according to your TV set (4:3 or 16:9). (See page 59.)

Connecting to a stereo TV set

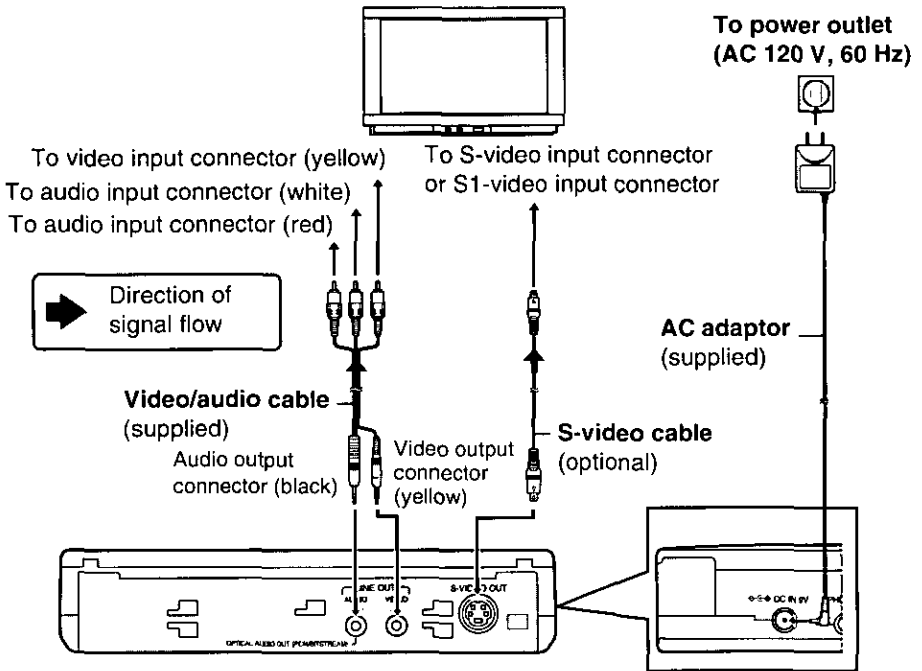

Notes:

- During DVD play, the TV volume may be at a lower level than during TV broadcasts, etc. If this is the case, adjust the volume to the desired level.
- If the player is connected to the TV through a video cassette recorder, the picture may not be played back normally with some DVDs. If this is the case, do not connect the player via the VCR.



- **When connecting this player to a TV set equipped with an S-video input connector**
The S (separate) video output connector separates the color (C) and luminance (Y) signals before transmitting them to the TV set in order to achieve a sharper picture. Use the S-video cable (optional) when connecting the player to a TV set equipped with an S-video input connector for the best picture clarity possible. When using the S-video cable, the yellow composite video plug need not be connected to the TV.

Connecting to audio equipment

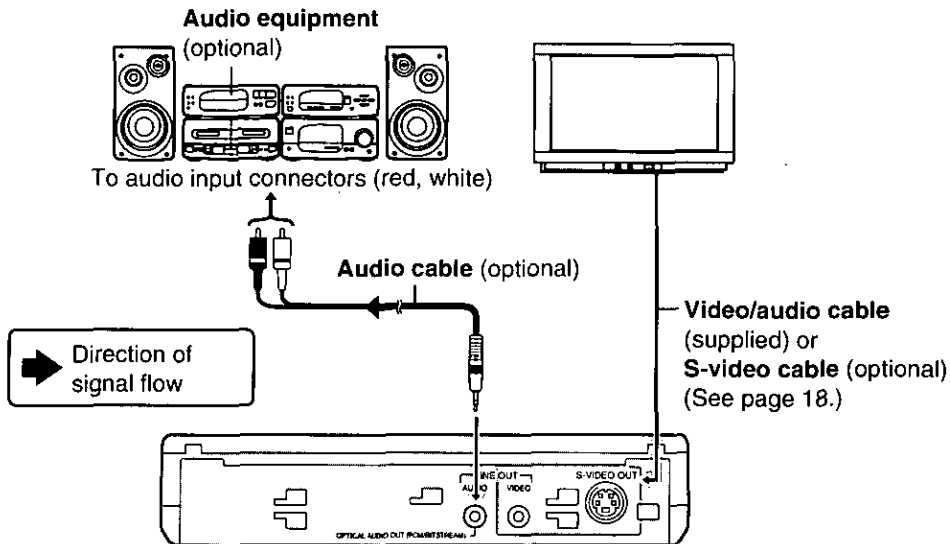

Connecting headphones (optional)

Connect the headphones.

- Headphones with a $\frac{1}{8}$ " (3.5mm) stereo plug can be connected.
- Turn down the volume level before connection, and then adjust the level.

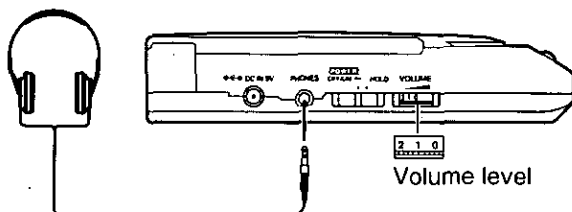

Caution:

- Avoid listening to the sound at levels which may be harmful to your ears.

Connection

Connecting to a decoder with Dolby Digital (AC-3) processing

When DVDs recorded in Dolby Digital (AC-3)/5.1ch are played, Dolby Digital bitstream is output from the player's audio output/optical digital audio output connector. When the player is connected to a Dolby Digital decoder using the optical digital audio cable (optional), you can enjoy theater-quality audio in your home.

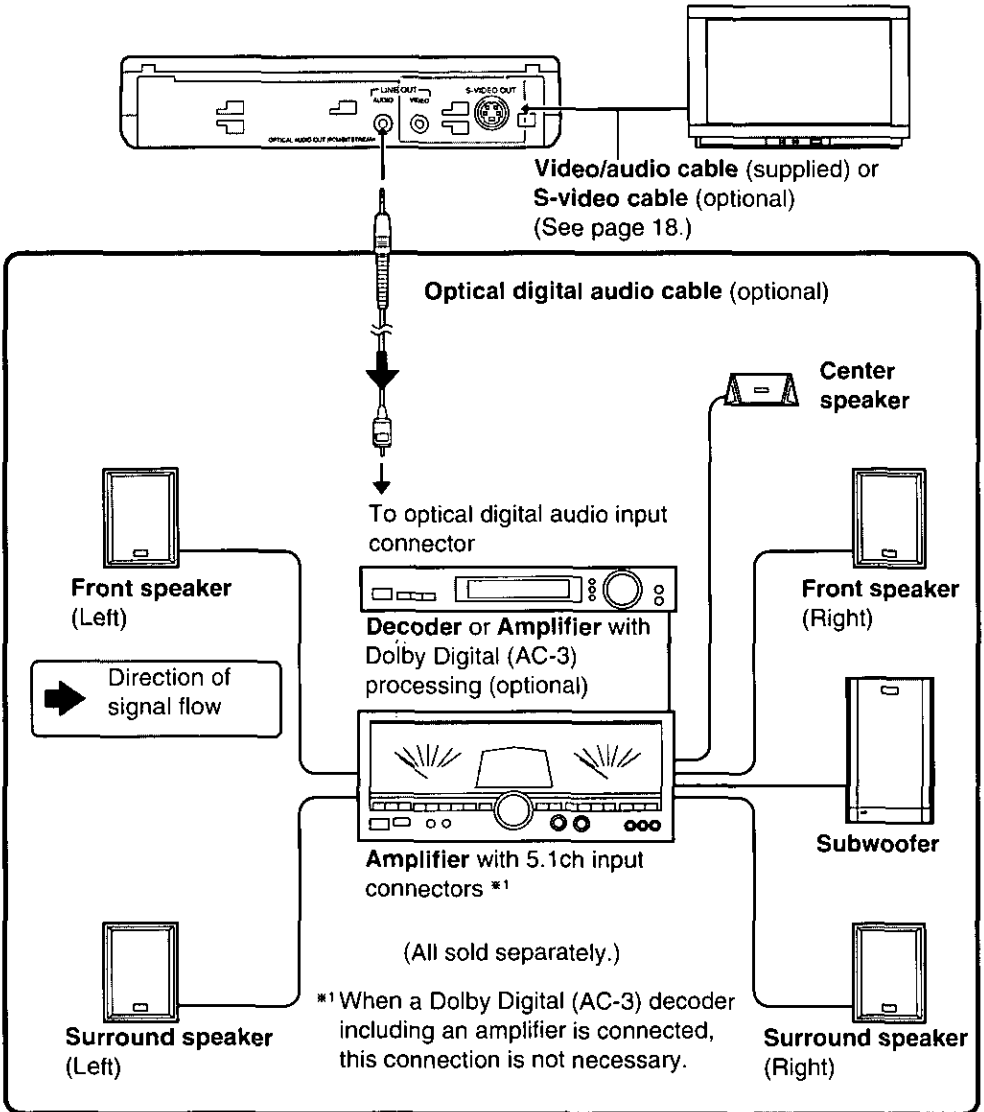

Caution for the audio output/optical digital audio output connector:

- When connecting an amplifier (with an optical digital input connector) which does not contain the Dolby Digital (AC-3) decoder, be sure to select "PCM" at "2 Dolby Digital" of the initial setting "6 Digital Audio Output". (See page 60.)
- Otherwise any attempt to play DVDs may cause such a high level of noise that it may be harmful to your ears and damage your speakers.
- Video CDs and CDs can be played as they would normally be played.

■ Concerning the audio output from the player's audio output/optical digital audio output connector

Disc	Sound recording format	Optical digital audio output from connector
DVD	Dolby Digital (AC-3)	<ul style="list-style-type: none"> • Dolby Digital (AC-3) bitstream (1–5.1ch) • PCM (2ch) (48 kHz/16 bit)*1 *2
	Linear PCM (48/96 kHz 16/20/24 bit)	<ul style="list-style-type: none"> • Linear PCM (2ch) (48 kHz sampling/16 bit only) • No output*2
Video CD	MPEG 1	PCM (44.1 kHz sampling)*1
CD	Linear PCM	Linear PCM (44.1 kHz sampling)

*1 The compressed audio signals are converted to PCM and then output.

*2 The type of audio can be selected by the initial setting "Digital Audio Output". (See page 60.)

For your reference:

- Dolby Digital (AC-3) is a digital sound compression technique developed by the Dolby Laboratories Licensing Corporation. Supporting 5.1-channel surround sound, as well as stereo (2-channel) sound, this technique enables a large quantity of sound data to be efficiently recorded on a disc.
- Linear PCM is a signal recording format used in CDs. While CDs are recorded in 44.1 kHz/16 bit, DVDs are recorded in 48 kHz/16 bit up to 96 kHz/24 bit.
- If you have a Dolby Pro Logic Surround decoder, you will obtain the full benefit of Pro Logic from the same DVD movies that provide full 5.1-channel Dolby Digital soundtracks, as well as from titles with the Dolby Surround mark.

Manufactured under license from Dolby Laboratories. "Dolby" and the double-D symbol are trademarks of Dolby Laboratories. Confidential Unpublished Works. © 1992-1997 Dolby Laboratories, Inc. All rights reserved.

Remote control preparation

Battery (supplied) installation

- 1 Open the cover.** _____
(Press down the part  and slide the cover in the direction of the arrow and lift it.)

- 2 Insert the batteries.** _____
(Insert the batteries while observing the correct \oplus and \ominus polarities.)

- 3 Close the cover.** _____

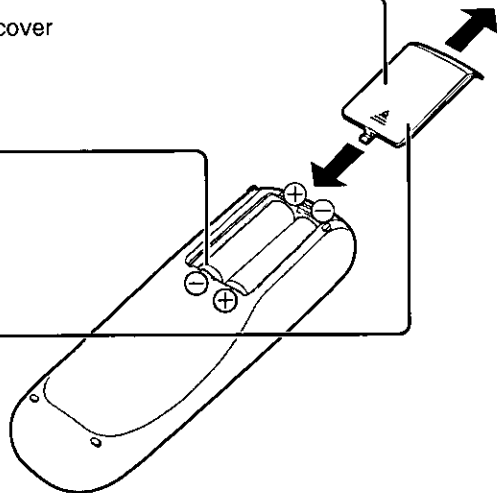

■ Service life of batteries

- The batteries normally last for about one year although this depends on how often, and for what operations, the remote control is used.
- If the remote control unit fails to work even when it is operated near the player, replace the batteries.
- Use size "AA" batteries.

Remote control operation range

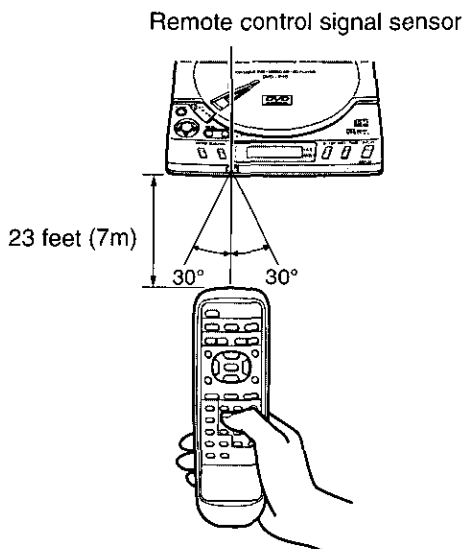

Remote control operational notes

- Do not use rechargeable (Ni-Cd) batteries.
- Do not attempt to recharge, short-circuit, disassemble, heat or throw the batteries into a fire.
- Do not mix old and new batteries.
- Do not drop, step on or otherwise impact the remote control unit. This may damage the parts or lead to malfunction.
- If the remote control unit is not going to be used for a long time, remove the batteries. Otherwise, electrolyte may leak which may lead, not only to malfunction, but also, to burns, if contact is made with the electrolyte.
- Wipe away any electrolyte leaking inside the remote control unit, and install new batteries.
- If any electrolyte should come into contact with parts of your body, wash it off thoroughly with water.
- Do not point bright lights at the remote control sensor.
- Do not place objects between the remote control unit and the remote control sensor.
- Do not use this remote control unit while simultaneously operating the remote control unit of any other equipment.

Inserting/Removing discs

Inserting discs

- 1 Press **OPEN** and open the disc lid.

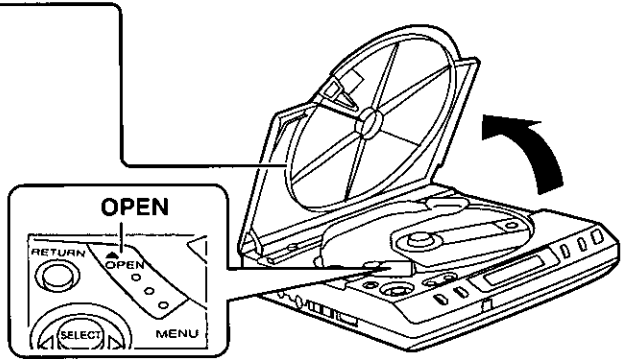

- 2 With the printed title side to be played back facing up, place the disc in position, using your fingers to push down on the area around the center hole. (A click is heard.)

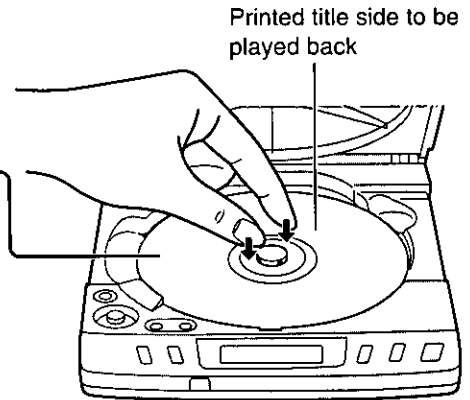

- 3 Close the disc lid.

Note:

- Do not insert more than 1 disc.

Removing discs

1 Press STOP.

2 Press OPEN and open the disc lid.

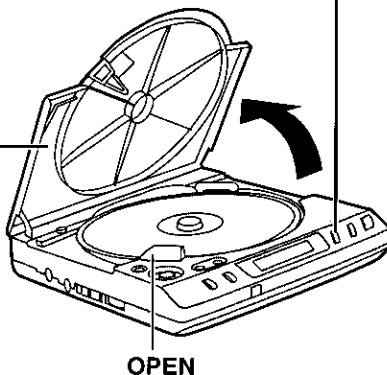

3 Using the groove for removing, remove the disc.

- Do not touch the disc surface when removing.

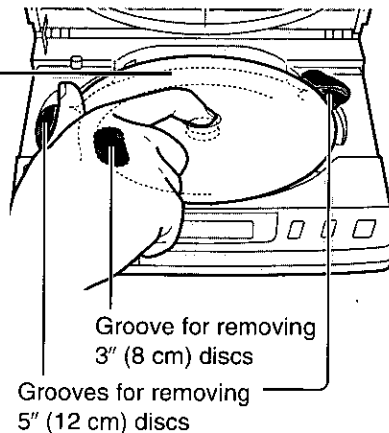

4 Close the disc lid.

Note:

- Be sure to keep the disc lid closed except while inserting/removing discs. This will reduce the risk of malfunction caused by dust entering the inside of the player.

Basic play

Preparations

- Switch the TV ON and select "Video" as the TV input.
- Switch on the stereo system's power if the player has been connected to a stereo system.

Confirm that the power is turned on. (See pages 13 and 16.)

Confirm that the disc is loaded. (See page 24.)

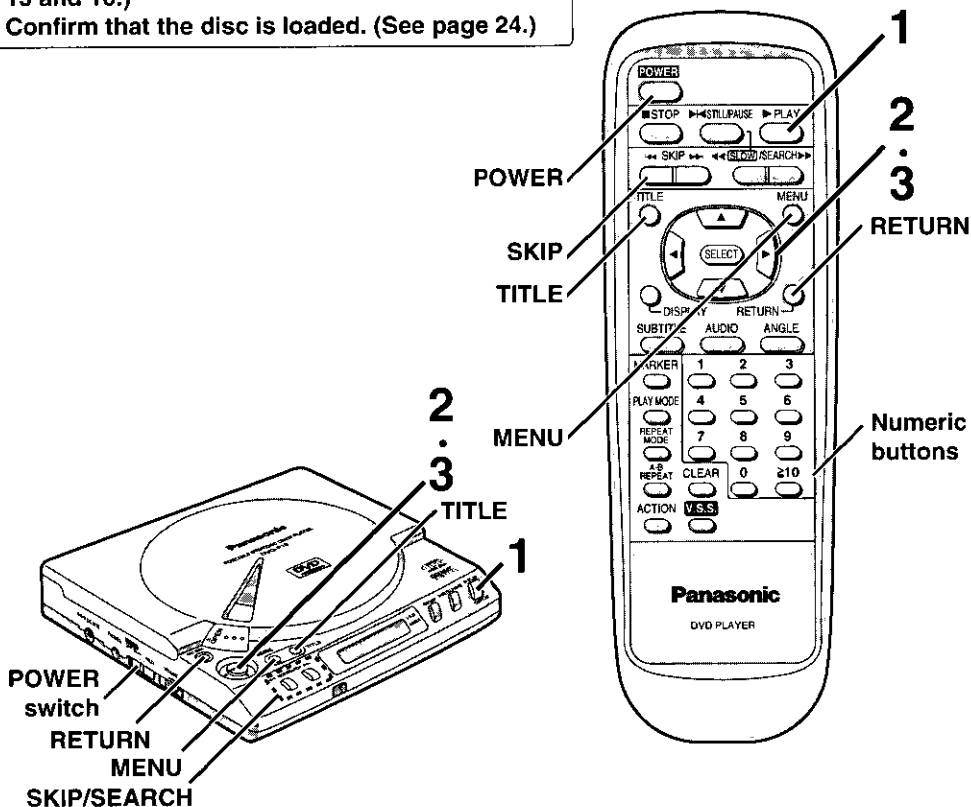

For your reference:

- When the menu continues onto another screen, pressing SKIP (in the case of the main unit, SKIP/SEARCH) will show the next screen. (The buttons to be used may differ depending on the disc. For operation, refer to the jacket of the disc.)
- To return to the menu screen, press TITLE, MENU or RETURN during play of DVDs or press RETURN during play of Video CDs. (The buttons to be used may differ depending on the disc.)
- When  appears on the TV monitor when a button is being operated, it means that the corresponding operation is not available by the player or the disc.
- The PLAY/DISPLAY button of the main unit functions both as a PLAY button and a DISPLAY button (for displaying the On-Screen Menu Icons). If the button is pressed in the stop mode, playback will start and if pressed during play, the On-Screen Menu Icons will be displayed.

Before enjoying DVD/Video CD/CD

The On-Screen Menu language of your player has been factory preset to English. If you would like to change the menu language to French or Spanish, please refer to "When '3 Menu Language' is selected" on page 58.

1 Press PLAY.

- In the case of the main unit, press PLAY/DISPLAY.
(Playback starts.)

Example:

Interactive DVD

TITLE MENU	
Dogs	Castles
Lovers	Birds

Example:

Video CD with playback control

1	EAST ASIA
2	SOUTH ASIA
3	MIDDLE EAST
4	AFRICA
5	EUROPE

■ When a menu screen appears on the TV monitor

In the case of most of the interactive DVDs or Video CDs with playback control, a menu screen appears on the TV monitor.

- For DVD, perform steps 2 and 3 to select the preferred item and start playback.
- For Video CD, press the numeric buttons of the remote control unit to select the item and start playback.

2 Select the preferred item by pressing ▲▼◀▶.

- In the case of the main unit, select the item using the joystick.

Example: DVD

When "Birds" is selected

TITLE MENU	
Dogs	Castles
Lovers	Birds

3 Press SELECT.

(Play of the selected item now starts.)

Notes:

- During playback of some discs, a message such as "Press the play button to start play" may appear. In such a case, press SELECT instead of PLAY/DISPLAY, since if PLAY/DISPLAY of the main unit is pressed during play, the On-Screen Menu icons will appear.
- If the disc is placed in upside down (and it is a single sided disc), the display window will indicate "NO DISC".

■ After operation

When the player is not in use, to save power, set the player to the standby mode by pressing the POWER button (in the case of the main unit, slide the POWER switch to the OFF position). The player will automatically be switched to the standby mode after approx. 15 minutes have elapsed in the stop mode (Auto power-off function).

Basic play

Stopping play

Press **STOP** during play.

RESUME function:

When play is stopped, the player records the point where **STOP** was pressed.

DVD, **VCD** or **CD** mark flashes on the display window when this function is activated.

Press **PLAY** (in the case of the main unit, **PLAY/DISPLAY**) again, and play will resume from this point.

- When the disc lid is opened or **STOP** is pressed again, the **RESUME** function will be cleared.
- This feature will not be cleared when the power is turned **OFF** and then turned back **ON**.
- The **RESUME** function works only with discs for which the elapsed playing time appears on the display window during play.

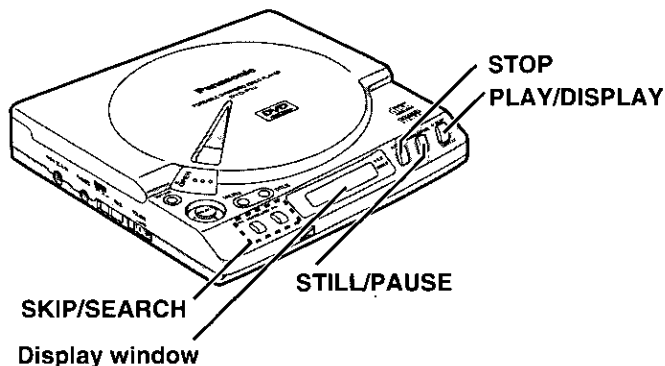
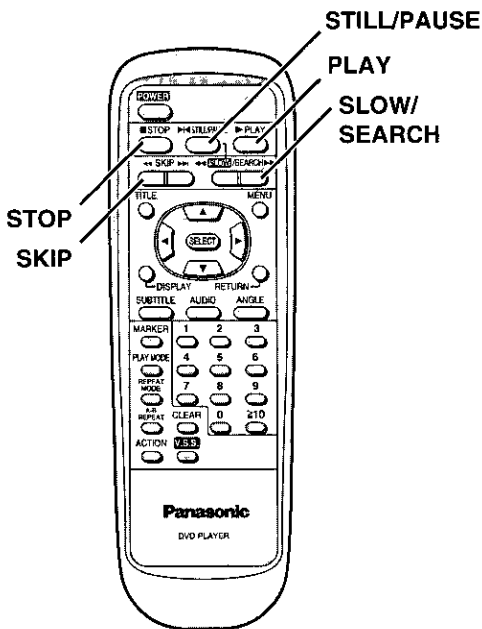

Rapid advance/ Rapid reverse

By the remote control unit

Press **SLOW/SEARCH** during play.

- ◀◀: Backward
- ▶▶: Forward

On the main unit

Keep **SKIP/SEARCH** pressed during play.

- ◀◀: Backward
- ▶▶: Forward

- The speed of rapid advance/rapid reverse becomes faster (up to 5 steps) as the button is kept pressed.
- The speed will be retained even after the button is released.

■ Returning to normal play

Press **PLAY** (in the case of the main unit, **PLAY/DISPLAY**).

■ Placing the player in the still picture/pause mode

Press **STILL/PAUSE**.

Note:

- Audio will be heard during rapid advance at step 1. (See page 62.)

For your reference:

- When **SLOW/SEARCH** (in the case of the main unit, **SKIP/SEARCH**) is pressed during menu play of Video CD with playback control, a menu screen may sometimes be recalled.

Skipping ahead or back

By the remote control unit

Press **SKIP** during play.

- ◀◀: Backward
- ▶▶: Forward

On the main unit

Tap **SKIP/SEARCH** during play.

- ◀◀: Backward
- ▶▶: Forward

- A chapter or a track is skipped each time the button is pressed.
- If ◀◀ **SKIP** (**SKIP/SEARCH**) is pressed once, the player returns to the beginning of the chapter/track being played back.

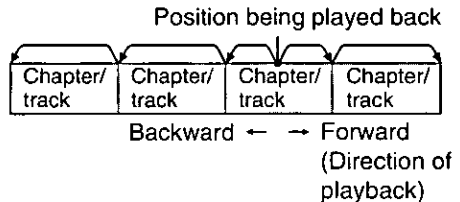

For your reference:

- When **SKIP** (in the case of the main unit, **SKIP/SEARCH**) is pressed during menu play of Video CD with playback control, a menu screen may sometimes be recalled.

Basic play

Still picture/Pause

Press **STILL/PAUSE** during play.

■ Returning to normal play

Press **PLAY** (in the case of the main unit, **PLAY/DISPLAY**).

Frame advance (DVD/Video CD only)

Press **STILL/PAUSE** in the still picture mode.

- The disc is advanced by one frame each time the button is pressed.
- When the button is continuously pressed, consecutive frame advance works.

■ Returning to normal play

Press **PLAY** (in the case of the main unit, **PLAY/DISPLAY**).

Note:

- Whether the pictures are advanced by a "frame" or "field" is automatic. (See page 63.)

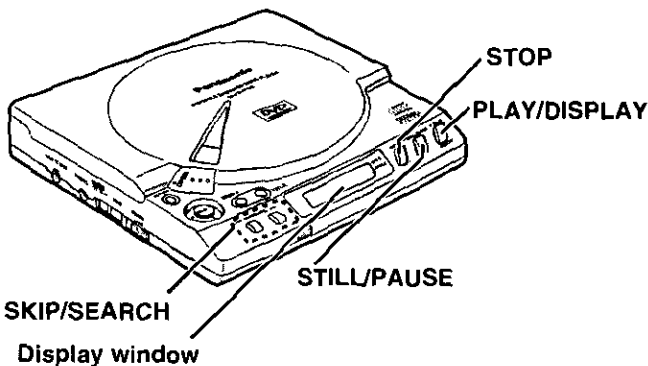
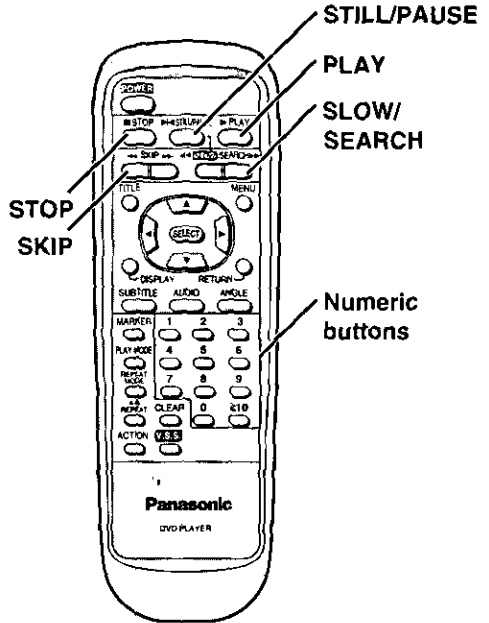

Slow-motion play
(DVD/Video CD only)

By the remote control unit

Press **SLOW/SEARCH** in the still picture mode.

- ◀◀: Backward
- ▶▶: Forward

On the main unit

Keep **SKIP/SEARCH** pressed in the still picture mode.

- ◀◀: Backward
- ▶▶: Forward

- The speed of slow-motion play becomes faster (up to 5 steps) as the button is continuously pressed.
- The speed will be retained even after the button is released.

■ **Returning to normal play**

Press **PLAY** (in the case of the main unit, **PLAY/DISPLAY**).

■ **Placing the player in the still picture/pause mode**

Press **STILL/PAUSE**.

For your reference:

- For Video CDs, slow-motion play in reverse direction is not possible.

Enjoying Video CD playback without using menus (Video CD only)

1 Press STOP after the menu screen appears.

("P b L" will be cleared from the display window.)

2 Select the preferred track number by pressing SKIP and press PLAY.

•In the case of the main unit, select the preferred track number by pressing **SKIP/SEARCH** and press **PLAY/DISPLAY**.
(Playback starts.)

- The numeric buttons of the remote control unit can also be used for entering the track numbers.
- Refer to the jacket etc. of the disc concerned for the track numbers.
- Select "track 1" to start play from the beginning of the disc.

■ **Returning to menu play**

Press **STOP** twice to stop playback, and press **PLAY** (in the case of the main unit, **PLAY/DISPLAY**).

("P b L" will appear on the display window and the menu appears on the TV monitor.) Select the preferred item using the numeric buttons.

For your reference:

- In these instructions, playback using the menu screen is referred to as "menu play" for Video CDs.

Operation using the On-Screen Menu Icons

This player features On-Screen Menu Icons showing disc information (title/chapter/track number, elapsed playing time, audio/subtitle language and angle) and player information (repeat play, marker and virtual surround sound); some icons show the indicated information and other icons allow the settings to be changed.

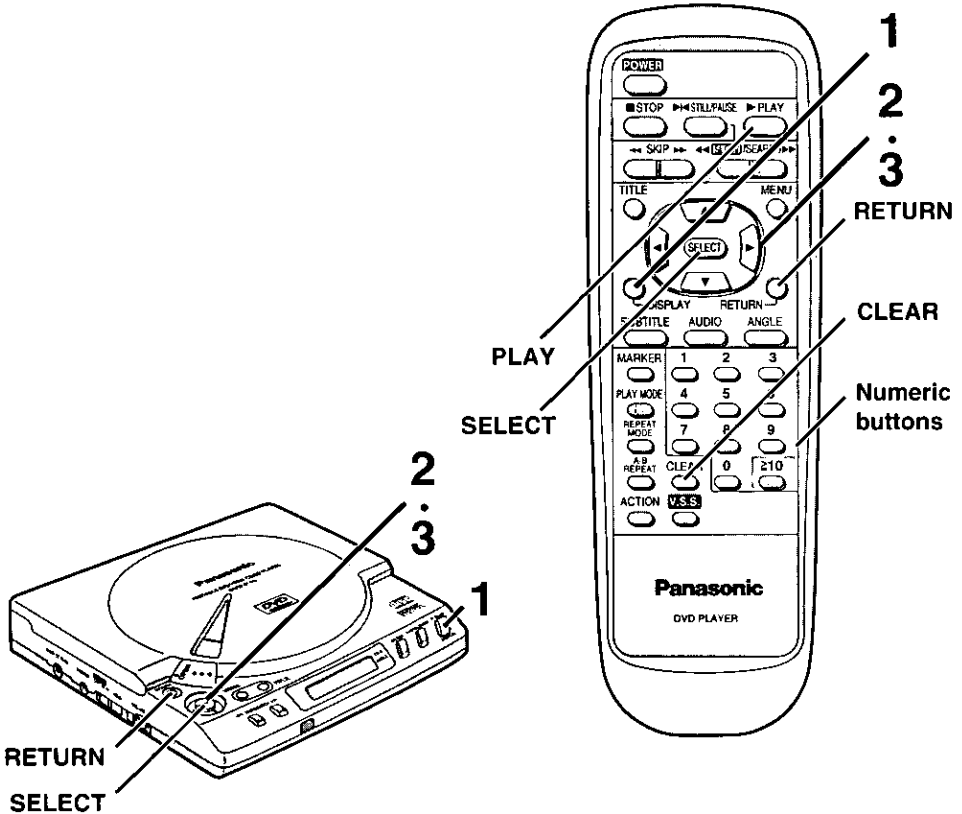

For your reference:

- On-Screen Menu Icons can also be cleared by pressing RETURN or CLEAR.
- The DISPLAY button of the remote control unit is effective to show the On-Screen Menu Icons even in the stop mode.
- The PLAY/DISPLAY button on the main unit functions both as a PLAY button and a DISPLAY button (for displaying the On-Screen Menu Icons). If the button is pressed during play, the On-Screen Menu Icons will be displayed and if pressed in the stop mode, playback will start.

1 Press DISPLAY during play.

- In the case of the main unit, press PLAY/DISPLAY.
(On-Screen Menu Icons is displayed.)
- Each time the button is pressed, the TV monitor changes as shown in the right.
- The screens may differ depending on the disc contents.

Example: DVD

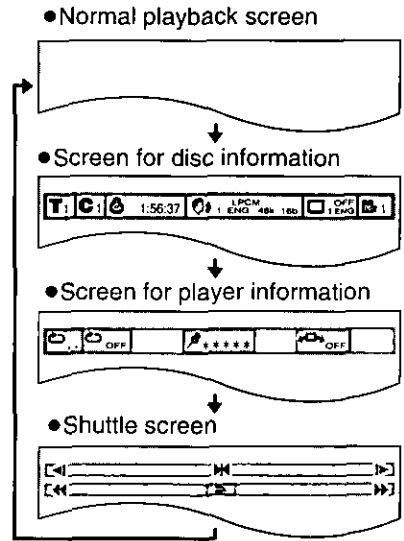

2 Select the preferred item by pressing ◀▶.

- In the case of the main unit, select the item using the joystick.
(The currently selected item is indicated by a yellow frame on the On-Screen Menu Icons.)

3 Select the preferred item by pressing ▲▼.

- In the case of the main unit, select the item using the joystick.
- When numbers are displayed (e.g. title No.), the numeric buttons of the remote control unit can also be used. When the numeric buttons are used, press SELECT to enter the selection.
- For some functions, the setting will be registered immediately; for others SELECT or PLAY (in the case of the main unit, SELECT or PLAY/DISPLAY) must be pressed. Some functions cannot be accessed from the stop mode.

• The PLAY/DISPLAY button on the main unit does not work during menu play of a Video CD with playback control. Press the DISPLAY button on the remote control unit to show the On-Screen Menu Icons.

• Depending on the type of the DVD software and the TV with automatic picture zoom function enabled, the On-Screen Menu Icons may not be displayed or only partially displayed on the TV screen. In this case, select the appropriate TV screen type by consulting the operating instruction manual for the TV.

Operation using the On-Screen Menu Icons

Detailed descriptions of each icon [Screen for disc information]

■ DVD

Title No. (See page 71.)	Change the title No. using the cursor buttons (joystick) [▲▼] or the numeric buttons and press SELECT.
------------------------------------	--

Chapter No. (See page 71.)	Change the chapter No. using the cursor buttons (joystick) [▲▼] or the numeric buttons and press SELECT.
--------------------------------------	--

Elapsed playing time (hour: minute: second)	Change the time using the numeric buttons and press SELECT. Example: To specify "1 hour 56 min. 37 sec.", enter "15637". (This function does not work with some discs.)
---	---

Angle No. (See page 47.)	Change the angle No. using the cursor buttons (joystick) [▲▼] or the numeric buttons.
------------------------------------	---



Audio soundtrack language No. (See page 45.)	Change the No. using the cursor buttons (joystick) [▲▼] or the numeric buttons.
--	---

Audio soundtrack language	ENG: English	RUS: Russian
	ITA: Italian	KOR: Korean
	SVE: Swedish	THA: Thai
	POR: Portuguese	DEU: German
	CHI: Chinese	NLD: Dutch
	VIE: Vietnamese	DAN: Danish
	FRA: French	JPN: Japanese
	ESP: Spanish	MAL: Malay
	NOR: Norwegian	*: Others

Subtitle language No. (See page 46.)	Change the No. using the cursor buttons (joystick) [▲▼] or the numeric buttons.
--	---

Subtitle language	ENG: English	RUS: Russian
	ITA: Italian	KOR: Korean
	SVE: Swedish	THA: Thai
	POR: Portuguese	DEU: German
	CHI: Chinese	NLD: Dutch
	VIE: Vietnamese	DAN: Danish
	FRA: French	JPN: Japanese
	ESP: Spanish	MAL: Malay
	NOR: Norwegian	*: Others

Audio attribute	LPCM	96k	16b	Linear PCM ("k" stands for kHz and "b" stands for bit.)
		or	20b	
		48k	24b	
	VOCAL	□□	1-5.1ch	Dolby Digital (AC-3)
		---	(OFF)	DVD Karaoke
			ON	1 vocal
VOCAL	---	(OFF)	DVD Karaoke	
		V1	2 vocals	
		V2		
		V1+V2		

Subtitle on/off	Select "ON" or "OFF" using the cursor buttons (joystick) [▲▼].	
	OFF	Subtitle is cleared.
	ON	Subtitle is displayed.

■ Video CD/CD

Track No.
(See page 71.)

Change the track No. using the cursor buttons (joystick) [▲▼] or the numeric buttons and press SELECT.
(The track No. cannot be changed during menu play of Video CDs with playback control.)

Elapsed playing time (minute: second)

Playback control (Video CD only)	OFF	Menu play is not ON.
	ON	Menu play is ON.

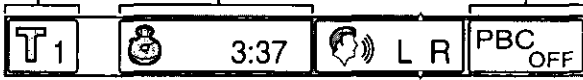

Audio mode (Video CD only) (See page 45.)	Change the mode using the cursor buttons (joystick) [▲▼].	
	LR	Audio channels L+R
	L	Audio channel L
	R	Audio channel R

For your reference:

- In the case of the main unit, the items can be changed using the joystick instead of the cursor buttons.
- “▲▼” around the icon means that the item can be changed using the cursor buttons (joystick) [▲▼].



- Track No. and the elapsed playing time are not displayed during menu play of Video CDs with playback control.
- It is not possible to turn playback control ON or OFF using the On-Screen Menu Icons.

Operation using the On-Screen Menu Icons

Detailed descriptions of each icon [Screen for player information]

A-B repeat play (See page 39.)

Press SELECT during play to store location A and press SELECT again to store location B and to start repeat play between the specified two locations. Press SELECT again to return to normal play.

Repeat play (See page 38.)

Select the preferred repeat mode during play using the cursor buttons (joystick) [▲▼].

OFF	Normal play	DVD
C	Chapter repeat play	
T	Title repeat play	
OFF	Normal play	Video CD CD
T	Track repeat play	
A	Disc repeat play	

Play mode

(Video CD/CD only)
(See pages 42–44.)

PRG	Program play
RND	Random play
---	Normal play

Virtual Surround Sound (V.S.S.)

(DVD only)
(See page 50.)

Select the preferred mode during play using the cursor buttons (joystick) [▲▼].

OFF	V.S.S. off
1	V.S.S. natural effect
2	V.S.S. emphasized effect



Marker

(See pages 40
and 41.)

Press SELECT during play and press SELECT again at the preferred point to store a marker. (Marker no. is displayed instead of “*”).

- To recall a marker, select the preferred marker no. using the cursor buttons (joystick) [◀▶] and enter the selection using the cursor button (joystick) [▲].
- To clear a marker, select the preferred marker no. using the cursor buttons (joystick) [◀▶] and press CLEAR.

Detailed descriptions of each icon [Shuttle screen]

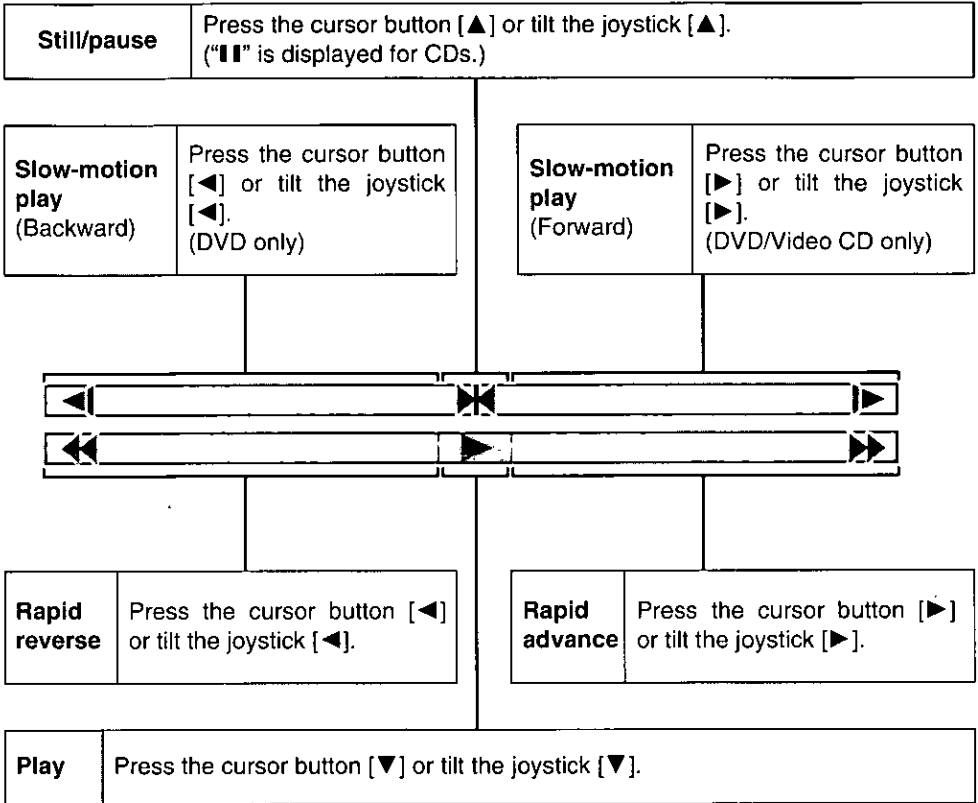

For your reference:

- In the case of the main unit, the items can be changed using the joystick instead of the cursor buttons.
- A-B repeat play, repeat play and marker functions do not work with interactive DVDs or during menu play of Video CDs with playback control.
- It is not possible to change the play mode using the On-Screen Menu Icons.
- The speed of rapid reverse, rapid advance and slow-motion play changes up to 5 steps each time the cursor button is pressed or the joystick is tilted.

Repeat play

Repeat viewing (listening)

Press **REPEAT MODE** during play.

(Each time this button is pressed, the TV monitor changes as shown below and the selected repeat play starts.)

■ DVD

- Repeat of chapter being played
- Repeat of title being played
- Cancel repeat mode

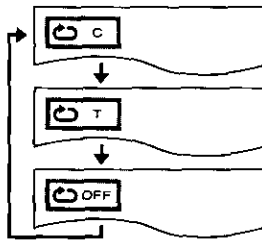

■ Video CD/CD

- Repeat of track being played
- Repeat of entire disc contents
- Cancel repeat mode

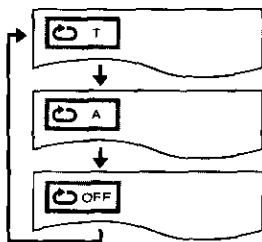

■ Returning to normal play

Normal play starts when approx. 5 seconds have elapsed after "OFF" is displayed.

REPEAT
MODE

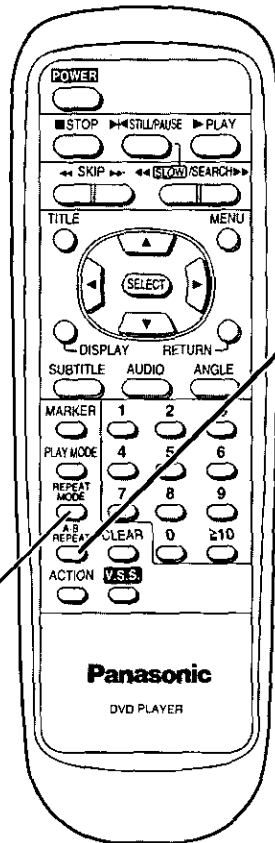

For your reference:

- Repeat play and A-B repeat play may not work correctly with some DVDs.
- Repeat play and A-B repeat play do not work with discs for which the elapsed playing time does not appear on the display window during play.
- A-B repeat play works only within a title [DVD] or a track [Video CD/CD].
- Some subtitles recorded around location A or B may fail to appear.
- If the title/track is completed before end location B is specified, the end point of the title/track serves as end location B.

Repeating sections between two specific points (A-B repeat)

1 Press A-B REPEAT during play.
(Starting location A is specified.)

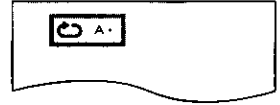

2 Press A-B REPEAT again.
(End location B is specified and repeat play between locations A and B starts.)

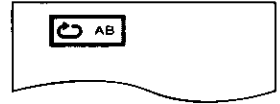

Returning to normal play

Press A-B REPEAT again to display "↻ ••"; A-B repeat play is cancelled and normal play starts.

Additional operation

Starting repeat play during program play

Press REPEAT MODE during program play (see page 42). (Each time this button is pressed, the TV monitor changes as shown below and the selected program repeat play starts.)

- Repeat of track being played
- Repeat of all programs
- Cancel repeat mode

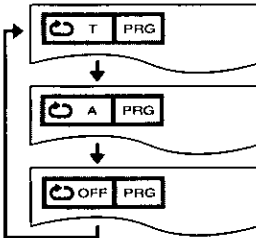

(When approx. 5 seconds have elapsed after "↻ OFF" is displayed, program play is resumed.)

For your reference

Chapter/Title repeat play (DVD)

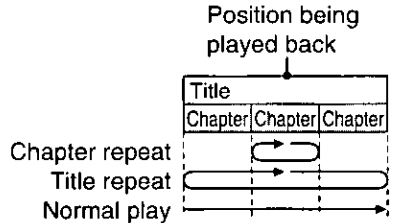

Track/Disc repeat play (Video CD/CD)

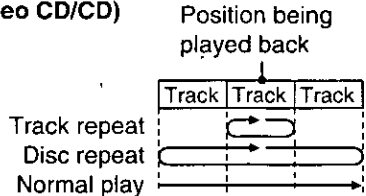

A-B repeat play

Starting location A End location B



Storing markers in memory to be viewed (heard) again

It is possible to store the starting point to be viewed (heard) again and to start playback from that point.

Storing a marker in memory

- 1 Press MARKER during play.**
(The marker screen is displayed.)

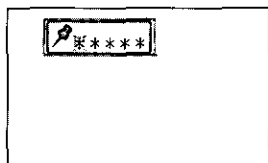

- "*" indicates no starting point has been stored yet at the corresponding marker number.

- 2 Press SELECT at the starting point to be viewed (heard) again.**
(The marker number is displayed.)

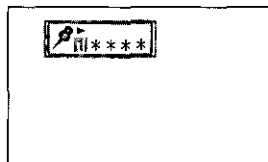

- Up to 5 markers can be stored in memory.
- If SELECT is pressed where any number is already displayed, the previous starting point will be replaced by the new one.

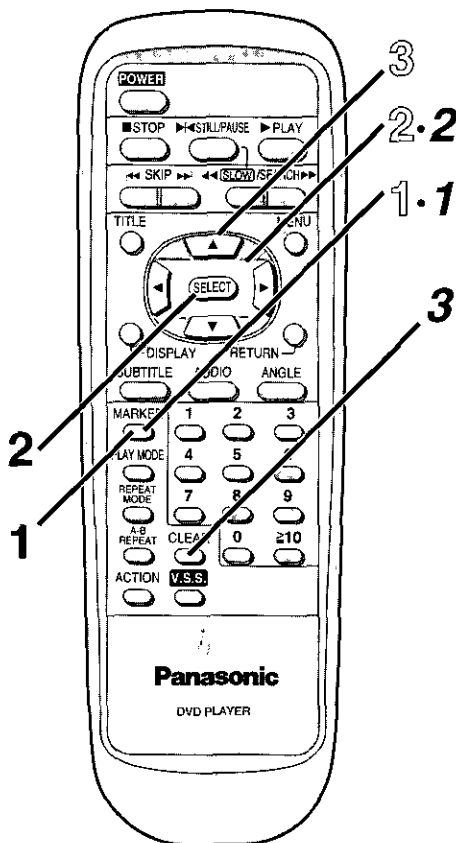

For your reference:

- Some subtitles recorded around the marker may fail to appear.
- These operations do not work with DVDs for which the elapsed playing time does not appear on the display window during play or during menu play of Video CDs.
- All the markers are retained in memory until the power is turned off or the disc is removed.

Recalling a marker

- 1** Press **MARKER** during play if the marker screen is not displayed.
(The marker screen is displayed.)

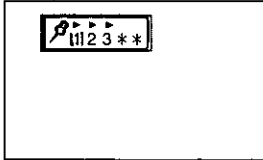
**Clearing a marker**

- 1** Press **MARKER** during play if the marker screen is not displayed.
(The marker screen is displayed.)

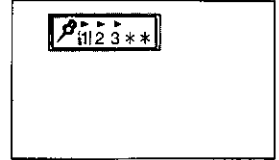

- 2** Select the marker number by pressing **◀▶**.

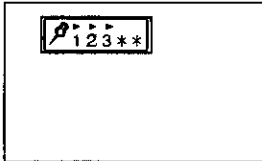

- 2** Select the marker number by pressing **◀▶**.

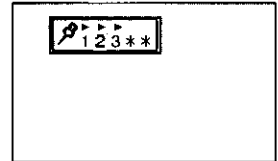

- 3** Press **▲**.
(Playback starts from the point corresponding to the selected marker.)

- 3** Press **CLEAR**.
(The selected marker is cleared.)

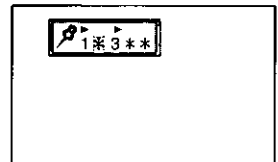

Program play

For Video CDs and CDs, the player plays the tracks on the disc in an order you specify.

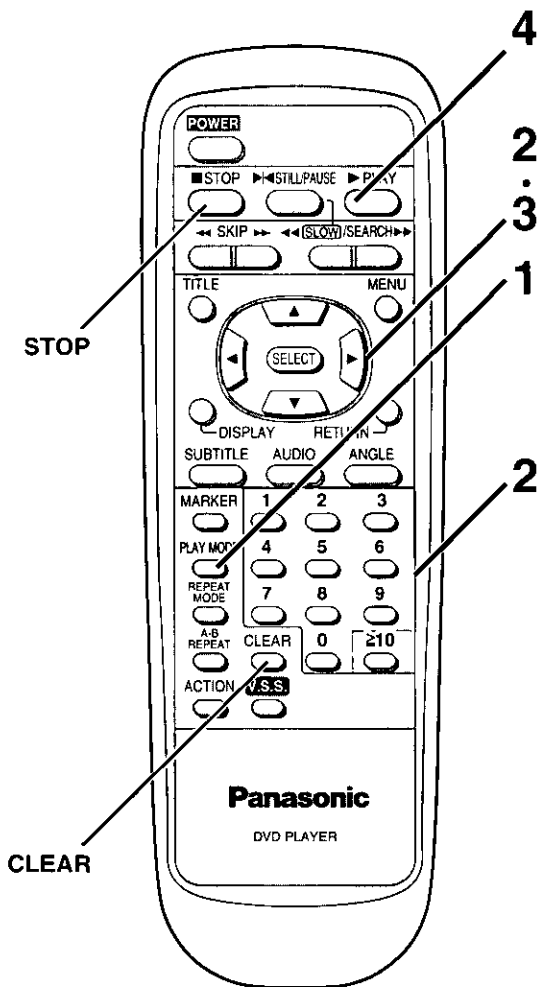

■ After playback of all programs

Play stops and the program playback screen is displayed.

■ Returning to normal play

Press STOP to stop program play, and then press PLAY MODE twice. When PLAY is pressed, normal play starts from the beginning of the disc. (The contents of the program are still retained in memory.)

1 Press PLAY MODE once in the stop mode.
 (The program playback screen is displayed.)

- To exit the screen
 Press PLAY MODE twice.

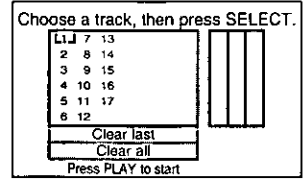

2 Select the preferred track number by pressing ▲▼◀▶ or the numeric buttons.

- When the number is selected using the numeric buttons, step 3 is not necessary.

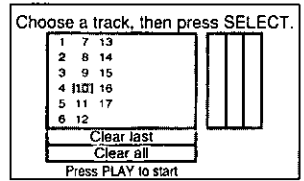

3 Press SELECT.
 (The selected track is stored in memory.)

- Repeat steps 2 and 3 to select another track.
- Up to 18 tracks can be programmed.

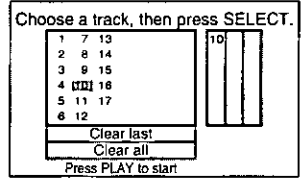

4 Press PLAY.
 (Play now begins in the programmed sequence.)

■ Clearing a program one by one
 Press STOP twice to display the program playback screen. Each time CLEAR is pressed, the last program is cancelled. Selecting "Clear last" using the cursor buttons and pressing SELECT also clears the last program.

■ Clearing all the programs
 The programs are cleared when power is turned off or the disc is removed. Selecting "Clear all" using the cursor buttons and pressing SELECT also clears all the programs.

For Video CDs and CDs, the player plays the tracks on the disc in random order.

1 Press **PLAY MODE** twice in the stop mode.

(The random playback screen is displayed.)

- **To exit the screen**
Press **PLAY MODE** once.

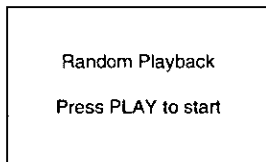

2 Press **PLAY**.

(Play now begins in random order.)

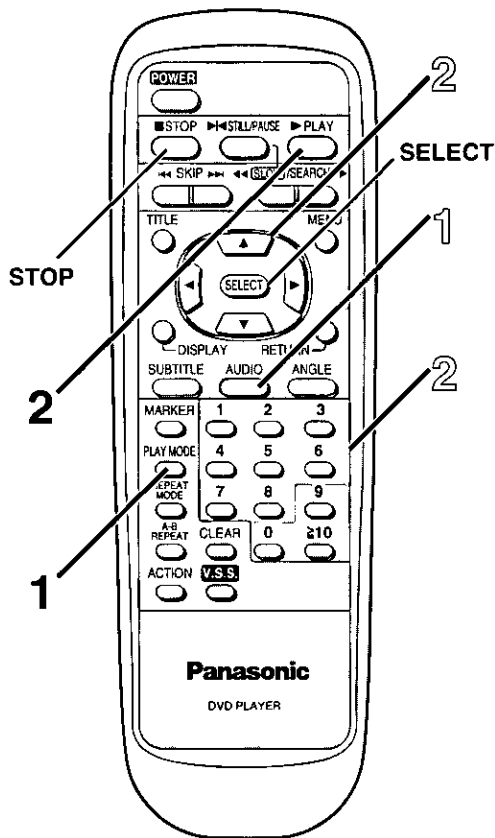

■ **After random play is finished**

Play stops and the random playback screen is displayed.

■ **Returning to normal play**

Press **STOP** to stop random play, and then press **PLAY MODE** once.

Changing audio soundtrack language

(Multi-audio function)



It is possible to change the audio soundtrack language during play if multiple audio soundtrack languages are recorded on the disc.

- 1 Press AUDIO during play.**
(Number of the audio soundtrack language being played back is displayed.)

- When no audio soundtrack is recorded, “—” will be displayed instead of the language number.

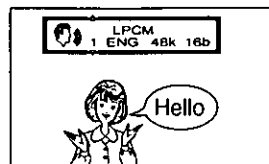

- 2 Select the preferred language by pressing ▲▼ or the numeric buttons (1–8).**

- Press AUDIO or SELECT to clear the display.



For your reference:

- When the preferred language is not selected even after pressing the cursor buttons several times, it means that the language is not available on the disc.
- When the power is turned on or the disc is removed, the language heard is the one selected at the initial settings (see page 52). If this language is not recorded on the disc, the language specified by the disc will be heard.

Additional operation DVD VCD

■ Switching vocals ON or OFF for Karaoke discs

Press AUDIO during play of Karaoke discs.

- Press AUDIO again to clear the display.
- It is not possible to switch vocals ON or OFF for CDs.
- DVD Karaoke (1 vocal)**
“...” (OFF) or “ON” of vocals can be selected by pressing ◀▶.
- DVD Karaoke (2 vocals)**
“...” (OFF), “1+2” (ON), “V1” (ON) or “V2” (ON) of vocals can be selected by pressing ◀▶.
- Video CD**
“LR”, “L” or “R” can be selected by pressing ▲▼.

Changing subtitle language (Multi-subtitle function)



It is possible to change the subtitle language during play if the multiple subtitle languages are recorded on the disc.

1 Press **SUBTITLE** during play.

(Number of the subtitle language being played back is displayed.)

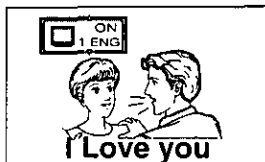

- When no subtitles are recorded “-” will be displayed instead of the language number.

2 Select the preferred language by pressing **▲▼** or the numeric buttons (1-0, ≥ 10).



- Press **SUBTITLE** or **SELECT** to clear the display.

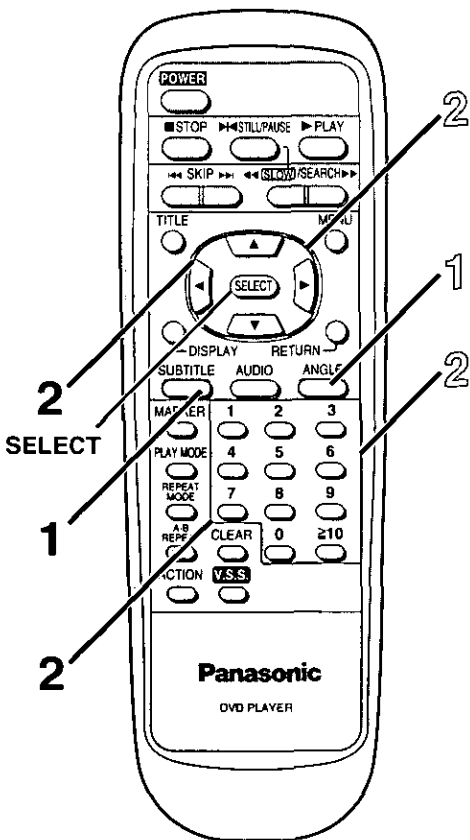

For your reference:

- When the preferred language is not selected even if pressing the cursor buttons several times, it means that the language is not available on the disc.
- When the power is turned on or the disc is removed, subtitles appear in the language selected at the initial settings (see page 52). If this language is not recorded on the disc, the language specified by the disc will be displayed.
- In some cases, the subtitle language is not changed to the selected one immediately.

Note:

- When a disc supporting the closed caption is played, the subtitle and the closed caption may overlap each other on the TV monitor. In this case, turn the subtitle off.

Additional operation

■ Clearing/Displaying the subtitles

“OFF” or “ON” of subtitles can be selected by pressing **◀▶**.

Viewing from another angle (Multi-angle function)



For DVDs which contain scenes which have been shot simultaneously from a number of different angles the same scene can be viewed from each of these different angles during play.

- 1 Press ANGLE during play.**
(Number of angle being played back is displayed.)

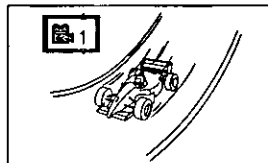

- 2 Select the preferred angle by pressing ▲▼ or the numeric buttons (1–9).**

- Press ANGLE or SELECT to clear the display.

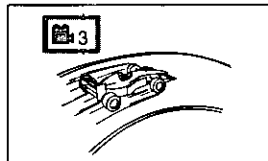

For your reference:

- This function only works for discs having scenes recorded at different angles.
- The angle indicator lights up on the display window at the scenes recorded at different angles to indicate that angle switching is possible.
- The angle number can be programmed beforehand; the angle will be switched to the selected number when the angle indicator lights up.

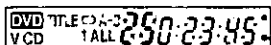

Angle indicator

Using a menu

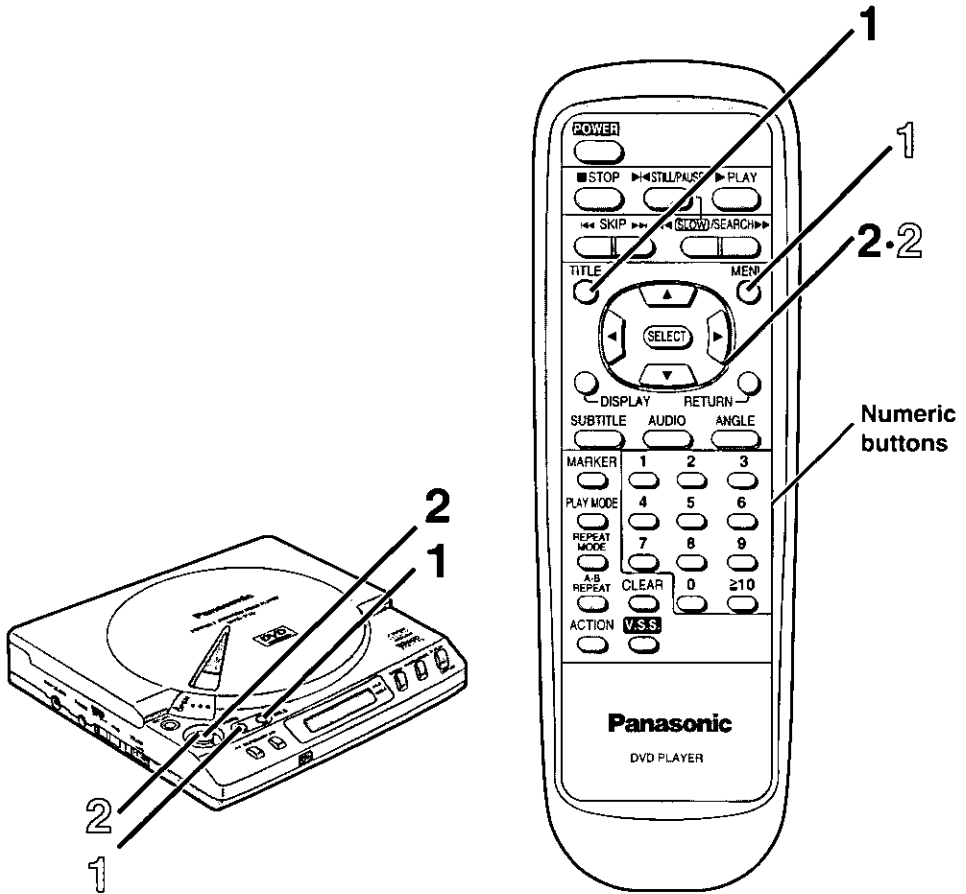

For your reference:

■ Title menu

If the DVD has multiple titles recorded on it, it is possible to select the preferred title from the title menu to start playback.

■ DVD menu

Some DVDs have unique menu structures called DVD menus. For example, DVDs programmed with complex contents provide guide menus, and those recorded with various languages provide menus for audio and subtitle languages. These menus are called "DVD menu". Although the DVD menu's contents and operation differ from disc to disc, the following explains basic operation when this feature is used.

Using a title menu

1 Press TITLE during play. (The title menu is displayed.)

- Pressing TITLE again resumes play from the scene when the title menu was first displayed.

Example:

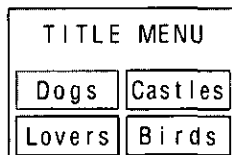

2 Select the preferred title by pressing ▲▼◀▶ and press SELECT.

- In the case of the main unit, select the item using the joystick.
- The numeric buttons can be used for selecting the items for some discs.

Using a DVD menu

1 Press MENU during play. (The DVD menu is displayed.)

- Pressing MENU again resumes play from the scene when the DVD menu was first displayed.

Example:

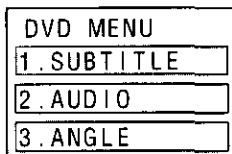

2 Select the preferred item by pressing ▲▼◀▶ and press SELECT.

- In the case of the main unit, select the item using the joystick.
- The numeric buttons can be used for selecting the items for some discs.
- To display the menu screen one after another, repeat step 2.

Reproducing a Virtual Surround Sound (V.S.S.) effect

DVD

This player can reproduce a virtual surround sound effect which reproduces a sound as if heard from non-existent rear speakers even when only a 2-channel stereo system is connected [for playback of Dolby Digital (AC-3)/5.1ch DVD software only].

Press V.S.S. (VIRTUAL SURROUND SOUND) during play.

(Each time this button is pressed, the display window changes as shown below.)

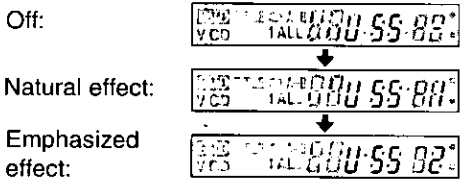

For your reference:

- This function works only with DVDs recorded in Dolby Digital (AC-3)/5.1ch surround. (The V.S.S. indicator is displayed on the display window.)

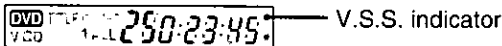

- The virtual surround sound effect may not work properly for some DVD software.
- When the player is connected to a TV set with surround effect, turn off the surround effect other than this virtual surround sound effect.
- For optimum effect, it is recommended that the distance between the TV set and the listening position be about 3 or 4 times the distance between the right and left front speakers.

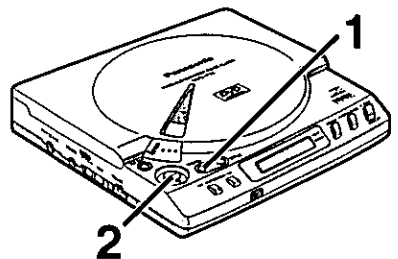
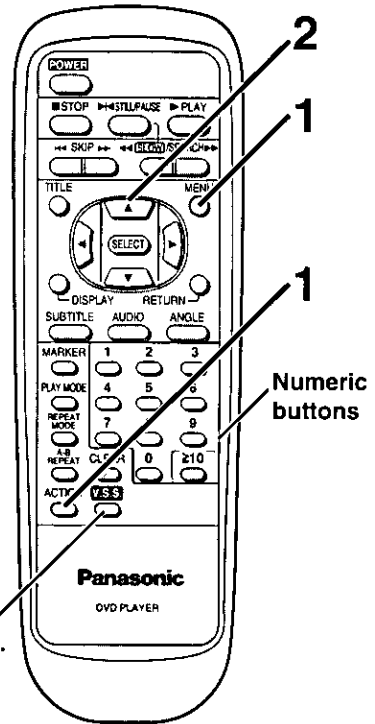
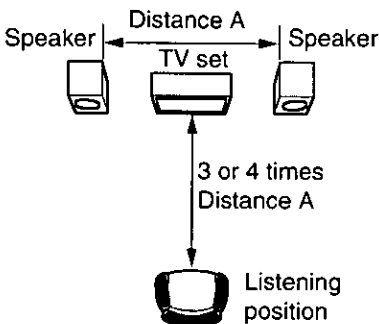

Changing the initial settings

The initial settings (factory settings) can be changed. For example, the audio soundtrack language can be changed to French by changing the setting at "1 Disc Languages". (The settings will be retained in memory, until the settings are changed, even after turning the power off.)

1 Press ACTION or MENU in the stop mode.

- In the case of the main unit, press MENU. (The initial settings screen is displayed.)

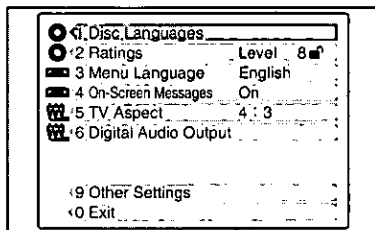

2 Select the preferred item by pressing ▲ ▼ and press SELECT.

- In the case of the main unit, select the item using the joystick.

1 Disc Languages (See page 52)

This is to select the audio soundtrack language, subtitle language and the language used in the menus. (If the language selected is not available on the disc, the language designated by each disc will be selected.)

2 Ratings (See page 54)

This is to disable the playing of DVDs which are unsuitable for children. Some discs may not be encoded with specific rating level information though its disc jacket says that it is for "adults". For those discs, the age restriction will not work. It is possible to prohibit playback of all DVDs.

3 Menu Language (See page 58)

This is to select the language used for the initial settings screen or for On-Screen Display messages such as "Play".

4 On-Screen Messages (See page 59)

This is to select whether On-Screen Display messages such as "Play" will be displayed or not.

5 TV Aspect (See page 59)

This is to select the appropriate TV aspect (4:3 or 16:9) according to the connected TV set.

6 Digital Audio Output (See page 60)

This is to select the audio type to be output from the audio output/optical digital audio output connector.

9 Other Settings (See page 62)

This is to make other settings such as dynamic range compression.

For your reference:

- The numeric buttons can also be used for selecting the items. (In this case, pressing SELECT is not necessary.)
- When the MENU button of the remote control unit is pressed during play, the DVD menu will be displayed and if pressed in the stop mode, the initial settings screen will be displayed.

Notes:

- There are no No. 7 and 8 items of the initial setting in this player.
- After the player is set to the "Lock All" setting in "2 Ratings", none of the initial settings, including "2 Ratings", can be changed if the DVD disc is left inside the player. In this case, remove the disc, and unlock the player.

Changing the initial settings

When "1 Disc Languages" is selected

See page 51 for steps 1 and 2.

3 Select the preferred item by pressing ▲▼ and press SELECT.

- In the case of the main unit, select the item using the joystick.

1 Audio

This is to select the audio soundtrack language heard from the speakers.

2 Subtitle

This is to select the subtitle language displayed on the screen.

3 Menus

This is to select the language used in the menus recorded on the discs such as title menus.

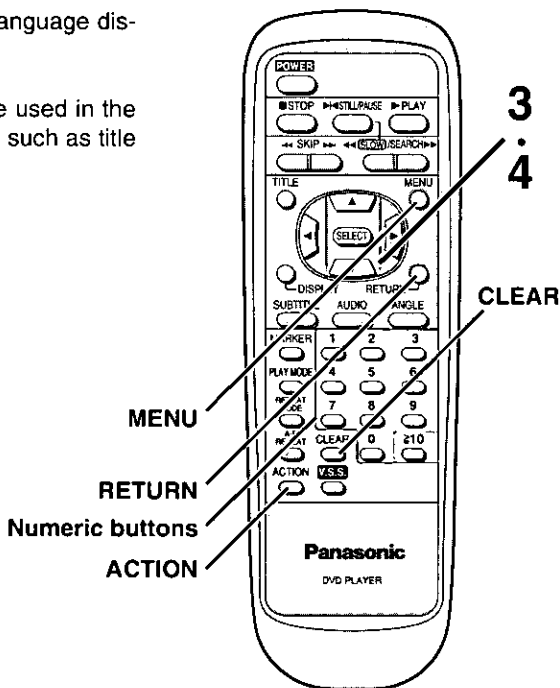
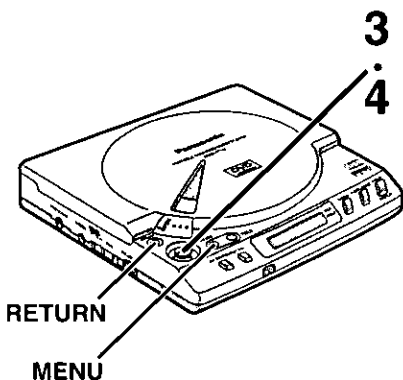
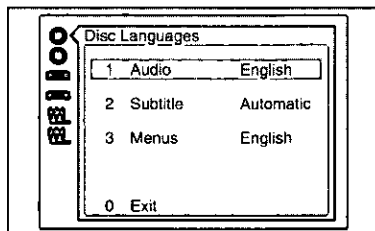

For your reference:

- The numeric buttons can also be used for selecting the items. (In this case, pressing SELECT is not necessary.)
- **Returning to the previous menu**
Press RETURN.
- **Finishing the initial settings**
Press ACTION, MENU or "0" at the initial settings screen illustrated in step 1 on page 51. (In the case of the main unit, press MENU.)

4 Select the preferred item by pressing ▲▼ and press SELECT.

- In the case of the main unit, select the item using the joystick.

■ When "1 Audio" is selected

1 English (Factory preset)

English will be selected as audio soundtrack language.

2 French/3 Spanish

Each language will be selected as audio soundtrack language.

4 Original

The top-priority language recorded on each disc will be selected as audio soundtrack language.

5 Other ****

Another language will be selected as audio soundtrack language.

Enter the 4-digit language code (see page 64) using the numeric buttons.

Press CLEAR if an incorrect language code is entered.

■ When "2 Subtitle" is selected

1 Automatic (Factory preset)

Subtitle language will automatically be selected in accordance with the audio soundtrack language.

● If the language selected for the "1 Audio" is actually used during play, the subtitles will not appear.

● If another language is used during play, the subtitles will appear in the language selected at "1 Audio".

2 English/3 French/4 Spanish

Each language will be selected as subtitle language.

5 Other ****

Another language will be selected as subtitle language.

Enter the 4-digit language code (see page 64) using the numeric buttons.

Press CLEAR if an incorrect language code is entered.

■ When "3 Menus" is selected

1 English (Factory preset)

English will be selected as disc menu language.

2 French/3 Spanish

Each language will be selected as disc menu language.

4 Other ****

Another language will be selected as disc menu language.

Enter the 4-digit language code (see page 64) using the numeric buttons.

Press CLEAR if an incorrect language code is entered.

(Setting is finished and the screen illustrated in step 3 is displayed.)

Changing the initial settings

When "2 Ratings" is selected

When playback is not restricted (Level 8)

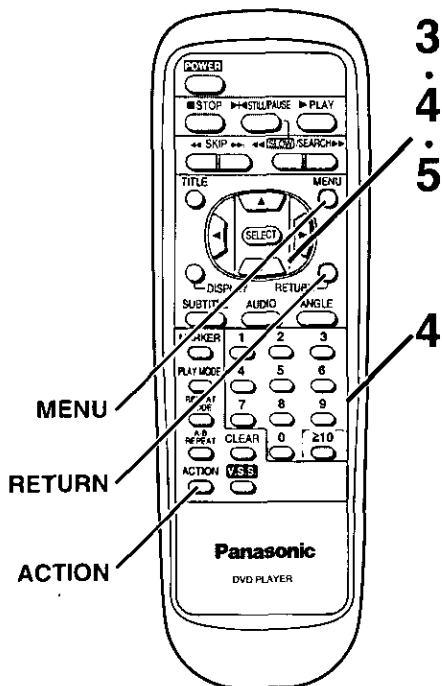
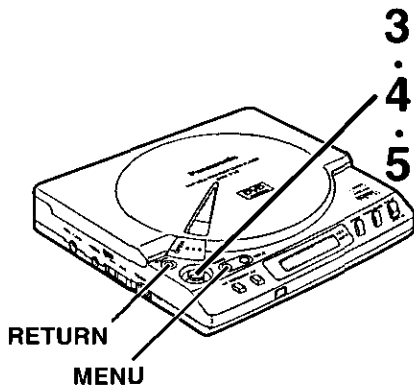

Notes:

- Do not forget your password.
- When the rating is locked, the settings cannot be changed unless the correct password is entered.

For your reference:

- The numeric buttons can also be used for selecting the items. (In this case, pressing SELECT is not necessary.)
- **Returning to the previous menu**
Press RETURN.
- **Finishing the initial settings**
Press ACTION, MENU or "0" at the initial settings screen illustrated in step 1 on page 51. (In the case of the main unit, press MENU.)

See page 51 for steps 1 and 2.

3 Select the preferred level by pressing ▲▼ and press SELECT.

- In the case of the main unit, select the item using the joystick.

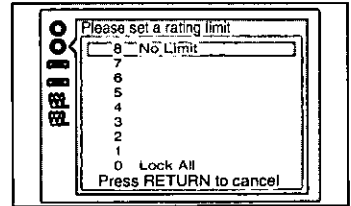

■ Level 8 (Factory preset)

All DVDs (for adults/general audiences/children) can be played back.

■ Level 7–Level 2

DVDs for general audiences/children can be played back. (DVDs for adults are prohibited.)

■ Level 1

DVDs for children can be played back. (DVDs for adults/general audiences are prohibited.)

■ Level 0

Playback of all DVDs is prohibited (e.g. to prohibit playback of DVDs for adults which are not encoded with rating level information).

4 When level 7 or lower is selected, Enter a 4-digit password by pressing the numeric buttons and press SELECT.

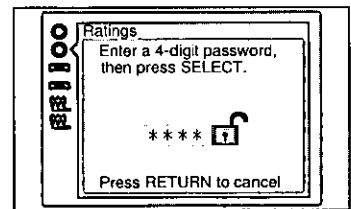

5 Press SELECT.



(Setting is finished and the screen illustrated in step 1 on page 51 is displayed.)

Changing the initial settings

When "2 Ratings" is selected

When playback is restricted (Level 0–Level 7)

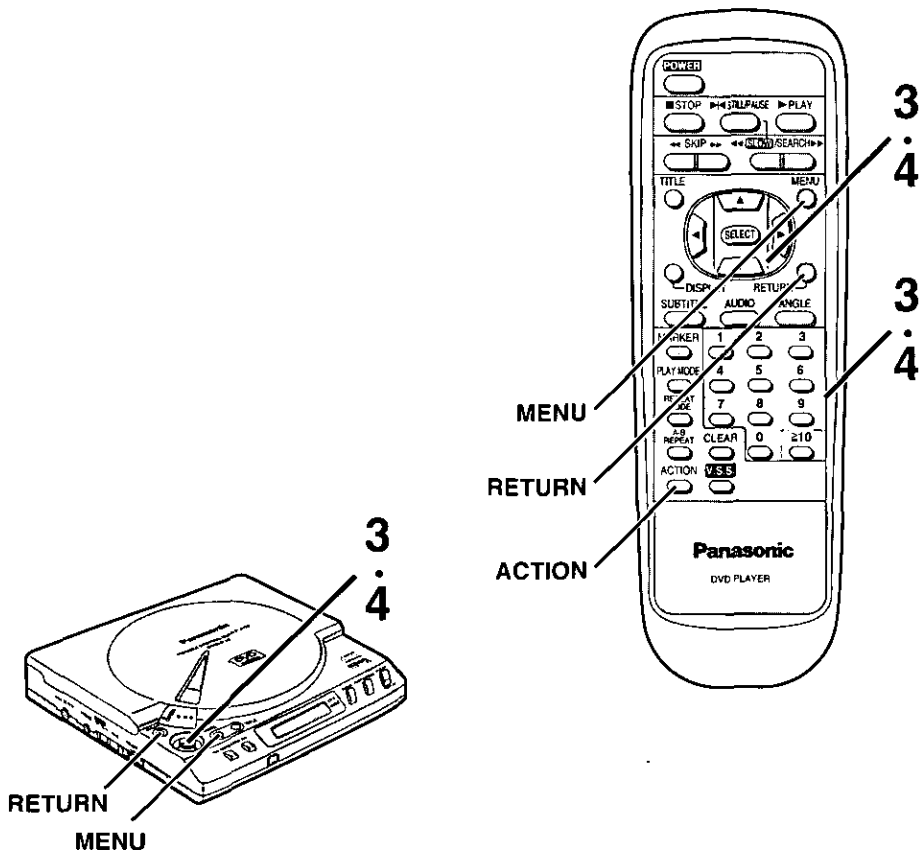

For your reference:

- In the case of the main unit, the items can be selected using the joystick instead of the cursor buttons.
- The numeric buttons can also be used for selecting the items. (In this case, pressing SELECT is not necessary.)
- **Returning to the previous menu**
Press RETURN.
- **Finishing the initial settings**
Press ACTION, MENU or "0" at the initial settings screen illustrated in step 1 on page 51. (In case of the main unit, press MENU.)

See page 51 for steps 1 and 2.

3 Enter the correct password by pressing the numeric buttons and press SELECT.

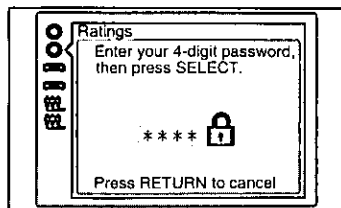

4 ■ To unlock the rating

1. Select "1 Unlock Player" by pressing ▲▼ and press SELECT.
2. Press SELECT.
(The screen illustrated in step 1 on page 51 is displayed.)

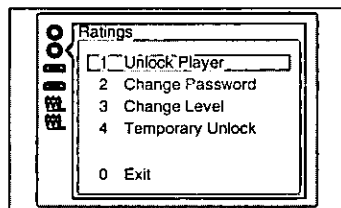

■ To change the password

1. Select "2 Change Password" by pressing ▲▼ and press SELECT.
2. Enter the password by pressing the numeric buttons and press SELECT.
3. Press SELECT.
(The screen illustrated in step 1 on page 51 is displayed.)

■ To change the rating level

1. Select "3 Change Level" by pressing ▲▼ and press SELECT.
2. Select the preferred level by pressing ▲▼ and press SELECT.
(The screen illustrated in step 1 on page 51 is displayed.)

■ To temporarily unlock the rating level

1. Select "4 Temporary Unlock" by pressing ▲▼ and press SELECT.
2. Press SELECT.
(The screen illustrated in step 1 on page 51 is displayed.)

•The player is unlocked only temporarily and will be locked again when the power is turned off or the disc is removed.

■ To finish the settings without changing the rating level

- Select "0 Exit" by pressing ▲▼ and press SELECT.
(The screen illustrated in step 1 on page 51 is displayed.)

Changing the initial settings

When **3 Menu Language** is selected

See page 51 for steps 1 and 2.

3 Select the preferred language by pressing ▲▼ and press SELECT.

- In the case of the main unit, select the item using the joystick.

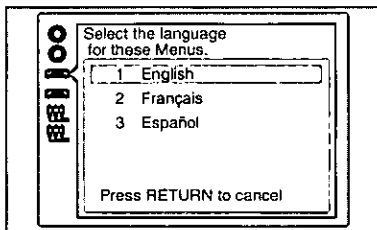

1 English (Factory preset)

English is selected as On-Screen Display language.

2 Français/3 Español

Each language is selected as On-Screen Display language.

(Setting is finished and the screen illustrated in step 1 on page 51 is displayed.)

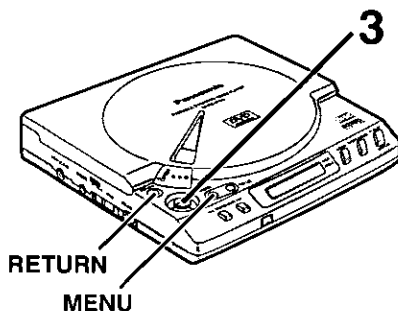
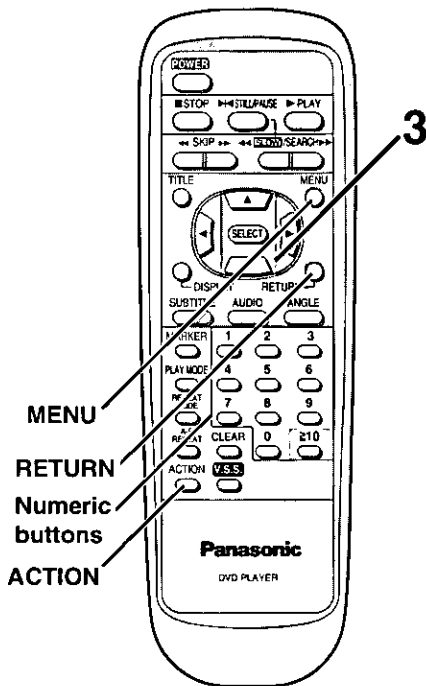

For your reference:

- The numeric buttons can also be used for selecting the items. (In this case, pressing SELECT is not necessary.)
- **Returning to the previous menu**
Press RETURN.
- **Finishing the initial settings**
Press ACTION, MENU or "0" at the initial settings screen illustrated in step 1 on page 51. (In the case of the main unit, press MENU.)

When "4 On-Screen Messages" is selected

See page 51 for steps 1 and 2.

3 Select "On" or "Off" by pressing ▲▼ and press SELECT.

- In the case of the main unit, select the item using the joystick.

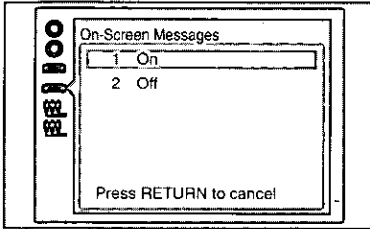

1 On (Factory preset)

On-Screen Display messages such as "Play" and "Still" will always be displayed on the screen.

2 Off

On-Screen Display messages such as "Play" and "Still" will not be displayed on the screen.

(Setting is finished and the screen illustrated in step 1 on page 51 is displayed.)

When "5 TV Aspect" is selected

See page 51 for steps 1 and 2.

3 Select the appropriate TV aspect by pressing ▲▼ and press SELECT.

- In the case of the main unit, select the item using the joystick.

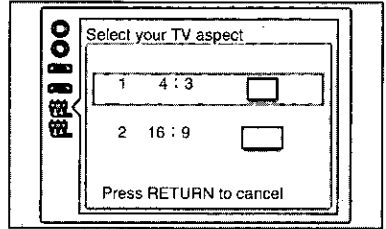

1 4:3 (Factory preset)

Select when a conventional TV set is connected.

•Video material for wide-screen formatted in the Pan & Scan style

Played back in the Pan & Scan style (the left and right edges are cut off)

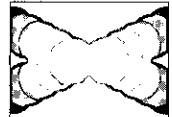

•Video material for wide-screen not formatted in the Pan & Scan style

Played back in the letterbox style (black bands appear at top and bottom of the screen)



2 16:9

Select when a wide-screen TV set is connected.

Video material for wide-screen is played back in "FULL" size.

(Setting the wide-screen TV to "FULL" mode is also necessary.)

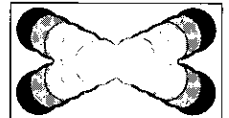

(Setting is finished and the screen illustrated in step 1 on page 51 is displayed.)

Changing the initial settings

When "6 Digital Audio Output" is selected

See page 51 for steps 1 and 2.

3 Select the preferred item by pressing ▲▼ and press SELECT.

• In the case of the main unit, select the item using the joystick.

1 LPCM (DVD)

This is to select whether Linear PCM audio converted to 48 kHz/16 bit will be output from the audio output/optical digital audio output connector during playback of the DVD recorded in Linear PCM.

2 Dolby Digital

This is to select the signal format (Bitstream or PCM) which will be output from the audio output/optical digital audio output connector during playback of the DVD recorded in Dolby Digital (AC-3).

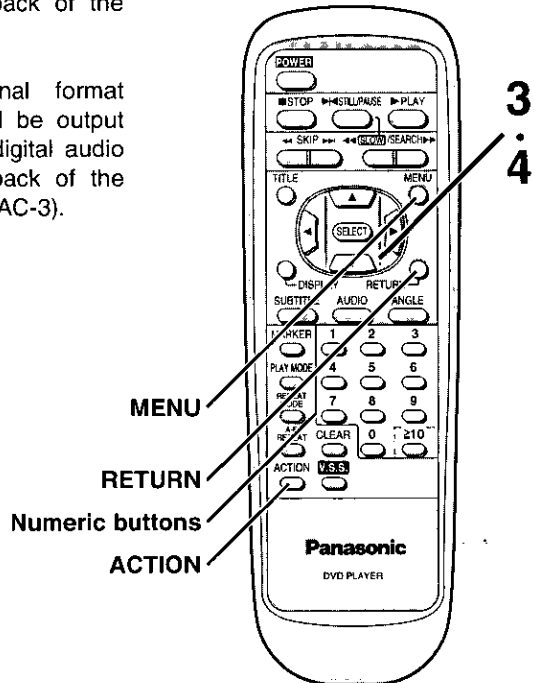
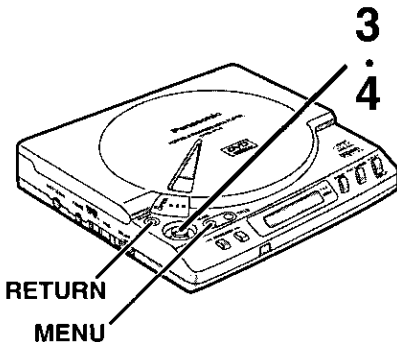
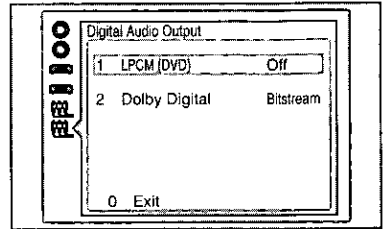

For your reference:

- The numeric buttons can also be used for selecting the items. (In this case, pressing SELECT is not necessary.)
- **Returning to the previous menu**
Press RETURN.
- **Finishing the initial settings**
Press ACTION, MENU or "0" at the initial settings screen illustrated in step 1 on page 51. (In the case of the main unit, press MENU.)

4 Select the preferred item by pressing ▲▼ and press SELECT.

• In the case of the main unit, select the item using the joystick.

■ When “1 LPCM (DVD)” is selected

1 Off (Factory preset)

Only Linear PCM of 48 kHz/16 bit digital audio is output.

During playback of the DVD recorded in Linear PCM of 48 kHz/20 bit/24 bit or 96 kHz, no digital audio is output.

2 PCM

During playback of the DVD recorded in Linear PCM of 48 kHz/20 bit/24 bit or 96 kHz, digital audio converted to 48 kHz/16 bit is output.

(Digital output of PCM audio is restricted to 48 kHz/16 bit or below for copyright protection.)

■ When “2 Dolby Digital” is selected

1 Bitstream (Factory preset)

Dolby Digital (AC-3) bitstream (1ch–5.1ch) will be output during playback of the DVD recorded in Dolby Digital (AC-3). Select this setting when the Dolby Digital (AC-3) decoder is connected.

2 PCM

PCM (2ch) converted to 48 kHz/16 bit will be output during playback of the DVD recorded in Dolby Digital (AC-3).

(Setting is finished and the screen illustrated in step 3 is displayed.)

■ Recommended setting of “Digital Audio Output”

Make settings as shown in table below depending on the type of equipment that is connected to the audio output/optical digital audio output connector using the optical digital audio cable.

Type of equipment to be connected	Recommended setting	
	LPCM (DVD)	Dolby Digital
No equipment is connected	Off (Factory preset)	Bitstream (Factory preset)
AV amplifier (with digital audio input connector) without Dolby Digital (AC-3) decoder	PCM*1	PCM*2
Dolby Digital (AC-3) decoder (See page 20.)	PCM*1	Bitstream (Factory preset)

*1 Audio output from the player's audio output/optical digital audio output connector is converted to 48 kHz/16 bit if the player is connected using the optical digital audio cable. To enjoy high quality sound at 48 kHz/20 bit/24 bit or 96 kHz, connect the amplifier or decoder to the audio output/optical digital audio output connector using the video/audio cable (supplied), not by the optical digital audio cable. [Select “Off” at the “1 LPCM (DVD)”.]

*2 When connecting an amplifier (with an optical digital input connector) which does not contain the Dolby Digital (AC-3) decoder, be sure to select “PCM”. If “Bitstream” is selected, any attempt to play DVDs may cause such a high level of noise that it may be harmful to your ears and damage your speakers.

Changing the initial settings

When "9 Other Settings" is selected

See page 51 for steps 1 and 2.

3 Select the preferred item by pressing ▲▼ and press SELECT.

- In the case of the main unit, select the item using the joystick.

1 Still Mode

This is to reduce jittering which may occur in the pictures during still mode.

2 Audio during Search

This is to select whether sounds during rapid advance at step 1 will be heard or not.

3 TV Mode (4:3)

This is to select the TV aspect when video material for wide-screen is played back on a conventional TV.

4 D. (Dynamic) Range Compression

This is to select the audio range which will be output during play.

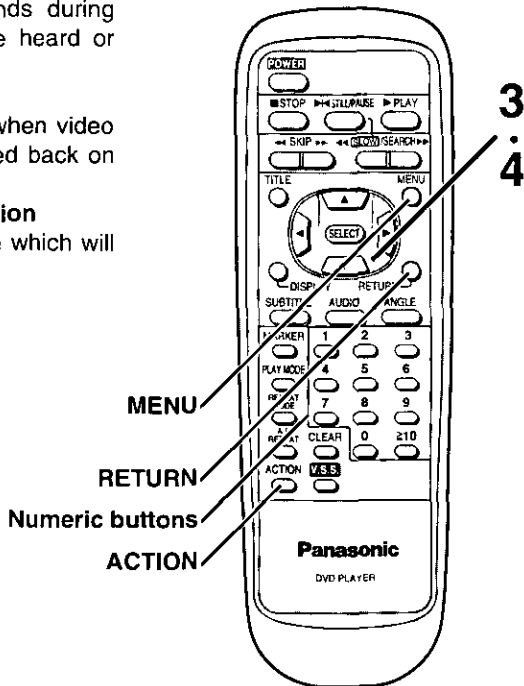
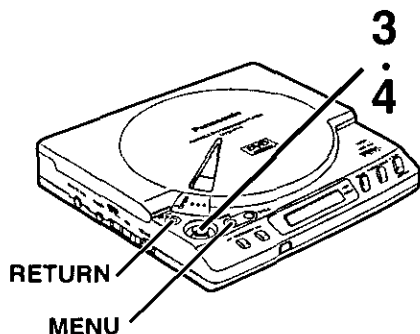
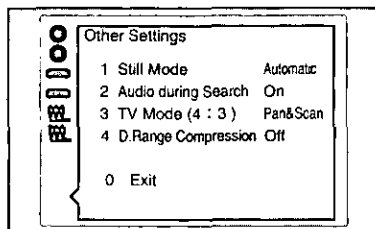

For your reference:

- The numeric buttons can also be used for selecting the items. (In this case, pressing SELECT is not necessary.)
- Returning to the previous menu
Press RETURN.
- Finishing the initial settings
Press ACTION, MENU or "0" at the initial settings screen illustrated in step 1 on page 51. (In the case of the main unit, press MENU.)

4 Select the preferred item by pressing **▲▼** and press **SELECT**.

- In the case of the main unit, select the item using the joystick.

■ When "1 Still Mode" is selected

1 **Automatic (Factory preset)**

Select this setting in general. "Frame still" and "Field still" will automatically be switched.

2 **Field**

Select this setting when jittering occurs in the pictures even when "Automatic" is selected.

■ When "2 Audio during Search" is selected

1 **On (Factory preset)**

Select this setting to hear sounds during rapid advance at step 1. (Select "Off" if you are bothered by these sounds.)

2 **Off**

Select when you do not want sound during rapid advance at step 1.

■ When "3 TV Mode (4:3)" is selected

1 **Pan & Scan (Factory preset)**

Video material for wide-screen will be played back in the Pan & Scan style (the left and right edges are cut off). Those not formatted in the Pan & Scan style will be played back in the letterbox style.

2 **Letterbox**

Video material for wide-screen will be played back in the letterbox style (black bands appear at top and bottom of screen).

■ When "4 D. (Dynamic) Range Compression" is selected

1 **Off (Factory preset)**

Normal audio range is selected.

2 **On**

Select this setting to enjoy listening to dynamic sound even on a low volume. This is useful for late-night listening. [This function only works with Dolby Digital (AC-3) DVDs.]

Dynamic range is the difference in volume between the quietest and loudest sounds heard. Dynamic Range Compression limits the difference in levels to give a more consistent level for listening at low volume. This is useful late at night, for example.

(Setting is finished and the screen illustrated in step 3 is displayed.)

Language code list

Code	Language Name
6565	Afar
6566	Abkhazian
6570	Afrikaans
6577	Ameharic
6582	Arabic
6583	Assamese
6588	Aymara
6590	Azerbaijani
6665	Bashkir
6669	Byelorussian
6671	Bulgarian
6672	Bihari
6678	Bengali; Bangla
6679	Tibetan
6682	Breton
6765	Catalan
6779	Corsican
6783	Czech
6789	Welsh
6865	Danish
6869	German
6890	Bhutani
6976	Greek
6978	English
6979	Esperanto
6983	Spanish
6984	Estonian
6985	Basque
7065	Persian
7073	Finnish
7074	Fiji
7079	Faroese
7082	French
7089	Frisian
7165	Irish
7168	Scots Gaelic
7176	Galician
7178	Guarani
7185	Gujarati
7265	Hausa
7273	Hindi
7282	Croatian
7285	Hungarian

Code	Language Name
7289	Armenian
7365	Interlingua
7378	Indonesian
7383	Icelandic
7384	Italian
7387	Hebrew
7465	Japanese
7473	Yiddish
7487	Javanese
7565	Georgian
7575	Kazakh
7576	Greenlandic
7577	Cambodian
7578	Kannada
7579	Korean
7583	Kashmiri
7585	Kurdish
7589	Kirghiz
7665	Latin
7678	Lingala
7679	Laothian
7684	Lithuanian
7686	Latvian, Lettish
7771	Malagasy
7773	Maori
7775	Macedonian
7776	Malayalam
7778	Mongolian
7779	Moldavian
7782	Marathi
7783	Malay
7784	Maltese
7789	Burmese
7865	Nauru
7869	Nepali
7876	Dutch
7879	Norwegian
7982	Oriya
8065	Panjabi
8076	Polish
8083	Pashto, Pushto
8084	Portuguese
8185	Quechua

Code	Language Name
8277	Rhaeto-Romance
8279	Romanian
8285	Russian
8365	Sanskrit
8368	Sindhi
8372	Serbo-Croatian
8373	Singhalese
8375	Slovak
8376	Slovenian
8377	Samoa
8378	Shona
8379	Somali
8381	Albanian
8382	Serbian
8385	Sundanese
8386	Swedish
8387	Swahili
8465	Tamil
8469	Telugu
8471	Tajik
8472	Thai
8473	Tigrinya
8475	Turkmen
8476	Tagalog
8479	Tonga
8482	Turkish
8484	Tatar
8487	Twi
8575	Ukrainian
8582	Urdu
8590	Uzbek
8673	Vietnamese
8679	Volapük
8779	Wolof
8872	Xhosa
8979	Yoruba
9072	Chinese
9085	Zulu

Troubleshooting

Before requesting service for this unit, check the chart below for a possible cause of the problem you are experiencing. Some simple checks or a minor adjustment on your part may eliminate the problem and restore proper operation.

If you are in doubt about some of the check points, or if the remedies indicated in the chart do not solve the problem, consult your dealer for instructions in U.S.A. or refer to the dealer from whom you have made your purchase to locate a convenient service center in Canada.

[In U.S.A. consult PASC Authorized Servicenters for detailed instructions or call 1-888-PANA-DVD (1-888-726-2383) or visit our home address www.panasonic.com/dvd for the address of an authorized factory servicenter. In Canada contact our Customer Care Centre at 905-624-5505 or the CCC web site at www.panasonic.ca/fdbckca.htm]

Symptom	Remedy	Reference page
No power.	•Ensure that the player is properly connected to the AC adaptor.	18
	•Ensure that the POWER switch of the player is not set to the "HOLD" position.	13
The player is automatically set to the standby mode.	•To conserve power, the player is automatically set to the standby mode after approx. 15 minutes have elapsed in the stop mode (Auto power-off function). Turn the power back on.	27
<ul style="list-style-type: none"> •Play fails to start even when PLAY (in the case of the main unit, PLAY/DISPLAY) is pressed. •Play starts but then stops immediately. 	•Condensation has formed: wait about 1 to 2 hours to allow the player to dry out.	10
	•This player cannot play discs other than DVDs, Video CDs and CDs.	5
	•The disc may be dirty and may require cleaning.	11
	•Ensure that the disc is inserted with the label side up.	24
No picture.	•Ensure that the player is connected properly.	18
	•Ensure that the input setting for the TV is "Video".	—
No sound from the external speakers of the stereo system or other equipment.	•Ensure that the player is connected properly.	18–21
	•Ensure that the input settings for the TV or stereo system are correct.	—
No key operation (by the remote control and/or the main unit) is effective.	•Some operations may be prohibited by the disc.	26
	•Ensure that the POWER switch of the player is not set to the "HOLD" position.	13
	•Turn the power off and then back to ON. Alternatively, turn the power off, disconnect the AC adaptor, and then re-connect it. (The player may not be operating properly due to lightning, static electricity or some other external factor.)	—

Troubleshooting

Symptom	Remedy	Reference page
No menu play of Video CD.	<ul style="list-style-type: none"> • This function works only with Video CDs with playback control. 	27, 71
Picture is distorted during rapid advance or rapid reverse.	<ul style="list-style-type: none"> • The picture will be somewhat distorted at times: this is normal. 	—
No subtitles.	<ul style="list-style-type: none"> • Subtitles appear only with discs which contain them. • Subtitles are cleared from the TV monitor. Turn ON the subtitles. 	— 46
Alternative audio soundtrack (or subtitle) languages fail to be selected.	<ul style="list-style-type: none"> • An alternative language is not selected with discs which do not contain more than one language. • In the case of some discs, the alternative language cannot be selected by switching the audio soundtrack/subtitle language. Try selecting it from the DVD menu if one is available. 	— 49
Angle cannot be changed.	<ul style="list-style-type: none"> • This function is dependent on software availability. Even if a disc has a number of angles recorded, these angles may be recorded for specific scenes only (when the angle indicator lights up during play on the display window). 	47
Play does not start even when title is selected.	<ul style="list-style-type: none"> • Confirm the "2 Ratings" setting. 	54–57
No 4:3 (16:9) picture.	<ul style="list-style-type: none"> • Choose the correct setup "5 TV Aspect" item which matches the TV set used. 	59
No On-Screen Display.	<ul style="list-style-type: none"> • The "Off" setting is selected at "4 On-Screen Messages": select "On". 	59
The password for rating level has been forgotten. <ul style="list-style-type: none"> • Reset all the settings to Factory preset. 	<ul style="list-style-type: none"> • While the player is in the stop mode, hold the player's ◀◀ SKIP/SEARCH button and the STILL/PAUSE button down simultaneously and then slide the POWER switch toward the "OFF/ON" position for longer than 1 second (until "Initialized" disappears from the TV monitor). The lock will be released and all initial settings will return to the default values. 	—

Symptom	Remedy	Reference page
Audio soundtrack and/or subtitle language is not the one selected at the initial settings.	<ul style="list-style-type: none"> ● If the audio soundtrack and/or subtitle language does not exist on the DVD, the language selected at the initial settings will not be seen/heard. 	52
The menu is not displayed in the preferred language.	<ul style="list-style-type: none"> ● Confirm the setting at the "Menus" of "1 Disc Languages". 	52
No operations can be performed with the remote control.	<ul style="list-style-type: none"> ● To conserve power, the player is automatically set to the standby mode after approx. 15 minutes have elapsed in the stop mode (Auto power-off function). Turn the power back on. 	27
	<ul style="list-style-type: none"> ● Check the batteries are installed with the correct polarities (⊕ and ⊖). 	22
	<ul style="list-style-type: none"> ● The batteries are depleted: replace them with new ones. 	22
	<ul style="list-style-type: none"> ● Point the remote control unit at the remote control sensor and operate. 	23
	<ul style="list-style-type: none"> ● Operate the remote control unit at a distance of not more than 23 feet (7 meters) from the remote control sensor. 	23
	<ul style="list-style-type: none"> ● Remove the obstacles between the remote control unit and remote control sensor. 	23
	<ul style="list-style-type: none"> ● Ensure that the POWER switch of the player is not set to the "HOLD" position. 	13
Shock-proof function (for preventing jumps in the sound during CD play) fails to work.	<ul style="list-style-type: none"> ● Shock-proof function does not work when the optical digital audio cable is connected to the audio output/optical digital audio output connector of the player's rear panel. 	—
The player becomes hot during playback.	<ul style="list-style-type: none"> ● This is normal. 	—
On-Screen Menu Icons not displayed or only partially displayed on the TV screen.	<ul style="list-style-type: none"> ● Select the appropriate TV screen type by consulting the operating instruction manual for the TV. 	—
If you cannot solve your problem.	<ul style="list-style-type: none"> ● Call our Panasonic Customer Call Center at 1-888-PANA-DVD (1-888-726-2383) or visit our home address www.panasonic.com/dvd for further assistance in U.S.A. To contact the nearest authorized Panasonic service centre in Canada, contact our Customer Care Centre at 905-624-5505, or the CCC web site at www.panasonic.ca/fdbckca.htm 	—

Self-diagnosis display function

When an error or trouble is detected during operation, a service number appears in the display window.

When a service number has appeared, check out the details given below.

Service number	Player status	Remedy
U 11	●Disc is dirty.	●Wipe the disc clean. (If the service number fails to be cleared even when the remedial action is taken, ask for the service engineer to repair the player.)
H □□ □□ stands for a number.	●Trouble is likely to have occurred. The number following "H" differs depending on the status of the player.	●Turn the power OFF and then back to ON. Alternatively, turn the power OFF, disconnect the AC adaptor, and then re-connect it. (If the service number fails to be cleared even when the remedial action is taken, ask for the service engineer to repair the player.)

Index

- A** A-B repeat play 36, 39
Angle switching 34, 47
Audio mode 35
Audio soundtrack
•Audio attribute 34
•Audio soundtrack language No. 34, 45
•Changing audio soundtrack
 language 34, 45
Auto-power off 27
- C** Chapter 29, 34, 38, 39, 71
Copyright 70
- D** Digital output 20, 21, 51, 60, 61, 70
Disc
•Disc handling 11
•Discs supported by this
 player 5, Back cover
•Inserting/Removing discs 24, 25
Disc language 51–53
Display window 14, 15
Dolby Digital
 (AC-3) 20, 21, 34, 50, 60, 61, 70
Dolby Digital (AC-3) decoder 20, 21
Dolby Pro Logic Surround
 decoder 21, 70
DVD Karaoke 34, 45
DVD menu 48, 49
Dynamic range 51, 62, 63
- E** Elapsed playing time 34, 35
- F** Field 30
Field still 63
Frame 30
Frame advance 30
Frame still 63
- H** Headphones 19
Hold function 13, 15
- I** Initial settings 51–63
Interactive DVD 15, 27, 37, 70
- L** Language code list 64
Letterbox 59, 63, 70
Linear PCM 21, 34, 60, 61, 70
- M** Maintenance 10
Marker 36, 40, 41
Menu play 29, 31, 33, 35, 37, 71
MPEG 21, 70
- N** NTSC system Back cover
- O** On-Screen Menu Icons 32–37
On-Screen Menu language 51, 58
On-Screen On/Off 51, 59
Optical digital audio cable 20, 61
Other settings 51, 62, 63
- P** PAL system 5, 15
Pan & Scan 59, 63, 70
Play mode 36
Playback
 control 15, 27, 29, 33, 35, 37, 71
 Program play 36, 39, 42, 43
 Random play 36, 44
Rapid advance/Rapid reverse
 (Search) 29, 37
Ratings 51, 54–57
•Password 54, 55, 57, 66
Region number 5
Repeat play 36, 38, 39
Resume function 28
- S** S-video output connector 13, 18, 71
S1-video input connector 18, 71
Self-diagnosis display function 68
Shuttle screen 37
Skipping ahead or back 29
Slow-motion play 31, 37
Still mode 62, 63
Still picture/Pause 30, 37
Subtitles
•Changing subtitle language 34, 46
•On/Off 34, 46
•Subtitle language No. 34, 46
- T** Title 34, 38, 39, 71
Title menu 48, 49
Track 29, 35, 38, 39, 71
TV aspect 18, 51, 59
- V** Virtual Surround Sound (V.S.S.) 50

Definition of terms

Digital audio output connector (Optical)

The digital audio output connector (optical) converts electrical signals into optical signals and transfers them to the amplifier. Consequently, it has a number of features including its immunity from electrical interference from external sources and its ability to prevent the generation of noise and its minimal effect on the external environment.

Dolby Digital (AC-3)

Dolby Digital (AC-3) is a digital sound compression technique developed by the Dolby Laboratories Licensing Corporation.

Supporting 5.1-channel surround sound, as well as stereo (2-channel) sound, this technique enables a large quantity of sound data to be efficiently recorded on a disc.

Dolby Pro Logic Surround decoder

This is a unit which uses the Dolby Surround (Pro Logic) system to restore 4-channel signals which were recorded on 2 channels back to the signals of 4 separate channels during playback. Compared with Dolby Digital (AC-3) / 5.1 channel surround sound, the channel separation is not as good and surround signals can be reproduced only up to a frequency of 7 kHz.

Interactive DVD

An interactive DVD is DVD software which includes multiple angles, multiple plot endings, etc.

Letterbox screen

This refers to a screen on which the playback picture of wide-screen DVDs or Video CDs appears with black bands running along the top and bottom.

Linear PCM audio (LPCM)

This refers to a signal recording format used in CDs.

While CDs are recorded in 44.1 kHz/16 bit, DVDs are recorded in 48 kHz/16 bit up to 96 kHz/24 bit, thus achieving higher quality audio than that of CDs.

MPEG (Moving Picture Experts Group)

MPEG is an international standard format for the compression of motion video as defined by the Moving Picture Experts Group, a working committee which functions under the auspices of the International Standardization Organization and International Electrotechnical Commission. The Group established the MPEG 1 standard in 1991 and the MPEG 2 standard in 1994. MPEG 2 builds on MPEG 1 with many improvements, and it yields a higher picture quality level.

Pan & Scan screen

This refers to a screen on which the playback picture of wide-screen DVDs or Video CDs is cut off at the left and right sides.

Apparatus Claims of U.S. Patent Nos. 4,631,603, 4,577,216, and 4,819,098, licensed for limited viewing uses only.

This product incorporates copyright protection technology that is protected by method claims of certain U.S. patents and other intellectual property rights owned by Macrovision Corporation and other rights owners. Use of this copyright protection technology must be authorized by Macrovision Corporation, and is intended for home and other limited viewing uses only unless otherwise authorized, by Macrovision Corporation. Reverse engineering or disassemble is prohibited.

Playback control (Video CD)

If the Video CD has "With Playback Control" or others written on the disc surface or on the jacket, the scenes or information to be viewed (or listened to) can be selected interactively with the TV monitor by looking at the menu shown on the TV monitor.

In these instructions, playback using the menu screen is referred to as the "menu play" for video CDs. This player supports Video CDs with playback control.

S-video output connector

This connector separates the color (C) and luminance (Y) signals before transmitting them to the TV set in order to achieve a sharper picture.

It is recommended to use the S-video cable (optional) when connecting the player to a TV set equipped with an S-video input connector.

S1-video input connector

When signals are supplied to this connector, pictures with a different picture aspect ratio (picture frame width to frame height) are identified, and the wide-screen TV picture quality mode is selected automatically.

Product service

Do not attempt to remove the cover(s) or repair the unit yourself. Refer servicing to qualified personnel only.

Product information

U.S.A.: For product service, product information or assistance with product operation, refer to the service center directory. **Canada:** Call the dealer from whom you have made your purchase, contact our Customer Care Centre at 905-624-5505, or access the CCC web site at www.panasonic.ca/fdbckca.htm

If you ship the product

Carefully pack and send it prepaid, adequately insured and preferably in the original carton. Attach a postage-affixed letter, detailing the complaint, to the outside of the carton. **DO NOT send the product to the Executive or Regional Sales offices. They are NOT equipped to make repairs.**

Title, Chapter (DVD)

DVDs are divided into some large sections (titles) or some small sections (chapters). Each section is numbered; these numbers are called "Title number" or "Chapter number".

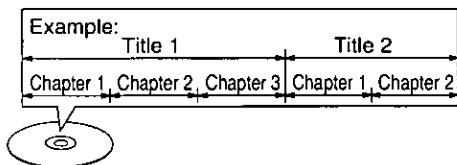

Track (Video CD/CD)

Video CDs or CDs are divided into some sections (tracks). Each section is numbered; these numbers are called "Track number".

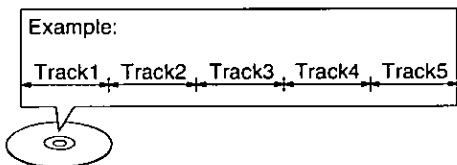

Specifications

Power source: DC 9 V	AC adaptor
Power consumption: 12 W (with AC adaptor) 7.7 W (Main unit only) [0.8 W when power is off either by the power switch or the remote control (when the AC adaptor is connected)]	Power source: AC 120 V, 60 Hz Power consumption: 15 W DC output: 9 V, 1 A

Signal system: NTSC

Weight: 1.4 lbs. (620 g)

Dimensions: 6 $\frac{5}{16}$ "(W)×6 $\frac{5}{16}$ "(D)×1 $\frac{7}{16}$ "(H)
[160 (W)×160 (D)×36 (H) mm]
(excluding protrusions)

Operating temperature range:
+41 to +95°F (+5 to +35°C)

Operating humidity range:
5 to 90% (no condensation)

Discs played:

- (1) DVD-VIDEO disc
 - 5"(12 cm) single-sided, single-layer
 - 5"(12 cm) single-sided, double-layer
 - 5"(12 cm) double-sided, double-layer (one layer per side)
 - 3"(8 cm) single-sided, single-layer
 - 3"(8 cm) single-sided, double-layer
 - 3"(8 cm) double-sided, double-layer (one layer per side)
- (2) Compact disc (CD-DA, VIDEO CD)
 - 5"(12 cm) disc
 - 3"(8 cm) disc

S-video output:

- Y output level: 1 Vp-p (75Ω)
- C output level: 0.286 Vp-p (75Ω) (NTSC)
- Output connector: S terminal (1 system)

Video output:

- Output level: 1 Vp-p (75Ω)
- Output connector: Mini-jack (1 system)

Audio output:

- Output level: 1.5 Vrms (1 kHz, 0 dB)
- Output connector: Stereo mini-jack (1 system)

Audio signal output characteristics:

- (1) Frequency response:
 - DVD (linear audio): 2 Hz–22 kHz (48 kHz sampling)
2 Hz–44 kHz (96 kHz sampling)
 - CD audio: 2 Hz–20 kHz
- (2) S/N ratio:
 - CD audio: 115 dB
- (3) Dynamic range:
 - DVD (linear audio): 99 dB
 - CD audio: 97 dB

Digital audio output:

- Optical digital output: Mini optical connector (Also used for audio output)

Pickup:

- Wave length: 660 nm/780 nm
- Laser power: CLASS II/CLASS I

Specifications are subject to change without notice.

Weight and dimensions are approximate.

**Panasonic Consumer Electronics Company,
Division of Matsushita Electric Corporation of America**

One Panasonic Way Secaucus, New Jersey 07094

<http://www.panasonic.com>

**Panasonic Sales Company,
Division of Matsushita Electric of Puerto Rico, Inc. ("PSC")**

Ave. 65 de Infantería, Km 9.5 San Gabriel Industrial Park, Carolina, Puerto Rico 00985

Panasonic Canada Inc.

5770 Ambler Drive, Mississauga, Ontario L4W 2T3

www.panasonic.ca

© Matsushita Electric Industrial Co., Ltd. 1998

Free Manuals Download Website

<http://myh66.com>

<http://usermanuals.us>

<http://www.somanuals.com>

<http://www.4manuals.cc>

<http://www.manual-lib.com>

<http://www.404manual.com>

<http://www.luxmanual.com>

<http://aubethermostatmanual.com>

Golf course search by state

<http://golfingnear.com>

Email search by domain

<http://emailbydomain.com>

Auto manuals search

<http://auto.somanuals.com>

TV manuals search

<http://tv.somanuals.com>