

Panasonic

Telephone Answering System
with Facsimile

Model No. **KX-F790**

OPERATING INSTRUCTIONS



Please read these Operating Instructions before using the unit.

*** FAX PAPER ***

98 foot roll of Panasonic super thermal paper

— OF —

164 foot roll of standard thermal paper

(See page 75 for order numbers.)

Please read **IMPORTANT SAFETY INSTRUCTIONS** on page 74 before use. Read and understand all instructions.

Caution:

The Telephone Consumer Protection Act of 1991 makes it unlawful for any person to use a computer or other electronic device to send any message via a telephone facsimile machine unless such a message clearly contains in a margin on the top or bottom of at least the first sent page the following information:

- 1) Date and time of transmission; and,
- 2) Identification of either business, business entity or individual sending the message; and,
- 3) Telephone number of either the sending machine, business, business entity or individual.

In order to program this information into your facsimile machine, you must complete the steps on pages 36 to 37 in these Operating Instructions.

Important Phone Numbers

Authorized Service Center: 1-800-545-2672

Accessory Purchases: 1-800-332-5368

Technical Support: 1-800-HELP-FAX

Accessories

For recording paper replacement, see page 75.

Power cord 1 pc.

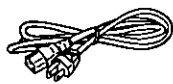

(page 11)

Telephone line cord 1 pc.



(page 11)

Paper stacker 1 pc.

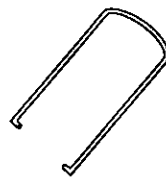

(page 9)

Recording paper . . . 1 pc.

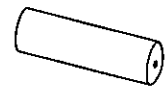

(page 9)

Handset 1 pc.

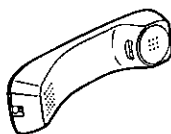

(page 11)

Handset cord 1 pc.



(page 11)

AA (R6, UM-3) size battery 4 pcs.



(page 10)

Any details given in these instructions are subject to change without notice. The picture on the cover page may vary slightly from the actual product.

Thank you for purchasing the Panasonic Telephone Answering System with Facsimile. This unit combines multiple functions of Facsimile, Answering Device and Telephone; You can send and receive documents and voice messages on a single line.

Features

General

- Desktop type
- LCD (Liquid Crystal Display) readout
- Automatic paper cutter
- Silent ring fax recognition system (page 25)
- Help function (see below)
- Copier function (page 27)

Facsimile

- Automatic document feeder (up to 15 sheets)
- 64-level halftones
- Resolution: standard/fine/super fine/halftone (page 19)
- Delayed transmission (page 42)
- Paper save function (page 49)
- Overseas transmission mode (page 47)
- Remote fax receiving using an extension phone (page 43)
- Junk mail prohibitor (page 45)
- Day/night mode (page 48)

Digital Answering System:

- Voice mailbox (page 54)
- Tone remote control system

Integrated telephone system

- One-touch dialer (10 phone numbers) (page 38)
- 22-station speed dialer (page 39)
- Hands-free speakerphone (page 16)
- Electronic telephone directory (page 40)

HELP function

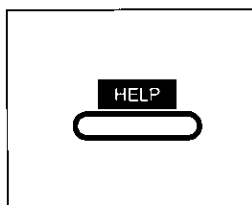

Use this function if the instructions are lost while using the unit. It will provide the user with instructions.

When the **HELP** button is pressed, the unit will print a quick reference.

Information:

- Transmit the leaflet on page 79 to several of your associates. In this way, you can confirm that your unit will function correctly and inform them of the procedure for transmitting documents and/or recording voice messages.

Table of Contents

1 Installation and Preparation

Location of Controls	6
Front view	6
Rear view	6
Control panel	7
Answering control buttons	8
Installing Your Unit	9
Installing the recording paper	9
Installing the paper stacker	9
Installing the batteries	10
Connections and dialing mode setting	11
Adjusting Volumes	12
Recording Greeting Messages	13
How to record greeting messages	13
Checking greeting messages	14
Setting the caller's recording time	14
Selecting the Receive Mode	15

2 Basic Instructions

Telephone

Making and Answering Voice Calls	16
Making voice calls	16
Making voice calls using automatic dialing	16
Redialing the last dialed number	17
Voice muting	17
Answering voice calls	17
Helpful hints for the speakerphone operation	17

Facsimile

Before Transmission	18
Acceptable documents	18
Loading documents	19
Setting resolution	19
Sending 16 or more sheets	19
Transmitting Documents	20
Transmitting documents manually	20
Transmitting documents with fewer procedures	20
Transmitting documents using automatic dialing	21
Receiving Documents and/or Voice Calls	22
Manual reception	22
Automatic reception	22

Receiving in the ANS/FAX mode	22
Setting the number of rings to answer in the ANS/FAX mode	23
Receiving in the TEL/FAX mode	24
Setting the number of rings to answer in the TEL/FAX mode	25
Silent ring fax recognition system	25
Receiving in the FAX mode	26
Setting the number of rings to answer in the FAX mode	26

Copier

Making a Copy	27
----------------------------	----

Answering Device

Operating the Answering Device	28
Setup of voice message and document reception	28
Listening to recorded messages	28
Functions during playback	29
Erasing recorded messages	29
Recording a memo message	30
Recording a telephone conversation	30
Setting the message alert	31
Setting the recording time alert	31

3 Basic Settings

User Programmable Features	32
Programming feature table	32
How to enter letters and symbols	34
To enter characters	34
Special uses of the direct call station keys	35
Setting the date and time	36
Setting your logo	36
Setting your facsimile telephone number	37
Setting the transmission report printing	37

Storing Phone Numbers for Automatic

Dialing	38
Storing phone numbers for one-touch dialing	38
Storing phone numbers for speed dialing	39
To keep a phone number secret	39

4 Advanced Instructions

Electronic Telephone Directory	40
How to use the electronic telephone directory	40

Polling	41
Polling reception	41
Polling transmission (Polled)	41
Delayed Transmission	42
Remote Fax Receiving Using an Extension	
Phone	43
Using an extension phone	43
Changing the remote fax activation code	44
Junk Mail Prohibitor	45
Setting the junk mail prohibitor	45
Transmitting documents to your unit with the prohibitor ID	46
Special Settings	47
Logo print position	47
Overseas transmission mode	47
Setting the day/night mode	48
Paper save reception/copy	49
Extension copy	50
Original mode	51
Resetting the advanced features	51
Voice Contact	52
Initiating voice contact	52
Receiving a request for voice contact	52
TONE, FLASH and PAUSE Buttons	53
TONE button	53
FLASH button	53
PAUSE button	53
Voice Mailbox	54
To use mailbox	54
Recording a personal greeting message for mailbox	54
Programming the mailbox password	55
How incoming messages are recorded into each mailbox	55
Retrieving messages in the mailbox	56
Erasing recorded messages in the mailbox	56
Retrieving messages in the mailbox from a remote location	57
Setting the mailbox alert	57
Operating the Answering Device from a Remote Phone	58
Summary of remote operations	58
Programming the remote ANS ID	59
Listening to the recorded messages in the common memory	59
Retrieving the recorded messages in the mailbox	60
Functions during playback	60

Erasing a specific message from memory ...	61
Erasing all messages from memory	61
Room monitoring	61
Recording a marker message	61
Re-recording a greeting message	62
Turning on/off pager alert	62
To skip the greeting message	62

Pager Alert	63
--------------------------	----

5 Reports and Lists

Printing Reports and Lists	64
How to print each report/list	64
Sample reports and lists	65
Setting journal auto print	67

6 Troubleshooting and Maintenance

Troubleshooting	68
Error messages on the display	68
General corrective measures	69
Explanation of communication result on the report	70
Clearing a recording paper jam	71
Clearing a document jam	72
Adjusting the feeder pressure	72
Maintenance	73
Cleaning the document feeder unit	73
Cleaning the thermal head	73

7 General Information

Important Safety Instructions	74
Accessory Order Information	75
Specifications	75
FCC Information	76
Limited Warranty	77
Index	78
FAX CORRESPONDENCE	79
Speed dialer list	80
Answering device remote operation card ...	81
Servicenter directory	83

Location of Controls

Front view

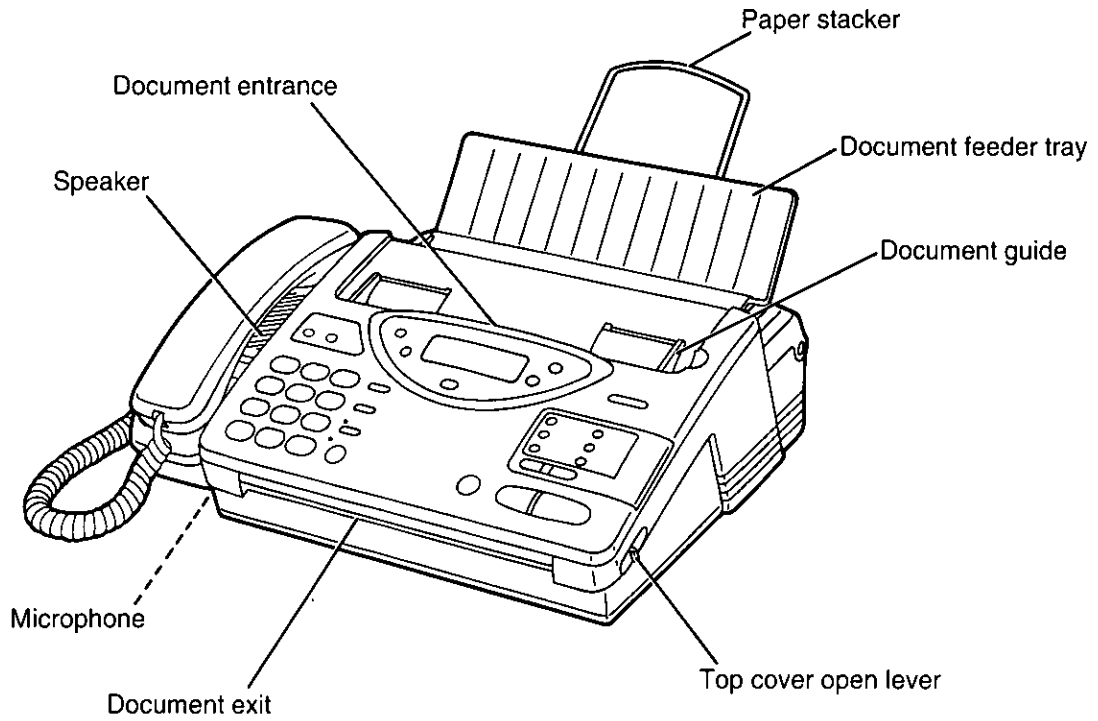

Rear view

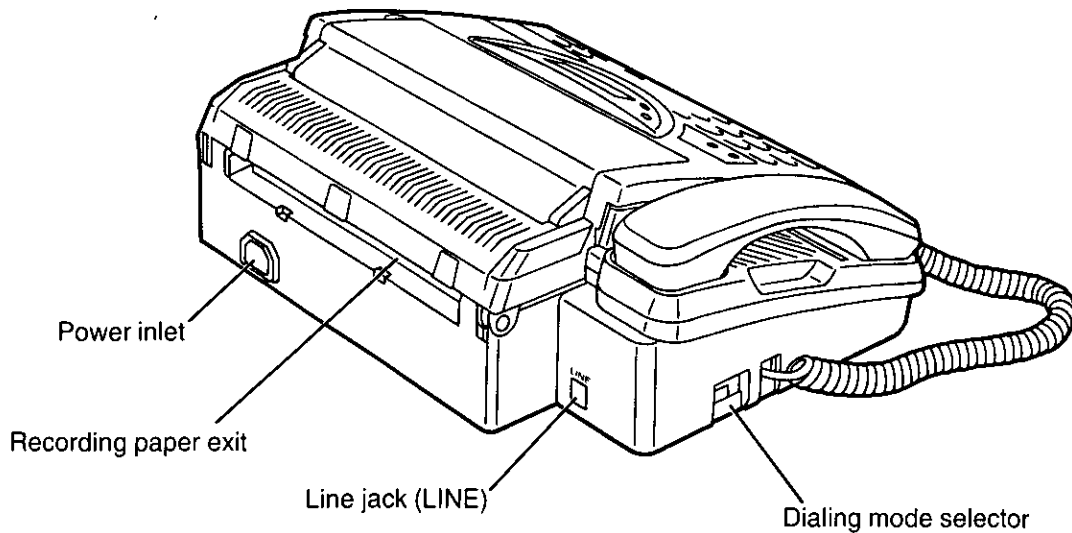

Control panel

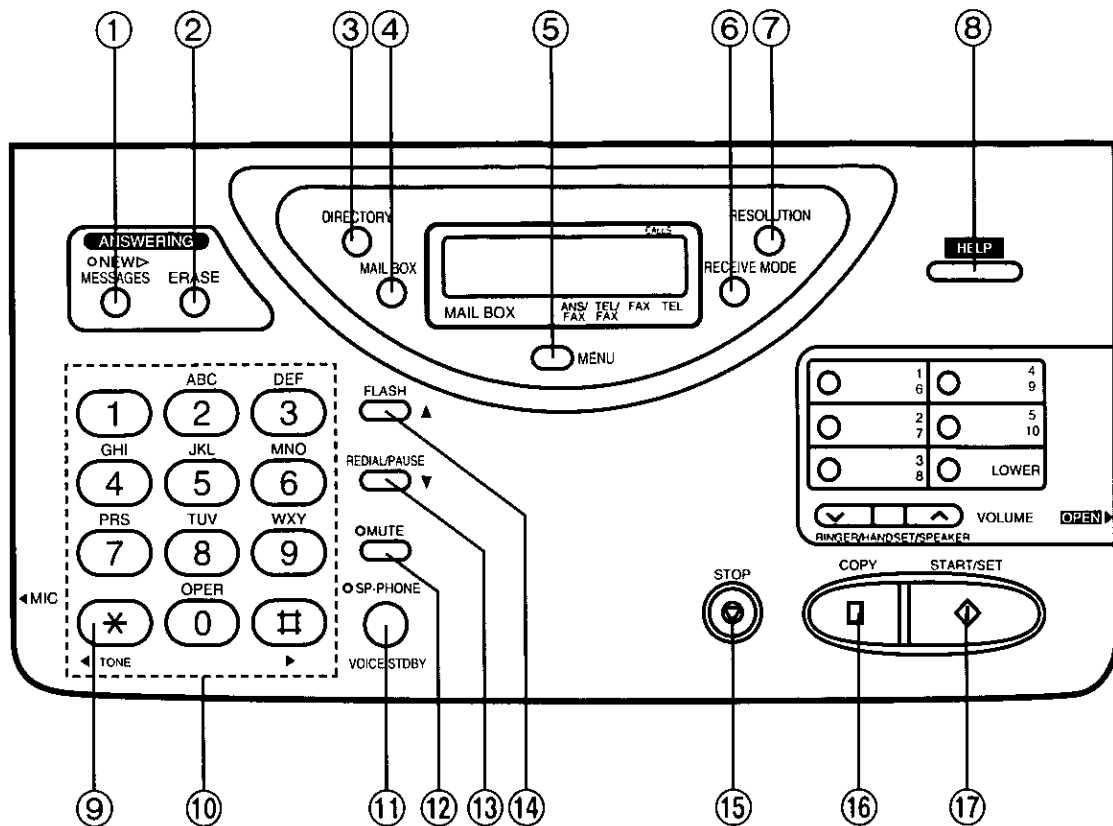

- ① **NEW MESSAGES button** (page 28)
Used to play back only new messages.
- ② **ERASE button** (page 29)
Used to erase recorded incoming messages.
- ③ **DIRECTORY button** (pages 16, 21 and 40)
Used for speed dialing. Also used for the electronic telephone directory.
- ④ **MAIL BOX button** (page 56)
Used to select a voice mailbox number.
- ⑤ **MENU button**
Used to start and exit various programming.
- ⑥ **RECEIVE MODE button** (page 15)
Used to select the desired receiving mode.
- ⑦ **RESOLUTION button** (page 19)
Used to adjust scanning line density.
- ⑧ **HELP button** (page 3)
Used to print an easy guide for operations.
- ⑨ **TONE button** (page 53)
Used to temporarily change the dialing mode from pulse to tone during a dialing operation.
- ⑩ **Dial keypad**
Used for dialing operation and parameter setting. Also used as character keys.
- ⑪ **SP-PHONE/VOICE STDBY button** (pages 16 and 52)
Used for on-hook dialing and voice contact features.
- ⑫ **MUTE button** (page 17)
Used for voice muting.
- ⑬ **REDIAL/PAUSE button** (pages 17 and 53)
Used to redial the last dialed number. Also used to insert a pause into a phone number.
- ⑭ **FLASH button** (page 53)
Used as a hook button. Also used to access some features of your host exchange.
- ⑮ **STOP button** (page 20)
Used to stop fax communication.
- ⑯ **COPY button** (page 27)
Used to start copying.
- ⑰ **START/SET button**
Used to start fax communication. Also used to store parameters during programming.

Control panel (cont.)

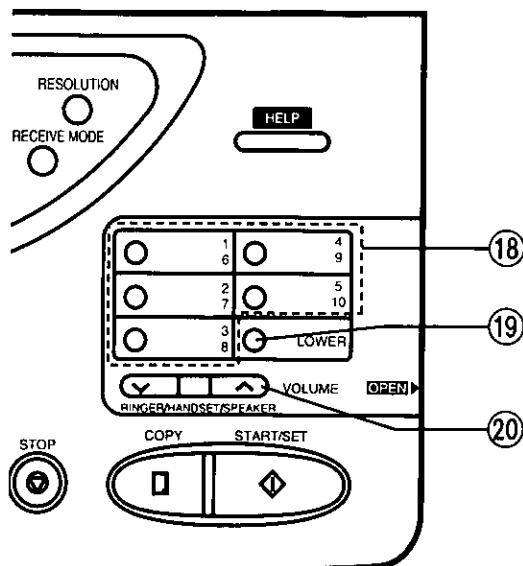

- ⑱ **Direct call station keys** (pages 16, 21 and 38)
Used for one-touch dialing. Also used as character keys when logo and station names are programmed.
- ⑲ **LOWER key** (pages 16, 21 and 38)
Used to access lower stations (6 to 10) for one-touch dialing.
- ⑳ **VOLUME buttons** (page 12)
Used to adjust the volume level of the ringer, handset and speaker.

Answering control buttons

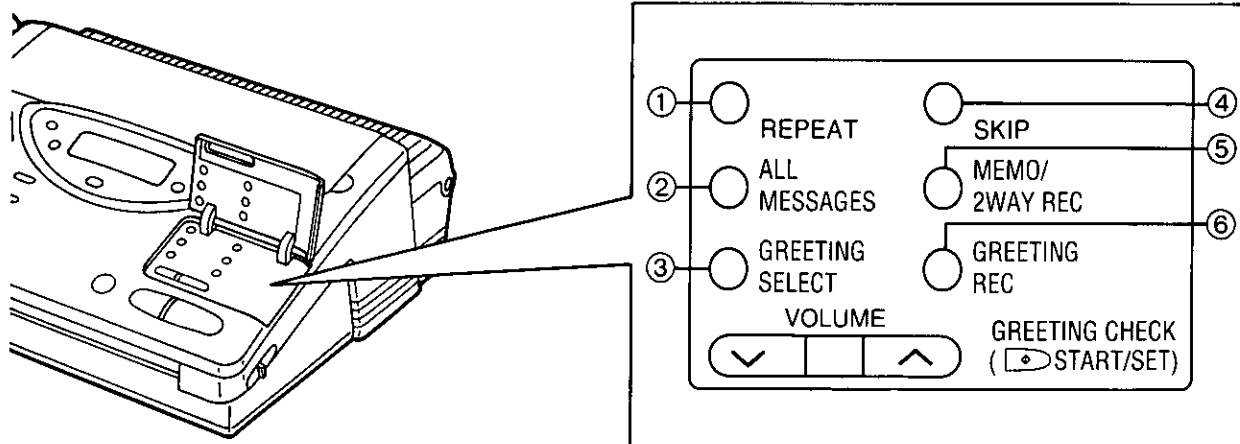

- ① **REPEAT button** (page 29)
Used to replay the previous message during the message playback.
- ② **ALL MESSAGES button** (page 28)
Used to play back all the recorded voice messages.
- ③ **GREETING SELECT button** (pages 13 and 54)
Used to select a desired greeting message when recording or checking the greeting message.
- ④ **SKIP button** (page 29)
Used to skip to the next message during the message playback.
- ⑤ **MEMO/2WAY REC button** (page 30)
Used to start and stop recording a memo message or a telephone conversation.
- ⑥ **GREETING REC button** (pages 13 and 54)
Used to start and stop recording a greeting message.

Installing Your Unit

Installing the recording paper

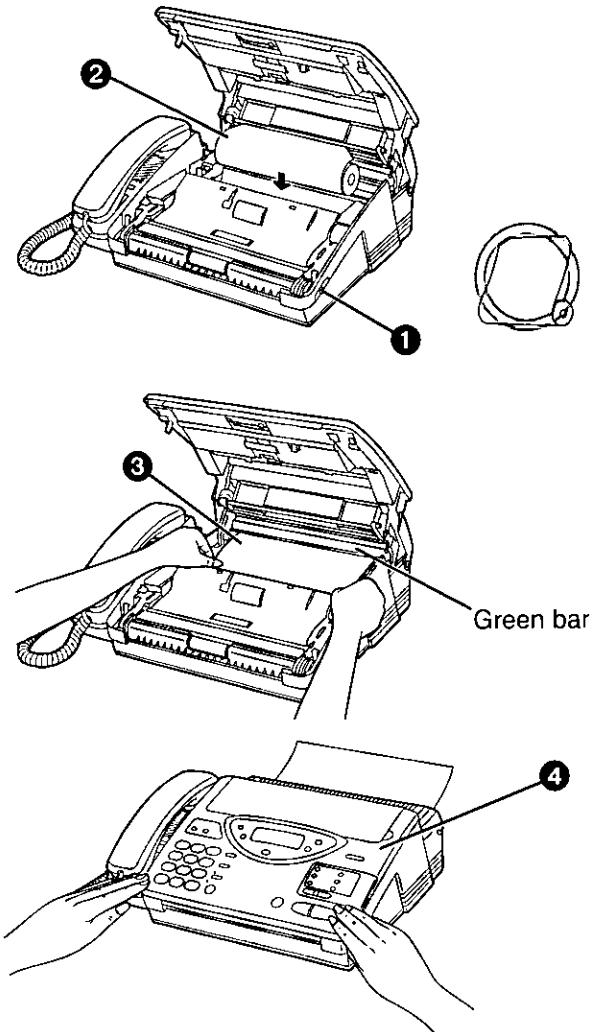

- 1 Slide the lever toward you to open the top cover.
- 2 Place a recording paper roll in the unit.
—Make sure that the shiny side of the paper is facing up and that there is no slack, tape or glue residue on the paper roll. (See note below.)
- 3 Insert the leading edge of recording paper under the green bar.
- 4 Close the top cover carefully by gently pressing down on both ends.

Notes:

- Use only the included roll or specified recording paper, or else the print quality may be affected and/or excessive thermal head wear may occur. See page 75 for order number.
- The start of some recording paper rolls is secured using glue or tape. Residue from this glue/tape may cause the paper cutter to jam immediately following installation of a new roll. To prevent this, cut approximately 6 inches from the new roll of paper prior to installation.

Installing the paper stacker

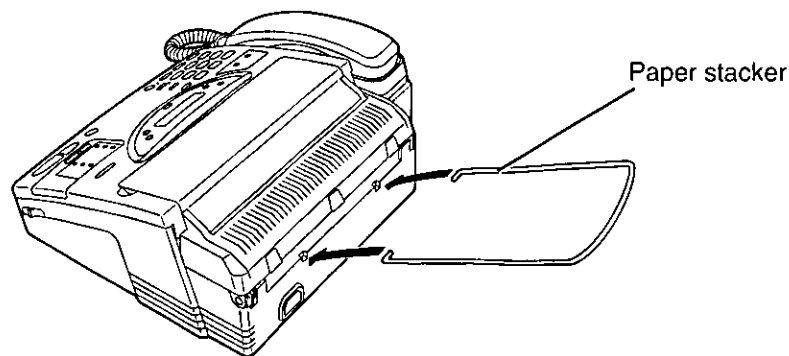

Installing the batteries

The batteries are required to retain voice messages in memory when the power cord is disconnected or during a power failure. Install four AA batteries (supplied) before using the unit.

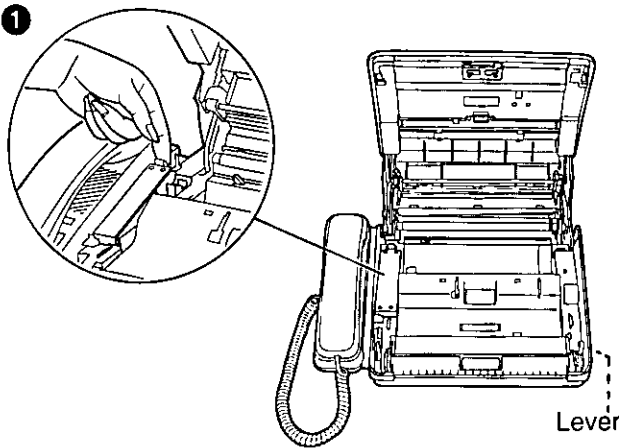

- 1 Slide the lever toward you to open the top cover and remove the battery compartment cover by pulling the hook toward you and lifting it up.
- 2 Install four AA batteries into the compartment using correct polarity (+, -).
- 3 (A) Replace the battery compartment cover by installing the tab of the cover into the hole first.
(B) Press down the part marked "PRESS" until it clicks.
- 4 Close the top cover.

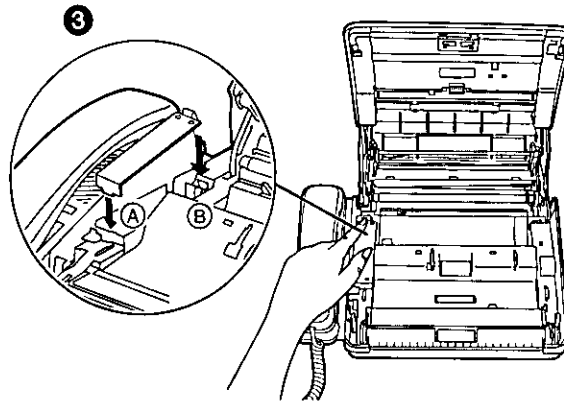
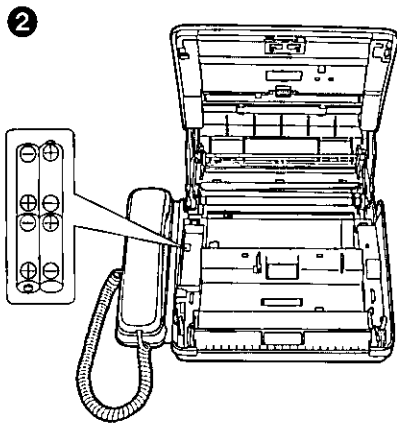

Battery precautions:

- The batteries should be used correctly, otherwise, the unit may be damaged due to battery leakage.
- Do not mix different types of batteries.
- Do not charge, short-circuit, disassemble, heat or dispose in fire.
- Remove all the batteries when replacing.

Notes:

- If you do not install the batteries, or if the battery power is low:
— The display will show the following message;

BATTERY LOW

Install new batteries.

— Greeting and all messages saved in memory will be erased when a power failure occurs.

- Batteries should be installed in order to provide message retention during a power failure. Message retention time is approximately 1 day with new batteries.
- To avoid losing the greeting and all messages saved in memory, the power cord must remain connected when replacing batteries.
- Disconnect the telephone line cord before opening the battery compartment cover.
- Replace all the batteries once a year, or mis-operation may occur.
- Do not use Nickel-Cadmium batteries.

Connections and dialing mode setting

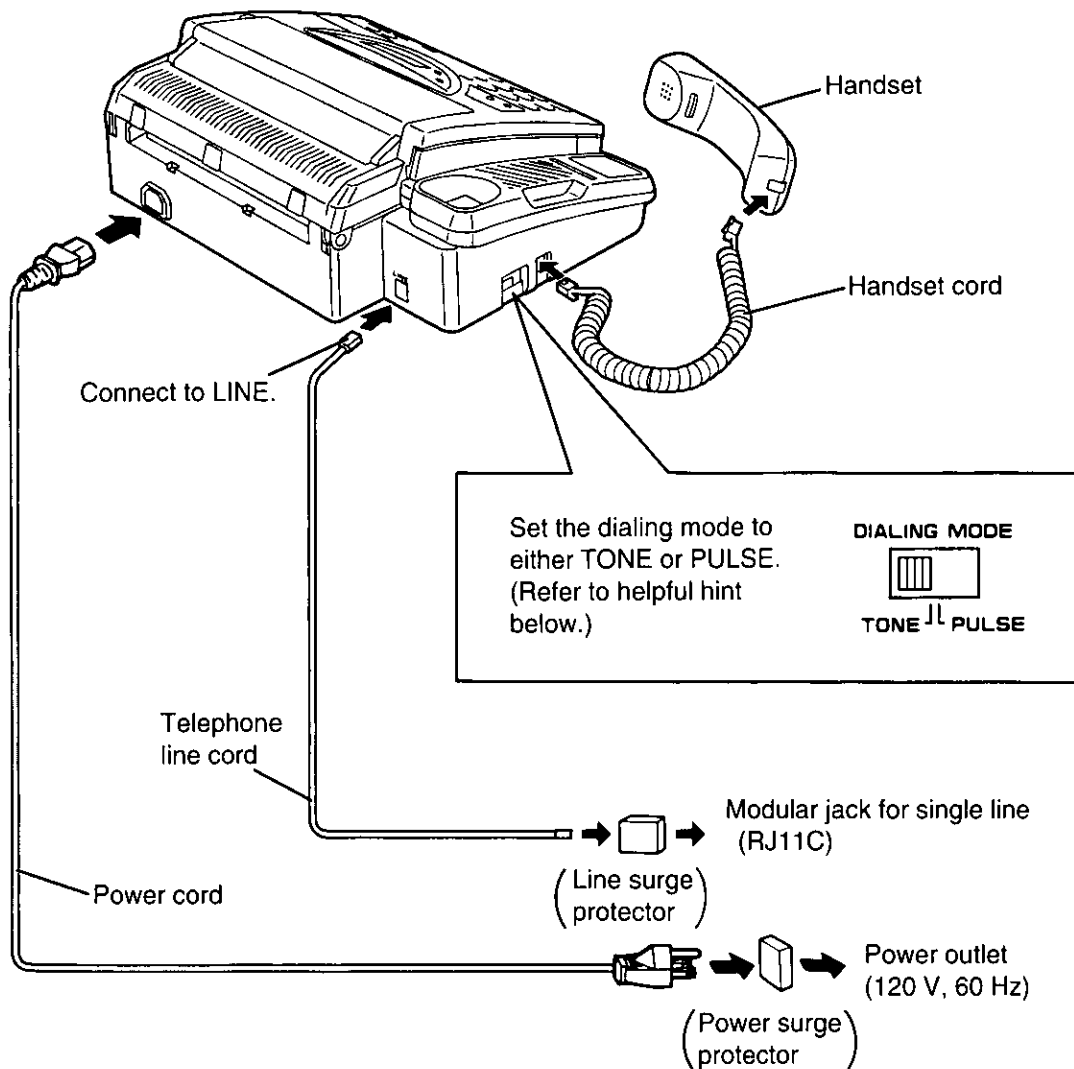

Helpful hint for setting the dialing mode:

1. Ensure that the dialing mode selector is set to TONE.
2. Lift the handset or press the SP-PHONE button, then listen for the dial tone.
3. Dial a familiar number.
4. If the call is successful, the unit is connected to a tone exchange. Leave the selector set to TONE.
5. If the call is not successful, the unit is connected to a pulse exchange. Switch the selector to PULSE.

Notes:

- We recommend the use of an exclusive power outlet to avoid interference from other equipment.
- When you operate this product, the socket outlet should be near the product and be easily accessible.
- The unit will not function during a power failure.
- For additional equipment protection, we recommend the use of a surge protector. The following type is available; TELESPIKE BLOK MODEL TSB (TRIPPE MFG. CO.), SPIKE BLOK MODEL SK6-0 (TRIPPE MFG. CO.), SUPER MAX (PANAMAX) or MP1 (ITW LINX).

Adjusting Volumes

You can adjust the volume level of the ringer, the handset and the speaker. These volume levels should be adjusted respectively.

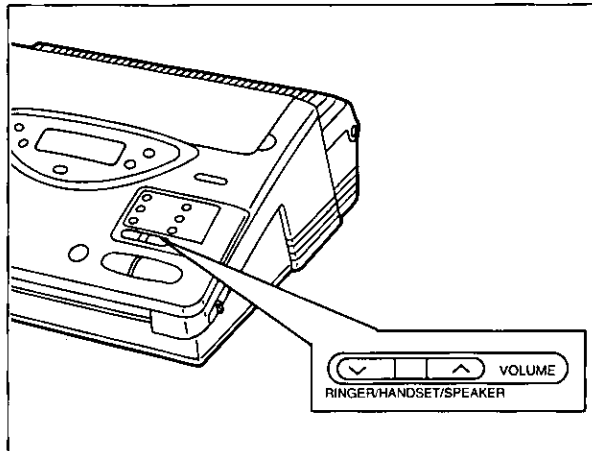

To increase the volume level,
press ^ repeatedly.

To decrease the volume level,
press v repeatedly.

—The number of the black squares in the display shows the volume level as below.

Ringer volume

Press the buttons (^/v) repeatedly while the unit is in idle status. 3 levels are available.

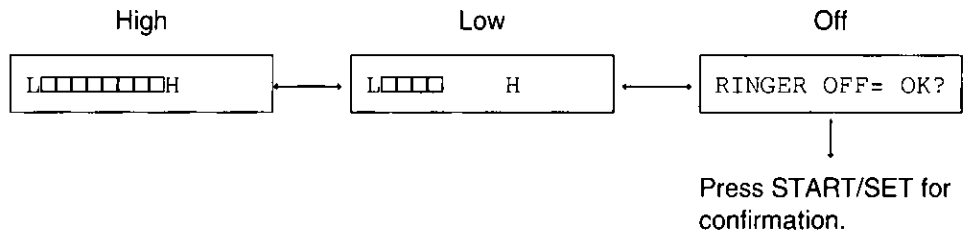

Note:

• If the ringer volume is set to off, the unit will not ring and the display will show "RINGER OFF" in idle status.

Handset volume

Press the buttons (^/v) repeatedly when the handset is in use. 3 levels are available.

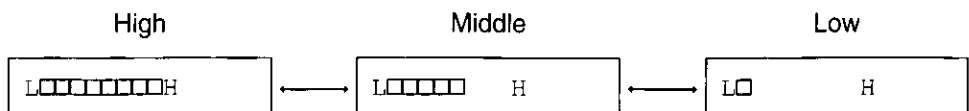

Speaker volume

Press the buttons (^/v) repeatedly when the speakerphone is used. 8 levels are available.

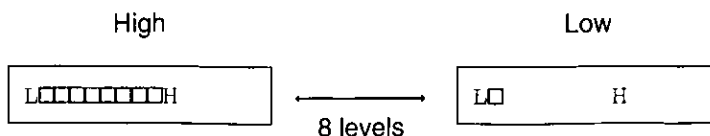

Answering device volume

Press the buttons (^/v) repeatedly while listening to messages recorded on the answering device. 9 levels are available.

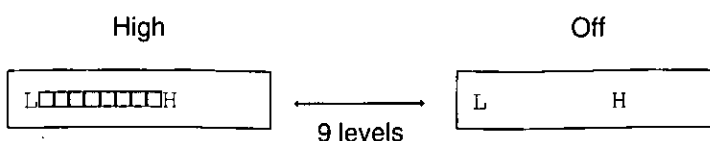

Recording Greeting Messages

Record two types of greeting messages before using the unit as an answering device and a facsimile. One is the message for the *ANS/FAX* mode, and the other is for the *TEL/FAX* mode.

The greeting message for the *ANS/FAX* mode tells a caller that you are unable to answer, and allows the caller to leave a voice message or to send a fax message.

The greeting message for the *TEL/FAX* mode tells a caller that the unit is calling you up, and allows the caller to wait until you answer the call or to send a fax message.

How to record greeting messages

Recording time is limited to 16 seconds for each message. Record a greeting message within 12 seconds for optimum performance. Perform the following steps to record each of the messages.

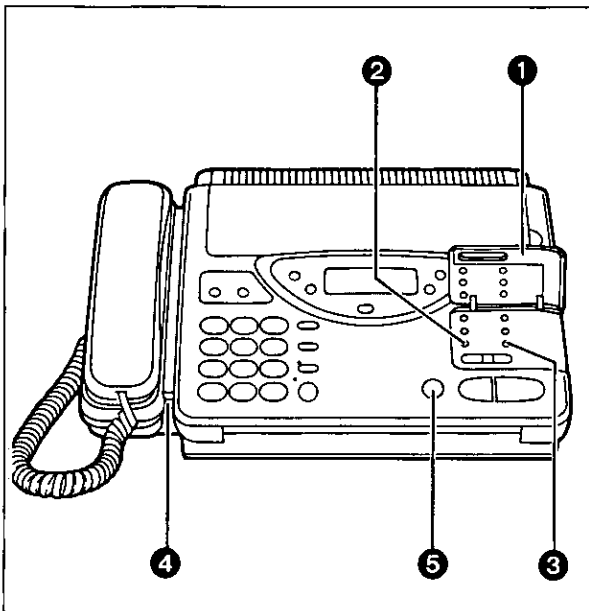

1 Open the station key panel.

2 ■ For the *ANS/FAX* mode:
Press **GREETING SELECT**.

ANS-GREETING

■ For the *TEL/FAX* mode:
Press **GREETING SELECT** repeatedly until the following is displayed.

TEL-GREETING

3 Press **GREETING REC**.
Example: Recording for the ANS/FAX mode

ANS REC 16s

—A beep will be heard.

4 Immediately after the beep, speak clearly and loudly toward the microphone from a distance of approximately 200 mm (8 inches).

5 When finished, press **STOP**.
—After a beep, the unit will play back the message so that you can confirm it. Adjust the speaker's volume to a suitable level by pressing the **VOLUME** buttons.

Suggested messages

■ For the *ANS/FAX* mode:
"This is (your name, business and/or telephone number). We are unable to answer right now. To send a fax, start transmission. To leave a message, speak (or 'speak for up to 1 minute') after the long beep. Thank you."

■ For the *TEL/FAX* mode:
"This is (your name, business and/or telephone number). Please wait for someone to answer the line. To send a fax, start transmission."

Notes:

- If you make a mistake while recording, repeat from step 2.
- You can record the greeting message for the *ANS/FAX* mode by directly pressing the **GREETING REC** button without pressing the **GREETING SELECT** button.

Checking greeting messages

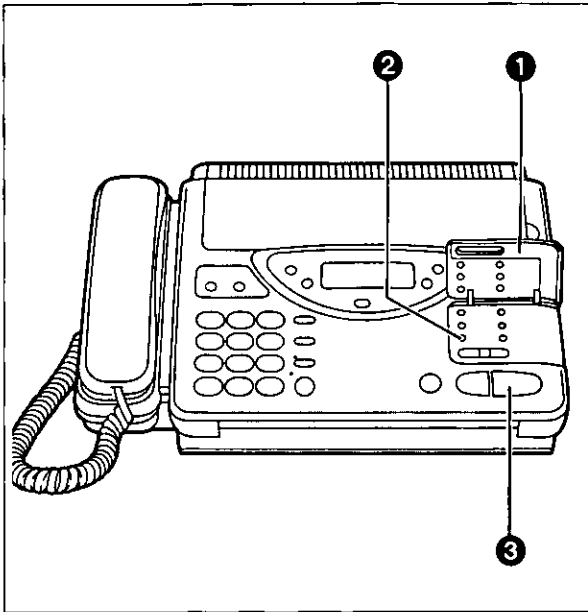

- 1 Open the station key panel.
- 2 ■ **Checking the greeting message for the ANS/FAX mode:**
Press **GREETING SELECT**.

ANS-GREETING

- **Checking the greeting message for the TEL/FAX mode:**
Press **GREETING SELECT** repeatedly until the following is displayed.

TEL-GREETING

- 3 Press **START/SET**.
—After a beep, the unit will play back the message.

Notes:

- Adjust the speaker volume using the **VOLUME** button (see page 12).
- You can check the greeting message for the **ANS/FAX** mode by directly pressing the **START/SET** button without pressing the **GREETING SELECT** button.

Setting the caller's recording time

You can choose from two lengths of recording times for incoming messages.

VOX (unlimited): The unit will record an incoming message as long as a caller speaks (pre-selected setting).

1 MIN (1 minute): The unit will record an incoming message up to 1 minute per message.

To change the recording time, proceed as follows:

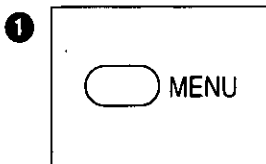

Press **MENU**.

1. SYSTEM SET UP

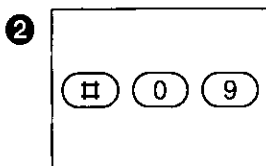

Press **#09**.

RECORDING TIME

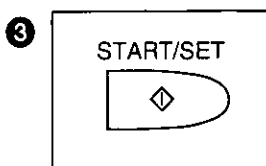

Press **START/SET**.

MODE=VOX [▲▼]

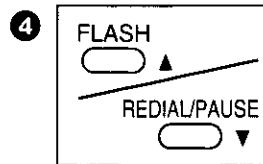

Press **▲** or **▼** to select the desired mode.

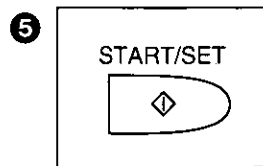

Press **START/SET** to store the setting.

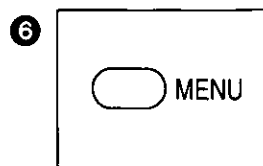

Press **MENU** to end the program.

Selecting the Receive Mode

Select a desired receiving mode by pressing the **RECEIVE MODE** button repeatedly. The selected mode is displayed.

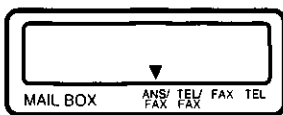
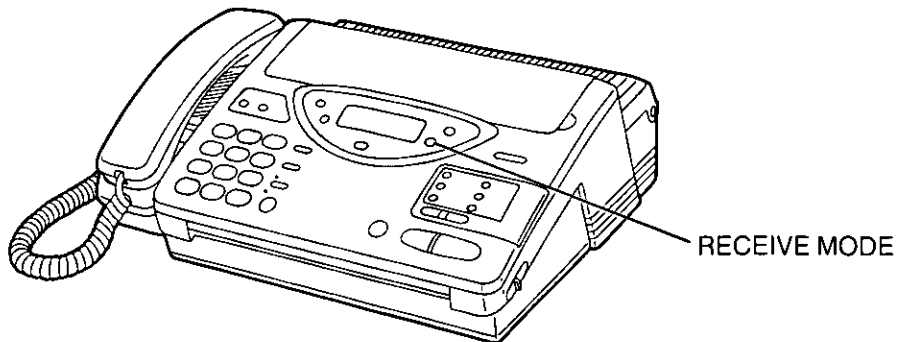

ANS/FAX mode:

When you wish to set the unit to record incoming voice messages and also receive fax messages, select this mode.
For further details, see page 22.

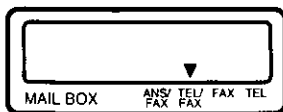

TEL/FAX mode:

When you wish to answer voice calls with ring and wish to receive fax messages without hearing ring, select this mode.
You can answer voice calls only and will not be disturbed by incoming faxes.
For further details, see page 24.

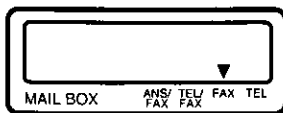

FAX mode:

When you wish to receive fax transmissions only, select this mode.
The unit will answer all calls and start to receive fax messages automatically.
For further details, see page 26.

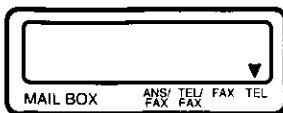

TEL mode:

When you wish to set the unit not to answer any incoming call automatically, select this mode.
When you pick up the handset and fax reception is required, you can press the **START/SET** button to receive documents.
If no one answers a call by 15 rings, the receiving mode will switch to the **ANS/FAX** mode automatically.

Note:

- Regardless of above setting, you can make voice and fax calls.

Making and Answering Voice Calls

Making voice calls

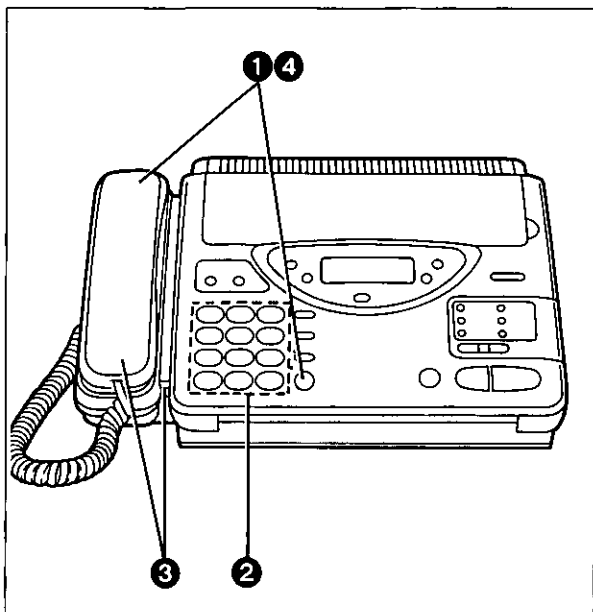

- 1 Press **SP-PHONE** or lift the handset, then listen for the dial tone.
- 2 Dial a phone number.
- 3 When the other party answers, speak through the microphone or handset.
- 4 When finished, press **SP-PHONE** again or place the handset on the cradle.

Helpful hints:

- Adjust the volume to a suitable level. See page 12.
- If you wish to switch to the handset from the speakerphone, lift the handset. To switch to the speakerphone, press the **SP-PHONE** button.
- If you misdial, press the **FLASH** button firmly, then dial the correct number.
- For helpful hints for the speakerphone operation, see page 17.

Making voice calls using automatic dialing

You can dial a phone number automatically using one-touch dialing and speed dialing. Before using automatic dialing, make sure that the desired telephone numbers have been stored in memory. For storing phone numbers, see pages 38 and 39.

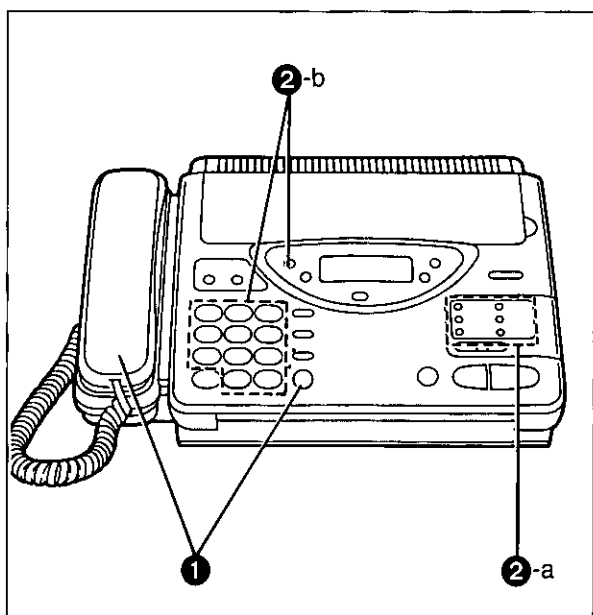

- 1 Press **SP-PHONE** or lift the handset.
- 2-a **Using one-touch dialing:**
 - When using the upper stations 1 to 5: Press the desired direct call station key.
 - When using the lower stations 6 to 10: Press **LOWER**, then press the desired direct call station key.
- 2-b **Using speed dialing:** Press **DIRECTORY**, then press # and the desired 2-digit number (00–21).

Helpful hint:

- You can also use the electronic telephone directory to make a voice call (see page 40).

Redialing the last dialed number

If the line is busy or you wish to redial the last dialed number, use the REDIAL/PAUSE button.

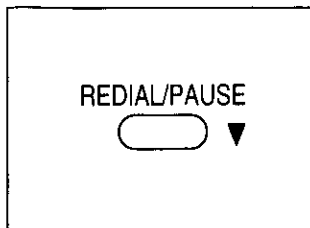

Press **SP-PHONE** or lift the handset, then press **REDIAL/PAUSE**.

Note:

- If the line is busy when using the speakerphone, the unit will automatically redial the number (see item 8 on page 75).

2

Voice muting

The MUTE button will mute your voice during a telephone conversation. Using this feature, you can hear the voice of the other party, but the other party cannot hear your voice.

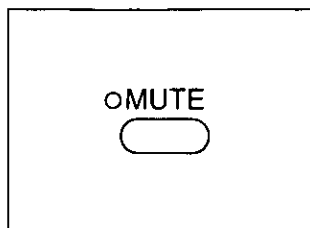

Press **MUTE** and confirm the MUTE indicator light is on.
To resume the conversation, press **MUTE** again.

Answering voice calls

When the unit rings, lift the handset or press **SP-PHONE** to answer the call.

When you have finished, replace the handset on the cradle or press **SP-PHONE**.

Note:

- For helpful hints for the speakerphone operation, see below.

Helpful hints for the speakerphone operation

- Use the speakerphone in a quiet room for best performance.
- If the other party has difficulty hearing you, decrease the volume using the **VOLUME** buttons (see page 12).
- If you and the other party speak at the same time, parts of your conversation will be lost. To avoid this, speak alternately.

Before Transmission

Acceptable documents

The unit can transmit documents that meet the following conditions.

- Document width should be from 128 to 216 mm (5 to 8½").
- Maximum document length should not exceed 600 mm (23⅝").
- Effective scanning width can be up to 208 mm (8⅜").
- Number of pages that can be set in the document feeder tray must not exceed 15 sheets.
- Document weight:
 - Single sheet: 45 to 90 g/m² (12 to 24 lb.)
 - Multiple sheets: 60 to 75 g/m² (16 to 20 lb.)

Minimum document size

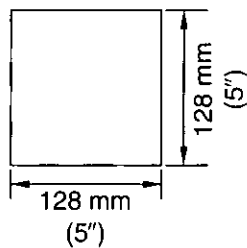

Maximum document size

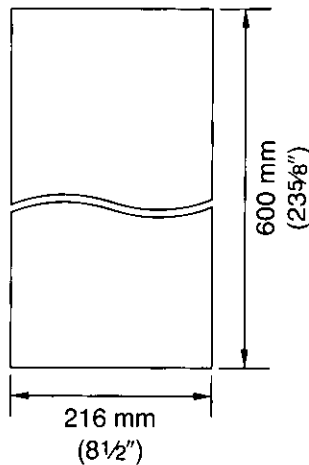

Effective scanning width

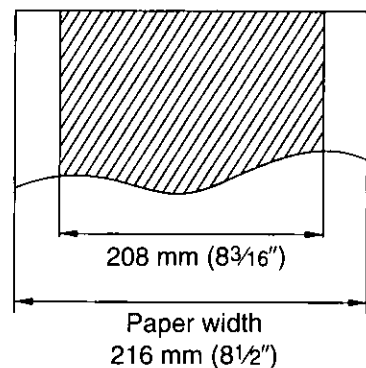

Note:

- Do not feed the following types of documents. Make a copy of these documents with a copier machine and feed the copy into the unit.
 - Paper with a chemically treated surface such as carbon paper or carbonless duplicating paper
 - Electrostatically charged paper
 - Heavily curled, creased or torn paper
 - Paper with a coated surface
 - Small-sized paper such as a slip or voucher
 - Thin paper less than 45 g/m² (12 lb.)
 - Thick paper over 90 g/m² (24 lb.)
 - Paper with faint contrast between the printing and the background
 - Paper with printing on the reverse side that can be seen through the front (e.g. newspaper)

Loading documents

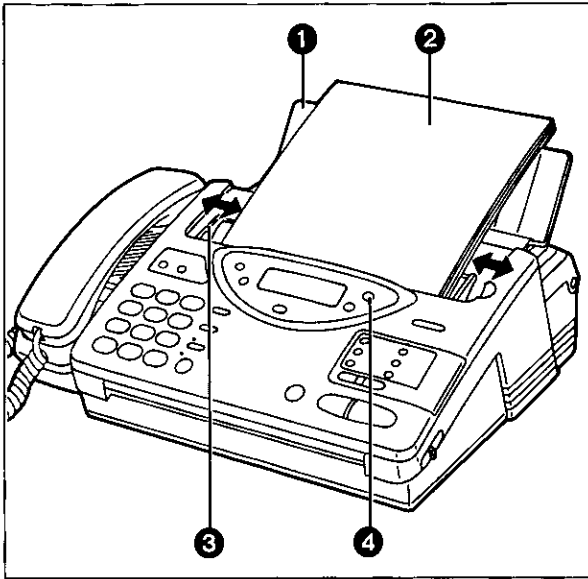

- ❶ Open the document feeder tray.
- ❷ Insert the documents **FACE DOWN** until a beep tone is heard.
—The unit can accept up to 15 sheets of paper at a time.
- ❸ Adjust the document guides to the width of the documents.
- ❹ Adjust the resolution by pressing **RESOLUTION** if needed (see below).

Notes:

- Remove clips, staples or other similar objects from a document before feeding it into the unit. Also check that all ink, paste or correction fluid on the document has completely dried.
- If the top edge of the document is curled, make it flat and insert the document.

Setting resolution

Depending on the quality of the originals, you can select the desired resolution by pressing the **RESOLUTION** button repeatedly. Use the button when the document has been fed into the unit.

STANDARD

Suitable for printed or typewritten originals with normal-sized characters.

FINE

Suitable for originals with small printing.

SUPER FINE

Suitable for originals with minute printing.

HALF TONE

Useful for originals containing photographs, shaded drawings, etc.

Notes:

- Using these features except the standard resolution will increase the transmission time.
- The super fine resolution only works between other compatible machines.
- If the setting is changed during feeding, it will be effective from the next sheet.
- To enhance the resolution settings, see page 51.

Sending 16 or more sheets

If you wish to send 16 or more sheets at a time, insert the first 15 sheets of the document. Add the extra sheets, up to 15 sheets at a time, before the last sheet is fed into the unit.

Transmitting Documents

Transmitting documents manually

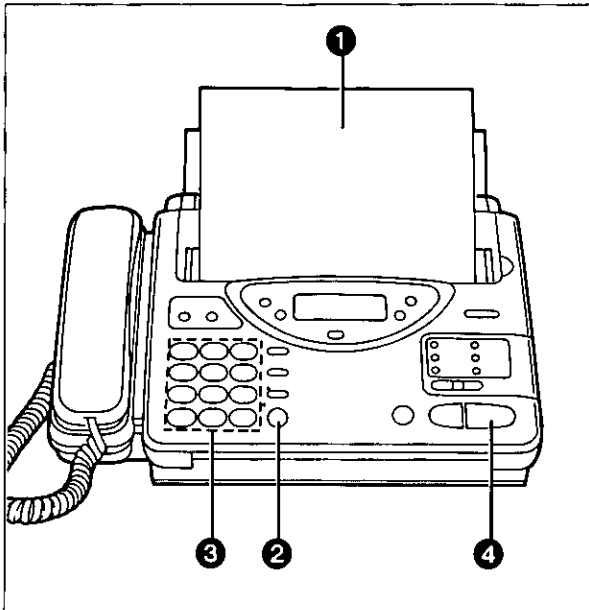

- ❶ Insert the documents **FACE DOWN** until a beep tone is heard.
- ❷ Press **SP-PHONE** or lift the handset, then listen for the dial tone.
- ❸ Dial a phone number.
- ❹ When a fax tone is heard, press **START/SET**.
- ❺ Place the handset on the cradle if using it.
—The unit will start transmission.

Notes:

- If the other party answers your call, ask them to press their start or transmit button to start the fax reception, then press your **START/SET** button.
- If there is a misdial in step 3, press the **FLASH** button firmly, then dial the correct number after the dial tone is heard.
- To interrupt the transmission, press the **STOP** button.

Transmitting documents with fewer procedures

You can transmit documents without using the handset or the SP-PHONE button.

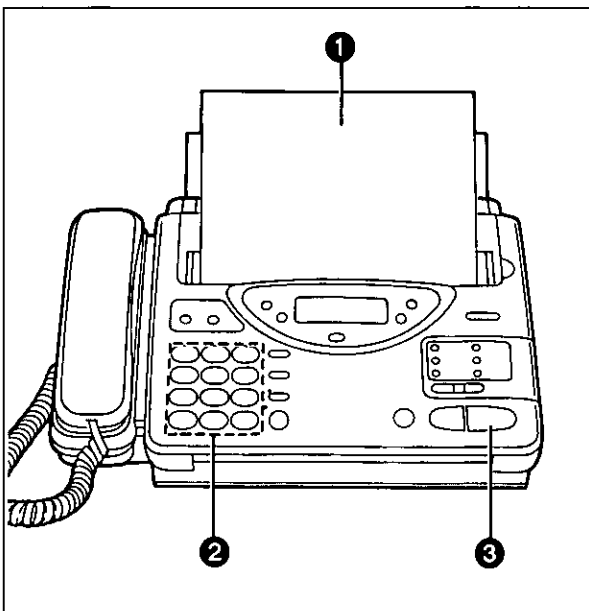

- ❶ Insert the documents **FACE DOWN** until a beep tone is heard.
- ❷ Enter the phone number.
—If incorrect, press the **STOP** button, then enter the correct number.
- ❸ Press **START/SET**.
—The unit will start to dial and transmit the documents.

Note:

- If there is no answer or the line is busy, the unit will automatically redial the number (see item 7 on page 75).

Transmitting documents using automatic dialing

You can transmit documents automatically using one-touch dialing and speed dialing. Before using automatic dialing, make sure that the desired telephone numbers have been stored in memory. For storing phone numbers, see pages 38 and 39.

Using one-touch dialing:

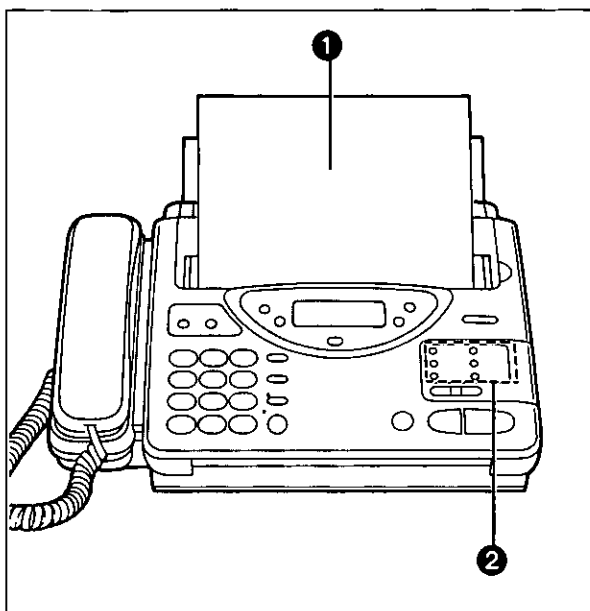

- 1 Insert the documents FACE DOWN until a beep tone is heard.
 - 2 ■ **When using the upper stations 1 to 5:**
Press the desired direct call station key.
 - **When using the lower stations 6 to 10:**
Press **LOWER**, then press the desired direct call station key.
- The unit will dial and transmit the documents automatically.

Note:

- If there is no answer or the line is busy, the unit will automatically redial the number (see item 7 on page 75).

Using speed dialing:

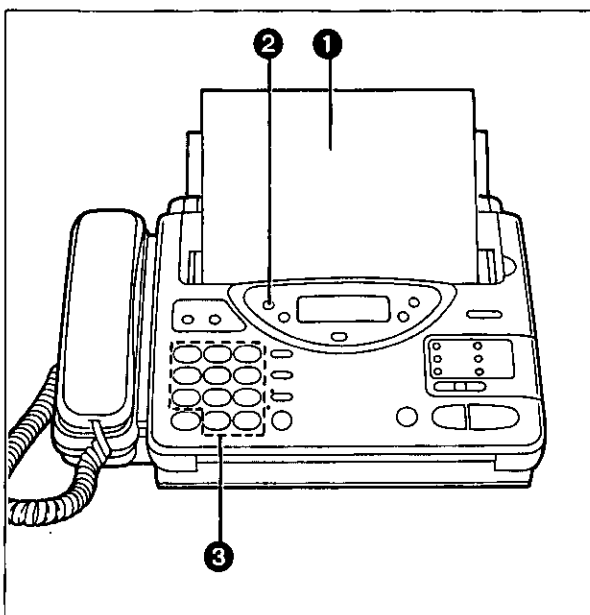

- 1 Insert the documents FACE DOWN until a beep tone is heard.
- 2 Press **DIRECTORY**.
- 3 Press #, then press the desired 2-digit number (00–21).
—The unit will dial and transmit the documents automatically.

Note:

- If there is no answer or the line is busy, the unit will automatically redial the number (see item 7 on page 75).

Receiving Documents and/or Voice Calls

Manual reception

When in the *TEL* mode or during a telephone conversation, you can receive documents as follows.

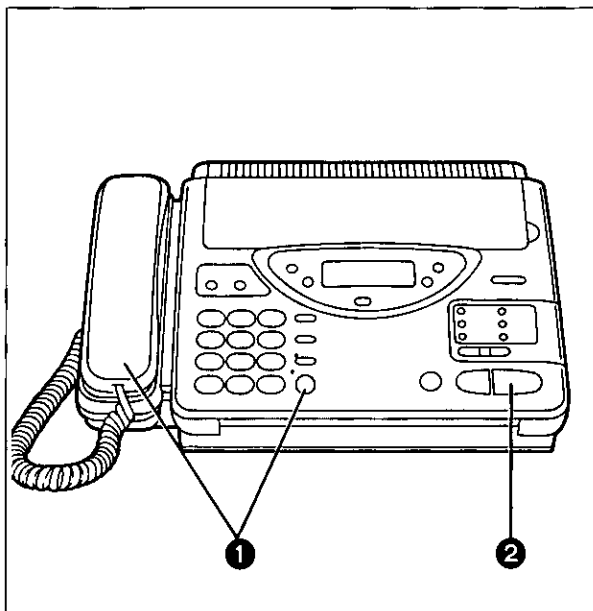

- 1 When the unit rings, press **SP-PHONE** or lift the handset to answer the call.
- 2 When document reception is required, or a slow beep or nothing is heard, press **START/SET**.
- 3 Place the handset on the cradle if using it.
—The unit will start reception.

Note:

- To interrupt reception, press the **STOP** button.
The unit will stop receiving.

Automatic reception

Set the receive mode to *ANS/FAX*, *TEL/FAX* or *FAX* by pressing **RECEIVE MODE**.

When a fax call comes in, the unit will automatically activate the fax function to receive documents.

Receiving in the ANS/FAX mode

When a call comes in, the unit will automatically answer the call after 1 to 4 rings or no rings (user programming) and distinguish between a fax and voice call.

When receiving a fax call, the unit will automatically activate the fax function to receive documents.

When receiving a voice call, the unit will play the greeting message and record an incoming voice message.

Helpful hint:

- Transmit the leaflet found on page 79 to several of your associates. This way, the user can confirm that the unit is functioning correctly and inform them of the procedure of transmitting documents and/or recording voice messages on the unit.

Setting the number of rings to answer in the ANS/FAX mode

This feature determines the number of rings after which the unit answers a call in the ANS/FAX mode.

The following choices are available:

- 1: The unit will answer after the first ring.
 - 2: The unit will answer after the second ring.
 - 3: The unit will answer after the third ring.
 - 4: The unit will answer after the fourth ring.
- Toll saver:** (see below)
Ringer off: The unit will answer without ringing.

Toll saver:

- When you call the unit from a remote location, the number of rings will tell you if there are any new voice messages or not.
 If the unit answers on the first ring, there is at least one newly recorded message.
 If the unit answers on the third ring, there are no newly recorded messages.
 Hang up immediately when you hear the second ring. The second ring indicates that there are no new messages. This will save you the toll charge for the call.

Helpful hints:

- If you wish to have the opportunity to pick up the handset before the call is answered by the unit, increase the number of rings.
- If you find there is difficulty in fax receiving from machines that have an automatic transmission feature, decrease the number of rings.

To change the setting, proceed as follows:

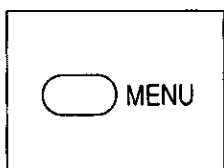
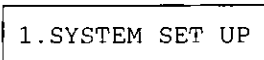
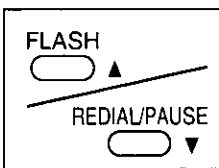
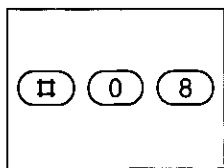
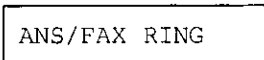
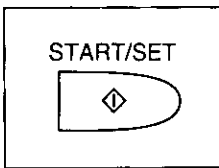
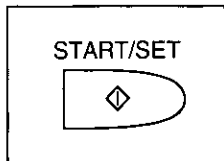
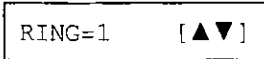
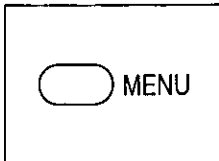
<p>1</p> 	<p>Press MENU.</p> 	<p>4</p> 	<p>Press ▲ or ▼ to select the desired number of rings.</p>
<p>2</p> 	<p>Press #08.</p> 	<p>5</p> 	<p>Press START/SET to store the setting.</p>
<p>3</p> 	<p>Press START/SET.</p> 	<p>6</p> 	<p>Press MENU to end the program.</p>

Receiving in the TEL/FAX mode

When a call comes in, the unit will work as follows.

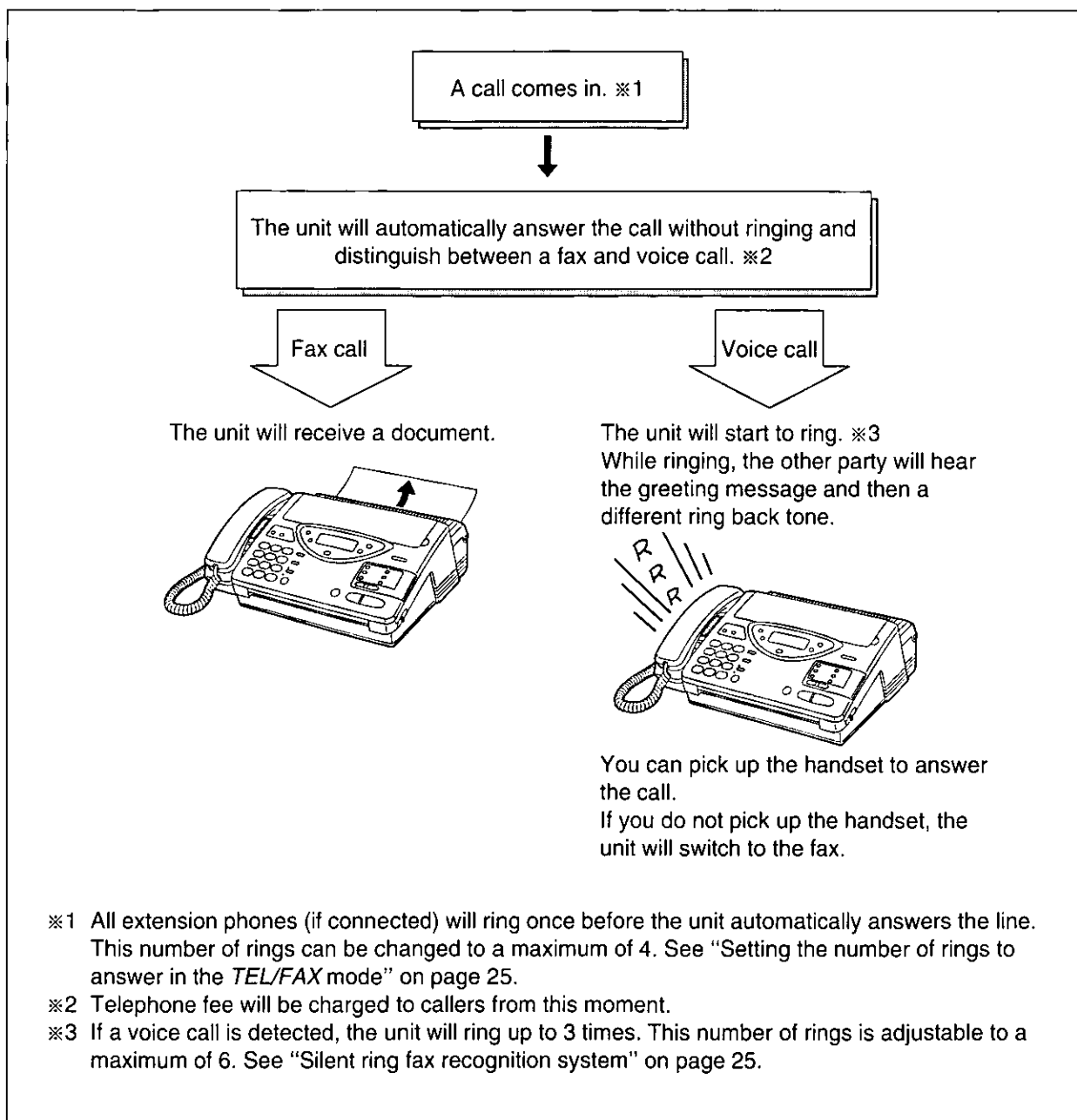

- ※1 All extension phones (if connected) will ring once before the unit automatically answers the line. This number of rings can be changed to a maximum of 4. See "Setting the number of rings to answer in the TEL/FAX mode" on page 25.
- ※2 Telephone fee will be charged to callers from this moment.
- ※3 If a voice call is detected, the unit will ring up to 3 times. This number of rings is adjustable to a maximum of 6. See "Silent ring fax recognition system" on page 25.

Notes:

- The unit can distinguish between a voice and fax call by detecting the calling tone (CNG), sent by the transmitting fax machines.
Some fax messages that are transmitted manually may not send with a calling tone. These calls must be manually received after the unit rings and the call is answered.
- If you hear the facsimile unit ringing, you can pick up the handset on the facsimile unit or another extension (if connected on the same line) to answer the call.

Setting the number of rings to answer in the TEL/FAX mode

This feature determines the number of rings after which the unit answers a call in the TEL/FAX mode. You can change the number of rings from 1 to 4 rings.

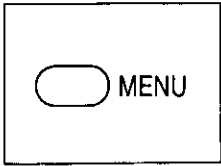
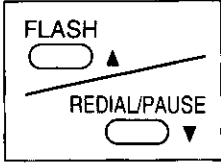
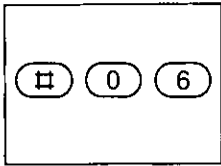
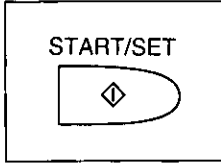
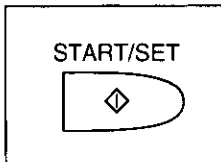
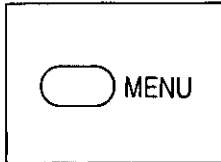
- | | | | |
|---|--|--|---|
| <p>1</p>  | <p>Press MENU.</p> <div style="border: 1px solid black; padding: 2px; width: fit-content; margin: 5px auto;">1. SYSTEM SET UP</div> | <p>4</p>  | <p>Press ▲ or ▼ to select the desired number of rings (1 to 4).</p> |
| <p>2</p>  | <p>Press #06.</p> <div style="border: 1px solid black; padding: 2px; width: fit-content; margin: 5px auto;">TEL/FAX RING</div> | <p>5</p>  | <p>Press START/SET to store the setting.</p> |
| <p>3</p>  | <p>Press START/SET.</p> <div style="border: 1px solid black; padding: 2px; width: fit-content; margin: 5px auto;">RING=1 [▲▼]</div> | <p>6</p>  | <p>Press MENU to end the program.</p> |

Note:

- If an extension telephone with a caller ID feature is connected to the same line, set the number of rings to more than 2.

Silent ring fax recognition system

In the TEL/FAX mode, when a fax call is received, the unit will automatically activate the fax function without ringing (we call this "silent ring fax recognition system"). If the unit detects a voice call, it will ring 3 times. This number of rings can be changed to a maximum of 6 by following steps below.

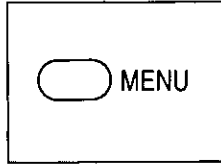
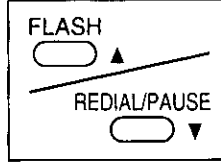
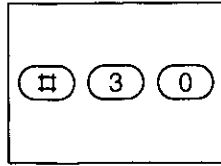
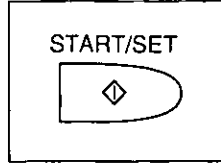
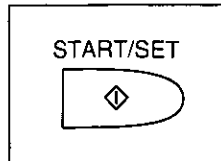
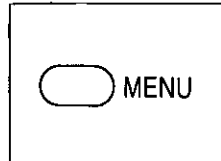
- | | | | |
|---|--|--|---|
| <p>1</p>  | <p>Press MENU.</p> <div style="border: 1px solid black; padding: 2px; width: fit-content; margin: 5px auto;">1. SYSTEM SET UP</div> | <p>4</p>  | <p>Press ▲ or ▼ to select the desired number of rings (3 to 6).</p> |
| <p>2</p>  | <p>Press #30.</p> <div style="border: 1px solid black; padding: 2px; width: fit-content; margin: 5px auto;">SILENT FAX RING</div> | <p>5</p>  | <p>Press START/SET to store the setting.</p> |
| <p>3</p>  | <p>Press START/SET.</p> <div style="border: 1px solid black; padding: 2px; width: fit-content; margin: 5px auto;">RING=3 [▲▼]</div> | <p>6</p>  | <p>Press MENU to end the program.</p> |

Receiving in the FAX mode

When a call comes in, the unit will automatically answer the line after 1 to 4 rings (user programming) and activate the fax function.

Setting the number of rings to answer in the FAX mode

This feature determines the number of rings after which the unit answers a call in the FAX mode. You can change the number of rings from 1 to 4 rings.

Helpful hints:

- If you wish to have the opportunity to answer a call before the unit does, increase the number of rings.
- If you find there is difficulty in fax receiving from machines that have an automatic transmission feature, decrease the number of rings.

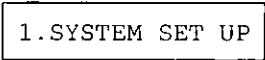
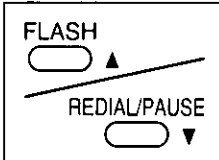
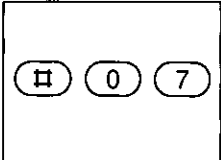
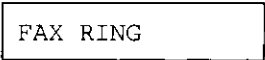
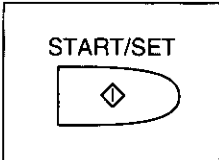
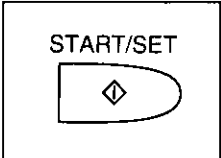
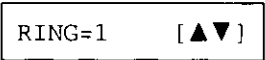
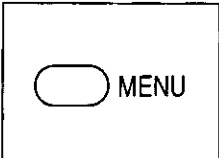
<p>1</p> 	<p>Press MENU.</p> 	<p>4</p> 	<p>Press ▲ or ▼ to select the desired number of rings (1 to 4).</p>
<p>2</p> 	<p>Press #07.</p> 	<p>5</p> 	<p>Press START/SET to store the setting.</p>
<p>3</p> 	<p>Press START/SET.</p> 	<p>6</p> 	<p>Press MENU to end the program.</p>

Note:

- If an extension telephone with a caller ID feature is connected to the same line, set the number of rings to more than 2.

Making a Copy

Any transmissible document can be copied (see page 18). To make a copy, follow the steps below.

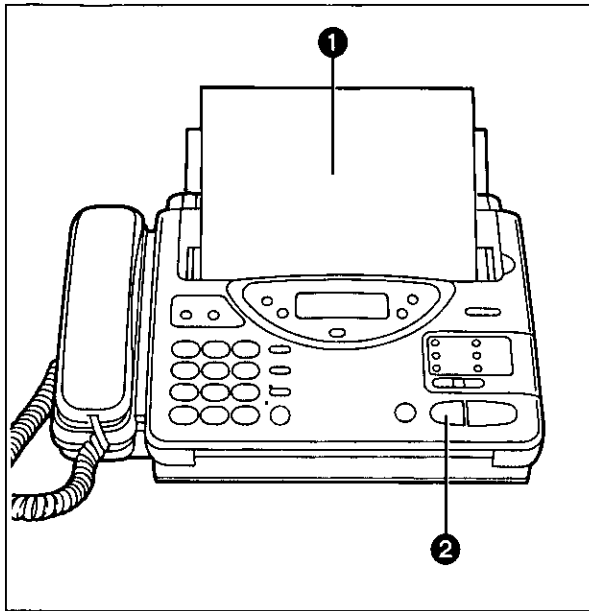

- ❶ Insert the documents **FACE DOWN**.
- ❷ Press **COPY**.
—The unit will start copying.

Notes:

- When copying, the unit will automatically select the **FINE** resolution. Depending on the originals, select the desired resolution (see page 19).
- You can make or receive voice calls while making a copy.
- To interrupt a copy, press the **STOP** button. The unit will stop copy operation and eject the documents.

Operating the Answering Device

Setup of voice message and document reception

The unit can save a total of 15 minutes of voice recordings in memory. The unit has four memory locations—common memory and three mailbox memories.

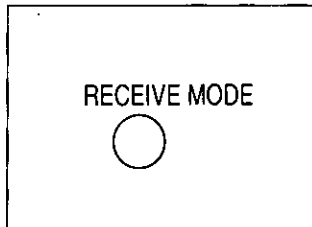

To set the unit to record incoming voice messages and receive documents, select **ANS/FAX** mode by pressing **RECEIVE MODE**.

—The display will show the time remaining for recording incoming messages for about 2 seconds.

TIME LEFT=12MIN

Notes:

- If the incoming messages are noisy, the recording time might be less than 15 minutes.
- The recording time for incoming messages can be set to "unlimited" (preset setting) or "1 minute". To change the recording time, see page 14.
- When the remaining time is little, erase useless messages from memory (see page 29).

Listening to recorded messages

When new incoming messages have been recorded, the **NEW MESSAGES** indicator will flash and the call counter will show the total number of messages.

If a message alert feature is set to on, the unit will alert the user with a slow beep if a caller's message has been recorded (see page 31).

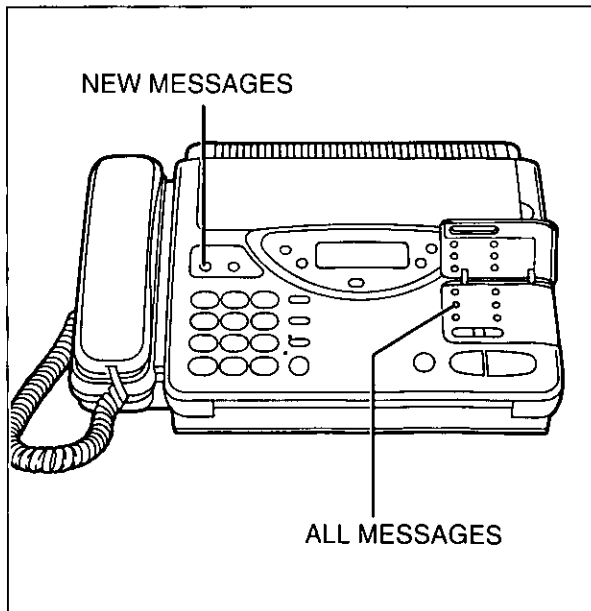

■ Playing back newly recorded messages:

Press **NEW MESSAGES**.

—The unit will begin to play back new messages.

At the end of the last message, 3 beeps will sound.

■ Playing back all the recorded messages:

Open the station key panel and press

ALL MESSAGES.

—The unit will begin to play back all the recorded messages.

At the end of the last message, 3 beeps will sound.

During the playback, the display will show the day and time when the message was recorded, along with the recorded order of the message.

MON 12:00AM 01

Saving messages:

The unit will save the incoming messages automatically, if the user does not erase them.

Note:

- The time remaining for recording incoming messages will appear on the display for about 2 seconds whenever the station key panel is opened.

Functions during playback

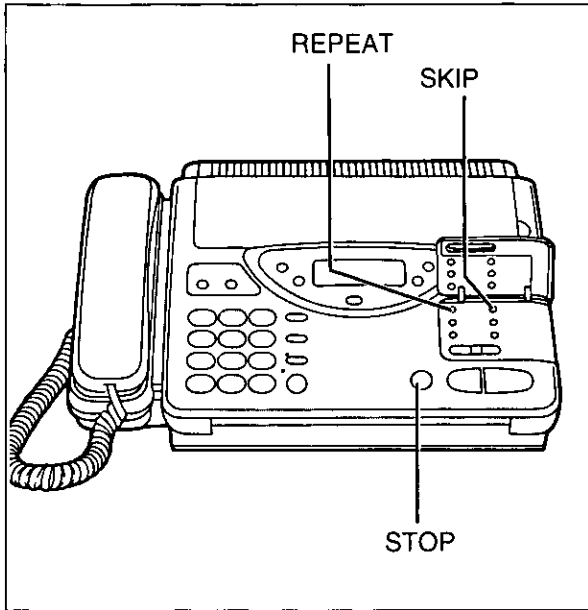

■ **Repeating a message:**

Press **REPEAT** to play back the previous message.

■ **Skipping a message:**

Press **SKIP** to skip to the next message.

■ **Stopping playback:**

Press **STOP**.

—If you wish to resume playback, press the **NEW MESSAGES** or **ALL MESSAGES** button within 1 minute after pressing the **STOP** button.

Note:

● *These functions can be used while recorded messages in a mailbox are being played back (see page 56).*

Erasing recorded messages

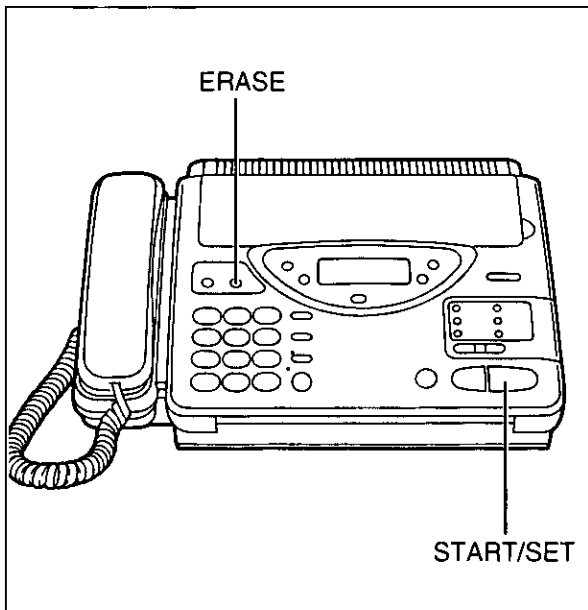

■ **Erasing a specific message from memory:**

Press **ERASE** while the message you want to erase is being played.

■ **Erasing all messages from memory:**

1. Press **ERASE** after listening to all the messages.

ICM ERASE OK?

2. Press **START/SET** for confirmation.

ERASE COMPLETED

—The unit will erase all the recorded messages in the common memory.

—If this feature is not required, press the **ERASE** button again or the **STOP** button instead of the **START/SET** button.

Note:

● *These features can be used for the mailbox feature. To erase messages in a mailbox, you must first select the mailbox by pressing the **MAIL BOX** button (see page 56).*

Recording a memo message

If the user is going out and wants to leave a private message for someone, they can record a voice memo in the unit. This can be played back afterward either directly or remotely, exactly like any other messages.

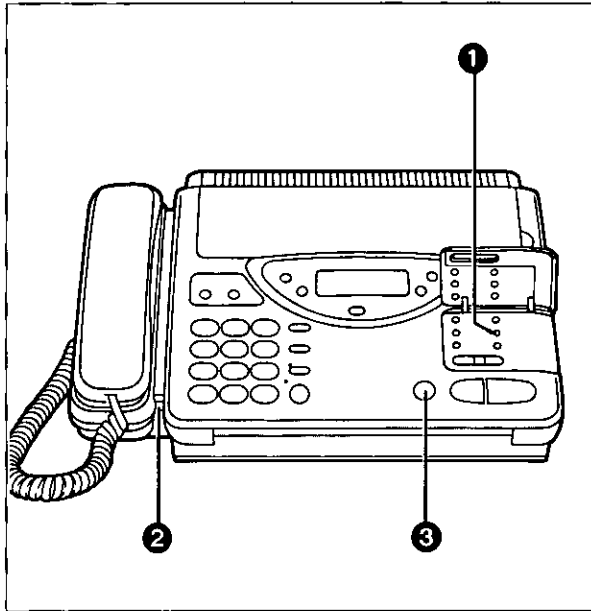

- 1 Open the station key panel, then press **MEMO/2WAY REC.**
- 2 Immediately after the beep, speak clearly and loudly toward the microphone.
- 3 When finished, press **MEMO/2WAY REC** again or **STOP**.
—The call counter on the display will increase by one.

Notes:

- When memory becomes full while recording, the unit will stop recording automatically and 6 beeps will be heard. Erase some or all messages (see page 29).
- This feature can be used for the mailbox feature. To record in a specific mailbox, you must first select the mailbox by pressing the **MAIL BOX** button. Then proceed the above steps.

Recording a telephone conversation

While speaking with someone on the telephone, the conversation can be recorded.

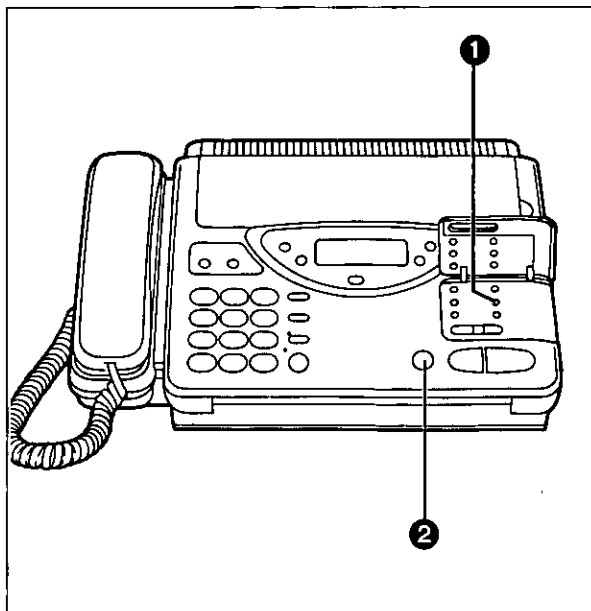

- 1 During the conversation, open the station key panel and press **MEMO/2WAY REC.**

2WAY RECORDING

- 2 To stop recording, press **MEMO/2WAY REC** again or **STOP**.
or
Hang up after the conversation.
—The call counter on the display will increase by one.

Notes:

- There may be imposed regulations in your area (state) concerning the manner in which 2-way telephone conversations may be recorded. So you should inform the other party that the conversation is being recorded. Consult your local telephone company for further information.
- This feature can be used for the mailbox feature. To record in a specific mailbox, you must first select the mailbox by pressing the **MAIL BOX** button. Then proceed the above steps.

Setting the message alert

When this feature is on, the unit will let you know with a slow beep if a caller's message has been recorded in the common memory.

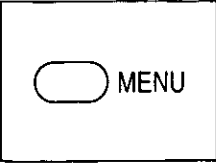
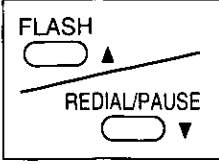
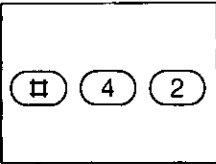
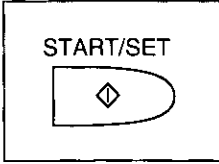
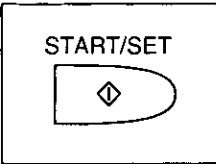
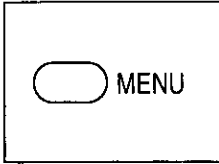
<p>1</p> 	<p>Press MENU.</p> <div style="border: 1px solid black; padding: 2px; width: fit-content; margin: 5px auto;">1. SYSTEM SET UP</div>	<p>4</p> 	<p>Press ▲ or ▼ to select "ON". —If this feature is not required, select "OFF".</p>
<p>2</p> 	<p>Press #42.</p> <div style="border: 1px solid black; padding: 2px; width: fit-content; margin: 5px auto;">MESSAGE ALERT</div>	<p>5</p> 	<p>Press START/SET to store the setting.</p>
<p>3</p> 	<p>Press START/SET.</p> <div style="border: 1px solid black; padding: 2px; width: fit-content; margin: 5px auto;">MODE=OFF [▲▼]</div>	<p>6</p> 	<p>Press MENU to end the program.</p>

Note:

- The feature does not work when an incoming message is recorded in the mailbox.

Setting the recording time alert

With this feature, when the remaining time to record incoming messages becomes less than 60 seconds, the unit will alert the user with a slow beep.

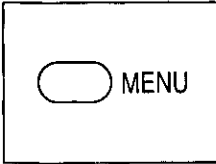
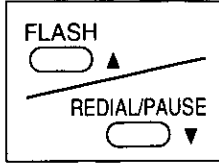
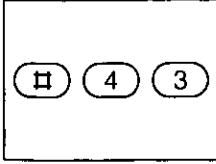
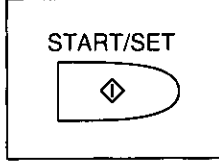
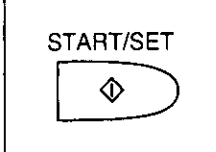
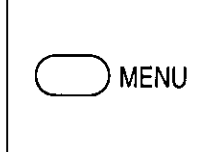
<p>1</p> 	<p>Press MENU.</p> <div style="border: 1px solid black; padding: 2px; width: fit-content; margin: 5px auto;">1. SYSTEM SET UP</div>	<p>4</p> 	<p>Press ▲ or ▼ to select "ON". —If this feature is not required, select "OFF".</p>
<p>2</p> 	<p>Press #43.</p> <div style="border: 1px solid black; padding: 2px; width: fit-content; margin: 5px auto;">REC. TIME ALERT</div>	<p>5</p> 	<p>Press START/SET to store the setting.</p>
<p>3</p> 	<p>Press START/SET.</p> <div style="border: 1px solid black; padding: 2px; width: fit-content; margin: 5px auto;">MODE=OFF [▲▼]</div>	<p>6</p> 	<p>Press MENU to end the program.</p>

User Programmable Features

The unit has the following programming features.

Basic features are the settings that need to be programmed upon completing the installation. Most probable choices have been pre-selected, but some features, such as codes #01, #02 and #03, must be programmed by user.

Advanced features should be programmed as the need arises.

Programming feature table

Basic features

Code	Feature	Description	Selection	Page
#01	SET DATE & TIME	Setting the current date and time.		36
#02	YOUR LOGO	Setting your company name or personal name.	up to 30 digits	36
#03	YOUR TELEPHONE NUMBER	Setting your facsimile telephone number.	up to 20 digits	37
#04	PRINT TRANSMISSION REPORT	Setting individual transmission report printing.	<u>ERROR/</u> ON/ OFF	37
#06	TEL/FAX DELAYED RING	Setting the number of rings on the extension phone (if connected) before the unit answers a call in the TEL/FAX mode.	<u>1/2/3/4</u>	25
#07	FAX RING COUNT	Setting the number of rings to answer in the FAX mode.	<u>1/2/3/4</u>	26
#08	ANS/FAX RING COUNT	Setting the number of rings to answer in the ANS/FAX mode.	<u>1/2/3/4/</u> TOLL SAVER/ RINGER OFF	23
#09	RECORDING TIME FOR ANS	Setting the recording time for incoming message.	<u>VOX (unlimited)/</u> 1 MIN (1minute)	14
#10	REMOTE ANS ID	Setting the remote control ID for remote operation of the answering device.	1–3 digits <u>(111)</u>	59

Note: In the "Selection" column, the underlined print indicates the pre-selected settings.

Advanced features

Code	Feature	Description	Selection	Page
#21	LOGO POSITION	Setting the logo print position on the transmitted document.	<u>OUT/IN/OFF</u>	47
#22	JOURNAL AUTO PRINT	Printing journal report automatically.	<u>ON/OFF</u>	67
#23	OVERSEAS MODE	Setting the overseas transmission mode.	<u>ON/OFF</u>	47
#24	JUNK MAIL PROHIBITOR	Turning on the junk mail prohibitor feature. Also setting the prohibitor ID.	<u>ON/OFF</u> ID=2 digits (22)	45
#25	DELAYED TRANSMISSION	Setting the delayed transmission.	<u>ON/OFF</u>	42
#30	SILENT FAX RECOGNITION RING	Setting the number of rings when receiving a voice call in the TEL/FAX mode.	<u>3</u> to 6 rings	25
#32	DAY/NIGHT MODE	Turning on the day/night mode.	<u>ON/OFF</u>	48
#33	PAPER SAVE FUNCTION	Setting the paper save reception/copy.	<u>ON/OFF</u>	49
#34	EXTENSION COPY	Copying a document twice in length.		50
#41	REMOTE FAX ACTIVATION CODE	Setting the remote fax activation code for remote receiving using an extension phone.	up to 4 digits (* *)	44
#42	MESSAGE ALERT	Turning on the message alert.	<u>ON/OFF</u>	31
#43	RECORDING TIME ALERT	Turning on the recording time alert.	<u>ON/OFF</u>	31
#46	ORIGINAL SETTING	Setting the contrast mode.	<u>NORMAL/</u> <u>LIGHT/</u> <u>DARKER</u>	51
#50	MAIL BOX ALERT	Turning on the mailbox alert.	<u>ON/OFF</u>	57
#51	BOX1 PASSWORD	Setting password for mailbox-1.	3 digits (<u>555</u>)	55
#52	BOX2 PASSWORD	Setting password for mailbox-2.	3 digits (<u>555</u>)	55
#53	BOX3 PASSWORD	Setting password for mailbox-3.	3 digits (<u>555</u>)	55
#60	COMMON PAGER	Setting the phone number for common pager.	<u>ON/OFF</u>	63
#61	MAIL BOX1 PAGER	Setting the phone number for mailbox-1 pager.	<u>ON/OFF</u>	63
#62	MAIL BOX2 PAGER	Setting the phone number for mailbox-2 pager.	<u>ON/OFF</u>	63
#63	MAIL BOX3 PAGER	Setting the phone number for mailbox-3 pager.	<u>ON/OFF</u>	63
#80	SET DEFAULT	Resetting the parameters of the advanced features.	<u>YES/NO</u>	51

Note: In the "Selection" column, the underlined print indicates the pre-selected settings.

How to enter letters and symbols

The dial keypad and the direct call station 1 are used as alphabet and symbol character input keys when you enter your logo and station names for automatic dialers.

To enter characters

Pressing each key will alternately select a character as shown below. When the desired character is displayed, press # to move the cursor to the right and enter the next character.

Keys	Number of pressing times												
	1	2	3	4	5	6	7	8	9	10	11	12	13
1	1	[]	{	}	+	-	/	=	,	.	_	'
2	A	B	C	a	b	c	2						
3	D	E	F	d	e	f	3						
4	G	H	I	g	h	i	4						
5	J	K	L	j	k	l	5						
6	M	N	O	m	n	o	6						
7	P	Q	R	S	p	q	r	s	7				
8	T	U	V	t	u	v	8						
9	W	X	Y	Z	w	x	y	z	9				
0	0	()	<	>	!	"	#	\$	%	&	¥	
0	:	;	?		*	@	^	'	→				
*	◀ key (Used to move the cursor to the left)												
□	▶ key (Used to move the cursor to the right)												

For example, when entering "Mike" as your logo:

- ① Press 6 once, then press #.

LOGO=M

- ② Press 4 six times, then press #.

LOGO=Mi

- ③ Press 5 five times, then press #.

LOGO=Mik

- ④ Press 3 five times.

LOGO=Mike

Note:

- If you make a mistake while programming, use # or * to move the cursor to the incorrect character, then make the correction.

Special uses of the direct call station keys

Direct call stations 2, 4 and 5 are used as command keys.

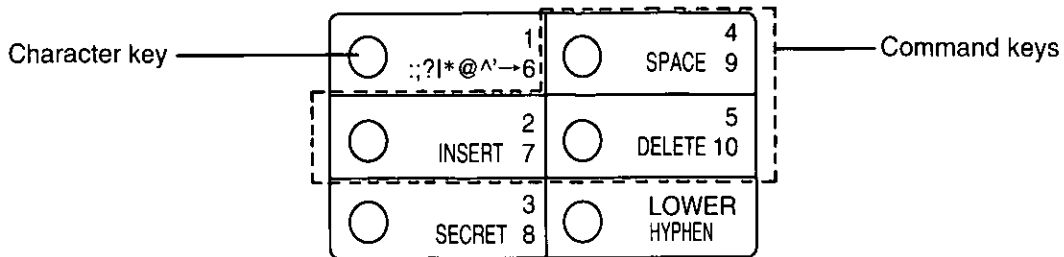

The layout of the direct call station keys is printed on the reverse side of the directory card.

1. Remove the directory card cover with a pencil or similar object as shown.
2. Turn over the directory card. You will find how each command is assigned to the direct call station keys.

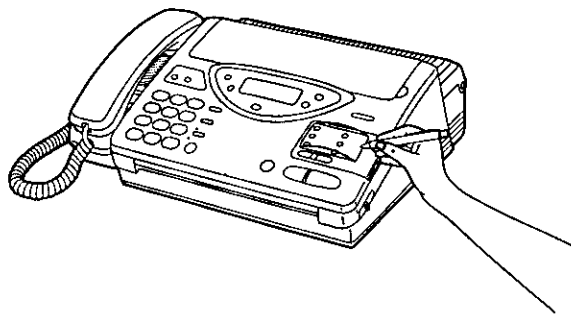

■ Direct call station 2 (INSERT):

This key is used to insert one character (or one space) in the programmed logo.

Example: Compny→Compny

1. Press # or * repeatedly until the cursor is positioned on "n".

LOGO=Compny

2. Press **INSERT**.

LOGO=Comp ny

3. Press **2** repeatedly until "a" is shown.

LOGO=Company

■ Direct call station 4 (SPACE):

This key is used to replace one character with a space.

■ Direct call station 5 (DELETE):

This key is used to delete one character from the programmed logo.

Example: Company→Company

1. Press # or * repeatedly until the cursor is positioned on "n".



LOGO=Company

2. Press **DELETE**.

LOGO=Company

Setting the date and time

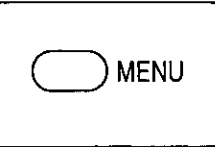
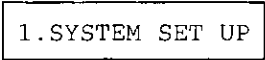
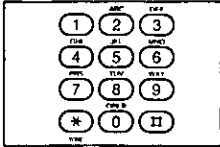
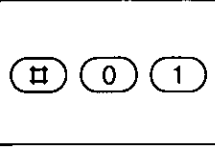
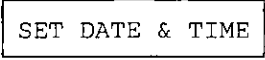
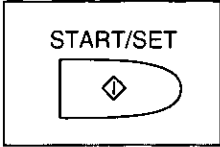
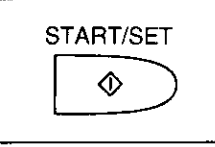
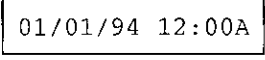
The internal clock of the unit will print the date and time, on the top line of all fax messages you transmit, and on the fax communication reports such as the journal report and the transmission report.

<p>1</p> 	<p>Press MENU.</p> 	<p>4</p> 	<p>Enter the current month/day/year/hour/minute by selecting each 2 digits. Then press * for AM or press # for PM.</p>
<p>2</p> 	<p>Press #01.</p> 	<p>5</p> 	<p>Press START/SET to store the setting.</p>
<p>3</p> 	<p>Press START/SET.</p> 	<p>6</p> 	<p>Press MENU to end the program.</p>

Example:



Aug. 10 1994, 3:00 PM
Press 08 10 94 03 00,
then press # to select PM.

Notes:

- When you make a mistake while programming, press the STOP button, then make the correction.
- The accuracy of the clock will be approximately ± 45 seconds a month at room temperature.

Setting your logo

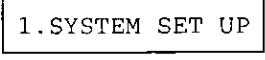
The logo is used to identify fax messages that are being transmitted by your unit. It may consist of alpha-numeric letters and symbols. Usually the logo is a company, division or personal name in an abbreviated form.

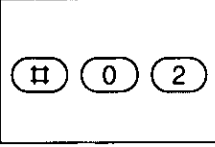
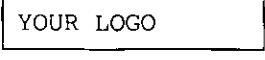
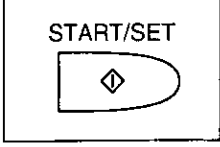
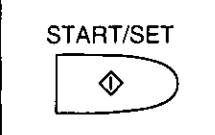
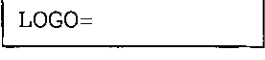
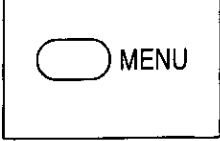
<p>1</p> 	<p>Press MENU.</p> 	<p>4</p> 	<p>Enter your logo up to 30 characters by following the instructions on page 34.</p>
<p>2</p> 	<p>Press #02.</p> 	<p>5</p> 	<p>Press START/SET to store the setting.</p>
<p>3</p> 	<p>Press START/SET.</p> 	<p>6</p> 	<p>Press MENU to end the program.</p>

Note:

- When the first character is entered, the preset logo will be cleared.

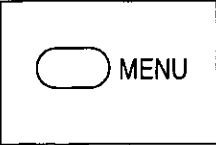

Setting your facsimile telephone number

Your programmed phone number will be printed on the top of each page transmitted from your unit.

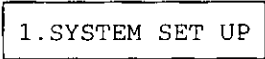
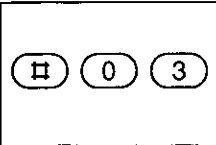
- 1**  Press **MENU**.

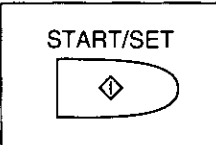
- 2**  Press **#03**.

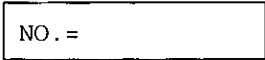
- 3**  Press **START/SET**.

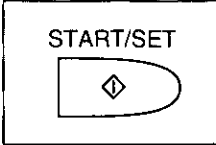
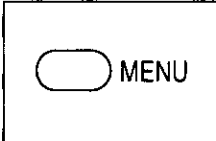
- 4**  Enter your facsimile telephone number up to 20 digits.
—The # button provides a space and the * button provides "+".
- 5**  Press **START/SET** to store the setting.
- 6**  Press **MENU** to end the program.

Setting the transmission report printing

Each time a document is transmitted, this feature will give you a printed record of the transmission.

The following choices are available:

ERROR: The report will print only when the transmission fails.

ON: The report will print, indicating whether the transmission is successful or not.

OFF: The report will not print.

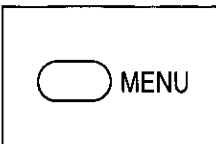

Sample of transmission report:

XMT REPORT						
						Jan. 01 1994 12:09AM
NO.	OTHER FACSIMILE	START TIME	USAGE TIME	MODE	PAGES	RESULT
01	COMPANY ABC	Jan. 01 12:08AM	01'05	TX	01	OK

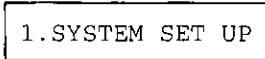
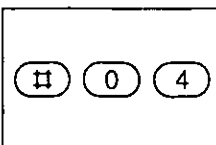
- 1**  Press **MENU**.

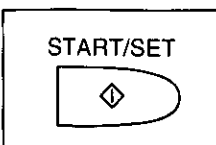
- 2**  Press **#04**.

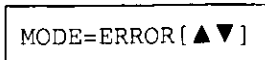
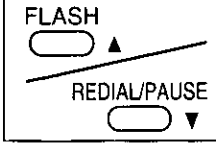
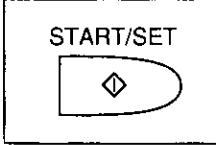
- 3**  Press **START/SET**.

- 4**  Press **▲** or **▼** to select the desired mode.
- 5**  Press **START/SET** to store the setting.
- 6**  Press **MENU** to end the program.

Storing Phone Numbers for Automatic Dialing

The unit's memory allows you to use both one-touch dialing (up to 10 phone numbers) and speed dialing (up to 22 phone numbers) for rapid access to your most frequently dialed numbers.

One-touch dialing: The unit is equipped with 5 direct call station keys, each of which is divided into an upper station and a lower station.

Speed dialing: The unit is equipped with additional 22 dialing stations. These stations are assigned to 2-digit numbers (00–21).

Storing phone numbers for one-touch dialing

Each station can store a phone number up to 30 digits in length and the associated station name up to 10 alpha-numeric characters.

- 1**  Press **MENU** repeatedly until the following is displayed.

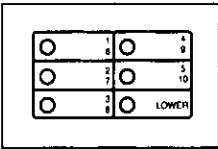
2. STORE TEL NO.
- 2**  **For upper stations 1 to 5:** Press one of the direct call station keys.
Example: Station 4



<S04>=

or

For lower stations 6 to 10: Press **LOWER**, then press one of the direct call station keys.
Example: Station 8

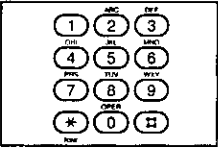
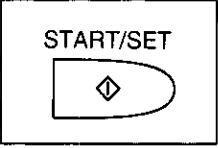
<LWR>

<S08>=
- 3**  Enter a phone number.
- 4**  Press **START/SET** to store the number.

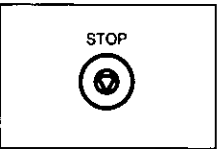



NAME=
- 5**  Enter the station name by following the instructions on page 34.
- 6**  Press **START/SET** to store the station name.
—To program other stations, repeat from step 2.
- 7**  Press **STOP** to end the program.

Notes:

- To enter a hyphen in a phone number, press the **LOWER** key. A hyphen is counted as 2 digits.
- If you make a mistake while programming, press the **STOP** button, then make the correction.
- To erase a programmed phone number in step 3, press the **STOP** button when the cursor is positioned on the beginning of the number.
- Confirm that phone numbers and their station names have been correctly stored by printing the telephone number list. See page 64.

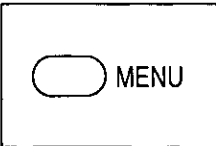
Storing phone numbers for speed dialing

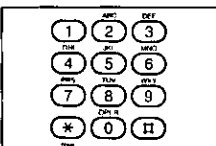
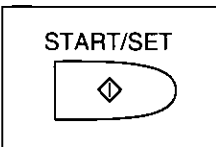
Each dialing station can store a phone number up to 30 digits in length and the associated station name up to 10 alpha-numeric characters.

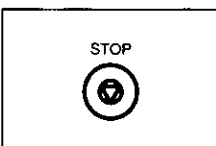
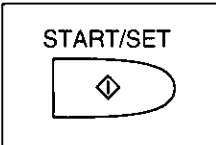
<p>1</p> 	<p>Press MENU repeatedly until the following is displayed.</p> <div style="border: 1px solid black; padding: 5px; width: fit-content; margin: 10px auto;">2. STORE TEL NO.</div>	<p>5</p> 	<p>Enter the station name by following the instructions on page 34.</p>
<p>2</p> 	<p>Press #, then press a 2-digit number (00–21). Example: Station #00</p> <div style="border: 1px solid black; padding: 5px; width: fit-content; margin: 10px auto;"><A00>=</div>	<p>6</p> 	<p>Press START/SET to store the station name. —To program other stations, repeat from step 2.</p>
<p>3</p> 	<p>Enter a phone number.</p>	<p>7</p> 	<p>Press STOP to end the program.</p>
<p>4</p> 	<p>Press START/SET to store the number.</p> <div style="border: 1px solid black; padding: 5px; width: fit-content; margin: 10px auto;">NAME=</div>		

Notes:

- To enter a hyphen in a phone number, press the LOWER key. A hyphen is counted as 2 digits.
- If you make a mistake while programming, press the STOP button, then make the correction.
- To erase a programmed phone number in step 3, press the STOP button when the cursor is positioned on the beginning of the number.
- Confirm that phone numbers and their station names have been correctly stored by printing the telephone number list (see page 64).

To keep a phone number secret

Use this feature to keep a whole phone number or a portion of a phone number secret. When the telephone number list is printed out (see pages 64 and 65), secret numbers will not be printed.

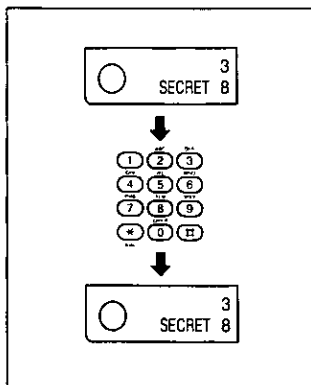

Using the SECRET (direct call station 3) button:

Press **SECRET** before and behind the phone number you wish to keep secret.

Example: The phone number you wish to keep secret is 12345.
Press **SECRET**, 1 2 3 4 5 and **SECRET** again.

<A01>= [12345]

Note:

- Pressing the **SECRET** button once counts as two digits.

Electronic Telephone Directory

The station names stored in memory for automatic dialing will be automatically registered in the electronic telephone directory in alphabetical order.

With the electronic telephone directory feature, you can make a fax or voice call by selecting the desired station name on the display.

How to use the electronic telephone directory

To search a station name and make a voice or fax call, proceed as follows.
If you wish to send a fax, insert the documents into the document feeder first.

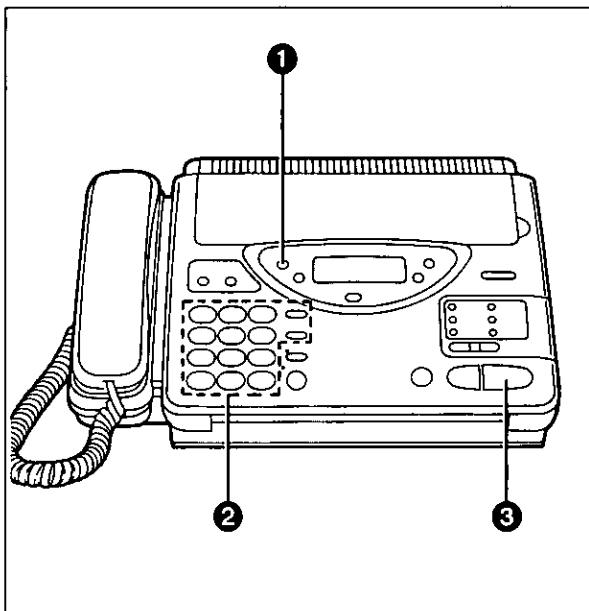

1 Press **DIRECTORY**.

SELECT INDEX

2 ■ Press a dial key to which the initial of a station name is assigned (see Index table).

Example: To search a name with the initial "N"

Press 6 repeatedly until the first station name with the initial "N" is displayed and press ▼ until the desired name is displayed.

or

■ Press ▲ or ▼ repeatedly until the desired name is displayed.

3 Press **START/SET**.

—The unit will start dialing.

—If a document has been fed into the unit, the transmission will start.

Index table

Dial key	Index	Dial key	Index
1	1	7	P, Q, R, S, 7
2	A, B, C, 2	8	T, U, V, 8
3	D, E, F, 3	9	W, X, Y, Z, 9
4	G, H, I, 4	0	0
5	J, K, L, 5	*	Other symbols
6	M, N, O, 6	#	(Used for speed dialing. See pages 16 and 21.)

Polling

Polling means that you call another facsimile machine to retrieve a document. On the other hand, the documents loaded on your unit can be retrieved only at the request of the calling machines (we call this "Polled" mode).

Polling reception

Make sure that no documents have been fed into your unit and that the other party's machine is ready for your call.

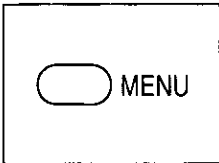
- 1**  Press **MENU** repeatedly until the following is displayed.

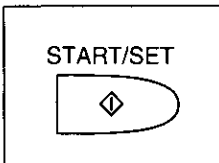
4 . POLLING
- 2**  Press **START/SET**.

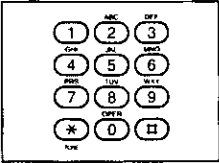
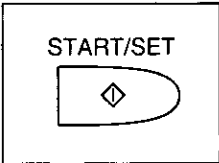
NO. =
- 3**  Enter the phone number by using one-touch dialing, speed dialing or a full number.
- 4**  Press **START/SET**.
—The unit will start polling.

Notes:

- The receiving unit incurs any telephone charges.
- If there is no answer or the line is busy, the unit will automatically redial the number (see item 7 on page 75).

Polling transmission (Polled)

To let other machines retrieve documents loaded on your unit, proceed as follows.

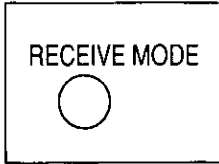
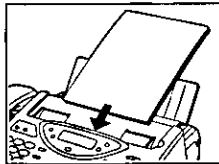
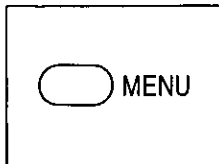
- 1**  Set the unit in the **ANS/FAX, TEL/FAX** or **FAX** mode by pressing **RECEIVE MODE**.
- 2**  Insert the documents **FACE DOWN**.
- 3**  Press **MENU** repeatedly until the following is displayed.

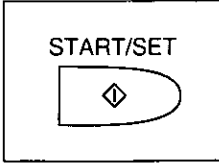
5 . POLLED
- 4**  Press **START/SET**.

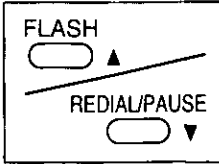
MODE=OFF [▲▼]
- 5**  Press **▲** or **▼** to select "ON".

MODE=ON [▲▼]

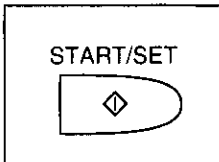
—If this feature is not required, select "OFF".
- 6**  Press **START/SET**.

POLLED ON

Note:

- When delayed transmission (see page 42) is set to ON, this feature is not available.

Delayed Transmission

Using a built-in clock, this unit can send documents automatically at a specific time. This allows you to take advantage of low-cost calling hours given by some telephone companies.

The delayed transmission can be reserved to take place up to 24 hours.

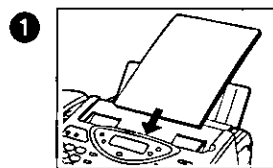

1 Insert the documents
FACE DOWN.

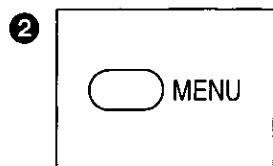

2 Press **MENU**.

1. SYSTEM SET UP

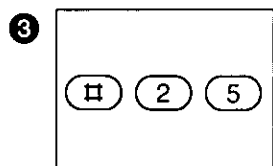

3 Press **#25**.

DELAYED XMT

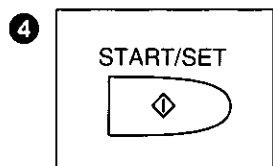

4 Press **START/SET**.

MODE=OFF [▲▼]

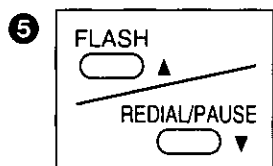

5 Press **▲** or **▼** to select
"ON".

MODE=ON [▲▼]

—If this feature is not
required, select "OFF".

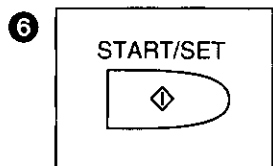

6 Press **START/SET**.

NO. =

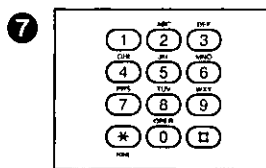

7 Enter the phone number
using one-touch dialing,
speed dialing or a full
number.

—You can use the
electronic telephone
directory (see
page 40).

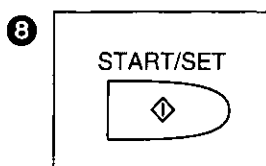

8 Press **START/SET**
to store the number.

TIME=12:00AM

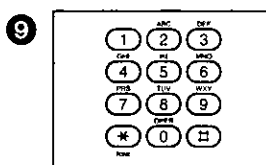

9 Enter the transmission
start time.

Example: 11:00PM

Press **1100**, then press **#**
to select PM.

—To select AM, press *****.

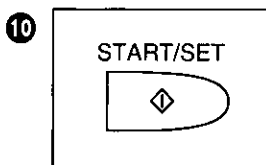

10 Press **START/SET**
to store the setting.

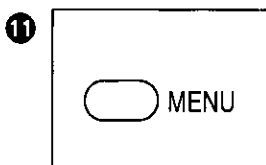

11 Press **MENU** to end the
program.

—When the
programmed time has
come, the unit will
automatically start
transmission.

Notes:

- If there is no answer or the line is busy, the unit will automatically redial the number (see item 7 on page 75).
- You can receive, transmit and copy documents while the delayed transmission is set. To copy or transmit documents, remove documents from the tray and replace them when you have finished.
- If the programmed start time has passed during a power failure, delayed transmission will be attempted soon after the power is restored.
- When polling transmission feature (see page 41) is set to ON, this feature is not available.

Remote Fax Receiving Using an Extension Phone

If you have an extension phone connected to the same line, it is possible to receive a fax message into your facsimile unit by using a touch tone extension phone.

This saves you the trouble of going to the facsimile unit and pressing the START button.

Important:

- This feature is available when you receive a call.
- To activate this feature, use a touch tone telephone as an extension phone and dial the remote fax activation code. The remote fax activation code is set to “**” as a preselected setting.

Using an extension phone

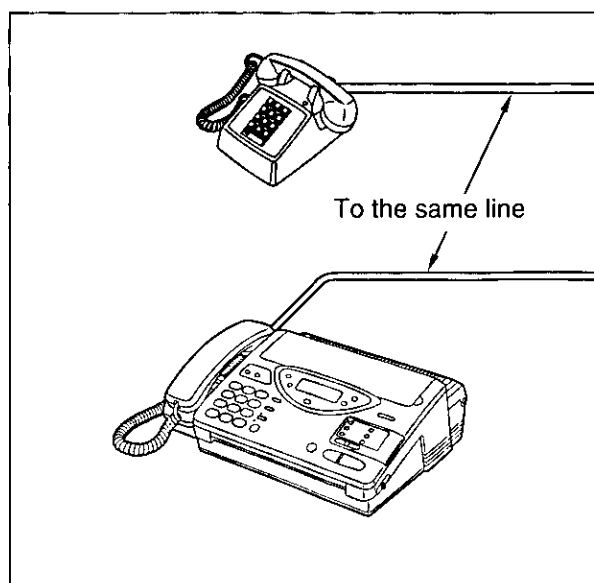

- 1 When a call comes in, lift the handset of the extension phone.
- 2 If a slow beep is heard, or the other party wishes to send you a fax, press the remote fax activation code.
- 3 Replace the handset on the cradle.
—The facsimile unit will activate the fax function to receive documents.

Note:

- The number of the remote fax activation code can be changed to another one. See page 44.

Changing the remote fax activation code

Your code can be from 1 to 4 digits long. The numbers 0 through 9 and character * may be used.
(e.g. **, 123, 123*)

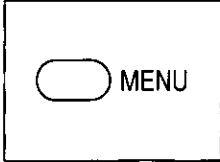
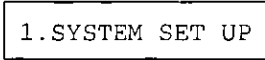
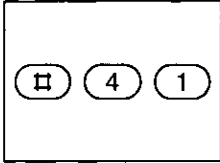
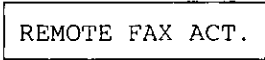
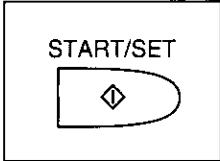
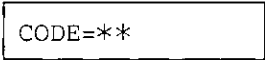
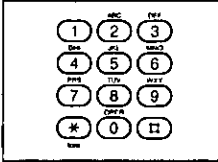
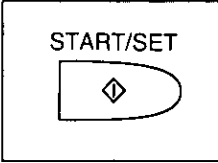
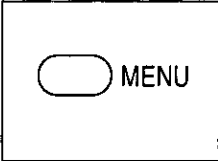
- 1**  Press **MENU**.

- 2**  Press **#41**.

- 3**  Press **START/SET**.

- 4**  Enter the new code number.
- 5**  Press **START/SET** to store the number.
- 6**  Press **MENU** to end the program.

Note:

- If the remote fax activation code is set to "0000", the unit does not work properly.

Junk Mail Prohibitor

This feature is effective to prevent fax receptions from unauthorized stations.

With this feature, the unit can receive documents only from the stations whose phone numbers are stored for automatic dialing.

If you wish to receive documents from other stations, advise the caller to call your unit manually and enter your prohibitor ID (see page 46) before initiating transmission.

Important:

- To activate this feature, set the unit in the ANS/FAX, TEL/FAX or FAX mode and let the unit receive documents automatically.
- When in the ANS/FAX or TEL/FAX mode, transmission using the prohibitor ID is available (see page 46).
- When manual reception is used, the documents from any transmitting station will be received.
- If the transmitting machines have not been programmed with their facsimile telephone numbers, the unit will not be able to receive documents automatically.

Setting the junk mail prohibitor

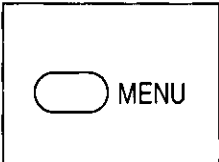
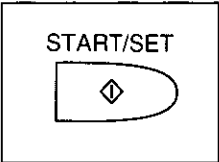
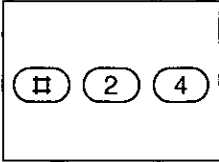
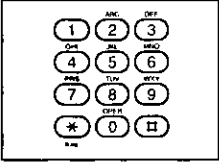
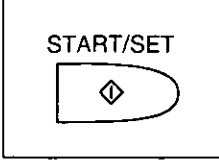
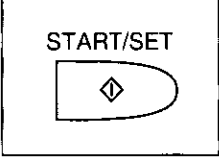
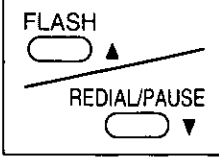
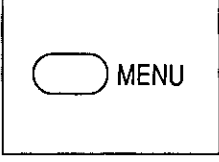
<p>1</p> 	<p>Press MENU.</p> <div style="border: 1px solid black; padding: 2px; width: fit-content; margin: 5px auto;">1.SYSTEM SET UP</div>	<p>5</p> 	<p>Press START/SET to store the setting.</p> <div style="border: 1px solid black; padding: 2px; width: fit-content; margin: 5px auto;">ID=22</div>
<p>2</p> 	<p>Press #24.</p> <div style="border: 1px solid black; padding: 2px; width: fit-content; margin: 5px auto;">JUNK MAIL PROH.</div>	<p>6</p> 	<p>If you wish to change the junk mail prohibitor ID, enter the desired 2-digit number. —0, # and * cannot be used.</p>
<p>3</p> 	<p>Press START/SET.</p> <div style="border: 1px solid black; padding: 2px; width: fit-content; margin: 5px auto;">MODE=OFF [▲▼]</div>	<p>7</p> 	<p>Press START/SET to store the number.</p>
<p>4</p> 	<p>Press ▲ or ▼ to select "ON".</p> <div style="border: 1px solid black; padding: 2px; width: fit-content; margin: 5px auto;">MODE=ON [▲▼]</div> <p>—If this feature is not required, select "OFF".</p>	<p>8</p> 	<p>Press MENU to end the program.</p>

Note:

- The junk mail prohibitor ID must be different from the first 2 digits of the remote ANS ID (see page 59). For example, if the remote ANS ID is set to "321", do not use "32" as a junk mail prohibitor ID.

Transmitting documents to your unit with the prohibitor ID _____

If the junk mail prohibitor feature is activated, automatic fax reception from unauthorized stations will not be available. However, in this instance, a caller can transmit documents to your unit manually by entering the prohibitor ID.

Issue the prohibitor ID to callers with priority status.

Important:

- Transmission with the prohibitor ID is activated when your unit is in the *ANS/FAX* or *TEL/FAX* mode.

Instructions for caller:

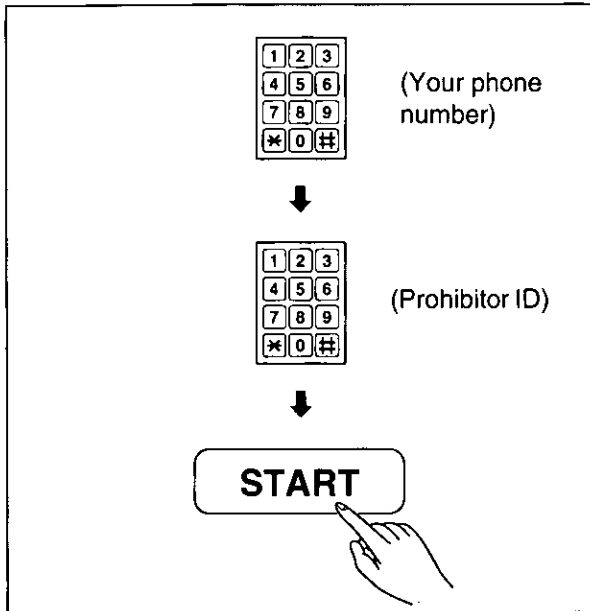

- ① A caller may call your unit.
- ② ■ **When your unit is in the *ANS/FAX* mode:**
They may enter the prohibitor ID while the greeting message is being played or during an incoming message recording mode.

or

■ **When your unit is in the *TEL/FAX* mode:**
They may enter the prohibitor ID while the different ring back tone is heard.
- ③ When a fax tone is heard, they may press their start or transmit button to start the fax transmission.

Special Settings

Logo print position

Your logo, telephone number, date, time and page number will be printed on the transmitted document from your unit in the following manner.

OUT: Outside of the transmitted document's paper size.

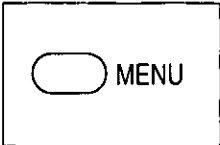
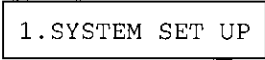
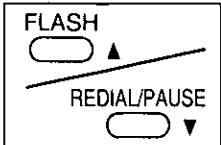
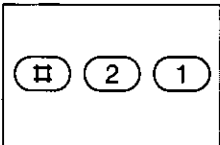
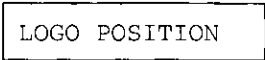
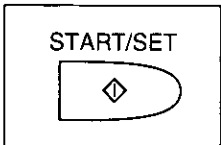
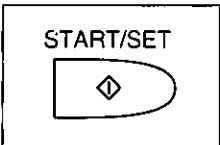
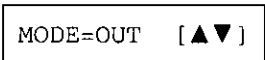
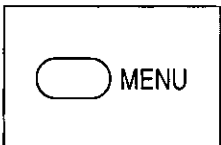

IN: Inside of the transmitted document's paper size.

OFF: Not printed.

<p>1</p> 	<p>Press MENU.</p> 	<p>4</p> 	<p>Press ▲ or ▼ to select the desired setting.</p>
<p>2</p> 	<p>Press #21.</p> 	<p>5</p> 	<p>Press START/SET to store your selection.</p>
<p>3</p> 	<p>Press START/SET.</p> 	<p>6</p> 	<p>Press MENU to end the program.</p>

Overseas transmission mode

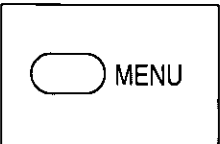
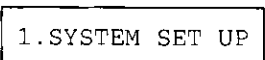
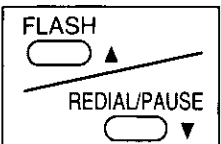
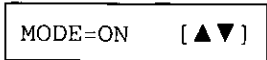
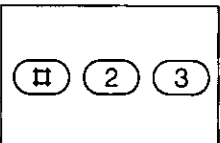
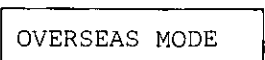
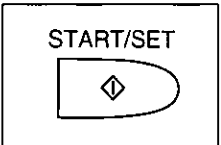
You may experience difficulty in transmitting documents overseas. When this feature is set to on, it will become easy to send documents as the transmission speed is slowed down.

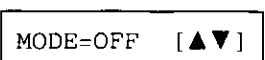
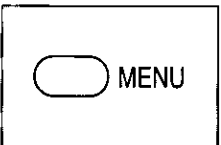
<p>1</p> 	<p>Press MENU.</p> 	<p>4</p> 	<p>Press ▲ or ▼ to select "ON".</p> 
<p>2</p> 	<p>Press #23.</p> 	<p>5</p> 	<p>—If this feature is not required, select "OFF".</p> <p>Press START/SET to store your selection.</p>
<p>3</p> 	<p>Press START/SET.</p> 	<p>6</p> 	<p>Press MENU to end the program. Then start transmission procedure (see pages 20 and 21).</p>

Notes:

- After the transmission has completed, this feature will be turned off automatically.
- When using this feature, transmission time will increase.

Setting the day/night mode

You may wish to use the unit as a telephone and facsimile (TEL/FAX mode) during the business hours and switch to the answering device (ANS/FAX mode) during off hours.

With this feature on, the unit will automatically switch the receiving mode at a preprogrammed time without the operator's assistance.

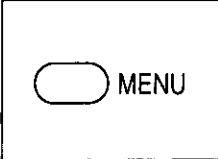
- 1**  Press **MENU**.

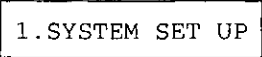
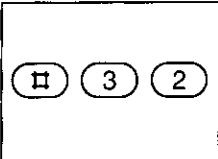

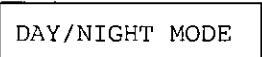
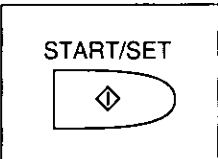
- 2**  Press **#32**.

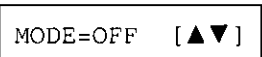
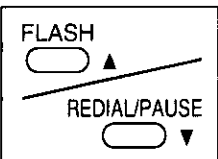

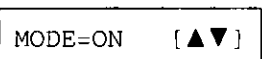
- 3**  Press **START/SET**.

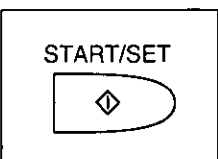
- 4**  Press **▲** or **▼** to select "ON".

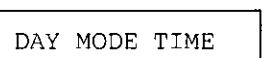
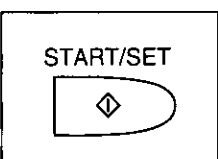

—If this feature is not required, select "OFF".
- 5**  Press **START/SET** to store the selection.

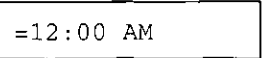
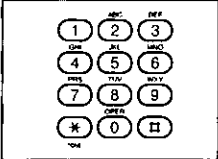

- 6**  Press **START/SET**.

- 7**  Enter the time at which the day mode (TEL/FAX mode) starts.

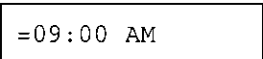
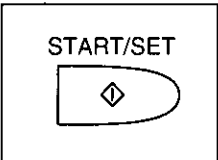
Example:
The TEL/FAX mode starts at 9:00AM.
Press 0900, then press * to select AM.

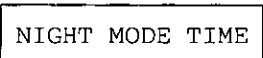
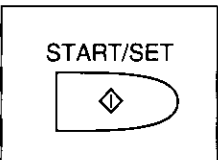
- 8**  Press **START/SET**.

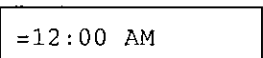
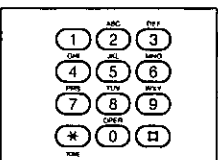
- 9**  Press **START/SET**.

- 10**  Enter the time at which the night mode (ANS/FAX mode) starts.

Example:
The ANS/FAX mode starts at 5:00PM.
Press 0500, then press # to select PM.

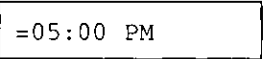
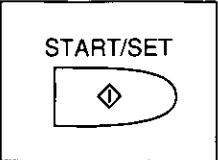
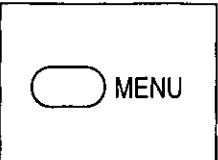
- 11**  Press **START/SET** to store the setting.
- 12**  Press **MENU** to end the program.

Note:

- If you select another receiving mode manually when this feature is on, the unit will keep the receiving mode that you select until either day or night mode starts.

Paper save reception/copy

Use this feature when you wish to save a recording paper during fax reception or copying. With this feature, the unit will reduce the data and print it out in half in length.

Important:

- This feature will not work,
 - when receiving documents sent in fine resolution or other nonstandard resolution.
 - when making a copy in the fine, super fine or half tone resolution.

Sample of paper save print:

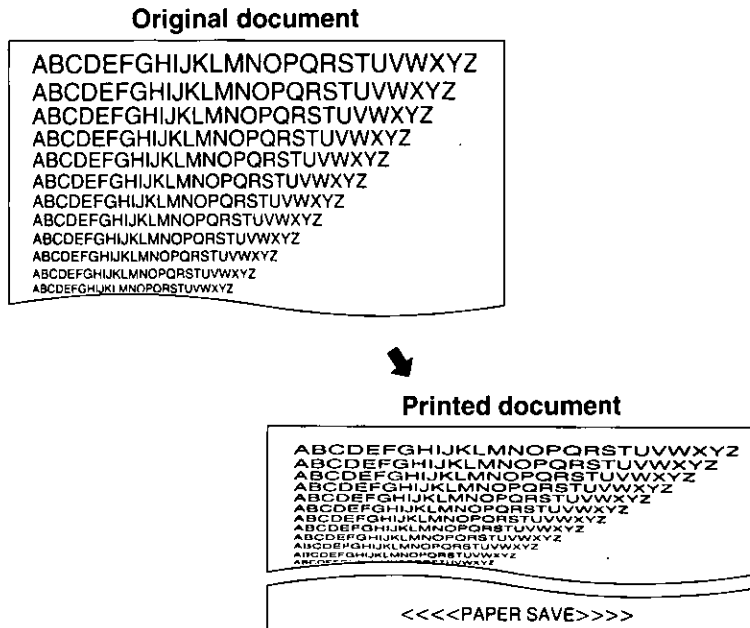

To activate this feature, proceed as follows:

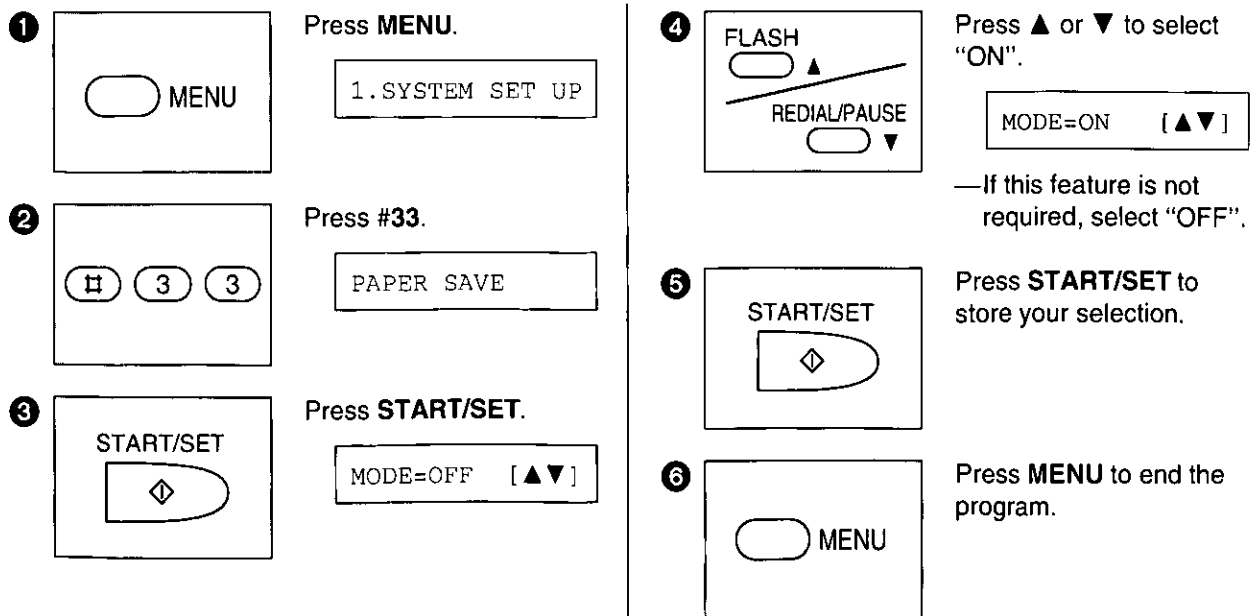

Extension copy

With this feature, the unit will copy a document twice in length.

We recommend that you use this feature when you received fax messages in the paper save reception (see page 49) and you wish to enlarge them.

Sample of extended copy:

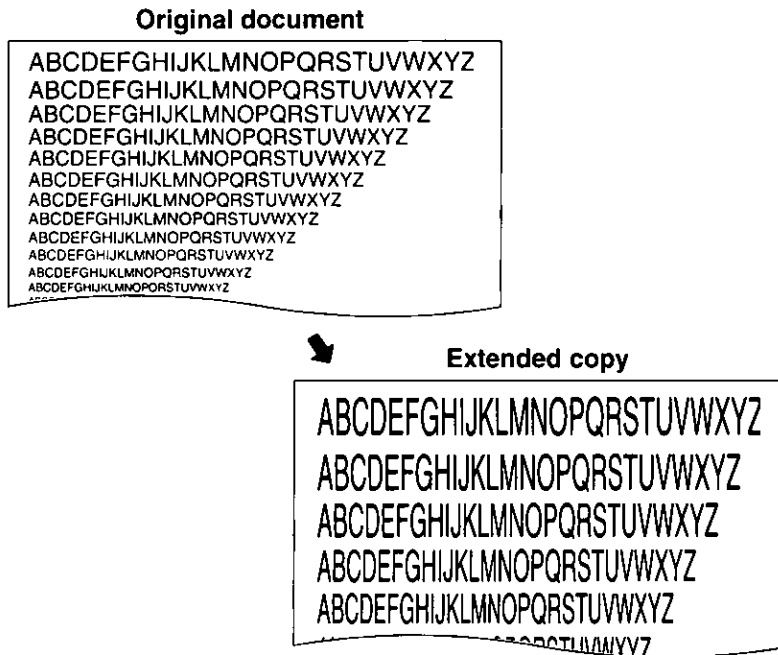

To make an extension copy, proceed as follows.

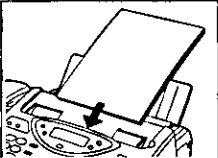
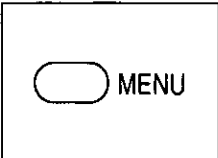
- 1**  Insert the documents **FACE DOWN**.
- 2**  Press **MENU**.

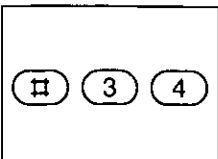
1. SYSTEM SET UP
- 3**  Press **#34**.

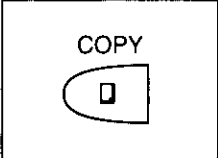
EXTENSION COPY
- 4**  Press **COPY**.

COPYING

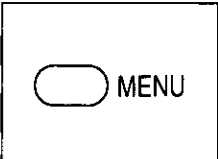
—The unit will start printing.
- 5**  Press **MENU** to end the operation.

Original mode

Use this feature when you need to transmit and copy a document with very faint writing or very dark writing. The following choices are available:

- NORMAL:** Used for a document with normal writing.
- LIGHT:** Used for a document with very faint writing.
- DARKER:** Used for a document with very dark writing.

These settings are available in the standard, fine and super fine resolutions. Set this feature before starting transmission or copying by following steps below.

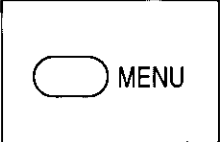
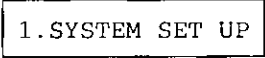
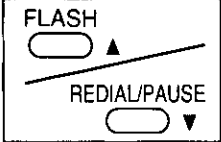
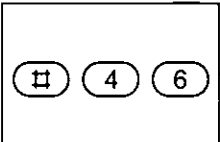
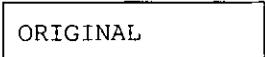
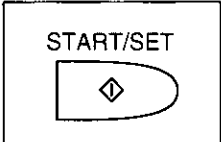
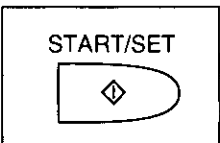
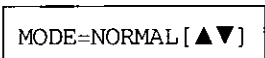
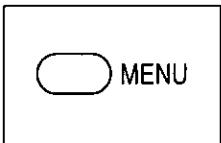



<p>1</p> 	<p>Press MENU.</p> 	<p>4</p> 	<p>Press ▲ or ▼ to select the desired mode.</p>
<p>2</p> 	<p>Press #46.</p> 	<p>5</p> 	<p>Press START/SET to store the setting.</p>
<p>3</p> 	<p>Press START/SET.</p> 	<p>6</p> 	<p>Press MENU to end the program.</p>

Note:

- This feature will return to the normal mode after the transmission or copying has completed.

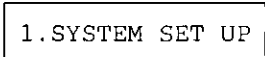
Resetting the advanced features

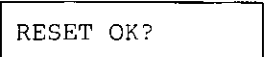
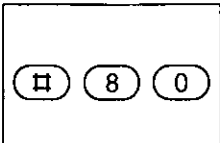
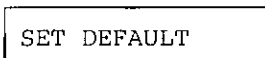
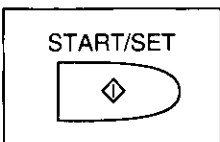
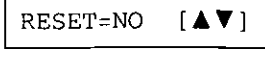
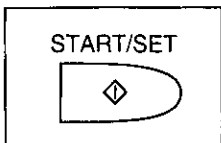
Use this feature to return the advanced features of #21 through #63 (see page 33) to their initial settings.

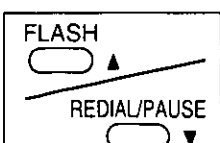
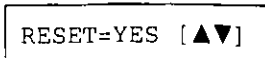
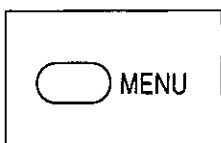
<p>1</p> 	<p>Press MENU.</p> 	<p>5</p> 	<p>Press START/SET.</p> 
<p>2</p> 	<p>Press #80.</p> 	<p>—If this feature is not required, press the STOP button.</p>	
<p>3</p> 	<p>Press START/SET.</p> 	<p>6</p> 	<p>Press START/SET again for confirmation.</p> 
<p>4</p> 	<p>Press ▲ or ▼ to select "YES".</p> 	<p>7</p> 	<p>Press MENU to end the program.</p>

Voice Contact

You can have a voice conversation on the same call after fax transmission or reception is completed. This saves the extra expense and time of making a subsequent telephone call to discuss the information sent over the fax.

Important:

- This feature works only when the other party's unit is equipped with the voice contact/call reservation feature.

Initiating voice contact

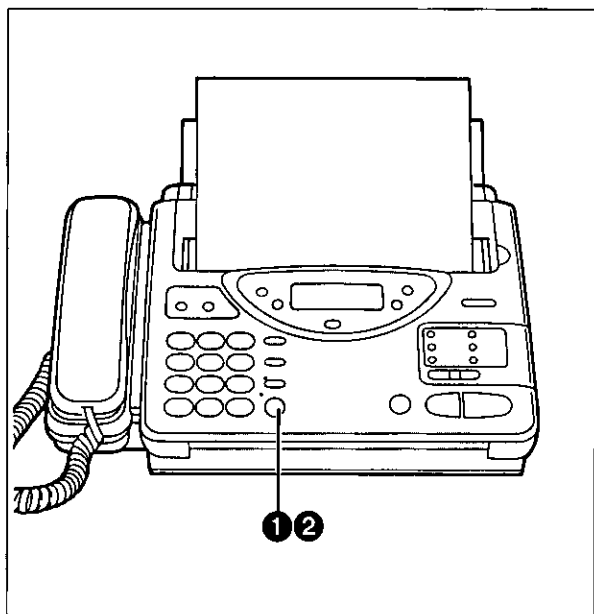

- 1 Press **SP-PHONE/VOICE STDBY** while transmitting or receiving documents.

VOICE STANDBY

—Your unit will call the other party with a distinctive ring.

- 2 When the other party answers, the unit will emit a distinctive ring. While ringing, press **SP-PHONE/VOICE STDBY** again or lift the handset to start speaking.

Notes:

- If you initiate voice contact while transmitting documents, you can speak after all the documents have been transmitted.
- If you initiate voice contact while receiving documents, you can speak after the current page of the documents is received.
- You can initiate the voice contact by lifting the handset during transmission or reception.
- If the other party does not answer, the line will be disconnected automatically.

Receiving a request for voice contact

If the other party initiates voice contact, your unit will emit a distinctive ring after the transmission or reception is completed.

When a distinctive ring is heard, press **SP-PHONE/VOICE STDBY** or lift the handset, then start speaking.

Note:

- If you do not answer within 10 seconds of hearing the distinctive ring, one of the following occurs:
 - When the unit is in the **ANS/FAX** mode, it will play back your greeting message and record the incoming voice message.
 - When the unit is in the **TEL/FAX**, **FAX** or **TEL** mode, the line will be disconnected.

TONE, FLASH and PAUSE Buttons

TONE button

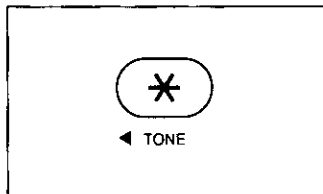

The TONE (*) button is used when your line has a rotary pulse dial service. Pressing the button allows you to change temporarily from pulse to tone mode during a dialing operation. When you hang up, the unit will automatically return to pulse mode.

Note:

- TONE can be stored into a phone number for automatic dialing.

FLASH button

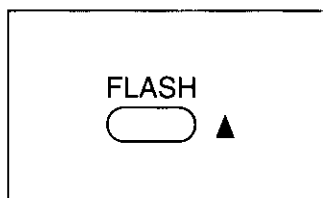

The FLASH button functions as the hookswitch on a regular phone. If you misdial or dial another phone number, press the FLASH button firmly. The call will be terminated and you will hear dial tone. You can then dial the next phone number.

Also pressing the FLASH button allows you to use special features of the host exchange (if connected) or local telephone company services. For further details, contact the supplier or your local telephone companies.

Note:

- FLASH can be stored into a phone number for automatic dialing.

PAUSE button

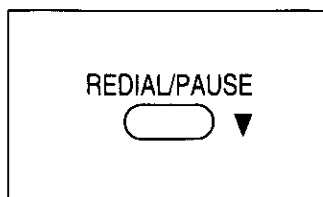

Pressing the REDIAL/PAUSE button causes a dialing delay in the dialing sequence.

Example-1: When your unit is connected to a host exchange, insert a pause as follows to get an outside line.

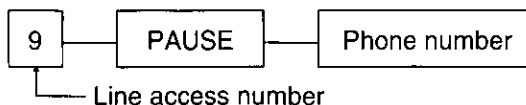

Example-2: If a transmission error occurs frequently when making an overseas transmission, add two pauses at the end of the phone number.

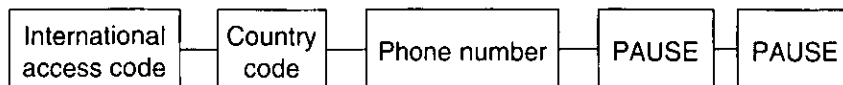

Note:

- PAUSE can be stored into a phone number for automatic dialing.

Voice Mailbox

The unit has four memory locations—common memory and three mailbox memories. The greeting messages and incoming calls can be recorded into each memory location.

This feature is useful when you use the unit jointly with other people and you wish your caller would record a message directly to you.

Your caller can leave a message in a specific mailbox, and only the person who knows the password can retrieve the message from the mailbox.

This unit has three personal mailboxes and you can program a password for each one of them.

To use mailbox

1. Record common greeting message into common memory (see page 13).
2. Record personal greeting message(s) into the mailbox(es) (see below).
3. Program each mailbox password (see page 55).
4. In order to leave a message into a mailbox, each owner of the mailboxes must inform callers in advance of their mailbox number.

Note:

- Greeting messages and incoming calls will be recorded in common memory unless the user selects any mailbox.

Recording a personal greeting message for mailbox

Record a personal greeting message for each mailbox. This will be played back to the caller who selected the specific mailbox. Each greeting message can be recorded up to 16 seconds.

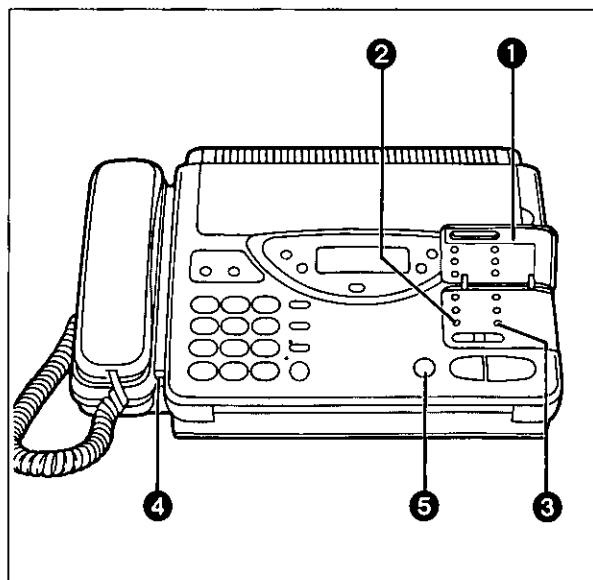

- 1 Open the station key panel.
- 2 Press **GREETING SELECT** until the desired mailbox number is displayed.
Example: Mailbox 2

BOX2-GREETING

- 3 Press **GREETING REC.**
—A long beep will be heard.

BOX2 REC 16s

- 4 Immediately after the long beep, speak clearly and loudly into the microphone.
- 5 When finished, press **STOP**.

Note:

- We recommend you record a briefer greeting message to leave more time for incoming messages. If you do not record a mailbox greeting message, incoming messages can be recorded after the long beep.

Programming the mailbox password

Program your own password for your mailbox to prevent other users from retrieving messages. You can choose any 3-digit number except a number including "0".

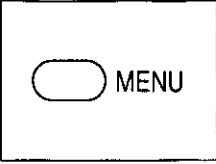
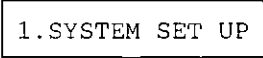
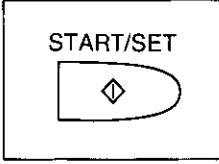
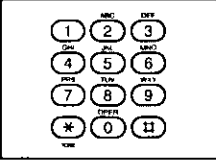
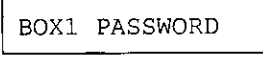
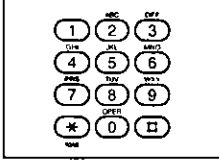
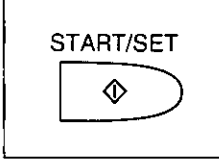
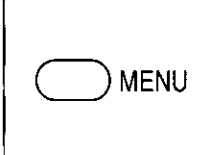
<p>1</p> 	<p>Press MENU.</p>		<p>3</p> 	<p>Press START/SET.</p>
<p>2</p> 	<p>For the mailbox 1, press #51. or For the mailbox 2, press #52. or For the mailbox 3, press #53.</p>	<p><i>Example: Mailbox 1</i></p> 	<p>4</p> 	<p>Enter the new password (111-999).</p>
			<p>5</p> 	<p>Press START/SET to store the setting. —To program other passwords, repeat from step 2.</p>
			<p>6</p> 	<p>Press MENU to end the program.</p>

Note:

- We recommend that you do not use seven (7) as a password number, because this number is used as the greeting message re-recording command for remote operations.

How incoming messages are recorded into each mailbox

In order to leave a message in a mailbox, each owner of the mailboxes must inform their callers of their mailbox number in advance and set the unit in the **ANS/FAX** mode.

<table border="0"> <tr><td>1</td><td>ABC</td><td>DEF</td></tr> <tr><td>GHI</td><td>JKL</td><td>MNO</td></tr> <tr><td>PQR</td><td>STU</td><td>VWX</td></tr> <tr><td>*</td><td>0</td><td>#</td></tr> </table>	1	ABC	DEF	GHI	JKL	MNO	PQR	STU	VWX	*	0	#	(Your phone number)
1	ABC	DEF											
GHI	JKL	MNO											
PQR	STU	VWX											
*	0	#											

↓

<table border="0"> <tr><td>*</td><td>1</td></tr> </table>	*	1	or	<table border="0"> <tr><td>*</td><td>ABC</td><td>2</td></tr> </table>	*	ABC	2	or	<table border="0"> <tr><td>*</td><td>DEF</td><td>3</td></tr> </table>	*	DEF	3
*	1											
*	ABC	2										
*	DEF	3										

- 1** A caller may call your unit (from a touch tone telephone only).
—The common greeting message will be heard.
- 2** They may press *, then enter the desired mailbox number (1-3).
—Personal greeting message will be heard, followed by a long beep.
- 3** They may leave a message in the mailbox.

Note:

- If a caller does not specify the mailbox in step 2, the message will be recorded into the common memory.

Retrieving messages in the mailbox

When there is a new message in a mailbox, the mailbox indicator will flash on the display.

Example: A new incoming message has been recorded in mailbox 2.

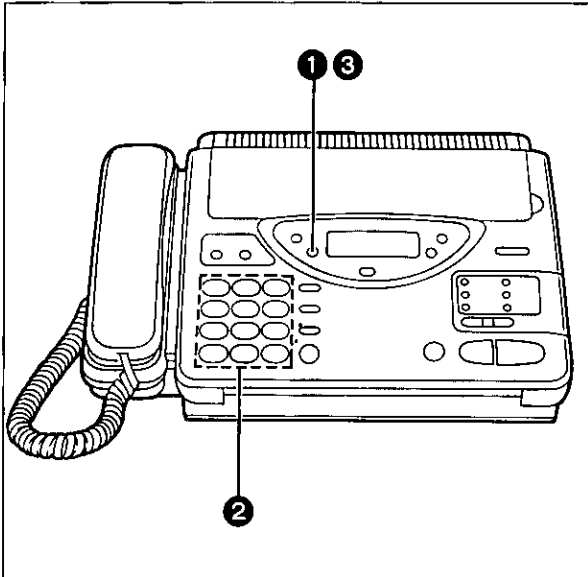
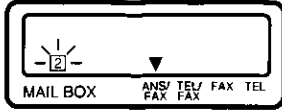

- 1 Press **MAIL BOX** repeatedly until the desired mailbox number is displayed.
Example: The mailbox number is 2.

BOX2 02

- 2 Enter the mailbox password.
Example: The password is 555 (factory setting).

PASSWORD=555

—The unit will automatically play back newly recorded messages.

MON 12:00AM 01

- 3 To exit the mailbox, press **MAIL BOX**.

Notes:

- If no new messages are recorded, the unit will play back all the messages recorded in the mailbox.
- The ALL MESSAGES, REPEAT, SKIP and STOP buttons can be used.
- If you leave the mailbox password set to "555" (factory setting), you need not enter the password in step 2. To listen to the recorded messages, press the NEW MESSAGES or ALL MESSAGES button.

Erasing recorded messages in the mailbox

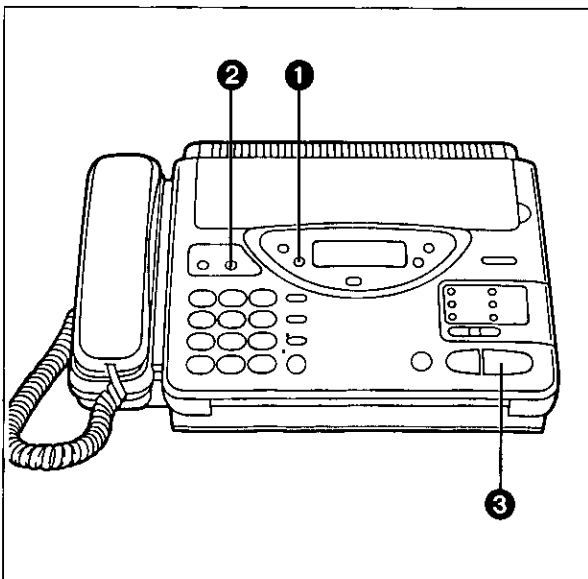

- **Erasing specific messages in the mailbox:**
Press **ERASE** while the message you want to erase is playing.

- **Erasing all messages in the mailbox:**

- 1 Press **MAIL BOX** repeatedly until the desired mailbox number is displayed.
Example: Mailbox 1 is selected.

- 2 Press **ERASE**.

BOX1 ERASE OK?

- 3 Press **START/SET** for confirmation.

ERASE COMPLETED

Retrieving messages in the mailbox from a remote location

The following operation allows the unit to play back voice messages stored in the mailbox from a remote location.

This feature is available when the unit is in the *ANS/FAX* mode.

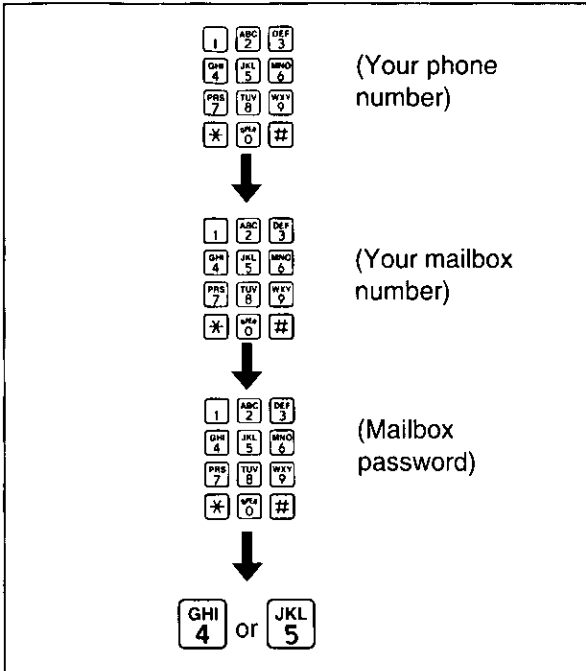

- 1 Call your unit from a touch tone telephone.
—Common greeting message will be heard.
- 2 Press *, then press the desired mail box number (1–3).
—Personal greeting message will be heard.
- 3 Press the mailbox password (3-digit).
—A long beep and a short beep(s) will sound. Short beep(s) indicate(s) the number of newly recorded message(s). Short beeps will sound up to 8 times even if 9 or more calls are recorded.
- 4 Press 4 for new message playback.
or
Press 5 or wait for 4 seconds for all message playback.

Setting the mailbox alert

When this feature is on, the unit will let you know with a slow beep if a caller's message has been recorded in the mailbox.

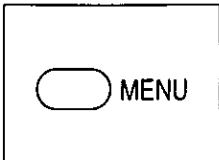
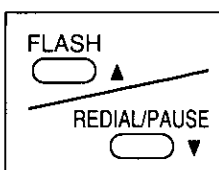
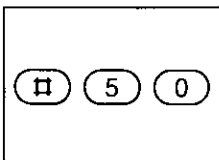
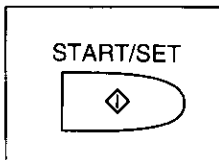
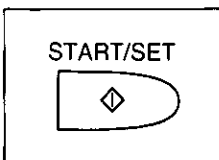
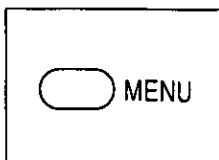
<p>1</p> 	<p>Press MENU.</p> <div style="border: 1px solid black; padding: 5px; width: fit-content; margin-left: 20px;">1. SYSTEM SET UP</div>	<p>4</p> 	<p>Press ▲ or ▼ to select "ON".</p> <div style="border: 1px solid black; padding: 5px; width: fit-content; margin-left: 20px;">MODE=ON [▲▼]</div>
<p>2</p> 	<p>Press #50.</p> <div style="border: 1px solid black; padding: 5px; width: fit-content; margin-left: 20px;">MAIL BOX ALERT</div>	<p>5</p> 	<p>—If this feature is not required, select "OFF".</p>
<p>3</p> 	<p>Press START/SET.</p> <div style="border: 1px solid black; padding: 5px; width: fit-content; margin-left: 20px;">MODE=OFF [▲▼]</div>	<p>6</p> 	<p>Press MENU to end the program.</p>

Operating the Answering Device from a Remote Phone

You can access your unit and retrieve the incoming messages from a remote location with a touch tone telephone.

Summary of remote operations

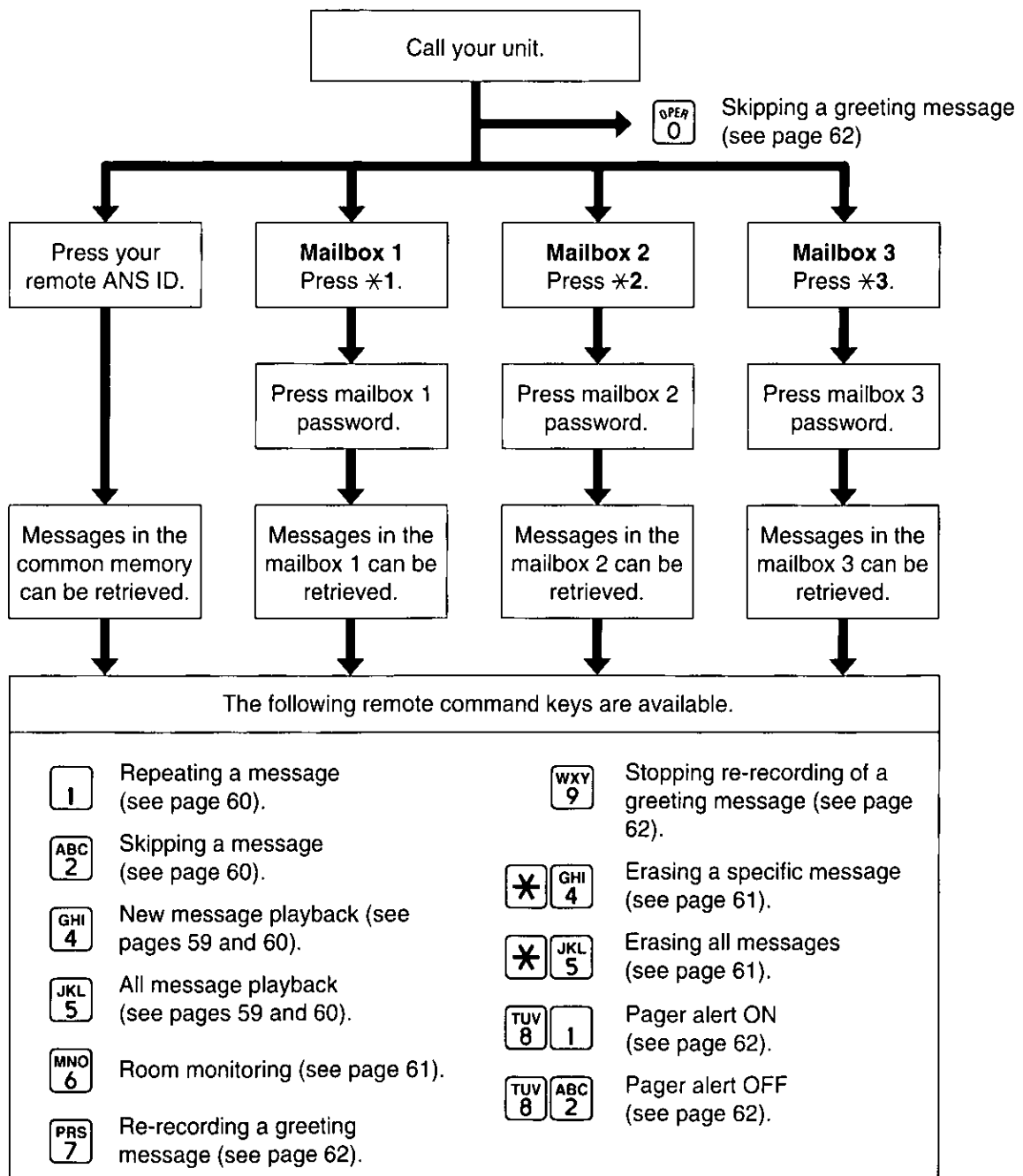



Programming the remote ANS ID

The remote ANS ID is used to access your answering device from a remote location with a touch tone telephone.

Choose any number from 111 to 999 except a number including "0".

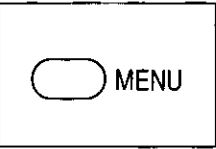
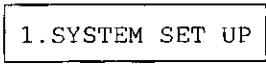
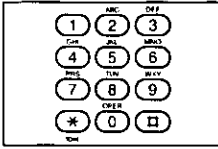
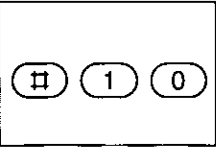
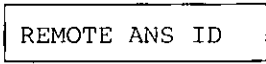
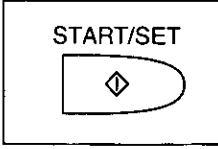
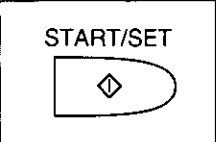
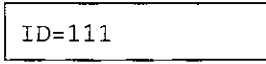
Make sure that the first 2-digit number of the remote ANS ID is different from the junk mail prohibitor ID.

<p>1</p> 	<p>Press MENU.</p> 	<p>4</p> 	<p>Enter the desired number (111-999).</p>
<p>2</p> 	<p>Press #10.</p> 	<p>5</p> 	<p>Press START/SET to store the setting.</p>
<p>3</p> 	<p>Press START/SET.</p> 	<p>6</p> 	<p>Press MENU to end the program.</p>

Note:

- We recommend that you do not use seven (7) as an ID number, because this number is used as the greeting message re-recording command for remote operations.

Listening to the recorded messages in the common memory

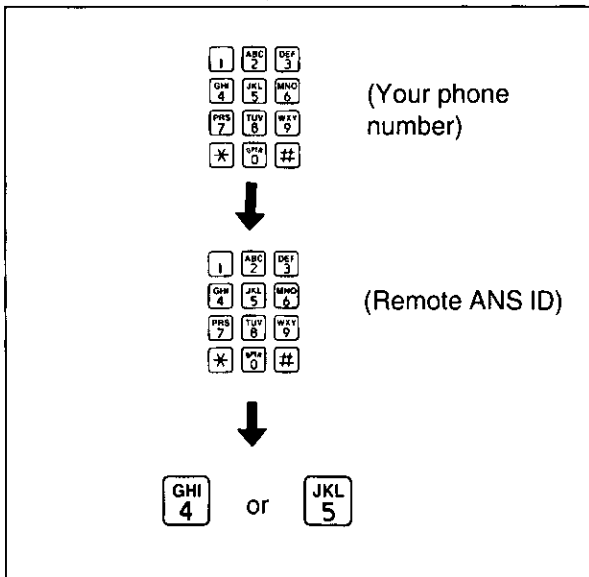

(Your phone number)

(Remote ANS ID)

GHI 4 or JKL 5

- 1 Call your unit.
 - The unit will play the greeting message.
- 2 Press the remote ANS ID during the common greeting message.
 - A long beep and a short beep(s) will sound. Short beep(s) indicate(s) the number of newly recorded messages. Short beeps will sound up to 8 times even if 9 or more calls are recorded.
- 3 Press 4 to listen to newly recorded messages, or Press 5 or wait for 4 seconds to listen to all the recorded messages.

Note:

- If you hear 6 beep tones after playing back messages, the memory is full. You must erase some or all messages.

If you want to listen to messages in the mailbox after playing back messages in the common memory;

1. Press * and 1, 2 or 3 (desired mailbox number).
2. Press the mailbox password.
3. Press 4 (for new message playback) or 5 (for all message playback) to play back messages.

Retrieving the recorded messages in the mailbox

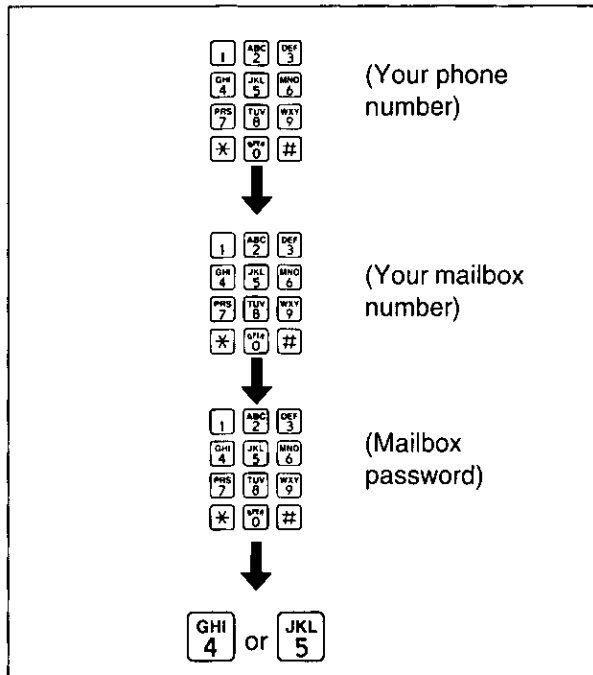

- ❶ Call your unit.
- ❷ Press * and the desired mailbox number (1-3).
- ❸ Enter a mailbox password during a personal greeting message.
 - A long beep and a short beep(s) will sound. Short beep(s) indicate(s) the number of recorded messages. Short beeps will sound up to 8 times even if 9 or more calls are recorded.
- ❹ Press 4 to listen to newly recorded messages. or Press 5 or wait for 4 seconds to listen to all the recorded messages.

If you want to listen to messages in the other memory after playing back:

1. Press *, and 0 (for common memory). Press * and other mailbox number 1, 2 or 3.
2. Press the mailbox password if you selected the mailbox.
3. Press the direct remote command 4 or 5 to play back messages.

Functions during playback

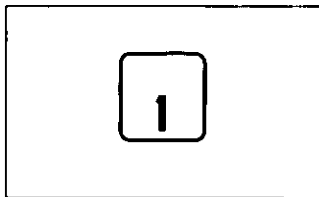

- **Repeating the current message:**
Press 1 to repeat the message currently being played.

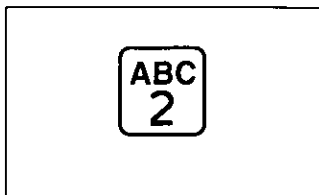

- **Skipping a message:**
Press 2 to start to play the next message.

Erasing a specific message from memory

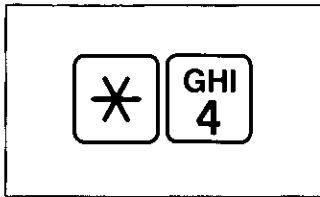

Press * 4 when the message you want to erase is being played.

- The unit will erase the message just played back.
- A long beep followed by three short beeps will be heard. Then the unit will continue with the next message.

Erasing all messages from memory

You can erase all the recorded messages in the accessing memory. To erase all messages in mailbox, you must first select the mailbox.

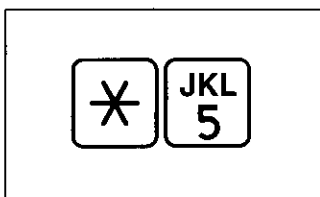

Press * 5.

- A long beep followed by three short beeps will be heard.
- The unit will erase all the recorded messages.

Note:

- The greeting messages will not be erased in this operation.

Room monitoring

You can monitor the sound in the room where the unit is installed. This feature also allows you to speak with anyone in the room.



Call your unit, then press your remote ANS ID while the greeting message is playing.

Press 6 after hearing a beep.

- The speakerphone of the unit in the room will be turned on and you can monitor the room sound for about 30 seconds.

Notes:

- To continue monitoring, press 6 again within 10 seconds after hearing one beep.
- To talk to the other party in the room, inform them to lift the handset or press the SP-PHONE button.

Recording a marker message

After playing back the recorded messages, you can leave an additional message during the same call. Wait for 3 beeps indicating the end of the remote operation and wait about 10 seconds for another 2 beeps indicating that the unit is ready for recording, then you can leave your message.

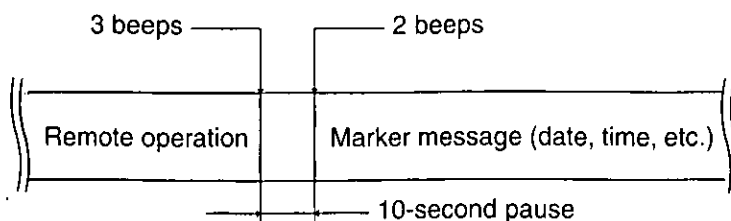

Re-recording a greeting message

You can change the content of the greeting message from a remote location.

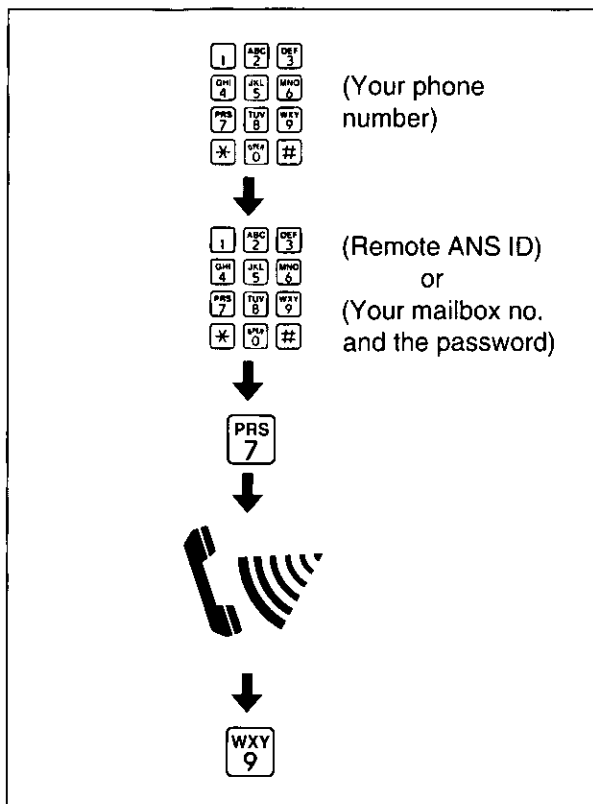

- 1 Call your unit.
- 2 ■ **For the common greeting message:**
Dial your remote ANS ID while the greeting message is playing.
- **For the mailbox greeting message:**
Press * and 1, 2 or 3 (desired mailbox no.). Then enter the mailbox password.
- 3 Press 7 to start re-recording after hearing a beep.
—A long beep will sound.
- 4 After hearing a long beep, speak clearly and loudly for up to 16 seconds.
—If you pause for over 2 seconds while recording, the unit will beep and stop the greeting message recording. In this event, repeat from step 2 within 10 seconds.
- 5 When finished, press 9.
—The new greeting message will be played back to confirm the content.

Turning on/off pager alert

You can remotely turn on/off a pager alert feature which has been programmed with a pager number in advance (see page 63).

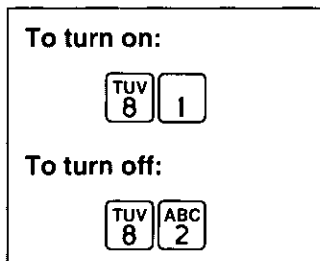

- 1 Call your unit.
- 2 For the common pager alert, press the remote ANS ID.
or
For a mailbox pager alert, press * and the mailbox number (1, 2 or 3), then press the mailbox password.
- 3 To turn on the pager alert, press 81.
To turn off the pager alert, press 82.

To skip the greeting message

Callers can record their messages without listening to the greeting message.

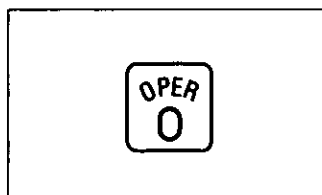

- They may call your unit, then dial 0 during the greeting message playback.
- The unit will skip the rest of the greeting message and start recording.

Pager Alert

The feature allows your unit to call your pager automatically each time an incoming message is recorded on the unit.

You can set the pager number for each memory (common, mailbox 1, 2 and 3).

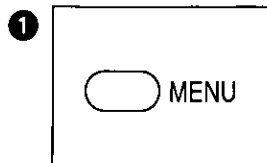

Press **MENU**.

1. SYSTEM SET UP

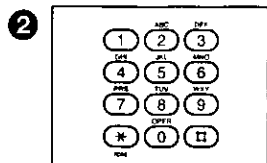

For common pager alert, press **#60**.

COMMON PAGER

or
For mailbox 1 pager alert, press **#61**.

MAIL BOX1 PAGER

or
For mailbox 2 pager alert, press **#62**.

MAIL BOX2 PAGER

or
For mailbox 3 pager alert, press **#63**.

MAIL BOX3 PAGER

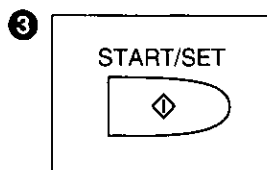

Press **START/SET**.

MODE=OFF [▲▼]

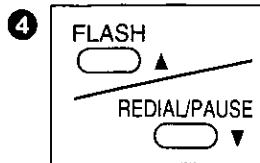

Press **▲** or **▼** to select "ON".

MODE=ON [▲▼]

—If this feature is not required, select "OFF".

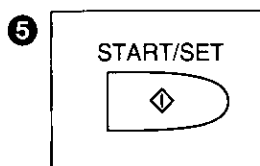

Press **START/SET**.

NO. =

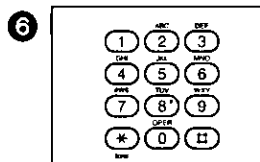

Enter your pager phone number. If necessary, press the PAUSE button twice. Please contact your pager company regarding the proper pause time.

If your pager has the ability to display phone numbers, enter the number that you wish to appear in the display. Press "#" if required by your pager company.

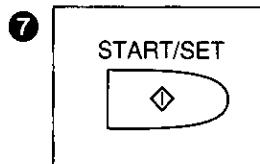

Press **START/SET** to store the setting.

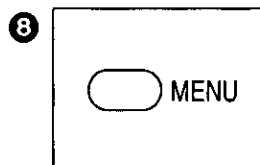

Press **MENU** to end the program.

When the pager beeps, call your unit from a touch tone telephone to retrieve the message.

Notes:

- You may enter a total of 30 digits and/or pauses in step 6 above.
- This feature can be turned on/off remotely from a touch tone phone (see page 62).

Printing Reports and Lists

You can get the following reports and lists from your unit. See pages 65 and 66 for sample reports and lists.

Basic Feature List:

This provides you with the current settings of the basic programming features (#01 to #10).

Advanced Feature List:

This gives you a list of the current settings of the advanced programming features (#21 to #80).

Telephone Number List:

This is a list of phone numbers and station names that are stored for one-touch dialing and speed dialing.

Journal Report:

This gives you a record of all transmissions and receptions (up to 35 fax communications). This report is useful for keeping telephone records or for verifying telephone charges.

This report can be printed automatically after every 35 fax communications (see page 67).

Printer test list:

This allows you to check the print quality of your unit.

If the test pattern has any blurred points or lines or dirty patterns, please clean the thermal head by following the instructions on page 73.

How to print each report/list

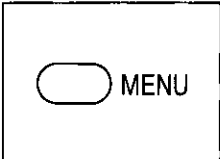
1  Press **MENU** repeatedly until the following is displayed.

3 . PRINT LIST

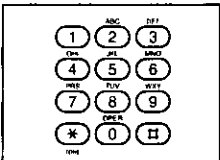
2  **For the basic feature list, press #1.**

BASIC LIST

For the advanced feature list, press #2.

ADVANCED LIST

For the telephone number list, press #3.

TEL NO. LIST

For the journal report, press #4.

JOURNAL REPORT

For the printer test list, press #5.

PRINTER TEST

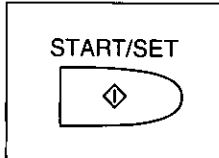
3  Press **START/SET** to start printing.

PRINTING

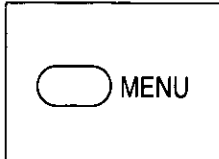
4  Press **MENU** to end the operation.

Sample reports and lists

Basic feature list

BASIC FEATURE LIST			
NO.	FEATURE	CURRENT SETTING	
#01	SET DATE & TIME	Jan. 01 1994 12:51AM	
#02	YOUR LOGO	Panasonic FAX SYSTEM	
#03	YOUR TELEPHONE NUMBER		
#04	PRINT TRANSMISSION REPORT	ERROR	(ERROR, ON, OFF)
#06	TEL/FAX DELAYED RING	1	[1...4]
#07	FAX RING COUNT	1	[1...4]
#08	ANS/FAX RING COUNT	1	[1...4, TOLL SAVER, RINGER OFF]
#09	RECORDING TIME	VOX	[VOX, 1MIN]
#10	REMOTE ANS ID	ID = 111	

Advanced feature list

ADVANCED FEATURE LIST			
NO.	FEATURE	CURRENT SETTING	
#21	LOGO POSITION	OUT	(OUT, IN, OFF)
#22	JOURNAL AUTO PRINT	ON	(ON, OFF)
#23	OVERSEAS MODE	OFF	(ON, OFF)
#24	JUNK MAIL PROHIBITOR	OFF	(ON, OFF)
#25	DELAYED TRANSMISSION	OFF	(ON, OFF)
		ID = 22	
		DESTINATION =	
		START TIME = 12:00AM	
#30	SILENT FAX RECOGNITION RING	3	[3...6]
#32	DAY/NIGHT MODE	OFF	(ON, OFF)
		DAY MODE TIME = 12:00AM	
		NIGHT MODE TIME = 12:00AM	
			(ON, OFF)

Telephone number list

TELEPHONE NUMBER LIST			
STATION KEY LIST			
TELEPHONE NUMBER	NAME	TELEPHONE NUMBER	NAME
01 092-123-4567	COMPANY A	06 999-1234	
02 83-555-1234	COMPANY B	07 []	
03 012-999-8877	COMPANY C	08	
04 83P4567		09	
05 987-6543		10	
AUTO KEY LIST			
TELEPHONE NUMBER	NAME	TELEPHONE NUMBER	NAME
00 111-2233*123		11 222-3344	COMPANY D
01 765-4321		12 092-555-6677	COMPANY E
02 345F6789		13	
03 092[]		14	
04		15	
05		16	

Codes in each phone number

*: * has been entered.

P: The pause has been entered.

F: The flash has been entered.

-: The hyphen has been entered.

[]: The secret phone number has been entered.
(The telephone number is not printed.)

5

Journal report

JOURNAL							
Jan. 01 1994 06:05PM							
NO.	OTHER FACSIMILE	START TIME	USAGE TIME	MODE	PAGES	RESULT	*CODE
01	1234567	Jan. 01 11:28AM	01'20	TX	02	OK	
02	9998765	Jan. 01 11:52AM	00'56	TX	01	OK	
03	<< G3 >>	Jan. 01 11:58AM	00'32	RX	01	OK	
04	555556677	Jan. 01 00:19PM	01'48	TX	03	OK	
05	+987 1234	Jan. 01 00:35PM	01'42	RX	03	OK	
06	<S01>	Jan. 01 01:14PM	02'40	TX	05	OK	
07	7776543	Jan. 01 01:27PM	01'03	TX	01	OK	
08	4445566	Jan. 01 02:46PM	01'18	TX	02	OK	
09	<A17>	Jan. 01 03:17PM	00'35	TX	00	COMMUNICATION ERROR	(71)
10	<< G3 >>	Jan. 01 03:19PM	01'21	RX	03	OK	
11	...	Jan. 01 03:38PM	02'25	TX	04	OK	
				TX	01	OK	
				TX	02	OK	



- ① Communication mode:
TX...Transmission
RX...Reception
POL.TX...Polling transmission
POL.RX...Polling reception
- ② Number of pages received or transmitted successfully
- ③ Communication result
(For the explanation of communication results, see page 70.)
- ④ Error code (for the service personnel use only)

Printer test list

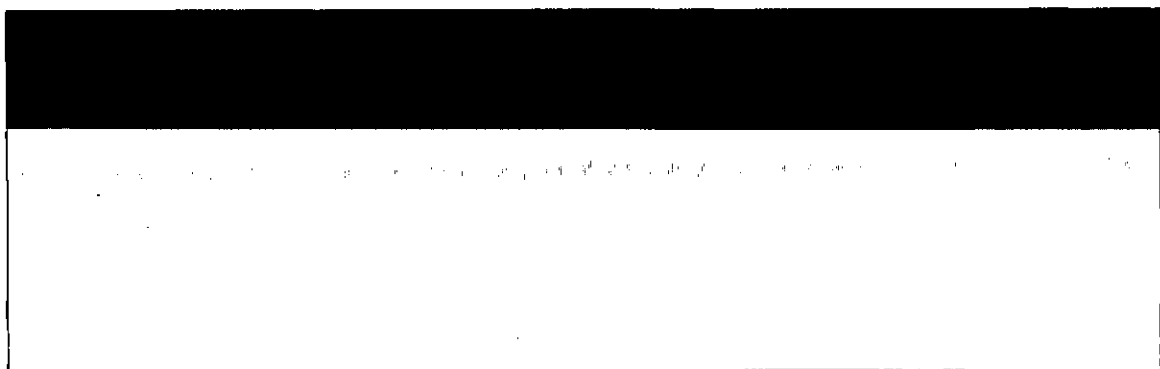

Setting journal auto print

This feature allows the unit to print a record of the last 35 fax communications (transmissions and receptions) automatically.

After printing, memory will clear and the unit will begin to store new data of the journal report.

When this feature is deactivated, the journal report data is stored until the memory becomes full. When memory is full and a new communication takes place, the oldest data will be erased and the newest data will be stored.

To activate this feature, proceed as follows:

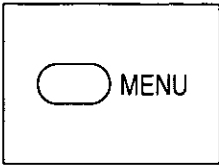
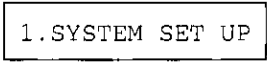
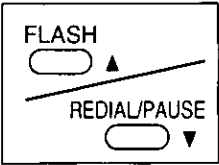
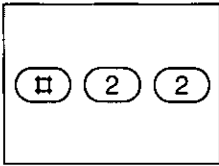
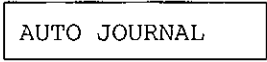
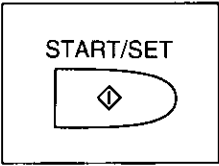
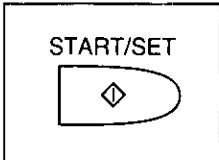
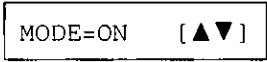
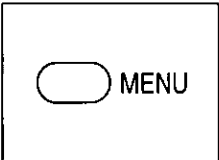
- | | | | |
|--|--|---|---|
| <p>1</p>  | <p>Press MENU.</p>  | <p>4</p>  | <p>Press ▲ or ▼ to select the desired mode.</p> |
| <p>2</p>  | <p>Press #, then press 22.</p>  | <p>5</p>  | <p>Press START/SET to store the setting.</p> |
| <p>3</p>  | <p>Press START/SET.</p>  | <p>6</p>  | <p>Press MENU to end the program.</p> |

Troubleshooting

Error messages on the display

If the unit detects a problem, one of the following messages will appear on the display.

ERROR MESSAGE	CAUSE AND REMEDY
BATTERY LOW	<ul style="list-style-type: none"> • Battery power is low. Replace the batteries with new ones (see page 10).
CHECK COVER	<ul style="list-style-type: none"> • The top cover is open. Close it.
CHECK DOCUMENT	<ul style="list-style-type: none"> • The document is not fed into the unit properly. Re-insert the document. If the misfeeding occurs frequently, clean the document feeder rollers inside the unit (see page 73). Still it remains unsolved, adjust the feeder pressure (see page 72).
CHECK MEMORY	<ul style="list-style-type: none"> • Memory (phone numbers, parameters, etc.) has been erased. Re-program them.
MECHA ERROR	<ul style="list-style-type: none"> • Mechanical error occurred. Open the cover and re-install the recording paper. Then press the STOP button and close the cover.
MEMORY FULL	<ul style="list-style-type: none"> • There is no room left in memory to record a message. Erase some or all messages (see page 29).
NO ANS GREETING	<ul style="list-style-type: none"> • The greeting message for the ANS/FAX mode has not been recorded. Record the greeting message (see page 13).
NO RESPONSE	<ul style="list-style-type: none"> • The receiving unit is busy or out of recording paper. Try again.
NO TEL GREETING	<ul style="list-style-type: none"> • The greeting message for the TEL/FAX mode has not been recorded. Record the greeting message (see page 13).
OUT OF PAPER	<ul style="list-style-type: none"> • The unit ran out of recording paper. Replace it with a new one (see page 9).
PAPER JAMMED	<ul style="list-style-type: none"> • The recording paper is jammed. Clear the jammed paper (see page 71).
POLLING ERROR	<ul style="list-style-type: none"> • The other unit does not provide the polling function. Check the other party.
REMOVE DOCUMENT	<ul style="list-style-type: none"> • The document is jammed. Open the cover, remove the jammed document (see page 72) and try again. • Attempted to transmit a document longer than 600 mm (23$\frac{5}{8}$""). Press the STOP button and remove the document (see page 72). When sending such a document, divide it into two or more sheets so that each sheet does not exceed 600 mm (23$\frac{5}{8}$"") and try again.

ERROR MESSAGE	CAUSE AND REMEDY
TRANSMIT ERROR	●Transmission error occurred. Try again.
UNIT OVERHEATED	●The unit is too hot. Leave it as it is and allow it to cool down.

General corrective measures

GENERAL

I cannot make and receive calls.

- The line cord is connected incorrectly or not connected. Confirm the connection (see page 11).

I cannot make calls.

- The setting of the dialing mode is wrong. Check the selector (see page 11).

The unit does not work.

- Disconnect the unit from the telephone line and connect a known working phone. If the known working phone operates properly, call your service personnel to have the unit repaired. If the known working phone does not operate properly, consult your telephone company.

The unit does not ring.

- The ringer volume is set to OFF. Raise it to a suitable level (see page 12).

The REDIAL/PAUSE button does not function properly.

- The button has combination feature of redial and pause. It will redial the last dialed number when it is pressed after hanging up and getting dial tone again (see page 17). If it is pressed after you dial another phone number, the button will function as pause button (see page 53).

While programming, I cannot enter the code or ID number.

- The whole or part of the number you try to enter is same as the other code or ID. Change the number into new one (see pages 44, 45 and 59).

FAX TRANSMISSION

The other party complains that letters on their received document are distorted.

- If your line has special telephone services such as call waiting, the service may have been activated during the fax reception. Connect the unit to a line that does not have such services.
- Another telephone connected to the same line as your unit is connected is hung off. Hang up and try again.

The other party complains that dirty patterns or black line appear on their received documents.

- The glass or rollers on your unit are dirty. Clean them (see page 73).

I cannot make an international fax call.

- Use the overseas transmission mode (see page 47).
- Add two pauses at the end of the phone number (see page 53).

FAX RECEPTION

I cannot receive documents automatically.

- The receive mode is set to TEL. Set the receive mode to ANS/FAX, TEL/FAX or FAX.
- The time to answer the call may be too long. Decrease the number of rings (see pages 25 and 26).
- The greeting message may be too long. Shorten the message (up to 20 seconds) or ask the other party to press your remote fax activation code and then start transmission (see page 43).

(continued)

FAX RECEPTION (cont.)

Recording image is faint.

- The sender transmitted a faint document.
Request them to transmit a clearer copy of the document.
- The thermal head is dirty. Clean it (see page 73).

ANSWERING DEVICE

No voice messages have been recorded in the ANS/FAX mode.

- The memory is full. Erase some or all messages (see pages 29 and 61).

I cannot retrieve recorded messages from a remote phone.

- Make sure that you use the remote ANS ID correctly (see page 59). When you dial it, press the buttons firmly.

Messages in the mailbox do not play back.

- You have programmed the mailbox password. Press the password and then try again (see page 55).

COPYING

Dirty patterns or black line appear on the copied documents.

- The glass or rollers on your unit are dirty. Clean them (see page 73).

Copied image is distorted.

- The thermal head is dirty. Clean it (see page 73).

Explanation of communication result on the report _____

When trouble occurs, the following messages may be printed on the transmission report and the journal report.

PRINTED MESSAGE	MEANING
COMMUNICATION ERROR:	●Transmission or reception error occurred. Try again or check the other party.
DOCUMENT JAMMED:	●A document was jammed. Remove the jammed document (see page 72).
JUNKMAIL PROH. REJECT:	●The unit rejected fax reception when the junk mail prohibitor is activated.
NO DOCUMENT:	●The document was not fed into the unit properly.
NO RESPONSE:	●The receiving unit is busy or out of recording paper. Try again.
PAPER JAMMED:	●The recording paper was jammed.
PAPER OUT:	●The unit was out of recording paper.
PRESSED THE STOP KEY:	●The fax communication was interrupted because the STOP button was pressed.
PRINTER OVERHEATED:	●Printer was overheated.
THE COVER WAS OPENED:	●The top cover was open.
OK:	●Fax communication was successful.

Clearing a recording paper jam

When the unit does not eject a recording paper during reception or copying, the recording paper has jammed. Remove the jammed paper by following the steps below.

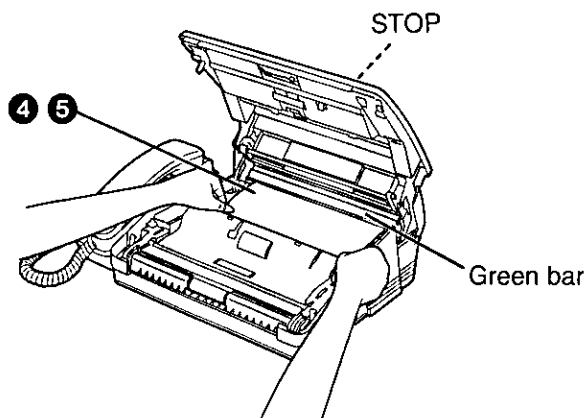
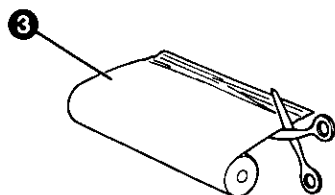
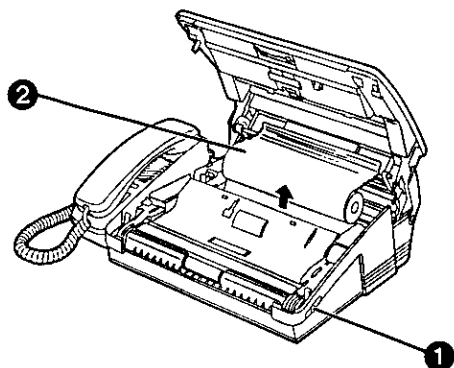

- 1 Slide the lever toward you to open the top cover.
- 2 Remove the jammed paper carefully.
- 3 Cut off the wrinkled portion.
- 4 Replace the recording paper roll in the proper direction.
—Make sure that there is no slack in the paper roll.
- 5 Insert the leading edge of the paper under the green bar.
—If the recording paper cannot be inserted, press the STOP button to reset the paper cutter and insert the paper again.
- 6 Close the cover carefully by gently pressing down on both ends.

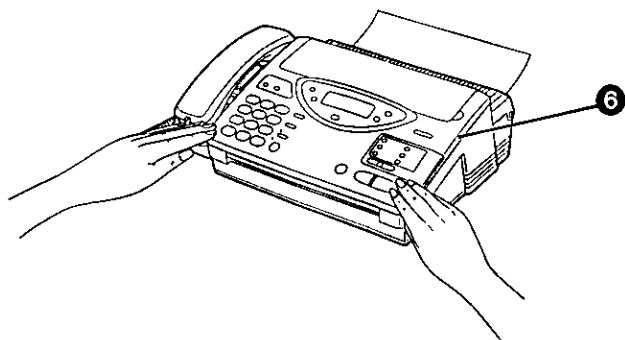

Clearing a document jam

When an original document becomes jammed, remove the jammed document by following the steps below.

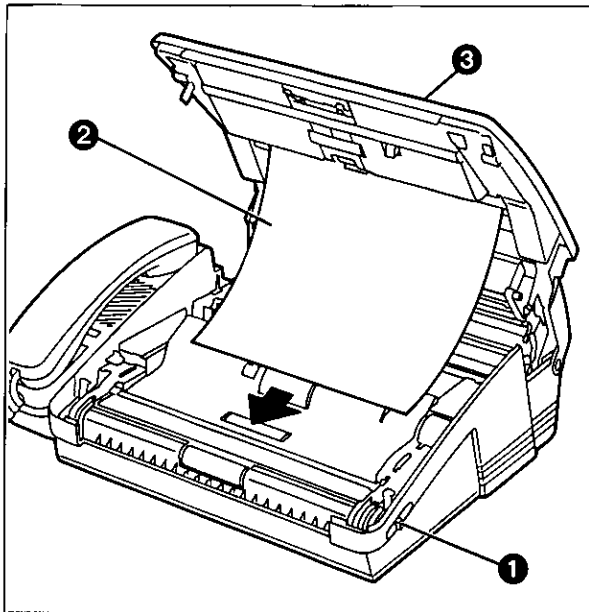

- 1 Slide the lever toward you to open the top cover.
- 2 Remove the jammed document carefully.
- 3 Close the cover carefully by gently pressing down on both ends.

Adjusting the feeder pressure

If misfeeding of documents, such as a multiple feeding or no feeding, occurs frequently, try to adjust the feeder pressure by following the steps below.

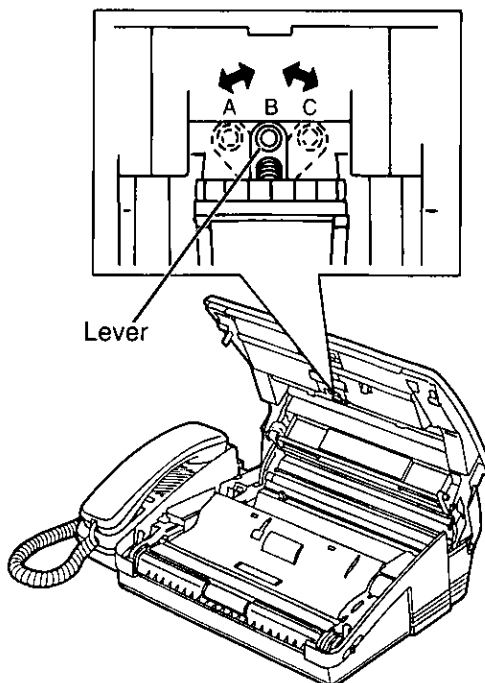

- 1 Open the top cover.
- 2 Shift the position of the lever by using an instrument with a pointed end, like a clip or ball-point pen.

Position A: The case of no feeding
Position B: Standard position
Position C: The case of multiple feeding
- 3 Close the top cover carefully by gently pressing down on both ends.

Maintenance

Cleaning the document feeder unit

When the misfeeding occurs frequently or when dirty patterns or black bands appear on a copied or transmitted document, clean the sub roller, the document feeder rollers and the glass by following the steps below.

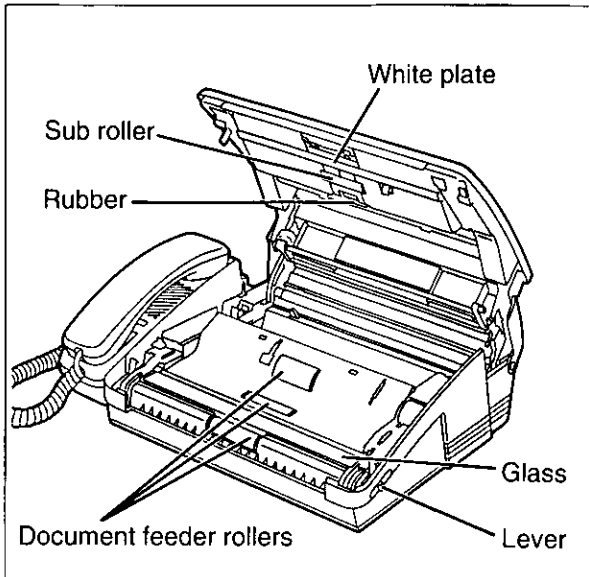

- 1 Disconnect the power cord and the telephone line cord.
- 2 Slide the lever toward you to open the top cover.
- 3 Clean the rubber, the sub roller and the document feeder rollers with a cloth moistened with isopropyl rubbing alcohol, then dry thoroughly.
- 4 Clean the glass and the white plate with a dry soft cloth.
- 5 Close the top cover carefully by gently pressing down on both ends.
- 6 Connect the power cord and telephone line cord.

Cleaning the thermal head

If dirty patterns or black bands appear on a copied or received document, clean the thermal head by following the steps below.

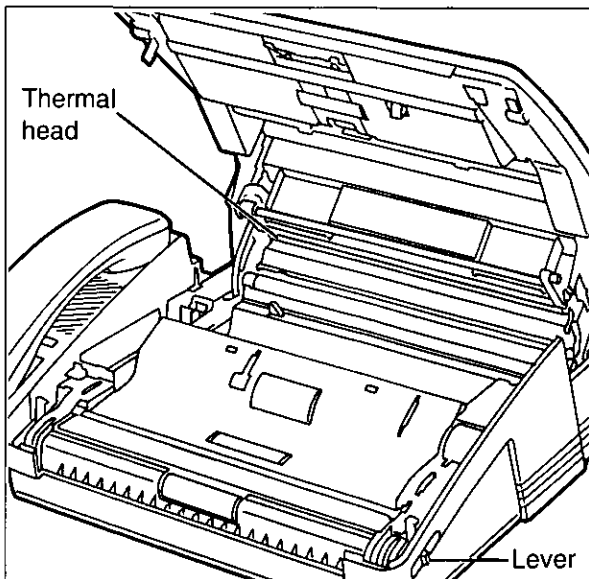

- 1 Disconnect the power cord and the telephone line cord.
- 2 Slide the lever toward you to open the top cover.
- 3 Remove the recording paper roll from the unit.
- 4 Clean the thermal head with a cloth moistened with isopropyl rubbing alcohol, then dry thoroughly.
- 5 Re-install the recording paper roll, then close the top cover carefully by gently pressing down on both ends.
- 6 Connect the power cord and telephone line cord.

Note:

- To prevent malfunction due to static electricity, do not use a dry cloth and do not touch the thermal head directly with your finger.

Important Safety Instructions

When using this unit, basic safety precautions as below should always be followed to reduce the risk of fire, electric shock, or personal injury.

1. Read and understand all instructions.
2. Follow all warnings and instructions marked on this unit.
3. Unplug this unit from wall outlets before cleaning. Do not use liquid or aerosol cleaners. Use a damp cloth for cleaning.
4. Do not use this unit near water, for example, near a bath tub, wash bowl, kitchen sink, or the like.
5. Install this unit securely on a stable surface. Serious damage may result if the unit falls.
6. Do not cover slots and openings of the unit, for they are provided for ventilation and protection against overheating. Never place the unit near radiators, in/or a place where proper ventilation is not provided.
7. Use only the power source as marked on the unit. If you are not sure of the type of the power supply to your home, consult your dealer or local power company.
8. Do not place objects on the power cord. Install the unit where no one can step on the cord.
9. Do not overload wall outlets and extension cords as this can result in the risk of fire or electric shock.
10. Never push any objects into this unit through slots as they may result in risk of fire or electric shock. Never spill any liquid on the unit.
11. To reduce the risk of electric shock, do not disassemble this unit, but take it to a qualified serviceman when some service or repair work is required. Opening or removing covers may expose you to dangerous voltages or other risks. Incorrect reassembly can cause electric shock when the appliance is subsequently used.
12. Unplug this unit from the wall outlet and refer servicing to qualified service personnel under the following conditions:
 - A. When the power supply cord or plug is damaged or frayed.
 - B. If liquid has been spilled into the unit.
 - C. If the unit has been exposed to rain or water.
 - D. If the unit does not work normally by following the operating instructions. Adjust only controls covered by the operating

instructions, for improper adjustment may require extensive work by a qualified technician.

- E. If the unit has been dropped or damaged.
 - F. If the unit exhibits a distinct change in performance.
13. During thunderstorms, avoid using telephones except cordless types. There may be a remote risk of electric shock from lightning.
 14. Do not use this unit to report a gas leak in the vicinity of it.

SAVE THESE INSTRUCTIONS

INSTALLATION:

1. Never install telephone wiring during a lightning storm.
2. Never install telephone jacks in wet locations unless the jack is specifically designed for wet locations.
3. Never touch uninsulated telephone wires or terminals unless the telephone line has been disconnected at the network interface.
4. Use caution when installing or modifying telephone lines.

WARNING:

To prevent fire or shock hazard, do not expose this product to rain or any type of moisture.

Other Information

- Keep the unit away from electrical noise-generating devices, such as fluorescent lamps and motors.
- The unit should be kept free from dust, moisture, high temperature, and vibration.
- The unit should not be exposed to direct sunlight.
- Do not place heavy objects on top of this unit.
- Do not use benzine, thinner, or any abrasive powder, to clean the cabinet. Wipe it with a soft cloth.
- Do not damage the power cord.
Do not touch the plug with wet hands.

Accessory Order Information

Use the following type of recording paper for replacement. For accessory order, call toll free 1-800-332-5368.

Parts No.	Description	Comment
KX-A116	Standard Thermal Recording Paper	216 mm×50 m (8½"×164') roll
KX-A106	Standard Thermal Recording Paper	216 mm×30 m (8½"×98') roll
KX-A125	Super Thermal Recording Paper (Plain paper like)	216 mm×30 m (8½"×98') roll

Specifications

1. **Applicable Lines:** Public Switched Telephone Network
2. **Document Size:** Max. 216 mm (8½") in width
Max. 600 mm (23⅝") in length
3. **Effective Scanning Width:** 208 mm (8⅜")
4. **Printing Paper Size:** (See Accessory Order Information on this page)
5. **Effective Printing Width:** 208 mm (8⅜")
6. **Transmission Time*:** Approx. 15 sec/page (Original mode)
Approx. 30 sec/page (G3 Normal mode)
7. **Fax Auto Redial:** Up to 5 times
8. **Telephone Auto Redial:** Up to 14 times
9. **Scanning Density:** Horizontal 8 pels/mm (203 pels/inch)
Vertical 3.85 lines/mm (98 lines/inch)—Standard
7.7 lines/mm (196 lines/inch)—Fine/Halftone
15.4 lines/mm (392 lines/inch)—Superfine
10. **Scanner Type:** CCD image sensor
11. **Printer Type:** Thermal printing
12. **Data Compression System:** Modified Huffman (MH), Modified READ (MR)
13. **Modem Speed:** 9600/7200/4800/2400 bps; Automatic Fallback
14. **Operating Environment:** 5–35°C (41–95°F), 45%–85% RH
15. **Dimensions (H×W×D):** 122×362×287 mm (4⅓⅙"×14¼"×11⅕⅙")
16. **Mass (Weight):** Approx. 4.1 kg (9.0 lb.)
17. **Power Consumption:** Transmission: Approx. 15 W / Reception: Approx. 35 W
Copy: Approx. 40 W / Standby: Approx. 5 W
Maximum: Approx. 100 W
18. **Power Supply:** 120 V AC, 60 Hz

*Transmission Time: Transmission times apply to text data using ITU-T No. 1 test chart, between the same machine models at maximum modem speed. Transmission times vary in actual usage.



FCC Information

If required by the telephone company, inform them of the following.

- FCC Registration No.: (found on the rear side of the unit)
- Ringer Equivalence No.: (found on the rear side of the unit)
- The particular telephone line to which the equipment is connected.

This unit must not be connected to a coin operated line. If you are on a party line, check with your local telephone company.

Ringer Equivalence Number (REN):

This REN is useful in determining the quantity of devices you may connect to your telephone line and still have all of those devices ring when your telephone number is called. In most but not all areas, the sum of the REN's of all devices connected to one line should not exceed five (5.0). To be certain of the number of devices you may connect to your line, as determined by the REN, you should contact your local telephone company to determine the maximum REN for your calling area.

In the event that terminal equipment causes harm to the telephone network, the telephone company should notify the customer, if possible, that service may be stopped. However, where prior notice is impractical, the company may temporarily cease service providing that they:

- a) Promptly notify the customer.
- b) Give the customer an opportunity to correct the problem with their equipment.
- c) Inform the customer of the right to bring a complaint to the Federal Communication Commission pursuant to procedures set out in FCC Rules and Regulations Subpart E of Part 68.

The Telephone Company may make changes in its communications facilities, equipment operations, or procedures where such action is reasonably required in the operation of its business and is not inconsistent with the rules and regulations in FCC Part 68. If such changes can be reasonably expected to render any customer terminal equipment incompatible with telephone company communications facilities, or require modification

or alteration of such terminal equipment, or otherwise materially affect its use or performance, the customer shall be given adequate notice in writing, to allow the customer an opportunity to maintain uninterrupted service.

CAUTION:

Any unauthorized changes or modifications to this equipment could void the user's authority to operate this device.

When programming emergency numbers and/or making test calls to emergency numbers:

1. Remain on the line and briefly explain to the dispatcher the reason for the call before hanging up.
2. Perform such activities in the off-peak hours; such as early morning or late evenings.

This telephone provides magnetic coupling to hearing aids.

Note:

This equipment has been tested and found to comply with the limits for a Class B digital device, pursuant to Part 15 of the FCC Rules. These limits are designed to provide reasonable protection against harmful interference in a residential installation. This equipment generates, uses, and can radiate radio frequency energy and, if not installed and used in accordance with the instructions, may cause harmful interference to radio communications. However, there is no guarantee that interference will not occur in a particular installation. If this equipment does cause harmful interference to radio or television reception, which can be determined by turning the equipment off and on, the user is encouraged to try to correct the interference by one or more of the following measures:

- Reorient or relocate the receiving antenna.
- Increase the separation between the equipment and receiver.
- Connect the equipment into an outlet on a circuit different from that to which the receiver is connected.
- Consult the dealer or an experienced radio/TV technician for help.

Limited Warranty

PANASONIC PERSONAL FACSIMILE Limited Warranty

Matsushita Consumer Electronics Company or Panasonic Sales Company (collectively referred to as "The warrantor"), will repair this product with new or refurbished parts, free of charge, in the U.S.A. or Puerto Rico for one (1) year from the date of original purchase in the event of a defect in materials or workmanship.

Batteries (when applicable)—New rechargeable batteries in exchange for defective rechargeable batteries for ten (10) days from the date of original purchase. Non-rechargeable batteries are not warranted.

Carry-in or mail-in service in the U.S.A. can be obtained during the warranty period from a Matsushita Services Company (MSC) Factory Servicenter listed in the Servicenter Directory. Carry-in or mail-in service in Puerto Rico can be obtained during the warranty period by calling the telephone numbers listed in the Servicenter Directory.

This warranty is extended only to the original purchaser. A purchase receipt or other proof of date of original purchase will be required before warranty performance is rendered.

This warranty only covers failures due to defects in materials or workmanship which occur during normal use. It does not cover damage which occurs in shipment or failures which are caused by products not supplied by the warrantor or failures which result from accident, misuse, abuse, neglect, mishandling, misapplication, alteration, faulty installation, modification, or service by anyone other than an MSC Factory Servicenter or an authorized MSC Servicenter or damage that is attributable to Acts of God, including, but not limited to, line surges.

LIMITS AND EXCLUSIONS

There are no express warranties except as listed above.

THE WARRANTOR SHALL NOT BE LIABLE FOR SPECIAL, INCIDENTAL, CONSEQUENTIAL OR PUNITIVE DAMAGES, INCLUDING, WITHOUT LIMITATION, LOSS OF GOODWILL, PROFITS OR REVENUE, LOSS OF USE OF THIS PRODUCT OR ANY ASSOCIATED EQUIPMENT, COST OF SUBSTITUTE EQUIPMENT, DOWNTIME COSTS, OR CLAIMS OF ANY PARTY DEALING WITH BUYER FOR SUCH DAMAGES, RESULTING FROM THE USE OF THIS PRODUCT OR ARISING FROM BREACH OF WARRANTY OR CONTRACT, NEGLIGENCE, OR ANY OTHER LEGAL THEORY.

ALL EXPRESS AND IMPLIED WARRANTIES, INCLUDING THE WARRANTIES OF MERCHANTABILITY AND FITNESS FOR A PARTICULAR PURPOSE, ARE LIMITED TO THE APPLICABLE WARRANTY PERIOD SET FORTH ABOVE.

Some states do not allow the exclusion or limitation of consequential damages, or limitations on how long an implied warranty lasts, so the above exclusions or limitations may not apply to you.

This warranty gives you specific legal rights, and you may also have other rights which vary from state to state.

If a problem with this product develops during the warranty period, you may contact your dealer or the MSC Factory Servicenter or authorized MSC servicenter. If the problem is not handled to your satisfaction, write to the Customer Satisfaction Center at the address indicated on the Servicenter Directory.

Index

A	Advanced feature list	64	MENU	36, 38, 41, 64
	ALL MESSAGES	28	MUTE	17
	ANS/FAX mode	15, 22	N	NEW MESSAGES
	ANS/FAX ring count	23		28
	Automatic dialing	16, 21, 38	O	One-touch dialing
B	Basic feature list	64		16, 21, 38
C	Cleaning	73		Original mode
	COPY	27, 50		51
D	Date and time	36		Overseas transmission mode
	Day/night mode	48	P	Pager alert
	Delayed transmission	42		62, 63
	DELETE	35		PAUSE
	Dial keypad	34		53
	Dialing mode	11		Paper save function
	Direct call station keys	16, 21, 35, 38		49
	DIRECTORY	16, 21, 40		Polled
E	Electronic telephone directory	40		41
	ERASE	29		Polling
	Error messages	68, 69		41
	Extension copy	50		Printer test list
F	FAX mode	15, 26	R	RECEIVE MODE
	FAX ring count	26		15
	Feeder pressure	72		REDIAL/PAUSE
	FLASH	16, 53		17
G	GREETING REC	13, 54		Remote ANS ID
	GREETING SELECT	13, 54		59
H	Handset volume	12		Remote fax activation code
	HELP	3		43, 44
I	INSERT	35		REPEAT
J	Journal auto print	67		29
	Journal report	64		RESOLUTION
	Junk mail prohibitor	45		19
	Junk mail prohibitor ID	45, 46		Ringer volume
L	Logo position	47	S	SECRET
	LOWER	16, 21, 38		39
M	MAIL BOX	56		Set default
	MEMO/2WAY REC	30		51
				Silent fax recognition ring
				25
				SKIP
				29
				SPACE
				35
				Speaker volume
				12
				Speed dialing
				16, 21, 39
				SP-PHONE
				16, 52
				START/SET
				13, 20, 36
				STOP
				20
			T	TEL mode
				15
				TEL/FAX mode
				15, 24
				TEL/FAX delayed ring
				25
				Telephone number list
				64
				TONE
				53
				TONE/PULSE
				11
				Transmission report
				37
			V	VOLUME
				12
			Y	Your logo
				36
				Your telephone number
				37

FAX CORRESPONDENCE

TO: _____ DATE: _____

FROM: _____ OUR TEL. NO.: _____

We would like to take this opportunity to introduce you to our Panasonic telephone answering device with facsimile. Our unit will work as a facsimile, an answering device and a standard telephone, so you can send both documents and voice messages on the same call.

Leaving a voice message and transmitting a document

1. Dial our phone number.
 - Our unit will play the greeting message.
2. Leave your message after the long beep.
3. Press your “*” (asterisk) button **twice** to activate the fax reception.
 - A fax tone will sound.
4. Start transmission to send a fax.

Transmitting a document only

1. Dial our phone number.
 - Our unit will play the greeting message.
2. Press your “*” button **twice** while the greeting message is being played.
 - A fax tone will sound.
3. Start transmission to send a fax.

Leaving a voice message and transmitting a document from a rotary (pulse) phone

1. Dial our phone number.
 - Our unit will play the greeting message.
2. Start transmission to send a fax.
3. Make a call reservation (e.g. ...lift the handset) during transmission of your document.
4. Leave your message after the long beep following the greeting message.

Transmitting a document from a rotary (pulse) phone

1. Dial our phone number.
 - Our unit will play the greeting message.
2. Start transmission to send a fax while the greeting message is being played.

Notes:

- If you wish to receive voice messages and documents automatically, set the unit in the ANS/FAX mode.
- “* button **twice**” is called remote fax activation code (see page 44). If you change it into another one, inform callers of pressing the code.

Speed dialer list

Station No.	Name/Phone No.	Station No.	Name/Phone No.
00		11	
01		12	
02		13	
03		14	
04		15	
05		16	
06		17	
07		18	
08		19	
09		20	
10		21	

Answering device remote operation card

<p style="text-align: center;">Mailbox Remote Operation</p> <p>■ Recording a message into a mailbox:</p> <ol style="list-style-type: none">1. Call your unit.2. Press * and the mailbox no. (1, 2 or 3).3. Leave a message. <p>■ Retrieving messages from a mailbox:</p> <ol style="list-style-type: none">1. Call your unit.2. Press * and the mailbox no. (1, 2 or 3).3. Press the mailbox password <input type="text"/> <input type="text"/> <input type="text"/>.4. Press the remote command key (refer to the reverse side).	<p style="text-align: center;">Mailbox Remote Operation</p> <p>■ Recording a message into a mailbox:</p> <ol style="list-style-type: none">1. Call your unit.2. Press * and the mailbox no. (1, 2 or 3).3. Leave a message. <p>■ Retrieving messages from a mailbox:</p> <ol style="list-style-type: none">1. Call your unit.2. Press * and the mailbox no. (1, 2 or 3).3. Press the mailbox password <input type="text"/> <input type="text"/> <input type="text"/>.4. Press the remote command key (refer to the reverse side).
<p style="text-align: center;">Mailbox Remote Operation</p> <p>■ Recording a message into a mailbox:</p> <ol style="list-style-type: none">1. Call your unit.2. Press * and the mailbox no. (1, 2 or 3).3. Leave a message. <p>■ Retrieving messages from a mailbox:</p> <ol style="list-style-type: none">1. Call your unit.2. Press * and the mailbox no. (1, 2 or 3).3. Press the mailbox password <input type="text"/> <input type="text"/> <input type="text"/>.4. Press the remote command key (refer to the reverse side).	<p style="text-align: center;">Notice of Remote Operation</p> <ul style="list-style-type: none">● The remote operation is available only from a touch tone phone when the unit is in the <i>ANS/FAX</i> mode.● When the unit is in the <i>TEL</i> mode, call your unit and wait for 15 rings. The unit will switch to <i>ANS/FAX</i> mode.● When you press any key, press firmly.● To send a document, press * * (remote fax activation code). When a fax tone is heard, start transmission.

Fold here

Key	Remote Command
1	Repeating a message
2	Skipping a message
4	New message playback
5	All message playback
6	Room monitoring
7	Re-recording a greeting message
9	Stopping re-recording of a greeting message
*4	Erasing a specific message
*5	Erasing all messages
8 1	Pager alert ON
8 2	Pager alert OFF

Key	Remote Command
1	Repeating a message
2	Skipping a message
4	New message playback
5	All message playback
6	Room monitoring
7	Re-recording a greeting message
9	Stopping re-recording of a greeting message
*4	Erasing a specific message
*5	Erasing all messages
8 1	Pager alert ON
8 2	Pager alert OFF

Answering Device Remote Operation

1. Call your unit.
2. Press the remote ANS ID during the greeting message.
3. Press remote command key (refer to right) within 4 seconds.
or
Wait for 4 seconds. All the recorded messages will be played back.

- To skip the greeting message, press **0**.
- To erase a specific message, press ***4** when a message to be erased is being played back.
- To erase all the recorded messages, press ***5**.

Key	Remote Command
1	Repeating a message
2	Skipping a message
4	New message playback
5	All message playback
6	Room monitoring
7	Re-recording a greeting message
9	Stopping re-recording of a greeting message
*4	Erasing a specific message
*5	Erasing all messages
8 1	Pager alert ON
8 2	Pager alert OFF

Servicenter Directory

**PRODUCT INFORMATION • OPERATION ASSISTANCE • LITERATURE
REQUESTS • DEALER LOCATIONS**

DIAL TOLL FREE: 1-800-HELP-FAX

Customer Satisfaction Center 2F-3, One Panasonic Way, Secaucus, NJ 07094 (Headquarters)
201-348-9090 (9:00am-8:00pm Monday-Friday, EST)

AUTHORIZED SERVICENTERS • PARTS DISTRIBUTOR LOCATIONS

To locate an independent authorized servicenter or parts distributor in your area, within the USA dial toll free **1-800-545-2672**, 24 hours a day, 7 days a week.

PRODUCT REPAIRS Factory Servicenters

CALIFORNIA

6550 Katella Avenue
Cypress, CA 90630
Phone (714) 373-7425
Fax (714) 894-8534

800 Dubuque Avenue
So. San Francisco,
CA 94080
Phone (415) 871-6373
Fax (415) 871-6840

20201 Sherman Way
Suite 102
Canoga Park, CA 91306
Phone (818) 709-1775
Fax (818) 709-2165

3878 Ruffin Road
Suite A
San Diego, CA 92123
Phone (619) 560-9200
Fax (619) 560-1831

COLORADO

1640 South Abilene Suite D
Aurora, CO 80012
Phone (303) 752-2024
Fax (303) 752-0610

FLORIDA

3700 North 29th Avenue
Suite 102
Hollywood, FL 33020
Phone (305) 925-2880
Fax (305) 925-5224

4710 Eisenhower
Boulevard Suite A1
Tampa, FL 33634
Phone (813) 884-4746
Fax (813) 886-4564

GEORGIA

4245 International Boulevard
Suite C
Norcross, GA 30093
Phone (404) 717-6880
Fax (404) 717-6668

HAWAII

99-859 Iwaiwa Street
Aiea, Hawaii 96701
Phone (808) 488-1996
Fax (808) 486-4369

ILLINOIS

*1703 North Randall Road
Elgin, IL 60123
"12:30 to 4:30, Mon-Fri"
Phone (708) 468-5466
Fax (708) 468-5465

9060 Golf Road
Niles, IL 60714
Phone (708) 299-1700
Fax (708) 299-1710

MARYLAND

Sulphur Springs
Business Center
1638 Sulphur Springs Road
Baltimore, MD 21227
Phone (410) 242-2607
Fax (410) 247-3047

MASSACHUSETTS

60 Glacier Drive, Suite G
Westwood, MA 02090
Phone (617) 329-4280
Fax (617) 329-0586

*pick-up/drop-off only

MICHIGAN

37048 Van Dyke Avenue
Sterling Heights, MI 48312
Phone (810) 939-2060
Fax (810) 939-2638

MINNESOTA

7850-12th Avenue South
Airport Business Center
Bloomington, MN 55425
Phone (612) 854-8624
Fax (612) 854-2089

MISSOURI

11982 Dorsett Road
Maryland Heights, MO 63043
Phone (314) 739-5301
Fax (314) 739-3631

OHIO

2236 Waycross Road
Cincinnati, OH 45240
Phone (513) 851-4180
Fax (513) 851-8443

PENNSYLVANIA

2221 Cabot Boulevard West
Suite B
Langhorne, PA 19047
Phone (215) 741-0661
Fax (215) 741-0521

Campbell's Run
Business Center
500 Business Center Drive
Pittsburgh, PA 15205
Phone (412) 788-2174
Fax (412) 788-2176

TENNESSEE

919-8th Avenue South
Nashville, TN 37203
Phone (615) 244-4434
Fax (615) 244-6713

TEXAS

7482 Harwin Drive
Houston, TX 77036
Phone (713) 781-1528
Fax (713) 781-0643

13615 Welch Road Suite 101
Farmers Branch, TX 75244
Phone (214) 385-1975
Fax (214) 960-7626

WASHINGTON

20425-84th Avenue South
Kent, WA 98032
Phone (206) 872-7922
Fax (206) 872-0918

Service in Puerto Rico

**Matsushita Electric
of Puerto Rico, Inc.
Panasonic Sales Company/
Factory Servicenter**

Ave. 65 de Infanteria, Km. 9.5
San Gabriel Industrial Park
Carolina, Puerto Rico 00985
Phone (809) 750-4300
Fax (809) 768-2910

REPAIR INQUIRIES Regional Customer Care Department

EAST (PCE)

2221 Cabot Boulevard West
Suite A
Langhorne, PA 19047
Phone (215) 741-0676
Fax (215) 750-6492

Covers:

CT, DE, ME, MD, MA,
NH, NJ, NY, PA, RI, VT,
VA, DC, WV

EAST (PCE)

1854 Shackelford Court
Suite 4105
Norcross, GA 30093
Phone (404) 717-6860
Fax (404) 717-6678

Covers:

AL, FL, GA, MS, NC, SC, TN

CENTRAL (PCC)

1703 North Randall Road
Elgin, IL 60123
Phone (708) 468-5530
Fax (708) 468-5528

Covers:

AR, IL, IN, IA, KS, KY, LA,
MI, MN, MO, NE, ND, OK,
SD, TX, WI, OH

WEST (PCW)

6550 Katella Avenue
Cypress, CA 90630
Phone (714) 373-7440
Fax (714) 373-7447

Covers:

AK, AZ, CA, CO, ID, MT, NV,
NM, OR, UT, WA, WY, HI

ACCESSORY PURCHASES

1-800-332-5368 (Consumer Orders Only)

Matsushita Services Company Box 01, 545 Tollgate Road Suite C, Elgin, IL 60123

(8:00am-7:30pm Monday-Thursday; 8:00am-5:00pm Friday; 9:00am-12:30pm Saturday; CST)

(Visa, Mastercard, Discover card, Check or Money Order)

(940905)

FAX ADVANTAGE PROGRAM

We are proud to present the Panasonic Fax Advantage Program. It's an incredible service program that's full of exciting advantages!

Customer Satisfaction

In support of our one-year limited warranty* (parts and labor) on our current fax product line, Panasonic is proud to offer you the following service options during the limited warranty period:

- 1 If you mail-in or carry-in your fax unit to one of our Regional Servicenters, the product will be repaired and returned to you, or...
- 2 If you call our 1-800-HELPFAX toll-free number, you will receive a refurbished replacement product overnight or on the second business day (delivery depending on the time of your call.)

Support After The Sale

If you have a problem with your fax, just call our 1-800-HELPFAX toll-free number for friendly support and assistance. We have a highly-qualified team of experts who can diagnose, and most likely solve, your problem over the phone. Approximately 90% of our customers' problems are resolved with just a simple phone call.

The Fax Advantage Program covers the first year of purchase and works like this:

- 1 If you have a problem with your fax, call toll-free 1-800-HELPFAX.
- 2 Talk to one of our experienced technical experts to diagnose (and most likely solve) your problem over the phone.
- 3 Providing that you may be entitled to Panasonic's service under the terms and conditions of the limited warranty**, we will arrange for a reconditioned replacement unit to be shipped to you overnight or second business day delivery, depending on the time of your call. The replacement unit will be completely refurbished, quality-tested by Panasonic technicians, and individually hand-inspected before it is shipped to you. You will keep the replacement unit and send your



original unit to us, along with a copy of your receipt.

4 This receipt *must be shipped back* with your original unit to Panasonic Company (as per instructions enclosed in your replacement unit's box).

Any unit that is replaced by Panasonic and *not* backed up by a proof of purchase by you will be subject to a minimum \$100.00 charge. Any unit that is replaced, but does not meet the terms and conditions of the limited warranty will be subject to additional charges, as per the program guidelines.

5 Once you receive your replacement unit, pack up your problem unit in the replacement unit's box. UPS will make 3 attempts within 10 days to pick-up your defective unit at no charge to you (should you be entitled to warranty service. If warranty conditions do not apply, you will be charged for all applicable shipping charges). *The product must be properly packaged in the same manner as the replacement unit, utilizing the packing materials provided.* You must make your unit available for UPS pick-up. If your unit is not available for UPS, you will be responsible for shipping unit back at your expense. Damage due to improper or inadequate packing will be charged back to your charge card as an out-of-warranty cost, as per the warranty stipulations (see back panel.)

Requirements:

6 You must give our technicians a valid credit card number. They will keep this number on file to cover any charges that are incurred by failure to send the problem product to Panasonic Company. If your problem unit is not eligible for warranty, you will be charged for the repair of the unit and for any shipping charges associated with this program. If you do not wish to pay out-of-warranty repair costs, you will be responsible for returning the replacement unit to Panasonic and for paying all shipping charges associated with this program including the overnight delivery of replacement product to you, shipment of problem unit to Panasonic, the replacement unit back to Panasonic and the return of your original unit back to you.

Acceptable credit cards:

Discover VISA
Master Card American Express (Optima)

Product that is not returned to Panasonic by 10 business days after shipment of the replacement product, will be charged to your account at Panasonic's Suggested Retail Price (see dealer for details).

Credit status will be verified prior to sending the replacement product.

Proof of Purchase must be included with the returned unit to verify warranty status.

Any parts and labor that are not covered by the limited warranty* will be charged as a non-warranty repair and billed at Panasonic's current rate for parts and labor.

*See back panel for one-year limited warranty.

**Replacement program excludes Puerto Rico and is subject to termination at any time without advance notice.



Matsushita Consumer Electronics Company, Division of Matsushita Electric Corporation of America
One Panasonic Way, Secaucus,
New Jersey 07094

Panasonic Sales Company, Division of Matsushita Electric of Puerto Rico, Inc. ("PSC")
Ave. 65 de Infantería, Km. 9.5
San Gabriel Industrial Park, Carolina,
Puerto Rico 00985

Free Manuals Download Website

<http://myh66.com>

<http://usermanuals.us>

<http://www.somanuals.com>

<http://www.4manuals.cc>

<http://www.manual-lib.com>

<http://www.404manual.com>

<http://www.luxmanual.com>

<http://aubethermostatmanual.com>

Golf course search by state

<http://golfingnear.com>

Email search by domain

<http://emailbydomain.com>

Auto manuals search

<http://auto.somanuals.com>

TV manuals search

<http://tv.somanuals.com>