

Operating Instructions

DVD Recorder

Model No. **DMR-ES15EB/EBL**

(Model suffix: "EB" for UK model, "EBL" for Ireland model)

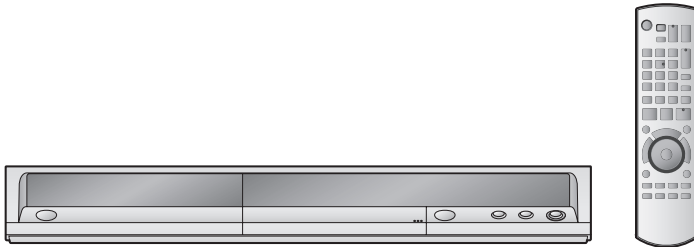

VIDEOplus+

Web Site: <http://www.panasonic-europe.com>

Region number supported by this unit

Region numbers are allocated to DVD players and DVD-Video according to where they are sold.

- The region number of this unit is "2".
- The unit will play DVD-Video marked with labels containing "2" or "ALL".

Example:



Dear customer

Thank you for purchasing this product. For optimum performance and safety, please read these instructions carefully.

Before connecting, operating or adjusting this product, please read the instructions completely.

Please keep this manual for future reference.

Note

"EB" on the packaging indicates the United Kingdom.

EB EBL

RQT8320-1B

Quick access to a variety of useful functions—“FUNCTIONS” menu

Display the FUNCTIONS menu to view all functions on this unit and select function for timer recording etc.

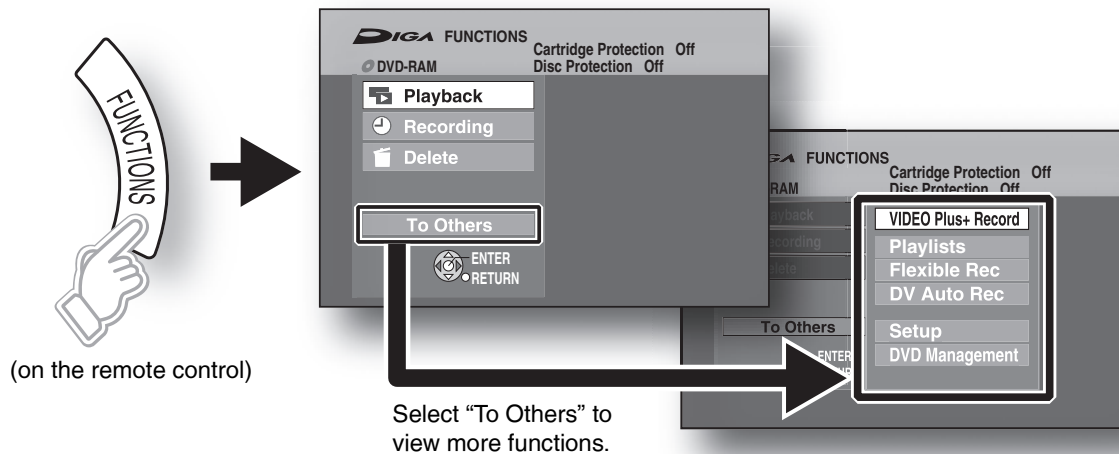

Caution for AC Mains Lead



**(For United Kingdom and Republic of Ireland)
("EB" and "EBL" area code model only)**

For your safety, please read the following text carefully.

This appliance is supplied with a moulded three pin mains plug for your safety and convenience.

A 5-ampere fuse is fitted in this plug.

Should the fuse need to be replaced please ensure that the replacement fuse has a rating of 5-ampere and that it is approved by ASTA or BSI to BS1362.

Check for the ASTA mark  or the BSI mark  on the body of the fuse.

If the plug contains a removable fuse cover you must ensure that it is refitted when the fuse is replaced.

If you lose the fuse cover the plug must not be used until a replacement cover is obtained.

A replacement fuse cover can be purchased from your local dealer.

CAUTION!

IF THE FITTED MOULDED PLUG IS UNSUITABLE FOR THE SOCKET OUTLET IN YOUR HOME THEN THE FUSE SHOULD BE REMOVED AND THE PLUG CUT OFF AND DISPOSED OF SAFELY.

THERE IS A DANGER OF SEVERE ELECTRICAL SHOCK IF THE CUT OFF PLUG IS INSERTED INTO ANY 13-AMPERE SOCKET.

If a new plug is to be fitted please observe the wiring code as stated below.

If in any doubt please consult a qualified electrician.

IMPORTANT

The wires in this mains lead are coloured in accordance with the following code:

Blue: Neutral, Brown: Live.

As these colours may not correspond with the coloured markings identifying the terminals in your plug, proceed as follows:

The wire which is coloured Blue must be connected to the terminal which is marked with the letter N or coloured Black or Blue.

The wire which is coloured Brown must be connected to the terminal which is marked with the letter L or coloured Brown or Red.

WARNING: DO NOT CONNECT EITHER WIRE TO THE EARTH TERMINAL WHICH IS MARKED WITH THE LETTER E, BY THE EARTH SYMBOL \perp OR COLOURED GREEN OR GREEN/YELLOW.

THIS PLUG IS NOT WATERPROOF—KEEP DRY.

Before use

Remove the connector cover.

How to replace the fuse

The location of the fuse differ according to the type of AC mains plug (figures A and B). Confirm the AC mains plug fitted and follow the instructions below.

Illustrations may differ from actual AC mains plug.

1. Open the fuse cover with a screwdriver.

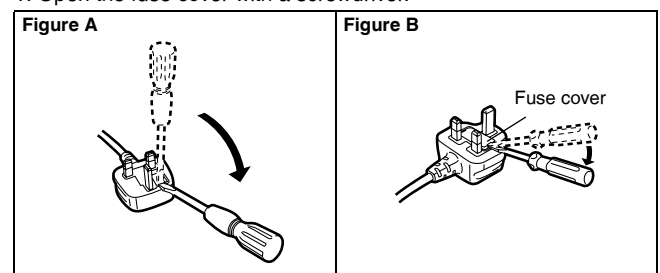

2. Replace the fuse and close or attach the fuse cover.

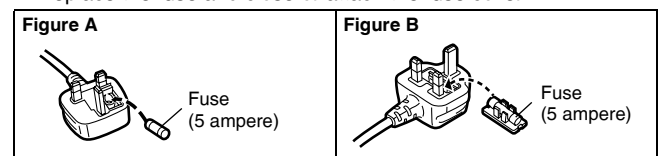

Table of contents

Getting started

Quick access to a variety of useful functions— “FUNCTIONS” menu	2
Caution for AC Mains Lead	2
Safety precautions	3
Included accessories	4
Disc handling	4
Unit care	4
Control reference guide	5
Disc information	6
The remote control information	7
Connection	8
TV Tuning (Auto Setup)	12
Set up to match your television and remote control	14

Recording

Important notes for recording	16
Recording modes and approximate recording times	17
Disc Insertion/Ejection	17
Recording television programmes	18
To specify a time to stop recording	
–One Touch Recording	19
Flexible Recording	19
Playing while you are recording	19
Timer recording	20
Using VIDEO Plus+ system to make timer recordings	20
Manually programming timer recordings	21
To cancel recording when recording has already begun	21
To release the programme from recording standby	21
Notes on timer recording	21
Check, change or delete a programme	22
Making timer recordings on the television	22
Recording from a satellite/digital terrestrial receiver	23
Manual Recording	23
Linked timer recordings with external equipment (SKY Digital STB/digital terrestrial receiver)—EXT LINK	23

Playing back

Playing discs	24
Changing audio during play	24
Operations during play	25
Using menus to play MP3 and still pictures (JPEG/TIFF)	26
Playing MP3	26
Playing still pictures (JPEG/TIFF)	27
Useful functions during still picture play	27
Using on-screen menus/FUNCTIONS window and Status message	28
Using on-screen menus	28
FUNCTIONS window	29
Status message	29

Safety precautions

Placement

Set the unit up on an even surface away from direct sunlight, high temperatures, high humidity, and excessive vibration. These conditions can damage the cabinet and other components, thereby shortening the unit's service life.

Do not place heavy items on the unit.

Voltage

Do not use high voltage power sources. This can overload the unit and cause a fire.

Do not use a DC power source. Check the source carefully when setting the unit up on a ship or other place where DC is used.

AC mains lead protection

Ensure the AC mains lead is connected correctly and not damaged. Poor connection and lead damage can cause fire or electric shock. Do not pull, bend, or place heavy items on the lead.

Grasp the plug firmly when unplugging the lead. Pulling the AC mains lead can cause electric shock.

Do not handle the plug with wet hands. This can cause electric shock.

Editing

Editing titles/chapters	30
Editing titles/chapters and playing chapters	30
Title operations	31
Chapter operations	31
Creating, editing and playing playlists	32
Creating playlists	32
Editing and playing playlists/chapters	33
Playlist operations	33
Chapter operations	33

Copying

Copying from a video cassette recorder	34
DV automatic recording DV Auto Rec	34
Manual recording	34

Convenient functions

Deleting titles	35
Using DELETE Navigator to delete titles	35
Deleting titles during play	35
DVD Management	36
Common procedures	36
Providing a name for a disc	36
Setting the protection	36
Deleting all titles and playlists—Delete all titles	36
Deleting all the contents of a disc—Format Disc	36
Selecting whether to show the Top Menu first	
–Auto-Play Select	37
Enabling discs to be played on other equipment	
–Finalize	37
Creating Top Menu—Create Top Menu	37
Enabling the second layer on DL (dual- or double- layer on single side) discs to be recordable	
–Close First Layer	37
Linked operations with the TV (Q Link)	38
Child Lock	38
Changing the unit's settings	39
Common procedures	39
Summary of settings	39
Set the clock manually	41
Resetting channel setting	42
TV System	43
Entering text	43

Reference

Messages	44
Frequently asked questions	45
Troubleshooting guide	46
Glossary	49
Specifications	50
Index	Back cover

Foreign matter

Do not let metal objects fall inside the unit. This can cause electric shock or malfunction.

Do not let liquids get into the unit. This can cause electric shock or malfunction. If this occurs, immediately disconnect the unit from the power supply and contact your dealer.

Do not spray insecticides onto or into the unit. They contain flammable gases which can ignite if sprayed into the unit.

Service





Do not attempt to repair this unit by yourself. If sound is interrupted, indicators fail to light, smoke appears, or any other problem that is not covered in these instructions occurs, disconnect the AC mains lead and contact your dealer or an authorized service center. Electric shock or damage to the unit can occur if the unit is repaired, disassembled or reconstructed by unqualified persons.

Extend operating life by disconnecting the unit from the power source if it is not to be used for a long time.

Included accessories

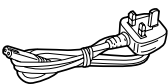
Please check and identify the supplied accessories. Use numbers when asking for replacement parts. (Product numbers correct as of December 2005. These may be subject to change.)

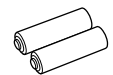
To order accessories, refer to "Sales and Support Information" (→ below).

- | | | | |
|---|--|---|--|
| <p><input type="checkbox"/> </p> <p>1 Remote control
(EUR7659Y50)</p> | <p><input type="checkbox"/> </p> <p>1 AC mains lead
(RJA0044-3C)</p> <ul style="list-style-type: none"> • For use with this unit only. Do not use it with other equipment. Also do not use the cords for other equipment with this unit. | <p><input type="checkbox"/> </p> <p>2 RF coaxial leads (black)
(K1TWACC00001)</p> <p><input type="checkbox"/> </p> <p>2 Batteries
R6 Size
for remote control</p> | <p><input type="checkbox"/> </p> <p>1 RF coaxial lead (grey)
(K1TWACA00001)</p> <p><input type="checkbox"/> </p> <p>1 Audio/video cable
(K2KA6BA00003)</p> |
|---|--|---|--|

■ Sales and Support Information

Customer Care Centre

- For customers within the UK: 08705 357357
- For customers within the Republic of Ireland: 01 289 8333
- Visit our website for product information
- E-mail: customer.care@panasonic.co.uk

Direct Sales at Panasonic UK

- Order accessory and consumable items for your product with ease and confidence by phoning our Customer Care Centre Monday-Thursday 9:00am-5:30pm, Friday 9:30am-5:30pm (Excluding public holidays).

- Or go on line through our Internet Accessory ordering application at www.panasonic.co.uk.
- Most major credit and debit cards accepted.
- All enquiries transactions and distribution facilities are provided directly by Panasonic UK Ltd.
- It couldn't be simpler!
- Also available through our Internet is direct shopping for a wide range of finished products, take a browse on our website for further details.

*Interested in purchasing an extended guarantee?
Please call 0870 240 6284 or visit our website
www.panasonic.co.uk/guarantee.*

Disc handling

■ How to hold a disc

Do not touch the recorded surface.

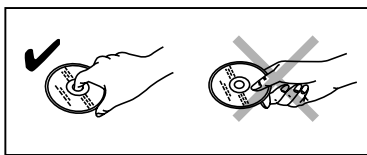

■ Concerning non-cartridge discs

Be careful about scratches and dirt.

■ If there is dirt or condensation on the disc

Wipe with a damp cloth and then wipe dry.

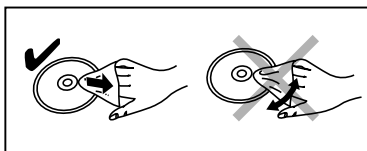

■ Handling precautions

- Do not attach labels or stickers to discs. (This may cause disc warping and un-balanced rotation, rendering it unusable.)
- Write on the label side of the disc only with a soft, oil-based felt pen. Do not use ballpoint pens or other hard writing implements. (This may cause disc warping and un-balanced rotation, rendering it unusable.)
- Do not use record cleaning sprays, benzene, thinner, static electricity prevention liquids or any other solvent.
- Do not use scratch-proof protectors or covers.
- Do not drop stack, or impact discs. Do not place objects on them.

- Do not use the following discs:
 - Discs with exposed adhesive from removed stickers or labels (rental discs, etc.).
 - Discs that are badly warped or cracked.
 - Irregularly shaped discs, such as heart shapes.
- Do not place in the following areas:
 - In direct sunlight.
 - In very dusty or humid areas.
 - Near a heater.
 - Locations susceptible to significant difference in temperature (condensation can occur).
 - Where static electricity or electromagnetic waves occur.
- To protect discs from scratches and dirt, return them to their cases or cartridges when you are not using them.

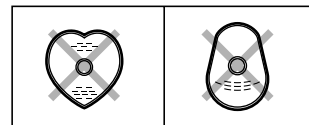

The manufacturer accepts no responsibility and offers no compensation for loss of recorded or edited material due to a problem with the unit or recordable media, and accepts no responsibility and offers no compensation for any subsequent damage caused by such loss.

Examples of causes of such losses are

- A disc recorded and edited with this unit is played in a DVD Recorder or computer disc drive manufactured by another company.
- A disc used as described above and then played again in this unit.
- A disc recorded and edited with a DVD Recorder or computer disc drive manufactured by another company is played in this unit.

Unit care

The precision parts in this unit are readily affected by the environment, especially temperature, humidity, and dust. Cigarette smoke also can cause malfunction or breakdown.

To clean this unit, wipe with a soft, dry cloth.

- Never use alcohol, paint thinner or benzene to clean this unit.
- Before using chemically treated cloth, carefully read the instructions that came with the cloth.

Observe the following points to ensure continued listening and viewing pleasure.

Dust and dirt may adhere to the unit's lens over time, making it impossible to record or play discs. Use the **DVD lens cleaner** (RP-CL720E) about once every year, depending on frequency of use and the operating environment. Carefully read the lens cleaner's instructions before use.

Before moving the unit, ensure the disc tray is empty. Failure to do so will risk severely damaging the disc and the unit.

Remote control

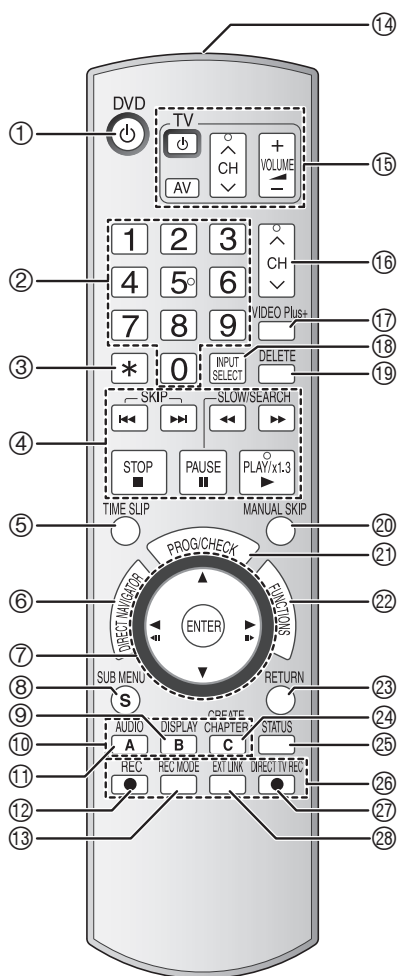

- ① Turn the unit on/off (→ page 12)
- ② Select channels and title numbers etc./Enter numbers
- ③ Cancel
- ④ Basic operations for recording and play
- ⑤ Skip the specified time (→ page 25)
- ⑥ Show Direct Navigator/Top menu (→ page 24, 26, 30)
- ⑦ Selection/Enter, Frame-by-frame (→ page 12, 25)
- ⑧ Show sub menu (→ page 27, 30, 33)
- ⑨ Show on-screen menu (→ page 28)
- ⑩ Manual tuning operation (→ page 42)
- ⑪ Select Audio (→ page 24)
- ⑫ Start recording (→ page 18)
- ⑬ Change recording mode (→ page 18)
- ⑭ Transmit the remote control signal
- ⑮ Television operations (→ page 15)
- ⑯ Channel select (→ page 18)
- ⑰ Show VIDEO Plus+ screen (→ page 20)
- ⑱ Input select (AV1, AV2, AV3 or DV)
- ⑲ Delete items (→ page 35)
- ⑳ Skip 30 seconds forward (→ page 25)
- ㉑ Show timer recording programme screen (→ page 21)
- ㉒ Show FUNCTIONS window (→ page 2, 14, 29)
- ㉓ Return to previous screen
- ㉔ Create chapter (→ page 25)
- ㉕ Show status messages (→ page 29)
- ㉖ Recording function
- ㉗ Direct TV recording (→ page 38)
- ㉘ Linked timer recordings with external equipment (→ page 23)

Included accessories/Disc handling/Unit care/Control reference guide

Main unit

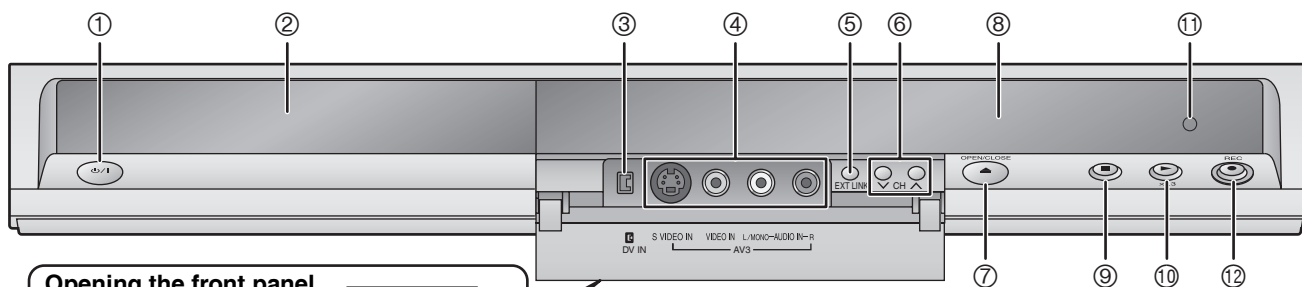

Opening the front panel

Press down on the ... part with your finger.

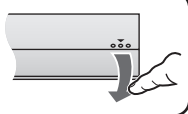



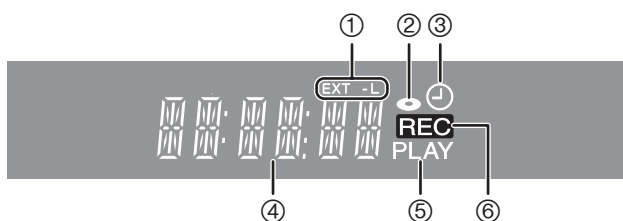

- ① Standby/on switch (⏻/⏻) (→ page 12)
Press to switch the unit from on to standby mode or vice versa. In standby mode, the unit is still consuming a small amount of power.
- ② Disc tray (→ page 18)
- ③ Connection for digital video (DV) camcorder (→ page 34)
- ④ Connection for camcorder etc. (→ page 34)
- ⑤ Linked timer recordings with external equipment (→ page 23)
- ⑥ Channel select (→ page 18)
- ⑦ Open/close disc tray (→ page 18)
- ⑧ Display (→ below)
- ⑨ Stop (→ page 18, 25)
- ⑩ Start play (→ page 24)
- ⑪ Remote control signal sensor
- ⑫ Start recording (→ page 18)/
Specify the time to stop recording (→ page 19)

The unit's display



- ① Linked timer recordings with external equipment indicator
- ② Disc indicator
• This indicator lights up when a disc that is supported by this unit is inserted.
- ③ Timer recording indicator
- ④ Main display section
- ⑤ Playing indicator
- ⑥ Recording indicator

Discs you can use for recording and play

Disc type	DVD-RAM	DVD-R	DVD-R DL※1 (dual layer on single side)	DVD-RW	+R※2	+R DL※1 (double layer on single side)	+RW
Indication in these instructions by	RAM	-R Before finalization	-R DL Before finalization	-RW(V) Before finalization	+R Before finalization	+R DL Before finalization	+RW
		DVD-V After finalization	DVD-V After finalization	DVD-V After finalization	DVD-V After finalization	DVD-V After finalization	
Logo					—	—	—
Recording format (→ below)	VR	DVD-Video	DVD-Video	DVD-Video	+VR	+VR	+VR
Re-writable※3	✓	×	×	✓	×	×	✓
What you can do on this unit							
Recording broadcasts that allow one copy	✓※4	×	×	×	×	×	×
Recording both M 1 and M 2 of bilingual broadcasts	✓	×	×	×	×	×	×
Recording 16:9 aspect picture	✓	×	×	×	×	×	×
Creating playlists	✓	×	×	×	×	×	×
Compatibility							
Usable high speed recording disc type※5	Up to 5x	Up to 16x	Up to 4x	Up to 6x	Up to 16x	Up to 2.4x	Up to 4x※6
Play on other players	Only on DVD-RAM compatible players. (It is not possible to finalize the disc.)	✓	✓※7	✓	✓	✓※8	✓ (It is not possible to finalize the disc.)
Only on compatible players after finalizing the disc (→ page 37)							

✓: Can do, ×: Cannot do

- We recommend using Panasonic discs. We also recommend using DVD-RAM discs with cartridges to protect them from scratches and dirt.
- You may not be able to record depending on the condition of the discs and you may not be able to play due to the condition of the recording.
- For the recording time, refer to “Recording modes and approximate recording times” on page 17.
- You cannot record programmes that allow “One time only recording” to CPRM compatible DVD-R and DVD-RW on this unit. You can record other programmes as DVD-Video format.

※1 You cannot continue a recording from the first layer to the second layer on dual- or double-layer discs. To record onto the second layer, you must first close the first layer using the “Close First Layer” item in DVD Management (→ page 37). You will no longer be able to record to the first layer after you do this (→ page 16).

When playing a title recorded on both layers, video and audio may momentarily cut out when the unit is switching layers.

※2 You may not be able to use +R recorded on this unit in another Panasonic DVD recorder and vice versa. Once the disc is finalized, however, it can be played in the other unit.

※3 The amount of the recordable disc space doesn't increase even if the programme is deleted when you use a one time recording disc.

※4 CPRM (→ page 49) compatible discs only.

※5 This unit can use the high-speed recording discs shown in the chart, but using them will not shorten the recording time.

※6 You can play 8x recording speed discs recorded on another equipment.

※7 Play on DVD-R DL compatible equipment.

※8 Play on +R DL compatible equipment.

Regarding recording format

VR (DVD Video Recording) format

This is a recording method which allows you to freely record and edit television broadcasts and so on.



- Digital broadcasts that allow “One time only recording” can be recorded to a CPRM compatible disc. You can record to CPRM compatible DVD-RAM on this unit.
- Play is only possible on a compatible DVD player.





DVD-Video format

This recording method is the same as commercially available DVD-Video.

- Digital broadcasts that allow “One time only recording” cannot be recorded.
- You can play on compatible equipment such as DVD players after finalizing the disc on this unit.

Play-only discs

Disc type	DVD-Video	DVD-Audio	DVD-RW (VR format)
Indication in these instructions	DVD-V	DVD-A	-RW(VR)
Logo			
Instructions	High quality movie and music discs	High fidelity music discs • Played on this unit in 2 channels.	DVD-RW recorded on another DVD Recorder※1 • You can play programmes that allow “One time only recording” if they have been recorded to a CPRM compatible disc. • By formatting (→ page 36) the disc, you can record to it in DVD-Video format. • It may be necessary to finalize the disc on the equipment used for recording.

Disc type	Audio CD	Video CD	SVCD※2	DVD-R	CD
Indication in these instructions	CD	VCD		MP3	JPEG
Logo					—
Instructions	Music and audio recorded (including CD-R/RW※1)	Music and video recorded (including CD-R/RW※1)		CD-R/RW and DVD-R※1 with MP3/Still pictures (JPEG and TIFF)	

• The producer of the disc can control how discs are played. So you may not always be able to control play as described in these operating instructions. Read the disc's instructions carefully.

※1 Close the session after recording. Play may be impossible on some discs due to the condition of the recording.

※2 Conforming to IEC62107.

Regarding DVD-Audio
Some multi-channel DVD-Audio will prevent down-mixing (→ page 49) of all or part of their contents if this is the manufacturer's intention. Tracks that are prevented from being down-mixed will not play properly on this unit (e.g. audio is played from the front two channels only). Refer to the disc's jacket for more information.

Discs that cannot be played

- 2.6 and 5.2 GB DVD-RAM, 12 cm
- 3.95 and 4.7 GB DVD-R for Authoring
- DVD-R recorded by VR format
- DVD-R (DVD-Video format), DVD-R DL, DVD-RW (DVD-Video format), +R, +R DL recorded on another unit and not finalized (→ page 49).
- DVD-Video with a region number other than “2” or “ALL”
- Blu-ray
- DVD-ROM, +R (8 cm), CD-ROM, CDV, CD-G, Photo CD, CVD, SACD, MV-Disc, PD, DivX Video Disc, “Chaoji VCD” available on the market including CVD, DVCD and SVCD that do not conform to IEC62107, etc.

Types of disc for the type of connected TV

When you use the discs recorded either PAL or NTSC, refer to this table.

(✓: Possible to view, x: Impossible to view)

TV type	Disc	Yes/No
Multi-system TV	PAL	✓
	NTSC	✓※3
NTSC TV	PAL	x
	NTSC	✓※4
PAL TV	PAL	✓
	NTSC	✓※5 (PAL60)

※3 If you select “NTSC” in “TV System” (→ page 43), the picture may be clearer.

※4 Select “NTSC” in “TV System” (→ page 43).

※5 If your television is not equipped to handle PAL 525/60 signals the picture will not be shown correctly.

The remote control information

■ Batteries

- Insert so the poles (+ and -) match those in the remote control.
 - Do not use rechargeable type batteries.
 - Do not mix old and new batteries.
 - Do not use different types at the same time.
 - Do not heat or expose to flame.
 - Do not take apart or short circuit.
 - Do not attempt to recharge alkaline or manganese batteries.
 - Do not use batteries if the covering has been peeled off.
- Mishandling of batteries can cause electrolyte leakage which can damage items the fluid contacts and may cause a fire. Remove if the remote control is not going to be used for a long period of time. Store in a cool, dark place.

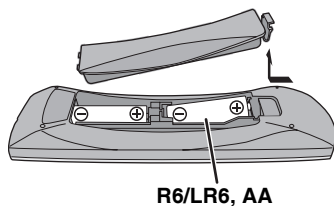

■ Use

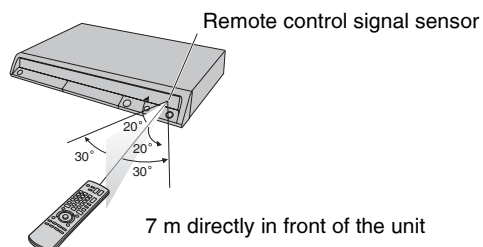

Use of the supplied RF coaxial leads

To prevent interference patterns from appearing on your TV, use only the supplied RF coaxial leads when you connect this unit to your TV and aerial outlet or aerial lead, as shown in connection types A-C.

- Keep the RF coaxial leads as far away as possible from other leads.
- Do not roll up the RF coaxial leads.

- Before connection, turn off the mains for all connected equipment and read the appropriate operating instructions. Be sure to read the Caution for AC Mains Lead on page 2.
- Choose from one of the connection types A-C that suits your requirement.

A Connecting to a television only

Using a fully wired 21-pin Scart lead

- You can use a variety of Q Link functions by connecting the unit to a Q Link compatible television (→ page 38).
- You can enjoy high-quality viewing by connecting the unit to an RGB compatible television.

Required setting

“AV1 Output” in the Setup menu (→ page 40)

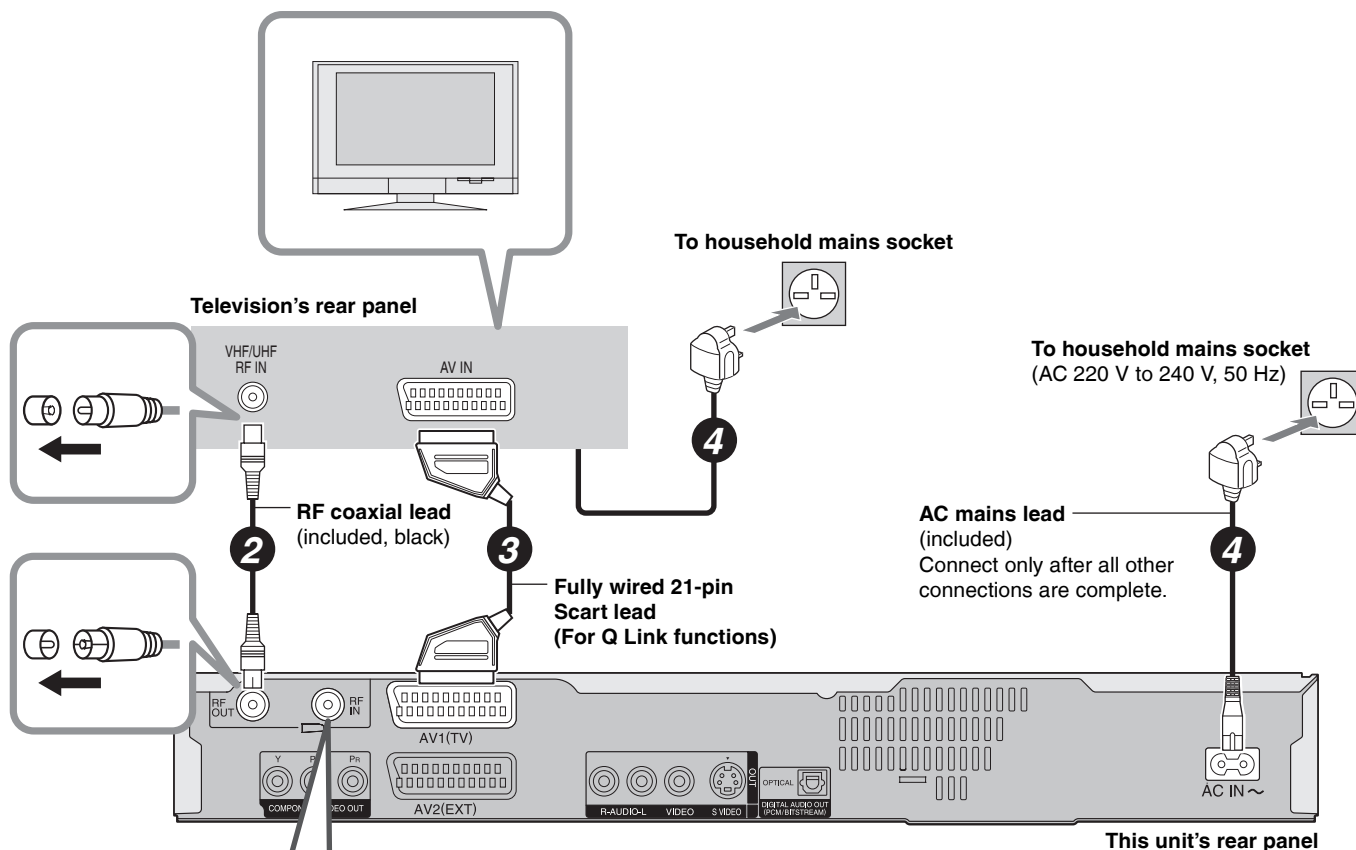

Use one of the RF coaxial lead (black or grey) to connect this unit's RF IN terminal to your aerial socket or aerial lead.

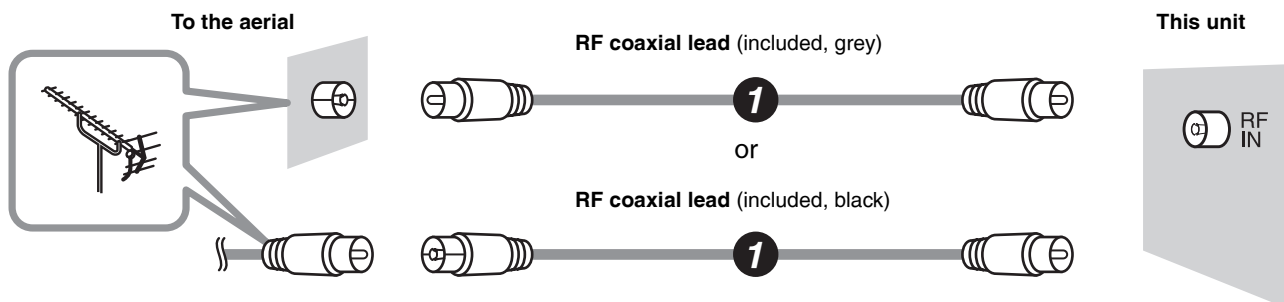

Connecting a terminal other than the 21-pin Scart terminal (→ page 11).
After completing the above connections, proceed to the TV Tuning (→ page 12).

B

Connecting to a television and Satellite/Digital terrestrial receiver

Using a fully wired 21-pin Scart lead

- You can use a variety of Q Link functions by connecting the unit to a Q Link compatible television (→ page 38).
- You can enjoy high-quality viewing by connecting the unit to an RGB compatible television.

Required setting

“AV1 Output” and “AV2 Input” in the Setup menu (→ page 40–41)

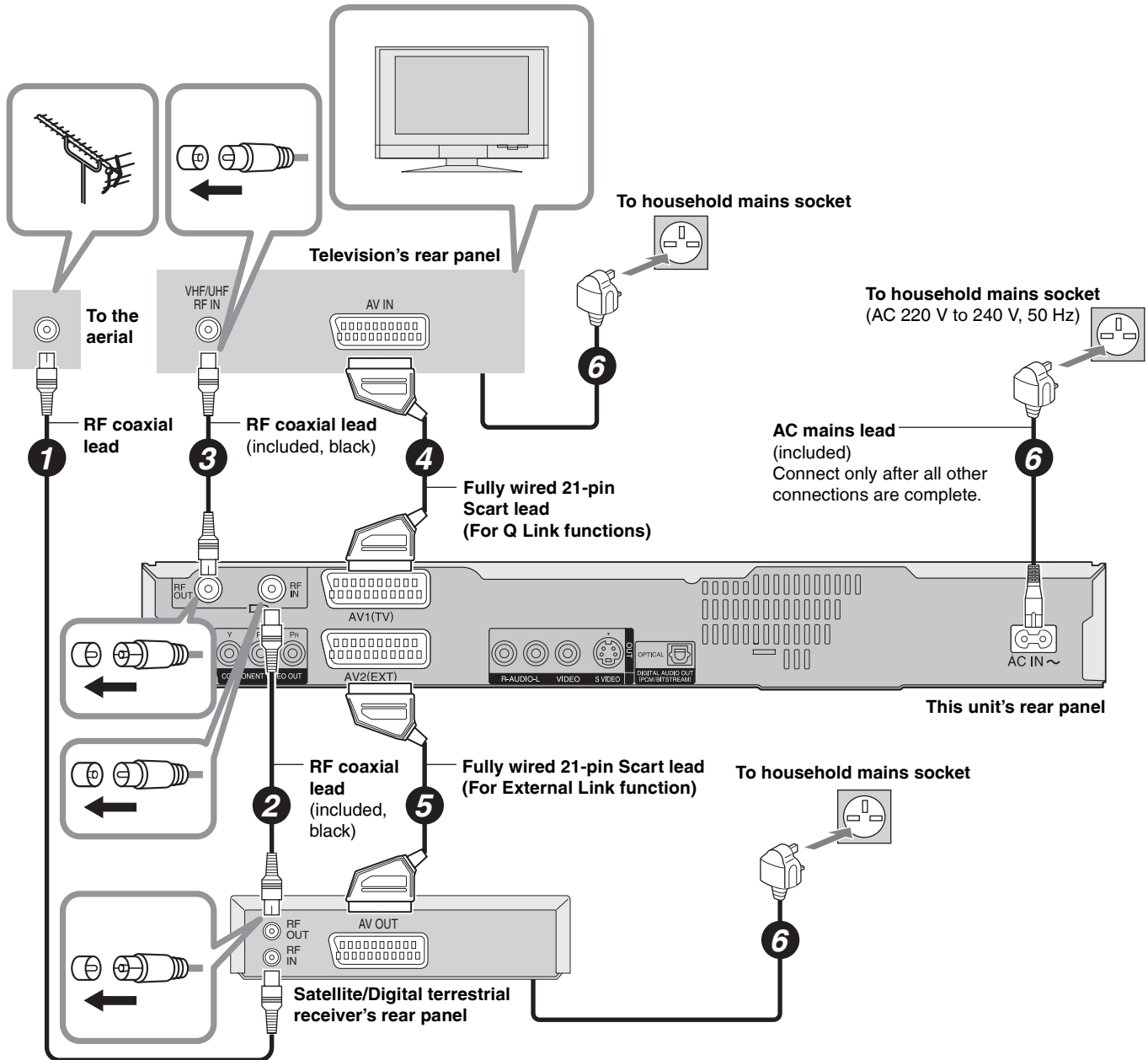

To view satellite/digital terrestrial programmes
 Press [INPUT SELECT] to select the input channel “AV2” or put this unit in standby mode.

To record satellite/digital terrestrial programmes
 Refer to “Recording from a satellite/digital terrestrial receiver” (→ page 23).

Connecting a terminal other than the 21-pin Scart terminal (→ page 11).
 After completing the above connections, proceed to the TV Tuning (→ page 12).

C

Connecting to a television and VCR

Using a fully wired 21-pin Scart lead

- You can use a variety of Q Link functions by connecting the unit to a Q Link compatible television (→ page 38).
- You can enjoy high-quality viewing by connecting the unit to an RGB compatible television.

Required setting

“AV1 Output” and “AV2 Input” in the Setup menu (→ page 40–41)

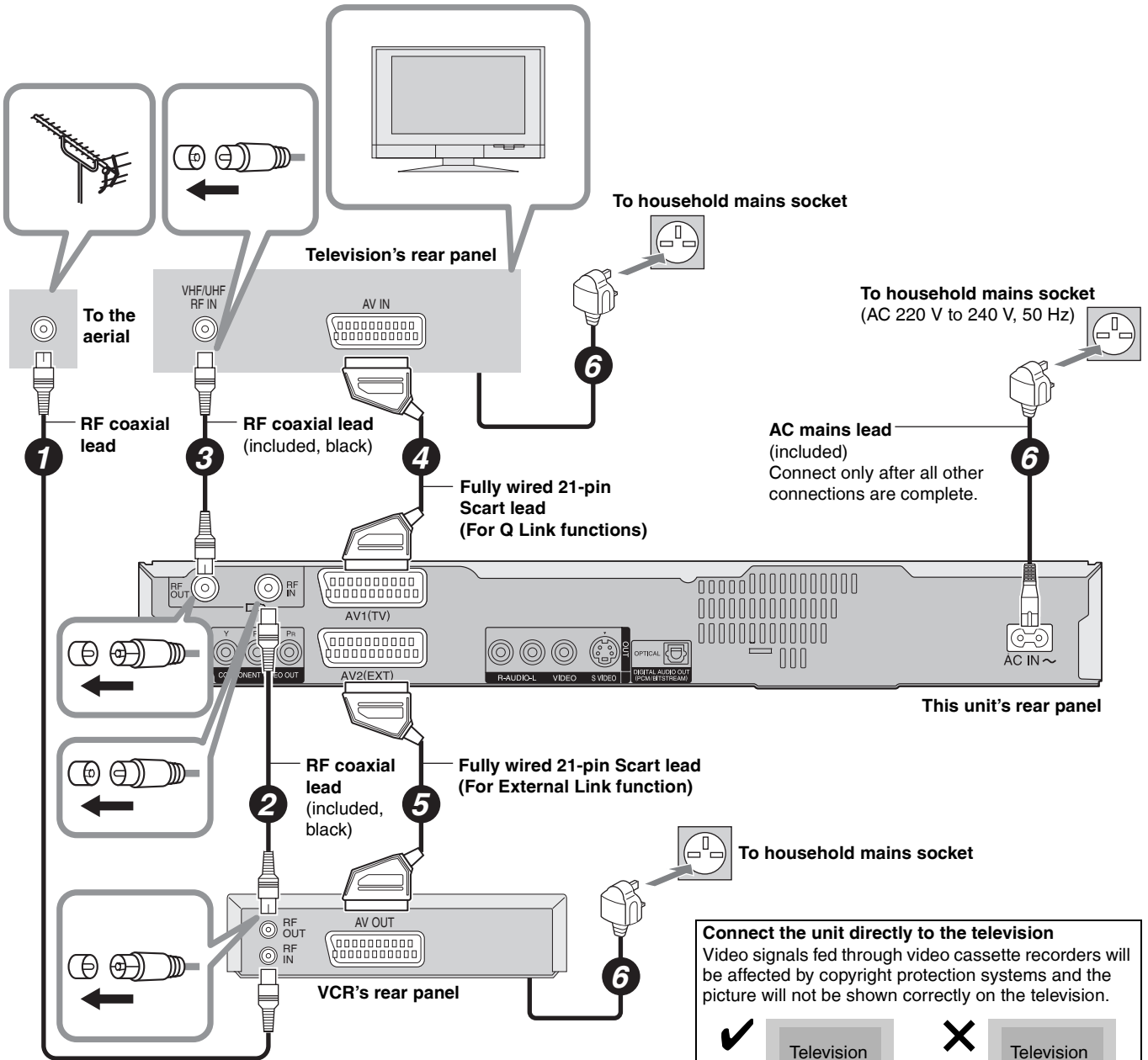

To copy from a VCR

Refer to “Copying from a video cassette recorder” (→ page 34).

Connecting a terminal other than the 21-pin Scart terminal (→ page 11).
 After completing the above connections, proceed to the TV Tuning (→ page 12).

Other connections

Connecting to a television with AUDIO/VIDEO terminals

Television's rear panel

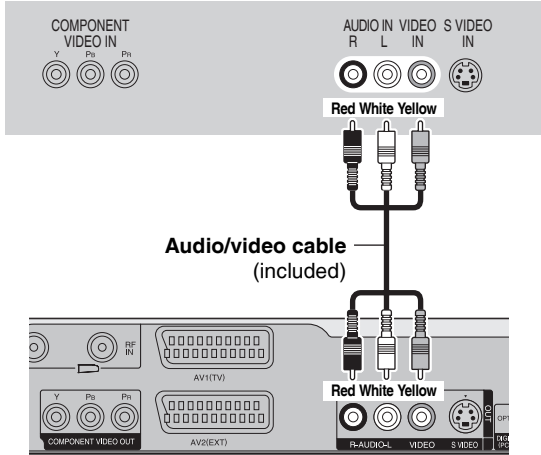

Audio/video cable (included)

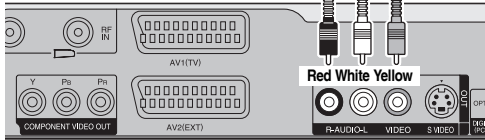

This unit's rear panel

Connecting to a television with S VIDEO terminals

The S VIDEO OUT terminal achieves a more vivid picture than the VIDEO OUT terminal. (Actual results depend on the television.)

Television's rear panel

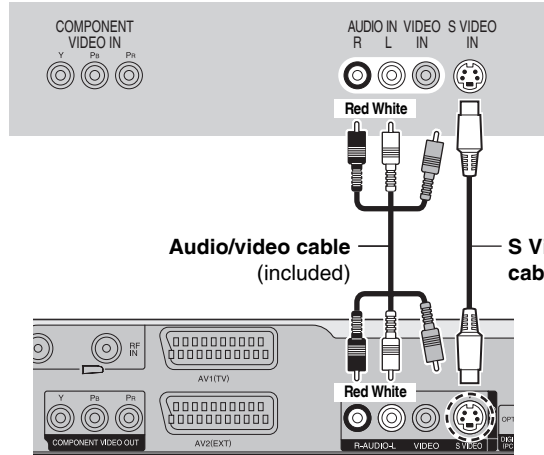

Audio/video cable (included)

S Video cable

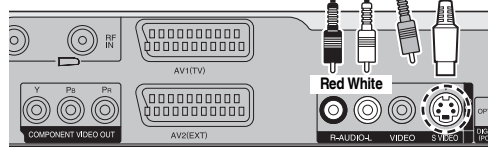

This unit's rear panel

Connecting to a television with COMPONENT VIDEO terminals

Television's rear panel

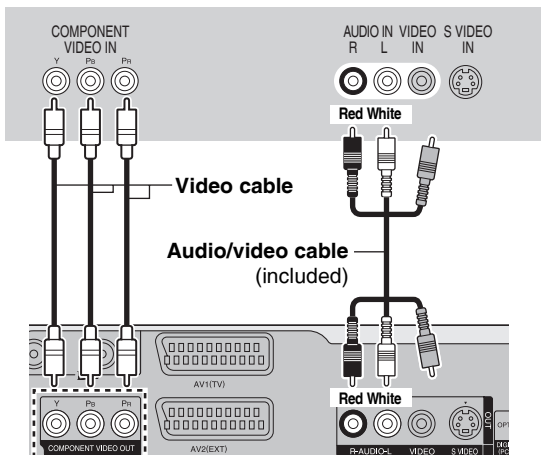

Video cable

Audio/video cable (included)

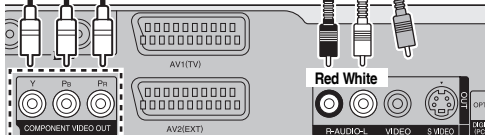

This unit's rear panel

COMPONENT VIDEO terminals can be used for either interlace or progressive output (→ page 49) and provide a purer picture than the S VIDEO OUT terminal.

- Connect to terminals of the same colour.
- **If you have a regular television (CRT : cathode ray tube)** Use component output with progressive "Off" (Factory setting, → page 40), even if it is progressive compatible, because progressive output can cause some flickering. This is the same for multi system televisions using PAL mode.

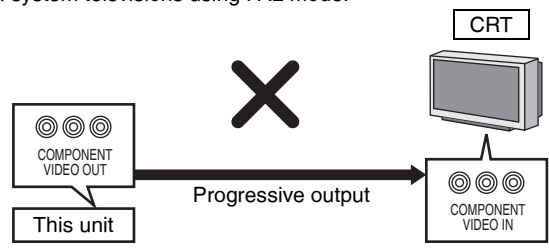

Connecting to an amplifier or system component

■ Connecting to an amplifier with a digital input terminal

- To enjoy multi-channel surround sound DVD-Video, connect an amplifier with Dolby Digital, DTS and MPEG decoders.
- **Required setting**
"Digital Audio Output" in the Setup menu (→ page 40)
- Before purchasing an optical digital audio cable, check the terminal shape of the connected equipment.
- You cannot use DTS Digital Surround decoders not suited to DVD.
- Even if using this connection, output will be only 2 channels when playing DVD-Audio.

Amplifier's rear panel

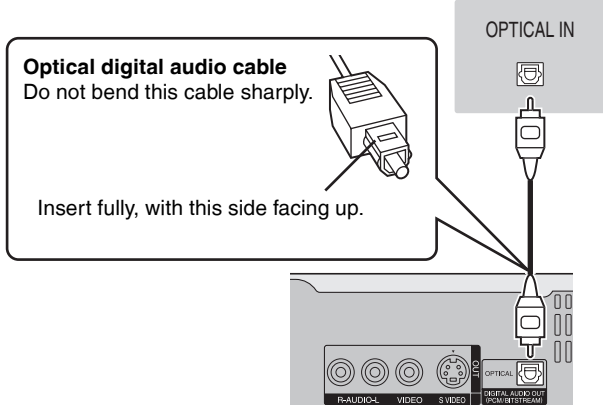

This unit's rear panel

■ Connecting to a stereo amplifier

Amplifier's rear panel

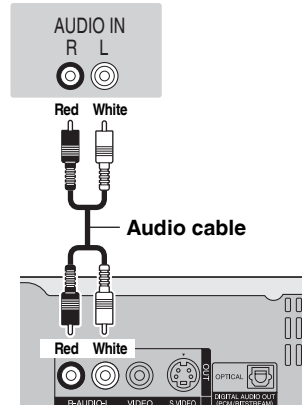

This unit's rear panel

TV Tuning (Auto Setup)

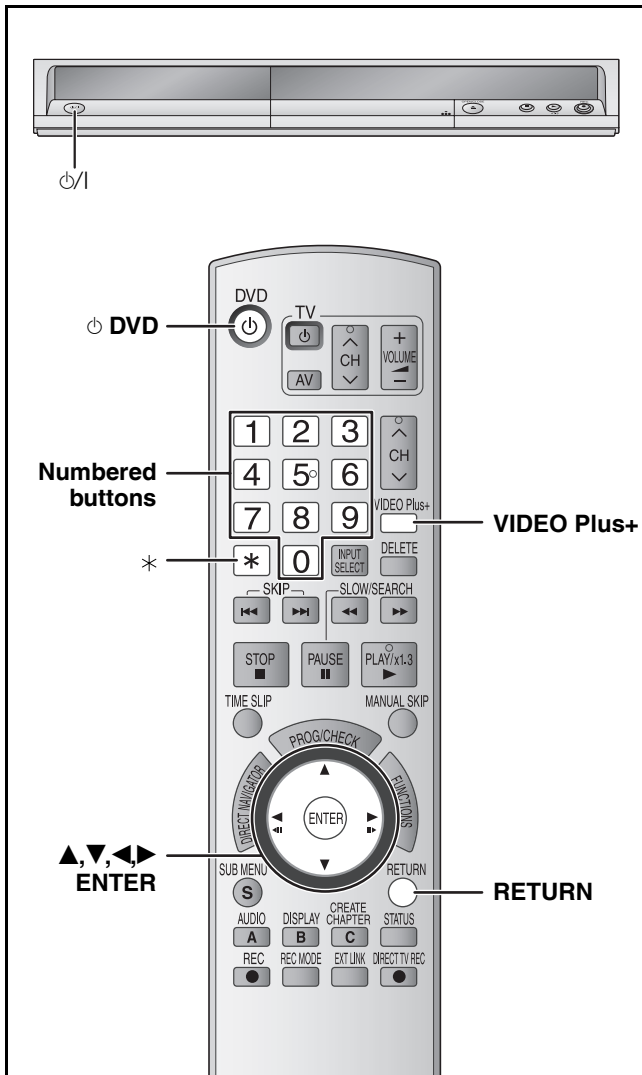

- 1** Turn on the mains for the television (and connected equipment) and select the AV input for this unit.
- 2** Press [DVD] to turn the unit on.
 - If the TV is Q Link compatible, it will start to download TV tuning information to this unit.



- If the TV is not Q Link compatible, Auto Setup will start to tune in all available TV stations. This may take about 5 minutes.



- 3** When setup has completed, the confirmation screen appears. Press [ENTER].
- 4** The Owner ID settings screen appears. Press [▶] and press the numbered buttons to enter your choice of a 4-digit PIN number.

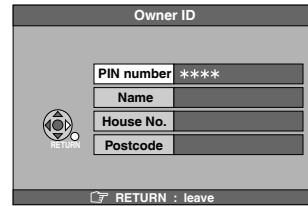

Make a note of the PIN number (don't forget), as it is not possible to return to the factory preset.

- 5** Press [ENTER] to store the PIN number.
- 6** Press [◀▶] to select "Yes" and press [ENTER].
The cursor moves to "Name".
- 7** Press [▶].
- 8** Press [▲▼] to select a letter and then press [▶] to move to next character. Repeat this to enter the name.
- 9** Press [ENTER] to store the name.
- 10** Press [▼] and [▶], and then repeat steps 8, 9 to enter and store "House No." and "Postcode".
- 11** Press [RETURN].
The Owner ID settings screen disappears.

To abort Auto Setup
Press [RETURN].

- **If the clock setting menu appears**
Set the clock manually (→ page 41).
- **To confirm that stations have been tuned correctly** (→ page 42)
- **Resetting channel setting** (→ page 42)
- **To enter the satellite station's name** (→ page 42)
The name of the satellite station may not be set automatically.
("—") will appear under "Name" in the programme list.)
In this case, enter the name manually.

Note

If this unit is connected to a digital TV (Freeview), only the analogue station's tuning information will be downloaded.

Timer recording from satellite receiver with VIDEO Plus+

This unit is not designed to control (turn on or change channels on) your satellite receiver. However, you can use VIDEO Plus+ Recording by making the satellite receiver's VIDEO Plus+ numbers available for recognition on this unit. Take the following steps to make all satellite stations available for recognition on this unit.

Through these steps, you can make timer recording from satellite stations with VIDEO Plus+ constantly available as the unit keeps the setting in memory.

Preparation

- Turn on the Satellite receiver(s).
- Select a correct station on the Satellite receiver(s).

1 Press [VIDEO Plus+].

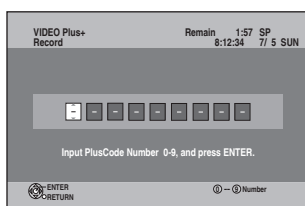

2 Press the numbered buttons to enter the VIDEO Plus+ number for a satellite station (e.g. Sky One).

- To correct the number

Press [◀] to correct any mistakes.

3 Press [ENTER].

“—” will appear in the “Name” column.

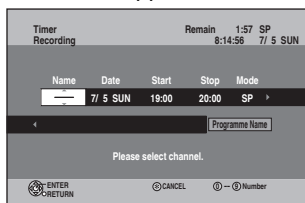

4 Press [▲, ▼] to select the channel or AV input that is to be used for recording from the satellite station.

5 Press [ENTER].

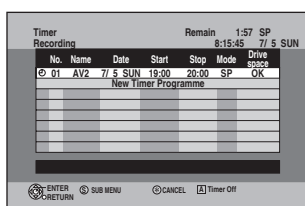

6 Press [▲] to select the programme that you have just set and press [*] to delete it from the timer recording list.

It is no longer needed.

Repeat the steps above until you have set dummy timer recordings for each of the satellite stations that you will make VIDEO Plus+ recordings from.

To exit the screen

Press [RETURN].

Set up to match your television and remote control

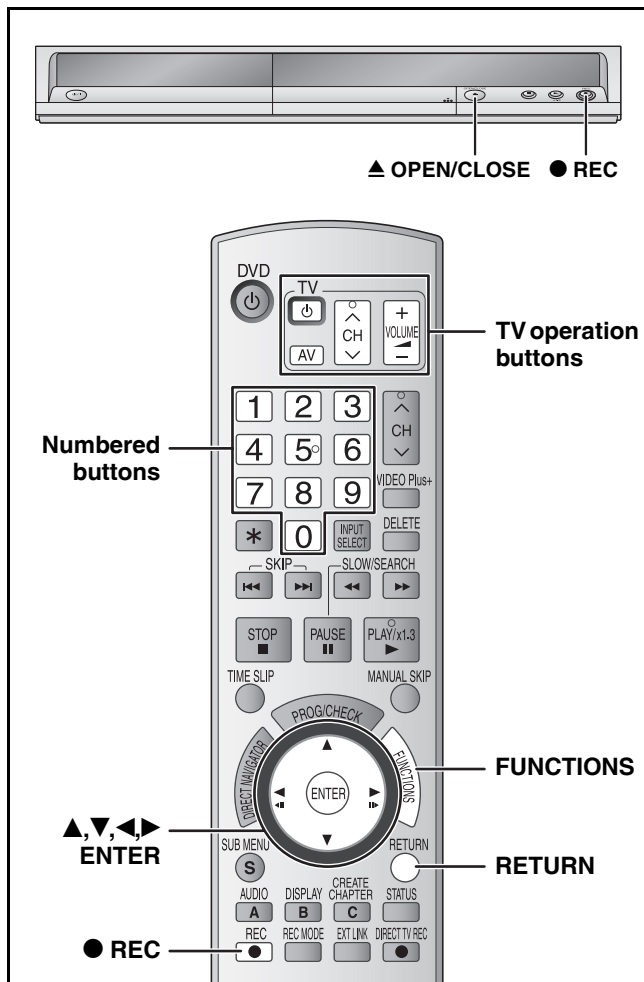

Selecting television type and aspect

Choose the setting to suit your television and preference.

- 1 While stopped
Press [FUNCTIONS].
- 2 Press [▲,▼] to select “To Others” and press [ENTER].

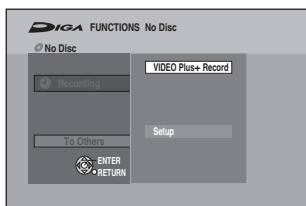

- 3 Press [▲,▼] to select “Setup” and press [ENTER].

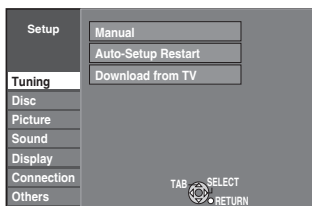

- 4 Press [▲,▼] to select “Connection” and press [▶].

- 5 Press [▲,▼] to select “TV Aspect” and press [ENTER].
- 6 Press [▲,▼] to select the TV aspect and press [ENTER].

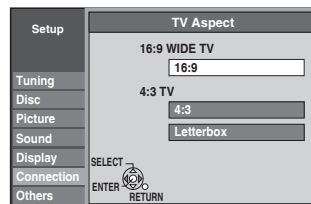

- **16:9**: 16:9 widescreen television
- **4:3**: 4:3 standard aspect television
- **RAM** Even if it records and plays, the aspect does not change.
- **DVD-V** Video recorded for a widescreen is played as Pan & Scan (unless prohibited by the producer of the disc) (→ page 49).
- **Letterbox**: 4:3 standard aspect television
Widescreen picture is shown in the letterbox style (→ page 49).

To enjoy progressive video

You can enjoy progressive video by connecting this unit’s COMPONENT VIDEO OUT terminals to an LCD/plasma television or LCD projector compatible with progressive scan (→ page 49).

- 1 While stopped
Press [FUNCTIONS].
- 2 Press [▲,▼] to select “To Others” and press [ENTER].
- 3 Press [▲,▼] to select “Setup” and press [ENTER].
- 4 Press [▲,▼] to select “Connection” and press [▶].
- 5 Press [▲,▼] to select “AV1 Output” and press [ENTER].
- 6 Press [▲,▼] to select “Video (with component)” or “S Video (with component)” and press [ENTER].
Set according to the signal and terminal of the connected TV.
- 7 Press [▲,▼] to select “Progressive” and press [ENTER].
- 8 Press [▲,▼] to select “On” and press [ENTER].
Output becomes progressive.

Note

- When connected to a CRT (Cathode ray tube) television or a multi system television using PAL mode, even if it is progressive compatible, progressive output can cause some flickering. Turn off “Progressive” if this occurs.
- Picture will not be displayed correctly if connected to an incompatible television.
- There is no output from the COMPONENT VIDEO OUT terminals if “AV1 Output” in the Setup menu is set to “RGB 1 (without component)” or “RGB 2 (without component)” (→ page 40).

To exit the screen

Press [RETURN] several times.

To return to the previous screen

Press [RETURN].

Television operation

You can operate the TV through the unit's remote control.

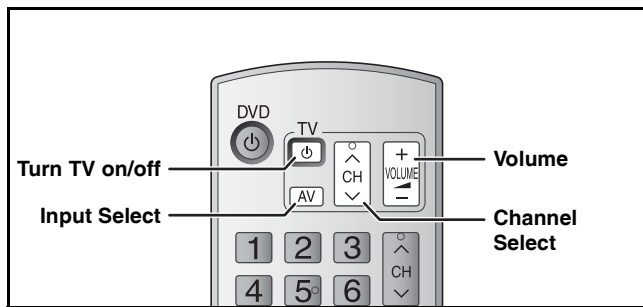

Point the remote control at the television
While pressing [**TV**], enter the code with the numbered buttons.

e.g., 01: [0] → [1]

Manufacturer and Code No.

Brand	Code	Brand	Code
Panasonic	01/02/03/ 04/45	NOKIA	25/26/27
AIWA	35	NORDMENDE	10
AKAI	27/30	ORION	37
BLAUPUNKT	09	PHILIPS	05/06
BRANDT	10/15	PHONOLA	31/33
BUSH	05/06	PIONEER	38
CURTIS	31	PYE	05/06
DESMET	05/31/33	RADIOLA	05/06
DUAL	05/06	SABA	10
ELEMIS	31	SALORA	26
FERGUSON	10	SAMSUNG	31/32/43
GOLDSTAR/LG	31	SANSUI	05/31/33
GOODMANS	05/06/31	SANYO	21
GRUNDIG	09	SBR	06
HITACHI	22/23/31/ 40/41/42	SCHNEIDER	05/06/29/ 30/31
INNO HIT	34	SELECO	06/25
IRRADIO	30	SHARP	18
ITT	25	SIEMENS	09
JVC	17/39	SINUDYNE	05/06/33
LOEWE	07/46	SONY	08
METZ	28/31	TELEFUNKEN	10/11/12/ 13/14
MITSUBISHI	06/19/20	THOMSON	10/15/44
MIVAR	24	TOSHIBA	16
NEC	36	WHITE WESTINGHOUSE	05/06

Test by turning on the television and changing channels. Repeat the procedure until you find the code that allows correct operation.

- If your television brand is not listed or if the code listed for your television does not allow control of your television, this remote control is not compatible with your television.

When other Panasonic products respond to this remote control

When other Panasonic products placed nearby affect this unit's remote control, change the remote control code on the main unit and the remote control (the two must match). Under normal circumstances use the factory set code "DVD 1".

To change the code on the main unit

- 1 While stopped
Press [**FUNCTIONS**].
- 2 Press [**▲, ▼**] to select "To Others" and press [**ENTER**].
- 3 Press [**▲, ▼**] to select "Setup" and press [**ENTER**].
- 4 Press [**▲, ▼**] to select "Others" and press [**▶**].
- 5 Press [**▲, ▼**] to select "Remote Control" and press [**ENTER**].
- 6 Press [**▲, ▼**] to select the code ("DVD 1", "DVD 2" or "DVD 3") and press [**ENTER**].

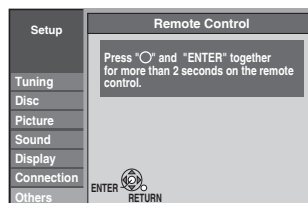

To change the code on the remote control

- 7 While pressing [**ENTER**], press and hold the numbered button ([1], [2] or [3]) for more than 2 seconds.
- 8 Press [**ENTER**].

- When the following indicator appears on the unit's display



Press and hold [**ENTER**] and the indicated number button at the same time for more than 2 seconds.

Note

Executing "Shipping Condition" in the Setup menu returns the main unit code to "DVD 1". Change the remote control code to 1 (→ step 7).

To exit the screen

Press [**RETURN**] several times.

To return to the previous screen

Press [**RETURN**].

Important notes for recording

Recording of bilingual programme

RAM

Both main and secondary audio can be recorded

You can change the audio during playback.
(→ page 24, "Changing audio during play")

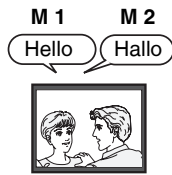

If you record from external equipment
–Select both "M 1" and "M 2" on the external equipment.

-R -R DL -RW(V) +R +R DL +RW

Select the main or secondary audio before recording

(→ page 40, "Bilingual Audio Selection")
The selected audio only is recorded.



If you record from external equipment
–Select "M 1" or "M 2" on the external equipment.

Recording of Widescreen broadcasting

RAM

16:9 aspect (Widescreen)



-R -R DL -RW(V) +R +R DL +RW

Recorded in 4:3 aspect



Recording of digital broadcasting

It is not possible to record digital broadcasts that allow "One time only recording" onto DVD-R, DVD-R DL, DVD-RW, +R, +R DL, +RW or 8 cm DVD-RAM discs. Use a CPRM (→ page 49) compatible DVD-RAM.

RAM (CPRM compatible disc only)



-R -R DL -RW(V) +R +R DL +RW



✓: Can do, x: Cannot do

Playing the disc on other DVD players

-R -R DL -RW(V) +R +R DL

The disc must be finalized after recording (→ page 37).

It is necessary to finalize DVD-R, etc. on this unit after recording or copying titles to them. You can then play them as a commercially sold DVD-Video. However, the discs become play-only and you can no longer record or copy.*

* You can record or copy again if you format DVD-RW.



Recorded to DVD-R, etc.



Finalize

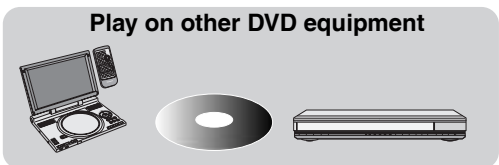

Play on other DVD equipment

Recording to DVD-R DL and +R DL

-R DL +R DL

DVD-R DL and +R DL discs have two layers of recording surface on one side.

It is not possible to record continuously from the first layer to the second layer. Recording stops when space on the first layer becomes full. You must close the first layer to start recording on the second layer (→ page 37, "Close First Layer"). Closing makes the first layer unavailable for recording (editing is still available). You cannot cancel closing. Make certain before proceeding.

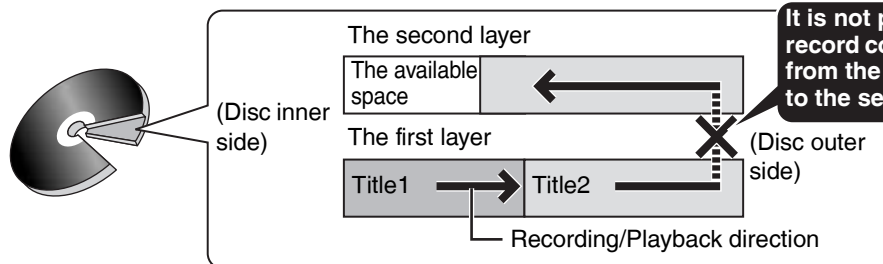

Recording modes and approximate recording times

Depending on the content being recorded, the recording times may become shorter than indicated.

Recording Mode	DVD-RAM		DVD-R, DVD-RW, +R, +RW 4.7 GB
	4.7 GB	9.4 GB (Double-sided ^{*1})	
XP (High quality)	1 h.	2 h.	1 h.
SP (Standard)	2 h.	4 h.	2 h.
LP (Long play)	4 h.	8 h.	4 h.
EP (Extra long play)	8 h. (6 h. ^{*2})	16 h. (12 h. ^{*2})	8 h. (6 h. ^{*2})
FR (Flexible Recording)	8 h. maximum	8 h. maximum for one side	8 h. maximum

Recording Mode	DVD-R DL, +R DL ^{*3} 8.5 GB	
	First layer (L0)	Second layer (L1)
XP (High quality)	55 min.	50 min.
SP (Standard)	1 h. 50 min.	1 h. 40 min.
LP (Long play)	3 h. 40 min.	3 h. 20 min.
EP (Extra long play)	7 h. 25 min. (5 h. 30 min. ^{*2})	6 h. 50 min. (5 h. 15 min. ^{*2})
FR (Flexible Recording)	7 h. 25 min. maximum	6 h. 50 min. maximum

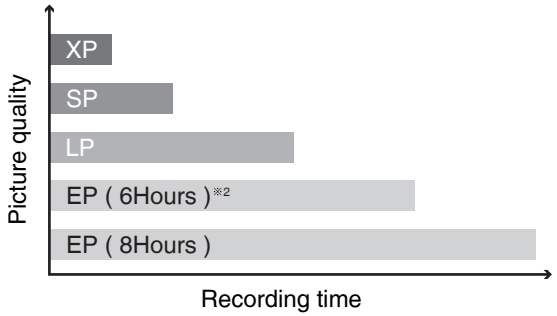

^{*1} It is not possible to record or play continuously from one side of a double sided disc to the other.
^{*2} When "Recording time in EP mode" is set to "EP (6Hours)" in the Setup menu (→ page 39). The sound quality is better when using "EP (6Hours)" than when using "EP (8Hours)".
^{*3} It is not possible to record continuously from the first layer to the second layer.

Note

- This unit uses variable bit rate (VBR) recording which varies the amount of data recorded to suit the images, so actual recording times and remaining recording times shown by the unit will be different. (The difference will be especially noticeable with DVD-R DL and +R DL.) Use a disc with plenty of remaining time to be sure.
- When recording to DVD-RAM using EP (8Hours) mode, play may not be possible on DVD players that are compatible with DVD-RAM. In this case use EP (6Hours) mode.

FR (Flexible Recording)

The unit automatically selects a recording rate between XP and EP (8Hours) that will enable the recordings to fit in the remaining disc space with the best possible recording quality.

- You can use FR mode in timer recordings (→ page 20, 21, step 3) and Flexible Recording (→ page 19).

Using FR mode is convenient in these kind of situations

- When the amount of free space on the disc makes selecting an appropriate recording mode difficult
 - When you want to record a long programme with the best picture quality possible
- e.g., Recording a 90 minutes programme to disc

If you select XP mode

The programme will not fit one disc.

60 minutes

Full

+

30 minutes

Another disc is necessary.

If you select SP mode

The programme will fit one disc.

There will be 30 minutes remaining disc space.

If you select FR mode

The programme will fit one disc perfectly.

Fit

Disc Insertion/Ejection

Refer to the control reference on page 14.

When the format confirmation screen is displayed

RAM -RW(V) +R +R DL +RW

When you insert a new disc and a disc recorded on a computer or other equipment, a format confirmation screen might be displayed. Format the disc to use it. However all the recorded contents are deleted.

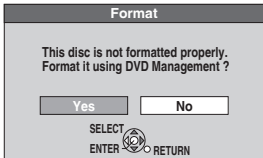

Press [◀▶] to select "Yes" and press [ENTER].

- Several steps are necessary to format a disc. Refer to "Deleting all the contents of a disc -Format Disc" (→ page 36).

When remove a recorded disc

-R -R DL -RW(V) +R +R DL

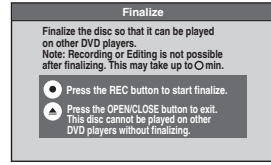

When you press [▲ OPEN/CLOSE] on the main unit while stopped: The screen shown at left appears when you have not processed the disc for play on other equipment.

When finalizing the disc

- Press [● REC].
- You cannot stop this process once you have started it.
 - If you want to provide the disc with a name or set play menu select, select "Disc Name" (→ page 36) or "Auto-Play Select" (→ page 37) in "DVD Management" before finalizing.

When opening the tray without disc finalization

Press [▲ OPEN/CLOSE] on the main unit.

Recording television programmes

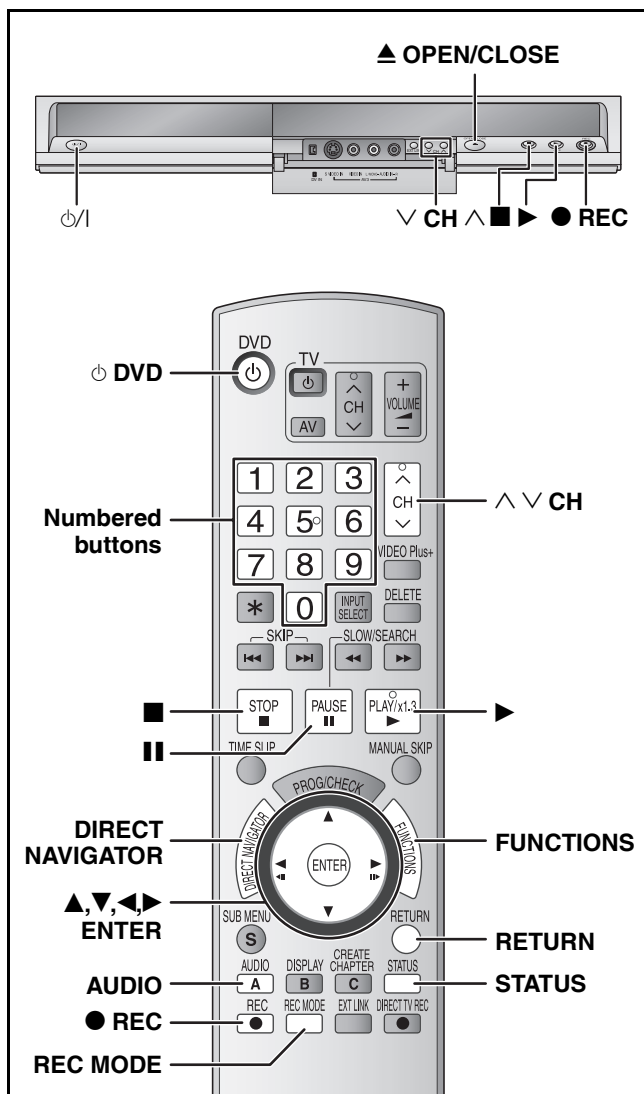

RAM -R -R DL -RW(V)

- You can record up to 99 titles on one disc.

+R +R DL +RW

- You can record up to 49 titles on one disc.

See also the notes "Important notes for recording" (→ page 16).

Note

- +RW** You can create a Top Menu using "Create Top Menu" (→ page 37). Recording or editing on the disc may delete the menu. In that case, create the menu again.
- RAM** It is not possible to record continuously from one side of a double sided disc to the other. You will need to eject the disc and turn it over.

Preparation

- Turn on the television and select the appropriate video input to suit the connections to this unit.
- Turn the unit on.

1 Press [▲ OPEN/CLOSE] on the main unit to open the tray and insert a disc.

- Press the button again to close the tray.
- When using 8 cm DVD-RAM, or 8 cm DVD-R, remove the disc from the cartridge.

Insert label-up.

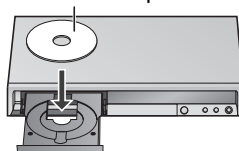

Cartridge disc

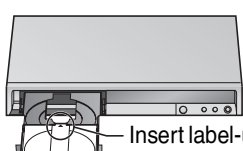

Insert label-up with the arrow facing in.
↑ Insert fully.

2 Press [^ v CH] to select the channel.



To select with the numbered buttons:

e.g., 5: [0] → [5]

15: [1] → [5]

3 Press [REC MODE] to select the recording mode (XP, SP, LP or EP).



Remaining time on the disc

4 Press [● REC] to start recording.



The elapsed time is shown on the display.

Recording will take place on open space on disc. Data will not be overwritten.

- You cannot change the channel or recording mode during recording. You can change the channel or recording mode while paused; however, the recording will then be as a separate title.
- You can record while the unit is in standby for timer recording, but once the time for the timer recording to begin is reached, any recording taking place will stop and the timer recording will begin.
- RAM** You can change the audio being received by pressing [AUDIO] during recording. (This does not affect the actual recording of the audio.)

■ To pause recording

Press [||].

Press again to restart recording.

You can also press [● REC] to restart.

(Recorded title is not split into separate titles.)

■ To stop recording

Press [■].

- From the start to the end of the recording is called one title.

■ -R -R DL -RW(V) +R +R DL +RW

It takes about 30 seconds for the unit to complete recording management information after recording finishes.

■ If a station also broadcasts Teletext information

The unit automatically records the programme name and station name if the station's "Title Page" is correctly set (→ page 42).

- The unit may take some time to retrieve titles (up to 30 minutes) and may fail in some cases.

Quick Start

1 Sec. Quick Start for Recording on DVD-RAM

Recording on DVD-RAM starts about 1 second after first pressing [⏻] on the main unit or [⏻ DVD] to turn on the unit and then sequentially pressing [● REC].

Note

Startup takes more time when:

- you play a disc or start recording to discs other than DVD-RAM.
- the clock has not been set.

To specify a time to stop recording—One Touch Recording

During recording

Press [● REC] on the main unit to select the recording time.

- The unit's display changes as shown below.

OFF 0:30 → OFF 1:00 → OFF 1:30 → OFF 2:00
 ↑ Counter (cancel) ← OFF 4:00 ← OFF 3:00 ←

- This does not work during timer recordings (→ page 20) or while using Flexible Recording (→ below).
- If you change the channel or recording mode while recording is paused, the time specified to stop recording is cancelled.
- The unit turns off automatically after the time to stop recording is reached.

To cancel

Press [● REC] on the main unit several times until the counter appears.

- The time to stop recording is cancelled; however, recording continues.

To stop recording partway

Press [■].

Flexible Recording

(Recording that fits the remaining disc space)

RAM -R -R DL -RW(V) +R +R DL +RW

The unit sets the best possible picture quality that fits the recording within the remaining disc space. The recording mode becomes FR mode. Refer to "FR (Flexible Recording)" (→ page 17).

Preparation

- Select the channel or the external input to record.

- While stopped
Press [FUNCTIONS].
- Press [▲, ▼] to select "To Others" and press [ENTER].
- Press [▲, ▼] to select "Flexible Rec" and press [ENTER].

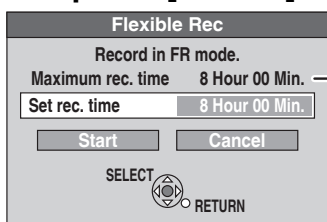

Maximum recording time
 This is the maximum recording time in EP (8Hours) mode.

- Press [◀▶] to select "Hour" and "Min." and press [▲, ▼] to set the recording time.

- You can also set the recording time with the numbered buttons.
- You cannot record for more than 8 hours.

- When you want to start recording

Press [▲, ▼, ▶◀] to select "Start" and press [ENTER].

Recording starts.

To exit the screen without recording

Press [RETURN].

e.g., DVD-RAM

To stop recording partway

Press [■].

To show the remaining time

Press [STATUS].

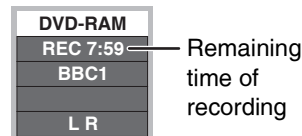

Note

When performing EXT LINK recording (→ page 23), the flexible recording function does not work.

Playing while you are recording

RAM

Playing from the beginning of the title you are recording—Chasing playback

Press [▶] (PLAY) during recording.

- There is no sound output while searching forward or backward.

To stop play

Press [■].

To stop recording

- Press [■] to stop playing.
- Press [■] (after 2 seconds).

To stop timer recording

- Press [■] to stop playing.
- Press [■] (after 2 seconds).
- Press [◀▶] to select "Stop Recording" and press [ENTER].

Playing a title previously recorded while recording—Simultaneous rec and play

- Press [DIRECT NAVIGATOR] during recording.
- Press [▲, ▼, ▶, ◀] to select a title and press [ENTER].

To stop play

Press [■].

To stop recording

- Press [■] to stop playing.
- Press [DIRECT NAVIGATOR] to exit screen.
- Press [■].

To stop timer recording

- Press [■] to stop playing.
- Press [DIRECT NAVIGATOR] to exit screen.
- Press [■].
- Press [◀▶] to select "Stop Recording" and press [ENTER].

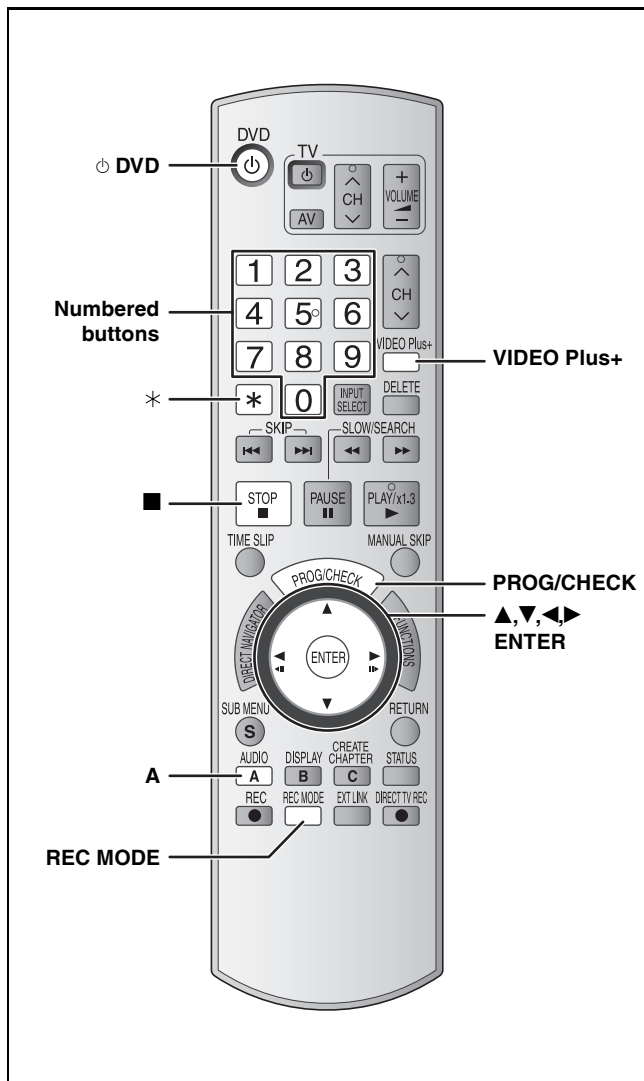

RAM -R -R DL -RW(V) +R +R DL +RW

See also the notes "Important notes for recording" (→ page 16).

Preparation

- Turn on the television and select the appropriate video input to suit the connections to this unit.
- Check the time on the unit is correct.
- Insert a disc (→ page 18).

Using VIDEO Plus+ system to make timer recordings

Entering VIDEO Plus+ number is an easy way of timer recording. You can find these numbers in TV listings in newspapers and magazines.

- You can enter up to 16 programmes up to a month in advance.
- **Using VIDEO Plus+ numbers for Satellite stations**
Set this unit to recognise VIDEO Plus+ numbers for Satellite stations before you start the following operations (→ page 13, Timer recording from satellite receiver with VIDEO Plus+).

1 Press [VIDEO Plus+].

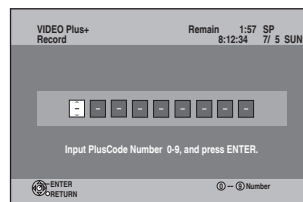

2 Press the numbered buttons to enter the VIDEO Plus+ number.

- **To correct the number**
Press [◀] to move back to correct a digit.

3 Press [ENTER].

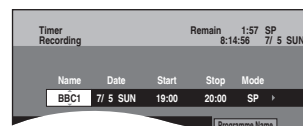

- Confirm the programme and make corrections if necessary using [▲, ▼, ◀, ▶] (→ page 21, Manually programming timer recordings, step 3).
- When "—" appears in the "Name" column, you cannot set timer recording. Press [▲, ▼] to select desired programme position. After you have entered the information of a TV station, it is kept in the unit's memory.
- You can also press [REC MODE] to change the recording mode.
- **To enter programme name**
Press [◀, ▶] to select "Programme Name" and press [ENTER] (→ page 43).

4 Press [ENTER].

The settings are stored and the programme goes to timer recording standby. The timer icon is displayed in left column.

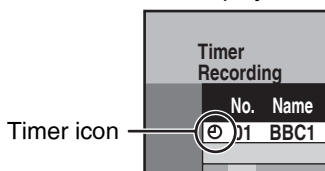

"⌚" lights on the unit's display to indicate timer recording standby has been activated.



When "!" appears, make sure the disc has a sufficient space.

Repeat steps 1–4 to programme other recordings.

■ Notes on timer recording (→ page 21)

To exit the timer recording list

Press [PROG/CHECK].

Manually programming timer recordings

You can enter up to 16 programmes up to a month in advance.

(Each daily or weekly programme is counted as one programme.)

1 Press [PROG/CHECK].

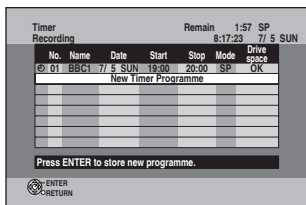

2 Press [▲,▼] to select “New Timer Programme” and press [ENTER].

3 Press [▶] to move through the items and change the items with [▲,▼].



- Press and hold [▲,▼] to alter Start (Start time) and Stop (Finish time) in 30-minute increments.
- You can also set Name (Programme position/TV Station Name), Date, Start (Start time), and Stop (Finish time) with the numbered buttons.
- You can also press [REC MODE] to change the recording mode.
- **Date**

→Date: Current date up to one month later minus one day
 ↓↑
 Daily timer: SUN-SAT → MON-SAT → MON-FRI
 ↓↑
 →Weekly timer: SUN → --- → SAT

- **To enter programme name**
 Press [◀▶] to select “Programme Name” and press [ENTER] (→ page 43).

4 Press [ENTER].

The settings are stored and the programme goes to timer recording standby.

The timer icon is displayed in left column.

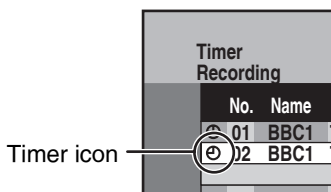

“⌚” lights on the unit’s display to indicate timer recording standby has been activated.

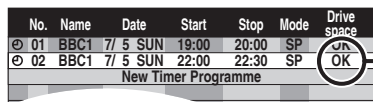

When “I” appears, make sure the disc has a sufficient space.

Repeat steps 2–4 to programme other recordings.

To cancel recording when recording has already begun

1 When this unit is on

Press [■].

The confirmation screen appears.

2 Press [◀▶] to select “Stop Recording” and press [ENTER].

Recording stops and the timer recording is cancelled. (Daily and weekly timers remain and timer recording will start as programmed.)

To release the programme from recording standby

1 Press [PROG/CHECK].

2 Press [▲,▼] to select the programme and press [A].

The timer icon (→ left) disappears.

- **To put the programme on recording standby again**

Perform step 2 again before the programme start time to put the programme on recording standby. Timer recording will work only if the timer icon is displayed.

Notes on timer recording

- “⌚” flashes on the unit’s display for about 5 seconds when the unit cannot go to timer recording standby (e.g., a recordable disc is not in the disc tray).
- Timer recordings begin when the set time is reached even when recording or when playing.
- If the unit is turned on when timer recording begins, it remains turned on after recording finishes. It does not turn off automatically. You can turn the unit off during timer recording.
- If the unit is not put in the timer recording standby mode at the last 10 minutes before the programmed timer recording starting time, “⌚” flashes on the unit’s display. In this case, insert a recordable disc to put the unit in the timer recording standby mode.
- If you are making consecutive recordings that will start one after the other, the beginning of the later programme cannot be recorded.

e.g., Programme① 10:00–11:00
 Programme② 11:00–12:00

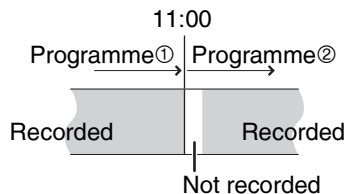

- If the actual broadcasting times of timer recordings overlap, the recording that starts first always has priority, and the recording of the later programme will start only after the first timer recording has finished.

To exit the timer recording list

Press [PROG/CHECK].

Refer to the control reference on page 20.

Check, change or delete a programme

Even when the unit is turned off, you can display the timer recording list by pressing [PROG/CHECK].

Press [PROG/CHECK].

Icons

- ⊖ Timer recording standby is activated.
- This programme is currently recording.
- ⊖ The times overlap those in another programme. Recording of the programme with the later start time starts when the earlier programme finishes recording.
- ⊖ You stopped a weekly or daily timer recording. The icon disappears the next time the timer programme starts recording.
- ⊖ The disc was full so the programme failed to record.
- ⊖ The material was copy-protected so it was not recorded.
- ⊖ The programme did not complete recording because the disc is dirty or some other reason.

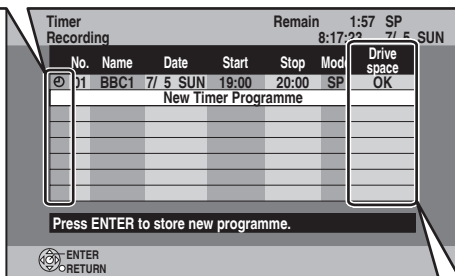

Message displayed in the "Drive space" line

OK: Displayed if the recording can fit in the remaining space.

→ **(Date):** For recordings made daily or weekly, the display will show until when recordings can be made (up to a maximum of one month from the present time) based on the time remaining on the disc.

!: It may not be possible to record because:

- the disc is write-protected
- there is no more space left
- the number of possible titles has reached its maximum.

■ To change a programme

Press [▲,▼] to select the programme and press [ENTER]. (→ page 21, Manually programming timer recordings, step 3)

■ To delete a programme

Press [▲,▼] to select the programme and press [*].

■ To exit the timer recording list

Press [PROG/CHECK].

- Programmes that failed to record are deleted from the timer recording list at 4 a.m. two days later.

Making timer recordings on the television

(e.g., of digital broadcasts)

To make a timer recording with your television, connect to a television with a Q Link function (→ page 38) that you can use for setting timer recordings using a fully wired 21-pin Scart lead (→ page 8–10).

1 Make timer programming on the TV.

2 Press [⏻ DVD] to put the unit in "standby" mode.

The start and end of recording is controlled by TV.

To stop recording

Press [■].

Note

- When this unit is in EXT LINK standby ("EXT-L" on the unit's display), recording from TV does not start.
- Programmes are recorded as one title on this unit when the end time of the earlier timer recording and the start time of the later timer recording are close to each other.

RAM To divide the titles, go to "Divide Title" (→ page 31).

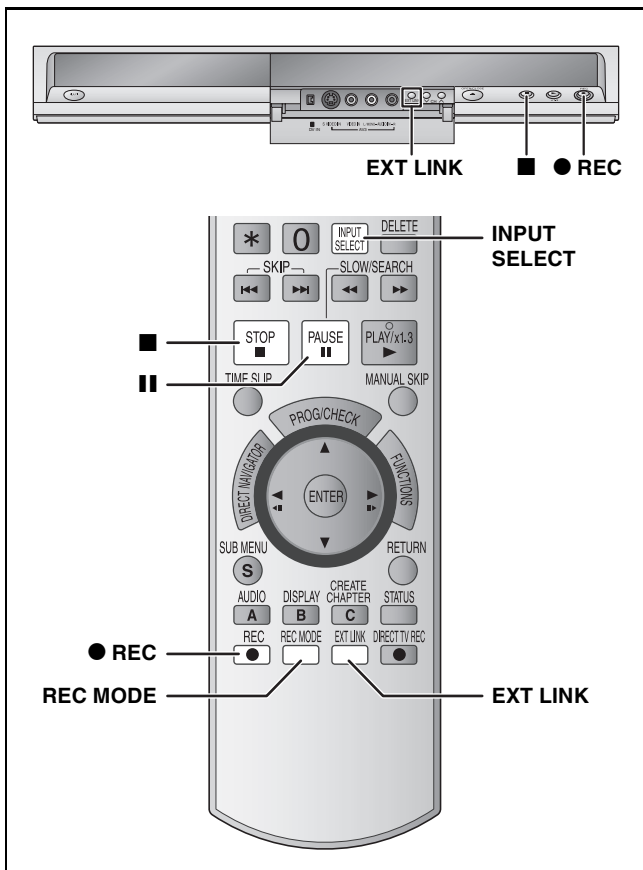

Linked timer recordings with external equipment (SKY Digital STB/digital terrestrial receiver)– EXT LINK

To record programmes from a SKY Digital STB/digital terrestrial receiver using timer programming

Preparation

- Make sure you connect the AV2 input terminal of this unit to “VCR Scart Terminal” of a SKY Digital STB/digital terrestrial receiver with a 21-pin scart lead (→ page 9).
- Set the “AV2 Input” and “Ext Link” to match the connected equipment in the Setup menu (→ page 41).

- 1 Make timer programming on SKY Digital STB/digital terrestrial receiver.
- 2 Press [EXT LINK].

The unit turns off and “EXT-L” lights on the unit’s display to indicate timer recording standby has been activated.

To cancel the external control

Press [EXT LINK] to stop recording or to cancel linked timer recording standby.

- In order to prevent accidental operation, press [EXT LINK] to cancel the setting after recording is finished.

For your reference

- This function does not work with some equipment. Refer to the equipment’s operating instructions.
- The beginnings of recordings may not be recorded correctly in some cases.
- When “Ext Link” is set to “Ext Link 2”, this function does not work if the input signal is NTSC system.
- Programmes are recorded as one title on this unit when the end time of the earlier timer recording and the start time of the later timer recording are close to each other.

- RAM** To divide the titles, go to “Divide Title” (→ page 31).
- While the unit is in EXT LINK standby mode or recording, video picture is from the AV2 input terminal irrespective of “AV1 Output” setting.

RAM -R -R DL -RW(V) +R +R DL +RW

Preparation

- Insert a disc (→ page 18).
- When recording a bilingual programme (→ page 16).

Manual Recording

Preparation

- Connect a satellite/digital terrestrial receiver to this unit’s input terminals (→ page 9).
- When the output signal from the external equipment is NTSC, change the “TV System” to “NTSC” in the Setup menu (→ page 43).

- 1 While stopped
Press [INPUT SELECT] to select the input channel for the equipment you have connected.
e.g., If you have connected to the AV2 input terminals, select “AV2”.
- 2 Press [REC MODE] to select the recording mode.
- 3 Select the channel on the other equipment.
- 4 Press [● REC].
Recording starts.

To skip unwanted parts

Press [⏸] to pause recording. (Press again to restart recording.)

To stop recording

Press [■].

Playing discs

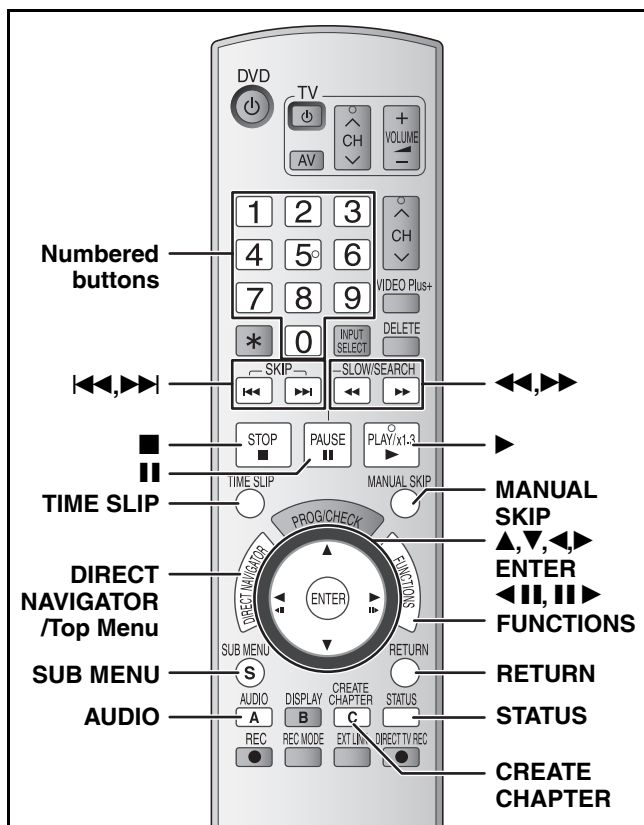

Preparation

- Turn on the television and select the appropriate video input to suit the connections to this unit.
- Turn on this unit.

1 Insert a disc (→ page 18).

2 Press [▶] (PLAY).

RAM -R -R DL -RW(V) +R +R DL +RW -RW(VR)

Play starts from the most recently recorded title.

DVD-V DVD-A CD VCD and MP3

Play starts from the beginning of the disc.



■ When a menu screen appears on the television

DVD-V DVD-A

Press [▲,▼,◀,▶] to select the item and press [ENTER].

Some items can also be selected using the numbered buttons.

VCD

Press the numbered buttons to select the item.

e.g., 5: [0] → [5] 15: [1] → [5]

• To return to the menu screen

DVD-V Press [DIRECT NAVIGATOR] or [SUB MENU].

DVD-A Press [DIRECT NAVIGATOR].

VCD Press [RETURN].

- The playing method may differ from the one described above depending on disc types. Read the disc's instructions carefully.

Selecting recorded programmes (titles) to play—Direct Navigator

Simply select the recorded programmes (titles) you want to play from the menu.

RAM -R -R DL -RW(V) +R +R DL +RW -RW(VR)

1 Press [DIRECT NAVIGATOR].

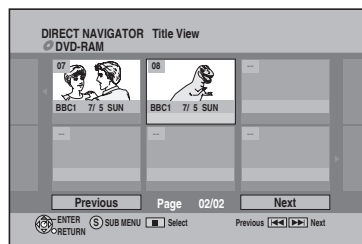

2 Press [▲,▼,◀,▶] to select the title and press [ENTER].

You can also select titles with the numbered buttons.

e.g., 5: [0] → [5] 15: [1] → [5]

To show other pages

Press [◀◀] (Previous) or [▶▶] (Next).

To exit the screen

Press [DIRECT NAVIGATOR].

Direct Navigator screen icons

- Currently recording.
- 🔒 Title protected.
- 📄 Title that was not recorded due to recording protection (Digital broadcasts etc.)
- ✗ Title cannot be played because data is damaged.
- 📁 Title with “One time only recording” restriction
- 📺 (NTSC) Title recorded using a different encoding system from that of the TV system currently selected on the unit.
- 📺 (PAL)

Note

- **RAM -R -R DL -RW(V) +R +R DL +RW** The unit stops playing a disc when timer recording starts.
- **RAM** Press [▶] (PLAY) when you wish to start playing the disc while recording (→ page 19, “Chasing playback”).

Changing audio during play

Press [AUDIO].

RAM -RW(VR) VCD

LR → L → R

e.g., “L R” is selected

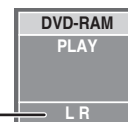

DVD-V DVD-A

You can change the audio channel number each time you press the button. This allows you to change things like the soundtrack language.

Soundtrack 1 ENG Digital 3/2.1ch

e.g., **DVD-V** English is the selected language (→ page 28, Soundtrack).

Operations during play

<p>Stop</p>	<p>Press [■]. The stopped position is memorized. Resume play function Press [▶] (PLAY) to restart from this position. The stopped position is cleared when: –you press [■] several times. –you open the tray. –DVD-A CD VCD and MP3 you turn the unit off.</p>
<p>Pause</p>	<p>Press [⏸]. Press again or press [▶] (PLAY) to restart play.</p>
<p>Search</p>	<p>Press [◀◀] or [▶▶].</p> <ul style="list-style-type: none"> • The speed increases up to 5 steps (+R +R DL +RW up to 3 steps). • Press [▶] (PLAY) to restart play. • Audio is heard during first level search forward. DVD-A (excluding motion picture parts) CD and MP3 Audio is heard during all levels of search. • Depending on the disc, searching may not be possible.
<p>Skip</p>	<p>During play or while paused, press [◀◀] or [▶▶]. The unit will skip titles, chapters, or tracks according to the number of times the button is pressed and play will begin.</p>
<p>Starting from a selected title</p>	<p>Press the numbered buttons. Play starts from the selected title, chapter or track. MP3/JPEG e.g., 5: [0] → [0] → [0] → [5] 15: [0] → [0] → [1] → [5]</p> <p>DVD-A Selecting groups While stopped (screen saver is displayed on the television → right) e.g., 5: [5]</p> <p>Other discs (You can select a track with DVD-Audio.) e.g., 5: [0] → [5] 15: [1] → [5]</p>  <ul style="list-style-type: none"> • This works only when stopped (screen saver is displayed on the television → above) with some discs. • VCD (with playback control) If you press the numbered buttons while stopped (the above screen saver is displayed on the television) you can cancel PBC. (Elapsed play time appears on the unit's display.)
<p>Quick View RAM</p>	<p>Press and hold [▶] (PLAY/x1.3). Play speed is quicker than normal. • Press again to return to normal speed.</p>
<p>Slow-motion* RAM -R -R DL -RW(V) +R +R DL +RW DVD-V DVD-A (Motion picture parts only) -RW(VR) VCD</p>	<p>While paused, press [◀◀] or [▶▶].</p> <ul style="list-style-type: none"> • The speed increases up to 5 steps. • Press [▶] (PLAY) to restart play. • VCD Forward direction [▶▶] only. • The unit will pause if slow-motion play is continued for approximately 5 minutes (excluding DVD-V DVD-A VCD).
<p>Frame-by-frame* RAM -R -R DL -RW(V) +R +R DL +RW DVD-V DVD-A (Motion picture parts only) -RW(VR) VCD</p>	<p>While paused, press [◀] or [▶].</p> <ul style="list-style-type: none"> • Each press shows the next frame. • Press and hold to change in succession forward or backward. • Press [▶] (PLAY) to restart play. • VCD Forward direction [▶] only.
<p>Skipping the specified time (Time Slip)* RAM -R -R DL -RW(V) +R +R DL +RW -RW(VR)</p>	<p>1 Press [TIME SLIP]. 2 Press [▲, ▼] to select the time and press [ENTER]. Play skips the specified time. • Each time you press [▲, ▼], the time increases [▲] or decreases [▼] by 1 minute intervals. (Press and hold for 10-minute intervals.)</p>
<p>Manual Skip* RAM -R -R DL -RW(V) +R +R DL +RW -RW(VR)</p>	<p>Press [MANUAL SKIP]. Play restarts from approximately 30 seconds later.</p>
<p>Create Chapter RAM (→ page 30, Title/Chapter)</p>	<p>Press [CREATE CHAPTER]. Chapters are divided at the point pressed. • Press [◀◀, ▶▶] to skip to the start of a chapter. • You cannot create chapters when the unit is in EXT LINK standby.</p>

* Excluding MP3/JPEG

Using menus to play MP3 and still pictures (JPEG/TIFF)

Regarding MP3 and still pictures (JPEG/TIFF)

- Compatible formats: ISO9660 level 1 or 2 (except for extended formats) and Joliet
- Maximum number of files (tracks) and folders (groups) recognizable: 3000 files*¹ (tracks) and 300 (including the root folder) folders (groups)
- *¹ Total number of recognizable file including MP3, JPEG and other type of files is 4000.
- This unit is compatible with multi-session but reading or play of the disc may take time if there are a lot of sessions.
- Operation may take time to complete when there are many files (tracks) and/or folders (groups) and some may not display nor be playable.
- English alphabet and Arabic numerals are displayed correctly. Other characters may not be displayed correctly.
- The display order on this unit may differ from how the order is displayed on a computer.
- Depending on how you create the disc (writing software), files (tracks) and folders (groups) may not play in the order you numbered them.
- This unit is not compatible with packet-write format.
- Depending on the recording, some items may not be playable.

Regarding MP3

- File format: MP3
- Files must have the extension “.mp3” or “.MP3”.
- Bit rates: 32 kbps to 320 kbps
- Sampling frequency: 16 kHz/22.05 kHz/24 kHz/32 kHz/44.1 kHz/48 kHz
- This unit is not compatible with ID3 tags.
- If there is a large amount of still picture data etc. within a MP3 file, play may not be possible.

Regarding still pictures (JPEG/TIFF)

- File format: JPEG, TIFF (non-compressed RGB chunky format)
- Files must have the extension “.jpg”, “.JPG”, “.tif” and “.TIF”.
- Number of pixels: 34 x 34 to 6144 x 4096 (Sub sampling is 4:2:2 or 4:2:0)
- Operation may take time to complete when playing TIFF format still pictures.
- MOTION JPEG is not supported.

• You can play MP3 and still pictures (JPEG/TIFF) on this unit by making folders as shown below. However depending on how you create the disc (writing software), play may not be in the order you numbered the folders.

Structure of MP3 folders

Prefix with 3-digit numbers in the order you want to play them.

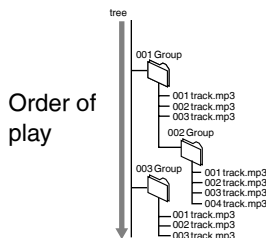

Structure of still pictures (JPEG/TIFF)*²

Files inside a folder are displayed in the order they were updated or taken.

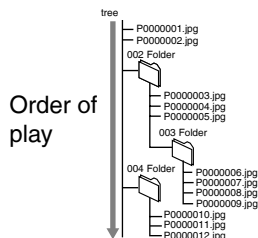

*² When the highest level folders are “DCIM” folders, they are displayed first on the tree.

Refer to the control reference on page 24.

Playing MP3

You can play CD-R/RW and DVD-R discs which contain MP3 files that have been recorded on a computer.

The screen shown at right is displayed when you insert a disc containing MP3 files and still pictures (JPEG/TIFF). Press [ENTER], and follow the steps below.

Play mode is set to MP3. To play another type of file, select the file type from Menu in FUNCTIONS.



1 Press [DIRECT NAVIGATOR].

G: Group no.

T: Track no. in the group

TOTAL: Track no./Total track no. in all groups

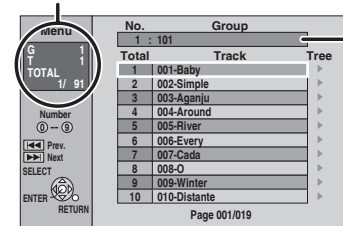

Selected group

- Files are treated as tracks and folders are treated as groups.

2 Press [▲,▼] to select the track and press [ENTER].

Play starts on the selected track.

• “” indicates the track currently playing.

• You can also select the track with the numbered buttons.

e.g., 5: [0] → [0] → [0] → [5]

15: [0] → [0] → [1] → [5]

To show other pages

Press [◀] (Previous) or [▶] (Next).

■ To select other group

1 Press [▶].

G: Selected group no. /Total group no.
If the group has no track, “- -” is displayed as group number.

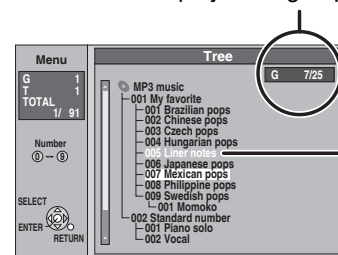

Groups that contain no compatible files.

2 Press [▲,▼] to select a group and press [ENTER].

The file list for the group appears.

To stop playing

Press [■].

To return to the previous screen

Press [RETURN].

To switch to JPEG menu

(→ page 27, “To select JPEG Menu”)

To exit the screen

Press [DIRECT NAVIGATOR].

Playing still pictures (JPEG/TIFF)

You can play CD-R/RW and DVD-R discs which contain still pictures (JPEG/TIFF) that have been recorded on a computer.

The screen shown at right is displayed when you insert a disc containing MP3 files and still pictures (JPEG/TIFF). Press [ENTER], and follow the steps below.

Play mode is set to MP3.
To play another type of file, select the file type from Menu in FUNCTIONS.

ENTER RETURN

■ To select JPEG Menu

- 1 Press [FUNCTIONS].
- 2 Press [▲,▼] to select "Menu" and press [ENTER].
- 3 Press [▲,▼] to select "JPEG" and press [ENTER].
→ below, step 2

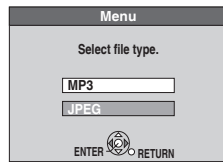

1 Press [DIRECT NAVIGATOR].

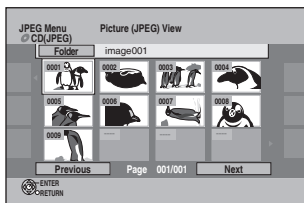

2 Press [▲,▼,◀,▶] to select the still picture and press [ENTER].

- The selected still picture is displayed on the screen.
- You can also select still pictures with the numbered buttons.

e.g., 5: [0] → [0] → [0] → [5]
15: [0] → [0] → [1] → [5]

To show other pages

Press [◀] (Previous) or [▶] (Next).

■ To select another folder

While the JPEG Menu is displayed

- 1 Press [▲,▼,◀,▶] to select "Folder" and press [ENTER].

F: Selected folder no./Total folder no.

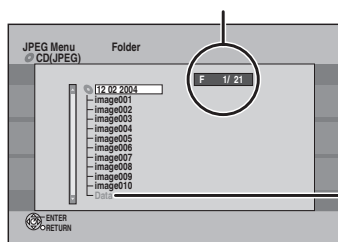

Folders that contain no compatible files.

- 2 Press [▲,▼] to select the folder and press [ENTER].

To display the previous or next still picture during play
Press [◀,▶].

To stop playing

Press [■].

- The unit remembers the still picture where you stopped play. This is cleared when you turn the unit off or remove the disc.

To return to the previous screen

Press [RETURN].

To switch to MP3 menu

Select "MP3" in step 3 of "To select JPEG Menu" (→ above).

To exit the screen

Press [DIRECT NAVIGATOR].

Useful functions during still picture play

You can display still pictures one by one with constant interval.

While the JPEG Menu is displayed

- ① Press [▲,▼,◀,▶] to select "Folder" and press [SUB MENU].

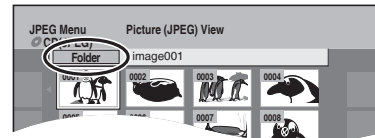

Start Slide Show
Slide Interval

- ② Press [▲,▼] to select "Start Slide Show" and press [ENTER].

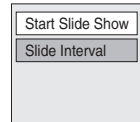

To change the slide interval

- ① In step ② above, press [▲,▼] to select "Slide Interval" and press [ENTER].
- ② Press [◀,▶] to select the slide interval and press [ENTER].
• You can select a slide interval between 0-30 seconds.

While playing

- ① Press [SUB MENU].

- ② Press [▲,▼] to select "Rotate RIGHT" or "Rotate LEFT" and press [ENTER].

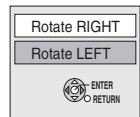

Rotate

To return the rotated picture to its original position

Press [▲,▼] to select the opposite rotation in step ② and press [ENTER].

- Rotation information will not be stored.

While playing

- ① Press [SUB MENU].

- ② Press [▲,▼] to select "Zoom in" and press [ENTER].

To return the picture to its original size

Press [▲,▼] to select "Zoom out" in step ② and press [ENTER].

- When zooming in, the picture may be cut off.
- The enlargement information will not be stored.
- The "Zoom in/Zoom out" function is only available for still pictures smaller than 640 x 480 pixels.

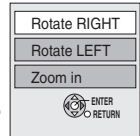

Zoom in
Zoom out

While playing

Press [STATUS] twice.



Shooting date

Properties

To exit the picture properties screen
Press [STATUS] again.

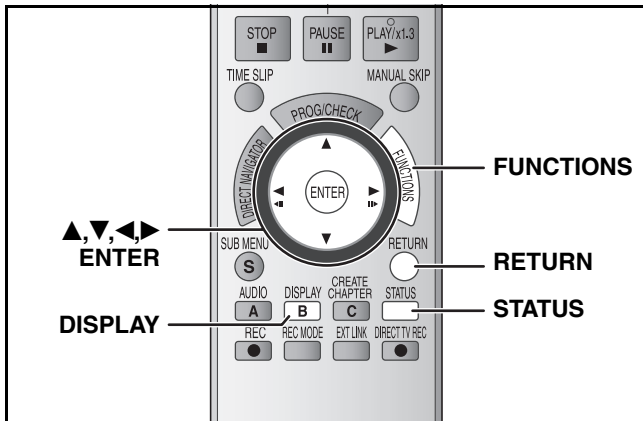

Using on-screen menus

Common procedures

1 Press [DISPLAY].

Disc	Soundtrack	1	Digital	2/0 ch
Play	Subtitle	Off		
Picture	Audio channel	LR		
Sound				
Other				

Menu Item Setting

- Depending on the condition of the unit (playing, stopped, etc.) and disc contents, there are some items that you cannot select or change.

2 Press [▲,▼] to select the menu and press [▶].

3 Press [▲,▼] to select the item and press [▶].

4 Press [▲,▼] to select the setting.

- Some items can be changed by pressing [ENTER].

To clear the on-screen menus

Press [DISPLAY].

Disc menu—Setting the disc content

Soundtrack* DVD-V DVD-A

Select the audio and language (→ right, Audio attribute, Language).

RAM -R -R DL -RW(V) +R +R DL +RW -RW(VR)

The disc's audio attributes appear.

VCD (SVCD)

Select the soundtrack number (1-2).

Subtitle* DVD-V DVD-A

Turn the subtitle on/off and select the language (→ right, Language).

RAM -R -R DL -RW(V) +R +R DL +RW -RW(VR) (Only discs that contain subtitle on/off information)

- Subtitle on/off information cannot be recorded using this unit.

VCD (SVCD)

Turn the subtitle on/off and select the subtitle number (1-4).

Audio channel RAM -RW(VR) VCD

→ page 24, Changing audio during play

Angle* DVD-V DVD-A

Change the number to select an angle.

STILL-P (Still picture) DVD-A

Selects the play method for still pictures.

Slide Show: Plays according to the default order on the disc.

Page: Select the still picture number and play.

- RANDOM:** Returns in random order.

- Return:** Returns to the default still picture on the disc.

PBC (Playback control → page 49) VCD

Indicates whether menu play (playback control) is on or off. (unchangeable)

* With some discs, you may only be able to make changes using the menus (→ page 24) on the disc.

- The display changes according to the disc content. You cannot change when there is no recording.

Audio attribute

LPCM/PPCM/Digital/DTS/MPEG: Signal type

ch (channel):

Number of channels

k (kHz):

Sampling frequency

b (bit):

Number of bits

Language

ENG: English

DAN: Danish

THA: Thai

FRA: French

POR: Portuguese

POL: Polish

DEU: German

RUS: Russian

CES: Czech

ITA: Italian

JPN: Japanese

SLK: Slovak

ESP: Spanish

CHI: Chinese

HUN: Hungarian

NLD: Dutch

KOR: Korean

FIN: Finnish

SVE: Swedish

MAL: Malay

*: Others

NOR: Norwegian

VIE: Vietnamese

- Enter a code (→ page 50) when you select “*: Others”.

Play menu—Change the play sequence

This function works only when the elapsed play time is displayed.

Select the item for repeat play. Depending on the disc, the items that can be selected will differ.

Repeat Play

- All

CD VCD

- Chapter

RAM -R -R DL -RW(V) +R +R DL +RW

DVD-V -RW(VR)

- Group

DVD-A and MP3

- PL (Playlist)

RAM -RW(VR)

- Title

RAM -R -R DL -RW(V) +R +R DL +RW

DVD-V -RW(VR)

- Track

DVD-A CD VCD and MP3

Select “Off” to cancel.

Picture menu—Change the picture quality

Playback NR

Reduces noise and picture degradation.
On ↔ Off

Progressive* (→ page 49)

Select “On” to enable progressive output.
Select “Off” if the picture is stretched horizontally.

Transfer* [When “Progressive” (→ above) is set to “On”]

Select the method of conversion for progressive output to suit the type of title being played (→ page 49, Film and video).

When the output signal is PAL

- **Auto:** Automatically detects the film and video content, and appropriately converts it.
- **Video:** Select when using “Auto”, and the video content is distorted.
- **Film:** Select this if the edges of the film content appear jagged or rough when “Auto” is selected. However, if the video content is distorted as shown in the illustration to the right, then select “Auto”.

- When the tray is opened, the setting will return to “Auto”.

When the output signal is NTSC

- **Auto 1 (normal):** Automatically detects the film and video content, and appropriately converts it.
- **Auto 2:** In addition to “Auto 1”, automatically detects film contents with different frame rates and appropriately converts it.
- **Video:** Select when using “Auto 1” and “Auto 2”, and the video content is distorted.

AV-in NR (Only when AV1, AV2, AV3 or DV is selected)

Reduces video tape noise while dubbing.

- **Automatic:** Noise reduction only works on picture input from a video tape.
- **On:** Noise reduction works for any input video.
- **Off:** Noise reduction is off. You can record the input signal as it is.

* Only when you have set “Progressive” to “On” in the Setup menu (→ page 40).

Sound menu—Change the sound effect

V.S.S.

RAM -R -R DL -RW(V) +R +R DL +RW DVD-V DVD-A
-RW(VR)

(Dolby Digital, MPEG, 2-channel or over only)

Enjoy a surround-like effect if you are using two front speakers only.

- Turn V.S.S. off if it causes distortion. (Check the surround function on the connected equipment.)
- V.S.S. does not work for bilingual recordings.

Dialog Enhancer

RAM -R -R DL -RW(V) +R +R DL +RW DVD-V DVD-A
-RW(VR)

(Dolby Digital, 3-channel or over only, including a center channel)

The volume of the center channel is raised to make dialog easier to hear.

Other menu—Change the display position

Position

1 - 5: The higher the setting the lower the on-screen menu moves.

FUNCTIONS window

By using the FUNCTIONS window you may access the main functions quickly and easily.

1 While stopped

Press [FUNCTIONS].

Functions displayed depend on the type of disc.

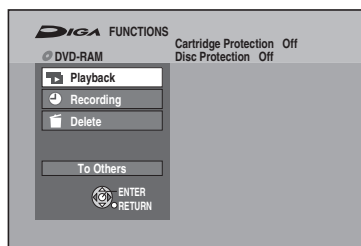

2 Press [▲, ▼] to select an item and press [ENTER].

- If you select “To Others” and press [ENTER], the following screen appears. Press [▲, ▼] to select an item and press [ENTER].

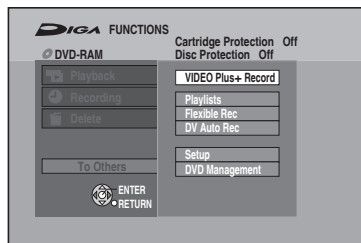

- If you press [RETURN], you can return to the previous screen.

To exit the FUNCTIONS window

Press [FUNCTIONS].

Status message

Status messages appear on the television during operation to show the condition of the unit.

Press [STATUS].

The display changes each time you press the button.

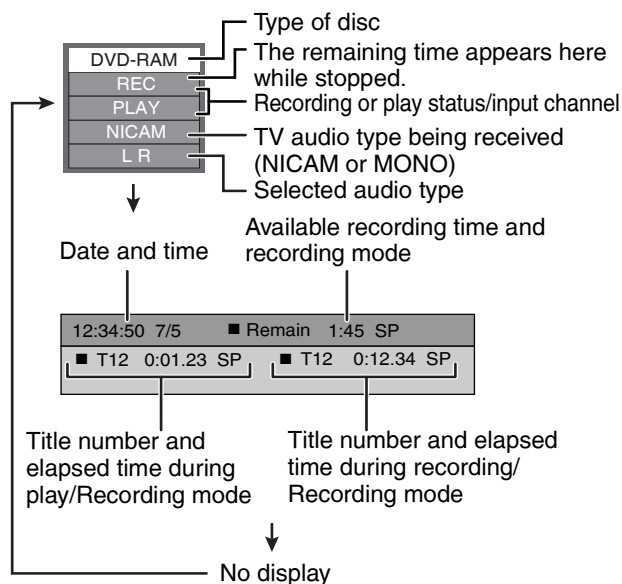

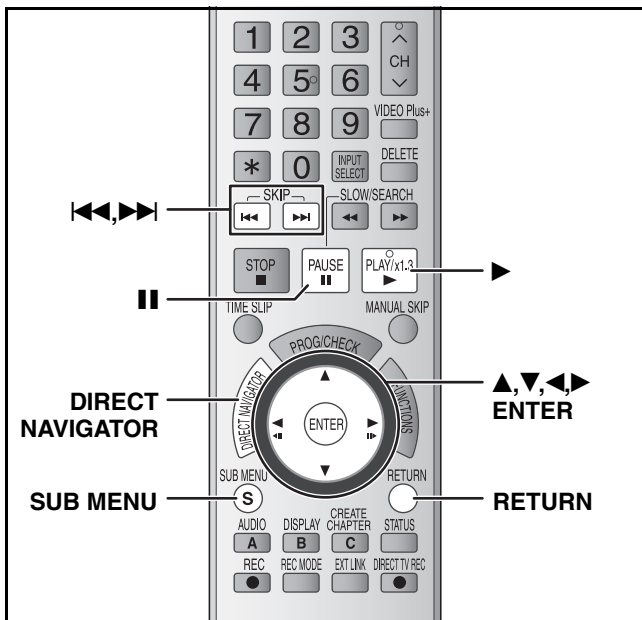

RAM -R -R DL -RW(V) +R +R DL +RW -RW(VR)

Title/Chapter

Programmes are recorded as a single title consisting of one chapter.

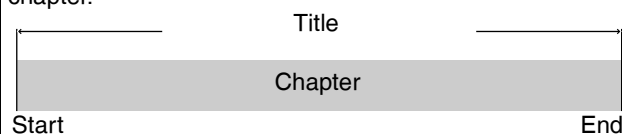

RAM You can divide a title into multiple chapters. (→ page 25, 31, "Create Chapter")

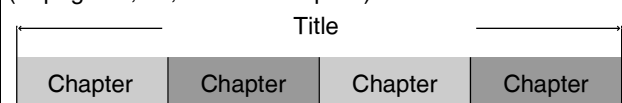

RAM You can change the order of chapters and create a playlist (→ page 32).

- -R -R DL -RW(V) +R +R DL Titles are divided into about 5-minute (+R +R DL 8-minute) chapters after finalizing (→ page 37).

• The maximum number of items on a disc:

- Titles: 99 (+R +R DL +RW 49 titles)
- Chapters: Approximately 1000 (+R +R DL +RW Approximately 254) (Depends on the state of recording.)

Note

- Once deleted or partially deleted, title/chapters cannot be restored to their original state. Make certain before proceeding.
- You cannot edit during recording.
- +RW You can create a Top Menu using "Create Top Menu" (→ page 37). Recording or editing on the disc may delete the menu. In that case, create the menu again.
- +R +R DL Management information is recorded in unused sections when you edit discs. The available space on these discs decreases each time you edit their contents.

Preparation

- Turn on the television and select the appropriate video input to suit the connections to this unit.
- Turn the unit on.
- Insert the disc with the title to edit (→ page 18).
- RAM Release protection (→ page 36).

Editing titles/chapters and playing chapters

- 1 During play or while stopped Press [DIRECT NAVIGATOR].
- 2 Press [▲,▼,◀,▶] to select the title.

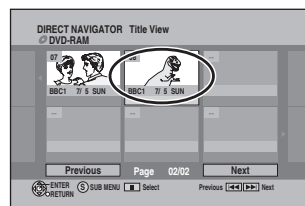

To show other pages

Press [◀◀] (Previous) or [▶▶] (Next).

Multiple editing

Select with [▲,▼,◀,▶] and press [■]. (Repeat.)

- A check mark appears. Press [■] again to cancel.

- 3 Press [SUB MENU], then press [▲,▼] to select the operation and press [ENTER].

- If you select "Edit", press [▲,▼] to select the operation and press [ENTER].

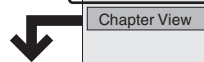
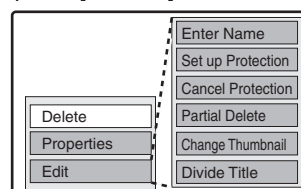

If you select "Chapter View" (→ step 4)

- 4 Press [▲,▼,◀,▶] to select the chapter.

To start play → Press [ENTER].

To edit → Step 5.

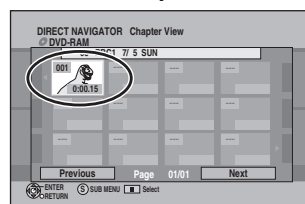

- To show other pages/Multiple editing (→ above)

- 5 Press [SUB MENU], then press [▲,▼] to select the operation and press [ENTER].

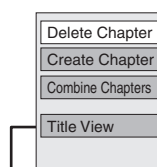

- You can go back to the Title View.

To exit the screen

Press [DIRECT NAVIGATOR].

To return to the previous screen

Press [RETURN].

Title operations

After performing steps 1–3 (→ page 30)

<p>Delete*</p> <p>RAM -R -R DL -RW(V) +R +R DL +RW</p>	<p>Press [◀▶] to select “Delete” and press [ENTER].</p> <ul style="list-style-type: none"> Once deleted, the recorded contents are lost and cannot be restored. Make certain before proceeding. -R -R DL +R +R DL The available recording time on a disc does not increase when you delete titles. -RW(V) +RW Available recording space on a disc increases only when the last recorded title is deleted. It does not increase if other titles are deleted.
<p>Properties</p> <p>RAM -R -R DL -RW(V) +R +R DL +RW -RW(VR)</p>	<p>Information (e.g., time and date) is shown.</p> <ul style="list-style-type: none"> Press [ENTER] to exit the screen.
<p>Enter Name</p> <p>RAM -R -R DL -RW(V) +R +R DL +RW</p>	<p>You can give names to recorded titles.</p> <p>→ page 43, Entering text</p>
<p>Set up Protection* Cancel Protection*</p> <p>RAM +R +R DL +RW</p>	<p>If set, this will protect the title from accidental deletion.</p> <p>Press [◀▶] to select “Yes” and press [ENTER].</p> <p>The lock symbol appears when the title is protected.</p>
<p>Partial Delete</p> <p>RAM (→ below, “For your reference”)</p>	<p>You can remove unnecessary part of the recording.</p> <ol style="list-style-type: none"> Press [ENTER] at the start point and end point of the section you want to delete. Press [▲,▼] to select “Exit” and press [ENTER]. <ul style="list-style-type: none"> Select “Next” and press [ENTER] to delete other sections. Press [◀▶] to select “Delete” and press [ENTER].
<p>Change Thumbnail</p> <p>RAM -R -R DL -RW(V) +R +R DL +RW (→ below, “For your reference”)</p>	<p>You can change the image to be shown as a thumbnail picture in the Title View.</p> <ol style="list-style-type: none"> Press [▶] (PLAY) to start play. Press [ENTER] when the image you want to use as a thumbnail is shown. <ul style="list-style-type: none"> To change the thumbnail Restart play and press [▲,▼] to select “Change”, then press [ENTER] at the point you want to use as the thumbnail. Press [▲,▼] to select “Exit” and press [ENTER].
<p>Divide Title</p> <p>RAM (→ below, “For your reference”)</p>	<p>You can divide a title into two.</p> <ol style="list-style-type: none"> Press [ENTER] at the point you want to divide the title. Press [▲,▼] to select “Exit” and press [ENTER]. Press [◀▶] to select “Divide” and press [ENTER]. <p>To confirm the division point Press [▲,▼] to select “Preview” and press [ENTER]. (The unit plays 10 seconds before and after the division point.)</p> <p>To change the division point Restart play and press [▲,▼] to select “Divide”, then press [ENTER] at the point you want to divide.</p> <p>Note</p> <ul style="list-style-type: none"> The divided titles retain the name and CPRM property (→ page 49) of the original title. Video and audio just before and after the dividing point may momentarily be cut out. Carry out the title division after checking it with “Preview” (→ above).

* Multiple editing is possible.

Chapter operations

After performing steps 1–5 (→ page 30)

<p>Delete Chapter*</p> <p>RAM</p>	<p>Press [◀▶] to select “Delete” and press [ENTER].</p> <ul style="list-style-type: none"> Once deleted, the recorded contents are lost and cannot be restored. Make certain before proceeding.
<p>Create Chapter</p> <p>RAM (→ below, “For your reference”)</p>	<p>Select the point where you want to start a new chapter while viewing the title.</p> <ol style="list-style-type: none"> Press [ENTER] at the point you want to divide. <ul style="list-style-type: none"> Repeat this step to divide at other points. Press [▲,▼] to select “Exit” and press [ENTER].
<p>Combine Chapters</p> <p>RAM</p>	<p>Press [◀▶] to select “Combine” and press [ENTER].</p> <ul style="list-style-type: none"> The selected chapter and next chapter are combined.

* Multiple editing is possible.

For your reference

- Use search or Time Slip (→ page 25) to find the desired point.
- To skip to the start or end of a title, press [◀◀] (start) or [▶▶] (end).

Creating, editing and playing playlists

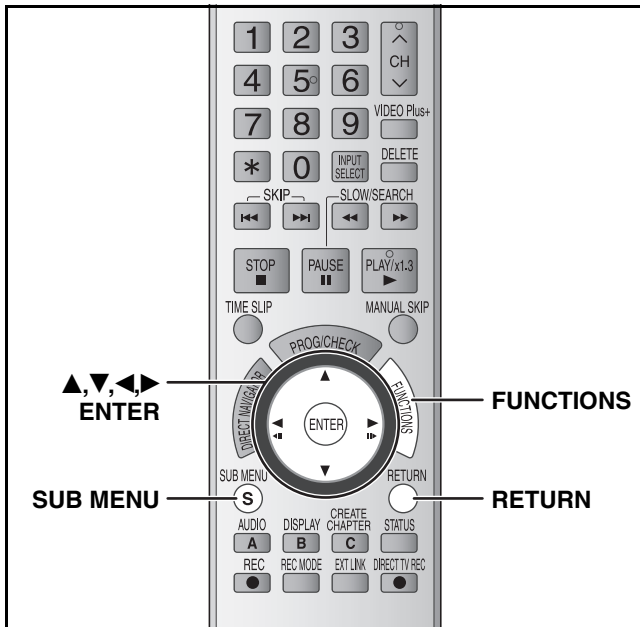

You can arrange the chapters (→ page 30) to create a playlist.

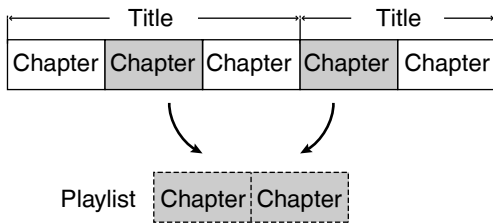

- Editing playlists doesn't modify the recorded data. Playlists are not recorded separately so this doesn't use much capacity.
- You cannot create or edit a playlist while recording.

RAM

- The maximum number of items on a disc:
 - Playlists: 99
 - Chapters in playlists: Approximately 1000 (Depends on the state of recording.)
- If you exceed the maximum numbers of items for a disc, all the items entered will not be recorded.

Preparation

- Turn on the television and select the appropriate video input to suit the connections to this unit.
- Turn the unit on.
- Insert the disc with the title to edit (→ page 18).
- Release disc or cartridge protection (→ page 36).

Creating playlists

- 1 While stopped**
Press [FUNCTIONS].
- 2 Press [▲,▼] to select "To Others" and press [ENTER].**

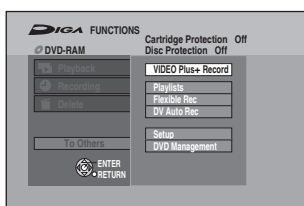

- 3 Press [▲,▼] to select "Playlists" and press [ENTER].**
- 4 Press [▲,▼,◀,▶] to select "Create" and press [ENTER].**

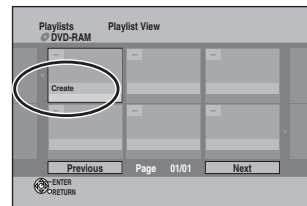

- 5 Press [◀,▶] to select the source title and press [▼].**
 - Press [ENTER] to select all the chapters in the title, then skip to step 7.

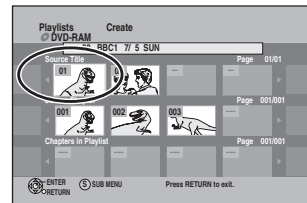

- 6 Press [◀,▶] to select the chapter you want to add to a playlist and press [ENTER].**
 - Press [▲] to cancel.

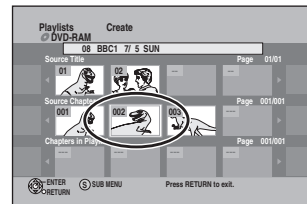

- You can also create a new chapter from the source title.
Press [SUB MENU] to select "Create Chapter" and press [ENTER] (→ page 31, "Create Chapter").

- 7 Press [◀,▶] to select the position to insert the chapter and press [ENTER].**

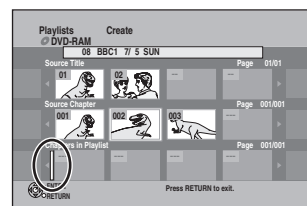

- Press [▲] to select other source titles.
- Repeat steps 5–7 to add other chapters.

- 8 Press [RETURN].**

To exit the screen

Press [RETURN] several times.

To return to the previous screen

Press [RETURN].

Editing and playing playlists/ chapters

RAM
-RW(VR) (play only)

- 1** While stopped
Press [FUNCTIONS].
- 2** Press [▲,▼] to select “To Others” and press [ENTER].
- 3** Press [▲,▼] to select “Playlists” and press [ENTER].
- 4** Press [▲,▼,◀▶] to select the playlist.
To start play → Press [ENTER].
To edit → Step 5.

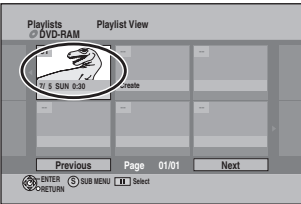

- To show other pages/Multiple editing (→ page 30)
- 5** Press [SUB MENU], then press [▲,▼] to select the operation and press [ENTER].
• If you select “Edit”, press [▲,▼] to select the operation and press [ENTER].

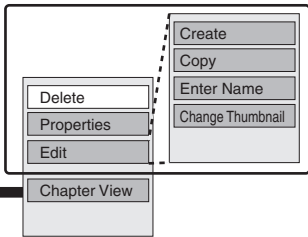

Refer to “Playlist operations” (→ right).

If you select “Chapter View” (→ step 6)

- 6** Press [▲,▼,◀▶] to select the chapter.
To start play → Press [ENTER].
To edit → Step 7.

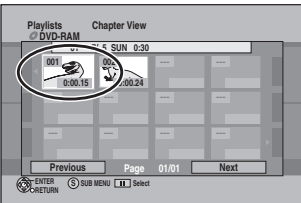

- To show other pages/Multiple editing (→ page 30)
- 7** Press [SUB MENU], then press [▲,▼] to select the operation and press [ENTER].

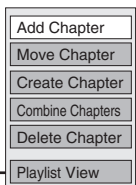

Refer to “Chapter operations” (→ right).

• You can go back to the Playlist View.

Playlist operations

After performing steps 1–5 (→ left)

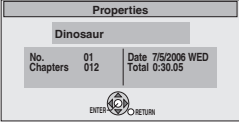
Delete* RAM	Press [◀▶] to select “Delete” and press [ENTER]. Once deleted, the playlists are lost and cannot be restored. Make certain before proceeding.
Properties RAM -RW(VR)	Playlist information (e.g., time and date) is shown. • Press [ENTER] to exit the screen. 
Create RAM	→ page 32, Creating playlists, steps 5–8
Copy* RAM	Press [◀▶] to select “Copy” and press [ENTER]. • The copied playlist becomes the newest one in the playlist view screen.
Enter Name RAM	→ page 43, Entering text
Change Thumbnail RAM	→ page 31, Change Thumbnail

* Multiple editing is possible.

Chapter operations

RAM

After performing steps 1–7 (→ left)

- Editing chapters in a playlist does not modify the source titles and source chapters.

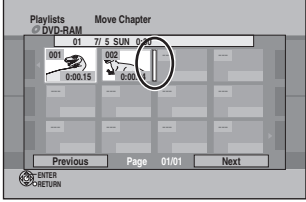
Add Chapter	→ page 32, Creating playlists, steps 5–8
Move Chapter	Press [▲,▼,◀▶] to select the position to insert the chapter and press [ENTER]. 
Create Chapter	→ page 31, Create Chapter
Combine Chapters	→ page 31, Combine Chapters
Delete Chapter* RAM	→ page 31, Delete Chapter The playlist itself is deleted if you delete all the chapters in it.

* Multiple editing is possible.

To exit the screen
Press [RETURN] several times.

To return to the previous screen
Press [RETURN].

Copying from a video cassette recorder

Refer to the control reference on page 35.

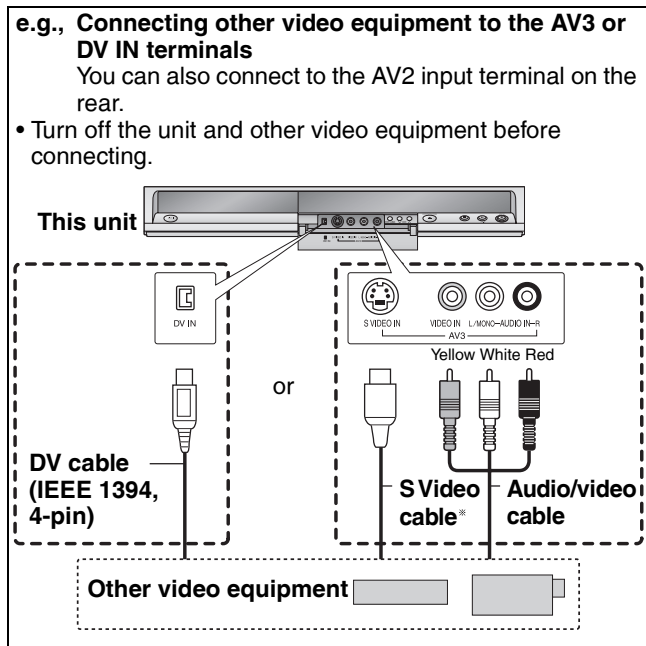

If the audio output of the other equipment is monaural
Connect to L/MONO on the AV3 input terminals at the front.
* The S VIDEO terminal achieves a more vivid picture than the VIDEO terminal.

Preparation

- Turn on the unit and connected equipment.
- Insert a disc (→ page 18).
- Press [REC MODE] to select the recording mode.
- When recording a bilingual programme (→ page 16).
- When the output signal from the external equipment is NTSC, change “TV System” to “NTSC” in the Setup menu (→ page 43). This unit cannot record to discs containing both PAL and NTSC signals.
- To reduce noise in input from external equipment, set “AV-in NR” to “On” (→ page 29).
- **When recording from the unit’s DV IN terminal**
Select the type of audio recording from “Audio Mode for DV Input” in the Setup menu (→ page 40).
When recording from DV equipment (e.g., digital video camcorder), you can record audio/video recordings from DV tape only.

DV automatic recording (DV Auto Rec)

RAM -R -RW(V) +R +RW

RAM Programmes are recorded as a title while at the same time chapters are created at each break in the images and the playlist is created automatically.

When “DV Auto Rec” screen is displayed

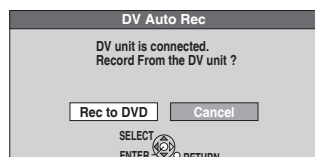

Press [◀▶] to select “Rec to DVD” and press [ENTER].
You can proceed to step 4.

- 1 While stopped**
Press [FUNCTIONS].
- 2** Press [▲,▼] to select “To Others” and press [ENTER].
- 3** Press [▲,▼] to select “DV Auto Rec”.
- 4** Press [◀▶] to select “Rec” and press [ENTER].
Recording starts.

When recording finishes

The confirmation screen appears. Press [ENTER] to finish DV automatic recording.

To stop recording

Press [■]. The confirmation screen appears. Press [ENTER].

Note

- Only one piece of DV equipment (e.g., digital video camcorder) can be connected to the unit via the DV IN terminal.
- It is not possible to operate the unit from the connected DV equipment.
- The DV IN terminal on this unit is for use with DV equipment only. (It cannot be connected to a computer, etc.)
- The DV equipment name may not be shown correctly.
- Depending on the DV equipment, the images or audio may not be input properly.
- The date and time information on the tape of the DV equipment will not be recorded.
- You cannot record and play simultaneously.

If the DV automatic recording function does not work properly, check the connections and DV equipment settings, and turn the unit off and back on.

If that does not work, follow the instructions for manual recording (→ below).

Manual recording

RAM -R -R DL -RW(V) +R +R DL +RW

- 1 While stopped**
Press [INPUT SELECT] to select the input channel for the equipment you have connected.
e.g., If you have connected to AV3 input terminals, select “AV3”.
- 2 Start play on the other equipment.**
- 3 When you want to start recording**
Press [● REC].
Recording starts.

• Using Flexible Recording (→ page 19), you can record the content of a video cassette (approx. 1–8 hours) to a 4.7 GB disc with the best possible quality of recording without wasting disc space.

To skip unwanted parts

Press [II] to pause recording. (Press again to restart recording.)

To stop recording

Press [■].

Almost all videos and DVD software on sale have been treated to prevent illegal copying. Any software that has been so treated cannot be recorded using this unit.

Deleting titles

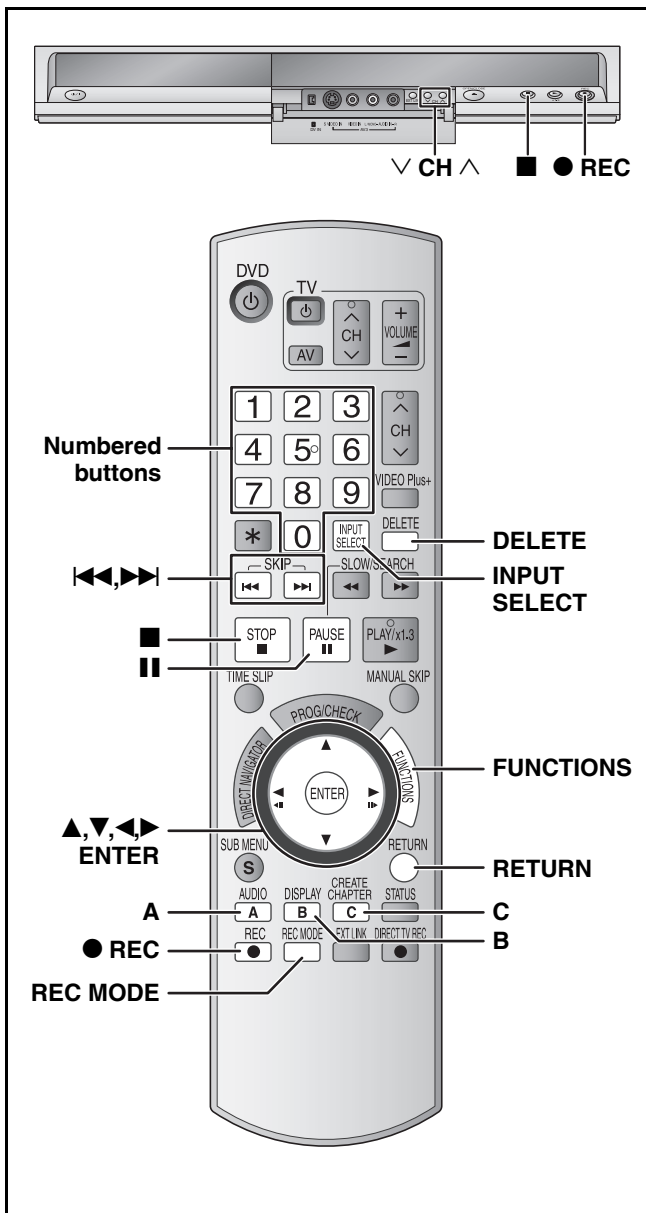

RAM -R -R DL -RW(V) +R +R DL +RW

- A title cannot be restored once it is deleted. Make certain before proceeding.
- You cannot delete while recording.

RAM

When a recorded title is deleted the available disc space will increase by the amount deleted.

The available disc space increases if any of these is deleted.

Title1	Title2	----	The last recorded title	The available space
--------	--------	------	-------------------------	---------------------

-RW(V) +RW

Disc space increases only when the last recorded title is deleted.

The available space does not increase if these are deleted.

When deleted, the available disc space increases.

Title1	Title2	----	The last recorded title	The available space
--------	--------	------	-------------------------	---------------------

-R -R DL +R +R DL

Available space does not increase after deletion.

Using DELETE Navigator to delete titles

Preparation

- Turn on the television and select the appropriate video input to suit the connections to this unit.
- Turn the unit on.
- Insert the disc (→ page 18).

1 While stopped
Press [FUNCTIONS].

2 Press [▲, ▼] to select “Delete” and press [ENTER].

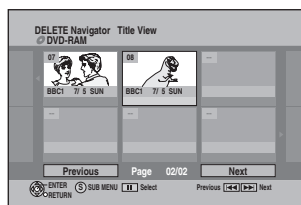

3 Press [▲, ▼, ◀, ▶] to select the title and press [ENTER].

To show other pages

Press [◀◀] (Previous) or [▶▶] (Next).

Multiple deleting

Select with [▲, ▼, ◀, ▶] and press [■]. (Repeat.)

- A check mark appears. Press [■] again to cancel.

4 Press [◀, ▶] to select “Delete” and press [ENTER].

To return to the previous screen

Press [RETURN].

To exit the screen

Press [RETURN] several times.

Deleting titles during play

1 While playing
Press [DELETE].

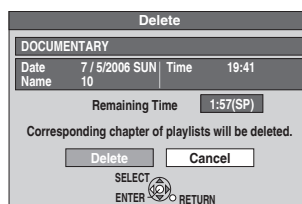

2 Press [◀, ▶] to select “Delete” and press [ENTER].

Refer to the control reference on page 35.

Common procedures

Preparation

- **RAM** Release protection (→ below).

- 1** While stopped
Press [FUNCTIONS].
- 2** Press [▲,▼] to select “To Others” and press [ENTER].
- 3** Press [▲,▼] to select “DVD Management” and press [ENTER].
Select which step 4 to perform depending on what you want to do next.

To exit the screen

Press [RETURN] several times.

To return to the previous screen

Press [RETURN].

Providing a name for a disc

RAM -R -R DL -RW(V) +R +R DL +RW

After performing steps 1–3 (→ above)

- 4** Press [▲,▼] to select “Disc Name” and press [ENTER].
→ page 43, Entering text
 - The disc name is displayed in the DVD Management window.
 - With a finalized disc and +RW, the name is displayed on the Top Menu.

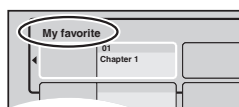
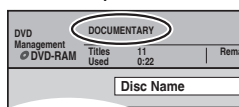

Setting the protection

RAM

After performing steps 1–3 (→ above)

- 4** Press [▲,▼] to select “Disc Protection” and press [ENTER].
- 5** Press [◀,▶] to select “Yes” and press [ENTER].

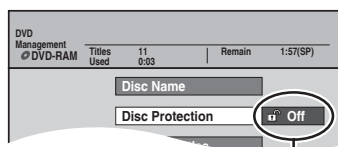

The lock symbol appears closed when the disc is write-protected.

Cartridge-protection

RAM (with a cartridge)

With the write-protect tab in the protect position, play automatically starts when inserted in the unit.



Deleting all titles and playlists

–Delete all titles

RAM

After performing steps 1–3 (→ left)

- 4** Press [▲,▼] to select “Delete all titles” and press [ENTER].
- 5** Press [◀,▶] to select “Yes” and press [ENTER].
- 6** Press [◀,▶] to select “Start” and press [ENTER].
A message appears when finished.
- 7** Press [ENTER].

Note

- Once deleted, the recorded contents are lost and cannot be restored. Make certain before proceeding.
- Deleting all video titles will result in all playlists also being deleted.
- Delete does not work if one or more titles are protected.

Deleting all the contents of a disc

–Format Disc

RAM -RW(V) +RW -RW(VR)

+R +R DL (New disc only)

Note

Formatting deletes all contents (including computer data), and they cannot be restored. Check carefully before proceeding. The contents are deleted when you format it even if you have set protection.

After performing steps 1–3 (→ left)

- 4** Press [▲,▼] to select “Format Disc” and press [ENTER].
 - 5** Press [◀,▶] to select “Yes” and press [ENTER].
 - 6** Press [◀,▶] to select “Start” and press [ENTER].
A message appears when formatting is finished.
- Note**
- Do not disconnect the AC mains lead while formatting. This can render the disc unusable.
 - Formatting normally takes a few minutes, however it may take up to a maximum of 70 minutes (**RAM**).
- 7** Press [ENTER].

Note

- -R -R DL CD Formatting cannot be performed on the disc.
- -RW(V) -RW(VR) You can format only as DVD-Video format on this unit.
- When a disc has been formatted using this unit, it may not be possible to use it on any other equipment.

To stop formatting **RAM**

Press [RETURN].

- You can cancel formatting if it takes more than 2 minutes. The disc must be reformatted if you do this.

Selecting whether to show the Top Menu first

–Auto-Play Select

-R -R DL -RW(V) +R +R DL +RW

You can select whether to show the top menu after finalizing. Make selections before finalizing the disc.

After performing steps 1–3 (→ page 36)

- 4 Press [**▲**,**▼**] to select “Auto-Play Select” and press [ENTER].
- 5 Press [**▲**,**▼**] to select items and press [ENTER].

Top Menu: The top menu appears first.

Title 1: The disc content is played without displaying the top menu.

Enabling discs to be played on other equipment

–Finalize

-R -R DL -RW(V) +R +R DL

Finalize the disc so you can play it on other DVD equipment. The equipment must be able to play finalized discs. To check compatibility with other equipment, refer to page 6.

After performing steps 1–3 (→ page 36)

- 4 Press [**▲**,**▼**] to select “Finalize” and press [ENTER].
- 5 Press [**◀**,**▶**] to select “Yes” and press [ENTER].
- 6 Press [**◀**,**▶**] to select “Start” and press [ENTER].

- Finalizing starts. You cannot cancel finalizing.
- Finalizing can take a few minutes, up to a maximum of 15 minutes, depending on the remaining space on the disc. (**-R DL +R DL** up to 60 minutes.)

Note

Do not disconnect the AC mains lead while finalizing. This will render the disc unusable.

- 7 Press [ENTER].

After finalizing

- **-R -R DL +R +R DL** The disc becomes play-only and you can no longer record or edit.
- **-RW(V)** You can record and edit the disc after formatting (→ page 36) although it becomes play-only after finalizing.
- Titles are divided into about 5-minute (**+R +R DL** 8-minute) chapters after finalizing. This time varies greatly depending on the condition and mode of recording.
- There is a pause of several seconds between titles and chapters during play.

- You cannot finalize discs recorded on other manufacturers' equipment.
- Discs finalized on this unit may not be playable on other players due to the condition of the recording.
- When finalizing a high-speed recording compatible disc, it may take longer than displayed on the confirmation screen (approximately four times).

Creating Top Menu

–Create Top Menu

+RW

+RW discs contain no Top Menu data. Top Menu is a convenient function. We recommend you to create the menu before playing a +RW disc on other equipment.

After performing steps 1–3 (→ page 36)

- 4 Press [**▲**,**▼**] to select “Create Top Menu” and press [ENTER].
- 5 Press [**◀**,**▶**] to select “Yes” and press [ENTER].
- 6 Press [**◀**,**▶**] to select “Start” and press [ENTER].
- 7 Press [ENTER].

- Recording or editing on the disc may delete the menu. In that case, create the menu again.
- You cannot use the title menu for playing on this unit.

Enabling the second layer on DL (dual- or double- layer on single side) discs to be recordable

–Close First Layer

-R DL +R DL

DVD-R DL and +R DL discs have two layers of recording surface on one side. This unit does not offer seamless recording on two layers. Recording stops when space on the first layer becomes full. You must close the first layer to start recording on the second layer. Closing makes the first layer unavailable for recording (editing is still available). You cannot cancel closing. Make certain before proceeding.

After performing steps 1–3 (→ page 36)

- 4 Press [**▲**,**▼**] to select “Close First Layer” and press [ENTER].
- 5 Press [**◀**,**▶**] to select “Yes” and press [ENTER].
- 6 Press [**◀**,**▶**] to select “Start” and press [ENTER].

Closing the layer starts. You cannot cancel closing. Closing the layer can take several minutes, up to a maximum of 30 minutes, depending on the remaining space on the first layer.

Note

Do not disconnect the AC mains lead while closing the layer. This will render the disc unusable.

- 7 Press [ENTER].

- You cannot close the first layer when it has no recording.
- By closing the layer, you can record or edit discs that have been recorded on the second layer by other equipment.

■ To confirm the layer you can record

You can confirm the remaining recording time on the layer you can record.

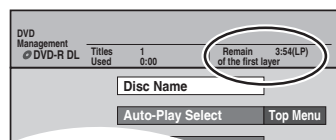

Linked operations with the TV (Q Link)

What is Q Link?

Q Link enables you to connect this unit to a Q Link-equipped Panasonic TV and perform various linked functions.

The following systems from other manufacturers have similar function to Q Link from Panasonic.

For details, refer to your television's operating instructions or consult your dealer.

- Q Link (registered trademark of Panasonic)
- Easy Link (registered trademark of Philips)
- SMARTLINK (registered trademark of Sony)
- DATA LOGIC (registered trademark of Metz)
- Megalogic (registered trademark of Grundig)

Preparation

- Connect this unit to your TV with a fully wired 21-pin Scart lead (→ page 8–10).

TV/DVD Auto On	When you press the following buttons, linked operations with the TV activate and corresponding screens appear. When this unit is on: Press [▶] (PLAY) [DIRECT NAVIGATOR] [VIDEO Plus+] [PROG/CHECK] [FUNCTIONS] • DVD-V DVD-A CD VCD and MP3 The TV is automatically turned on and corresponding screens appear when you insert the discs.	When this unit is off: Press [▶] (PLAY) [DIRECT NAVIGATOR] [VIDEO Plus+] [PROG/CHECK]
DVD Auto Standby	When you turn the TV off, the unit is turned off as well. However, this function works in the stop mode [while screen saver (→ right) is displayed on the television, this does not work]. This function does not work during the following operations: channel reception setting, Auto Clock Setting, Child Lock and Manual Tuning.	
Direct TV Recording	You can record the same programme that you are watching on the TV. • This function allows you to immediately start recording the programme that you are viewing on the TV without having to change the channels on this unit. • Just make sure you have a disc ready in the unit so that when a programme comes on the television that you want to record, all you have to do is press [● DIRECT TV REC] . You don't even have to turn this unit on. Press [● DIRECT TV REC] for 1 second. Recording starts. To stop recording Press [■] .	
Download from the TV	As you set TV stations, the station list data is automatically copied from the TV to the unit, and the TV stations are assigned to the programme positions on the unit in the same order as on the TV.	

Child Lock

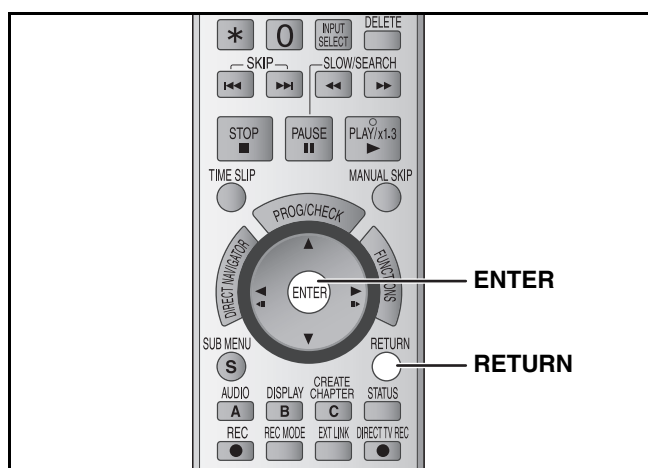

The Child Lock deactivates all buttons on the unit and remote control. Use it to prevent other people from operating the unit.

Press and hold [ENTER] and [RETURN] simultaneously until "X HOLD" appears on the unit's display.



If you press a button while the Child Lock is on, "X HOLD" appears on the unit's display and operation is impossible.

To cancel the Child Lock

Press and hold [ENTER] and [RETURN] simultaneously until "X HOLD" disappears.

Changing the unit's settings

Refer to the control reference on page 35.

Common procedures

- 1 While stopped
Press [FUNCTIONS].
- 2 Press [▲,▼] to select "To Others" and press [ENTER].
- 3 Press [▲,▼] to select "Setup" and press [ENTER].
- 4 Press [▲,▼] to select the tab and press [▶].
- 5 Press [▲,▼] to select the menu and press [ENTER].
- 6 Press [▲,▼] to select the option and press [ENTER].

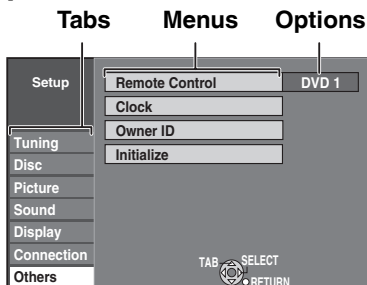

To return to the previous screen
Press [RETURN].

To exit the screen
Press [RETURN] several times.





Note
There may be differences in operation methods. If this happens, follow the on-screen instructions for the operation.

Summary of settings

The settings remain intact even if you switch the unit to standby.

Tabs	Menus	Options (Underlined items are the factory presets.)
Tuning	Manual (→ page 42)	
	Auto-Setup Restart (→ page 42)	
	Download from TV (→ page 42)	
Disc	Settings for Playback	
	• Press [ENTER] to show the following settings.	
	Ratings Set a ratings level to limit DVD-Video play.	<ul style="list-style-type: none"> • <u>8 No Limit</u>: All DVD-Video can be played. • 1 to 7: Prohibits play of DVD-Video with corresponding ratings recorded on them. • 0 Lock All: Prohibits play of all DVD-Video.
	Follow the on-screen instructions. Enter a 4-digit password with the numbered buttons when the password screen is shown.	<ul style="list-style-type: none"> • Unlock Recorder • Change Password • Change Level • Temporary Unlock
	• Do not forget your password.	
	DVD-Audio Video mode Playback Select "On" to play DVD-Video content on some DVD-Audio.	<ul style="list-style-type: none"> • On: The setting returns to "Off" when you change the disc or turn the unit off. • <u>Off</u>
	Soundtrack DVD-V	<ul style="list-style-type: none"> • <u>English</u> • German • French • Italian • Spanish • Original: The original language of each disc will be selected. • Other * * * *
	Subtitle DVD-V	<ul style="list-style-type: none"> • <u>Automatic</u>: If the language selected for "Soundtrack" is not available, subtitles of that language will automatically appear if available on that disc. • English • German • French • Italian • Spanish • Other * * * *
	Menus DVD-V	<ul style="list-style-type: none"> • <u>English</u> • German • French • Italian • Spanish • Other * * * *
	Settings for Recording	
• Press [ENTER] to show the following setting.		
Recording time in EP mode Select the maximum number of hours for recording in EP mode (→ page 17, Recording modes and approximate recording times).	<ul style="list-style-type: none"> • EP (6Hours): You can record for 6 hours on an unused 4.7 GB disc. • <u>EP (8Hours)</u>: You can record for 8 hours on an unused 4.7 GB disc. 	
Picture	Comb Filter Select the picture sharpness when recording. The setting is fixed with "On" if you set "TV System" to "NTSC" (→ page 43).	<ul style="list-style-type: none"> • On: Select it to record clear picture. • <u>Off</u>: Normally, use this setting.
	Still Mode Select the type of picture shown when you pause play (→ page 49, Frames and fields).	<ul style="list-style-type: none"> • <u>Automatic</u>: • Field: Select if jittering occurs when "Automatic" is selected. (The picture is coarser.) • Frame: Select if small text or fine patterns cannot be seen clearly when "Automatic" is selected. (The picture is clearer and finer.)

Refer to the control reference on page 35.

Tabs	Menus	Options (Underlined items are the factory presets.)
Sound	Dynamic Range Compression  (Dolby Digital only) Change the dynamic range for late night viewing.	• On • <u>Off</u>
	Bilingual Audio Selection  Select whether to record the main or secondary audio type when recording to a disc.	• <u>M 1</u> • M 2 You cannot select this when recording from an external source (except from DV equipment connected to this unit's DV IN terminal). Select the audio on the other equipment.
	Digital Audio Output Change the settings when you have connected equipment through this unit's DIGITAL AUDIO OUT terminal (→ page 11). • Press [ENTER] to show the following settings.	
	PCM Down Conversion Select how to output audio with a sampling frequency of 96 kHz or 88.2 kHz. • Signals are converted to 48 kHz or 44.1 kHz despite the above settings if the signals have a sampling frequency of over 96 kHz or 88.2 kHz, or the disc has copy protection.	• On: Signals are converted to 48 kHz or 44.1 kHz. (Choose when the connected equipment cannot process signals with a sampling frequency of 96 kHz or 88.2 kHz.) • <u>Off</u> : Signals are output as 96 kHz or 88.2 kHz. (Choose when the connected equipment can process signals with a sampling frequency of 96 kHz or 88.2 kHz.)
	Dolby Digital  Select how to output the signal. Select "Bitstream" if the connected equipment decodes the signal. Select "PCM" if this unit decodes the signal and output it as 2 channel.	• <u>Bitstream</u> : When connecting to equipment displaying the Dolby Digital logo. • PCM: When connecting to equipment not displaying the Dolby Digital logo.
	 MPEG Not making the proper settings may result in noise or some trouble for digital recording.	• <u>Bitstream</u> : When connecting to equipment displaying the DTS logo. • PCM: When connecting to equipment not displaying the DTS logo. • <u>Bitstream</u> : When connected to equipment with a built-in MPEG decoder. • <u>PCM</u> : When connected to equipment without a built-in MPEG decoder.
Audio Mode for DV Input You can select the kind of audio when recording from the unit's DV IN terminal (→ page 34).	• <u>Stereo 1</u> : Records audio (L1, R1). • Stereo 2: Records added audio such as narration (L2, R2) subsequent to original recording. • Mix: Records both Stereo 1 and Stereo 2.  When recording bilingual broadcast to a disc, select the type of audio in advance from "Bilingual Audio Selection" (→ above).	
Display	On-Screen Messages Choose whether to show status messages automatically.	• <u>Automatic</u> • Off
	Grey Background Select "Off" if you do not want to have the unit show the grey background when tuner reception is weak.	• <u>On</u> • Off
	FL Display Changes the brightness of the unit's display.	• <u>Bright</u> • Dim
Connection	TV Aspect (→ page 14)	• <u>16:9</u> • 4:3 • Letterbox
	Progressive (→ page 14) This setting is fixed with "Off" if you set "AV1 Output" to "RGB 1 (without component)" or "RGB 2 (without component)" (→ below).	• On • <u>Off</u>
	TV System (→ page 43)	• <u>PAL</u> • NTSC
	AV1 Output Select the output from the AV1 terminal. Select "RGB 1 (without component)" or "RGB 2 (without component)" for RGB output. Select "Video (with component)" or "S Video (with component)" for component output (progressive output). Set according to the signal and terminal of the connected TV.	• Video (with component): Select when a TV is connected that can receive a composite signal. • S Video (with component): Select when a TV is connected that can receive an S Video signal. • RGB 1 (without component): Select when you have connected a TV that can receive RGB signals. Select this mode so the TV automatically switches to display the picture from the unit when you turn the unit on. • <u>RGB 2 (without component)</u> : Select when you have connected a TV that can receive RGB signals. If you would like to switch to display the picture from the unit only when playback or viewing menus, select this mode.

Tabs	Menus	Options (Underlined items are the factory presets.)
Connection (Continued)	AV2 Settings Set to match the connected equipment. • Press [ENTER] to show the following setting.	
	AV2 Input This setting is according to the output signal of the connected equipment.	• <u>Video</u> • S Video
	Ext Link This setting cannot be made when the "TV System" is set to "NTSC" (→ page 43).	• <u>Ext Link 1</u> : When a satellite/digital terrestrial receiver (SKY Digital STB etc.) which transmits a special control signal recordings via the 21-pin Scart lead is connected. Start and stop timings of recording are controlled by the control signal (SKY Digital STB/digital terrestrial receiver using the "SKY Personal Planner" function). • <u>Ext Link 2</u> : When an external equipment with a timer function is connected. When it turns on, recording starts. When it turns off, recording stops.
Others	Remote Control (→ page 15)	• <u>DVD 1</u> • DVD 2 • DVD 3
	Clock (→ below)	
	Owner ID (→ page 12) In order to prevent another person from using this unit if it is stolen, you can set a PIN number and input your personal information. Once the PIN number has been set, you cannot return to the factory preset. Make sure not to forget this.	• PIN number • Name • House No. • Postcode
	Initialize • Press [ENTER] to show the following setting.	
	Shipping Condition All the settings except for the ratings level, ratings password, Owner ID and time settings return to the factory preset. The timer recording programmes are also cancelled.	• Yes • <u>No</u>
	Default Settings All the settings except for the programmed channels, time settings, disc language settings, ratings level, ratings password, Owner ID and remote control code return to the factory presets.	• Yes • <u>No</u>

Set the clock manually

Refer to the control reference on page 35.

- Usually, the unit's channel reception setting function (→ page 12) automatically adjusts the clock to correct time. Under some reception conditions, however, the unit cannot set the clock automatically.
- In this case, follow the operation steps below to manually set the clock.

- In the case of a power failure, the clock setting remains in memory for approximately 60 minutes.

- 1** While stopped
Press [FUNCTIONS].
- 2** Press [▲,▼] to select "To Others" and press [ENTER].
- 3** Press [▲,▼] to select "Setup" and press [ENTER].
- 4** Press [▲,▼] to select "Others" and press [▶].
- 5** Press [▲,▼] to select "Clock" and press [ENTER].
- 6** Press [▲,▼] to select "Off" of "Automatic" and press [ENTER].

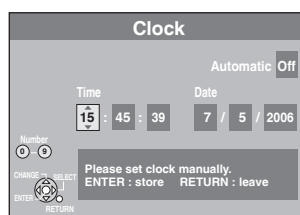

- 7** Press [◀,▶] to select the item you want to change.

The items change as follows:

Hour ↔ Minute ↔ Second ↔ Day ↔ Month ↔ Year

- 8** Press [▲,▼] to change the setting.

You can also use the numbered buttons for setting.

- 9** Press [ENTER] when you have finished the settings.

The clock starts.

To exit the screen

Press [RETURN] several times.

To return to the previous screen

Press [RETURN].

Note

If a TV station transmits a time setting signal, and when "Automatic" in the Clock setting menu is set to "On", the automatic time correction function checks the time and if necessary it is adjusted several times every day.

Resetting channel setting

Refer to the control reference on page 35.

You can add or delete channels, or change programme positions.

- 1 While stopped
Press [FUNCTIONS].
- 2 Press [▲,▼] to select “To Others” and press [ENTER].
- 3 Press [▲,▼] to select “Setup” and press [ENTER].
- 4 Press [▲,▼] to select “Tuning” and press [▶].

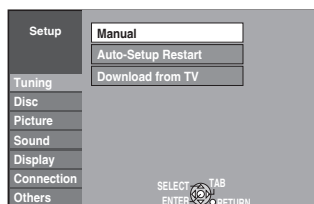

- 5 Press [▲,▼] to select “Manual” and press [ENTER].

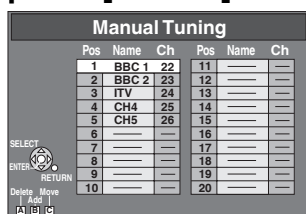

To delete a programme position

Press [▲,▼,◀▶] to select a programme position and press [A].

To add a blank programme position

Press [▲,▼,◀▶] to select a programme position and press [B].

To move a TV station to another programme position

- ① Press [▲,▼,◀▶] to select a programme position and press [C].
- ② Press [▲,▼] to select the new programme position to which you want to assign the TV station and press [ENTER].

Note

When the unit connected to a Q Link-compatible TV with a fully wired 21-pin Scart lead sets itself automatically (→ page 12), only deletion of the programme position can be performed.

To change detailed station settings

After performing steps 1–5 (→ above)

- 6 Press [▲,▼,◀▶] to select a programme position and press [ENTER].

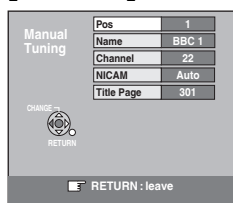

Press [▲,▼] to select an item and press [▶].

Pos	To change the programme position in which the TV stations are assigned Press [▲,▼] or the numbered buttons to select the number of the desired programme position and press [ENTER].
Name	To enter or change the name of a TV station Press [▲,▼,◀▶] to enter station name and press [ENTER]. If the station name needs a blank space, select the blank between “Z” and “*”.
Channel	To enter newly available TV stations or change the channel number of an already tuned TV station Press [▲,▼] or the numbered buttons to enter the channel number of the desired TV station. Wait a few moments until the desired TV station has been tuned. After the desired TV station is tuned, press [ENTER].
NICAM	To select the type of sound to be recorded Press [▲,▼] to select “Auto” and press [ENTER]. • Select “Off” if you want to record the normal (mono) sound during a stereo, bilingual or NICAM broadcast, or if the stereo sound is distorted due to inferior reception conditions.
Title Page	To enter the Teletext title page for a channel Entering title page number allows the unit to automatically record programme and station names. Press [▲,▼] or the numbered buttons to enter the number and press [ENTER]. • To find the correct title page for the station, refer to its Teletext TV guide. • The unit’s clock must be set correctly.

Automatic setting

You can restart auto channel setting if the channel reception setting (→ page 12) fails for some reason.

After performing steps 1–4 (→ left)

- 5 Press [▲,▼] to select “Auto-Setup Restart” or “Download from TV” and press [ENTER].

The confirmation screen appears.

Select “Download from TV” when you connect the unit to a Q Link-compatible TV with a fully wired 21-pin Scart lead. (Programme positions are downloaded from the TV and copied through this convenient function.)

- 6 Press [◀▶] to select “Yes” and press [ENTER].

You can also use the following method to restart Auto-Setup. When the unit is on and stopped

Press and hold [▼ CH] and [CH ^] on the main unit for about 5 seconds.

- All the settings except for the ratings level, ratings password, Owner ID and time settings return to the factory preset. The timer recording programmes are also cancelled.

To exit the screen

Press [RETURN] several times.

To return to the previous screen

Press [RETURN].

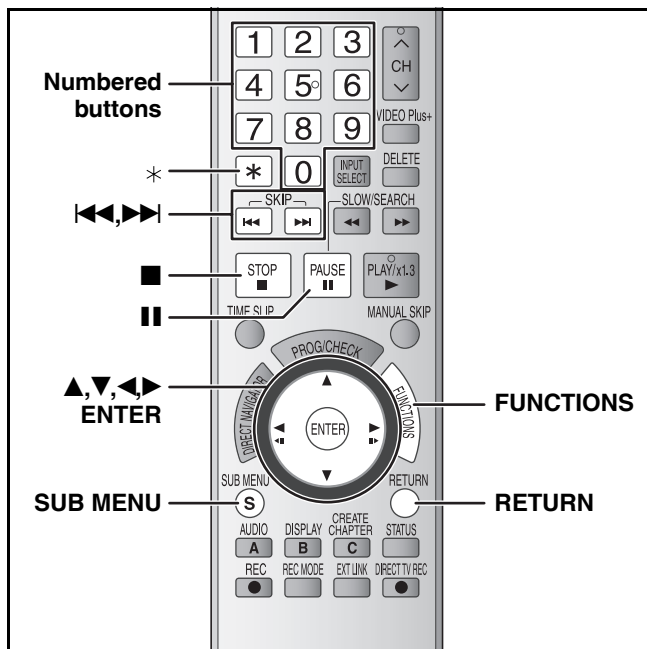

Change this setting if you connect an NTSC television or to record NTSC video from another source.

- 1** While stopped
Press [FUNCTIONS].
- 2** Press [▲, ▼] to select “To Others” and press [ENTER].
- 3** Press [▲, ▼] to select “Setup” and press [ENTER].
- 4** Press [▲, ▼] to select “Connection” and press [▶].
- 5** Press [▲, ▼] to select “TV System” and press [ENTER].
- 6** Press [▲, ▼] to select the TV system and press [ENTER].

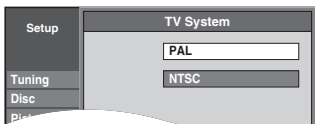

- **PAL (factory preset)**
 - Select when connecting to a PAL or Multi-system television. Programmes recorded using NTSC are played as PAL 60.
 - Select to record television programmes and PAL input from other equipment.
 - **NTSC**
 - Select when connecting to a NTSC television. Television programmes cannot be recorded properly.
 - Select to record NTSC input from other equipment.
- The confirmation screen appears.

- 7** Press [◀, ▶] to select “Yes” and press [ENTER].

To exit the screen

Press [RETURN] several times.

To return to the previous screen

Press [RETURN].

■ To change the setting all at once (PAL ↔ NTSC)

While stopped, press and hold [■] and [▲ OPEN/CLOSE] on the main unit at the same time for about 5 seconds.

RAM -R -R DL -RW(V) +R +R DL +RW

You can give names to recorded titles, etc.
The maximum number of characters:

RAM	Characters	-R -R DL -RW(V) +R +R DL +RW	Characters
Title	64 (44*)	Title	44
Playlist	64	Disc	40
Disc	64		

* Title name for timer recording

If a name is long, parts of it may not be shown in some screens.

1 Show Enter Name screen.

Title (timer recording)	(→ page 20, 21, step 3)
Title	(→ page 30, step 3)
Playlist	(→ page 33, step 5)
Disc	(→ page 36, “Providing a name for a disc”)

Name field: shows the text you have entered

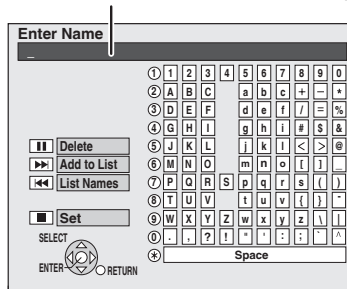

2 Press [▲, ▼, ◀, ▶] to select a character and press [ENTER].

Repeat this step to enter other characters.

• To delete a character

Press [▲, ▼, ◀, ▶] to select the character in the name field and press [■].

• Using the numbered buttons to enter characters

e.g., entering the letter “R”

① Press [7] to move to the 7th row.

② Press [7] twice to highlight “R”.

③ Press [ENTER].

• To enter a space

Press [*] and press [ENTER].

• Add/recall names (→ below)

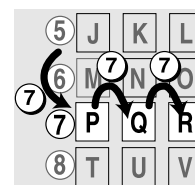

3 Press [■] (Set).

Returns to the previously displayed screen.

To end partway

Press [RETURN].

Text is not saved.

■ To add a name

You can add frequently used names and recall them later.

Maximum number of registered names: 20

Maximum number of characters per name: 20

After entering the name (→ above, steps 1–2).

1 Press [▶▶] while the name to be added is shown in the name field.

2 Press [◀] to select “Add” and press [ENTER].

To cancel adding word

Press [RETURN].

■ To recall an added name

1 Press [◀◀].

2 Press [▲, ▼, ◀, ▶] to select the name to be recalled and press [ENTER].

■ To delete an added name

1 Press [◀◀].

2 Press [▲, ▼, ◀, ▶] to select the name to be deleted and press [SUB MENU].

3 Press [ENTER].

4 Press [◀] to select “Delete” and press [ENTER].

5 Press [RETURN].

On the television

Page

Cannot finish recording completely.	<ul style="list-style-type: none"> The programme was copy-protected. The disc may be full. The maximum number of times you can record the programme is exceeded. 	— — —
Cannot record on the disc.	<ul style="list-style-type: none"> The disc may be dirty or scratched. 	4
Unable to format.		
Please check the disc.		
Cannot record. Disc is full.	<ul style="list-style-type: none"> Create space by deleting any unnecessary titles. RAM -RW(V) +RW (Even if you delete recorded content from DVD-R, DVD-R DL, +R or +R DL, there is no increase in disc space.) Use a new disc. 	31, 35, 36
Cannot record. Maximum numbers of titles exceeded.		
No disc	<ul style="list-style-type: none"> The disc may be upside down. 	—
This is a non-recordable disc.	<ul style="list-style-type: none"> The unit cannot record on the disc you inserted. Insert a DVD-RAM or unfinalized DVD-R, DVD-R DL, DVD-RW (DVD-Video format), +R, +R DL or +RW. You inserted an unformatted DVD-RAM, DVD-RW, +R, +R DL or +RW. Format the disc with this unit. 	6
This disc is not formatted properly.		36
⊘	<ul style="list-style-type: none"> The operation is prohibited by the unit or disc. 	—

On the unit's display

The following messages or service numbers appear on the unit's display when something unusual is detected during startup and use.

DVD □ ("□" stands for a number.)	<ul style="list-style-type: none"> The remote control and main unit are using different codes. Change the code on the remote control. Press and hold [ENTER] and the indicated number button at the same time for more than 2 seconds. 	15
HARD ERR ("HARD" and "ERR" are alternately displayed.)	<ul style="list-style-type: none"> If there is no change after turning the unit on and off, consult the dealer where the unit was purchased. 	—
NoREAD	<ul style="list-style-type: none"> The disc is dirty or badly scratched. The unit cannot record, play, or edit. This message may appear when the DVD lens cleaner has finished cleaning. Press [▲ OPEN/CLOSE] on the main unit to eject the disc. 	4 —
NoWRIT	<ul style="list-style-type: none"> Recording may be unavailable due to a disc problem. Use a new disc. The unit's "TV System" setting differs from the TV system used by the disc. Change the "TV System" in the Setup menu. 	— 43
NoERAS	<ul style="list-style-type: none"> Deleting an item may be unavailable due to a disc problem. Use a new disc. 	—
PLEASE WAIT ("PLEASE" and "WAIT" are alternately displayed.)	<ul style="list-style-type: none"> Displayed when the unit is started. This is not a malfunction. The unit is carrying out its recovery process. You cannot operate the unit while "PLEASE WAIT" is displayed. 	— —
PROG FULL ("PROG" and "FULL" are alternately displayed.)	<ul style="list-style-type: none"> There are already 16 timer programmes. Delete unnecessary timer programmes. 	22
UNSUPPORT ("UNSUP" and "PORT" are alternately displayed.)	<ul style="list-style-type: none"> You have inserted a disc the unit cannot play or record on. 	6, 7
UNFORMAT ("UNFOR" and "MAT" are alternately displayed.)	<ul style="list-style-type: none"> You have inserted a new DVD-RW/+R/+R DL/+RW or a DVD-RAM/DVD-RW (DVD-Video format) recorded on other equipment. 	36
U59	<ul style="list-style-type: none"> The unit is hot. The unit switches to standby for safety reasons. Wait for about 30 minutes until the message disappears. Select a position with good ventilation when installing the unit. Do not block the vent on the rear of the unit. 	—
U61	<ul style="list-style-type: none"> The unit detected an error while recording or playing with no disc in the disc tray. The unit is carrying out its recovery process. This process restores the unit to normal operation. The unit is not broken. Wait until the message disappears. 	—
U88	<ul style="list-style-type: none"> The unit detected an error while recording or playing with a disc in the disc tray. The unit is carrying out its recovery process. This process restores the unit to normal operation. The unit is not broken. Wait until the message disappears. 	46
U99	<ul style="list-style-type: none"> The unit fails to operate properly. Press [⊘/I] on the main unit to switch the unit to standby. Now press [⊘/I] on the main unit again to turn the unit on. 	—
X HOLD	<ul style="list-style-type: none"> The Child Lock function is activated. Press and hold [ENTER] and [RETURN] simultaneously until "X HOLD" disappears. 	38

Frequently asked questions

Set up		Page
What equipment is necessary to play multi channel surround sound?	<ul style="list-style-type: none"> • DVD-Video: You can play DVD-Video multi channel surround by digitally connecting an amplifier equipped with a Dolby Digital, DTS or MPEG decoder. • DVD-Audio: This unit plays DVD-Audio in 2 channels. You cannot play multi channel surround sound. 	11 —
Are the headphones and speakers directly connected to the unit?	<ul style="list-style-type: none"> • You cannot directly connect to the unit. Connect through the amplifier etc. 	11
The television has a Scart terminal and component video input terminal. Which terminal should I connect with?	<ul style="list-style-type: none"> • If you have a regular television (CRT: cathode ray tube), we recommend using the Scart terminal. You can enjoy high-quality RGB video from this unit by connecting to an RGB compatible television. If you have an LCD/plasma television or LCD projector compatible with progressive scan, connect through the component video terminals for high-quality progressive video. If you have a CRT television or a multi system television using PAL mode that is compatible with progressive scan, we cannot recommend progressive output as some flickering can occur. 	8–11
Is my television progressive output compatible?	<ul style="list-style-type: none"> • All Panasonic televisions that have 625 (576)/50i - 50p, 525 (480)/60i - 60p input terminals are compatible. Consult the manufacturer if you have another brand of television. 	—
Disc		
Can DVD-R, DVD-R DL, DVD-RW (DVD-Video Format), +R, +R DL and +RW recorded on this unit be played on other equipment?	<ul style="list-style-type: none"> • You can play on compatible equipment such as DVD players after finalizing the disc on this unit. It is not necessary to finalize +RW. However depending on the condition of the recording, the quality of the disc and capabilities of the DVD player, play may not be possible. 	37
Can I play DVD-Video, DVD-Audio and Video CDs bought in another country?	<ul style="list-style-type: none"> • You cannot play DVD-Video if their region number does not include "2" or "ALL". Refer to the disc's jacket for more information. 	Cover
Can a DVD-Video that does not have a region number be played?	<ul style="list-style-type: none"> • The DVD-Video region number indicates the disc conforms to a standard. You cannot play discs that do not have a region number. 	—
Please tell me about DVD-R, DVD-R DL, DVD-RW, +R, +R DL and +RW compatibility with this unit.	<ul style="list-style-type: none"> • This unit records and plays DVD-R, DVD-R DL, DVD-RW (DVD-Video format), +R, +R DL and +RW, and plays DVD-RW (VR format). • This unit also records and plays high speed recording compatible discs. • After recording but before finalizing +R, +R DL discs <ul style="list-style-type: none"> – You may not be able to play and record discs on this unit after recording them on other Panasonic products or other manufacturer's equipment. – You may not be able to play and record discs on other equipment after recording them on this unit. After finalizing the disc, however, you will be able to play it on any DVD-Video compatible player. 	6, 7 — —
Please tell me about CD-R and CD-RW compatibility with this unit.	<ul style="list-style-type: none"> • This unit plays CD-R/CD-RW discs (audio recording discs) which have been recorded under one of the following standards: CD-DA, Video CD, SVCD (conforming to IEC62107), MP3 and still pictures (JPEG/TIFF). Close the session after recording. • You cannot write to a CD-R or CD-RW with this unit. 	7, 26 —
Recording		
Can I record from a commercially purchased video cassette or DVD?	<ul style="list-style-type: none"> • Most commercially sold video cassettes and DVD are copy protected; therefore, recording is usually not possible. 	—
Can I record digital audio signals using this unit?	<ul style="list-style-type: none"> • You cannot record digital signals. The digital audio terminals on this unit are for output only. (The audio recorded using the unit's DV IN terminal from a digital video camcorder, for example, is recorded digitally.) 	—
Can a digital audio signal from this unit be recorded to other equipment?	<ul style="list-style-type: none"> • You can record if using the PCM signal. When recording DVD, change the "Digital Audio Output" settings to the following from the Setup menu. <ul style="list-style-type: none"> – PCM Down Conversion: On – Dolby Digital/DTS/MPEG: PCM However, only <ul style="list-style-type: none"> – As long as digital recording from the disc is permitted. – As long as the recording equipment is compatible with a sampling frequency of 48 kHz. • You cannot record MP3 signals. 	40 —
Can I switch to bilingual broadcast during recording?	<ul style="list-style-type: none"> • With DVD-RAM, you can. Just press [AUDIO]. This does not affect the actual recording of the audio. • With DVD-R, DVD-R DL, DVD-RW (DVD-Video format), +R, +R DL or +RW, you cannot. 	— —

Troubleshooting guide

Before requesting service, make the following checks. If you are in doubt about some of the check points, or if the remedies indicated in the chart do not solve the problem, consult your dealer for instructions.

The following do not indicate a problem with this unit:

- Regular disc rotating sounds.
- Poor reception due to atmospheric conditions.
- Image disturbance during search.
- Interruptions in reception due to periodic satellite broadcasting breaks.
- Operations do not work due to a poor-quality disc. (Try again using a Panasonic disc.)
- The unit freezes due to one of its safety devices being activated. (Press and hold [⏻] on the main unit for 10 seconds.)

Power	Page
No power. The unit does not turn on pressing [⏻ DVD]. The unit switches to the standby mode.	8-10 23 —

TV screen and video	Page
Television reception worsens after connecting the unit.	—
Status messages do not appear.	40
The grey background does not appear.	40
Picture does not appear during timer recording.	—
The 4:3 aspect ratio picture expands left and right.	29
Screen size is wrong.	14
There is a lot of after-image when playing video.	29
When playing DVD-Video using progressive output, one part of the picture momentarily appears to be doubled up.	29
There is no apparent change in picture quality when adjusted with the Picture menu in the on-screen menus.	—
The images from this unit do not appear on the television.	8-11
Picture is distorted.	— 43

Displays	Page
The display is dim.	40
"0:00" is flashing on the unit's display.	41
The clock is not correct.	41
The time recorded on the disc and the available time shown do not add up.	—
The play time shown for MP3 does not agree with the actual time.	—
"U88" is displayed and the disc cannot be ejected.	—

Sound	Page
No sound. Low volume. Distorted sound. Cannot hear the desired audio type.	8-11, 40 24 29 —
Cannot switch audio.	— 11, 40 —

Operation		Page
Cannot operate the television. The remote control doesn't work.	• Change manufacturer code. Some televisions cannot be operated even if you change the code.	15
	• The remote control and main unit are using different codes. Change the code on the remote control. Press and hold [ENTER] and the indicated number button at the same time for more than 2 seconds.	15
	• The batteries are depleted. Replace them with new ones.	7
	• You are not pointing the remote control at the main unit's remote control signal sensor during operation.	7
	• Coloured glass may obstruct the signal reception/transmission.	—
	• Don't place the signal sensor in direct sunlight or in areas that may be subject to sunlight exposure.	—
	• It may be necessary to set the code on the remote control again after changing the batteries.	15
	• It may be necessary to set the manufacturer code again after changing the batteries.	15
	• The child lock function is activated.	38
The unit is on but cannot be operated.	• Some operations may be prohibited by the disc.	—
	• The unit is hot ("U59" appears on the display). Wait for "U59" to disappear.	—
	• One of the unit's safety devices may have been activated. Reset the unit as follows: 1 Press [⏻] on the main unit to switch the unit to standby. If the unit doesn't switch to standby, press and hold [⏻] on the main unit for about 10 seconds. The unit is forcibly switched to standby. Alternatively, disconnect the AC mains lead, wait one minute, then reconnect it. 2 Press [⏻] on the main unit to switch it on. If the unit still cannot be operated, consult the dealer.	—
Cannot eject disc.	• Linked timer recordings with external equipment is in recording standby ("EXT-L" on the unit's display blinks when [⏻ DVD] is pressed). Press [EXT LINK] to cancel the recording standby.	23
	• The unit is recording.	—
	• The unit may have a problem. While the unit is off, press and hold [■] and [CH ^] on the main unit at the same time for about 5 seconds. Remove the disc and consult the dealer.	—
	• If the Child Lock function is activated, above operation does not work. Cancel the Child Lock function.	38
Cannot tune channels. Cannot download the tuning positions.	• Check the connections.	8-10
	• You must connect to a television equipped with the Q Link function with a fully wired 21-pin Scart lead to download channel presets.	8-10
Startup is slow.	• Startup is slow if the clock is not set, there was a power failure or the AC plug has just been connected.	—
	• Twenty to 30 seconds after turning on the unit, you can play a disc or start recording to discs other than DVD-RAM.	—
	• Startup takes time for a few minutes after 5:15 am due to system maintenance of this unit.	—
Takes time to read DVD-RAM.	• It may take time to read a disc if it is being used for the first time in this unit or it has not been used for a long time.	—

Recording, timer recording and copying

Cannot record.	• You haven't inserted a disc or the disc you inserted cannot be recorded on. Insert a disc the unit can record onto.	6
	• The disc is unformatted. Format the disc. [RAM] [-RW(V)] [+R] [+R DL] [+RW]	36
	• The write-protect tab on the cartridge is set to PROTECT, or the disc is protected with DVD Management.	36
	• Some programmes have limitations on the number of times they can be recorded. (CPRM)	49
	• You cannot record when there is not enough space or when the number of titles has reached its limit. Delete unwanted titles or use a new disc.	31, 35, 36
	• You cannot record on finalized DVD-R, DVD-R DL, DVD-RW (DVD-Video format), +R, +R DL or DVD-RW (VR format) discs.	—
	• Due to peculiarities of DVD-R, DVD-R DL, DVD-RW (DVD-Video format), +R, +R DL or +RW, you may be unable to record onto them if you either insert and remove the disc or switch the unit on and off while a disc is loaded, a total of fifty times.	—
	• DVD-R, DVD-R DL, DVD-RW (DVD-Video format), +R, +R DL or +RW recorded on this unit may not be recordable on other Panasonic DVD recorders.	—
Cannot record from external equipment.	• Check that the connection is correct.	8-10, 34
	• Select the input channel ("AV2", "AV3" or "DV") for the equipment you have connected.	—
Timer recording does not work properly.	• The timer programme is incorrect or different timer programme times overlap. Correct the programme.	22
VIDEO Plus+ programming does not work properly.	• The unit or the timer programme is not on timer recording standby. ("⏻" on the unit's display or the timer icon in the timer recording list is not on.) Put the unit and the timer programme on timer recording standby.	20, 21
	• Set the clock.	41
Timer recording does not stop even when [■] is pressed.	• When this unit is on, press [■]. A dialog appears, so press [◀▶] to select "Stop Recording" and press [ENTER].	21
	• When using the linked timer recording with external equipment, press [EXT LINK]. ("EXT-L" disappears.)	23
The timer programme remains even after recording finishes.	• The timer programme remains if set to daily or weekly.	21
A part or whole of a recorded title has been lost.	• If there is a power failure or the plug is disconnected from the household AC mains socket while recording or editing, the title may be lost or the disc may become unusable. You will have to format the disc ([RAM] [-RW(V)] [+RW]) or use a new disc. We cannot offer any guarantee regarding lost programmes or discs.	—
The DV automatic recording function does not work.	• If images cannot be recorded or if the recording is aborted, check the connections and DV equipment settings.	34
	• You cannot start recording until the images from the DV equipment appear on the television.	—
	• Recording may not be performed as desired if the time codes on the tape in the DV equipment are not successive.	—
	• Depending on the equipment, the DV automatic recording may not operate properly.	—
	• You can only record audio/video images on a DV tape.	—

Play		Page
Play fails to start even when [▶] (PLAY) is pressed. Play starts but then stops immediately.	• Insert the disc correctly with the label facing up.	18
	• The disc is dirty.	4
	• You tried to play a blank disc or disc unplayable on this unit.	6, 7
	• You tried to play a +RW that needs to be finalized on the equipment used for recording.	—
	• When recording to DVD-RAM using EP (8Hours) mode, play may not be possible on DVD players that are compatible with DVD-RAM. In this case use EP (6Hours) mode.	39
Audio and video momentarily pause.	• This occurs between playlist chapters.	—
	• This occurs as scenes change during Quick View.	—
DVD-Video is not played.	• You have set a ratings level to limit DVD-Video play. Change this setting.	39
Alternative soundtrack and subtitles cannot be selected.	• The languages are not recorded on the disc.	—
	• You may have to use the disc's menus to select languages.	24
No subtitles.	• Subtitles are not recorded on the disc.	—
	• Set "Subtitle" on the on-screen menu to "On".	28
Angle cannot be changed.	• Angles can only be changed during scenes where different angles are recorded.	—
You have forgotten your ratings password.	• While the disc tray is open, press and hold [● REC] and [▶ x1.3] on the main unit at the same time for 5 or more seconds ("INIT" will appear on the unit's display). The ratings level returns to "8".	—
Quick View does not work.	• This does not work when audio is other than Dolby Digital.	—
	• This does not work when recording in XP or FR mode.	—
The resume play function does not work.	• Memorized positions are cancelled when the unit is turned off or when the tray is opened. The memorized position on the playlist is also cancelled when the playlist and title are edited.	—
The Video CD picture does not display properly.	• When connecting to Multi-system TV, select "NTSC" in "TV System" in the Setup menu.	43
	• When connecting to PAL TV, the lower part of the picture cannot be displayed correctly during search.	—
Time Slip does not work.	• Time Slip does not work when the unit's "TV System" settings are different from the title recorded on the disc.	43
When playing PAL disc, picture distorted.	• Set "Transfer" in Picture menu to "Auto".	29

Edit

Cannot format.	• The disc is dirty. Wipe with a damp cloth and then wipe dry.	4
	• You tried formatting a disc that is not compatible with this unit.	6, 7
Cannot create chapters.	• The unit writes the chapter information to the disc when you turn it off or remove the disc. The information is not written if there is an interruption to the power before this.	—
Cannot mark the start point or the end point during "Partial Delete" operation.	• These operations are not possible with still pictures.	—
	• You cannot set points if they are too close to each other. You cannot set an end point before a start point.	—
Cannot delete chapters.	• When the chapter is too short to delete, use "Combine Chapters" to make the chapter longer.	31
The available recording space doesn't increase even after deleting recordings on the disc.	• Available recording space on DVD-R, DVD-R DL, +R or +R DL does not increase even after deleting previously recorded titles.	—
	• Available recording space on DVD-RW (DVD-Video format) or +RW increases only when the last recorded title is deleted. It does not increase if other titles are deleted.	—
Cannot create a playlist.	• You cannot select all the chapters at once in a title if the title also includes still pictures. Select them individually.	—

To reset this unit

To return all the settings other than the main ones to the factory preset.	• Select "Yes" in "Shipping Condition" in the Setup menu. All the settings except for the ratings level, ratings password, Owner ID and time settings return to the factory preset. The timer recording programmes are also cancelled.	41
	• Select "Yes" in "Default Settings" in the Setup menu. All the settings other than the programmed channels, time settings, disc language settings, ratings level, ratings password, Owner ID and remote control code return to the factory presets.	41
	• Press and hold [∨ CH] and [CH ∧] on the main unit for about 5 seconds. All the settings except for the ratings level, ratings password, Owner ID and time settings return to the factory preset. The timer recording programmes are also cancelled.	—
To reset the ratings level settings.	• While the disc tray is open, press and hold [● REC] and [▶ x1.3] on the main unit at the same time for 5 or more seconds.	—
To restore the unit if it freezes due to one of the safety devices being activated.	• Press and hold [⏻/⏹] on the main unit for 10 seconds. (The settings remain.)	—

Bitstream

This is the digital form of multi-channel audio data (e.g., 5.1 channel) before it is decoded into its various channels.

Component video output

Component signal outputs the colour difference signals (P_B/P_R) and luminance signal (Y) separately in order to achieve high fidelity in reproducing colours. If the television is compatible with progressive output, a high quality picture can be output because this unit's component video output terminal outputs a progressive output signal.

CPRM (Content Protection for Recordable Media)

CPRM is technology used to protect broadcasts that are allowed to be recorded only once. Such broadcasts can be recorded only with CPRM compatible recorders and discs.

Dolby Digital

This is a method of coding digital signals developed by Dolby Laboratories. Apart from stereo (2-channel) audio, these signals can also be multi-channel audio. A large amount of audio information can be recorded on one disc using this method.

Down-mixing

This is the process of remixing the multi-channel audio found on some discs into two channels for stereo output. It is useful when you want to listen to the 5.1-channel audio recorded on DVDs through your television's speakers. Some discs prohibit down-mixing and this unit can then only output the front two channels.

DTS (Digital Theater Systems)

This surround system is used in many movie theaters. There is good separation between the channels, so realistic sound effects are possible.

Dynamic range

Dynamic range is the difference between the lowest level of sound that can be heard above the noise of the equipment and the highest level of sound before distortion occurs. Dynamic range compression means reducing the gap between the loudest and softest sounds. This means you can listen at low volumes but still hear dialog clearly.

Film and video

DVD-Videos are recorded using either film or video. This unit can determine which type has been used, then uses the most suitable method of progressive output.

Film:

Recorded at 25 frames per second (PAL discs) or 24 frames per second (NTSC discs). (NTSC discs recorded at 30 frames per second as well.) Generally appropriate for motion picture films.

Video:

Recorded at 25 frames/50 fields per second (PAL discs) or 30 frames/60 fields per second (NTSC discs). Generally appropriate for TV drama programmes or animation.

Finalize

A process that makes play of a recorded CD-R, CD-RW, DVD-R etc. possible on equipment that can play such media. You can finalize DVD-R, DVD-R DL, DVD-RW (DVD-Video format), +R or +R DL on this unit.

After finalizing, the disc becomes play-only and you can no longer record or edit. However, finalized DVD-RW can be formatted to become recordable.

Formatting

Formatting is the process of making media such as DVD-RAM recordable on recording equipment.

You can format DVD-RAM, DVD-RW (only as DVD-Video format), +R, +R DL or +RW on this unit.

When you use a new DVD-RW, +R, +R DL or +RW, it must be formatted.

Formatting deletes irrevocably all contents.

Frames and fields

Frames refer to the single images that constitute the video you see on your television. Each frame consists of two fields.

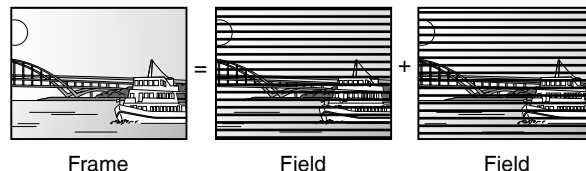

- A frame still shows two fields, so there may be some blurring, but picture quality is generally better.
- A field still shows less picture information so it may be rougher, but there is no blurring.

JPEG (Joint Photographic Experts Group)

This is a system used for compressing/decoding colour still pictures. If you select JPEG as the storage system on digital cameras etc., the data will be compressed to 1/10–1/100 of its original size. The feature of JPEG is less deterioration in picture quality considering the degree of compression.

MP3 (MPEG Audio Layer 3)

An audio compression method that compresses audio to approximately one tenth of its size without any considerable loss of audio quality. You can play MP3 you have recorded onto DVD-R, CD-R and CD-RW.

Pan & Scan/Letterbox

In general, DVD-Video are produced with the intention that they be viewed on a widescreen television (16:9 aspect ratio), so images often don't fit regular (4:3 aspect ratio) televisions. Two styles of picture, "Pan & Scan" and "Letterbox", deal with this problem.

Pan & Scan: The sides are cut off so the picture fills the screen.



Letterbox: Black bands appear at the top and bottom of the picture so the picture itself appears in an aspect ratio of 16:9.



Playback control (PBC)

If a Video CD has playback control, you can select scenes and information with menus.

(This unit is compatible with version 2.0 and 1.1.)

Progressive/Interlace

The PAL video signal standard has 625 (or 576) interlaced (i) scan lines, whereas progressive scanning, called 625p (or 576p), uses twice the number of scan lines. For the NTSC standard, these are called 525i (or 480i) and 525p (or 480p) respectively.

Using progressive output, you can enjoy the high-resolution video recorded on media such as DVD-Video.

Your television must be compatible to enjoy progressive video.

Panasonic televisions with 625 (576)/50i · 50p, 525 (480)/60i · 60p input terminals are progressive compatible.

Protection

You can prevent accidental deletion by setting writing protection or deletion protection.

RGB

This refers to the three primary colours of light, red (R), green (G), and blue (B) and also the method of producing video that uses them. By dividing the video signal into the three colours for transmission, noise is reduced for even higher quality images.

Sampling frequency

Sampling is the process of converting the heights of sound wave (analogue signal) samples taken at set periods into digits (digital encoding). Sampling frequency is the number of samples taken per second, so larger numbers mean more faithful reproduction of the original sound.

Thumbnail

This refers to a miniature representation of a picture used to display multiple pictures in the form of a list.

TIFF (Tag Image File Format)

This is a system used for compressing/decoding colour still pictures. A common format for storing high quality images on digital cameras and other devices.

Specifications

Recording System

DVD-RAM: DVD Video Recording format
 DVD-R: DVD-Video format
 DVD-R DL (Dual Layer): DVD-Video format
 DVD-RW: DVD-Video format
 +R
 +R DL (Double Layer)
 +RW

Recording time

Maximum 8 hours (using 4.7 GB disc)
 XP: Approx. 1 hour SP: Approx. 2 hours
 LP: Approx. 4 hours EP: Approx. 6 hours/8 hours

Recordable discs

DVD-RAM: Ver. 2.0
 Ver. 2.1/3x-SPEED DVD-RAM Revision 1.0
 Ver. 2.2/5x-SPEED DVD-RAM Revision 2.0
 DVD-R: for General Ver. 2.0
 for General Ver. 2.0/4x-SPEED DVD-R Revision 1.0
 for General Ver. 2.x/8x-SPEED DVD-R Revision 3.0
 for General Ver. 2.x/16x-SPEED DVD-R Revision 6.0
 for DL Ver. 3.0
 DVD-RW: for DL Ver. 3.x/4x-SPEED DVD-R for DL Revision 1.0
 Ver. 1.1
 Ver. 1.x/2x-SPEED DVD-RW Revision 1.0
 Ver. 1.x/4x-SPEED DVD-RW Revision 2.0
 Ver. 1.x/6x-SPEED DVD-RW Revision 3.0
 +R: Ver. 1.0
 Ver. 1.1
 Ver. 1.2
 Ver. 1.3
 for DL Ver. 1.0
 +RW: Ver. 1.1
 Ver. 1.2/4x-SPEED

Playable discs

DVD-RAM (DVD Video Recording format), DVD-R (DVD-Video format, MP3, JPEG), DVD-R DL (Dual Layer) (DVD-Video format), DVD-RW (DVD-Video format, DVD Video Recording format), +R, +R DL (Double Layer), +RW, DVD-Video, DVD-Audio, CD-Audio (CD-DA), Video CD, CD-R/RW (CD-DA, Video CD, SVCD^{*1}, MP3, JPEG formatted discs), SVCD^{*1}

^{*1} Conforming to IEC62107.

Quick Start for Recording

1 Sec. Quick Start for Recording on DVD-RAM^{*2}

^{*2} From the power off state, recording on DVD-RAM starts about 1 second after first pressing the Power button and then sequentially pressing the REC button.

Video

Video System: PAL colour signal, 625 lines, 50 fields
 NTSC colour signal, 525 lines, 60 fields
 Recording System: MPEG2 (Hybrid VBR)
 Video In (SECAM/PAL/NTSC): AV1/AV2 (21 pin), AV3 (pin jack) 1 Vp-p 75 Ω, termination
 S-Video In (SECAM/PAL/NTSC): AV2 (21 pin), AV3 (S terminal) 1 Vp-p 75 Ω, termination
 Video Out (PAL/NTSC): AV1/AV2 (21 pin), Video Out (pin jack) 1 Vp-p 75 Ω, termination
 S-Video Out (PAL/NTSC): AV1 (21 pin), S-Video Out (S terminal) 1 Vp-p 75 Ω, termination
 RGB Out (PAL/NTSC): AV1 (21 pin) 0.7 Vp-p (PAL) 75 Ω, termination
 Component video output (NTSC 480p/480i, PAL 576p/576i)
 Y: 1.0 Vp-p 75 Ω, termination
 Pb: 0.7 Vp-p 75 Ω, termination
 Pr: 0.7 Vp-p 75 Ω, termination

Audio

Recording System: Dolby Digital 2ch
 Audio In: AV1/AV2 (21 pin), AV3 (pin jack)
 Input Level: Standard: 0.5 Vrms, Full scale: 2.0 Vrms at 1 kHz
 Input Impedance: More than 10 kΩ
 Audio Out: AV1/AV2 (21 pin), Audio Out (pin jack)
 Output Level: Standard: 0.5 Vrms, Full scale: 2.0 Vrms at 1 kHz
 Output Impedance: Less than 1 kΩ
 Digital Audio Out: Optical terminal (PCM, Dolby Digital, DTS, MPEG)

Television System

Tuner System: PAL-I
 Channel Coverage:
The United Kingdom UHF: CH 21-68
Republic of Ireland VHF: CH 4-13, A-J
 UHF: CH 21-68
 RF Converter Output: Not provided
Optical pick-up System with 1 lens, 2 integration units
 (662 nm wavelength for DVDs,
 780 nm wavelength for CDs)

LASER Specification

Class 1 LASER Product
 Wave Length: 780 nm (CDs), 662 nm (DVDs)
 Laser Power:

No hazardous radiation is emitted with the safety protection
 IEEE 1394 Standard, 4 pin: 1 pc

DV Input

Others

Region Code: # 2
 Operating temperature: 5 °C-40 °C
 Operating humidity range: 10 %-80 % RH (no condensation)
 Power supply: AC 220 V-240 V, 50 Hz
 Power consumption: Approx. 22 W
 Dimensions (WxDxH): 430 mm x 316 mm x 58 mm
 Mass: 3.2 kg

Note

Specifications are subject to change without notice.
 Mass and dimensions are approximate.

Language code list Enter the code with the numbered buttons.

Abkhazian: 6566	Catalan: 6765	Gujarati: 7185	Lingala: 7678	Rhaeto-Romance: 8277	Tamil: 8465
Afar: 6565	Chinese: 9072	Hausa: 7265	Lithuanian: 7684	Romanian: 8279	Tatar: 8484
Afrikaans: 6570	Corsican: 6779	Hebrew: 7387	Macedonian: 7775	Russian: 8285	Telugu: 8469
Albanian: 8381	Croatian: 7282	Hindi: 7273	Malagasy: 7771	Samoan: 8377	Thai: 8472
Ameharic: 6577	Czech: 6783	Hungarian: 7285	Malay: 7783	Sanskrit: 8365	Tibetan: 6679
Arabic: 6582	Danish: 6865	Icelandic: 7383	Malayalam: 7776	Scots Gaelic: 7168	Tigrinya: 8473
Armenian: 7289	Dutch: 7876	Indonesian: 7378	Maltese: 7784	Serbian: 8382	Tonga: 8479
Assamese: 6583	English: 6978	Interlingua: 7365	Maori: 7773	Serbo-Croatian: 8372	Turkish: 8482
Aymara: 6589	Esperanto: 6979	Irish: 7165	Marathi: 7782	Shona: 8378	Turkmen: 8475
Azerbaijani: 6590	Estonian: 6984	Italian: 7384	Moldavian: 7779	Sindhi: 8368	Twi: 8487
Bashkir: 6665	Faroese: 7079	Japanese: 7465	Mongolian: 7778	Singhalese: 8373	Ukrainian: 8575
Basque: 6985	Fiji: 7074	Javanese: 7487	Nauru: 7865	Slovak: 8375	Urdu: 8582
Bengali; Bangla: 6678	Finnish: 7073	Kannada: 7578	Nepali: 7869	Slovenian: 8376	Uzbek: 8590
Bhutani: 6890	French: 7082	Kashmiri: 7583	Norwegian: 7879	Somali: 8379	Vietnamese: 8673
Bihari: 6672	Frisian: 7089	Kazakh: 7575	Oriya: 7982	Spanish: 6983	Volapük: 8679
Breton: 6682	Galician: 7176	Kirghiz: 7589	Pashto, Pushto: 8083	Sundanese: 8385	Welsh: 6789
Bulgarian: 6671	Georgian: 7565	Korean: 7579	Persian: 7065	Swahili: 8387	Wolof: 8779
Burmese: 7789	German: 6869	Kurdish: 7585	Polish: 8076	Swedish: 8386	Xhosa: 8872
Byelorussian: 6669	Greek: 6976	Laotian: 7679	Portuguese: 8084	Tagalog: 8476	Yiddish: 7473
Cambodian: 7577	Greenlandic: 7576	Latin: 7665	Punjabi: 8065	Tajik: 8471	Yoruba: 8979
	Guarani: 7178	Latvian, Lettish: 7686	Quechua: 8185	Zulu: 9085	

CAUTION!

THIS PRODUCT UTILIZES A LASER.
 USE OF CONTROLS OR ADJUSTMENTS OR PERFORMANCE OF PROCEDURES OTHER THAN THOSE SPECIFIED HEREIN MAY RESULT IN HAZARDOUS RADIATION EXPOSURE.
 DO NOT OPEN COVERS AND DO NOT REPAIR YOURSELF.
 REFER SERVICING TO QUALIFIED PERSONNEL.

CAUTION!

- DO NOT INSTALL OR PLACE THIS UNIT IN A BOOKCASE, BUILT-IN CABINET OR IN ANOTHER CONFINED SPACE. ENSURE THE UNIT IS WELL VENTILATED. TO PREVENT RISK OF ELECTRIC SHOCK OR FIRE HAZARD DUE TO OVERHEATING, ENSURE THAT CURTAINS AND ANY OTHER MATERIALS DO NOT OBSTRUCT THE VENTILATION VENTS.
- DO NOT OBSTRUCT THE UNIT'S VENTILATION OPENINGS WITH NEWSPAPERS, TABLECLOTHS, CURTAINS, AND SIMILAR ITEMS.
- DO NOT PLACE SOURCES OF NAKED FLAMES, SUCH AS LIGHTED CANDLES, ON THE UNIT.
- DISPOSE OF BATTERIES IN AN ENVIRONMENTALLY FRIENDLY MANNER.

WARNING:

TO REDUCE THE RISK OF FIRE, ELECTRIC SHOCK OR PRODUCT DAMAGE, DO NOT EXPOSE THIS APPARATUS TO RAIN, MOISTURE, DRIPPING OR SPLASHING AND THAT NO OBJECTS FILLED WITH LIQUIDS, SUCH AS VASES, SHALL BE PLACED ON THE APPARATUS.

THIS UNIT IS INTENDED FOR USE IN MODERATE CLIMATES.
 (→ page 50, Specifications—Others)

This product may receive radio interference caused by mobile telephones during use. If such interference is apparent, please increase separation between the product and the mobile telephone.

The socket outlet shall be installed near the equipment and easily accessible or the mains plug or an appliance coupler shall remain readily operable.



(Back of product)

DANGER – VISIBLE AND INVISIBLE LASER RADIATION WHEN OPEN. AVOID DIRECT EXPOSURE TO BEAM. FDA 21 CFR/Class IIIb	
注意	— 打开时有可见及不可见激光辐射。避免光束照射。
注意	— ここを開くと可視及び不可視レーザー光が出ます。ビームを見たり、触れたりしないでください。
CAUTION – CLASS 3B VISIBLE AND INVISIBLE LASER RADIATION WHEN OPEN. AVOID EXPOSURE TO THE BEAM. IEC60825-1+A2/Class 3B	
ATTENTION – RAYONNEMENT LASER VISIBLE ET INVISIBLE, CLASSE 3B, EN CAS D'OUVERTURE, ÉVITER UNE EXPOSITION AU FAISCEAU	
FORSIGTIG – SYNLIG OG USYNLIG LASERSTRÅLING KLASSE 3B, NÅR LÅGET ER ÅBENT, UNDGÅ AT BLIVE UDSAT FOR STRÅLEN.	
VARO – AVATTAESSA OLET ALTIINNA LUOKAN 3B NÄKYVÄÄ JA NÄKYMÄTÖNTÄ LASERSTRÄLTYÄ. VÄRÖ ALITUMISTA SAATELLE.	
VARNING – KLASSE 3B SYNLIG OCH OSYNLIG LASERSTRÅLNING NÄR DENNA DEL ÄR ÖPPNAD. UNDVIK EXPOSITION FÖR STRÅLEN.	
VORSICHT – SICHTBARE UND UNSICHTBARE LASERSTRÄHLUNG KLASSE 3B, WENN ABDECKUNG GEÖFFNET, NICHT DEM STRAHL AUSSETZEN.	
CAUTION – VISIBLE AND INVISIBLE LASER RADIATION WHEN OPEN. AVOID EXPOSURE TO THE BEAM. IEC60825-1	
ATTENTION – RAYONNEMENT LASER VISIBLE ET INVISIBLE EN CAS D'OUVERTURE. EXPOSITION DANGEREUSE AU FAISCEAU.	
ADVARSEL – SYNLIG OG USYNLIG LASERSTRÅLING VED ÅBNING. UNDGÅ UDSÆTTELSE FOR STRÅLING.	
VARO! – AVATTAESSA OLET ALTIINNA NÄKYVÄÄ JA NÄKYMÄTÖN LASERSTRÄLTYLLE. ÄLÄ KATSO SAATEESEN.	
VARNING – SYNLIG OCH OSYNLIG LASERSTRÅLNING NÄR DENNA DEL ÄR ÖPPNAD. BETRÄKTA EJ STRÅLEN.	
VORSICHT – SICHTBARE UND UNSICHTBARE LASERSTRÄHLUNG, WENN ABDECKUNG GEÖFFNET, NICHT DEM STRAHL AUSSETZEN.	
ADVARSEL – SYNLIG OG USYNLIG LASERSTRÅLING NÄR DEKSEL ÅPNES. UNNSÅ EKSPONERING FOR STRÅLEN. VOL 1.167	

(Inside of product)

- For your safety, be sure not to connect or handle the equipment with wet hands.
- Your attention is drawn to the fact that recording pre-recorded tapes or discs or other published or broadcast material may infringe copyright laws.

Do not place the unit on amplifiers or equipment that may become hot.

The heat can damage the unit.

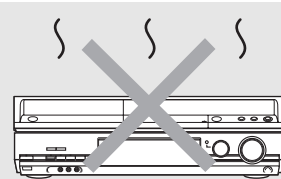

-If you see this symbol-

Information on Disposal for Users of Waste Electrical & Electronic Equipment (private households)



This symbol on the products and/or accompanying documents means that used electrical and electronic products should not be mixed with general household waste. For proper treatment, recovery and recycling, please take these products to designated collection points, where they will be accepted on a free of charge basis. Alternatively, in some countries you may be able to return your products to your local retailer upon the purchase of an equivalent new product.

Disposing of this product correctly will help to save valuable resources and prevent any potential negative effects on human health and the environment which could otherwise arise from inappropriate waste handling. Please contact your local authority for further details of your nearest designated collection point.

Penalties may be applicable for incorrect disposal of this waste, in accordance with national legislation.

For business users in the European Union

If you wish to discard electrical and electronic equipment, please contact your dealer or supplier for further information.

Information on Disposal in other Countries outside the European Union

This symbol is only valid in the European Union.

If you wish to discard this product, please contact your local authorities or dealer and ask for the correct method of disposal.

Index

Angle	28	DV automatic recording	34	Properties	
Audio		DVD-RAM, DVD-R, DVD-R DL,		playlist	33
attribute	28	DVD-RW, +R, +R DL, +RW . . .	6, 16	still picture	27
language	28			title	31
playback	24	Enter name		Protection	
AV-in NR	29	disc	36	cartridge	36
		entering text	43	disc	36
Change Thumbnail	31	playlist	33	title	31
Channel		title	20, 21, 31	Q Link	38
audio	28	EXT LINK	23, 41	Quick Start	18
settings	12, 42	Finalize	37, 49	Quick View	25
Chapter	25, 30	Flexible Recording	19		
Chasing playback	19	Format disc	36	Ratings level	39
Child Lock	38	FR (Flexible Recording)		Recording	
Cleaning		Mode	17, 19	Direct TV Recording	38
disc	4	FUNCTIONS window	2, 29	DV automatic recording . . .	34
lens	4			External Link	23
main unit	4	JPEG	26, 27, 49	Flexible Recording	19
Clock settings	41			mode	17
Close First Layer	37	Language		timer	20
Connection		code list	50	Remote control code	15
aerial	8, 9, 10	soundtrack	28, 39	Repeat play	28
amplifier, system component .	11	subtitle	28, 39	Resetting channel setting . . .	42
AV3 input terminals	34			Resume play function	25
DV IN terminal	34	Manual Skip	25	RGB	40, 49
satellite/digital terrestrial		Menu			
receiver	9	JPEG	27	Setup menu	39
television	8, 9, 10, 11	MP3	26	Shipping Condition	41
video cassette recorder .	10, 34	on-screen	28	Simultaneous rec and play . . .	19
Copy (playlist)	33	Setup	39	Soundtrack	28
Copying		Mode		Status messages	29
DV automatic recording . . .	34	recording	17	Subtitle	28
from a video cassette		still mode	39		
recorder	34	MP3	26, 49	Teletext	18
Manual recording	34	Noise reduction (NR)		Thumbnail	31
CPRM	49	AV-in NR	29	TIFF	26, 27, 49
Create Chapter	25, 31, 33	Playback NR	29	Time Slip	25
Create playlists	32			Timer recording	20
Create Top Menu	37	On-screen		Transfer	29
		menus	28	Tuning	
Default Settings	41	status messages	29	manual	42
Delete		Owner ID	12, 41	settings	12, 42
all titles	36	Partial Delete	31	TV aspect	14, 40
chapter	31, 33	PCM Down Conversion	40	TV System (PAL/NTSC)	43
playlist	33	Picture settings	29, 39	VIDEO Plus+	20
title	31, 35	Playback NR	29	V.S.S.	29
Delete Navigator	35	Playlist	32		
Dialog Enhancer	29	Progressive	14, 29, 40, 49		
Direct Navigator	24				
Direct TV Recording	38				
Divide Title	31				

Manufactured under license from Dolby Laboratories. "Dolby" and the double-D symbol are trademarks of Dolby Laboratories.

"DTS" and "DTS 2.0 + Digital Out" are trademarks of Digital Theater Systems, Inc.

VIDEO Plus+ and PlusCode are registered trademarks of Gemstar Development Corporation.
The VIDEO Plus+ system is manufactured under license from Gemstar Development Corporation.

MPEG Layer-3 audio decoding technology licensed from Fraunhofer IIS and Thomson multimedia.

This product incorporates copyright protection technology that is protected by method claims of certain U.S. patents and other intellectual property rights owned by Macrovision Corporation and other rights owners. Use of this copyright protection technology must be authorized by Macrovision Corporation, and is intended for home and other limited viewing uses only unless otherwise authorized by Macrovision Corporation. Reverse engineering or disassembly is prohibited.

Matsushita Electric Industrial Co., Ltd.
Web Site: <http://www.panasonic.co.jp/global/>

En

RQT8320-1B

H1205XB1026

Free Manuals Download Website

<http://myh66.com>

<http://usermanuals.us>

<http://www.somanuals.com>

<http://www.4manuals.cc>

<http://www.manual-lib.com>

<http://www.404manual.com>

<http://www.luxmanual.com>

<http://aubethermostatmanual.com>

Golf course search by state

<http://golfingnear.com>

Email search by domain

<http://emailbydomain.com>

Auto manuals search

<http://auto.somanuals.com>

TV manuals search

<http://tv.somanuals.com>