

# Panasonic®

## Operating Instructions

### DVD Recorder

Model No. **DMR-ES16**

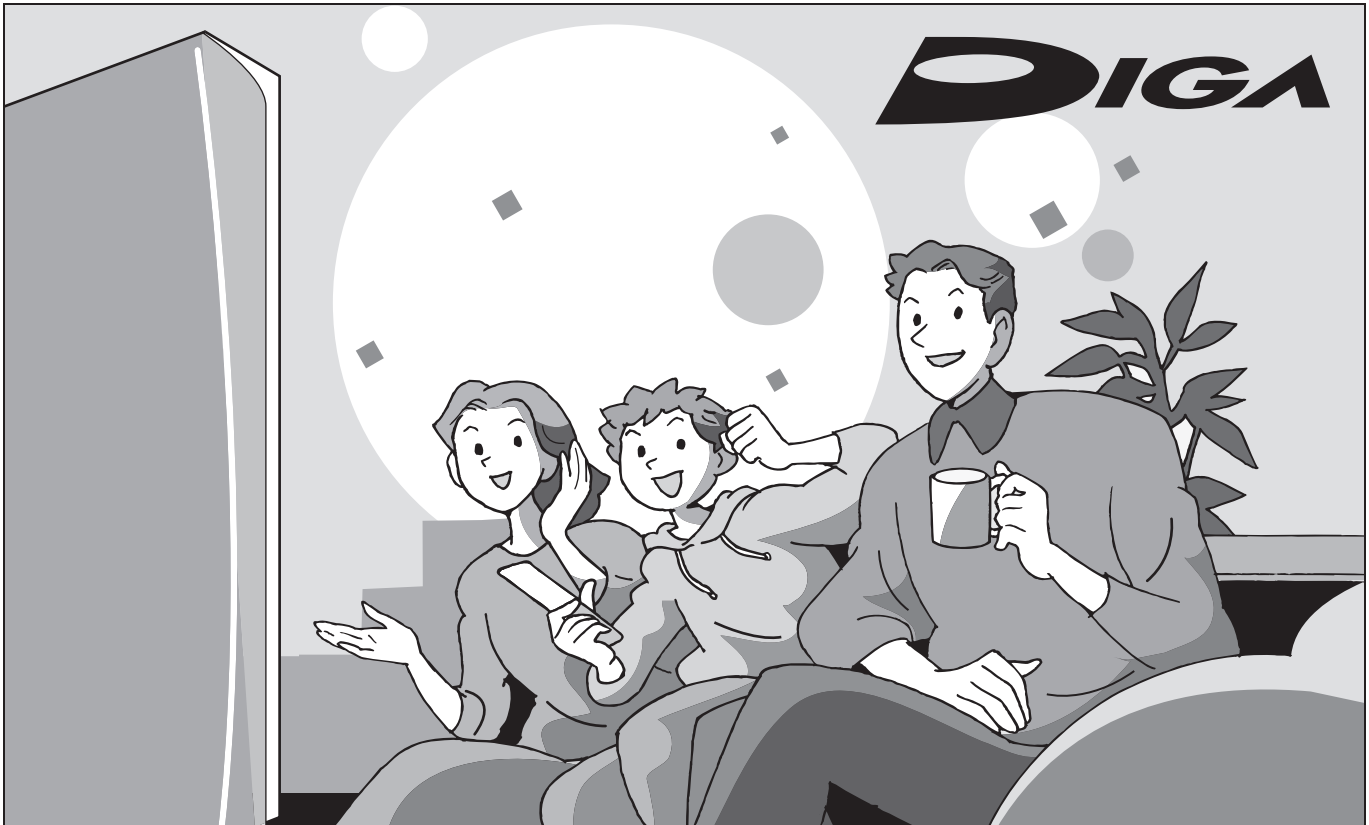

### Dear customer

Thank you for purchasing this product. For optimum performance and safety, please read these instructions carefully.

Before connecting, operating or adjusting this product, please read the instructions completely.

Please keep this manual for future reference.

#### Region number supported by this unit

Region numbers are allocated to DVD players and software according to where they are sold.

- The region number of this unit is "1".
- The unit will play DVDs marked with labels containing "1" or "ALL".

Example:



If you have any questions contact  
1-800-561-5505

The warranty can be found on page 47.

PC (En) Cf

RQT8950-Y  
H0107FJ0

## CAUTION!

THIS PRODUCT UTILIZES A LASER.  
USE OF CONTROLS OR ADJUSTMENTS OR PERFORMANCE OF PROCEDURES OTHER THAN THOSE SPECIFIED HEREIN MAY RESULT IN HAZARDOUS RADIATION EXPOSURE. DO NOT OPEN COVERS AND DO NOT REPAIR YOURSELF. REFER SERVICING TO QUALIFIED PERSONNEL.

## CAUTION!

DO NOT INSTALL OR PLACE THIS UNIT IN A BOOKCASE, BUILT-IN CABINET OR IN ANOTHER CONFINED SPACE. ENSURE THE UNIT IS WELL VENTILATED. TO PREVENT RISK OF ELECTRIC SHOCK OR FIRE HAZARD DUE TO OVERHEATING, ENSURE THAT CURTAINS AND ANY OTHER MATERIALS DO NOT OBSTRUCT THE VENTILATION VENTS.

## WARNING:

TO REDUCE THE RISK OF FIRE, ELECTRIC SHOCK OR PRODUCT DAMAGE,

- DO NOT EXPOSE THIS APPARATUS TO RAIN, MOISTURE, DRIPPING OR SPLASHING AND THAT NO OBJECTS FILLED WITH LIQUIDS, SUCH AS VASES, SHALL BE PLACED ON THE APPARATUS.
- USE ONLY THE RECOMMENDED ACCESSORIES.
- DO NOT REMOVE THE COVER (OR BACK); THERE ARE NO USER SERVICEABLE PARTS INSIDE. REFER SERVICING TO QUALIFIED SERVICE PERSONNEL.



**CAUTION**  
RISK OF ELECTRIC SHOCK  
DO NOT OPEN



CAUTION: TO REDUCE THE RISK OF ELECTRIC SHOCK, DO NOT REMOVE SCREWS. NO USER-SERVICEABLE PARTS INSIDE. REFER SERVICING TO QUALIFIED SERVICE PERSONNEL.



The lightning flash with arrowhead symbol, within an equilateral triangle, is intended to alert the user to the presence of uninsulated "dangerous voltage" within the product's enclosure that may be of sufficient magnitude to constitute a risk of electric shock to persons.



The exclamation point within an equilateral triangle is intended to alert the user to the presence of important operating and maintenance (servicing) instructions in the literature accompanying the appliance.

# IMPORTANT SAFETY INSTRUCTIONS

Read these operating instructions carefully before using the unit. Follow the safety instructions on the unit and the applicable safety instructions listed below. Keep these operating instructions handy for future reference.

- 1) Read these instructions.
- 2) Keep these instructions.
- 3) Heed all warnings.
- 4) Follow all instructions.
- 5) Do not use this apparatus near water.
- 6) Clean only with dry cloth.
- 7) Do not block any ventilation openings. Install in accordance with the manufacturer's instructions.
- 8) Do not install near any heat sources such as radiators, heat registers, stoves, or other apparatus (including amplifiers) that produce heat.
- 9) Do not defeat the safety purpose of the polarized or grounding-type plug. A polarized plug has two blades with one wider than the other. A grounding-type plug has two blades and a third grounding prong. The wide blade or the third prong are provided for your safety. If the provided plug does not fit into your outlet, consult an electrician for replacement of the obsolete outlet.
- 10) Protect the power cord from being walked on or pinched particularly at plugs, convenience receptacles, and the point where they exit from the apparatus.
- 11) Only use attachments/accessories specified by the manufacturer.
- 12) Use only with the cart, stand, tripod, bracket, or table specified by the manufacturer, or sold with the apparatus. When a cart is used, use caution when moving the cart/apparatus combination to avoid injury from tip-over.
- 13) Unplug this apparatus during lightning storms or when unused for long periods of time.
- 14) Refer all servicing to qualified service personnel. Servicing is required when the apparatus has been damaged in any way, such as power-supply cord or plug is damaged, liquid has been spilled or objects have fallen into the apparatus, the apparatus has been exposed to rain or moisture, does not operate normally, or has been dropped.



The socket outlet shall be installed near the equipment and easily accessible. The mains plug of the power supply cord shall remain readily operable. To completely disconnect this apparatus from the AC Mains, disconnect the power supply cord plug from AC receptacle.

## CAUTION

Danger of explosion if battery is incorrectly replaced. Replace only with the same or equivalent type recommended by the manufacturer. Dispose of used batteries according to the manufacturer's instructions.

DANGER - VISIBLE AND INVISIBLE LASER RADIATION WHEN OPEN. AVOID DIRECT EXPOSURE TO BEAM. FDA 21 CFR/Class IIIb	
注意	- 打开时有可见及不可见激光辐射。避免光束照射。
注意	- ここを開くと可視及び不可視レーザー光が出ます。ビームを見たり、触れたりしないでください。
CAUTION - CLASS 3B VISIBLE AND INVISIBLE LASER RADIATION WHEN OPEN. AVOID EXPOSURE TO THE BEAM. IEC60825-1 +A2/Class 3B	
ATTENTION - RAYONNEMENT LASER VISIBLE ET INVISIBLE. CLASSE 3B. EN CAS D'OUVERTURE, EVITER UNE EXPOSITION AU FAISCEAU.	
FORSIGTIG - SYNLIG OG USYNLIG LASERSTRÅLING KLASSE 3B. NÅR LÅGET ER ÅBENT, UNDGÅ AT BLIVE UDSAT FOR STRÅLEN.	
VARO - AVATTAESSA OLET ALTTIINA LUOKAN 3B NÄKYVÄÄ JA NÄKYMÄTÖNTÄ LASERSÄTELYÄ. VÄRÖ ALITSTUIMISTA SÄTEELTÄ.	
VARNING - KLASS 3B SYNLIG OCH OSYNLIG LASERSTRÅLNING NÄR DENNA DEL ÄR ÖPPNAD. UNDVIK EXPONERING FÖR STRÅLEN.	
VORSICHT - SICHTBARE UND UNSICHTBARE LASERSTRÄHLUNG KLASSE 3B. WENN ABDECKUNG GEÖFFNET, NICHT DEM STRAHL AUSSETZEN.	
CAUTION - VISIBLE AND INVISIBLE LASER RADIATION WHEN OPEN. AVOID EXPOSURE TO THE BEAM. IEC60825-1	
ATTENTION - RAYONNEMENT LASER VISIBLE ET INVISIBLE EN CAS D'OUVERTURE. EXPOSITION DANGEREUSE AU FAISCEAU.	
ADVARSEL - SYNLIG OG USYNLIG LASERSTRÅLING VED ÅBNING. UNDGÅ UDSÆTTELSE FOR STRÅLING.	
VARO! - AVATTAESSA OLET ALTTIINA NÄKYVÄÄ JA NÄKYMÄTÖN LASERSÄTELYÄ. ÄLÄ KATSO SÄTEESEEN.	
VARNING - SYNLIG OCH OSYNLIG LASERSTRÅLNING NÄR DENNA DEL ÄR ÖPPNAD. BETRÄKTA EJ STRÅLEN.	
VORSICHT - SICHTBARE UND UNSICHTBARE LASERSTRÄHLUNG. WENN ABDECKUNG GEÖFFNET, NICHT DEM STRAHL AUSSETZEN.	
ADVARSEL - SYNLIG OG USYNLIG LASERSTRÅLING NÅR DEKSEL ÅPNES. UNNGÅ EKSPONERING FOR STRÅLEN. VQL1J67	

(Inside of product)

## Getting started

<b>IMPORTANT SAFETY INSTRUCTIONS</b> .....	2
<b>Accessories</b> .....	3
<b>Disc information</b> .....	4
<b>The remote control information</b> .....	6
<b>Disc handling</b> .....	6
<b>Unit care</b> .....	6
<b>Control reference guide</b> .....	7
<b>STEP 1 Connection</b> .....	8
<b>STEP 2 Plug-in Auto Tuning</b> .....	12
<b>Channel captions/Television type</b> .....	14
<b>Remote control settings</b> .....	15
<b>Clock settings</b> .....	15

## Recording

<b>Important notes for recording</b> .....	16
Recording modes and approximate recording times .....	17
Disc Insertion/Ejection .....	17
<b>Recording television programs</b> .....	18
To specify a time to stop recording –One Touch Recording ..	19
Flexible Recording .....	19
Playing while you are recording .....	19
Selecting audio to record .....	19
<b>Scheduled recording</b> .....	20
Cancel scheduled recording that has already begun .....	21
Release program from recording standby .....	21
Notes on scheduled recording .....	21
Check, change or delete a program .....	21

## Playing back

<b>Playing discs</b> .....	22
Operations during play .....	23
<b>Using menus to play MP3, DivX and still pictures (JPEG/TIFF)</b> .....	24
Selecting file type to play .....	24
Playing MP3, DivX and still pictures (JPEG/TIFF) .....	24
To select other folder (group) .....	25
Useful functions during still picture play .....	25
Regarding DivX VOD content .....	26
Regarding MP3, DivX and still pictures .....	26
<b>Using on-screen menus/ FUNCTIONS window and Status messages</b> .....	27
Using on-screen menus .....	27
FUNCTIONS window .....	28
Status messages .....	28

## Editing

<b>Entering text</b> .....	29
<b>Deleting titles</b> .....	29
Selecting recorded titles to delete –Delete Navigator .....	29
Deleting title during play .....	29
<b>Editing titles/chapters</b> .....	30
Editing titles/chapters and playing chapters .....	30
Title operations .....	31
Chapter operations .....	31
<b>Creating, editing and playing playlists</b> .....	32
Creating playlists .....	32
Editing and playing playlists/chapters .....	33
Playlist operations .....	33
Chapter operations .....	33

## Copying

<b>Copying from a video cassette recorder</b> .....	34
DV camcorder recording .....	34
Manual recording .....	34

## Convenient functions

<b>DVD Management</b> .....	35
Providing a disc with a name –Disc Name .....	35
Setting the protection –Disc Protection .....	35
Deleting all titles and playlists –Delete All Titles .....	35
Deleting all contents of a disc –Format Disc ( DVD ) .....	35
Selecting whether to show the Top Menu first	
–Playback will start with: .....	36
Enabling discs to be played on other equipment –Finalize ..	36
Creating Top Menu –Create DVD Top Menu .....	36
Enabling the second layer on DL (dual- or double- layer on single side) discs to be recordable –Close First Layer .....	36
<b>Changing the unit's settings</b> .....	37
Common procedures .....	37
Summary of settings .....	37

## Reference

<b>Messages</b> .....	40
<b>Frequently asked questions</b> .....	41
<b>Troubleshooting guide</b> .....	42
<b>Product Service</b> .....	44
<b>Glossary</b> .....	45
<b>Specifications</b> .....	46
<b>Limited Warranty</b> .....	47
<b>Index</b> .....	48

## Accessories



Please check and identify the supplied accessories. Use numbers indicated in parentheses when asking for replacement parts. (Product numbers correct as of January 2007. These may be subject to change.)

**To order accessories, call the dealer from whom you have made your purchase.**



1 **Remote control**  
(EUR7659Y10)



1 **Audio/video cable**  
(K2KA6BA00003)

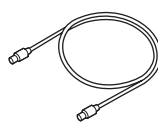

1 **75  $\Omega$  coaxial cable**  
(K2KZ2BA00001)

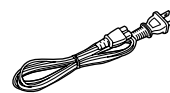

1 **AC power supply cord**  
(K2CB2CB00018)

- For use with this unit only. Do not use it with other equipment. Also do not use the cords for other equipment with this unit.

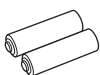





2 **Batteries**  
for remote control

The enclosed Canadian French label sheet corresponds to the English display on the front and back sides of the unit.

# Disc information

## Discs you can use for recording and play

Disc type	DVD-RAM	DVD-R	DVD-R DL* <sup>1</sup> (dual layer on single side)	DVD-RW	+R* <sup>2</sup>	+R DL* <sup>1</sup> (double layer on single side)	+RW
Indication in these instructions	<b>RAM</b>	<b>-R</b> Before finalization	<b>-R DL</b> Before finalization	<b>-RW(V)</b> Before finalization	<b>+R</b> Before finalization	<b>+R DL</b> Before finalization	<b>+RW</b>
		<b>DVD-V</b> After finalization	<b>DVD-V</b> After finalization	<b>DVD-V</b> After finalization	<b>DVD-V</b> After finalization	<b>DVD-V</b> After finalization	
Logo					—	—	—
Recording format (→ below)	VR	DVD-Video	DVD-Video	DVD-Video	+VR	+VR	+VR
Re-writable* <sup>3</sup>	Yes	No	No	Yes	No	No	Yes
<b>What you can do on this unit</b>							
Recording broadcasts that allow one copy	Yes* <sup>4</sup>	No	No	No	No	No	No
Recording both Main and SAP of MTS broadcast	Yes	No	No	No	No	No	No
Recording 16:9 aspect picture	Yes	No	No	No	No	No	No
Creating playlists	Yes	No	No	No	No	No	No
<b>Compatibility</b>							
Usable high speed recording disc type* <sup>5</sup>	Up to 5x	Up to 16x	Up to 4x	Up to 6x	Up to 16x	Up to 2.4x	Up to 4x* <sup>6</sup>
Play on other players	Only on DVD-RAM compatible players. (It is not possible to finalize the disc.)	Yes	Yes* <sup>7</sup>	Yes	Yes	Yes* <sup>8</sup>	Yes (It is not possible to finalize the disc.)
		Only on compatible players after finalizing the disc (→ page 36)					

- We recommend using Panasonic discs. We also recommend using DVD-RAM discs with cartridges to protect them from scratches and dirt.
- You may not be able to record depending on the condition of the discs and you may not be able to play due to the condition of the recording.
- For the recording time, refer to "Recording modes and approximate recording times" on page 17.

\*<sup>1</sup> You can record onto the second layer of dual- or double-layer discs after closing the first layer (→ page 36). You will no longer be able to record to the first layer after you do this (→ page 16).

When playing a title recorded on both layers, video and audio may momentarily cut out when the unit is switching layers.

\*<sup>2</sup> You may not be able to use +R recorded on this unit in another Panasonic DVD recorder and vice versa. Once the disc is finalized, however, it can be played in the other unit.

\*<sup>3</sup> The amount of the recordable disc space doesn't increase even if the program is deleted when you use a one time recording disc.

\*<sup>4</sup> CPRM (→ page 45) compatible discs only.

\*<sup>5</sup> This unit can use the high-speed recording discs shown in the chart, but using them will not shorten the recording time.

\*<sup>6</sup> You can play 8x recording speed discs recorded on another equipment.

\*<sup>7</sup> Play on DVD-R DL compatible equipment.

\*<sup>8</sup> Play on +R DL compatible equipment.

### Regarding recording format

#### VR (DVD Video Recording) format

This is a recording method which allows you to freely record and edit television broadcasts and so on.

- Digital broadcasts that allow "One time only recording" can be recorded to a CPRM compatible disc. You can record to CPRM compatible DVD-RAM on this unit.
- Play is only possible on a compatible DVD player.

#### DVD-Video format

This recording method is the same as commercially available DVD-Video.



- Digital broadcasts that allow "One time only recording" cannot be recorded.
- You can play on compatible equipment such as DVD players after finalizing the disc on this unit.



#### +VR (+R/+RW Video Recording) format

This is method for recording moving pictures to +R/+RW discs. You can play back such discs recorded in this method in a similar way as contents recorded in the DVD-Video format.

- Digital broadcasts that allow "One time only recording" cannot be recorded.
- After finalizing the disc or creating the top menu, you can play the disc on DVD players and other equipment.

## Play-only discs

Disc type	DVD-Video	DVD-Audio	DVD-RW (VR format)
Indication in these instructions	<b>DVD-V</b>	<b>DVD-A</b>	<b>-RW(VR)</b>
Logo			
Instructions	High quality movie and music discs	High fidelity music discs <ul style="list-style-type: none"> <li>• Played on this unit in 2 channels.</li> </ul>	DVD-RW recorded on another DVD Recorder* <ul style="list-style-type: none"> <li>• You can play programs that allow "One time only recording" if they have been recorded to a CPRM compatible disc.</li> <li>• By formatting (→ page 35) the disc, you can record to it in DVD-Video format.</li> <li>• It may be necessary to finalize the disc on the equipment used for recording.</li> </ul>

Disc type	DVD-R	CD		Video CD
Logo			—	
Indicated in these instructions by	<b>DivX</b>	<b>CD</b>	<b>DivX, MP3, JPEG/TIFF</b>	<b>VCD</b>
Instructions	DVD-R* with video recorded in DivX	Recorded audio and music (including CD-R/RW*)	<ul style="list-style-type: none"> <li>• CD-R and CD-RW* with video recorded in DivX</li> <li>• CD-R and CD-RW* with music recorded in MP3 (→ page 24)</li> <li>• CD-R and CD-RW* with still pictures recorded in JPEG and TIFF</li> </ul>	Recorded music and video (including CD-R/RW*)

- The producer of the disc can control how discs are played. So you may not always be able to control play as described in these operating instructions. Read the disc's instructions carefully.
- Operation and sound quality of CDs that do not conform to CD-DA specifications (copy control CDs, etc.) cannot be guaranteed.
- \* Close the session after recording. Play may be impossible on some discs due to the condition of the recording.

### Regarding DVD-Audio

Some multi-channel DVD-Audio will prevent down-mixing (→ page 45) of all or part of their contents if this is the manufacturer's intention. Tracks that are prevented from being down-mixed will not play properly on this unit (e.g. audio is played from the front two channels only). Refer to the disc's jacket for more information.

### Note about using a DualDisc

The digital audio content side of a DualDisc does not meet the technical specifications of the Compact Disc Digital Audio (CD-DA) format so play may not be possible.

## Discs that cannot be played

- 2.6 and 5.2 GB DVD-RAM, 12 cm (5")
- 3.95 and 4.7 GB DVD-R for Authoring
- DVD-R recorded in VR format
- DVD-R (DVD-Video format), DVD-R DL, DVD-RW (DVD-Video format), +R, +R DL recorded on another unit and not finalized (→ page 45)
- PAL discs (you can still play the audio on DVD-Audio)
- DVD-Video with a region number other than "1" or "ALL"
- Blu-ray, HD-DVD
- DVD-ROM, +R 8 cm (3"), CD-ROM, CDV, CD-G, Photo CD, CVD, SVCD, SACD, MV-Disc, PD, etc.

# The remote control information

## ■ Batteries

- Insert so the poles (+ and –) match those in the remote control.
- Do not use rechargeable type batteries.
- Do not mix old and new batteries.
- Do not use different types at the same time.
- Do not heat or expose to flame.
- Do not take apart or short circuit.
- Do not attempt to recharge alkaline or manganese batteries.
- Do not use batteries if the covering has been peeled off.

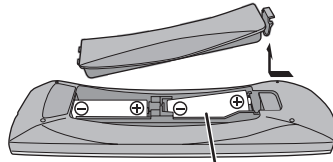

R6/LR6, AA

Mishandling of batteries can cause electrolyte leakage which can damage items the fluid contacts and may cause a fire. Remove if the remote control is not going to be used for a long period of time. Store in a cool, dark place.

## ■ Use

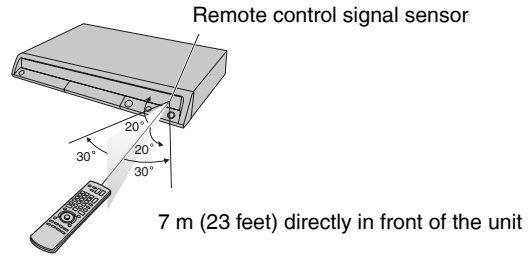

# Disc handling

## ■ How to hold a disc

Do not touch the recorded surface.



## ■ Concerning non-cartridge discs

Be careful about scratches and dirt.

## ■ If there is dirt or condensation on the disc

Wipe with a damp cloth and then wipe dry.



## ■ Handling precautions

- Do not attach labels or stickers to discs. (This may cause disc warping and un-balanced rotation, rendering it unusable.)
- Write on the label side of the disc only with a soft, oil-based felt pen. Do not use ballpoint pens or other hard writing implements.
- Do not use record cleaning sprays, benzine, thinner, static electricity prevention liquids or any other solvent.

- Do not use scratch-proof protectors or covers.
- Do not drop, stack, or impact discs. Do not place objects on them.
- Do not use the following discs:
  - Discs with exposed adhesive from removed stickers or labels (rented discs, etc.).
  - Discs that are badly warped or cracked.
  - Irregularly shaped discs, such as heart shapes.
- Do not place in the following areas:
  - In direct sunlight.
  - In very dusty or humid areas.
  - Near a heater.
  - Locations susceptible to significant differences in temperature (condensation can occur).
  - Where static electricity or electromagnetic waves occur.
- To protect discs from scratches and dirt, return them to their cases or cartridges when you are not using them.



**The manufacturer accepts no responsibility and offers no compensation for loss of recorded or edited material due to a problem with the unit or recordable media, and accepts no responsibility and offers no compensation for any subsequent damage caused by such loss.**

### Examples of causes of such losses are

- A disc recorded and edited with this unit is played in a DVD recorder or computer disc drive manufactured by another company.
- A disc used as described above and then played again in this unit.
- A disc recorded and edited with a DVD recorder or computer disc drive manufactured by another company is played in this unit.

# Unit care

The precision parts in this unit are readily affected by the environment, especially temperature, humidity, and dust. Cigarette smoke also can cause malfunction or breakdown.

## To clean this unit, wipe with a soft, dry cloth.

- Never use alcohol, paint thinner or benzine to clean this unit.
- Before using chemically treated cloth, carefully read the instructions that came with the cloth.

## Observe the following points to ensure continued listening and viewing pleasure.

Dust and dirt may adhere to the unit's lens over time, making it impossible to record or play discs.

Use the **DVD lens cleaner** (RP-CL720PP) about once every year, depending on frequency of use and the operating environment. Carefully read the lens cleaner's instructions before use.

**Do not place the unit on amplifiers or equipment that may become hot.**

The heat can damage the unit.



**Before moving the unit, ensure the disc tray is empty. Failure to do so will risk severely damaging the disc and the unit.**

## Remote control

Instructions for operations are generally described using the remote control.

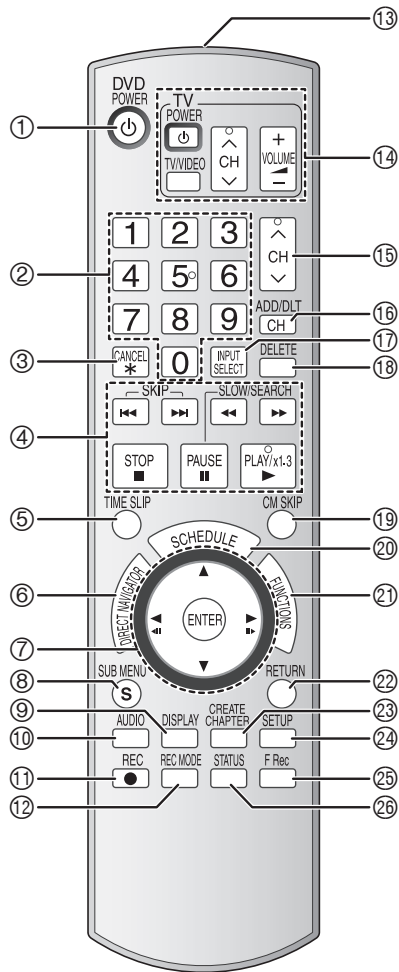

- ① Turn the unit on (→ page 12)
- ② Select channels and title numbers, etc./ Enter numbers
- ③ Cancel
- ④ Basic operations for recording and play
- ⑤ Skip the specified time (→ page 23)
- ⑥ Show Direct Navigator/Top menu (→ page 22, 24, 30)
- ⑦ Selection/Enter, Frame-by-frame (→ page 12, 23)
- ⑧ Show sub menu (→ page 25, 30, 33)
- ⑨ Show on-screen menu (→ page 27)
- ⑩ Select audio (→ page 19, 23)
- ⑪ Start recording (→ page 18)
- ⑫ Change recording mode (→ page 18)
- ⑬ Remote control signal output
- ⑭ Television operations (→ page 15)
- ⑮ Channel select (→ page 18)
- ⑯ Add/delete channel (→ page 13)
- ⑰ Input select (IN1 or IN2 or DV)
- ⑱ Delete items (→ page 29)
- ⑲ Skip a minute forward (→ page 23)
- ⑳ Show scheduled recording list (→ page 20)
- ㉑ Show FUNCTIONS window (→ page 28)
- ㉒ Return to previous screen
- ㉓ Create chapters (→ page 23)
- ㉔ Show Setup menu (→ page 14, 37)
- ㉕ Start Flexible Recording (→ page 19)
- ㉖ Show status messages (→ page 28)

### ■ Using the cursor

- Select items on menu screens and set items.

Press up, down, left or right to select an item.

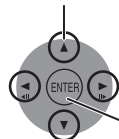

Press [ENTER] to confirm.

This operation is also possible...

- Frame-by-frame (backward/forward):  
While paused, press [◀▶] or [▶▶] (left/right)

## Main unit

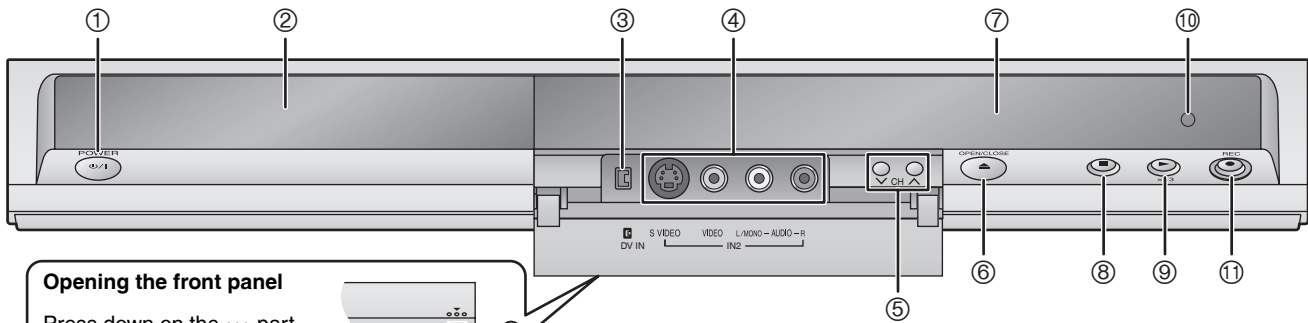

### Opening the front panel

Press down on the ... part with your finger.

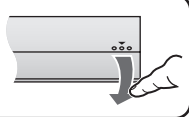

- ① POWER button (POWER  $\phi$ /I) (→ page 12)  
Press to switch the unit from on to standby mode or vice versa. In standby mode, the unit is still consuming a small amount of power.
- ② Disc tray (→ page 18)
- ③ Connector for a digital video (DV) camcorder (→ page 34)
- ④ Connectors for external equipment (→ page 34)
- ⑤ Channel select (→ page 18)
- ⑥ Open/close disc tray (→ page 18)
- ⑦ Display (→ below)
- ⑧ Stop (→ page 18, 23)
- ⑨ Start play (→ page 22)
- ⑩ Remote control signal sensor
- ⑪ Start recording (→ page 18)/  
Specify the time to stop recording (→ page 19)

## The unit's display

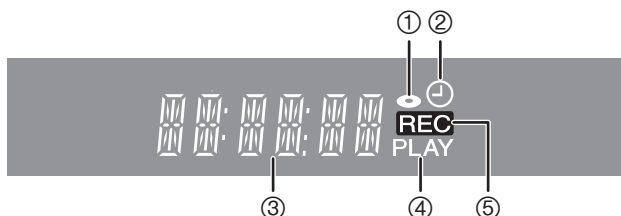

- ① Disc indicator
  - This indicator lights up when a disc that is supported by this unit is inserted.
- ② Scheduled recording indicator
- ③ Main display section
- ④ Playing indicator
- ⑤ Recording indicator

# STEP 1 Connection

This section includes diagrams of four common methods of connections (A-D, pages 8-9). Please connect using the one that best suits you.

• Visit Panasonic's homepage for more information about connection methods. (This is in English only.)

[http://www.panasonic.com/consumer\\_electronics/dvd\\_recorder/dvd\\_connection.asp](http://www.panasonic.com/consumer_electronics/dvd_recorder/dvd_connection.asp)

- Before doing any connection, turn off all equipment and read the appropriate operating instructions.
- Peripheral equipment and optional cables are sold separately unless otherwise indicated.

## ■ The unit's RF OUT terminal

The picture and sound signal from this unit does not go through the RF OUT terminal to the television. Make sure you connect one of the following terminals on this unit to the television: the AUDIO/VIDEO OUT terminal, the S VIDEO OUT terminal or the COMPONENT VIDEO OUT terminal.

- Refer to page 11 if the antenna connector doesn't match.

## ■ When the unit is not to be used for a long time

To save power, unplug it from the household AC outlet. This unit consumes a small amount of power, even when it is turned off (**approx. 2.0 W**).

## ■ Connect the unit directly to the television

Video signals fed through video cassette recorders will be affected by copyright protection systems and the picture will not be shown correctly on the television.

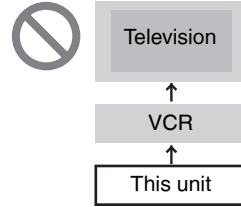

### A Connection with a television

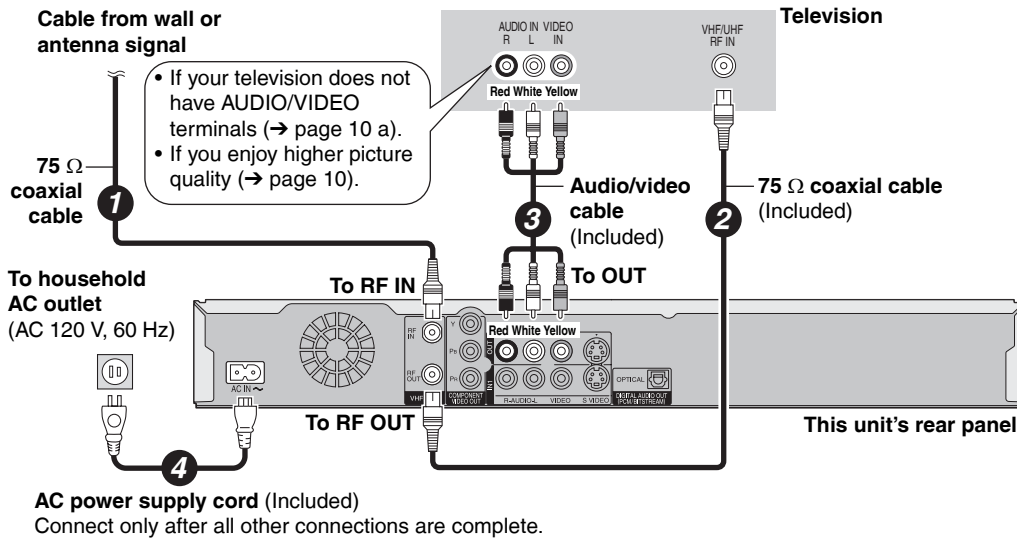

### B Connection with a television and video cassette recorder

The connection will allow the video cassette recorder to be used for playback and recording when this unit is turned off.

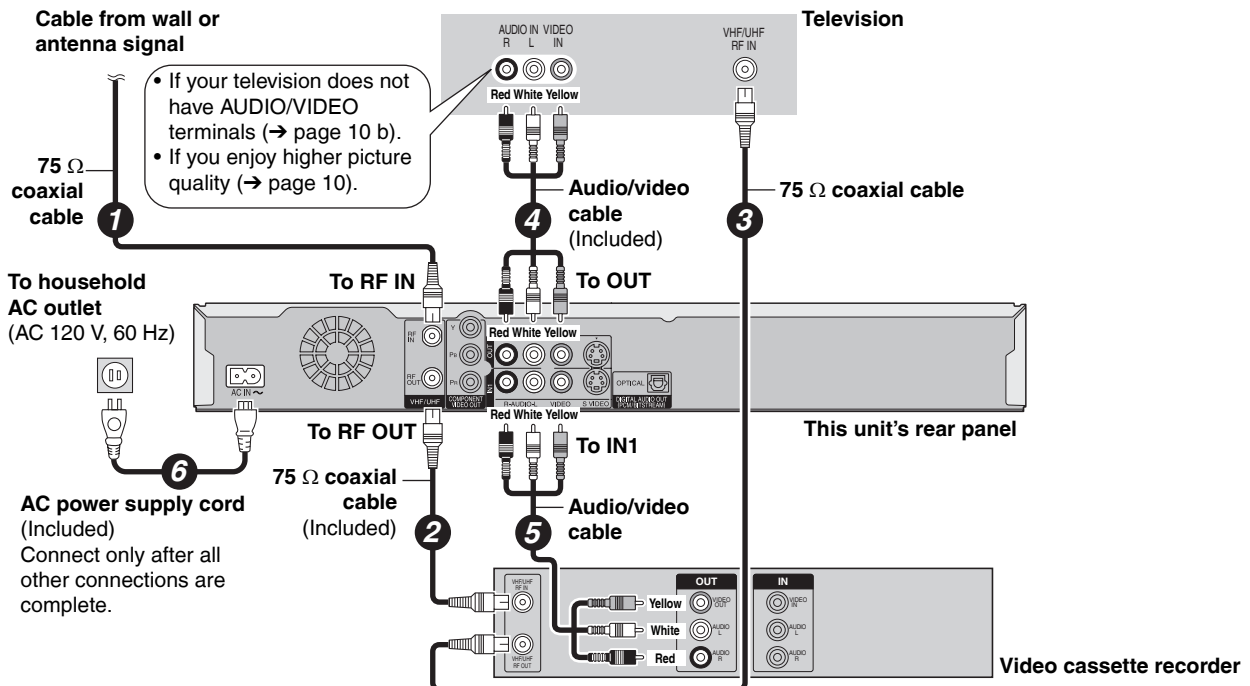



**C Connection with a television and cable box or satellite receiver**

- You need to subscribe to a cable TV service to enjoy viewing their programming.
- Consult your service provider regarding appropriate cable TV box.

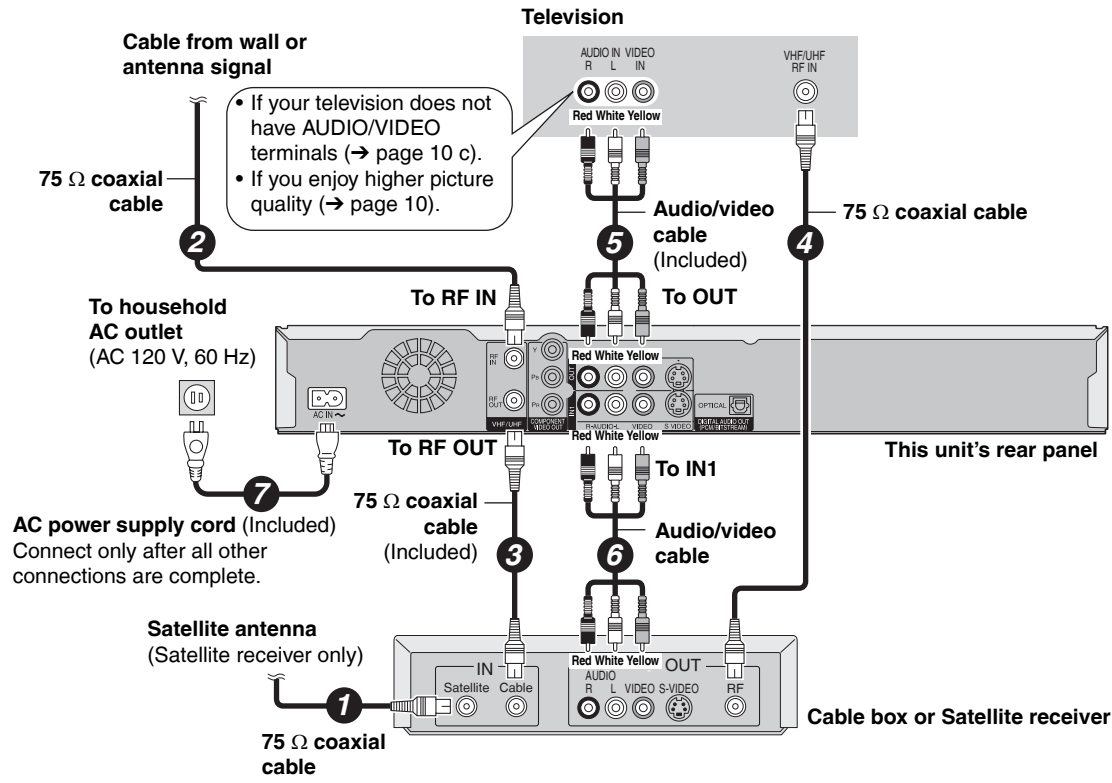

**D Connection with a television, video cassette recorder and cable box or satellite receiver**

- You need to subscribe to a cable TV service to enjoy viewing their programming.
- Consult your service provider regarding appropriate cable TV box.
- The connection will allow the video cassette recorder to be used for playback and recording when this unit is turned off.

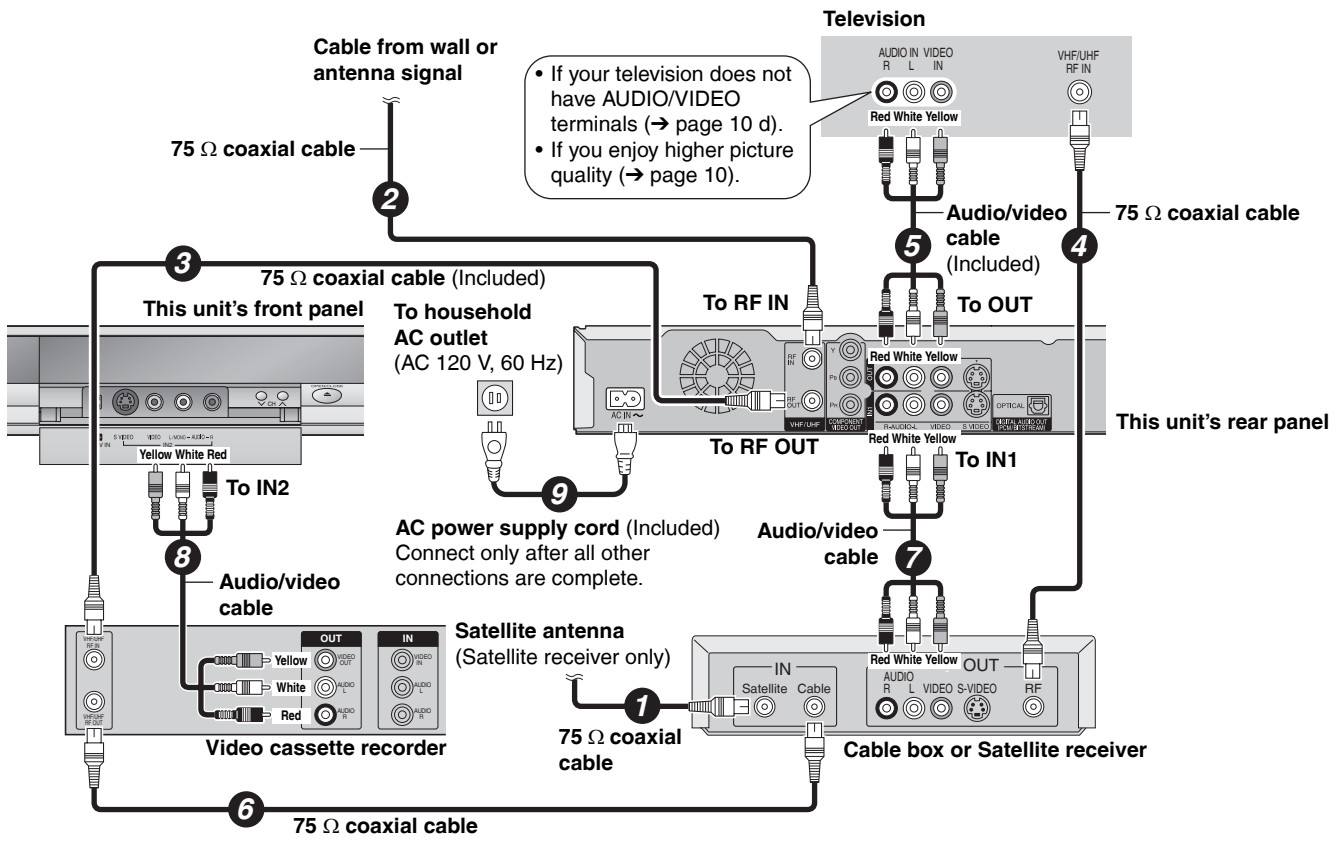

If your television does not have Audio/Video terminals, RF Modulator is necessary

**a** Connection with a television (→ page 8 A)

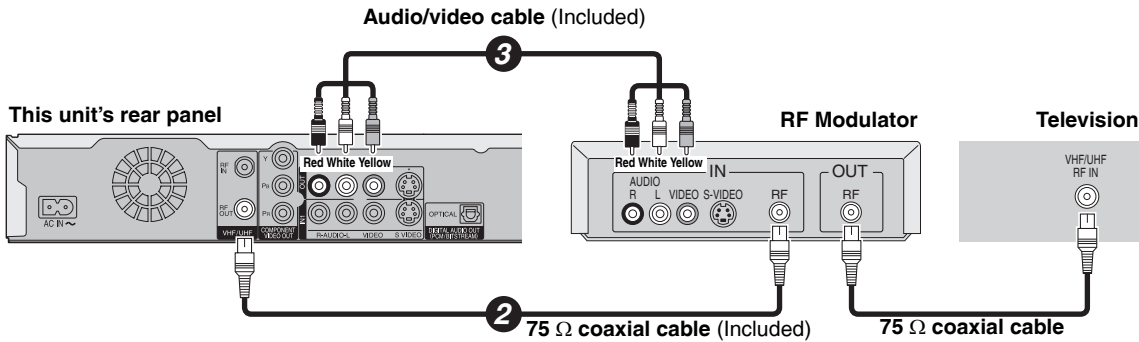

**b** Connection with a television and video cassette recorder (→ page 8 B)

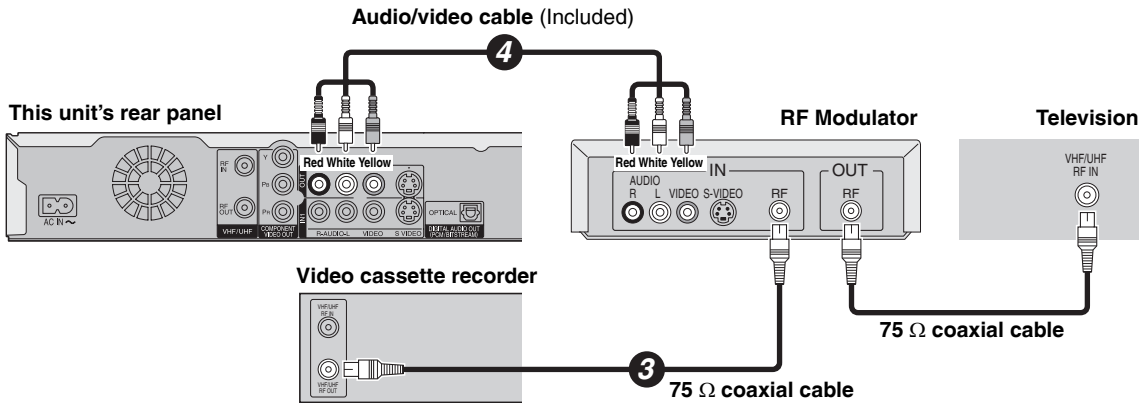

**c** Connection with a television and cable box or satellite receiver (→ page 9 C)

**d** Connection with a television, video cassette recorder and cable box or satellite receiver (→ page 9 D)

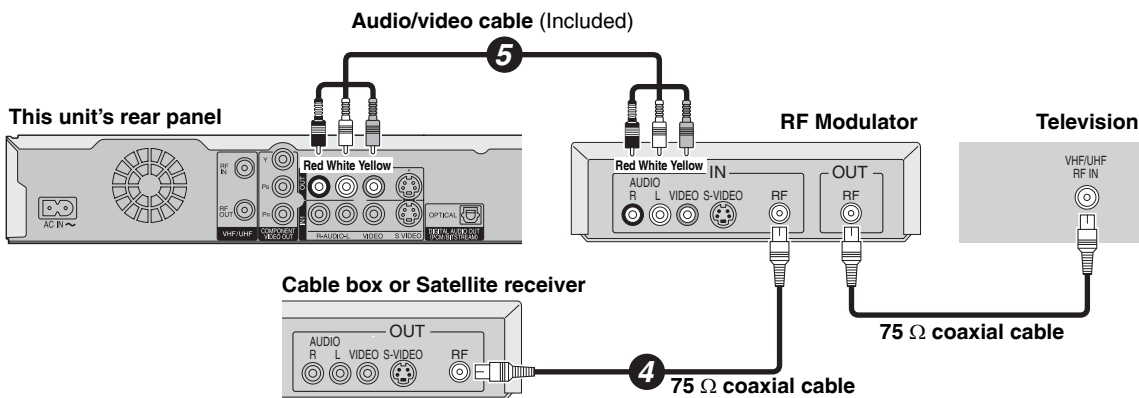

To enjoy higher picture quality

Connecting to the S VIDEO IN terminal

The S VIDEO OUT terminal achieves a more vivid picture than the VIDEO OUT terminal. (Actual results depend on the television.)

Television

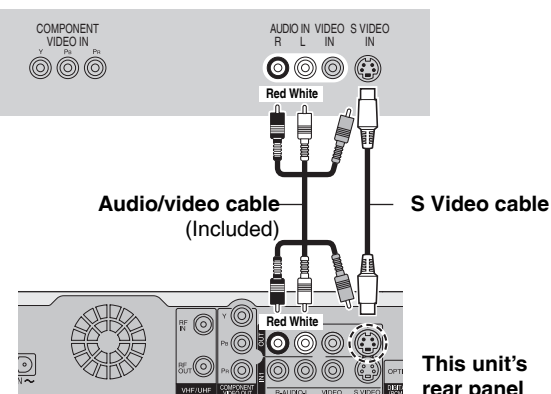

Connecting to the COMPONENT VIDEO IN terminal

These terminals can be used for either interlace or progressive output (→ page 45) and provide a purer picture than the S VIDEO OUT terminal.

- Connect to terminals of the same color.

Television

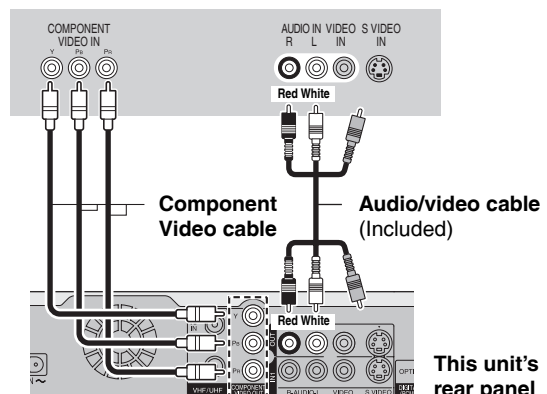

## If the antenna connector doesn't match

Use one of the following connections to suit the antenna lead to the unit's RF IN terminal, and the 75 Ω coaxial cable to the antenna terminals on the equipment (television etc.). Refer to other equipment's operating instructions.

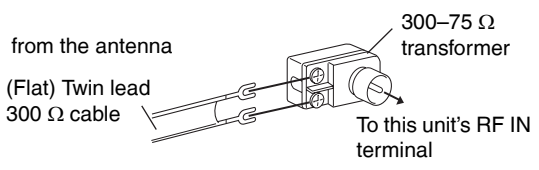
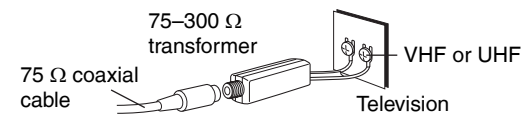
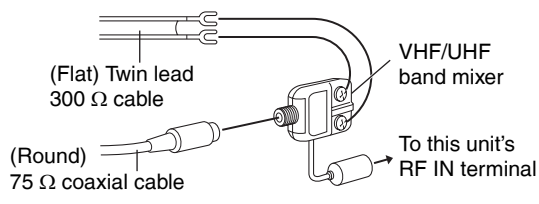
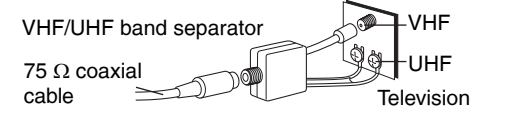
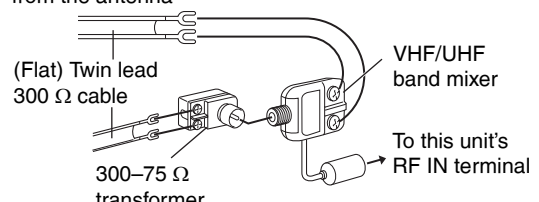
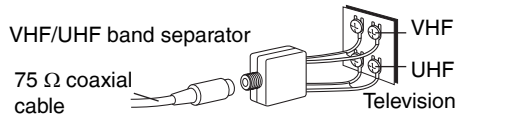
Type	This unit	Other equipment (television etc.)
<b>A twin lead</b>	<p>from the antenna</p> <p>(Flat) Twin lead 300 Ω cable</p>  <p>300–75 Ω transformer</p> <p>To this unit's RF IN terminal</p>	 <p>75–300 Ω transformer</p> <p>75 Ω coaxial cable</p> <p>VHF or UHF Television</p>
<b>A twin lead and a coaxial plug</b>	<p>from the antenna</p> <p>(Flat) Twin lead 300 Ω cable</p> <p>(Round) 75 Ω coaxial cable</p>  <p>VHF/UHF band mixer</p> <p>To this unit's RF IN terminal</p>	 <p>VHF/UHF band separator</p> <p>75 Ω coaxial cable</p> <p>VHF UHF Television</p>
<b>Two twin leads</b>	<p>from the antenna</p> <p>(Flat) Twin lead 300 Ω cable</p> <p>300–75 Ω transformer</p>  <p>VHF/UHF band mixer</p> <p>To this unit's RF IN terminal</p>	 <p>VHF/UHF band separator</p> <p>75 Ω coaxial cable</p> <p>VHF UHF Television</p>

## Connecting an amplifier or system component

### ■ Connecting an amplifier with a digital input terminal

- To enjoy multi-channel surround on DVD-Video, connect an amplifier with a built-in decoder displaying these logo marks using an optical digital audio cable and change the settings in Digital Audio Output (→ page 39).
- Before purchasing an optical digital audio cable, check the terminal shape of the connected equipment.
- You cannot use DTS Digital Surround decoders not suited to DVD.
- Even if using this connection, output will be only 2 channels when playing DVD-Audio.



### ■ Connection to a stereo amplifier

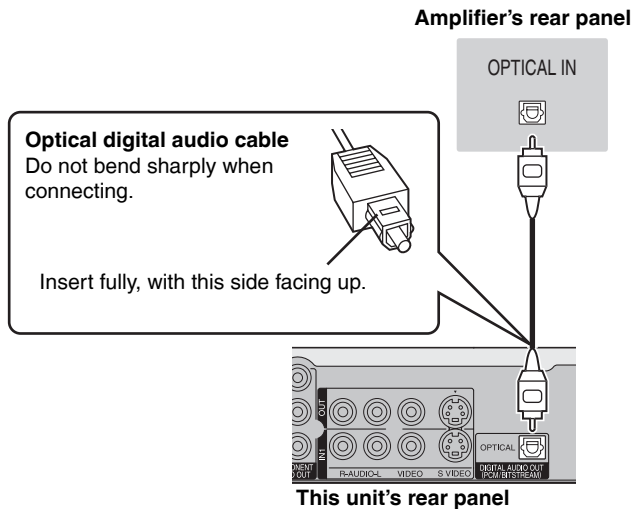

### Amplifier's rear panel

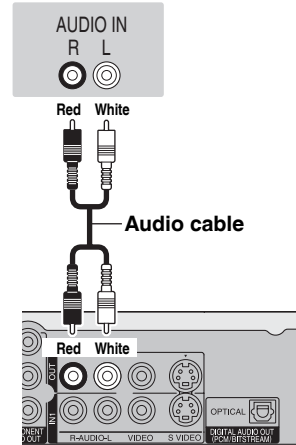

# STEP 2 Plug-in Auto Tuning

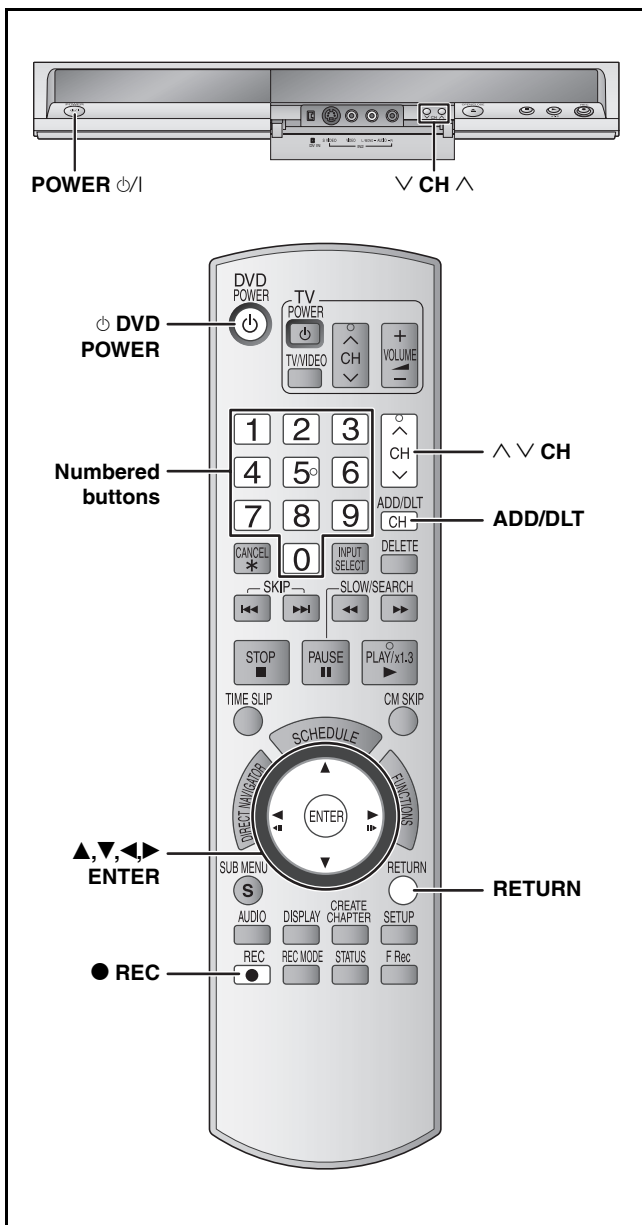

After pressing [DVD POWER] to turn the unit on for the first time, the unit starts necessary setup.

### Regarding DST (Daylight Saving Time) (→ page 15)

Legal revision is expected to change the DST period in 2007. When you use the unit with DST on, the change may cause the unit's clock to go behind the actual time. Check the DST setting in "Set Clock Manually" in the Setup menu, set DST off and reset the clock precisely if you are using this function.

### Preparation

Turn on the television and select the appropriate video input to suit the connections to this unit.

**1 Press [DVD POWER].**

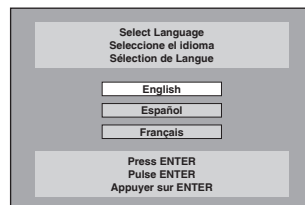

**2 Press [▲, ▼] to select the language and press [ENTER].**

If you make a mistake, press [RETURN] to return to an earlier screen.

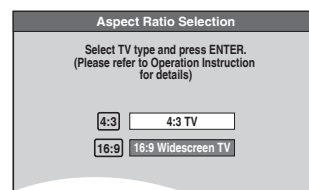

**3 Press [▲, ▼] to select "4:3 TV" or "16:9 Widescreen TV" and press [ENTER].**

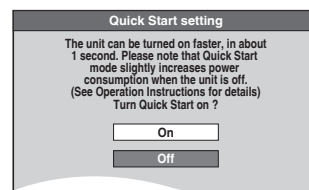

**4 Press [▲, ▼] to select "On" or "Off" and press [ENTER].**

If you activate "Quick Start" function, select "On".

### About "Quick Start" function

If you set Quick Start to on, you can start recording to DVD-RAM about 1 second after you press [DVD POWER] to turn the unit on and then sequentially press [REC]. The following happens when you have selected "On".

- Power consumption in standby mode increases because power is supplied to the unit.

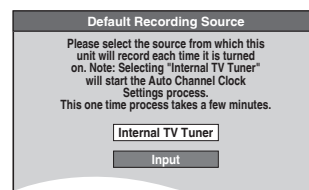

**5 Press [▲, ▼] to select "Internal TV Tuner" or "Input" and press [ENTER].**

When you do not set channels on this unit, select "Input". The unit then displays "Set Clock Manually" screen. Set the clock manually (→ page 13).

(Continued on next page)

## 6 Press [ENTER] to start Plug-in Auto Tuning.

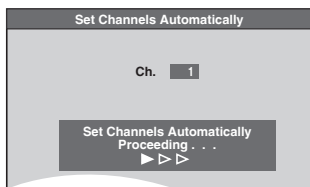

The unit then proceeds with Auto Clock Setting. The time is displayed when finished.

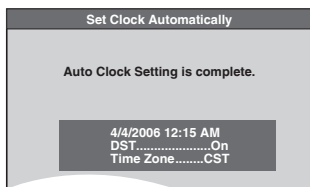

### ■ When one of the following screen appears “No channels were found.” screen



After turning off the unit, confirm following and perform setup again.

- Confirm the antenna cable is firmly connected to RF IN terminal.
- If you do not set channels on this unit, select “Input” in step 5.

### “Auto Clock Setting is incomplete.” screen

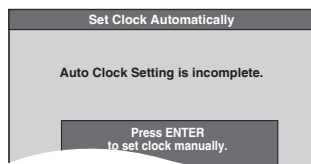

Press [ENTER] and set clock manually (→ right).

## 7 Press [ENTER].

A picture or a blue background screen is displayed.

### ■ If the clock is an hour slower or faster than the actual time

Select “-1” or “+1” in “Adjust Time Zone” in the Setup menu (→ page 15).

The unit configures channels according to the Signal Source (RF IN) settings (→ page 37) as follows.

Signal Source (RF IN)	Band	Channel
Antenna	VHF	2–13
	UHF	14–69
Cable TV	VHF	2–13
	CATV LOW BAND	95–99
	CATV MID/SUPER BAND	14–36
	CATV HYPER BAND	37–65
	ULTRA BAND	66–94 100–125
	SPECIAL CATV CHANNEL	1

### Adding and deleting channels

After channel setting on this unit completed, you can add or delete channels if necessary channels are not set or unnecessary channels are set.

## 1 Press the numbered buttons to select a channel.

### Antenna

e.g., 5: [0] → [5]  
15: [1] → [5]

### Cable TV

e.g., 5: [0] → [0] → [5]  
15: [0] → [1] → [5]  
115: [1] → [1] → [5]

Unit's display



- You can also use [^ V CH] when you are going to delete a channel.

## 2 Press [ADD/DLT].

e.g., The channel is deleted.

Channel 15 Deleted

### Restart Plug-in Auto Tuning (after relocation, for example)

The setting of the clock and channel is cleared when you perform the procedure below. Scheduled recording settings are also cleared.

## 1 When the unit is on and stopped Press and hold [V CH] and [^ CH] on the main unit for about five seconds.

The unit turns off.

## 2 Press [DVD POWER].

The language selection screen is displayed.

### When “Set Clock Manually” screen is displayed

The “Set Clock Manually” screen is automatically displayed when:  
– there is an error while setting the clock automatically.  
– you have selected “Input” in step 5 while setting (→ page 12).

## 1 Press [◀▶] to select the item you want to change and press [▲▼] to change the setting.

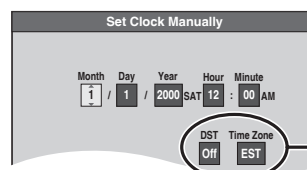

DST, Time Zone (→ below)

### • DST (Daylight Saving Time):

If you select “On”, the clock is advanced one hour starting at 2 a.m. on the first Sunday in April and ending at 2 a.m. on the last Sunday in October.

- Time Zone shows the time difference from Greenwich Mean Time (GMT).

EST (Eastern Standard Time) = GMT –5  
CST (Central Standard Time) = GMT –6  
MST (Mountain Standard Time) = GMT –7  
PST (Pacific Standard Time) = GMT –8  
AST (Alaska Standard Time) = GMT –9  
HST (Hawaii Standard Time) = GMT –10

## 2 Press [ENTER].

A picture or a blue background screen is displayed. The clock starts.

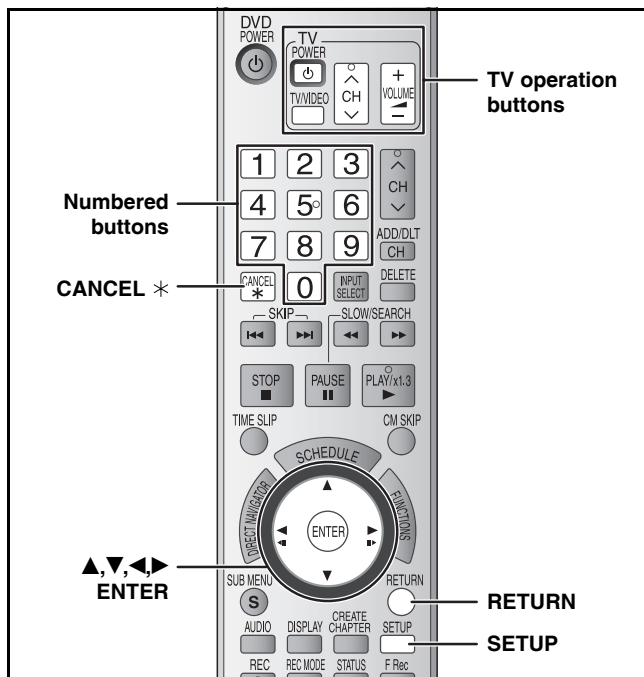

## Channel captions

You can give the preset captions, or manually enter new ones yourself. The captions you enter are displayed when the channel is displayed and in the Direct Navigator screen.

- You can set channel captions after channel setting on this unit is completed (→ page 12–13).

- While stopped  
Press [SETUP].

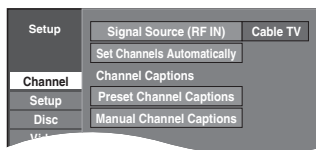

- Press [▲,▼] to select “Channel” and press [▶].

### Preset Channel Captions

- Press [▲,▼] to select “Preset Channel Captions” and press [ENTER].

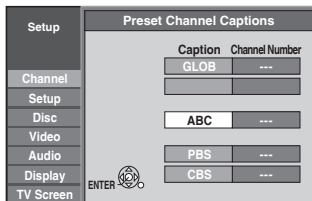

- Press [▲,▼] to select the caption and press [▶].

You can choose from the following captions.  
ABC, PBS, CBS, CNN, FOX, ESPN, NBC, HBO, A&E, AMC, FAM, MAX, MTV, SHOW, TBS, USA, TNT, CBC, UPN, CTV, WB, TSN, DSC, GLOB

- When selecting the caption, press and hold [▲,▼] to scroll up and down the screen.

- Press [▲,▼] to select the channel corresponding to the caption and press [◀].

  - Channels are only displayed if they contain a station and if captions have not been added manually.
  - To delete the channel number, press [CANCEL \*].

Repeat steps 4 and 5 to enter other channels.

- Press [ENTER].

### Manual Channel Captions

- Press [▲,▼] to select “Manual Channel Captions” and press [ENTER].
- Press [▲,▼] to select the channel and press [▶].
  - Channels are only displayed if they contain a station and if preset captions have not been added.
- Press [▲,▼] to select the first character and press [▶].
  - You can choose from the following characters:  
A–Z, 0–9, -, &, !, /, (space)
  - To delete the caption, press [CANCEL \*].
  - Repeat this step to enter the other characters.

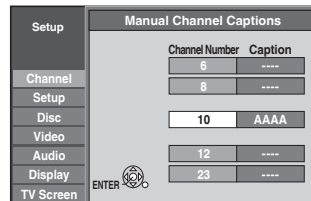

- Press [◀,▶] to return to the “Channel Number” column.  
Repeat steps 4–6 to enter other channels.
- Press [ENTER].

#### To exit the screen

Press [SETUP].

#### To return to the previous screen

Press [RETURN].

## Selecting television type

Do the following if you connect a progressive television or if you connect a different type of television after choosing a type during initial setup just after turning the unit on for the first time. Select the item that matches your television.

- While stopped  
Press [SETUP].
- Press [▲,▼] to select “TV Screen” and press [▶].
- Press [▲,▼] to select “TV Type” and press [ENTER].

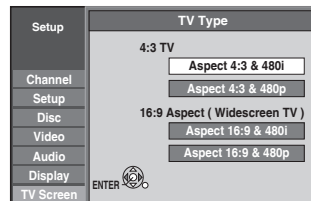

- 480p/480i:  
Select “480p” if the television is compatible with progressive output.

- Press [▲,▼] to select the item and press [ENTER].

#### To exit the screen

Press [SETUP].

#### To return to the previous screen

Press [RETURN].

## Remote control settings

Refer to the control reference on page 14.

### Television operation

You can operate the TV through the unit's remote control.

Point the remote control at the television

While pressing [**POWER TV**], enter the code with the numbered buttons.

e.g., 0250: [0] → [2] → [5] → [0]

Manufacturer and Code No.

Panasonic	0051/0250	PHILIPS (RC-5)	0054
National		RCA	0047
QUASAR		SAMSUNG	0060/0587/ 0702
FISHER	0154	SANYO	0154
GE	0047	SHARP	0093/0165
GOLDSTAR	0178/0317/ 0457	SONY	0000
HITACHI	0145	SYLVANIA	0054
JVC	0053	THOMSON	0047
LG	0178/0317/ 0457	TOSHIBA	0156
MAGNAVOX	0054	ZENITH	0017
mitsubishi	0150		

Test by turning on the television and changing channels. Repeat the procedure until you find the code that allows correct operation.

- If your television brand is not listed or if the code listed for your television does not allow control of your television, this remote control is not compatible with your television.

### When other Panasonic products respond to this remote control

When other Panasonic products placed nearby affect this unit's remote control, change the remote control code on the main unit and the remote control (the two must match).

Use "1", the factory set code, under normal circumstances.

To change the code on the main unit

- 1 While stopped  
Press [SETUP].
- 2 Press [**▲,▼**] to select "Setup" and press [**▶**].
- 3 Press [**▲,▼**] to select "Remote Control Code" and press [ENTER].
- 4 Press [**▲,▼**] to select the code ("1", "2" or "3") and press [ENTER].

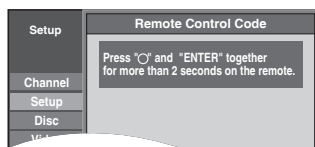

To change the code on the remote control

- 5 While pressing [ENTER], press and hold the numbered button ([1], [2] or [3]) for more than 2 seconds.
- 6 Press [ENTER].

- When the following indicator appears on the unit's display



Press and hold [ENTER] and the indicated number button at the same time for more than 2 seconds.

To exit the screen

Press [SETUP].

To return to the previous screen

Press [RETURN].

## Clock settings

Refer to the control reference on page 14.

### Set Clock Manually

In the case of a power failure, the clock setting remains in memory for approximately 1 minute.

- 1 While stopped  
Press [SETUP].
- 2 Press [**▲,▼**] to select "Setup" and press [**▶**].
- 3 Press [**▲,▼**] to select "Clock Settings" and press [ENTER].
- 4 Press [**▲,▼**] to select "Set Clock Manually" and press [ENTER].

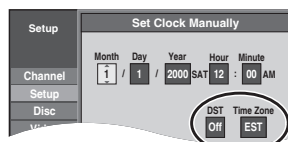

DST, Time Zone (→ below)

- 5 Press [**◀▶**] to select the item you want to change and press [**▲,▼**] to change the setting.
  - DST (Daylight Saving Time): On or Off  
If you select "On", the clock is advanced one hour starting at 2 a.m. on the first Sunday in April and ending at 2 a.m. on the last Sunday in October.
  - Time Zone shows the time difference from Greenwich Mean Time (GMT).
    - EST (Eastern Standard Time) = GMT -5
    - CST (Central Standard Time) = GMT -6
    - MST (Mountain Standard Time) = GMT -7
    - PST (Pacific Standard Time) = GMT -8
    - AST (Alaska Standard Time) = GMT -9
    - HST (Hawaii Standard Time) = GMT -10

- 6 Press [ENTER].

The clock starts.

### Adjust Time Zone

Adjust the time zone (-1 or +1) if it was not set correctly with auto clock setting.

You can set this menu only after "Set Clock Automatically" is completed.

- 1 While stopped  
Press [SETUP].
- 2 Press [**▲,▼**] to select "Setup" and press [**▶**].
- 3 Press [**▲,▼**] to select "Clock Settings" and press [ENTER].
- 4 Press [**▲,▼**] to select "Adjust Time Zone" and press [ENTER].
- 5 Press [**▲,▼**] to select "-1" or "+1" and press [ENTER].

To exit the screen

Press [SETUP].

To return to the previous screen

Press [RETURN].

# Important notes for recording

## Recording of MTS broadcasting

**RAM**

**Both main and secondary audio can be recorded**  
You can change the audio during playback.  
(→ page 23, Changing audio)

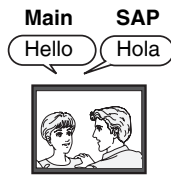

If you record from external equipment  
–Select both “Main” and “SAP” on the external equipment.

**-R -R DL -RW(V) +R +R DL +RW**

**Select the main or secondary audio before recording**  
(→ page 39, “Multi-channel TV Sound ( MTS )”)  
The selected audio only is recorded.



If you record from external equipment  
–Select “Main” or “SAP” on the external equipment.

## Recording of Widescreen broadcasting

**RAM**

**Recorded in 16:9 aspect (Widescreen)**



**-R -R DL -RW(V) +R +R DL +RW**

**Recorded in 4:3 aspect**



## Recording of digital broadcasting

**RAM** (CPRM compatible disc only)



**-R -R DL -RW(V) +R +R DL +RW**



It is not possible to record digital broadcasts that allow “One time only recording” onto DVD-R, DVD-R DL, DVD-RW, +R, +R DL, +RW or 8 cm (3”) DVD-RAM discs. Use a CPRM (→ page 45) compatible DVD-RAM.

## Playing the disc on other DVD players

**-R -R DL -RW(V) +R +R DL**

**The disc must be finalized after recording (→ page 36).**

It is necessary to finalize DVD-R, etc. on this unit after recording or copying titles to them. You can then play them as a commercially sold DVD-Video. However, the discs become play-only and you can no longer record or copy.\*

\* You can record and copy again if you format DVD-RW.



Recorded to DVD-R, etc.



Finalize

Play on other DVD equipment



**+RW**

To enable play on other DVD equipment, please use “Create DVD Top Menu” in DVD Management menu (→ page 36).

## Recording to a DVD-R DL and +R DL

**-R DL +R DL**

DVD-R DL and +R DL discs have two layers of recording surface on one side.

**It is not possible to record continuously from the first layer to the second layer.** Recording stops when space on the first layer becomes full. You must close the first layer to start recording on the second layer. Closing makes the first layer unavailable for recording (editing is still available). You cannot cancel closing. Make certain before proceeding.

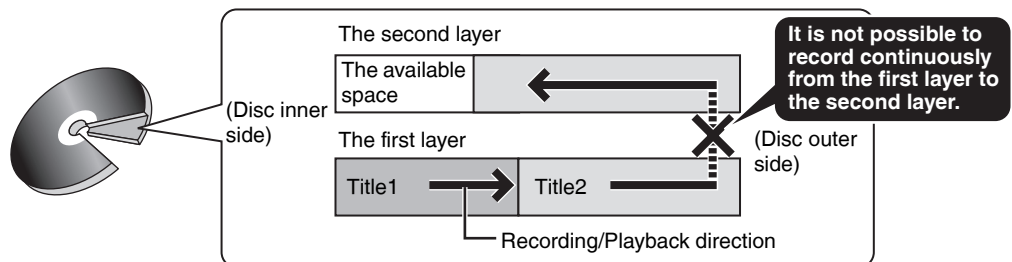



## Recording modes and approximate recording times

Depending on the content being recorded, the recording times may become shorter than indicated.

Recording Mode	DVD-RAM		DVD-R, DVD-RW, +R, +RW 4.7 GB
	4.7 GB	9.4 GB (Double-sided*1)	
XP (High picture quality)	1 h.	2 h.	1 h.
SP (Standard)	2 h.	4 h.	2 h.
LP (Long recording)	4 h.	8 h.	4 h.
EP (Extra long recording)	8 h. (6 h.*2)	16 h. (12 h.*2)	8 h. (6 h.*2)
FR (Flexible Recording)	8 h. maximum	8 h. maximum for one side	8 h. maximum

Recording Mode	DVD-R DL, +R DL*3 8.5 GB	
	First layer (L0)	Second layer (L1)
XP (High picture quality)	55 min.	50 min.
SP (Standard)	1 h. 50 min.	1 h. 40 min.
LP (Long recording)	3 h. 40 min.	3 h. 20 min.
EP (Extra long recording)	7 h. 25 min. (5 h. 30 min.*2)	6 h. 50 min. (5 h. 15 min.*2)
FR (Flexible Recording)	7 h. 25 min. maximum	6 h. 50 min. maximum

\*1 It is not possible to record or play continuously from one side of a double sided disc to the other.

\*2 When "Recording Time in EP Mode" is set to "EP - Extended Play (6H)" in the Setup menu (→ page 38). The sound quality is better when using "EP - Extended Play (6H)" than when using "EP - Extended Play (8H)".

\*3 It is not possible to record continuously from the first layer to the second layer.

### Note

- This unit uses variable bit rate (VBR) recording which varies the amount of data recorded to suit the images, so actual recording times and remaining recording times shown by the unit will be different. (The difference will be especially noticeable with DVD-R DL and +R DL.) Use a disc with plenty of remaining time.
- RAM** When recording to DVD-RAM using EP (8H) mode, play may not be possible on DVD players that are compatible with DVD-RAM. Use EP (6H) mode if playback may be on other equipment.

## Disc Insertion/Ejection

### When the format confirmation screen is displayed

**RAM -RW(V) +R +R DL +RW**

When you insert a new disc and a disc recorded on a computer or other equipment, a format confirmation screen might be displayed. Format the disc to use it. However all the recorded contents are deleted.

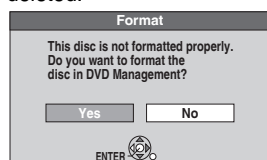

Press [◀▶] to select "Yes" and press [ENTER].

- Several steps are necessary to format a disc. Refer to "Deleting all contents of a disc -Format Disc ( DVD )" (→ page 35).

### FR (Flexible Recording)





The unit automatically selects a recording rate between XP and EP (8H) that will enable the recordings to fit in the remaining disc space with the best possible recording quality.

- You can use FR mode in Scheduled recording (→ page 20, step 3) and Flexible recording (→ page 19).

### Using "FR mode" is convenient in these kind of situations

- When the amount of free space on the disc makes selecting an appropriate recording mode difficult
- When you want to record a long program with the best picture quality possible

e.g., Recording a 90 minutes program to disc

If you select XP mode	
The program will not fit one disc.	
60 minutes → 	+  → 30 minutes
Another disc is necessary.	
If you select SP mode	
The program will fit one disc.	
 → There will be 30 minutes remaining disc space.	
If you select FR mode	
The program will fit one disc perfectly.	
	

### When remove a recorded disc

**-R -R DL -RW(V) +R +R DL**

When you press [▲ OPEN/CLOSE] on the main unit while stopped: The following screen appears when you have not processed the disc for play on other equipment.

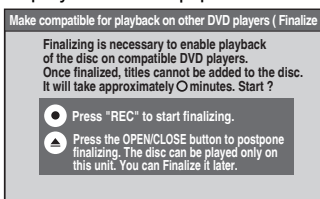

### When finalizing the disc

Press [● REC].

- You cannot stop this process once you have started it.
- If you want to provide the disc with a name or set play menu select, select "Disc Name" (→ page 35) or "Playback will start with." (→ page 36) in "DVD Management" before finalizing.

### When opening the tray without disc finalization

Press [▲ OPEN/CLOSE] on the main unit.

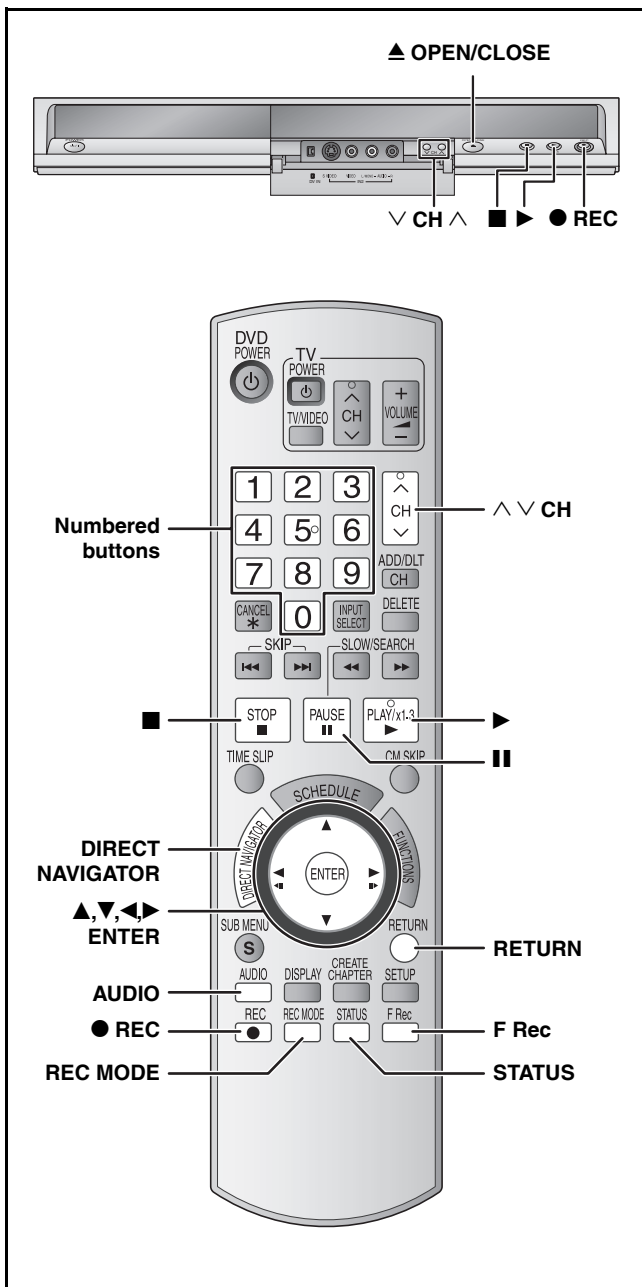

## RAM -R -R DL -RW(V)

- You can record up to 99 titles on one disc.

## +R +R DL +RW

- You can record up to 49 titles on one disc.

See also the notes "Important notes for recording" (→ page 16).

### Note

- +RW** You can create a Top Menu using "Create DVD Top Menu" (→ page 36). Recording or editing on the disc may delete the menu. In that case, create the menu again.
- RAM** It is not possible to record continuously from one side of a double sided disc to the other. You will need to eject the disc and turn it over.

### Preparation

- Turn on the television and select the appropriate video input to suit the connections to this unit.
- Turn the unit on.

### Off Timer

The unit switches to standby after about 6 hours in the stop mode. You can turn this feature off or change the time to 2 hours (→ page 37, "Off Timer").

## 1 Press [▲ OPEN/CLOSE] on the main unit to open the tray and insert a disc.

- Press the button again to close the tray.
- When using 8 cm (3") DVD-RAM, or 8 cm (3") DVD-R, remove the disc from the cartridge.

Insert label-up.

### ■ Cartridge disc

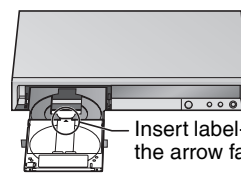
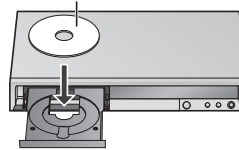

Insert label-up with the arrow facing in.

Insert fully.

## 2 Press [^ ∇ CH] to select the channel.



To select with the numbered buttons:

### Antenna

e.g., 5: [0] → [5]

15: [1] → [5]

### Cable TV

e.g., 5: [0] → [0] → [5]

15: [0] → [1] → [5]

115: [1] → [1] → [5]

- Select the audio to record (→ page 19).

## 3 Press [REC MODE] to select the recording mode (XP, SP, LP, or EP).



Remaining time on the disc

## 4 Press [● REC] to start recording.



The elapsed time is shown on the display.

Recording will take place on free space on disc. Data will not be overwritten.

- You cannot change the channel or recording mode during recording. You can change the channel or recording mode while paused; however, the recording will then be as a separate title.
- You can record while the unit is in standby for scheduled recording, but once the time for the scheduled recording to begin is reached, any recording taking place will stop and the scheduled recording will begin.

### ■ To pause recording

Press [II].

Press again to restart recording.

You can also press [● REC] to restart.

(Title is not split into separate titles.)

### ■ To stop recording

Press [■].

- From the start to the end of the recording is called one title.

### ■ -R -R DL -RW(V) +R +R DL +RW

It takes about 30 seconds for the unit to complete recording management information after recording finishes.

### ■ When recording the channel (not set on this unit) from cable box or satellite receiver

- Select the channel on the equipment before turning the unit on.
- Press [^ ∇ CH] to select IN1 or IN2 in step 2 (→ above).

## To specify a time to stop recording –One Touch Recording

### During recording

Press [● REC] to select the recording time.

- The unit's display changes as shown below.

OFF 0:30 → OFF 1:00 → OFF 1:30 → OFF 2:00  
 ↑ Counter (cancel) ← OFF 4:00 ← OFF 3:00 ←

- This does not work during scheduled recordings (→ page 20) or while using Flexible Recording (→ below).
- If you change the channel or recording mode while recording is paused, the time specified to stop recording is cancelled.
- The unit turns off automatically after the time to stop recording is reached.

### To cancel

Press [● REC] several times until the counter appears.

- The time to stop recording is cancelled; however, recording continues.

### To stop recording partway

Press [■].

## Flexible Recording

(Recording that fits the remaining disc space)

RAM -R -R DL -RW(V) +R +R DL +RW

The unit sets the best possible picture quality that fits the recording within the remaining disc space. The recording mode becomes FR mode. Refer to "FR (Flexible Recording)" (→ page 17).

### Preparation

Select the channel or the external input (IN1, IN2 or DV) to record.

### 1 While stopped

#### Press [F Rec].

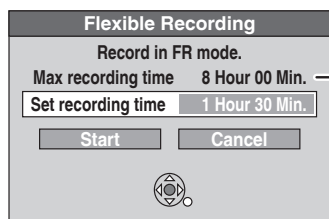

Maximum recording time  
This is the maximum recording time in FR mode.

### 2 Press [◀▶] to select "Hour" and "Min." and press [▲▼] to set the recording time.

- You can also set the recording time with the numbered buttons.
- You cannot record for more than 8 hours.

### 3 When you want to start recording

#### Press [▲▼, ▶▶] to select "Start" and press [ENTER].

Recording starts.

### To exit the screen without recording

Press [RETURN].

e.g., DVD-RAM



Remaining time of recording

### To stop recording partway

Press [■].

### To show the remaining time

Press [STATUS].

## Playing while you are recording

RAM

### Playing from the beginning of the title you are recording–Chasing playback

### Press [▶] (PLAY) during recording.

- There is no sound output while searching forward or backward.

### To stop play

Press [■].

### To stop recording

2 seconds after play stops

Press [■].

### To stop scheduled recording

- Press [■] to stop playing.
- After 2 seconds, press [■].
- Press [◀▶] to select "Stop recording" and press [ENTER].

### Playing a title previously recorded while recording–Simultaneous rec and play

### 1 Press [DIRECT NAVIGATOR] during recording.

### 2 Press [▲, ▼, ▶, ◀] to select a title and press [ENTER].

- There is no sound output while searching forward or backward.

### To stop play

Press [■].

### To stop recording

- Press [■] to stop playing.
- Press [DIRECT NAVIGATOR] to exit screen.
- Press [■].

### To stop scheduled recording

- Press [■] to stop playing.
- Press [DIRECT NAVIGATOR] to exit screen.
- Press [■].
- Press [◀▶] to select "Stop recording" and press [ENTER].

## Selecting audio to record

RAM

### Press [AUDIO].

- Stereo:** Main audio (stereo)
  - If the broadcast is "Mono+SAP", audio will be monaural even if you select Stereo mode.
- SAP Audio:** Secondary audio program (SAP)
  - If recorded in SAP mode, main audio is also recorded.
- Mono:** Main audio (monaural)
  - Select "Mono" if reception is poor during a stereo broadcast.

e.g., "Stereo" is selected

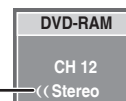

"(" appears when the unit is receiving the audio type you selected.

- If you change the sound setting while recording, the recorded sound will also change.

-R -R DL -RW(V) +R +R DL +RW

Select the audio (Main or SAP) in "Multi-channel TV Sound ( MTS )" in the Setup menu (→ page 39).

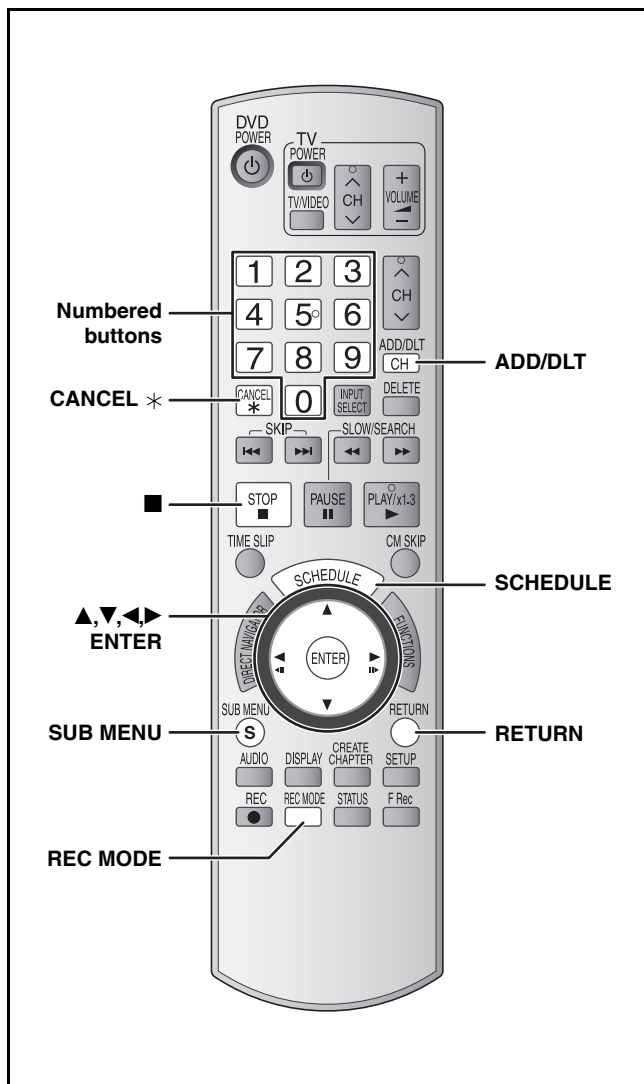

RAM -R -R DL -RW(V) +R +R DL +RW

See also the notes “Important notes for recording” (→ page 16).

You can enter up to 16 programs up to a month in advance. (Each daily or weekly program is counted as one program.)

### Preparation

- Turn on the television and select the appropriate video input to suit the connections to this unit.
- Check that the time on the unit is correct.
- Insert a disc (→ page 18).

## 1 Press [SCHEDULE].

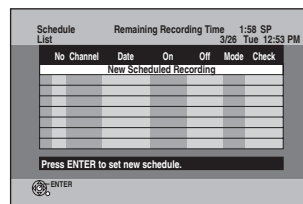

## 2 Press [▲,▼] to select “New Scheduled Recording” and press [ENTER].

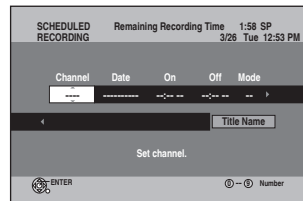

## 3 Press [▶] to move through the items and change the items with [▲,▼].

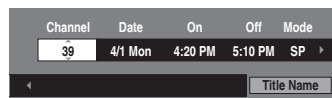

- Press and hold [▲,▼] to alter On (Start time) and Off (Finish time) in 30-minute increments.
- You can also set Channel, Date, On (Start time), and Off (Finish time) with the numbered buttons.
- You can also press [REC MODE] to change the recording mode.

### ■ To set daily or weekly timer

Press [◀▶] to select “Date” and [▲,▼] to select daily timer or weekly timer.

- Date: Current date up to one month later minus one day
- ↓↑
- Daily timer: Sun-Sat → Mon-Sat → Mon-Fri
- ↓↑
- Weekly timer: Weekly, Sun → --- → Weekly, Sat

### ■ To enter title name

Press [◀▶] to select “Title Name” and press [ENTER] (→ page 33, Entering text).

## 4 Press [ENTER].

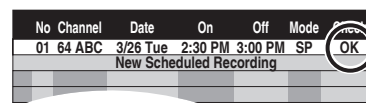

When “!” appears, make sure the disc has a sufficient space.

“!” lights on the unit’s display to indicate scheduled recording standby has been activated.

- Repeat steps 2–4 to schedule other recordings.

### Note

When the disc is removed, scheduled recording standby is cancelled (the “!” indicator goes out). You can put the unit back on standby by inserting a recordable disc (the “!” lights on again).

### ■ To return to the previous screen

Press [RETURN].

### ■ To exit the screen

Press [SCHEDULE].

### ■ When recording the channel (not set on this unit) from cable box or satellite receiver

- ① Press [▲,▼] to select IN1 or IN2 in the channel column (→ above, step 3).
- ② Select the channel on the equipment before the scheduled time.

## Cancel scheduled recording that has already begun

- 1 When the unit is on  
Press [■].  
The confirmation screen appears.
- 2 Press [◀, ▶] to select "Stop recording" and press [ENTER].  
Recording stops and the scheduled recording is cancelled.  
(Daily and weekly schedules remain and scheduled recording will start as programmed.)

## Release program from recording standby

- 1 Press [SCHEDULE].
- 2 Press [▲, ▼] to select the program and press [SUB MENU].
- 3 Press [▲, ▼] to select "Schedule set to Off" and press [ENTER].  
Cancelled icon is displayed in left column.

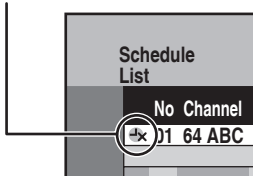

- Be sure to select "Schedule set to On." in step 3 before the scheduled time to put the program on recording standby.

## Notes on scheduled recording

- "Ⓞ" flashes on the unit's display for about 5 seconds when the unit cannot go to scheduled recording standby (e.g., a recordable disc is not in the disc tray).
- Scheduled recordings begin when the set time is reached even when recording or when playing.
- If the unit is turned on when scheduled recording begins, it remains turned on after recording finishes. It does not turn off automatically. You can turn the unit off during scheduled recording.
- If you are making consecutive recordings that will start one after the other, the beginning of the later program cannot be recorded.

e.g., Program① 10:00–11:00  
Program② 11:00–12:00

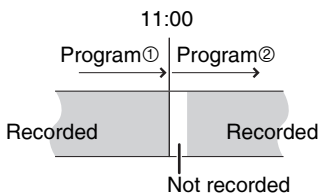

- If the actual broadcasting times of scheduled recordings overlap, the recording that starts first always has priority, and the recording of the later program will start only after the first scheduled recording has finished.
- If you set DST (Daylight Saving Time) to On when manually setting the clock (→ page 15), scheduled recording may not work when summer switches to winter and vice versa.

## Check, change or delete a program

Even when the unit is turned off, you can display the schedule list by pressing [SCHEDULE].

Press [SCHEDULE].

**Icons**

- This program is currently recording.
- Ⓞ The times overlap those in another program.
- ✕ Scheduled recording standby is cancelled. Recording will not start at the scheduled time.
- ⊖ You stopped a weekly or daily scheduled recording. The icon disappears the next time the scheduled program starts recording.
- Ⓛ The disc was full so the program failed to record.
- Ⓜ The material was copy-protected so it was not recorded.
- Ⓧ The program did not complete recording because the disc is dirty or for some other reason.

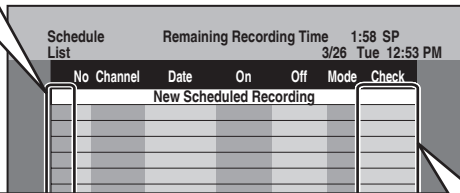

**Message displayed in the Check line**

- OK:** Displayed if the recording can fit in the remaining space.
- **(Date):** For recordings made daily or weekly, the display will show until when recordings can be made (up to a maximum of one month from the present time) based on the time remaining on the disc.
- !:** It may not be possible to record because:
  - no disc is inserted
  - the disc is write-protected
  - there is no more space left
  - the number of possible titles has reached its maximum
  - scheduled recording standby is cancelled
- Overlap:** The times overlap those in another program. Recording of the program with the later start time starts when the earlier program finishes recording.

### To change a program

Press [▲, ▼] to select the program and press [ENTER] (→ page 20, step 3).

- During scheduled recording, you can change the end time as long as the recording mode is not "FR".

### To delete a program

Press [▲, ▼] to select the program and press [CANCEL \*] or [ADD/DLT].

### To cancel recording that has already begun

Press [▲, ▼] to select program and press [SUB MENU], then press [ENTER].

### To exit the schedule list

Press [SCHEDULE].

- Programs that failed to record are displayed gray, and cannot be changed. They are automatically deleted from the schedule list at 4 a.m. two days later.

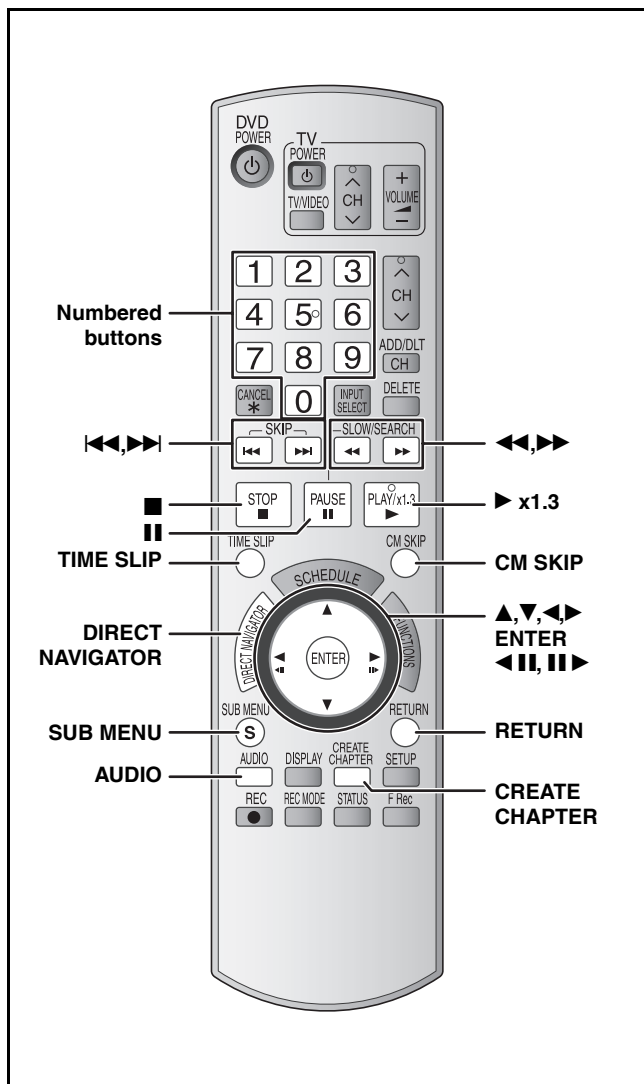

## Preparation

- Turn on the television and select the appropriate video input to suit the connections to this unit.
- Turn on this unit.

**1** Insert a disc (→ page 18).

**2** Press [▶] (PLAY).

**RAM -R -R DL -RW(V) +R +R DL +RW -RW(VR)**

Play starts from the most recently recorded title.

**DVD-V DVD-A CD VCD** and **MP3**

Play starts from the beginning of the disc.

**DivX**

DivX menu screen appears (→ page 24).



### ■ When a menu screen appears on the television

**DVD-V DVD-A**

Press [▲,▼,◀,▶] to select the item and press [ENTER].

Some items can also be selected using the numbered buttons.

**VCD**

Press the numbered buttons to select the item.

e.g., 5: [0] → [5] 15: [1] → [5]

#### • To return to the menu screen

**DVD-V** Press [DIRECT NAVIGATOR] or [SUB MENU].

**DVD-A** Press [DIRECT NAVIGATOR].

**VCD** Press [RETURN].

- The playing method may differ from the one described above depending on disc types. Read the disc's instructions carefully.

### Selecting recorded titles to play

#### -Direct Navigator

**RAM -R -R DL -RW(V) +R +R DL +RW -RW(VR)**

Simply select the recorded titles you want to play from the menu.

**1** Press [DIRECT NAVIGATOR].

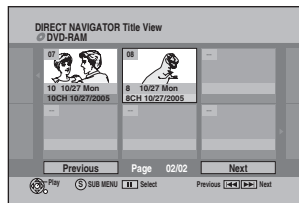

**2** Press [▲,▼,◀,▶] to select the title and press [ENTER].

You can also select titles with the numbered buttons.

e.g., 5: [0] → [5] 15: [1] → [5]

#### To show other pages

Press [◀◀] (Previous) or [▶▶] (Next).

#### To exit the screen

Press [DIRECT NAVIGATOR].

#### Direct Navigator screen icons

- Title protected.
- Title that was not recorded due to recording protection (Digital broadcasts, etc.)
- Title cannot be played because data is damaged.
- Currently recording.
- Title with "One time only recording" restriction

#### Note

- **RAM -R -R DL -RW(V) +R +R DL +RW** The unit stops playing a disc when scheduled recording starts.
- **RAM** Press [▶] (PLAY) when you wish to start playing the disc while recording (→ page 19, "Chasing playback").

## Operations during play

<p>Stop</p>	<p>Press [■]. The stopped position is memorized. <b>Resume play function</b> Press [▶] (PLAY) to restart from this position.</p> <ul style="list-style-type: none"> <li>• <b>VCD</b> Depending on the disc, resume play function may not be effective.</li> <li>• The stopped position is cleared when:               <ul style="list-style-type: none"> <li>– You press [■] several times.</li> <li>– You open the tray.</li> <li>– <b>DVD-A</b> <b>CD</b> <b>VCD</b> and <b>MP3/DivX</b>: You turn the unit off.</li> </ul> </li> </ul>
<p>Pause</p>	<p>Press [⏸]. Press again or press [▶] (PLAY) to restart play.</p>
<p>Search</p>	<p>Press [⏮] or [⏭].</p> <ul style="list-style-type: none"> <li>• The speed increases up to 5 steps (<b>+R</b> <b>+R DL</b> <b>+RW</b> up to 3 steps).</li> <li>• Press [▶] (PLAY) to restart play.</li> <li>• Audio is heard during first level search forward.</li> <li>• <b>DVD-A</b> (excluding motion picture parts) <b>CD</b> and <b>MP3</b>: Audio is heard during all levels of search.</li> <li>• <b>DivX</b>: Audio is not heard during all levels of search.</li> <li>• Depending on the disc, searching may not be possible.</li> </ul>
<p>Skip</p>	<p><b>During play or while paused, press [⏮] or [⏭].</b></p> <p>Skip to the title, chapter or track you want to play.</p> <ul style="list-style-type: none"> <li>• Each press increases the number of skips.</li> <li>• <b>DivX</b>: Backward direction [⏮] only</li> </ul>
<p>Starting from a selected item</p>	<p><b>Press the numbered buttons.</b> Play starts from the selected title, chapter or track.</p> <p>e.g., 5: [0] → [5] <b>CD</b> <b>MP3</b>, <b>JPEG/TIFF</b> and <b>DivX</b> 5: [0] → [0] → [5]          15: [1] → [5] 15: [0] → [1] → [5]</p> <p><b>DVD-A</b> Selecting groups While stopped (screen saver is displayed on the television → right)</p> <p>5: [5]</p> <ul style="list-style-type: none"> <li>• This works only when stopped (screen saver is displayed on the television → above) with some discs.</li> <li>• <b>VCD</b> (with playback control) If you press the numbered buttons while stopped (the above screen saver is displayed on the television) you can cancel PBC. (Elapsed play time appears on the unit's display.)</li> </ul>
<p>Quick View <b>RAM</b></p>	<p><b>Press and hold [▶] (PLAY/x1.3).</b> Play speed is quicker than normal.</p> <ul style="list-style-type: none"> <li>• Press again to return to normal speed.</li> </ul>
<p>Slow-motion</p> <p><b>RAM</b> <b>-R</b> <b>-R DL</b> <b>-RW(V)</b> <b>+R</b> <b>+R DL</b>  <b>+RW</b> <b>DVD-V</b>  <b>DVD-A</b> (Motion picture parts only)  <b>-RW(VR)</b> <b>VCD</b></p>	<p><b>While paused, press [⏮] or [⏭].</b></p> <ul style="list-style-type: none"> <li>• The speed increases up to 5 steps.</li> <li>• Press [▶] (PLAY) to restart play.</li> <li>• <b>VCD</b> Forward direction [⏭] only.</li> <li>• The unit will pause if slow-motion play is continued for approximately 5 minutes (excluding <b>DVD-V</b> <b>DVD-A</b> <b>VCD</b>).</li> </ul>
<p>Frame-by-frame</p> <p><b>RAM</b> <b>-R</b> <b>-R DL</b> <b>-RW(V)</b> <b>+R</b> <b>+R DL</b>  <b>+RW</b> <b>DVD-V</b>  <b>DVD-A</b> (Motion picture parts only)  <b>-RW(VR)</b> <b>VCD</b></p>	<p><b>While paused, press [⏪] or [⏩].</b></p> <ul style="list-style-type: none"> <li>• Each press shows the next frame.</li> <li>• Press and hold to change forward or backward in succession.</li> <li>• Press [▶] (PLAY) to restart play.</li> <li>• <b>VCD</b> Forward direction [⏩] only.</li> </ul>
<p>Skipping the specified time (Time Slip)</p> <p><b>RAM</b> <b>-R</b> <b>-R DL</b> <b>-RW(V)</b> <b>+R</b> <b>+R DL</b>  <b>+RW</b> <b>-RW(VR)</b></p>	<p><b>1 Press [TIME SLIP].</b>  <b>2 Press [▲, ▼] to select the time and press [ENTER].</b></p> <p>Play skips to the specified time.</p> <ul style="list-style-type: none"> <li>• Each time you press [▲, ▼], the time increases [▲] or decreases [▼] by 1 minute intervals. (Press and hold for 10-minute intervals.)</li> </ul>
<p>CM Skip</p> <p><b>RAM</b> <b>-R</b> <b>-R DL</b> <b>-RW(V)</b> <b>+R</b> <b>+R DL</b>  <b>+RW</b> <b>-RW(VR)</b></p>	<p><b>Press [CM SKIP].</b> Play restarts from approximately a minute later.</p>
<p>Changing audio</p>	<p><b>Press [AUDIO].</b>  <b>RAM</b> <b>-RW(VR)</b> <b>VCD</b> and <b>DivX</b> (→ page 26)</p> <p>Stereo → Mono L → Mono R</p> <p>e.g., "Stereo" is selected</p> <ul style="list-style-type: none"> <li>• <b>RAM</b> <b>-RW(VR)</b> When playing an SAP broadcast: Main Audio ↔ SAP Audio</li> <li>• <b>DVD-V</b> <b>DVD-A</b> You can change the audio channel number each time you press the button. This allows you to change things like the soundtrack language.</li> </ul> <p><b>Soundtrack</b> [1 ENG] [Digital 3/2.1ch]</p> <p>e.g., <b>DVD-V</b> English is the selected language (→ page 27, Soundtrack).</p>
<p>Create Chapter <b>RAM</b> (→ page 30, Title/Chapter)</p>	<p><b>Press [CREATE CHAPTER].</b> Chapters are divided at the point pressed.</p> <ul style="list-style-type: none"> <li>• Press [⏮, ⏭] to skip to the start of a chapter.</li> </ul>



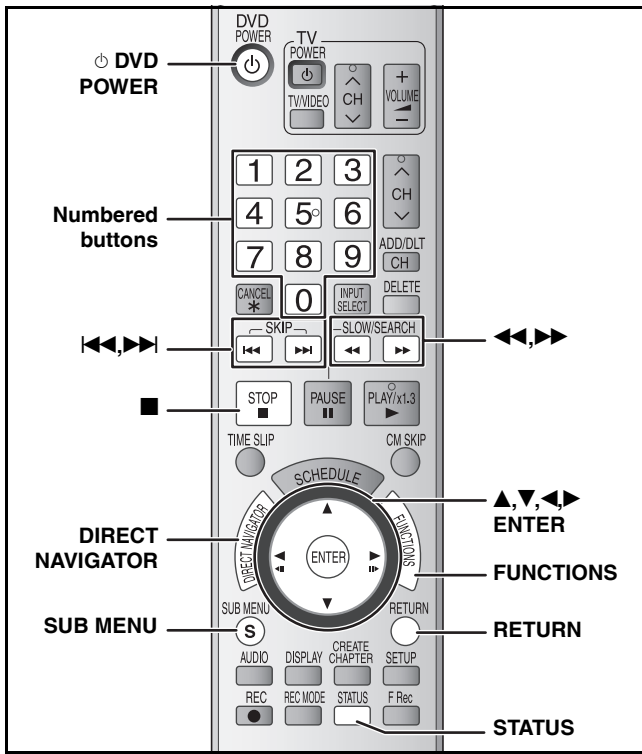

## Selecting file type to play

### CD

You can play CD-R/CD-RW which contain MP3 files, DivX video contents or still pictures that have been recorded on a computer.

The screen shown below is displayed when you insert a disc containing MP3 files, DivX video contents and still pictures (JPEG/TIFF).

e.g.,

Playback mode is set to DivX.  
To play another type of files,  
please select playback mode  
from Menu in FUNCTIONS.



- When playing the file displayed on the screen  
Press [ENTER].
- When playing other file displayed on the screen  
Press [ENTER] and follow the steps below.

### To select file type

## 1 Press [FUNCTIONS].

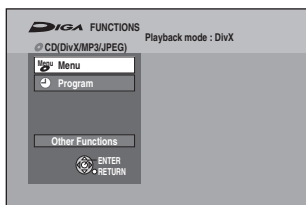

## 2 Press [▲,▼] to select "Menu" and press [ENTER].



## 3 Press [▲,▼] to select playback mode and press [ENTER].

→ right, step 2

## Playing MP3, DivX and still pictures (JPEG/TIFF)

### 1 Press [DIRECT NAVIGATOR].

#### ■ MP3 CD

G: Group no.

T: Track no. in the group

TOTAL: Track No./Total tracks in all groups

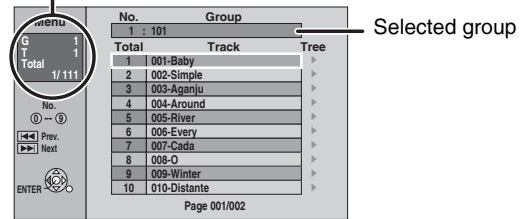

- Files are treated as tracks and folders are treated as groups.
- " " indicates the track currently playing.

#### ■ DivX -R CD

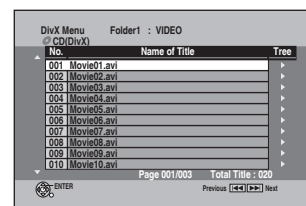

- Files are treated as titles.

#### ■ Still picture (JPEG/TIFF) CD

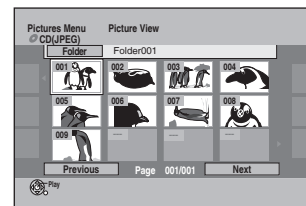

### To switch to other menu

Press [RETURN] and perform steps 1–3 in "To select file type" on the left column.

## 2 Press [▲,▼,◀,▶] to select the file (track, title or picture) and press [ENTER].

Play starts on the selected file (track, title or picture).

- You can also select the file (track, title or picture) with the numbered buttons.

e.g., 5: [0] → [0] → [5]

15: [0] → [1] → [5]

### To show other pages

Press [◀] (Previous) or [▶] (Next).

### To stop playing

Press [■].

- (JPEG) The unit remembers the still picture where you stopped play. This is cleared when you turn the unit off or remove the disc.

### To display the previous or next still picture during play (JPEG)

Press [◀▶].

### To return to the previous screen

Press [RETURN].

### To exit the screen

Press [DIRECT NAVIGATOR].

### Note (DivX)

- Picture sizes set at the recording time may prevent the unit from showing pictures in the adequate aspect. You may be able to adjust the aspect through the TV.
- Successive play is not available.



## To select other folder (group)

MP3, DivX

**1** While the Menu screen is displayed  
Press [▶].

■ MP3 **CD**

**G:** Selected group No. /Total group No.  
If the group has no track, "--" is displayed as group number.

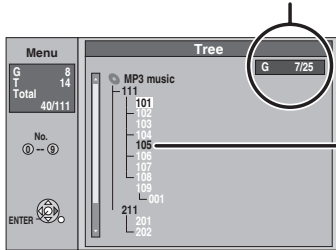

Groups that contain no compatible files.

■ DivX **-R CD**

**F:** Selected folder No./Total folder No. including DivX title

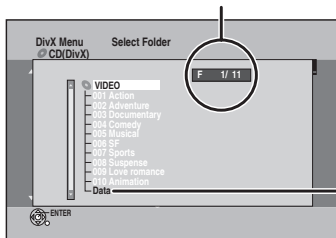

Folders that contain no compatible files.

**2** Press [▲,▼] to select a group (folder) and press [ENTER].  
The file list for the group (folder) appears.

## Still picture

**CD**

**1** While the Pictures Menu is displayed  
Press [▲,▼,◀,▶] to select "Folder" and press [ENTER].

**F:** Selected folder No./Total folder No.

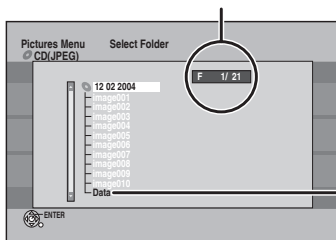

Folders that contain no compatible files.

**2** Press [▲,▼] to select the folder and press [ENTER].

**To return to the previous screen**  
Press [RETURN].

**To exit the screen**  
Press [DIRECT NAVIGATOR].

## Useful functions during still picture play

**CD**

You can display still pictures one by one with constant interval.

**While the Pictures Menu is displayed**

**①** Press [▲,▼,◀,▶] to select "Folder" and press [SUB MENU].

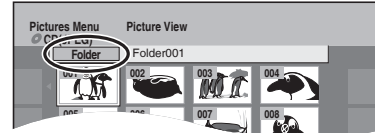

Start SlideShow  
Slide Interval

**②** Press [▲,▼] to select "Start Slide Show" and press [ENTER].

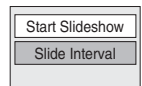

**To change the slide interval**

**①** In step ② above, press [▲,▼] to select "Slide Interval" and press [ENTER].

**②** Press [◀,▶] to select the slide interval and press [ENTER].

- You can select a slide interval between 0-30 seconds.

**While playing**

**①** Press [SUB MENU].

**②** Press [▲,▼] to select "Rotate RIGHT" or "Rotate LEFT" and press [ENTER].

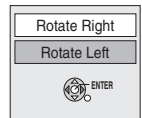

Rotate

**To return the rotated picture to its original position**

Press [▲,▼] to select the opposite rotation in step ② and press [ENTER].

- Rotation information will not be stored.

**While playing**

**①** Press [SUB MENU].

**②** Press [▲,▼] to select "Zoom in" and press [ENTER].

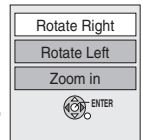

Zoom in  
Zoom out

**To return the picture to its original size**

Press [▲,▼] to select "Zoom out" in step ② and press [ENTER].

- When zooming in, the picture may be cut off.
- The enlargement information will not be stored.
- The "Zoom in/Zoom out" function is only available for still pictures smaller than 640 x 480 pixels.

**While playing**

**Press [STATUS] twice.**



Properties

Shooting date

**To exit the picture properties screen**  
Press [STATUS] again.

Refer to the control reference on page 24.

## Regarding DivX VOD content

**-R CD**

DivX Video-on-Demand (VOD) content is encrypted for copyright protection. In order to play DivX VOD content on this unit, you first need to register the unit.

Follow the on line instructions for purchasing DivX VOD content to enter the unit's registration code and register the unit. For more information about DivX VOD, visit [www.divx.com/vod](http://www.divx.com/vod).

### Display the unit's registration code (→ page 37, "DivX Registration" in "Setup" tab)



- After playing DivX VOD content for the first time, new registration code is then displayed in "DivX Registration". Do not use this registration code to purchase or rent DivX VOD content. If you use this code to purchase DivX VOD content, and then play the content on this unit, you will no longer be able to play any content that you purchased using the old code.
- If you purchase DivX VOD content using a registration code different from this unit's code, you will not be able to play this content. ("Authorization Error." is displayed.)

### Regarding DivX content that can only be played a set number of times

Some DivX VOD content can only be played a set number of times. When you play this content, the remaining number of plays is displayed. You cannot play this content when the number of remaining plays is zero. ("Rental Expired." is displayed.)

When playing this content

- The number of remaining plays is reduced by one if:
  - you press [DVD POWER].
  - you press [STOP].
  - you press [SKIP] or [SEARCH] etc. and arrive at another content or the start of the content being played.
- Resume play function (→ page 23) does not work.

## Regarding MP3, DivX and still pictures

**CD**

- Compatible formats: ISO9660 level 1 or 2 (except for extended formats) and Joliet
- This unit is compatible with multi-session but reading or play of the disc may take time if there are a lot of sessions.
- Operation may take time to complete when there are many files (titles or tracks) and/or folders (groups) and some files (tracks) may not display or be playable.
- English alphabet and Arabic numerals are displayed correctly. Other characters may not be displayed correctly.
- The display order on this unit may differ from how the order is displayed on a computer.
- Depending on how you create the disc (writing software), files (tracks) and folders (groups) may not play in the order you numbered them.
- This unit is not compatible with packet-write format.
- Depending on the recording, some items may not be playable.

### MP3

Playable discs	<b>CD</b>
File format	MP3 <ul style="list-style-type: none"> <li>• Files must have the extension ".mp3" or ".MP3".</li> </ul>
Maximum number of folders (groups)	99 Recognizable folders per disc on this unit (including the root folder)
Maximum number of files (tracks)	999 Recognizable files per disc on this unit <sup>*1</sup>
Bit rates	32 kbps to 320 kbps
Sampling frequency	16 kHz/22.05 kHz/24 kHz/32 kHz/44.1 kHz/48 kHz
ID3 tags	Not compatible

- If there is a large amount of still picture data etc. within an MP3 file, play may not be possible.

### DivX

Playable discs	<b>-R CD</b>
File format	DivX <ul style="list-style-type: none"> <li>• Files must have the extension ".DIVX", ".divx", ".AVI" or ".avi".</li> </ul> 
Maximum number of folders	300 Recognizable folders per disc on this unit (including the root folder)
Maximum number of files	200 Recognizable DivX files per disc on this unit <sup>*1</sup>
Support version	Plays all versions of DivX video (including DivX 6) with standard playback of DivX media files. Certified to the DivX Home Theater Profile. <p>Video</p> <ul style="list-style-type: none"> <li>– Number of stream: Up to 1</li> <li>– Codec: DIV3, DIV4, DIVX, DV50</li> <li>– Picture size: 32 x 32 to 720 x 576</li> <li>– FPS (Frame Per Second): Up to 30 fps</li> </ul> <p>Audio</p> <ul style="list-style-type: none"> <li>– Number of stream: Up to 8</li> <li>– Format: MP3, Dolby Digital, MPEG</li> <li>– Multi channel: Dolby Digital is possible. MPEG multi is 2ch conversion.</li> </ul> <ul style="list-style-type: none"> <li>• GMC (Global Motion Compensation) is not supported.</li> </ul>

### Still pictures (JPEG/TIFF<sup>\*2</sup>)

Playable discs	<b>CD</b>
File format	JPEG, TIFF (non-compressed RGB chunky format) <ul style="list-style-type: none"> <li>• Files must have the extension ".jpg", ".JPG", ".tif" or ".TIF".</li> </ul>
Number of pixels	between 34 x 34 and 6144 x 4096 pixels (Sub sampling is 4:2:2 or 4:2:0)
Maximum number of folders	99 Recognizable folders per disc on this unit (including the root folder)
Maximum number of files	999 Recognizable files per disc on this unit <sup>*1</sup>
MOTION JPEG	Not compatible

<sup>\*1</sup> Total number of recognizable file including MP3, JPEG, DivX and other type of files is 4000.

<sup>\*2</sup> Operation may take time to complete when playing TIFF format still pictures, or when there are many files and/or folders, some files may not display or be playable.

**You can play MP3 and still pictures (JPEG/TIFF) on this unit by making folders as shown below. However depending on how you create the disc (writing software), play may not be in the order you numbered the folders.**

**CD**

**Structure of MP3 folders**

Prefix with 3-digit numbers in the order you want to play them.

**CD**

**Structure of still pictures (JPEG/TIFF)**

Files inside a folder are displayed in the order they were updated or taken.

- When the highest level folders are "DCIM" folders, they are displayed first on the tree.

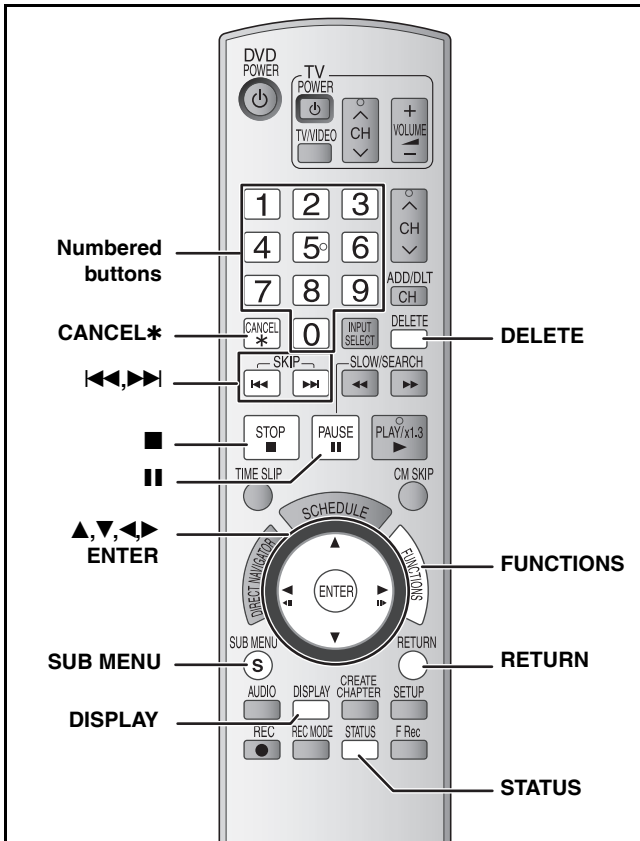

## Using on-screen menus

### Common procedures

#### 1 Press [DISPLAY].

Menu	Item	Setting
Disc	Soundtrack	1 DD Digital 2/0 ch
Play	Subtitle	Off
Video	Audio channel	L R
Audio		
Other		

• Depending on the condition of the unit (playing, stopped, etc.) and disc contents, there are some items that you cannot select or change.

#### 2 Press [▲, ▼] to select the menu and press [▶].

#### 3 Press [▲, ▼] to select the item and press [▶].

#### 4 Press [▲, ▼] to select the setting.

• Some items can be changed by pressing [ENTER].

#### To clear the on-screen menus

Press [DISPLAY].

### Disc menu—Setting disc content

#### Soundtrack\* DVD-V DVD-A

Select the audio and language (→ right, Audio attribute, Language).

**RAM -R -R DL -RW(V) +R +R DL +RW -RW(VR)**

The disc's audio attributes appear.

#### DivX

Select the soundtrack number.

• Soundtrack numbers are displayed even when there is only one audio type.

#### Subtitle\* DVD-V DVD-A

Turn the subtitle on/off and select the language (→ below, Language).

**RAM -R -R DL -RW(V) +R +R DL +RW -RW(VR)**

(Only discs that contain subtitle on/off information)

Turn the subtitle on/off.

• Subtitle on/off information cannot be recorded using this unit.

• If the subtitles overlap closed captions recorded on discs, turn the subtitles off.

#### DivX

Turn the subtitle on/off and select the subtitle number.

• Subtitle numbers are displayed even if there are not multiple subtitles.

#### Audio channel RAM -RW(VR) VCD and DivX

→ page 23, Changing audio

#### Angle\* DVD-V DVD-A

Change the number to select an angle.

#### Still-P (Still picture) DVD-A

Selects the play method for still pictures.

**Slide Show:** Plays according to the default order on the disc.

**Page:** Select the still picture number and play.

• **RANDOM:** Plays in random order.

• **Return:** Returns to the default still picture on the disc.

#### Source Select (DivX)

• **Automatic:** The constructing method of the DivX contents is automatically distinguished and output.

• **Interlace:** Select when the disc contents were recorded using interlace.

• **Progressive:** Select when the disc contents were recorded using progressive.

#### PBC (Playback control → page 45) VCD

Indicates whether menu play (playback control) is on or off (unchangeable).

\* With some discs, you may only be able to make changes using the menus (→ page 22) on the disc.

• The display changes according to the disc content. You cannot change anything when there is no recording.

#### Audio attribute

LPCM/PPCM/□□ Digital/DTS/MPEG:	Signal type
k (kHz):	Sampling frequency
b (bit):	Number of bits
ch (channel):	Number of channels

#### Language

ENG: English	DAN: Danish	THA: Thai
FRA: French	POR: Portuguese	POL: Polish
DEU: German	RUS: Russian	CES: Czech
ITA: Italian	JPN: Japanese	SLK: Slovak
ESP: Spanish	CHI: Chinese	HUN: Hungarian
NLD: Dutch	KOR: Korean	FIN: Finnish
SVE: Swedish	MAL: Malay	*: Others
NOR: Norwegian	VIE: Vietnamese	

### Play menu—Change play sequence

This function works only when the elapsed play time is displayed. Select the item for repeat play. Depending on the disc, the items that can be selected will differ.

#### Repeat play

- All **CD VCD**
- Chapter **RAM -R -R DL -RW(V) +R +R DL +RW DVD-V -RW(VR)**
- Group **DVD-A and MP3**
- Playlists **RAM -RW(VR)**
- Title **RAM -R -R DL -RW(V) +R +R DL +RW DVD-V -RW(VR)**
- Track **DVD-A CD VCD and MP3**  
Select "Off" to cancel.

Refer to the control reference on page 27.

**Video menu—Change picture quality**

**Picture**

RAM -R -R DL -RW(V) +R +R DL +RW DVD-V DVD-A  
-RW(VR) VCD

Select the picture mode.

- **Normal:** Default setting
- **Soft:** Soft picture with fewer video artifacts
- **Fine:** Details are sharper
- **Cinema:** Mellows movies, enhances detail in dark scenes.

**DNR**

RAM -R -R DL -RW(V) +R +R DL +RW DVD-V DVD-A  
-RW(VR) VCD and DivX

Reduces noise and picture degradation.  
On↔Off

**Progressive**

[Only when you have selected “480p” in “TV Type” (→ page 14).]

Select “On” to enable progressive output.

- Select “Off” if the picture is stretched horizontally.
- When progressive output is on, closed captions cannot be displayed.

**Transfer** [Only when “Progressive” (→ above) is set to “On”.]

Select the method of conversion for progressive output to suit the type of material being played (→ page 45, Film and video).

- **Auto1 (normal):** Automatically detects the film and video content, and appropriately converts it.
- **Auto2:** In addition to “Auto1”, automatically detects film contents with different frame rates and appropriately converts it.
- **Video:** Select when using “Auto1” and “Auto2”, and the video content is distorted.

**Line-in NR** (Only when IN1, IN2 or DV is selected.)

Reduces video tape noise while copying.  
Depending on the video signal, jittering may occur.

- **Automatic:** Noise reduction only works on picture input from a video tape.
- **On:** Noise reduction works for any video input.
- **Off:** Noise reduction is off. Select when you want to record input as it is.

**Audio menu—Change sound effect**

**V. Surround Sound**

RAM -R -R DL -RW(V) +R +R DL +RW DVD-V DVD-A  
-RW(VR)

(Dolby Digital, 2-channel or over only)

Enjoy a surround-like effect if you are using two front speakers only.

- Turn V. Surround Sound off if it causes distortion.
- Turn off the surround function on the connected equipment.
- V. Surround Sound does not work for SAP recordings.

**Dialog Enhancer**

RAM -R -R DL -RW(V) +R +R DL +RW DVD-V DVD-A  
-RW(VR) and DivX

(Dolby Digital, 3-channel or over only, including a center channel)

The volume of the center channel is raised to make dialog easier to hear.

**Other menu—Change the display position**

**Position**

1 (Standard) - 5: The higher the setting the lower the screen moves.

**FUNCTIONS window**

By using the FUNCTIONS window you may access the main functions quickly and easily.

- 1 While stopped  
Press [FUNCTIONS].

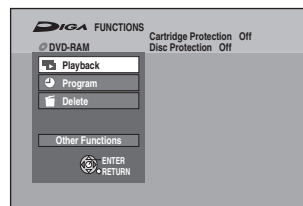

Functions displayed depend on the type of disc.

- 2 Press [▲,▼] to select an item and press [ENTER].

- If you select “Other Functions”, press [▲,▼] to select an item and press [ENTER].

**To exit the FUNCTIONS window**

Press [FUNCTIONS].

**Status messages**

Status messages appear on the television during operation to show the condition of the unit.

**Press [STATUS].**

The display changes each time you press the button.

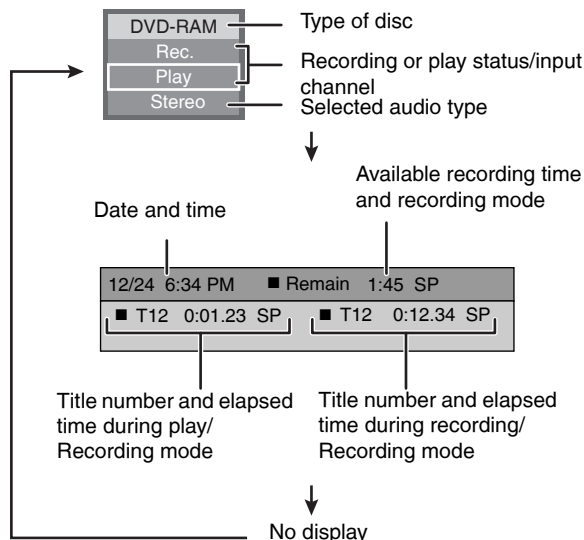

## Entering text

Refer to the control reference on page 27.

**RAM -R -R DL -RW(V) +R +R DL +RW**

You can give names to recorded titles, etc.

The maximum number of characters:

RAM	Characters	-R -R DL -RW(V) +R +R DL +RW	Characters
Title	64 (44*)	Title	44
Playlist	64	Disc	40
Disc	64		

\* Scheduled recording

If a name is long, parts of it may not be shown in some screens.

### 1 Show Enter Name screen.

Title (scheduled recording)	(→ page 20, Step 3)
Title	(→ page 30, Step 3)
Playlist	(→ page 33, Step 5)
Disc	(→ page 35, "Providing a disc with a name -Disc Name")

**-R -R DL -RW(V) +R +R DL**

If you enter a long name, only part of it is shown in the Top Menu after finalization (→ page 36). When entering a title name, the name that will appear in the Top Menu can be previewed in "Top Menu Preview (Finalized Disc)" window.

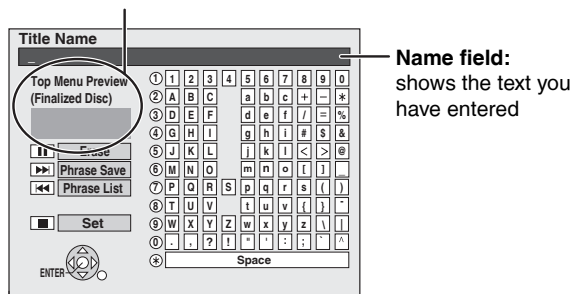

**Name field:**  
shows the text you have entered

### 2 Press [▲,▼,◀,▶] to select a character and press [ENTER].

Repeat this step to enter other characters.

#### • To erase a character

Press [▲,▼,◀,▶] to select the character in the name field and press [II].

#### • Using the numbered buttons to enter characters

e.g., entering the letter "R"

① Press [7] to move to the 7th row.

② Press [7] twice to highlight "R".

③ Press [ENTER].

#### • To enter a space

Press [CANCEL \*] and press [ENTER].

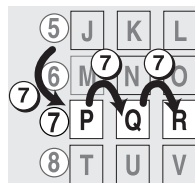

### 3 Press [■] (Set).

Returns to the previously displayed screen.

#### To end partway

Press [RETURN].

Text is not saved.

#### ■ To save frequently used phrases

You can add frequently used phrases and recall them later.

Maximum number of saved phrases: 20

Maximum number of characters per phrase: 20

After entering the phrase (→above, steps 1-2)

1 Press [▶▶] while the phrase to be saved is shown in the name field.

2 Press [◀] to select "Save" and press [ENTER].

• To cancel saving phrase

Press [RETURN].

#### ■ To recall a saved phrase

1 Press [◀◀].

2 Press [▲,▼,◀,▶] to select the phrase to be recalled and press [ENTER].

#### ■ To erase a saved phrase

1 Press [◀◀].

2 Press [▲,▼,◀,▶] to select the phrase to be erased and press [SUB MENU].

3 Press [ENTER].

4 Press [◀] to select "Erase" and press [ENTER].

5 Press [RETURN].

## Deleting titles

Refer to the control reference on page 27.

**RAM -R -R DL -RW(V) +R +R DL +RW**

• A title cannot be restored once it is deleted.

Make certain before proceeding.

• You cannot delete while recording.

**RAM**

When a recorded title is deleted the available disc space will increase by the amount deleted.

The available disc space increases if any of these is deleted.

Title1	Title2	----	The last recorded title	The available space
--------	--------	------	-------------------------	---------------------

**-RW(V) +RW**

Disc space increases only when the last recorded title is deleted.

The available space does not increase if these are deleted. When deleted, the available disc space increases.

Title1	Title2	----	The last recorded title	The available space
--------	--------	------	-------------------------	---------------------

**-R -R DL +R +R DL**

Available space does not increase after deletion.

## Selecting recorded titles to delete -Delete Navigator

### Preparation

- Turn on the television and select the appropriate video input to suit the connections to this unit.
- Turn the unit on.
- Insert a disc (→ page 18).

### 1 While stopped

Press [FUNCTIONS].

### 2 Press [▲,▼] to select "Delete" and press [ENTER].

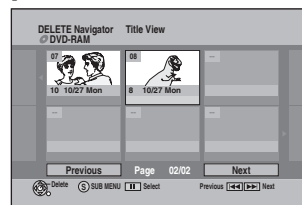

### 3 Press [▲,▼,◀,▶] to select the title and press [ENTER].

#### To show other pages

Press [◀◀] (Previous) or [▶▶] (Next).

#### Multiple deleting

Select with [▲,▼,◀,▶] and press [II]. (Repeat.)

• A check mark appears. Press [II] again to cancel.

### 4 Press [◀,▶] to select "Delete" and press [ENTER].

#### To return to the previous screen

Press [RETURN].

#### To exit the screen

Press [RETURN] several times.

## Deleting title during play

### 1 While playing

Press [DELETE].

### 2 Press [◀,▶] to select "Delete" and press [ENTER].

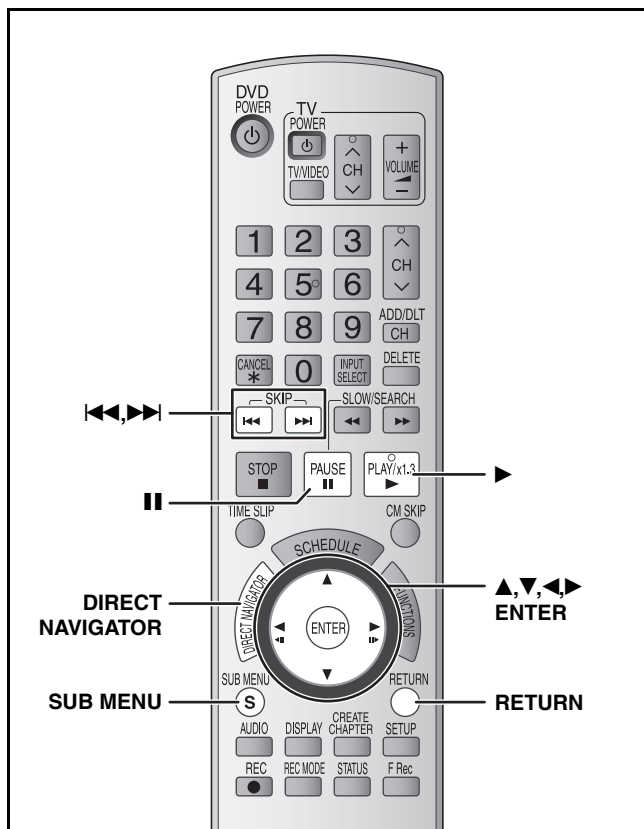

**RAM** -R -R DL -RW(V) +R +R DL +RW -RW(VR)

## Title/Chapter

Programs are recorded as a single title consisting of one chapter.

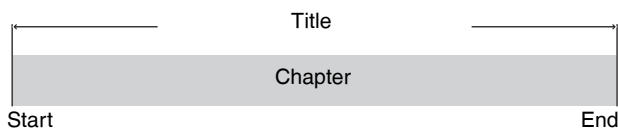

You can divide a title into multiple chapters. **RAM**  
(→ page 23, 31, Create Chapter)

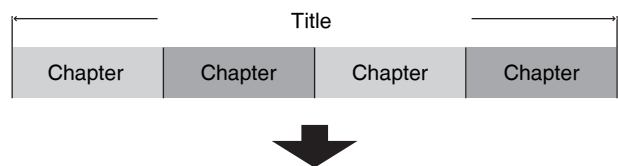

**RAM** You can change the order of chapters and create a playlist  
(→ page 32).

- **-R -R DL -RW(V) +R +R DL** Titles are divided into about 5-minute **(+R +R DL 8-minute)** chapters after finalizing (→ page 36).

- The maximum number of items on a disc:

- Titles: 99 **(+R +R DL +RW 49 titles)**
- Chapters: Approximately 1000 **(+R +R DL +RW Approximately 254)**  
Depends on the state of recording.

## Note

- Once deleted, divided or shortened, a title cannot be restored to its original state. Make certain before proceeding.
- You cannot edit during recording.
- **+RW** You can create a Top Menu using "Create DVD Top Menu" (→ page 36). Recording or editing on the disc may delete the menu. In that case, create the menu again.
- **+R +R DL** Management information is recorded in unused sections when you edit discs. The available space on these discs decreases each time you edit their contents.

## Preparation

- Turn on the television and select the appropriate video input to suit the connections to this unit.
- Turn the unit on.
- Insert a disc (→ page 18).
- **RAM** Release protection (→ page 35).

## Editing titles/chapters and playing chapters

- 1 During play or while stopped  
Press [DIRECT NAVIGATOR].
- 2 Press [**▲,▼,◀,▶**] to select the title.

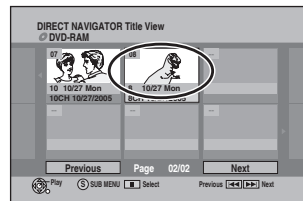

### To show other pages

Press [**◀◀**] (Previous) or [**▶▶**] (Next).

### Multiple editing

Select with [**▲,▼,◀,▶**] and press [**||**]. (Repeat.)

- A check mark appears. Press [**||**] again to cancel.

- 3 Press [SUB MENU], then press [**▲,▼**] to select the operation and press [ENTER].

- If you select "Edit Title", press [**▲,▼**] to select the operation and press [ENTER] (→ page 31).

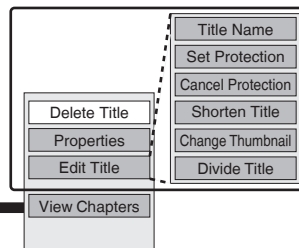

Refer to "Title operations" (→ page 31).

If you select "View Chapters" (→ Step 4)

- 4 Press [**▲,▼,◀,▶**] to select the chapter.

To start play → Press [ENTER].

To edit → Step 5

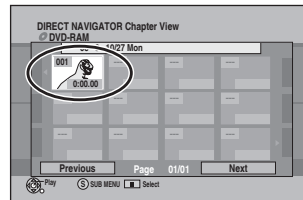

- To show other pages/Multiple editing (→ above)

- 5 Press [SUB MENU], then press [**▲,▼**] to select the operation and press [ENTER].

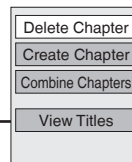

Refer to "Chapter operations" (→ page 31).

- You can go back to the Title View.

### To exit the screen

Press [DIRECT NAVIGATOR].

### To return to the previous screen

Press [RETURN].

## Title operations

After performing steps 1–3 (→ page 30)

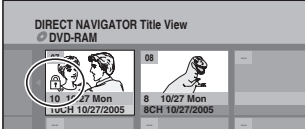
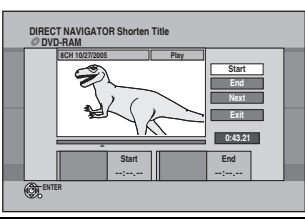
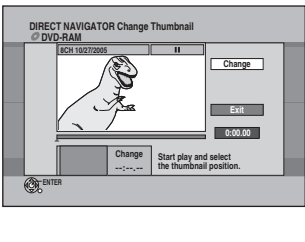
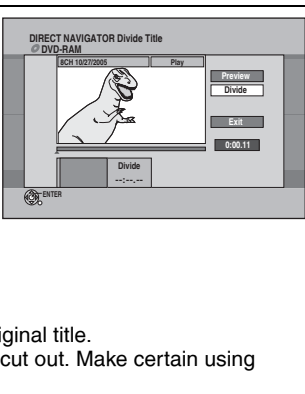
<p><b>Delete Title*</b></p> <p>RAM -R -R DL -RW(V) +R +R DL +RW</p>	<p>Press [◀▶] to select “Delete” and press [ENTER].</p> <ul style="list-style-type: none"> <li>Once deleted, the recorded contents are lost and cannot be restored. Make certain before proceeding.</li> <li>-R -R DL +R +R DL The available recording space does not increase when you delete titles.</li> <li>-RW(V) +RW Available recording space increases only when the last recorded title is deleted. It does not increase if other titles are deleted.</li> </ul>	
<p><b>Properties</b></p> <p>RAM -R -R DL -RW(V) +R +R DL +RW -RW(VR)</p>	<p>Information (e.g., time and date) is shown.</p> <ul style="list-style-type: none"> <li>Press [ENTER] to exit the screen.</li> </ul>	
<p><b>Title Name</b></p> <p>RAM -R -R DL -RW(V) +R +R DL +RW</p>	<p>You can give names to recorded titles.</p> <p>→ page 29, Entering text</p>	
<p><b>Set Protection*</b> <b>Cancel Protection*</b></p> <p>RAM +R +R DL +RW</p>	<p>If set, this will protect the title from accidental deletion.</p> <p>Press [◀▶] to select “Yes” and press [ENTER].</p> <p>The lock symbol appears when the title is protected.</p>	
<p><b>Shorten Title</b></p> <p>RAM (→ below, “For quicker editing”)</p>	<p>You can remove unnecessary parts of the recording such as commercials.</p> <ol style="list-style-type: none"> <li>Press [ENTER] at the start point and end point of the section you want to delete.</li> <li>Press [▲,▼] to select “Exit” and press [ENTER]. Select “Next” and press [ENTER] to delete other sections.</li> <li>Press [◀▶] to select “Delete” and press [ENTER].</li> </ol>	
<p><b>Change Thumbnail</b></p> <p>RAM -R -R DL -RW(V) +R +R DL +RW (→ below, “For quicker editing”)</p>	<p>You can change the image to be shown as a thumbnail picture in the Title View.</p> <ol style="list-style-type: none"> <li>Press [▶] (PLAY) to start play.</li> <li>Press [ENTER] when the image you want to use as a thumbnail is shown. To change the thumbnail Restart play and press [▲,▼] to select “Change”, then press [ENTER] at the point you want to use as the thumbnail.</li> <li>Press [▲,▼] to select “Exit” and press [ENTER].</li> </ol>	
<p><b>Divide Title</b></p> <p>RAM (→ below, “For quicker editing”)</p>	<p>You can divide a title into two.</p> <ol style="list-style-type: none"> <li>Press [ENTER] at the point you want to divide the title.</li> <li>Press [▲,▼] to select “Exit” and press [ENTER].</li> <li>Press [◀▶] to select “Divide” and press [ENTER].</li> </ol> <p>To confirm the division point Press [▲,▼] to select “Preview” and press [ENTER]. (The unit plays 10 seconds before and after the division point.)</p> <p>To change the division point Restart play and press [▲,▼] to select “Divide”, then press [ENTER] at the point you want to divide.</p> <p><b>Note</b></p> <ul style="list-style-type: none"> <li>The divided titles retain the name and CPRM property (→ page 45) of the original title.</li> <li>Video and audio just before and after the dividing point may momentarily be cut out. Make certain using “Preview” function (→ above) before proceeding.</li> </ul>	

\* Multiple editing is possible.

## Chapter operations

After performing steps 1–5 (→ page 30)

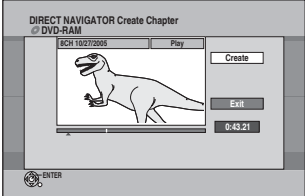
<p><b>Delete Chapter*</b></p> <p>RAM</p>	<p>Press [◀▶] to select “Delete” and press [ENTER].</p> <ul style="list-style-type: none"> <li>Once deleted, the recorded contents are lost and cannot be restored. Make certain before proceeding.</li> </ul>	
<p><b>Create Chapter</b></p> <p>RAM (→ below, “For quicker editing”)</p>	<p>Select the point where you want to start a new chapter while viewing the title.</p> <ol style="list-style-type: none"> <li>Press [ENTER] at the point you want to divide. <ul style="list-style-type: none"> <li>Repeat this step to divide at other points.</li> </ul> </li> <li>Press [▲,▼] to select “Exit” and press [ENTER].</li> </ol>	
<p><b>Combine Chapters</b></p> <p>RAM</p>	<p>Press [◀▶] to select “Combine” and press [ENTER].</p> <ul style="list-style-type: none"> <li>The selected chapter and following chapter are combined.</li> </ul>	

\* Multiple editing is possible.

### For quicker editing

- Use search, Time Slip or slow-motion (→ page 23) to find the desired point.
- To skip to the start or end of a title, press [◀◀] (start) or [▶▶] (end).

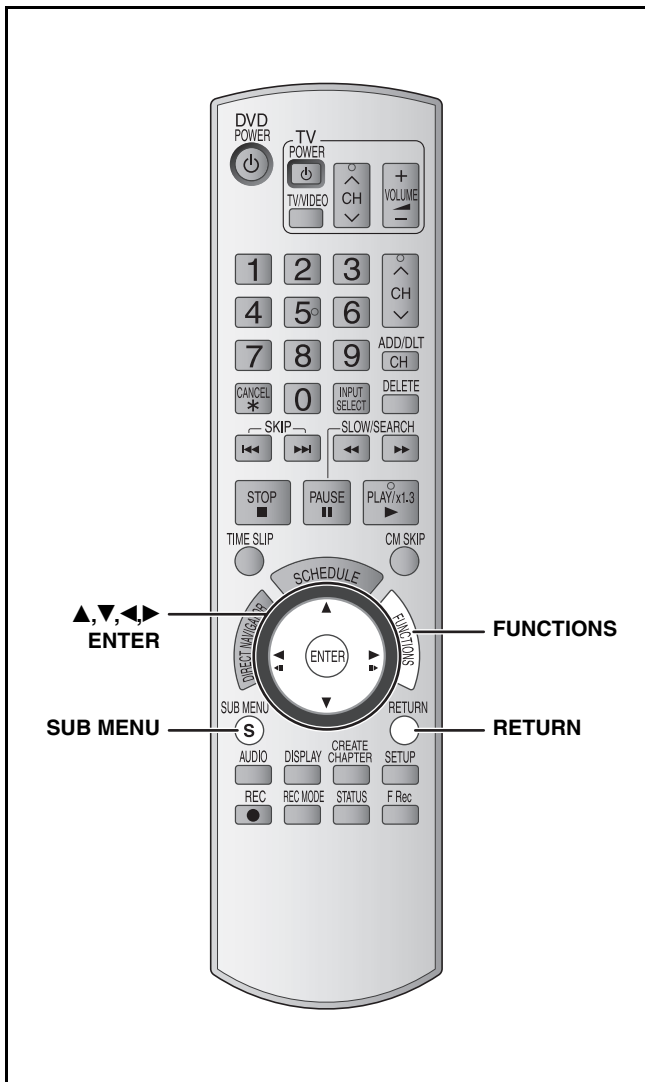

You can arrange the chapters (→ page 30) to create a playlist.

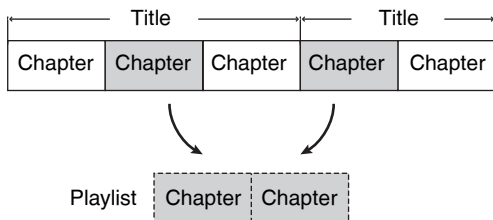

- Editing playlists doesn't modify the recorded data. Playlists are not recorded separately so this doesn't use much capacity.
- You cannot create or edit a playlist while recording.

## RAM

- The maximum number of items on a disc:
  - Playlists: 99
  - Chapters in playlists: Approximately 1000  
Depends on the state of recording.
- If you exceed the maximum numbers of items for a disc, all the items entered will not be recorded.

## Preparation

- Turn on the television and select the appropriate video input to suit the connections to this unit.
- Turn the unit on.
- Insert a disc (→ page 18).
- Release disc or cartridge protection (→ page 35).

## Creating playlists

- 1 While stopped  
Press [FUNCTIONS].
- 2 Press [▲,▼] to select “Other Functions” and press [ENTER].

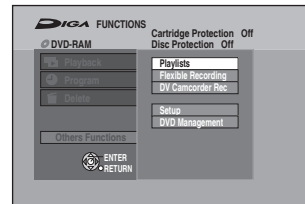

- 3 Press [▲,▼] to select “Playlists” and press [ENTER].
- 4 Press [▲,▼,◀,▶] to select “Create” and press [ENTER].

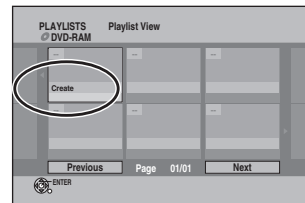

- 5 Press [◀,▶] to select the source title and press [▼].  
Press [ENTER] to select all the chapters in the title, then skip to step 7.

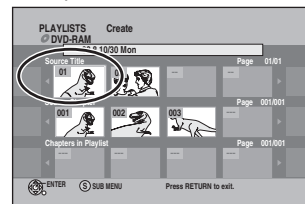

- 6 Press [◀,▶] to select the chapter you want to add to a playlist and press [ENTER].  
Press [▲] to cancel.

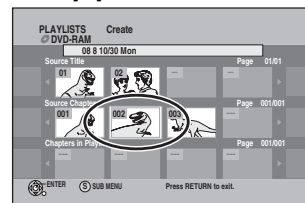

- You can also create a new chapter from the source title. Press [SUB MENU] to select “Create Chapter” and press [ENTER] (→ page 31, “Create Chapter”).

- 7 Press [◀,▶] to select the position to insert the chapter and press [ENTER].

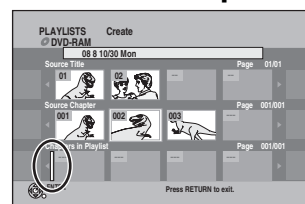

- Press [▲] to select other source titles.
- Repeat steps 5–7 to add other chapters.

- 8 Press [RETURN].

## To exit the screen

Press [RETURN] several times.

## To return to the previous screen

Press [RETURN].



## Editing and playing playlists/chapters

**RAM** -RW(VR) (play only)

- 1** While stopped  
Press [FUNCTIONS].
- 2** Press [▲,▼] to select “Other Functions” and press [ENTER].
- 3** Press [▲,▼] to select “Playlists” and press [ENTER].
- 4** Press [▲,▼,◀,▶] to select the playlist.  
To start play → Press [ENTER].  
To edit → Step 5

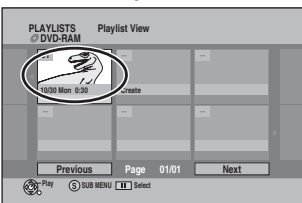

- To show other pages/Multiple editing (→ page 30)

- 5** Press [SUB MENU], then press [▲,▼] to select the operation and press [ENTER].  
• If you select “Edit”, press [▲,▼] to select the operation and press [ENTER].

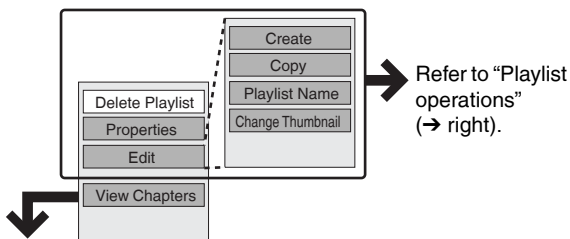

If you select “View Chapters” (→ Step 6)

- 6** Press [▲,▼,◀,▶] to select the chapter.  
To start play → Press [ENTER].  
To edit → Step 7

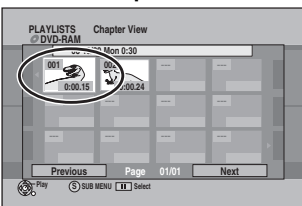

- To show other pages/Multiple editing (→ page 30)

- 7** Press [SUB MENU], then press [▲,▼] to select the operation and press [ENTER].

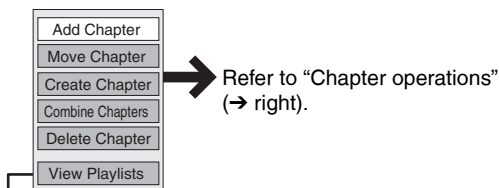

- You can go back to the Playlist View.

### To exit the screen

Press [RETURN] several times.

### To return to the previous screen

Press [RETURN].

## Playlist operations

After performing steps 1–5 (→ left)

Delete Playlist* <b>RAM</b>	Press [◀▶] to select “Delete” and press [ENTER]. Once deleted, the playlists are lost and cannot be restored. Make certain before proceeding.
Properties <b>RAM</b> -RW(VR)	Playlist information (e.g., length and date) is shown. • Press [ENTER] to exit the screen.
Create <b>RAM</b>	→ page 32, Creating playlists, steps 5–8
Copy* <b>RAM</b>	Press [◀▶] to select “Copy” and press [ENTER]. • The copied playlist becomes the newest one in the playlist view screen.
Playlist Name <b>RAM</b>	→ page 29, Entering text
Change Thumbnail <b>RAM</b>	→ page 31, Change Thumbnail

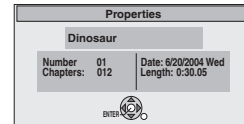

\* Multiple editing is possible.

## Chapter operations

**RAM**

After performing steps 1–7 (→ left)

- Editing chapters in a playlist does not modify the source titles and source chapters.

Add Chapter	→ page 32, Creating playlists, steps 5–8
Move Chapter	Press [▲,▼,◀,▶] to select the position to insert the chapter and press [ENTER].
Create Chapter	→ page 31, Create Chapter
Combine Chapters	→ page 31, Combine Chapters
Delete Chapter* Delete Chapter*	→ page 31, Delete Chapter The playlist itself is deleted if you delete all the chapters in it.

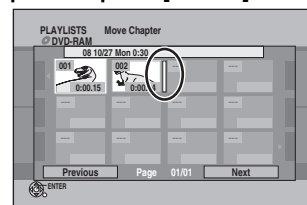

\* Multiple editing is possible.

# Copying from a video cassette recorder

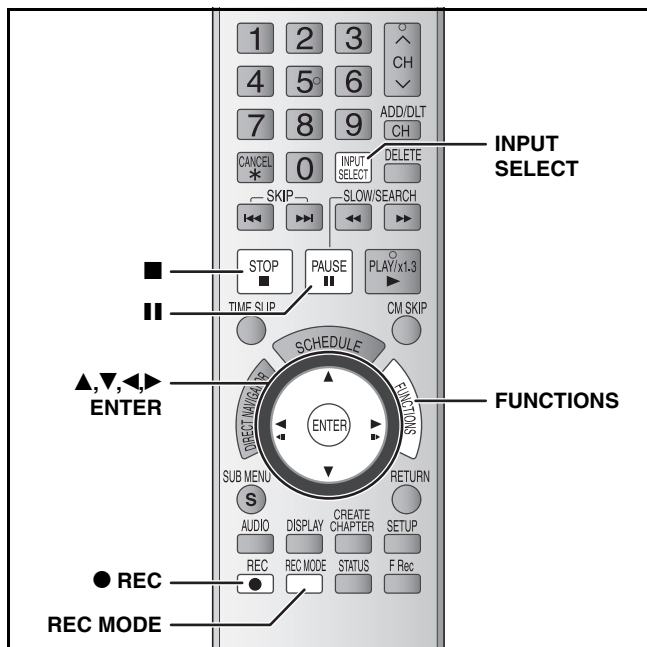

- 1** While stopped  
Press [FUNCTIONS].
- 2** Press [▲,▼] to select “Other Functions” and press [ENTER].
- 3** Press [▲,▼] to select “DV Camcorder Rec.” and press [ENTER].
- 4** Press [◀,▶] to select “Record” and press [ENTER].  
Recording starts.

## When recording finishes

The confirmation screen appears. Press [ENTER] to finish DV Auto Record.

## To stop recording

Press [■]. The confirmation screen appears. Press [ENTER].

## Note

- Only one piece of DV equipment (e.g., digital video camcorder) can be connected to the unit via the DV IN terminal.
- If you use video camcorders from other manufacturers these are not guaranteed to work.
- It is not possible to operate the unit from the connected DV equipment.
- The DV IN terminal on this unit is for use with DV equipment only. (It cannot be connected to a computer, etc.)
- The DV equipment name may not be shown correctly.
- Depending on the DV equipment, the images or audio may not be input properly.
- The date and time information on the tape of the DV equipment will not be recorded.
- You cannot record and play simultaneously.

## e.g.: Connecting other video equipment to the IN2 or DV IN terminals

You can also connect to the IN1 input terminal on the rear.

- Turn off the unit and other equipment before connecting.

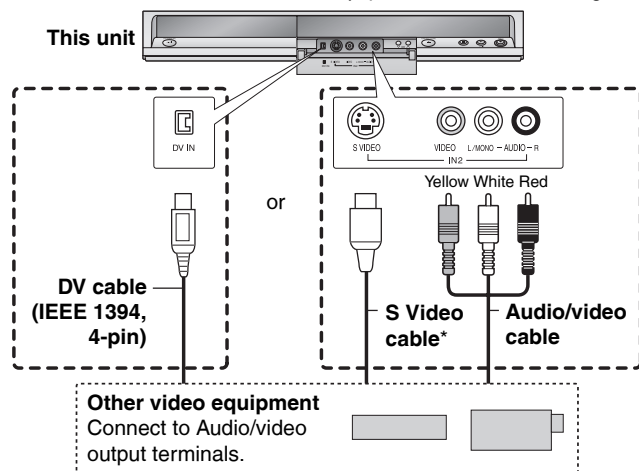

If the DV automatic recording function does not work properly, check the connections and DV equipment settings, and turn the unit off and back on.

**If that does not work, follow the instructions for manual recording (→ below).**

## Manual recording

RAM -R -R DL -RW(V) +R +R DL +RW

## Note

When recording using this unit's input terminals, only the sound received at the time of recording will be recorded. As long as secondary audio that is recorded on the video cassette is not output on the unit in play, it is not recorded.

- 1** While stopped  
Press [INPUT SELECT] to select the input channel for the equipment you have connected.  
e.g., If you have connected to IN2 input terminals, select “IN2”.
- 2** Start play on the other equipment.
- 3** When you want to start recording  
Press [● REC].  
Recording starts.

- Using Flexible Recording (→ page 19), you can record the content of a video cassette (approx. 1–8 hours) to a 4.7 GB disc with the best possible quality of recording without wasting disc space.

## To skip unwanted parts

Press [II] to pause recording. (Press again to restart recording.)

## To stop recording

Press [■].

**Almost all videos and DVD software on sale have been treated to prevent illegal copying. Any software that has been so treated cannot be recorded using this unit.**

If the audio output of the other equipment is monaural  
Connect to L/MONO.

\* The S VIDEO terminal achieves a more vivid picture than the VIDEO terminal.

See also the notes “Important notes for recording” (→ page 16).

## Preparation

- Turn on the unit and connected equipment.
- Insert a disc (→ page 18).
- Press [REC MODE] to select the recording mode.
- To reduce noise in input from external equipment, set “Line-in NR” to “On” (→ page 28).
- **When recording from the unit's DV IN terminal**  
Select the type of audio recording from “Select Audio Channel for DV Input” in the Setup menu (→ page 39).  
When recording from DV equipment (e.g., digital video camcorder), you can record audio/video recordings from DV tape only.

## DV camcorder recording

RAM -R -RW(V) +R +RW

**RAM** Programs are recorded as a title while at the same time chapters are created at each break in the images and the playlist is created automatically.

When “DV camcorder connection” screen is displayed

Press [◀,▶] to select “Record to DVD” and press [ENTER].  
You can proceed to step 4.



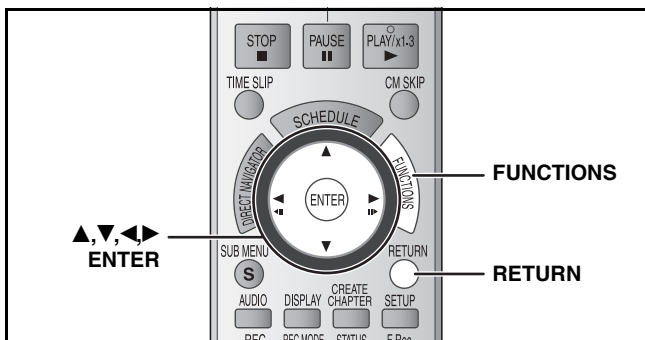

## Preparation

**RAM** Release protection (→ below).

- 1** While stopped  
Press [FUNCTIONS].
- 2** Press [▲,▼] to select “Other Functions” and press [ENTER].
- 3** Press [▲,▼] to select “DVD Management” and press [ENTER].  
Select which step 4 to perform depending on what you want to do next.

## To exit the screen

Press [RETURN] several times.

## To return to the previous screen

Press [RETURN].

## Providing a disc with a name –Disc Name

**RAM** -R -R DL -RW(V) +R +R DL +RW

After performing steps 1–3 (→ above)

- 4** Press [▲,▼] to select “Disc Name” and press [ENTER].  
→ page 29, Entering text
  - The disc name is displayed in the DVD MANAGEMENT window.
  - With a finalized disc and +RW the name is displayed in the Top Menu.



## Setting the protection –Disc Protection

**RAM**

After performing steps 1–3 (→ above)

- 4** Press [▲,▼] to select “Disc Protection” and press [ENTER].
- 5** Press [◀▶] to select “Yes” and press [ENTER].

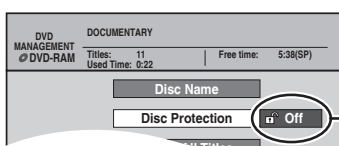

The lock symbol appears closed when the disc is write-protected.

## Cartridge–protection

**RAM** (with a cartridge)

With the write-protect tab in the protect position, play automatically starts when inserted in the unit.



## Deleting all titles and playlists –Delete All Titles

**RAM**

After performing steps 1–3 (→ left)

- 4** Press [▲,▼] to select “Delete All Titles” and press [ENTER].
- 5** Press [◀▶] to select “Yes” and press [ENTER].
- 6** Press [◀▶] to select “Start” and press [ENTER].  
A message appears when finished.
- 7** Press [ENTER].

**Note**

- Once deleted, the recorded contents are lost and cannot be restored. Make certain before proceeding.
- Deleting all video titles will result in all playlists also being deleted.
- Delete does not work if one or more titles are protected.

## Deleting all contents of a disc –Format Disc ( DVD )

**RAM** -RW(V) +RW -RW(VR)

+R +R DL (New disc only)

**Note**

Formatting delete all contents (including computer data), and they cannot be restored. Check carefully before proceeding. The contents are deleted when you format the disc even if you have set protection.

After performing steps 1–3 (→ left)

- 4** Press [▲,▼] to select “Format Disc ( DVD )” and press [ENTER].
- 5** Press [◀▶] to select “Yes” and press [ENTER].
- 6** Press [◀▶] to select “Start” and press [ENTER].  
A message appears when formatting is finished.
- Note**
  - Do not disconnect the AC power supply cord while formatting. This can render the disc unusable.
  - Formatting normally takes a few minutes. However, it may take up to a maximum of 70 minutes (**RAM**).
- 7** Press [ENTER].

**Note**

- -R -R DL CD Formatting cannot be performed.
- -RW(V) -RW(VR) You can format only as DVD-Video format on this unit.
- When a disc has been formatted using this unit, it may not be possible to use it on any other equipment.

**RAM** To stop formatting

Press [RETURN].

- You can cancel formatting if it takes more than 2 minutes. The disc must be reformatted if you do this.

Refer to the control reference on page 35.

## Selecting whether to show the Top Menu first

### –Playback will start with:

**-R -R DL -RW(V) +R +R DL +RW**

You can select whether to show the top menu after finalizing. Make selections before finalizing the disc.

After performing steps 1–3 (→ page 35)

- 4 Press [**▲**,**▼**] to select “Playback will start with:” and press [ENTER].
- 5 Press [**▲**,**▼**] to select items and press [ENTER].

DVD's Top Menu: The top menu appears first.  
 First Title on DVD: The disc content is played without displaying the top menu.

## Enabling discs to be played on other equipment

### –Finalize

**-R -R DL -RW(V) +R +R DL**

Finalize the disc so you can play it on other DVD equipment. The equipment must be able to play finalized discs. To check compatibility with other equipment, refer to page 4.

After performing steps 1–3 (→ page 35)

- 4 Press [**▲**,**▼**] to select “Finalize” and press [ENTER].
- 5 Press [**◀**,**▶**] to select “Yes” and press [ENTER].
- 6 Press [**◀**,**▶**] to select “Start” and press [ENTER].

- Finalizing starts. You cannot cancel finalizing.
- Finalizing can take a few minutes, up to a maximum of 15 minutes, depending on the remaining space on the disc.  
 (-R DL +R DL up to 60 minutes.)

#### Note

Do not disconnect the AC power supply cord while finalizing. This will render the disc unusable.

- 7 Press [ENTER].

#### After finalizing

- **-R -R DL +R +R DL** The disc becomes play-only and you can no longer record or edit.
- **-RW(V)** You can record and edit the disc after formatting (→ page 35) although it becomes play-only after finalizing.
- Titles are divided into about 5-minute (+R +R DL 8-minute) chapters. This time varies greatly depending on the condition and mode of recording.
- There is a pause of several seconds between titles and chapters during play.

- You cannot finalize discs recorded on other manufacturers' equipment.
- Discs finalized on this unit may not be playable on other players due to the condition of the recording.
- When finalizing a high-speed recording compatible disc, it may take longer than displayed on the confirmation screen (approximately four times).

## Creating Top Menu

### –Create DVD Top Menu

**+RW**

+RW discs contain no Top Menu data. Top Menu is a convenient function. We recommend you to create the menu before playing a +RW disc on other equipment.

After performing steps 1–3 (→ page 35)

- 4 Press [**▲**,**▼**] to select “Create DVD Top Menu” and press [ENTER].
- 5 Press [**◀**,**▶**] to select “Yes” and press [ENTER].
- 6 Press [**◀**,**▶**] to select “Start” and press [ENTER].  
 Creating Top Menu starts. You cannot cancel creating. Creating Top Menu can take a few minutes.
- 7 Press [ENTER].

- Recording or editing on the disc may delete the menu. In that case, create the menu again.
- You cannot use the title menu for playing on this unit.

## Enabling the second layer on DL (dual- or double- layer on single side) discs to be recordable

### –Close First Layer

**-R DL +R DL**

DVD-R DL and +R DL discs have two layers of recording surface on one side. This unit does not offer seamless recording on two layers. Recording stops when space on the first layer becomes full. You must close the first layer to start recording on the second layer. Closing makes the first layer unavailable for recording (editing is still available). You cannot cancel closing. Make certain before proceeding.

After performing steps 1–3 (→ page 35)

- 4 Press [**▲**,**▼**] to select “Close First Layer” and press [ENTER].
- 5 Press [**◀**,**▶**] to select “Yes” and press [ENTER].
- 6 Press [**◀**,**▶**] to select “Start” and press [ENTER].

Closing the layer starts. You cannot cancel closing. Closing the layer can take several minutes, up to a maximum of 30 minutes, depending on the remaining space on the first layer.

#### Note

Do not disconnect the AC power supply cord while closing the layer. This will render the disc unusable.

- 7 Press [ENTER].

- You cannot close the first layer when it has no recording.
- By closing the layer, you can record or edit discs that have been recorded on the second layer by other equipment.

#### ■ To confirm the layer you can record

You can confirm the remaining recording time on the layer you can record.

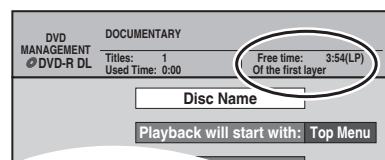

# Changing the unit's settings

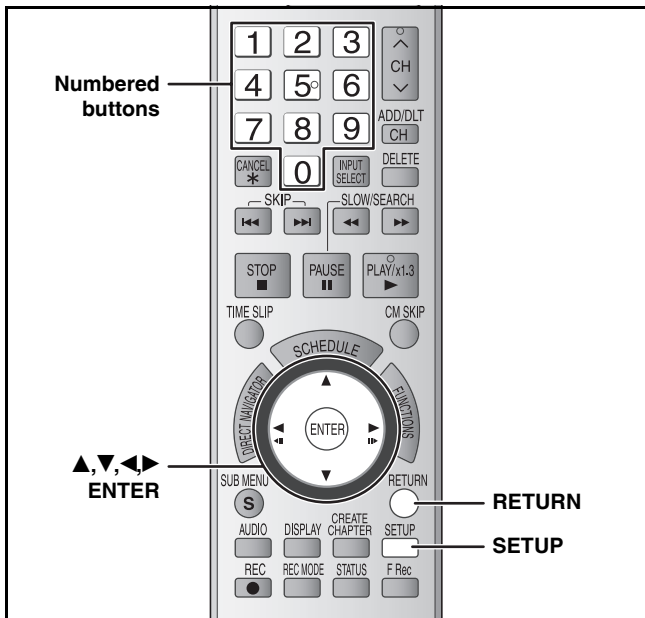

## Common procedures

- 1 While stopped  
Press [SETUP].
- 
- 2 Press [▲, ▼] to select the tab and press [▶].
  - 3 Press [▲, ▼] to select the menu and press [ENTER].
  - 4 Press [▲, ▼] to select the option and press [ENTER].

**To return to the previous screen**  
Press [RETURN].

**To exit the screen**  
Press [SETUP].

### Note

There may be differences in operation methods. If this happens, follow the on-screen instructions for the operation.

## Summary of settings

The settings remain intact even if you switch the unit to standby.

Tabs	Menus	Options (Underlined items are the factory presets.)			
<b>Channel</b>	<b>Signal Source (RF IN)</b> (→ page 13)	• Antenna	• <u>Cable TV</u>		
	<b>Set Channels Automatically</b>	–			
	<b>Preset Channel Captions</b> *1 (→ page 14)	–			
	<b>Manual Channel Captions</b> *1 (→ page 14)	–			
<b>Setup</b>	<b>Off Timer</b> Select how long the unit remains on when it is not being used.	• 2 Hours	• <u>6 Hours</u>	• Off	
	<b>Remote Control Code</b> (→ page 15)	• <u>Set Code 1</u>	• Set Code 2	• Set Code 3	
	<b>Clock Settings</b> Press [ENTER] to show the following settings.				
	<b>Set Clock Automatically</b>	–			
	<b>Set Clock Manually</b> (→ page 15)	–			
	<b>Adjust Time Zone</b> *2 (→ page 15)	• -1	• <u>0</u>	• +1	
	<b>Quick Start</b> If you set Quick Start to on, you can start recording to DVD-RAM about 1 second after you press [DVD POWER] to turn the unit on and then sequentially press [REC].	• On	• <u>Off</u>		
	The following happens when you have selected “On”. • Power consumption in standby mode increases because power is supplied to the unit.				
	<b>DivX Registration</b> Displays the unit's registration code. You need this registration code to purchase and play DivX Video-on-Demand (VOD) (→ page 26) content.	–			
	<b>Restore Default Settings</b> This returns all values in the Setup menus, except for the clock, channel settings, ratings level, and on-screen language, to the default settings.	• Yes	• <u>No</u>		

\*1 You can set these menus only after “Set Channels Automatically” is completed.

\*2 You can set this menu only after “Set Clock Automatically” is completed.

Tabs	Menus	Options (Underlined items are the factory presets.)	
Disc	<b>Settings for Playback</b>		
	Press [ENTER] to show the following settings.		
	<b>Ratings</b>	<p>Set a ratings level to limit DVD-Video play.</p> <p>Follow the on-screen instructions. Enter a 4-digit password with the numbered buttons when the password screen is shown.</p> <ul style="list-style-type: none"> <li>Do not forget your password.</li> </ul>	<ul style="list-style-type: none"> <li><u>8 No Limit</u>: All DVD-Video can be played.</li> <li>1 to 7: Prohibits play of DVD-Video with corresponding ratings recorded on them.</li> <li>0 Lock All: Prohibits play of all DVD-Video.</li> </ul>
	<b>Play DVD-Audio in Video Mode</b>	Select "Video Mode (Video On)" to play DVD-Video content on some DVD-Audio.	<ul style="list-style-type: none"> <li>Video Mode (Video On): The setting returns to "Audio Mode (Video Off)" when you change the disc or turn the unit off.</li> <li><u>Audio Mode (Video Off)</u></li> </ul>
<b>Audio Language</b>	<b>DVD-V</b>	<ul style="list-style-type: none"> <li>Some discs start in a certain language despite any changes you make here.</li> </ul>	<ul style="list-style-type: none"> <li><u>English</u> • French • Spanish</li> <li>Original: The original language of each disc will be selected.</li> <li>Other * * * *</li> </ul>
<b>Subtitle Language</b>	<b>DVD-V</b>	<ul style="list-style-type: none"> <li>Enter a code (→ page 45) with the numbered buttons when you select "Other * * * *".</li> <li>When the selected language is not available on the disc, the default language is played. There are discs where you can only switch the language from the menu screen (→ page 22).</li> </ul>	<ul style="list-style-type: none"> <li><u>Automatic</u>: If the language selected for "Audio Language" is not available, subtitles of that language will automatically appear if available on that disc.</li> <li>English • French • Spanish • Other * * * *</li> <li><u>English</u> • French • Spanish • Other * * * *</li> </ul>
<b>Menu Language</b>	<b>DVD-V</b>		
<b>Settings for Recording</b>			
	Press [ENTER] to show the following setting.		
	<b>Recording Time in EP Mode</b>	<p>Select the maximum number of hours for recording in EP mode (→ page 17, Recording modes and approximate recording times).</p>	<ul style="list-style-type: none"> <li>EP – Extended Play (6H): You can record for 6 hours on an unused 4.7 GB disc.</li> <li><u>EP – Extended Play (8H)</u>: You can record for 8 hours on an unused 4.7 GB disc. The sound quality is better when using "EP – Extended Play (6H)" than when using "EP – Extended Play (8H)".</li> </ul>
Video	<b>Still Mode ( paused video )</b>	Select the type of picture shown when you pause play (→ page 45, Frames and fields).	<ul style="list-style-type: none"> <li><u>Automatic</u></li> <li>Field: Select if jittering occurs when "Automatic" is selected. (The picture is coarser.)</li> <li>Frame: Select if small text or fine patterns cannot be seen clearly when "Automatic" is selected. (The picture is clearer and finer.)</li> </ul>
	<b>Black Level Control</b>	Select for adjusting the black level control to the desired setting for picture enhancement.	
	<b>Input Level</b>	Adjusts the black level of the input signal.	<ul style="list-style-type: none"> <li>Lighter • <u>Darker</u></li> </ul>
	<b>Output Level (Composite/SVideo)</b>	Adjusts the black level of the output signal from the VIDEO OUT and S VIDEO OUT terminal.	<ul style="list-style-type: none"> <li><u>Lighter</u> • Darker</li> </ul>
	<b>Output Level (Component)</b>	Adjusts the black level of the output signal from the COMPONENT VIDEO OUT (Y/P <sub>B</sub> /P <sub>R</sub> ) terminals.	<ul style="list-style-type: none"> <li>Lighter • <u>Normal</u> • Darker</li> </ul>

Tabs	Menus	Options (Underlined items are the factory presets.)
Audio	<b>Dynamic Range Compression <u>DVD-V</u> (Dolby Digital only)</b> Change the dynamic range for late night viewing.	<ul style="list-style-type: none"> <li>• On</li> <li>• <u>Off</u></li> </ul>
	<b>Multi-channel TV Sound ( MTS )</b> <u>-R</u> <u>-R DL</u> <u>-RW(V)</u> <u>+R</u> <u>+R DL</u> <u>+RW</u> Select whether to record the main or secondary audio program (SAP) when recording to a disc.	<ul style="list-style-type: none"> <li>• <u>Main</u></li> <li>• Secondary Audio Program (SAP)</li> </ul> You cannot select the audio on this unit when recording from an external source, such as when transferring (copying) from a video cassette recorder. Select on the other equipment. When recording from the unit's DV IN terminal, select the type of audio recording from "Select Audio Channel for DV Input" (→ below).
	<b>Digital Audio Output</b> Change the settings when you have connected equipment through this unit's DIGITAL AUDIO OUT terminal (→ page 11). <ul style="list-style-type: none"> <li>• Press [ENTER] to display the menu.</li> </ul>	
	<b>PCM Down Conversion</b> Select how to output audio with a sampling frequency of 96 kHz or 88.2 kHz. <ul style="list-style-type: none"> <li>• Signals are converted to 48 kHz or 44.1 kHz despite the above settings if the signals have a sampling frequency of over 96 kHz or 88.2 kHz, or the disc has copy protection.</li> </ul>	<ul style="list-style-type: none"> <li>• On: Signals are converted to 48 kHz or 44.1 kHz. (Choose when the connected equipment cannot process signals with a sampling frequency of 96 kHz or 88.2 kHz.)</li> <li>• <u>Off</u>: Signals are output as 96 kHz or 88.2 kHz. (Choose when the connected equipment can process signals with a sampling frequency of 96 kHz or 88.2 kHz.)</li> </ul>
	<b>Dolby Digital</b>  Select how to output the signal. If "Bitstream" is selected, the connected equipment decodes the signal. If "PCM" is selected, this unit decodes the signal and outputs it as 2 channel.	<ul style="list-style-type: none"> <li>• <u>Bitstream</u>: When connecting to equipment displaying the Dolby Digital logo.</li> <li>• PCM: When connecting to equipment not displaying the Dolby Digital logo.</li> </ul>
<b>DTS</b>   Select how to output the signal. If "Bitstream" is selected, the connected equipment decodes the signal and outputs it as 2 channel. <p><b>Note</b> Not making the proper settings may result in noise or some trouble for digital recording.</p>	<ul style="list-style-type: none"> <li>• <u>Bitstream</u>: When connecting to equipment displaying the DTS logo.</li> <li>• PCM: When connecting to equipment not displaying the DTS logo.</li> </ul>	
	<b>Select Audio Channel for DV Input</b> You can select the kind of audio when recording from the unit's DV IN terminal (→ page 34).	<ul style="list-style-type: none"> <li>• <u>Stereo 1</u>: Records audio (L1, R1)</li> <li>• Stereo 2: Records added audio such as narration (L2, R2) subsequent to original recording.</li> <li>• Mix: Records both Stereo 1 and Stereo 2.</li> </ul> <u>-R</u> <u>-R DL</u> <u>-RW(V)</u> <u>+R</u> <u>+R DL</u> <u>+RW</u> When recording MTS broadcast, select the type of audio in advance from "Multi-channel TV Sound ( MTS )" (→ above).
Display	<b>Status Messages</b> Choose whether to show status messages automatically.	<ul style="list-style-type: none"> <li>• <u>Automatic</u></li> <li>• Off</li> </ul>
	<b>On-screen Language</b> Choose the language for these menus and on-screen messages.	<ul style="list-style-type: none"> <li>• <u>English</u></li> <li>• Español</li> <li>• Français</li> </ul>
	<b>Blue Background</b> Select "Off" if you do not want to have the unit show the blue background when reception is weak.	<ul style="list-style-type: none"> <li>• <u>On</u></li> <li>• Off</li> </ul>
	<b>FL Display</b> Changes the brightness of the unit's display.	<ul style="list-style-type: none"> <li>• <u>Bright</u></li> <li>• Dim</li> <li>• Automatic: The display turns dark during play, and reappears momentarily when you press a button. When the unit is turned off all displays disappear. While using this mode the standby power consumption can be reduced.</li> </ul>
TV Screen	<b>TV Type (→ page 14)</b>	<ul style="list-style-type: none"> <li>• <u>Aspect 4:3 &amp; 480i</u></li> <li>• Aspect 4:3 &amp; 480p</li> <li>• Aspect 16:9 &amp; 480i</li> <li>• Aspect 16:9 &amp; 480p</li> </ul>
	<b>4:3 TV Settings for DVD-Video</b> Select how DVD-Video widescreen picture is shown on a 4:3 standard aspect television.	<ul style="list-style-type: none"> <li>• <u>Pan and Scan (Stretch to fit)</u>: Video recorded for a widescreen is played as Pan &amp; Scan (unless prohibited by the producer of the disc).</li> <li>• Letterbox (Shrink to fit): Video recorded for a widescreen is played in the letterbox style.</li> </ul>
	<b>4:3 TV Settings for DVD-RAM</b> Select how DVD-RAM widescreen picture is shown on a 4:3 standard aspect television.	<ul style="list-style-type: none"> <li>• 4:3 Aspect: Titles played as recorded.</li> <li>• Pan and Scan (Stretch to fit): Video recorded for a widescreen is played as Pan &amp; Scan.</li> <li>• <u>Letterbox (Shrink to fit)</u>: Video recorded for a widescreen is played in the letterbox style.</li> </ul>

## On the television

Page

<b>Authorization Error.</b> This title is not authorized to play.	• You are trying to play the DivX VOD content that was purchased with a different registration code. You cannot play the content on this unit.	26
<b>Cannot finish recording completely.</b>	• The program was copy-protected. • The disc may be full. • The maximum number of times you can record the program is exceeded.	— — —
<b>Cannot play.</b>	• You inserted an incompatible disc (Discs recorded in PAL video, etc.).	—
<b>Cannot record on the disc.</b>	• The disc may be dirty or scratched.	6
<b>Unable to format.</b>		
<b>Please check the disc.</b>		
<b>Cannot record. Disc is full.</b>	• Create space by deleting any unnecessary titles. <b>RAM -RW(V) +RW</b> (Even if you delete recorded content from DVD-R, DVD-R DL, +R or +R DL, there is no increase in disc space.)	29, 31, 35
<b>Cannot record. Maximum numbers of titles exceeded.</b>	• Use a new disc.	—
<b>No disc</b>	• The disc may be upside down.	—
<b>Please change the disc.</b>	• There may be a problem with the disc. Press [▲ OPEN/CLOSE] on the main unit to remove it and check it for scratches or dirt. (The unit turns off automatically after you open the tray.)	6
<b>This is a non-recordable disc.</b>	• The unit cannot record on the disc you inserted. Insert a DVD-RAM or unfinalized DVD-R, DVD-R DL, DVD-RW (DVD-Video format), +R, +R DL or +RW.	4
<b>This disc is not formatted properly.</b>	• You inserted an unformatted DVD-RAM, DVD-RW, +R, +R DL or +RW. Format the disc with this unit.	35
<b>Rental Expired.</b>	• The DivX VOD content has zero remaining plays. You cannot play it. (DivX)	26
Ⓞ	• The operation is prohibited by the unit or disc.	—

## On the unit's display

The following messages or service numbers appear on the unit's display when something unusual is detected during startup and use.

<b>SET □</b> ("□" stands for a number.)	• The remote control and main unit are using different codes. Change the code on the remote control. Press and hold [ENTER] and the indicated number button at the same time for more than 2 seconds.		15
<b>HARD ERR</b> ("HARD" and "ERR" are alternately displayed.)	• If there is no change after turning the unit on and off, consult the dealer where the unit was purchased.		—
<b>NoREAD</b>	• The disc is dirty or badly scratched. The unit cannot record, play, or edit. • The message may appear when the DVD lens cleaner has finished cleaning. Press [▲ OPEN/CLOSE] on the main unit to eject the disc.		6 —
<b>NoWRIT</b>	• Recording may be unavailable due to a disc problem. Use a new disc.		—
<b>NoERAS</b>	• Deleting an item may be unavailable due to a disc problem. Use a new disc.		—
<b>PLEASE WAIT</b> ("PLEASE" and "WAIT" are alternately displayed.)	• Displayed when the unit is started. This is not a malfunction. • The unit is carrying out its recovery process. You cannot operate the unit while "PLEASE WAIT" is displayed.		— —
<b>UNSUPPORT</b> ("UNSUP" and "PORT" are alternately displayed.)	• You have inserted a disc the unit cannot play or record on.		4, 5
<b>UNFORMAT</b> ("UNFOR" and "MAT" are alternately displayed.)	• You have inserted a new DVD-RW/+R/+R DL/+RW or a DVD-RAM/DVD-RW (DVD-Video format) recorded on other equipment.		35
<b>U59</b>	• The unit is hot. The unit switches to standby for safety reasons. Wait about 30 minutes until the message disappears. Select a position with good ventilation when installing the unit. Do not block the vent on the rear of the unit.		—
<b>U61</b>	• There was a power failure or the AC plug was disconnected while the unit was on. The unit is carrying out its recovery process. This process restores the unit to normal operation. The unit is not broken. Wait until the message disappears.		—
<b>U88</b>	• There was something unusual detected with the disc while recording or playing. The unit is carrying out its recovery process. This process restores the unit to normal operation. The unit is not broken. Wait until the message disappears.		42
<b>U99</b>	• The unit fails to operate properly. Press [POWER ⏻/⏻] on the main unit to switch the unit to standby. Now press [POWER ⏻/⏻] on the main unit again to turn the unit on.		—



# Frequently asked questions

Set up		Page
Do the Audio/Video cables need to be connected to the TV in order to see the Menus?	<ul style="list-style-type: none"> <li>If your television does not have AUDIO/VIDEO terminals, an RF modulator is necessary. Consult your local dealer for more information.</li> </ul>	8–10
What equipment is necessary to play multi channel surround sound?	<ul style="list-style-type: none"> <li><b>DVD-Video:</b> You can play DVD-Video multi channel surround by digitally connecting an amplifier equipped with a Dolby Digital or DTS decoder.</li> <li><b>DVD-Audio:</b> This unit plays DVD-Audio in 2 channels. You cannot play multi channel surround sound.</li> </ul>	11 —
Are the headphones and speakers directly connected to the unit?	<ul style="list-style-type: none"> <li>You cannot directly connect to the unit. Connect through the amplifier, etc.</li> </ul>	11
The television has both S VIDEO IN terminal and COMPONENT VIDEO IN terminals. Which terminal should I connect with?	<ul style="list-style-type: none"> <li>We recommend the COMPONENT VIDEO IN terminal. Component signal outputs the color difference signals (P<sub>B</sub>/P<sub>R</sub>) and luminance signal (Y) separately in order to achieve high fidelity in reproducing colors. If the television is compatible with progressive output, a high quality picture can be output because this unit's component video output terminal outputs a progressive output signal.</li> </ul>	10
Is my television progressive output compatible?	<ul style="list-style-type: none"> <li>All Panasonic televisions that have 480p input terminals are compatible. Consult the manufacturer if you have another brand of television.</li> </ul>	—

Disc		
Can I play DVD-R, DVD-R DL, DVD-RW (DVD-Video format), +R, +R DL and +RW recorded with this unit with other equipment?	<ul style="list-style-type: none"> <li>You can play on compatible equipment such as DVD players after finalizing the disc on this unit. It is not necessary to finalize +RW. However, depending on the condition of the recording, the quality of the disc and capabilities of the DVD player, play may not be possible. To enable play on other DVD players, please use "Create DVD Top Menu" in the DVD Management menu.</li> </ul>	36
Can I play DVD-Video, DVD-Audio and Video CDs bought in another country?	<ul style="list-style-type: none"> <li>You can play them if the video standard is NTSC.</li> <li>However, you cannot play DVD-Video if their region number does not include "1" or "ALL".</li> </ul>	— Cover
Can a DVD-Video that does not have a region number be played?	<ul style="list-style-type: none"> <li>The DVD-Video region number indicates the disc conforms to a standard. You cannot play discs that do not have a region number.</li> </ul>	—
Please tell me about DVD-R, DVD-R DL, DVD-RW, +R, +R DL and +RW compatibility with this unit.	<ul style="list-style-type: none"> <li>This unit records and plays DVD-R, DVD-R DL, DVD-RW (DVD-Video format), +R, +R DL and +RW, and plays DVD-RW (VR format).</li> <li>This unit also records and plays high speed recording compatible discs.</li> <li>After recording but before finalizing +R, +R DL discs                             <ul style="list-style-type: none"> <li>– You may not be able to play and record discs on this unit after recording them on other Panasonic products or other manufacturer's equipment.</li> <li>– You may not be able to play and record discs on other equipment after recording them on this unit.</li> </ul>                             After finalizing the disc, however, you will be able to play it on any DVD-Video compatible player.                         </li> </ul>	4, 5 4 —
Please tell me about CD-R and CD-RW compatibility with this unit.	<ul style="list-style-type: none"> <li>This unit plays CD-R/CD-RW discs which have been recorded under one of the following standards: CD-DA, Video CD, MP3, DivX and still pictures (JPEG/TIFF). Close the session after recording.</li> <li>You cannot write to a CD-R or CD-RW with this unit.</li> </ul>	5, 24 —

Recording								
Can I record from a commercially purchased video cassette or DVD?	<ul style="list-style-type: none"> <li>Most commercially sold video cassettes and DVD are copy protected; therefore, recording is usually not possible.</li> </ul>	—						
Can I record digital audio signals using this unit?	<ul style="list-style-type: none"> <li>You cannot record digital signals. The digital audio terminals on this unit are for output only. (The audio recorded using the unit's DV IN terminal from a digital video camcorder, for example, is recorded digitally.)</li> </ul>	—						
Can a digital audio signal from this unit be recorded to other equipment?	<ul style="list-style-type: none"> <li>You can record if using the PCM signal. When recording DVD, change the "Digital Audio Output" settings to the following from the Setup menu.                             <table border="0" style="margin-left: 20px;"> <tr> <td>–PCM Down Conversion</td> <td>On</td> </tr> <tr> <td>–Dolby Digital</td> <td>PCM</td> </tr> <tr> <td>–DTS</td> <td>PCM</td> </tr> </table>                             However, only                             <ul style="list-style-type: none"> <li>–As long as digital recording from the disc is permitted.</li> <li>–As long as the recording equipment is compatible with a sampling frequency of 48 kHz.</li> </ul> </li> <li>You cannot record MP3 signals.</li> </ul>	–PCM Down Conversion	On	–Dolby Digital	PCM	–DTS	PCM	39 —
–PCM Down Conversion	On							
–Dolby Digital	PCM							
–DTS	PCM							
Can I switch to SAP during recording?	<ul style="list-style-type: none"> <li>With DVD-RAM, you can, and the recorded audio also changes. Just press [AUDIO].</li> <li>With DVD-R, DVD-R DL, DVD-RW (DVD-Video format), +R, +R DL or +RW you cannot. Change before recording with "Multi-channel TV Sound ( MTS )" in the Setup menu.</li> </ul>	19 39						

# Troubleshooting guide

Before requesting service, make the following checks. If you are in doubt about some of the check points, or if the remedies indicated in the chart do not solve the problem, refer to "Product information" on page 44.

## The following do not indicate a problem with this unit:

<ul style="list-style-type: none"> <li>• Regular disc rotating sounds.</li> <li>• Poor reception due to atmospheric conditions.</li> <li>• Image disturbance during search.</li> <li>• Interruptions in reception due to periodic satellite broadcasting breaks.</li> </ul>	<ul style="list-style-type: none"> <li>• Operations do not work due to a poor-quality disc. (Try again using a Panasonic disc.)</li> <li>• The unit freezes due to one of its safety devices being activated. (Press and hold [POWER <math>\odot</math>/I] on the main unit for 10 seconds.)</li> </ul>
---	---

## Power

		Page
<b>No power.</b>	• Insert the AC power supply cord securely into a known active AC outlet.	<b>8, 9</b>
<b>The unit switches to the standby mode.</b>	<ul style="list-style-type: none"> <li>• This is a power saving feature. Change "Off Timer" in the Setup menu, if you would prefer.</li> <li>• One of the unit's safety devices is activated. Press [POWER <math>\odot</math>/I] on the main unit to turn the unit on.</li> </ul>	<b>37</b> —



## TV screen and video











<b>The images from this unit do not appear on the television.</b>	• Make sure that the television is connected to the VIDEO OUT terminal, S VIDEO OUT terminal or COMPONENT VIDEO OUT terminals on this unit.	<b>8, 9, 10</b>
<b>Picture is distorted.</b>	<ul style="list-style-type: none"> <li>• Make sure that the television's input setting (e.g., VIDEO 1) is correct.</li> <li>• The television isn't compatible with progressive signals. Press and hold [■] and [▶ x1.3] on the main unit at the same time for about 5 seconds. The setting will change to interlace.</li> </ul>	— —
<b>Television reception worsens after connecting the unit.</b>	• Re-connect all connecting cords securely.	—
<b>Status messages do not appear.</b>	• Select "Automatic" in "Status Messages" in the Setup menu.	<b>39</b>
<b>The blue background does not appear.</b>	• Select "On" in "Blue Background" in the Setup menu.	<b>39</b>
<b>The 4:3 aspect ratio picture expands left and right.</b>	• Use the television to change the aspect. If your television does not have that function, set "Progressive" in the Video menu to "Off".	<b>28</b>
<b>Screen size is wrong.</b>	• Check the settings for "TV Type", "4:3 TV Settings for DVD-Video" or "4:3 TV Settings for DVD-RAM" in the Setup menu.	<b>39</b>
<b>There is a lot of after-image when playing video.</b>	• Set "DNR" in the Video menu to "Off".	<b>28</b>
<b>When playing DVD-Video using progressive output, one part of the picture momentarily appears to be doubled up.</b>	• Set "Progressive" in the Video menu to "Off". This problem is caused by the editing method or material used on DVD-Video, but should be corrected if you use interlace output.	<b>28</b>
<b>There is no apparent change in picture quality when adjusted with the Video menu in the on-screen menus.</b>	• The effect is less perceivable with some types of video.	—

## Displays

<b>The display is dim.</b>	• Change "FL Display" in the Setup menu.	<b>39</b>
<b>"12:00A" is flashing on the unit's display.</b>	• Set the clock.	<b>15</b>
<b>Compared to the actual recorded time, less remaining time is displayed.</b>	• The displayed recording/play time is converted from the number of frames at 29.97 frames (equal to 0.999 seconds) to one second. There will be a slight difference between the time displayed and the actual elapsed time (e.g., actual one-hour elapsed time may display as approximately 59 minutes 56 seconds). This does not affect the recording.	—
<b>The time recorded on the disc and the available time shown do not add up.</b>	• Times shown may disagree with actual times.	—
<b>The play time shown for MP3 does not agree with the actual time.</b>	<ul style="list-style-type: none"> <li>• Even if you delete recorded content from DVD-R, DVD-R DL, +R, or +R DL, there is no increase in disc space.</li> <li>• Available recording space on DVD-RW (DVD-Video format) or +RW increases only when the last recorded title is deleted. It does not increase if other titles are deleted.</li> <li>• Available recording space on DVD-R, DVD-R DL, +R and +R DL reduces if you have repeatedly recorded and edited more than 200 times or so. (For the second layer on DVD-R DL and +R DL, this happens after about 60 times.)</li> <li>• While searching, the elapsed time may not display correctly.</li> </ul>	— — —
<b>"U88" is displayed and the disc cannot be ejected.</b>	<ul style="list-style-type: none"> <li>• The unit is carrying out the recovery process. Do the following to eject the disc. <ol style="list-style-type: none"> <li>1 Press [POWER <math>\odot</math>/I] on the main unit to switch the unit to standby. If the unit doesn't switch to standby, press and hold [POWER <math>\odot</math>/I] on the main unit for about 10 seconds. The unit is forcibly switched to standby.</li> <li>2 While the unit is off, press and hold [■] and [CH ^] on the main unit at the same time for about 5 seconds. Remove the disc.</li> </ol> </li> </ul>	—

Sound		Page
<b>No sound</b> <b>Low volume.</b> <b>Distorted sound.</b> <b>Cannot hear the desired audio type.</b>	• Check the connections and settings. Check the input mode on the amplifier if you have connected one.	8–11, 39
	• Press [AUDIO] to select the audio.	23
	• Turn off V. Surround Sound in the following cases. – When using discs that do not have surround sound effects such as Karaoke discs. – When playing MTS broadcast programs.	28
<b>Cannot switch audio.</b>	• Audio may not be output due to how files were created. (DivX)	—
	• You cannot change the audio type when DVD-R, DVD-R DL, DVD-RW (DVD-Video format), +R, +R DL or +RW is in the disc tray.	—
	• You cannot change the audio type when playing DVD-R, DVD-R DL, DVD-RW (DVD-Video format), +R, +R DL or +RW. (You can select “Main” or “SAP” in “Multi-channel TV Sound (MTS)” in the Setup menu before recording.)	39
	• When the sound is output from DIGITAL AUDIO OUT terminal, the sound effect doesn’t work if the setting of “Dolby Digital” is “Bitstream”. • There are discs where audio cannot be changed because of how the disc was created.	11, 39 —

Operation		
<b>Cannot operate the television.</b> <b>The remote control doesn’t work.</b>	• Change manufacturer code. Some televisions cannot be operated even if you change the code.	15
	• The remote control and main unit are using different codes. Change the code on the remote control. Press and hold [ENTER] and the indicated number button at the same time for more than 2 seconds.	15
	• The batteries are depleted. Replace them with new ones.	6
	• You are not pointing the remote control at the main unit’s remote control signal sensor during operation.	6
	• Colored glass may obstruct the signal reception/transmission.	—
	• Don’t place the signal sensor in direct sunlight or in areas that may be subject to sunlight exposure.	—
	• It may be necessary to set the code on the remote control again after changing the batteries. • It may be necessary to set the manufacturer code again after changing the batteries.	15 15
<b>The unit is on but cannot be operated.</b>	• Some operations may be prohibited by the disc. • The unit is hot (“U59” appears on the display). Wait for “U59” to disappear. • One of the unit’s safety devices may have been activated. Reset the unit as follows: 1 Press [POWER  ] on the main unit to switch the unit to standby. If the unit doesn’t switch to standby, press and hold [POWER  ] on the main unit for about 10 seconds. The unit is forcibly switched to standby. Alternatively, disconnect the AC power supply cord, wait one minute, then reconnect it. 2 Press [POWER  ] on the main unit to switch it on. If the unit still cannot be operated, consult the dealer.	— — — —
	• Startup takes time in the following situations. – A disc other than a DVD-RAM is inserted. – The clock is not set. – Immediately after a power failure or the AC power supply cord is connected.	—
<b>Cannot eject disc.</b>	• The unit is recording. • The unit may have a problem. While the unit is off, press and hold [■] and [CH ^] on the main unit at the same time for about 5 seconds. Remove the disc and consult the dealer.	— —
<b>Startup is slow.</b>	• Startup takes time in the following situations. – A disc other than a DVD-RAM is inserted. – The clock is not set. – Immediately after a power failure or the AC power supply cord is connected.	—

Recording, scheduled recording and copying			
<b>Cannot record.</b>	• You haven’t inserted a disc or the disc you inserted cannot be recorded on. Insert a disc the unit can record onto.	4	
	•      The disc is not formatted. Format the disc using DVD Management.	35	
	• The write-protect tab on the cartridge is set to Protect, or the disc is protected with DVD Management.	35	
	• Some programs have limitations on the number of times they can be recorded. (CPRM)	45	
	• The disc is full or nearly full. Delete unneeded titles or use another disc.	29, 31, 35	
	• You cannot record on finalized DVD-R, DVD-R DL, DVD-RW (DVD-Video format), +R, +R DL or DVD-RW (VR format) discs.	—	
	• Due to peculiarities of DVD-R, DVD-R DL, DVD-RW (DVD-Video format), +R, +R DL or +RW you may be unable to record onto them if you either insert and remove the disc or switch the unit on and off while a disc is loaded, a total of fifty times.	—	
	• DVD-R, DVD-R DL, DVD-RW, +R, +R DL and +RW recorded on this unit may not be recordable on other Panasonic DVD recorders.	—	
	<b>Cannot record from external equipment.</b>	• Check that the connection is correct. • Select the input channel (“IN1”, “IN2” or “DV”) for the equipment you have connected.	8, 9, 34 —
	<b>Scheduled recording does not work properly.</b>	• The scheduled program is incorrect or different scheduled program times overlap. Correct the program. • Set the clock.	21 15
<b>Scheduled recording does not stop even when [■] is pressed.</b>	• If you start recording immediately after turning on the unit while “Quick Start” is set to “On”, you cannot then stop recording for a few seconds.	37	
<b>The scheduled program remains even after recording finishes.</b>	• The scheduled program remains if set to Monday - Friday, Monday - Saturday, Sunday - Saturday or weekly.	20	
<b>A part or whole of a recorded title has been lost.</b>	• If there is a power failure or the plug is disconnected from the household AC outlet while recording or editing, the title may be lost or the disc may become unusable. You will have to format the disc (      ) or use a new disc. We cannot offer any guarantee regarding lost titles or discs.	—	

## Recording, scheduled recording and copying (Continued)

		Page
<b>The DV automatic recording function does not work.</b>	• If images cannot be recorded or if the recording is aborted, check the connections and DV equipment settings.	<b>34</b>
	• You cannot start recording until the images from the DV equipment appear on the television.	—
	• Recording may not be performed as desired if the time codes on the tape in the DV equipment are not successive.	—
	• Depending on the equipment, the DV automatic recording may not operate properly.	—
	• You can only record audio/video images on a DV tape.	—

## Play

<b>Play fails to start even when [▶] (PLAY) is pressed. Play starts but then stops immediately.</b>	• Insert the disc correctly with the label facing up.	<b>18</b>
	• The disc is dirty.	<b>6</b>
	• You tried to play a blank disc or unplayable disc on this unit.	<b>4, 5</b>
	• You tried to play a +RW that needs to be finalized on the equipment used for recording.	—
	• When recording to DVD-RAM using EP (8H) mode, play may not be possible on DVD players that are compatible with DVD-RAM. In this case use EP (6H) mode.	<b>38</b>
<b>DVD-Video is not played.</b>	• You cannot play discs during DV automatic recording.	<b>34</b>
	• If playing DivX VOD content, refer to the homepage where you purchased it. (DivX)	<b>26</b>
<b>Alternative soundtrack and subtitles cannot be selected.</b>	• Some DVD-Video cannot be played when you change the ratings level.	<b>38</b>
<b>No subtitles.</b>	• The languages are not recorded on the disc.	—
	• You may have to use the disc's menus to select languages.	<b>22</b>
<b>Angle cannot be changed.</b>	• When progressive output is on, closed captions cannot be displayed.	—
	• Subtitles are not recorded on the disc.	—
	• Set "Subtitle" on the on-screen menu to "On".	<b>27</b>
<b>You have forgotten your ratings password.</b>	• Angles can only be changed during scenes where different angles are recorded.	—
<b>Quick View does not work.</b>	• While the disc tray is open, press and hold [● REC] and [▶ x1.3] on the main unit at the same time for 5 or more seconds ("INIT" will appear on the unit's display). The ratings level returns to "8".	—
<b>The resume play function does not work.</b>	• This does not work when audio is other than Dolby Digital.	—
	• This does not work while recording in XP or FR mode.	—
<b>It takes time before play starts.</b>	• Memorized positions are canceled when –press [■] several times. –open the disc tray.	—
	– <b>DVD-A CD VCD MP3/DivX</b> : turn off the power.	—
	• This function does not work when playing DivX VOD content.	<b>26</b>
<b>Picture stops.</b>	• It will take a little time for DivX videos to start playing. (DivX)	—
	• Picture may stop if the DivX files are greater than 2 GB. (DivX)	—

## Edit

<b>Cannot format.</b>	• The disc is dirty. Wipe with a damp cloth and then wipe dry.	<b>6</b>
	• You tried formatting a disc that is not compatible with this unit.	<b>4, 5</b>
<b>Cannot create chapters.</b>	• The unit writes the chapter division information to the disc when you turn it off or remove the disc. The information is not written if there is an interruption to the power before this.	—
<b>Cannot mark the start point or the end point during "Shorten Title" operation.</b>	• These operations are not possible with still pictures.	—
	• You cannot set points if they are too close to each other. You cannot set an end point before a start point.	—
<b>Cannot delete chapters.</b>	• When the chapter is too short to delete, use "Combine Chapters" to make the chapter longer.	<b>31</b>
<b>The available recording space doesn't increase even after deleting recordings on the disc.</b>	• Available recording space on DVD-R, DVD-R DL, +R or +R DL does not increase even after deleting previously recorded titles.	—
	• Available recording space on DVD-RW (DVD-Video format) or +RW increases only when the last recorded title is deleted. It does not increase if other titles are deleted.	—
<b>Cannot create a playlist.</b>	• You cannot select all the chapters at once in a title if the title also includes still pictures. Select them individually.	—

## Product Service

- 1. Damage requiring service**—The unit should be serviced by qualified service personnel if:
  - (a) The AC power supply cord or AC adaptor has been damaged; or
  - (b) Objects or liquids have gotten into the unit; or
  - (c) The unit has been exposed to rain; or
  - (d) The unit does not operate normally or exhibits a marked change in performance; or
  - (e) The unit has been dropped or the cabinet damaged.
- 2. Servicing**—Do not attempt to service the unit beyond that described in these operating instructions. Refer all other servicing to authorized servicing personnel.
- 3. Replacement parts**—When parts need replacing ensure the servicer uses parts specified by the manufacturer or parts that have the same characteristics as the original parts. Unauthorized substitutes may result in fire, electric shock, or other hazards.
- 4. Safety check**—After repairs or service, ask the servicer to perform safety checks to confirm that the unit is in proper working condition.

### Product information

For product information or assistance with product operation:

Contact the Panasonic Canada Inc. Customer Care Centre at 1-800-561-5505, or visit the website ([www.panasonic.ca](http://www.panasonic.ca)), or an authorized Servicentre closest to you.

## Bitstream

This is the digital form of multi-channel audio data (e.g., 5.1 channel) before it is decoded into its various channels.

## CPRM (Content Protection for Recordable Media)

CPRM is technology used to protect broadcasts that are allowed to be recorded only once. Such broadcasts can be recorded only with CPRM compatible recorders and discs.

## DivX

A video compression format developed by DivX, Inc. that compresses video files without any considerable loss of video quality.

## Dolby Digital

This is a method of coding digital signals developed by Dolby Laboratories. Apart from stereo (2-channel) audio, these signals can also be multi-channel audio. A large amount of audio information can be recorded on one disc using this method.

## Down-mixing

This is the process of remixing the multi-channel audio found on some discs into two channels for stereo output. It is useful when you want to listen to the 5.1-channel audio recorded on DVDs through your television's speakers. Some discs prohibit down-mixing and this unit can then only output the front two channels.

## DTS (Digital Theater Systems)

This surround system is used in many movie theaters. There is good separation between the channels, so realistic sound effects are possible.

## Dynamic range

Dynamic range is the difference between the lowest level of sound that can be heard above the noise of the equipment and the highest level of sound before distortion occurs. Dynamic range compression means reducing the gap between the loudest and softest sounds. This means you can listen at low volumes but still hear dialog clearly.

## Film and video

DVD-Videos are recorded using either film or video. This unit can determine which type has been used, then uses the most suitable method of progressive output.

### Film:

Recorded at 24 or 30 frames per second. Generally appropriate for motion picture films.

### Video:

Recorded at 30 frames/60 fields per second. Generally appropriate for TV drama programs or animation.

## Finalize

A process that makes play of a recorded CD-R, CD-RW, DVD-R, etc. possible on equipment that can play such media. You can finalize DVD-R, DVD-R DL, DVD-RW (DVD-Video format), +R or +R DL on this unit. After finalizing, the disc becomes play-only and you can no longer record or edit. However, finalized DVD-RW can be formatted to become recordable.

## Formatting

Formatting is the process of making media such as DVD-RAM recordable on recording equipment.

You can format DVD-RAM, DVD-RW (only as DVD-Video format), +R, +R DL or +RW on this unit.

When you use a new DVD-RW, +R, +R DL or +RW, it must be formatted. Formatting irrevocably deletes all contents.

## Frames and fields

Frames refer to the single images that constitute the video you see on your television. Each frame consists of two fields.

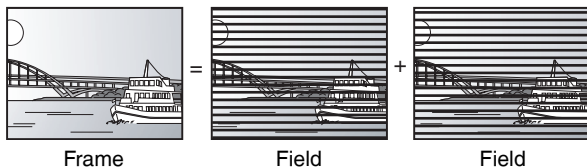

Frame

Field

Field

- A frame still shows two fields, so there may be some blurring, but picture quality is generally better.
- A field still shows less picture information so it may be rougher, but there is no blurring.

## JPEG (Joint Photographic Experts Group)

This is a system used for compressing/decoding color still pictures. If you select JPEG as the storage system on digital cameras, etc., the data will be compressed to 1/10–1/100 of its original size. The feature of JPEG is less deterioration in picture quality considering the degree of compression.

## MP3 (MPEG Audio Layer 3)

An audio compression method that compresses audio to approximately one tenth of its size without any considerable loss of audio quality. You can play MP3 you have recorded onto CD-R and CD-RW.

## Pan & Scan/Letterbox

In general, DVD-Video are produced with the intention that they be viewed on a widescreen television (16:9 aspect ratio), so images often don't fit regular (4:3 aspect ratio) televisions. Two styles of picture, "Pan & Scan" and "Letterbox", deal with this problem.

Pan & Scan: The sides are cut off so the picture fills the screen.



Letterbox: Black bands appear at the top and bottom of the picture so the picture itself appears in an aspect ratio of 16:9.



## Playback control (PBC)

If a Video CD has playback control, you can select scenes and information with menus.

(This unit is compatible with version 2.0 and 1.1.)

## Progressive/Interlace

NTSC, the video signal standard, has 480 interlaced (i) scan lines, whereas progressive scanning uses twice the number of scan lines. This is called 480p.

Using progressive output, you can enjoy the high-resolution video recorded on media such as DVD-Video. Your television must be compatible to enjoy progressive video.

## Protection

You can prevent accidental deletion by setting writing protection or deletion protection.

## Sampling frequency

Sampling is the process of converting the heights of sound wave (analog signal) samples taken at set periods into digits (digital encoding). Sampling frequency is the number of samples taken per second, so larger numbers mean more faithful reproduction of the original sound.

## Thumbnail

This refers to a miniature representation of a picture used to display multiple pictures in the form of a list.

## TIFF (Tag Image File Format)

This is a system used for compressing/decoding color still pictures. A common format for storing high quality images on digital cameras and other devices.

## Language code list

Enter the code with the numbered buttons.

Abkhazian: 6566	Chinese: 9072	Hebrew: 7387	Macedonian: 7775	Romanian: 8279	Telugu: 8469
Afar: 6565	Corsican: 6779	Hindi: 7273	Malagasy: 7771	Russian: 8285	Thai: 8472
Afrikaans: 6570	Croatian: 7282	Hungarian: 7285	Malay: 7783	Samoan: 8377	Tibetan: 6679
Albanian: 8381	Czech: 6783	Icelandic: 7383	Malayalam: 7776	Sanskrit: 8365	Tigrinya: 8473
Ameharic: 6577	Danish: 6865	Indonesian: 7378	Maltese: 7784	Scots Gaelic: 7168	Tonga: 8479
Arabic: 6582	Dutch: 7876	Interlingua: 7365	Maori: 7773	Serbian: 8382	Turkish: 8482
Armenian: 7289	English: 6978	Irish: 7165	Marathi: 7782	Serbo-Croatian: 8372	Turkmen: 8475
Assamese: 6583	Esperanto: 6979	Italian: 7384	Moldavian: 7779	Shona: 8378	Twi: 8487
Aymara: 6589	Estonian: 6984	Japanese: 7465	Mongolian: 7778	Sindhi: 8368	Ukrainian: 8575
Azerbaijani: 6590	Faroese: 7079	Javanese: 7487	Nauru: 7865	Singhalese: 8373	Urdu: 8582
Bashkir: 6665	Fiji: 7074	Kannada: 7578	Nepali: 7869	Slovak: 8375	Uzbek: 8590
Basque: 6985	Finnish: 7073	Kashmiri: 7583	Norwegian: 7879	Slovenian: 8376	Vietnamese: 8673
Bengali, Bangla: 6678	French: 7082	Kazakh: 7575	Oriya: 7982	Slovenian: 8376	Volapük: 8679
Bhutani: 6890	Frisian: 7089	Kirghiz: 7589	Pashto, Pushto: 8083	Somali: 8379	Welsh: 6789
Bihari: 6672	Galician: 7176	Korean: 7579	Persian: 7065	Spanish: 6983	Wolof: 8779
Breton: 6682	Georgian: 7565	Kurdish: 7585	Polish: 8076	Sundanese: 8385	Xhosa: 8872
Bulgarian: 6671	German: 6869	Laotian: 7679	Portuguese: 8084	Swahili: 8387	Yiddish: 7473
Burmese: 7789	Greek: 6976	Latin: 7665	Punjabi: 8065	Swedish: 8386	Yoruba: 8979
Byelorussian: 6669	Greenlandic: 7576	Latvian, Lettish: 7686	Quechua: 8185	Tagalog: 8476	Zulu: 9085
Cambodian: 7577	Guarani: 7178	Lingala: 7678	Rhaeto-Romance: 8277	Tajik: 8471	
Catalan: 6765	Gujarati: 7185	Lithuanian: 7684		Tamil: 8465	
	Hausa: 7265			Tatar: 8484	

# Specifications

## Recordable discs:

### DVD-RAM:

Ver. 2.0

Ver. 2.1/3X-SPEED DVD-RAM Revision 1.0

Ver. 2.2/5X-SPEED DVD-RAM Revision 2.0

### DVD-R:

for General Ver. 2.0

for General Ver. 2.0/4X-SPEED DVD-R Revision 1.0

for General Ver. 2.x/8X-SPEED DVD-R Revision 3.0

for General Ver. 2.x/16X-SPEED DVD-R Revision 6.0

for DL Ver. 3.0

for DL Ver. 3.x/4X-SPEED DVD-R for DL Revision 1.0

### DVD-RW:

Ver. 1.1

Ver. 1.x/2X-SPEED DVD-RW Revision 1.0

Ver. 1.x/4X-SPEED DVD-RW Revision 2.0

Ver. 1.x/6X-SPEED DVD-RW Revision 3.0

### +R:

Ver. 1.0

Ver. 1.1

Ver. 1.2

Ver. 1.3

for DL Ver. 1.0

### +RW:

Ver. 1.1

Ver. 1.2/4X-SPEED

## Recording system:

DVD-RAM: DVD Video Recording format

DVD-R: DVD-Video format

DVD-R DL (Dual Layer):

DVD-Video format

DVD-RW: DVD-Video format

+R

+R DL (Double Layer)

+RW

## Recording time:

Max. 8 hours (using 4.7 GB disc)

XP: Approx. 1 hour      SP: Approx. 2 hours

LP: Approx. 4 hours      EP: Approx. 6 hours or 8 hours

## Playable discs:

DVD-RAM: DVD Video Recording format

DVD-R: DVD-Video format, DivX

DVD-R DL (Dual Layer):

DVD-Video format

DVD-RW: DVD-Video format, DVD Video Recording format

+R      +R DL (Double Layer)

+RW      DVD-Video

DVD-AUDIO CD-Audio (CD-DA)

Video CD      CD-R/CD-RW (CD-DA, Video CD, MP3, JPEG, DivX)

## Optical pick-up:

System with 1 lens, 2 integration units

(662 nm wavelength for DVDs, 780 nm wavelength for CDs)

## LASER Specification

Class 1 LASER Product

Wave length: 780 nm (CDs)

662 nm (DVDs)

Laser power: No hazardous radiation is emitted with the safety protection

## Television system

TV system: NTSC system, 525 lines, 60 fields

Antenna reception TV Channel: 2 ch-69 ch

input: CATV Channel: 1 ch-125 ch

RF converter output: Not provided

## Quick Start for Recording (Quick Start : ON)

1 Sec. Quick Start for Recording on DVD-RAM\*

\* From the power off state, recording on DVD-RAM starts about 1 second after first pressing the Power button and then sequentially pressing the REC button (Quick Start Mode).

## Video system

**Recording system:** MPEG2 (Hybrid VBR)

**Input:** LINE (pin jack) x2, 1.0 Vp-p; 75 Ω  
S connector x2 Y: 1.0 Vp-p; 75 Ω  
C: 0.286 Vp-p; 75 Ω

**Output:** LINE (pin jack) x1, 1.0 Vp-p; 75 Ω  
S connector x1 Y: 1.0 Vp-p; 75 Ω  
C: 0.286 Vp-p; 75 Ω

**Component video output:** Y, PB, PR x 1 Y: 1.0 Vp-p; 75 Ω  
(480p/480i) PB: 0.7 Vp-p; 75 Ω  
PR: 0.7 Vp-p; 75 Ω

## Audio system

**Recording system:** Dolby Digital (2ch)

**Analog Input:** LINE (pin jack) x2  
Reference input: 309 mVrms  
FS: 2 Vrms (1 kHz, 0 dB)  
Input impedance: 47 kΩ

**Analog Output:** LINE (pin jack) x1  
Reference output: 309 mVrms  
FS: 2 Vrms (1 kHz, 0 dB)  
Output impedance: 1 kΩ  
(Load impedance: 10 kΩ)

**Number of channels:** Recording: 2 channels  
Playback: 2 channels

**Digital Output:** Digital audio optical output connector x1  
(PCM, Dolby Digital, DTS)

**DV Input:** IEEE 1394 Standard, 4 Pin: 1 pc

**Regional Code:** # 1

**Clock unit:** Quartz-controlled 12-hour digital display

**Operating temperature range:** 5 °C to 40 °C (41 °F to 104 °F)

**Operating humidity range:** 10 % to 80 % RH (no condensation)

**Power supply:** AC 120 V, 60 Hz

**Power consumption:** Approx. 19 W

**Dimensions (W × H × D):** 430 mm × 58 mm × 248 mm  
(16<sup>15</sup>/<sub>16</sub>" × 2<sup>5</sup>/<sub>16</sub>" × 9<sup>13</sup>/<sub>16</sub>"

**Mass:** Approx. 2.8 kg (6.16 lbs)

### Power consumption in standby mode:

**approx. 2.0 W** (Shipping condition)

**approx. 6.1 W** (User setting: Quick Start: On)

### Note

Specifications are subject to change without notice.

The model number and serial number of this product can be found on either the back or the bottom of the unit. Please note them in the space provided below and keep for future reference.

MODEL NUMBER \_\_\_\_\_ DMR-ES16

SERIAL NUMBER \_\_\_\_\_

### User memo:

DATE OF PURCHASE \_\_\_\_\_

DEALER NAME \_\_\_\_\_

DEALER ADDRESS \_\_\_\_\_

TELEPHONE NUMBER \_\_\_\_\_

Panasonic Canada Inc.

## PANASONIC PRODUCT – LIMITED WARRANTY

Panasonic Canada Inc. warrants this product to be free from defects in material and workmanship and agrees to remedy any such defect for a period as stated below from the date of original purchase.

<b>Technics Audio Product</b>	<b>One (1) year, parts and labour</b>
<b>Panasonic Portable / Clock Radio (without Tape, CD, MD)</b>	<b>One (1) year, parts and labour</b>
<b>Panasonic Audio / SD Audio Product</b>	<b>One (1) year, parts and labour</b>
<b>Panasonic DVD Product</b>	<b>One (1) year, parts and labour</b>
<b>Panasonic Combination DVD Player / VCR</b>	<b>One (1) year, parts and labour</b>
<b>Panasonic Combination DVD Recorder / VCR</b>	<b>One (1) year, parts and labour</b>
<b>Accessories including rechargeable batteries</b>	<b>Ninety (90) days</b>

### LIMITATIONS AND EXCLUSIONS

This warranty does not apply to products purchased outside Canada or to any product which has been improperly installed, subjected to usage for which the product was not designed, misused or abused, damaged during shipping, or which has been altered or repaired in any way that affects the reliability or detracts from the performance, nor does it cover any product which is used commercially. Dry cell batteries are also excluded from coverage under this warranty.

This warranty is extended to the original end user purchaser only. A purchase receipt or other proof of date of original purchase is required before warranty service is performed.

**THIS EXPRESS, LIMITED WARRANTY IS IN LIEU OF ALL OTHER WARRANTIES, EXPRESS OR IMPLIED, INCLUDING ANY IMPLIED WARRANTIES OF MERCHANTABILITY AND FITNESS FOR A PARTICULAR PURPOSE. IN NO EVENT WILL PANASONIC CANADA INC. BE LIABLE FOR ANY SPECIAL, INDIRECT OR CONSEQUENTIAL DAMAGES.**

In certain instances, some jurisdictions do not allow the exclusion or limitation of incidental or consequential damages, or the exclusion of implied warranties, so the above limitations and exclusions may not be applicable.

### WARRANTY SERVICE

**FOR PRODUCT OPERATION ASSISTANCE**, please contact:

Our Customer Care Centre:	Telephone #:	(905) 624-5505
	1-800 #:	1-800-561-5505
	Fax #:	(905) 238-2360
	Email link:	"Customer support" on <a href="http://www.panasonic.ca">www.panasonic.ca</a>

**FOR PRODUCT REPAIRS**, please locate your nearest Authorized Servicentre at [www.panasonic.ca](http://www.panasonic.ca) :

Link : "Servicentres™ locator" under "Customer support"

### **IF YOU SHIP THE PRODUCT TO A SERVICENTRE**

Carefully pack and send prepaid, adequately insured and preferably in the original carton.  
Include details of the defect claimed, and proof of date of original purchase.

<b>Angle</b> .....	27	<b>Divide Title</b> .....	31	<b>PCM Down Conversion</b> .....	39
<b>Audio</b>		<b>DivX</b> .....	24, 26, 45	<b>Picture</b> .....	28
attribute .....	27	<b>DNR</b> .....	28	<b>Playlist</b> .....	32
language .....	27	<b>DV automatic recording</b> .....	34	<b>Progressive</b> .....	28, 45
receiving, recording .....	19, 39	<b>DVD-RAM, DVD-R, DVD-R DL, DVD-RW, +R, +R DL, +RW</b> .....	4	<b>Properties</b>	
<b>Change Thumbnail</b> .....	31			playlist .....	33
<b>Channel</b>		<b>Enter name</b>		still picture .....	25
adding, deleting .....	13	disc .....	35	title .....	31
audio .....	27	playlist .....	33	<b>Protection</b>	
captions .....	14	title .....	20, 31	cartridge .....	35
Set Channels Automatically .....	13	<b>Finalize</b> .....	36, 45	disc .....	35
<b>Chasing playback</b> .....	19	<b>Flexible Recording</b> .....	19	title .....	31
<b>Cleaning</b>		<b>Format disc</b> .....	35	<b>Quick Start</b> .....	12, 37
disc .....	6	<b>FR (Flexible Recording) Mode</b> .....	17	<b>Quick View</b> .....	23
lens .....	6	<b>FUNCTIONS window</b> .....	28	<b>Ratings</b> .....	38
main unit .....	6	<b>JPEG</b> .....	24, 45	<b>Recording</b>	
<b>Clock settings</b> .....	15			Flexible Recording .....	19
<b>Close First Layer</b> .....	36	<b>Language</b>		from a video cassette recorder .....	34
<b>CM Skip</b> .....	23	audio .....	27	mode .....	17
<b>Connection</b>		on-screen .....	39	scheduled .....	20
amplifier, system component .....	11	soundtrack .....	27	<b>Repeat play</b> .....	27
antenna .....	8, 9, 11	subtitle .....	27	<b>Restore default settings</b> .....	37
cable box, satellite receiver .....	9, 10	<b>Menu</b>		<b>Resume play function</b> .....	23
DV IN terminal .....	34	MP3 .....	24	<b>Scheduled recording</b> .....	20
television .....	8, 9, 10	on-screen .....	27	<b>Setup menu</b> .....	37
video cassette recorder .....	8, 9, 10, 34	Pictures .....	24	<b>Shorten Title</b> .....	31
<b>Copy (playlist)</b> .....	33	Setup .....	37	<b>Signal Source (RF IN)</b> .....	13
<b>Copying</b>		<b>Mode</b>		<b>Simultaneous rec and play</b> .....	19
DV automatic recording .....	34	recording .....	17	<b>Soundtrack</b> .....	27
from a video cassette recorder .....	34	still mode .....	38	<b>Status messages</b> .....	28
Manual recording .....	34	<b>MP3</b> .....	24, 45	<b>Subtitle</b> .....	27
<b>CPRM</b> .....	45	<b>Noise reduction (NR)</b>		<b>Thumbnail</b> .....	31
<b>Create Chapter</b> .....	23, 31, 33	DNR .....	28	<b>TIFF</b> .....	24, 45
<b>Create DVD Top Menu</b> .....	36	Line-in NR .....	28	<b>Time Slip</b> .....	23
<b>Create playlists</b> .....	32	<b>On-screen</b>		<b>Transfer</b> .....	28
<b>Delete</b>		language .....	39	<b>TV Type</b> .....	14
all titles .....	35	menus .....	27	<b>V. Surround Sound</b> .....	28
chapter .....	31, 33	status messages .....	28		
chapter in playlist .....	33				
playlist .....	33				
title .....	29				
<b>Delete Navigator</b> .....	29				
<b>Dialog Enhancer</b> .....	28				
<b>Direct Navigator</b> .....	22, 30				

Manufactured under license from Dolby Laboratories. Dolby and the double-D symbol are trademarks of Dolby Laboratories.

"DTS" is a registered trademark of DTS, Inc. and "DTS 2.0 + Digital Out" is a trademark of DTS, Inc.

This product incorporates copyright protection technology that is protected by method claims of certain U.S. patents and other intellectual property rights owned by Macrovision Corporation and other rights owners. Use of this copyright protection technology must be authorized by Macrovision Corporation, and is intended for home and other limited viewing uses only unless otherwise authorized by Macrovision Corporation. Reverse engineering or disassembly is prohibited.

## -If you see this symbol-

### Information on Disposal in other Countries outside the European Union



This symbol is only valid in the European Union. If you wish to discard this product, please contact your local authorities or dealer and ask for the correct method of disposal.

Official DivX® Certified product.

Plays all versions of DivX® video (including DivX®6) with standard playback of DivX® media files. DivX, DivX Certified, and associated logos are trademarks of DivX, Inc. and are used under license.

## Panasonic Canada Inc.

5770 Ambler Drive, Mississauga, Ontario L4W 2T3  
[www.panasonic.ca](http://www.panasonic.ca)



## Free Manuals Download Website

<http://myh66.com>

<http://usermanuals.us>

<http://www.somanuals.com>

<http://www.4manuals.cc>

<http://www.manual-lib.com>

<http://www.404manual.com>

<http://www.luxmanual.com>

<http://aubethermostatmanual.com>

Golf course search by state

<http://golfingnear.com>

Email search by domain

<http://emailbydomain.com>

Auto manuals search

<http://auto.somanuals.com>

TV manuals search

<http://tv.somanuals.com>