

Panasonic®

Digital Disk Recorder Operating Instructions Model No. WJ-HD220

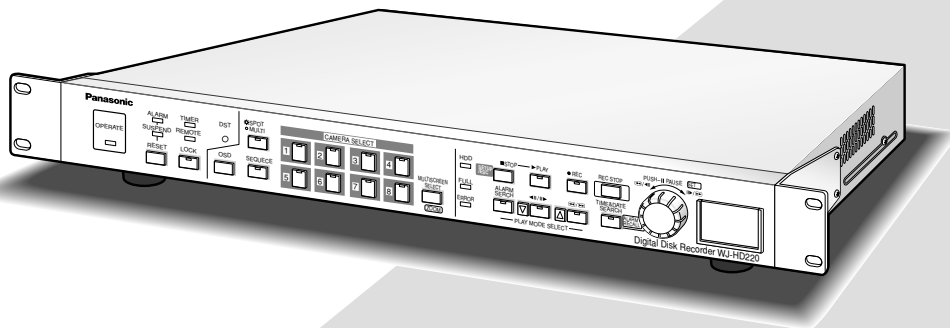

ENGLISH

FRANÇAIS

Before attempting to connect or operate this product,
please read these instructions carefully and save this manual for future use.

ENGLISH VERSION

Caution:

Before attempting to connect or operate this product, please read the label on the bottom.

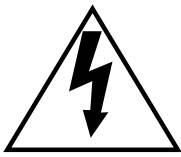
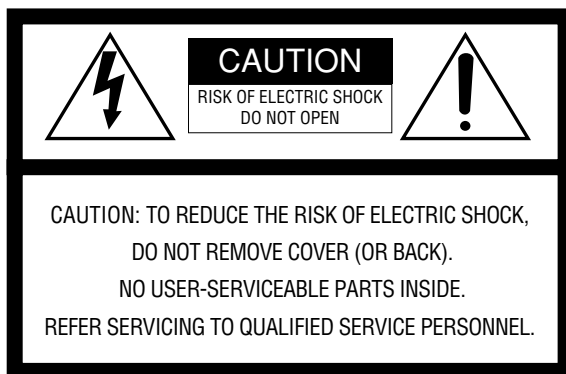

SA 1965

The lightning flash with arrowhead symbol, within an equilateral triangle, is intended to alert the user to the presence of uninsulated "dangerous voltage" within the product's enclosure that may be of sufficient magnitude to constitute a risk of electric shock to persons.



SA 1966

The exclamation point within an equilateral triangle is intended to alert the user to the presence of important operating and maintenance (servicing) instructions in the literature accompanying the appliance.



Power disconnection. Unit with or without ON-OFF switches have power supplied to the unit whenever the power cord is inserted into the power source; however, the unit is operational only when the ON-OFF switch is in the ON position. The power cord is the main power disconnect for all units.

For U.S.A.

NOTE: This equipment has been tested and found to comply with the limits for a Class A digital device, pursuant to Part 15 of the FCC Rules. These limits are designed to provide reasonable protection against harmful interference when the equipment is operated in a commercial environment. This equipment generates, uses, and can radiate radio frequency energy and, if not installed and used in accordance with the instruction manual, may cause harmful interference to radio communications.

Operation of this equipment in a residential area is likely to cause harmful interference in which case the user will be required to correct the interference at his own expense.

FCC Caution: To assure continued compliance, (example - use only shielded interface cables when connecting to computer or peripheral devices). Any changes or modifications not expressly approved by the party responsible for compliance could void the user's authority to operate this equipment.

The serial number of this product may be found on the bottom of the unit. You should note the serial number of this unit in the space provided and retain this book as a permanent record of your purchase to aid identification in the event of theft.

Model No. WJ-HD220

Serial No. _____

WARNING: To prevent fire or electric shock hazard, do not expose this appliance to rain or moisture. The apparatus shall not be exposed to dripping or splashing and that no objects filled with liquids, such as vases, shall be placed on the apparatus.

IMPORTANT SAFETY INSTRUCTIONS

- 1) Read these instructions.
- 2) Keep these instructions.
- 3) Heed all warnings.
- 4) Follow all instructions.
- 5) Do not use this apparatus near water.
- 6) Clean only with dry cloth.
- 7) Do not block any ventilation openings. Install in accordance with the manufacturer's instructions.
- 8) Do not use near any heat sources such as radiators, heat registers, stoves, or other apparatus (including amplifiers) that produce heat.
- 9) Do not defeat the safety purpose of the polarized or grounding-type plug. A polarized plug has two blades with one wider than the other. A grounding-type plug has two blades and a third grounding prong. The wide blade or the third prong are provided for your safety. If the provided plug does not fit into your outlet, consult an electrician for replacement of the obsolete outlet.
- 10) Protect the power cord from being walked on or pinched particularly at plugs, convenience receptacles and the points where they exit from the apparatus.
- 11) Only use attachments/accessories specified by the manufacturer.
- 12) Use only with the cart, stand, tripod, bracket, or table specified by the manufacturer, or sold with the apparatus. When a cart is used, use caution when moving the cart/apparatus combination to avoid injury from tip-overs.



- 13) Unplug this apparatus during lightning storms or when unused for long periods of time.
- 14) Refer all servicing to qualified service personnel. Servicing is required when the apparatus has been damaged in any way, such as power-supply cord or plug is damaged, liquid has been spilled or objects fallen into the apparatus, the apparatus has been exposed to rain or moisture, does not operate normally, or has been dropped.

CONTENTS

IMPORTANT SAFETY INSTRUCTIONS	3	Lock/Unlock Buttons	54
PREFACE	5	■ Password Verification	54
FEATURES	5	■ Enabling Button Lock	54
PRECAUTIONS	6	WJ-HD220 NETWORK OPERATION	55
MAJOR OPERATING CONTROLS AND THEIR FUNCTIONS	7	PREPARATIONS	56
■ Front View	7	■ System Requirements	56
■ Rear View	10	■ Connection	57
INSTALLATION	11	■ Main Page and Control Panel	58
■ Installing the Optional HDD	11	WJ-HD220 SETUP	59
■ Mounting in the Rack	12	■ To Access Setup Menus	59
CONNECTIONS & DIP SW SETTING	13	■ Timer Setup (TIMER SETUP)	59
System Composition & Connections	13	■ Trigger Action Setup (TRIGGER ACTION SETUP)	61
<Basic System>	13	■ Camera Recording Setup (REC CAMERA SETUP)	62
<PS·Data System>	14	■ Manual Recording Setup (REC SETUP)	62
<Network System>	15	■ Trigger Action Setup (TRIGGER ACTION SETUP)	62
■ Connection with the Camera Site	16	■ Externally Specified Recording Mode (EXT REC SETUP)	63
■ Connection with the Monitors	16	■ Display Setup (DISPLAY SETUP)	63
■ ALARM/REMOTE Connection	16	■ Camera Title (CAMERA TITLE)	64
■ Serial Port Connections	18	■ System Setup (SYSTEM SETUP)	64
DIP Switch Setting	20	■ Alarm Setup (ALARM SETUP)	66
■ System Mode	20	■ Video Motion Detector Setup (VMD SETUP)	66
■ DATA Port Termination	20	■ VMD Area Setup (VMD AREA SETUP)	66
SETUP PROCEDURES	21	■ Communication Setup (COMMUNICATION SETUP)	67
■ Prior to Setup	21	■ Serial Port Setup (SERIAL PORT SETUP)	67
■ Initializing	24	■ Camera System Setup (CAMERA SYSTEM SETUP) (only for PS·DATA)	68
■ Main Menu (WJ-HD220 MAIN MENU)	25	■ Network Setup (NETWORK SETUP)	68
■ Timer Recording Setup (TIMER REC)	25	■ Switcher Setup (SWITCHER SETUP)	70
■ Manual Recording Setup (REC SETUP)	28	■ Multi Sequence Setup (MULTI SEQUENCE SETUP)	71
■ Externally Specified Recording Mode (EXT REC SETUP)	28	■ Spot Sequence Setup (SPOT SEQUENCE SETUP)	71
■ Display Setup (DISPLAY SETUP)	28	■ Camera View Setup (CAMERA VIEW SETUP)	71
■ System Setup (SYSTEM SETUP)	31	■ System Information (SYSTEM INFORMATION)	72
■ Alarm Setup (ALARM SETUP)	37	■ System Log (SYSTEM LOG)	73
■ Communication Setup (COMMUNICATION SETUP)	38	■ Error Information on Network Connections (ERROR INFORMATION (FTP, SMTP, DDNS))	73
■ Serial Port Setup (SERIAL PORT SETUP)	38	NETWORK CONFIGURATION	74
■ Network Setup (NETWORK SETUP)	40	■ User Setup (USER SETUP)	74
■ Switcher Setup (SWITCHER SETUP)	41	■ Host Setup (HOST SETUP)	74
■ System Information (SYSTEM INFORMATION)	43	■ FTP Client Setup (FTP CLIENT SETUP)	75
■ Language (LANGUAGE)	44	■ Mail Setup (MAIL SETUP)	76
OPERATING PROCEDURES	45	■ Network Video Setup (NETWORK VIDEO SETUP)	77
Controlling Video Inputs & Monitors	45	OPERATING WJ-HD220	78
■ On the Spot Monitor	45	■ Main Panel	78
■ On the Multiscreen Monitor	46	■ Main Control Panel	80
Alarm Control Function	47	■ Alarm List	82
■ Alarm Input	47	■ HTTP Download and Viewing Images	83
■ Alarm Output	47	TROUBLESHOOTING	84
■ Resetting Alarm	48	SPECIFICATIONS & APPENDIX	85
■ Suspending Alarm Input	49	SPECIFICATIONS	86
■ Alarm Log Recall & Search	49	STANDARD ACCESSORIES	87
Recording	50	APPENDIX	88
■ Internal Timer Recording	50	■ Remote Control from System Controller	88
■ Power-on Recording	51	■ RS-232C Communication Protocol	90
■ Manual Recording	51	■ HDD Maintenance	94
■ Alarm Recording	51	■ Mail Contents	99
Playback	52	■ Network Security	100
■ Normal Playback	52	■ Network Error Information	101
■ Skip Playback	52		
■ Step Playback	52		
■ Alarm Search Playback	52		
■ Time & Date Search Playback	53		
■ Multiscreen Playback	53		

PREFACE

The Digital Disk Recorder WJ-HD220 is designed for use within a surveillance system and is a combination of a hard disk recorder and an 8-input video multiplexer. It records nearly 8 600 hours of picture and audio data selectively on a field basis with fine quality (FQ). Besides recording and

playback, the WJ-HD220 features versatile interfaces with the network and RS485 communications. Interactive menus are provided for recording setup, alarm setup, network setup, and so forth.

FEATURES

- **Built-in HDD**

- **Viewing Live Pictures**

- Single channel live (CH 1-8)
- Quad-split live, Multi-split live
- Single live zoomed electrically
- Sequential live

- **Recording Mode**

- Manual recording
- Timer recording
- Alarm-event recording
- Power-on recording
- Recording quality and rate selectable

- **Playback**

- Single channel playback
- Step-search playback
- Skip-search playback
- Time & Date search
- Quad playback
- Single playback zoomed electrically

- **Remote Control**

- Serial port control
- Alarm sensor inputs
- Control of up to 4 cameras (CAM1-4) by multiplexed PSD via direct connection

- **Network Access**

- Viewing live images
- Viewing playback images
- Controlling cameras
- Controlling recorder

- **Miscellaneous**

- Password protected buttons
- Alarm list search
- Language selection from 5 types for recorder and from 7 types for HTML

Trademarks

Microsoft, Windows, WindowsXP and Internet Explorer are either registered trademarks or trademarks of Microsoft Corporation in the United States of America and/or other countries.

PRECAUTIONS

- Refer all work related to the installation of this product to qualified service personnel or system installers.
- Prevent condensation from forming on the surface of the hard disk. Wait until the dew evaporates in any of the following cases.
 - The recorder is moved to a place significantly different in temperature or humidity.
 - The recorder is moved out of an air-conditioned room.
 - The recorder is placed in an extremely humid place.
 - The recorder is placed in a room where a heater has just been turned on.
- Consumable parts
 - Contact your dealer for replacement of the following parts when the time comes:
 - Built-in hard disk needs replacement after around 30 000 hours of operation.
 - Cooling fan also needs replacement after around 30 000 hours of operation.
 - Backup battery has a lifetime of around five (5) years in an ordinary environment.
- Do not block the ventilation opening or slots on the cover.
 - To prevent the appliance from overheating, place it at least 5 cm (2 inches) away from the wall.
- Do not drop metallic parts through slots.
 - This could permanently damage the appliance. Turn the power off immediately and contact qualified service personnel for service.
- Handle the appliance with care.
 - Do not strike or shake, as this may damage the appliance.
- Fully charge up the backup battery.
 - Keep the appliance turned on for at least 48 hours to recharge the backup battery. This procedure is necessary when using the appliance for the first time or after it has been unplugged for a long time from the AC outlet. Insufficient charging of the battery may cause erasure of settings if the AC power supply should fail.
- We recommend that you note down your settings and retain them. Power or battery failure may erase settings you entered.
- Do not expose the appliance to water or moisture, nor try to operate it in wet areas.
- Do not use strong or abrasive detergents when cleaning the appliance body.
 - Use a dry cloth to clean the appliance when it is dirty.
 - When the dirt is hard to remove, use a mild detergent and wipe gently.
- Do not operate the appliance beyond its specified temperature, humidity or power source ratings.
 - Do not use the appliance in an extreme environment where high temperature or high humidity exists. Use the appliance at temperatures within +5 °C to +45 °C (41 °F to 113 °F) and a humidity below 90 %.
 - The input power source for this appliance is 120 V AC 60 Hz.
- It might occur some kind of malfunction of "RECORD" or "PLAY", or "damage or defect of recorded data", due to failure or trouble of machine. Any consequent damage or loss arising from such problem is not subject of the warranty.

MAJOR OPERATING CONTROLS AND THEIR FUNCTIONS

■ Front View

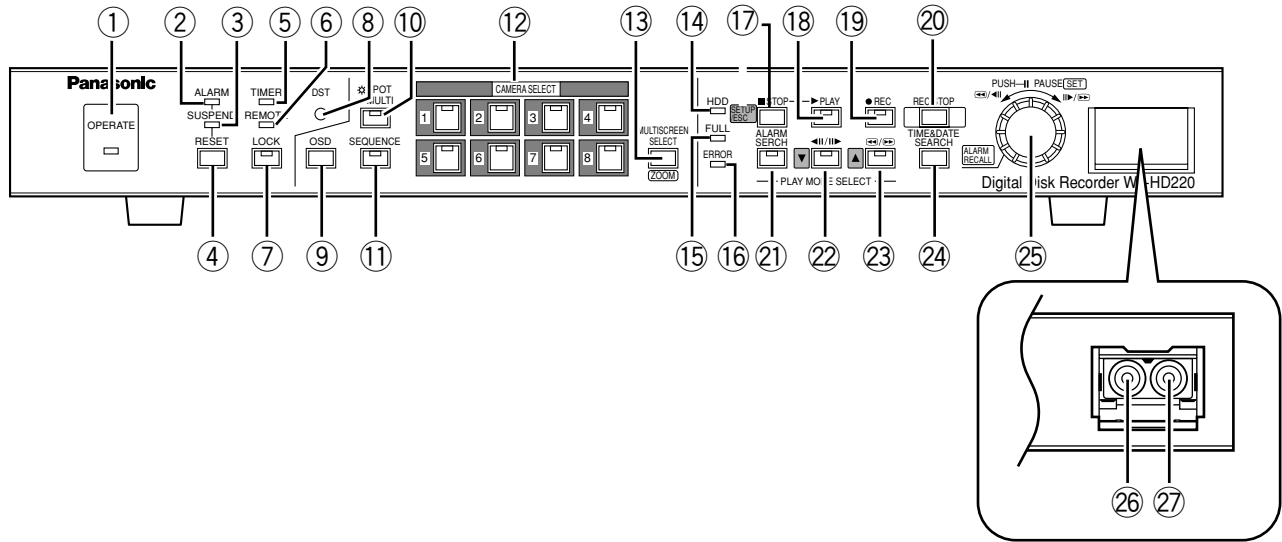

① Operate Indicator (OPERATE)

Lights up when the power of the WJ-HD220 Digital Disk Recorder is turned on.

② Alarm Indicator (ALARM)

Blinks when an alarm condition exists. It changes to steady light when the activated alarm is reset after the auto-reset time has elapsed.
To turn the indicator off, press the ALARM RESET button.

③ Alarm Suspension Indicator (SUSPEND)

Lights up when the alarm suspension mode is selected.

④ Alarm Reset Button (RESET)

Pressing this button cancels an activated alarm, and returns the system to the condition before the alarm was activated.

⑤ Timer Indicator (TIMER)

Lights up when the internal timer works after setting the TIMER to INT (internal) in the menu setup. It blinks while recording during the specified start and end time.

⑥ Remote Indicator (REMOTE)

Lights up when the recorder is remotely controlled via the serial port or 10BASE-T/100BASE-T port on the rear panel.

⑦ Lock Button (LOCK)

Holding down the button for 2 seconds will enable or disable the button lock function. While locked, the buttons at the front panel are not operable and the LED in the LOCK button lights up.

⑧ Daylight Saving Time (DST)

The button is recessed inside the front panel opening. Pressing this button shifts the internal clock to the summer time or vice versa.

⑨ On Screen Display Button (OSD)

Toggles the "on screen display" (OSD) on and off. You can eliminate OSD when it veils a portion on the monitor you wish to observe. OSD includes the time and date, alarm status, camera title, and recorder status. The status information is displayed only on the multiscreen monitor.

⑩ Monitor Selection Button (SPOT/MULTI)

Toggles the monitor selection between the spot monitor and multiscreen monitor you wish to control.
When the spot monitor is selected, the LED in the button lights up.

⑪ Sequence Button (SEQUENCE)

Runs the assigned sequence on the selected monitor for the specified duration. Pressing this button pauses the sequence, or restarts the paused sequence.
The LED in the button lights up when running, or blinks when pausing.

⑫ Camera Selection Buttons (CAMERA SELECT)

Pressing a button selects the input live image, or the recorded image of the specified input. The LED in the button indicates the status of the camera input as follows.

Green: The input displayed on the monitor is not being recorded, but is a live or playback image.

Yellow: The input is displayed on the monitor, and is recorded on the hard disk.

Orange: The input is not displayed on the monitor, but is recorded on the hard disk.

Blink Yellow: The input channel has an activated alarm and is in alarm recording mode.

Blink Green: The input channel has an activated alarm but it is not recorded.

These buttons are used for password input to release the button lock function.

13 Multiscreen Selection Button (MULTISCREEN SELECT/ZOOM)

Selects the multiscreen pattern to be displayed on the multiscreen monitor. The pattern changes every time the button is pressed depending on the setup for MULTI SEL MODE.

When ALL is selected:

Pattern 4A (comprising input 1, 2, 3, 4) → Pattern 4B (5, 6, 7, 8) → Pattern 9 (1-8) → Pattern 4A

When QUAD ONLY is selected:

Pattern 4A → Pattern 4B → Pattern 4A

Holding down this button for 2 seconds electronically enlarges the specified area when a single picture is displayed on the multiscreen monitor.

14 HDD Access Indicator (HDD)

Lights up when the HDD is accessed.

15 FULL Indicator (FULL)

Lights up when the available disk space has dropped below the percentage specified for HDD FULL and when STOP is set for DISK END MODE.

16 Error indicator (ERROR)

Blink Yellow: S.M.A.R.T. (Self-Monitoring Analysis and Reporting Technology) reports that the usable life-time of the HDD is nearing its end.

Blink Red: HDD error, HDD removed automatically, or thermal error.

17 Stop and Setup/Escape Button (STOP SETUP/ESC)

Pressing this button except in the menu setup or recording will stop the playback.

Holding down this button for 2 seconds calls up setup menus, or escapes from the setup.

In the setup menu, pressing this button will go one step back to the previous selection.

18 Playback Button (▶PLAY)

Pressing this button starts the playback. The LED in the button lights up while playing back, and it blinks while pausing the playback or searching the record.

19 Recording Button (●REC)

Pressing this button manually starts recording. The LED in the button lights up during recording mode. Recording starts when this button is pressed manually, when the preset time for the internal timer comes, or when an alarm sensor is activated.

20 Recording Stop Button (REC STOP)

Pressing the button for two seconds stops recording. Recording in any mode is stopped exclusively with this button.

21 to 24 are playback mode selection (**PLAY MODE SELECT**) buttons.

21 Alarm Search Button (ALARM SEARCH)

Pressing this button enables the JogDial to retrieve the beginning image of the desired alarm record. Press the [PLAY] button after searching the alarm record to play it back.

22 Step Playback & Down Button (◀◀ / ▶▶ ▼)

Pressing this button allows the JogDial to advance pictures field by field for minute searching.

In the menu setup, pressing this button moves the cursor downward.

23 Skip Playback & Up Button (◀◀ / ▶▶ ▲)

Pressing this button allows the JogDial to skip some picture fields in rough searching.

In the menu setup, pressing this button moves the cursor upward.

24 Time and Date Search Button (TIME&DATE SEARCH)

Pressing this button opens the time & date search window. Specify the time and date of the desired record rotating and pressing the JogDial, then press the [PLAY] button to start playback.

25 JogDial (PUSH- II PAUSE ◀◀ / ◀◀ ▶▶ / ▶▶ SET ALARM RECALL)

When playing back at normal speed (PLAY):

Pressing the JogDial pauses or restarts playback.

When operating alarm search (ALARM SEARCH):

Rotating the JogDial will access the beginning image of the next later or next older alarm record.

Holding down the JogDial for 2 seconds will jump to the newest record at the disk end in forward playback, or to the oldest record in reverse playback.

When playing back in step mode (STEP):

Rotating the JogDial one click clockwise or counter-clockwise will access the next later or next older image field. A minute search for the desired field can be made.

When playing back in skip mode (SKIP):

Rotating the JogDial changes the skip playback speed and directions. The more turns you rotate the JogDial, the faster the pictures will change. A rough search for the desired field can be made.

Holding down the JogDial for 2 seconds will jump to the newest record at the disk end in forward playback, or to the oldest record in reverse playback.

When pausing the playback:

Holding down the JogDial for 2 seconds will return to the live image display, and the alarm list will appear.

While opening the time and date search window (TIME&DATE SEARCH):

Pressing the JogDial moves the cursor to the next position in the window.

Rotating the JogDial increases or decreases the parameter.

After specifying the date and time, press the [PLAY] button to start playback.

When operating alarm recall (ALARM RECALL):

Holding down the JogDial for two seconds will open or close the alarm event log on the monitor.

Rotating the JogDial will scroll up or down the log page.

After selecting an alarm event with the [▲] or [▼] button, press the [PLAY] button to start playing back the selected alarm record.

When operating setup menus:

Pressing the JogDial validates the selected parameter and moves the cursor to the next position.

Rotating the JogDial increases or decreases the parameter.

②⑥ **Audio Out**

An RCA standard type jack supplies audio output signal that is identical to the AUDIO OUT terminal on the rear panel.

②⑦ **Video Out (VIDEO OUT)**

An RCA standard type jack supplies a video output signal that is identical to the MULTI OUT terminal on the rear panel.

■ Rear View

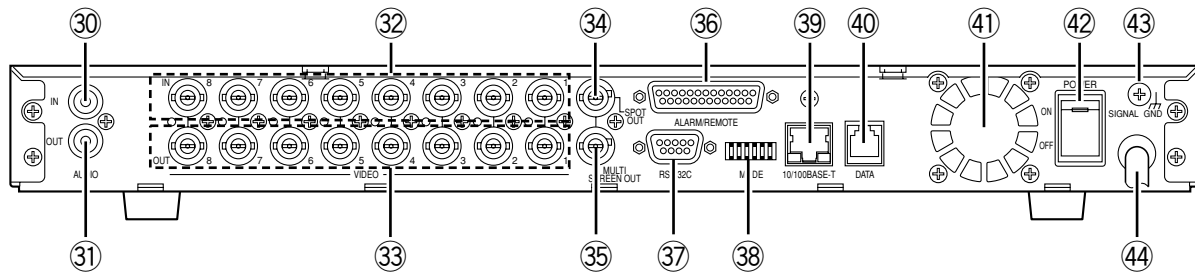

③⑩ Audio Input Connector (AUDIO IN)

An RCA standard jack that accepts an unbalanced -10 dBV, 10 k Ω line input audio signal supplied from an external device.

③⑪ Audio Output Connector (AUDIO OUT)

An RCA standard jack that supplies an unbalanced -10 dBV, 600 Ω line output audio signal to an external device.

③⑫ Video Input Connector (VIDEO IN 1-8)

Connectors 1-4 allow direct connection of the PSD cameras (video and commands multiplexed) while connectors 5-8 accept only normal video signals. A 75 Ω termination is made unless the video output terminal is connected.

③⑬ Video Output Connector (VIDEO OUT 1-8)

This BNC supplies a video signal looped through the video input terminal. Connectors 1-4 will output signals only when the recorder is turned on.

③⑭ Spot Output Connector (SPOT OUT)

This BNC supplies a full-screen live image signal to the spot monitor while recording or not recording. No playback or split image, setup menu, or OSD information is supplied via this connector.

③⑮ Multiscreen Output Connector (MULTISCREEN OUT)

This BNC provides the multiscreen monitor with the following video.

- Live image: single spot, multi-split spot, single sequence, quad-split sequence
- Playback image: single spot, multiscreen spot
- OSD information: camera title, time and date, recorder status, alarm status

The menu setup windows are also provided via this BNC.

③⑯ Alarm/Remote Port (ALARM/REMOTE)

This port accepts the alarm inputs 1 - 8, and remote controls while supplying status outputs. See ALARM/REMOTE Connection for details.

③⑰ RS232C Port (RS-232C)

This 9-pin port is used to communicate with the personal computer when controlling the recorder, or updating the firmware installed in the recorder. See Serial Port Connections for cable wiring, and RS-232C Communication Protocol.

③⑱ Mode Setup DIP Switch (MODE)

A 6-bit switch is used for such system setups as disk formatting, PSD chain termination, and so forth. See DIP Switch Setting for details.

③⑲ 10Base-T/100Base-T (10/100BASE-T)

This port is used to exchange control data with Ethernet via an Ethernet Hub.

④⑰ Data Port (DATA)

This port is used to communicate with external devices compatible with the PSD (Panasonic Security Data) protocol based on RS485.

④⑱ Cooling Fan

Prevents the temperature of the recorder from rising. Do not block the ventilation openings.

④⑲ Power Switch (POWER ON OFF)

This switch turns the power of the recorder on and off.

④⑳ Signal Ground Terminal (SIGNAL GND)

④㉑ Power Cord

Is connected to an AC outlet.

INSTALLATION

● Warning

This installation should be made by qualified service personnel or system installers.

● Notes

Places to avoid

- Direct exposure to sunlight or near a source of heat such as a radiator.
- Very dirty and dusty places. Places subject to strong vibrations.
- Near a transformer, dimmer, video player, radio or monitor. These may cause humming noise, etc.

About mounting

- Do not block the ventilation openings or slots in the cover to prevent the appliance from overheating.
- Always keep the temperature in the rack within +45 °C (113 °F).
- Secure the rear of the appliance to the rack with additional mounting brackets (procured locally), if the rack is subject to vibration.

■ Installing the Optional HDD (In case of the model installing a single HDD)

There is an extension space inside the recorder to mount the optional HDD unit, besides the one unit pre-installed when shipped.

1. Unplug the power cord from the AC outlet.
2. Remove nine screws to detach the top cover.
You will see the additional HDD bracket adjacent to the pre-installed HDD unit.
3. Remove six screws fastening the additional bracket.

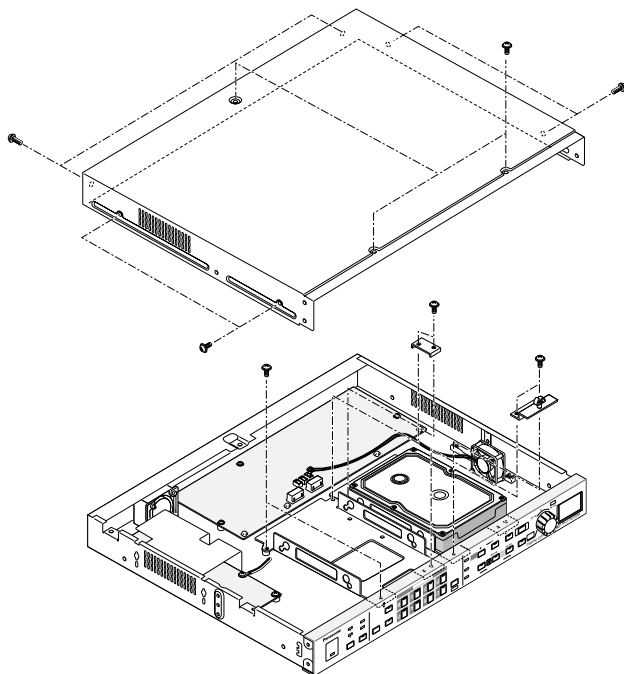

4. Disconnect the fan cord connector on the main board.
Then remove the bracket with the fan from the chassis.

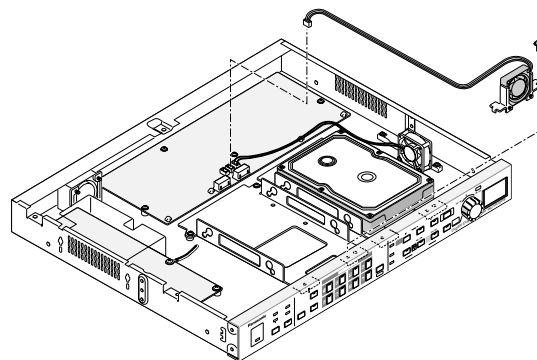

5. Prepare the optional HDD unit.
5-1 Attach the supplied serial number label and transparent seal on the HDD unit surface as illustrated.
5-2 Set the jumper connectors as illustrated.

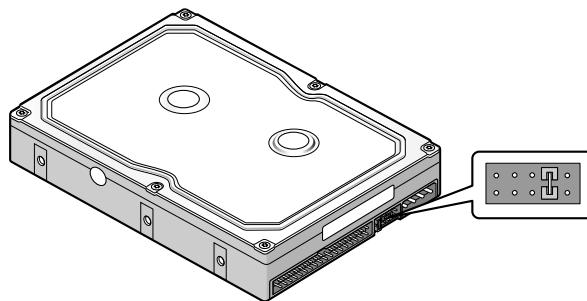

Notes:

- For pin connector settings, refer to the INSTRUCTIONS included with the HDD unit.
- Some optional HDD units to be added require setting change of the master HDD pin connector.

6. Assemble the optional HDD unit onto the bracket using the absorbers, sleeves, earth lug, and screws provided with the recorder.

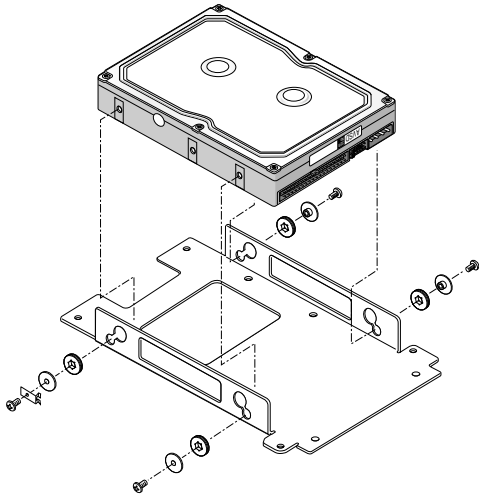

7. Place the HDD unit on the chassis, and fix it with six screws.
8. Reinstall the fan cord and connector.
9. Connect the power cable and flat cable on the rear of the HDD unit.

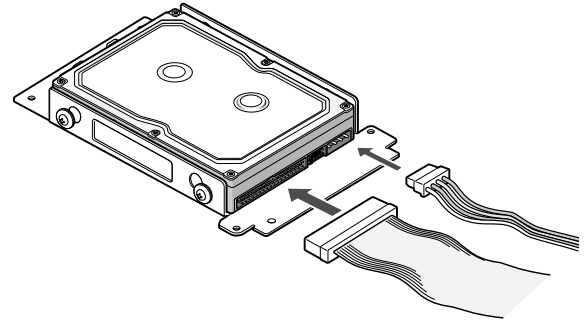

10. Fix the top cover to the recorder with nine screws.

■ Mounting in the Rack

1. Remove the four rubber feet by removing the five screws on the bottom of the unit.

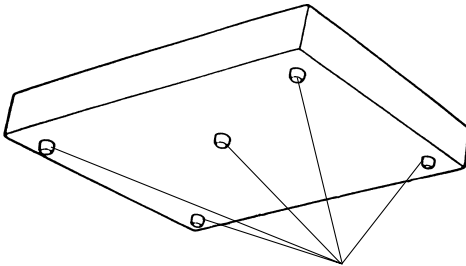

Remove 5 rubber feet.

2. Place the rack mounting brackets on both sides of the unit and tighten with the six supplied screws (M3 x10).

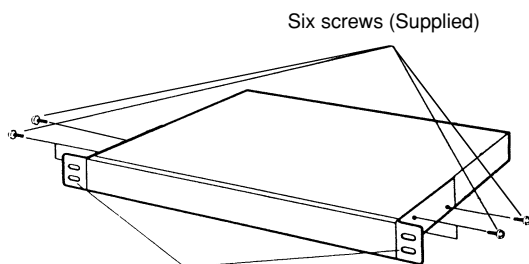

Fix the rack mounting brackets.

3. Install the unit with the rack mounting brackets in the rack by using four screws (not included).

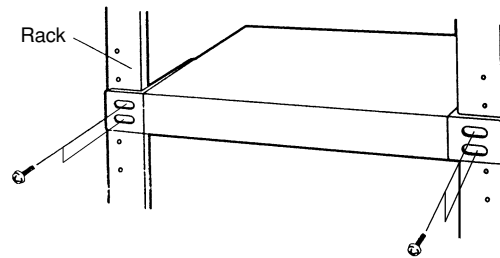

CONNECTIONS & DIP SW SETTING

System Composition & Connections

Three system compositions are introduced depending on the camera type and other peripherals connected.

<Basic System>

Ordinary system-cameras are connected in combination with the multiscreen and spot monitors, microphone, and speakers.

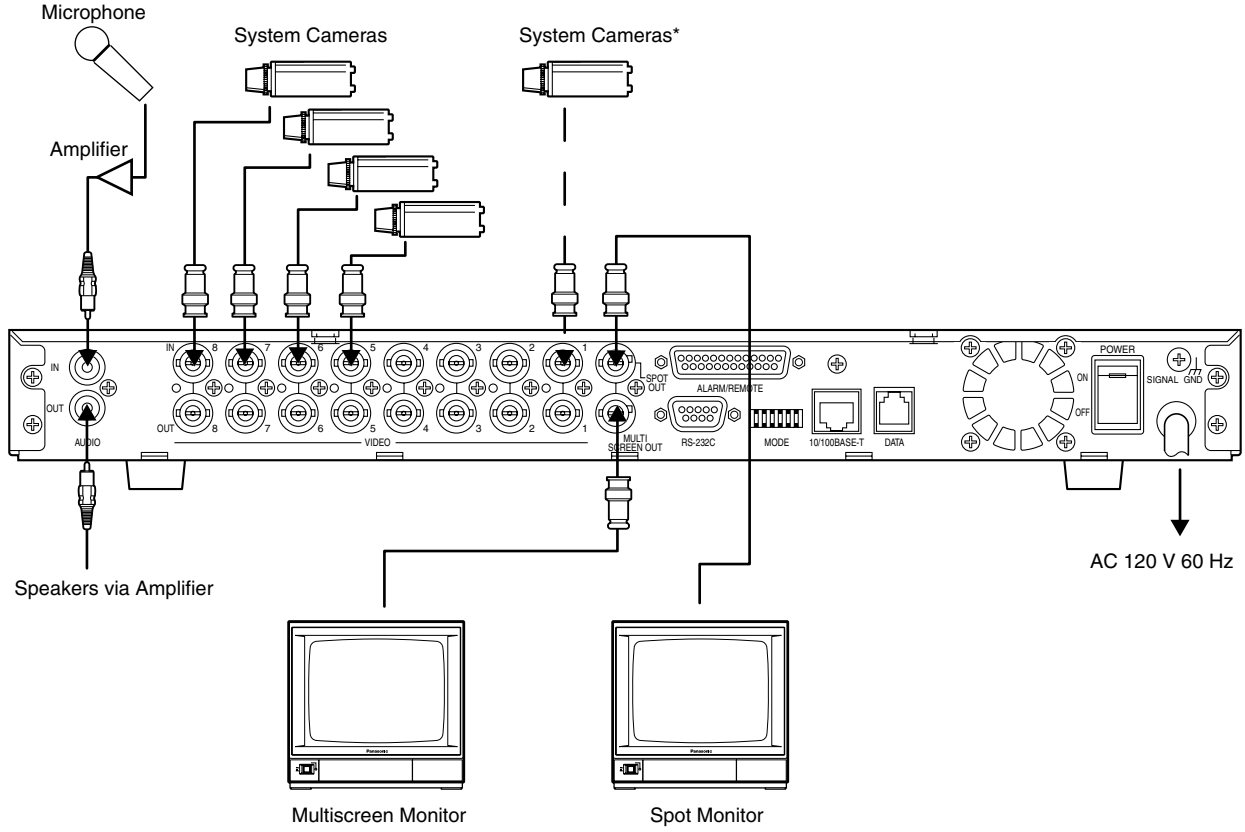

Note: Be sure to set DATA to OFF in the CAMERA SYSTEM SETUP menu when connecting system cameras to VIDEO IN connectors 1-4.

<PS·Data System>

Cameras equipped with data multiplex function are connected in combination with the system controllers and multiplex unit compatible with PS·Data.

Note: Set DATA to ON in the CAMERA SYSTEM SETUP menu when connecting combination cameras to VIDEO IN 1-4.

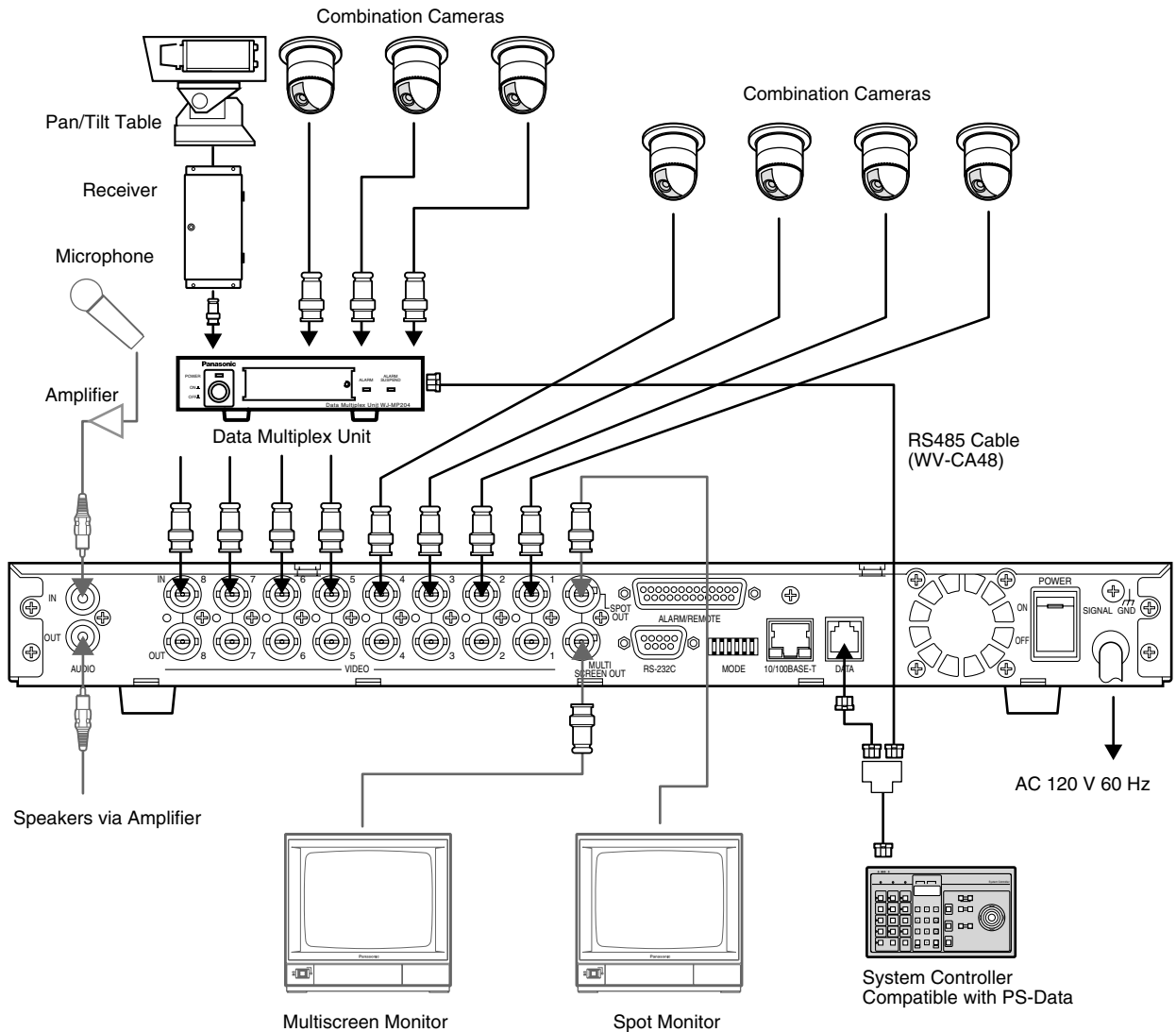

<Network System>

Personal computers can access the WJ-HD220 via the network.

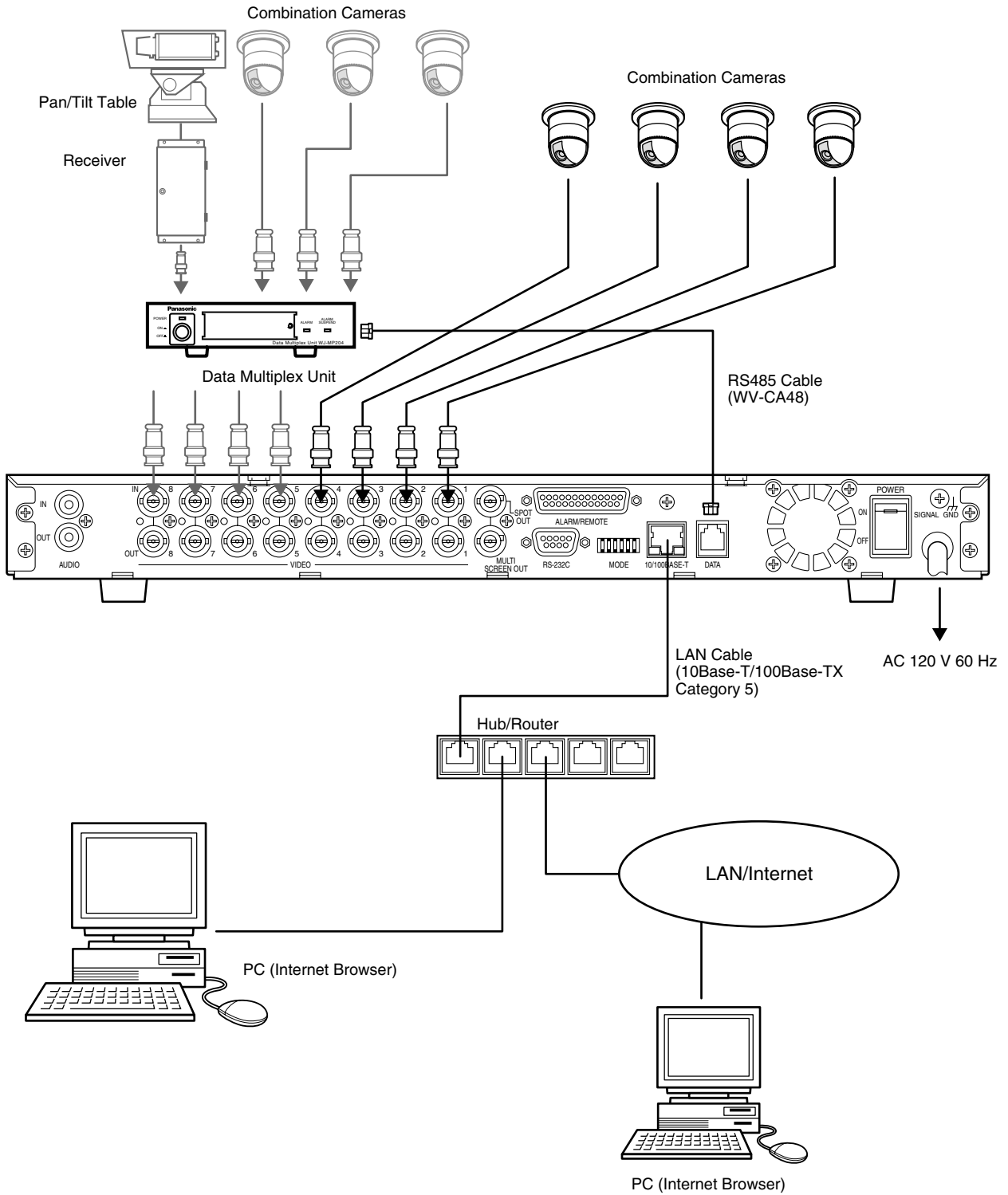

■ Connection with the Camera Site

● System Camera Connection

Connect system cameras to VIDEO IN 5-8.

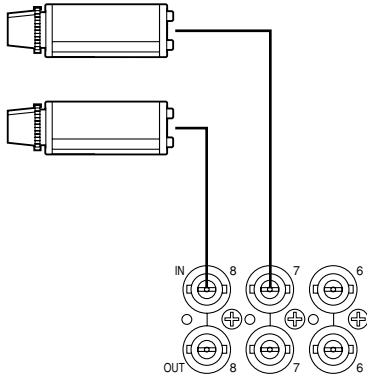

● Data-multiplex Camera Connection

Connect combination cameras directly to VIDEO IN 1-4. When connecting to VIDEO IN 5-8, use a Data Multiplex Unit as shown below.

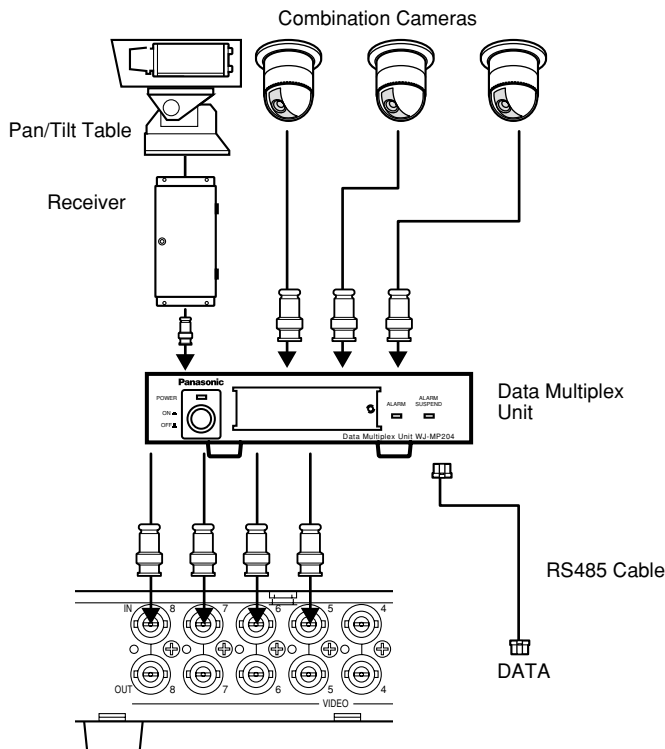

■ Connection with the Monitors

Connect the spot and multiscreen monitors.

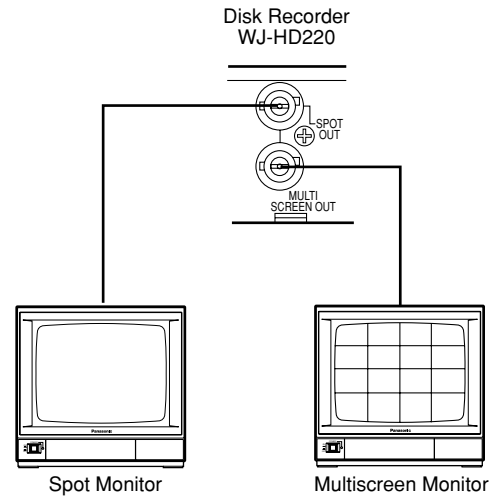

■ ALARM/REMOTE Connection

A 25-pin connector is used to accept and supply control signals.

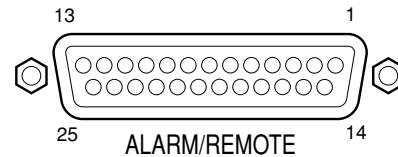

Pin #	Designation	Pin #	Designation
1	Alarm Reset In	14	Time Adjust Out
2	Alarm In 1	15	Alarm In 5
3	Alarm In 2	16	Alarm In 6
4	Alarm Recovery Out *1	17	Alarm In 7
5	Alarm Recovery Out 2	18	Alarm In 8
6	Alarm Out 1	19	Signal GND
7	Alarm Out 2 *2	20	Signal GND
8	Disk End Out	21	Play Status Out
9	Warning Out	22	EXT REC MODE In
10	Alarm In 3	23	No Connection
11	Alarm In 4	24	Sequence In
12	REC Status Out	25	Sequence Out
13	Time Adjust In		

Notes:

- Input rating: Low-active, non-voltage normally open (N.O.) contact
- Output rating for pin #4 Alarm Recovery Out *1: High-active with a 200 Ω resistor pulled up to +5 V
- Output rating for pin #7 Alarm Out 2 *2: High-active with a 4.7 kΩ resistor pulled up to +12 V
- Output rating for pin #6 Alarm Out 1: Low-active, maximum load capacity of +12 V 100 mA
- Output rating for other pins: Low-active, maximum load capacity of 24 V 100 mA , open-collector with a 4.7 kΩ resistor pulled up to +5 V inside
- Pin #24 Sequence In receives a close contact input to advance the sequence one step. This input does not start a sequence but forwards the presently running sequence by one step.
- Pin #25 Sequence Out supplies a negative pulse when the sequence running on the multiscreen monitor advances one step.

● Alarm Connection

There are eight alarm inputs, while two outputs are provided with different driving capacity.

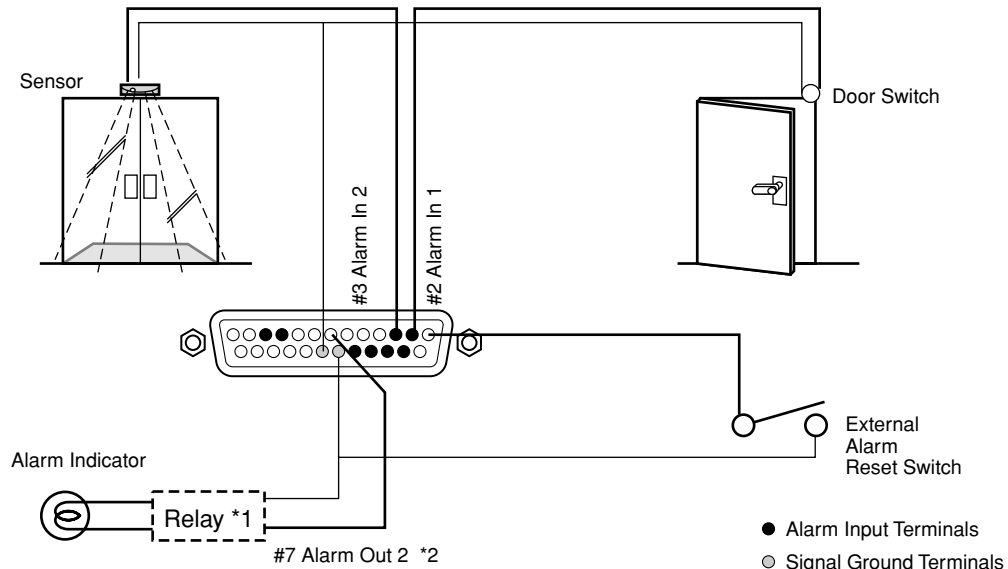

*1: Use when the indicator exceeds over the drive capacity of the alarm out terminal.

*2: Connect to #6 Alarm Out 1 when using a low-active device.

● External Recording Connection

The recording mode will change from the internal timer mode to the external mode (EXT REC MODE) specified in REC SETUP menu when the switch is turned on.

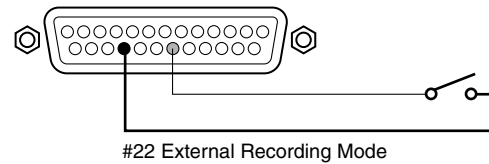

● Time Adjusting Connection

The internal timer is calibrated with this input.

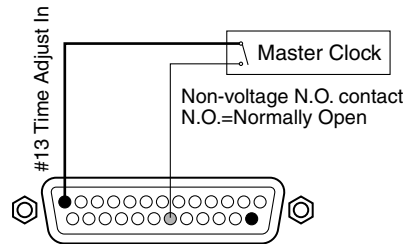

Serial Port Connections

RS-232C Connection

A 9-pin connector is provided with the recorder to communicate with the PC via the RS-232C interface.

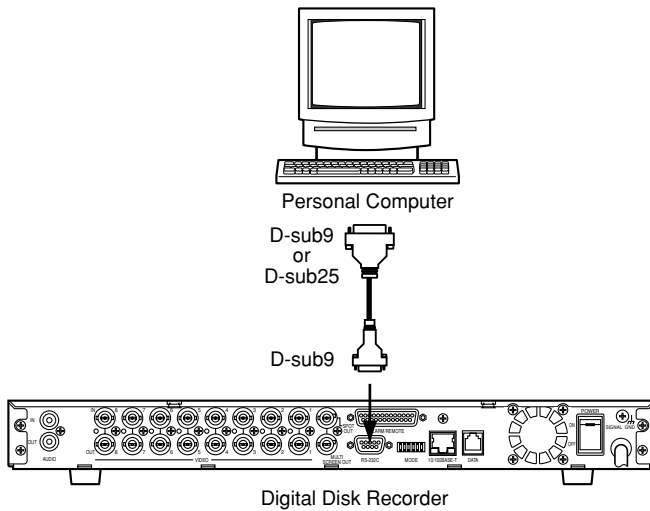

Note: Using a conversion cable may malfunction since this RS-232C is incompatible with USB.

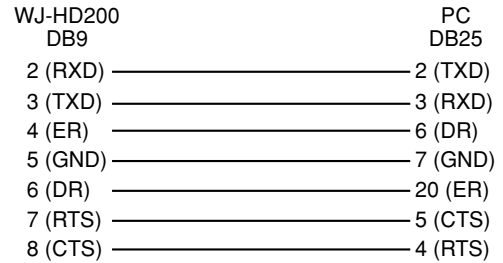
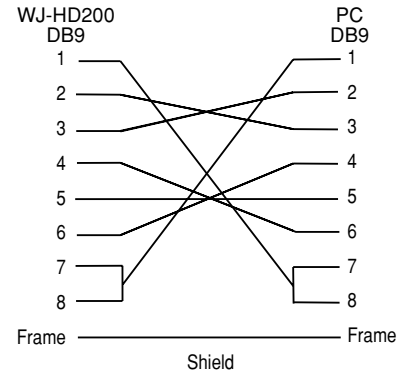

PS-Data Connection

Note the following when connecting the recorder with PS-Data devices.

1. Place the recorder in the middle of the chain when the System Controller and other devices are connected.
2. Termination must be made at both ends of the chain.
Refer to the manual included with each device for termination.
See page 20, ■ DATA Port Termination for the recorder.
3. Protocol selection must be set to PS-DATA in the menu setup.
4. Use the optional RS-485 cable for connection.

Connection examples are shown.

<Case 1 > With System Controller and other devices

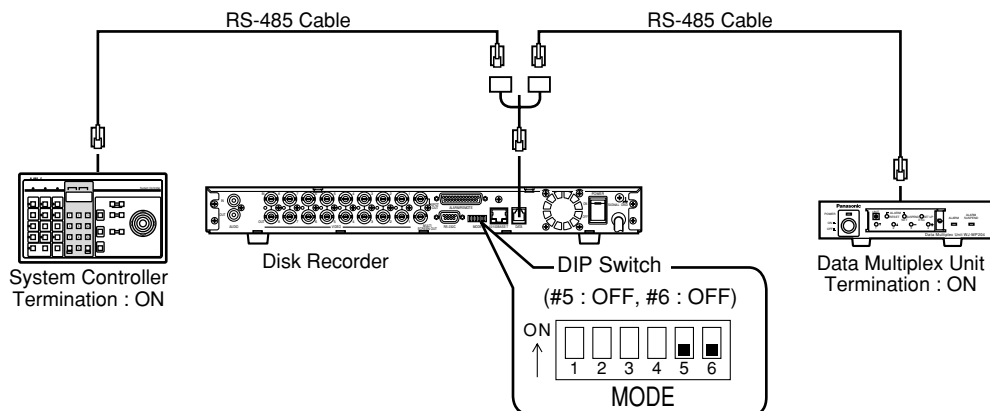

<Case 2> Exclusively with System Controller

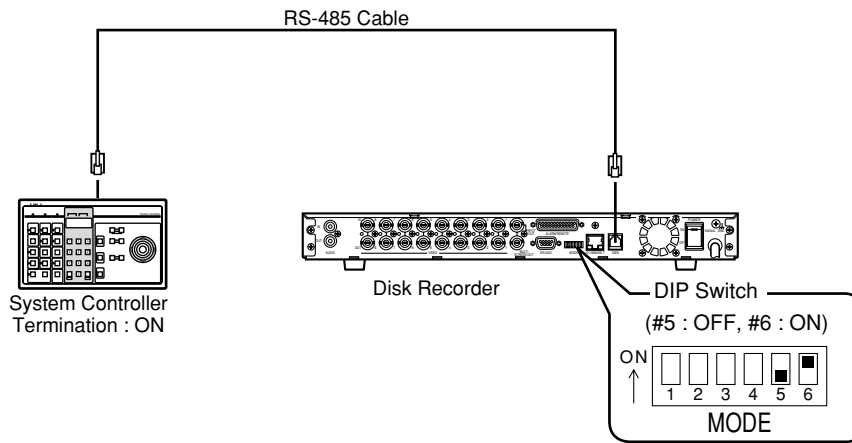

<Case 3> With other system devices except System Controller

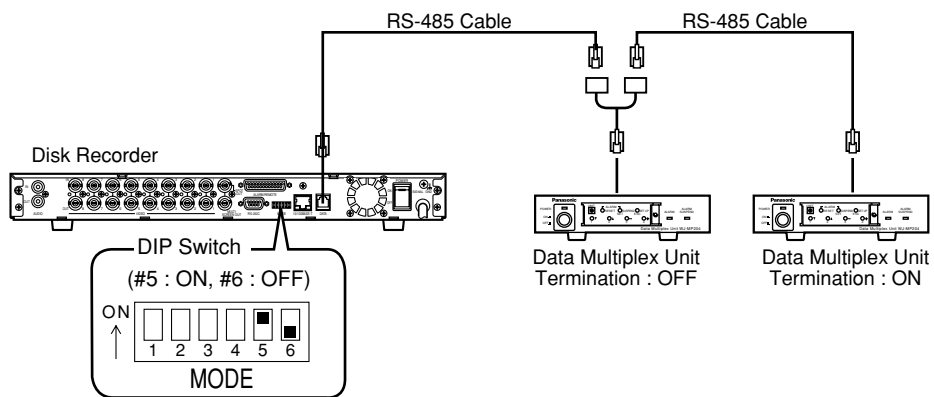

● 10/100BASE-T Port Connection

The PC controls the WJ-HD220 via Ethernet.

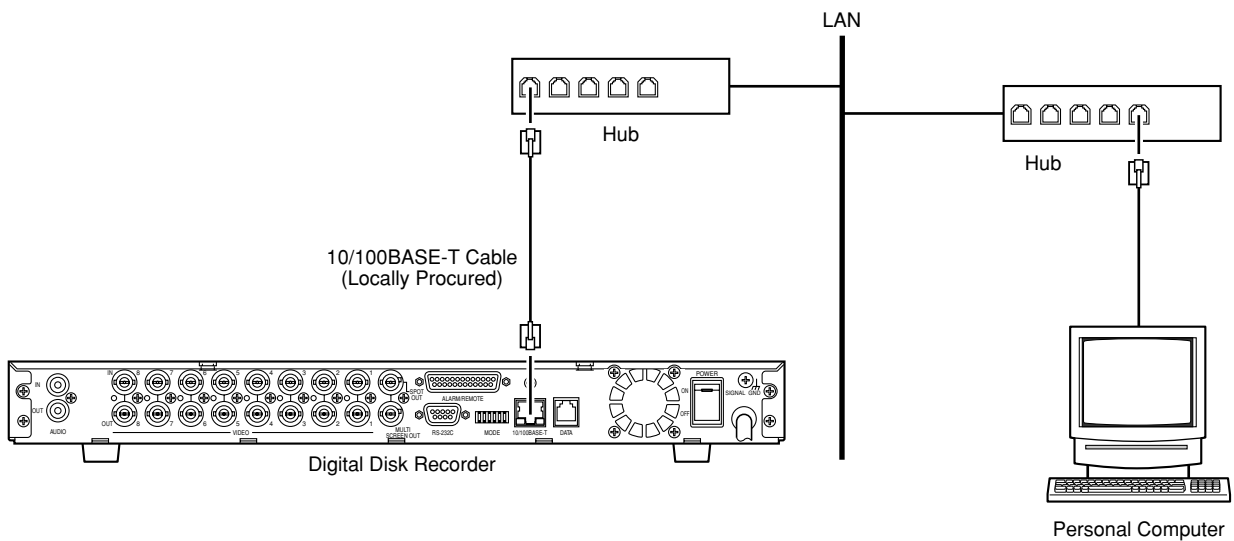

DIP Switch Setting

The 6-bit DIP switch is used as follows.

Note: Use only the switch combinations shown in the table above.

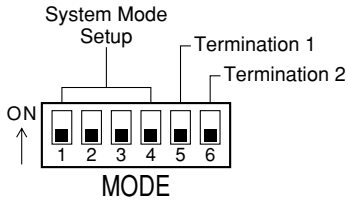

- #1 through #4: System mode setup
- #5 and #6: DATA port termination

■ System Mode

Switch Position	Mode
	Normal operation mode
	Initializing HTML contents

■ DATA Port Termination

Termination switch positions depend on the system composition.

Switch Position	System Composition with:		Note
	System Controller	Other System Devices	
	Yes	Yes	<Case 1>
	Yes	No	<Case 2>
	No	Yes	<Case 3>

SETUP PROCEDURES

■ Prior to Setup

● Turning On the Power

1. Plug the power cord into the AC outlet.
2. Turn on the power switch on the rear panel. The operate LED lights up. An HDD check and a system check will be carried out while displaying respective messages. Power-on recording will start if TIMER has been set to EXT in the SYSTEM SETUP menu.
3. Press the [REC STOP] button to stop power-on recording, if applicable.

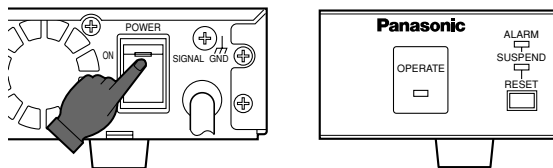

4. Hold down the buttons of [LOCK] and [RESET] simultaneously to suspend alarm inputs. The SUSPEND indicator will light up. This will prevent your setting operations from being interrupted by alarm inputs.

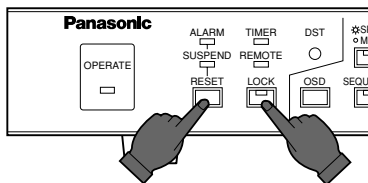

Note: Refer to Power-on Procedures in the Appendix for details.

● Turning Off the Power

1. Press the [STOP] button when playing back, or [REC STOP] button when recording. Confirm that the HDD access indicator has turned off.
2. Turn off the power switch on the rear panel. The operate LED goes off.

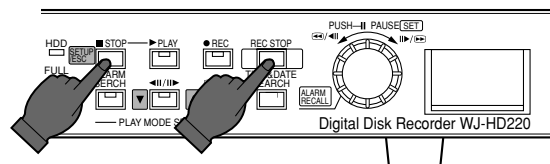

Confirm that the HDD access indicator is off.

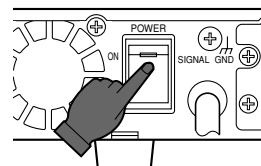
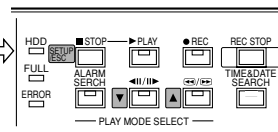

Notes:

- Do not turn off the power while the HDD access indicator is on.
- Do not leave the recorder turned off for a long time. Supply AC power to the unit and turn it on to charge up the backup battery.

● Displaying WJ-HD220 (MAIN MENU)

1. Confirm that the camera and peripherals are connected correctly and securely.
2. Turn on the power switches of all system components.
3. Hold down the [STOP] button for 2 seconds. The WJ-HD220 MAIN MENU appears.

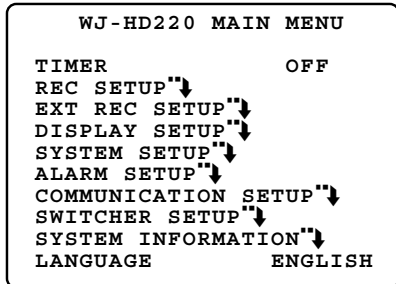

● Closing WJ-HD220 (MAIN MENU)

1. Hold down the [STOP SETUP/ESC] button for 2 seconds. The setup menu disappears, and normal operation will be available.

Note: A blackout screen may appear for about 2 seconds until the camera image is displayed if you changed the settings and closed the setup menu.

● Buttons and Dials Used for Setup

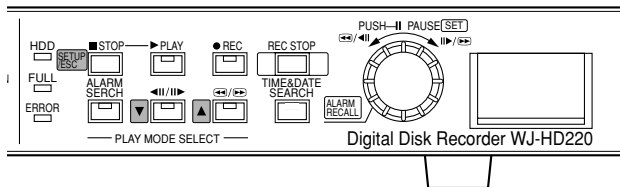

[▲ up] button: Moves the cursor upwards in a menu, and opens the previous menu page.

[▼ down] button: Moves the cursor downward in a menu, and opens the next menu page.

JogDial (Counter-clockwise): Decreases the parameter value.

JogDial (Clockwise): Increases the parameter value.

JogDial (Pressing) SET: Validates the selection, and moves the cursor to the right. When the selected item has a "↓" return symbol, pressing this will open the next lower layer menu for more minute settings

[STOP SETUP/ESC] button (Pressing): Moves the cursor to the left, or returns to the previous menu.

[STOP SETUP/ESC] button (Holding down): Opens the setup menu, or escapes from it and switches back to normal operation.

● Menu Tree

The figure shows the hierarchy of menu windows.

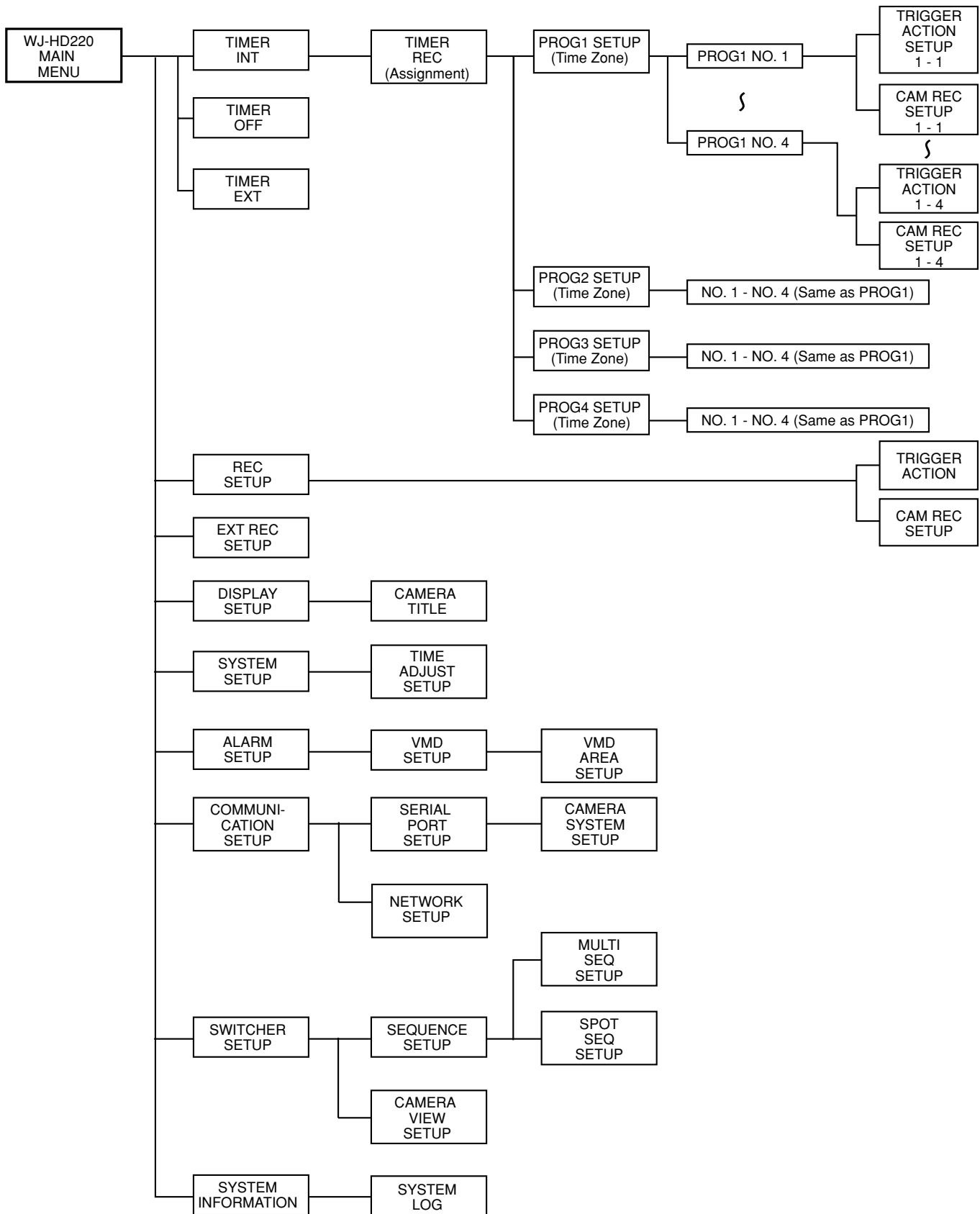

■ Initializing

You can initialize all disk contents including image data and/or setup data.

● Initializing All Contents & Setup Data

Warning! The following are irrevocable procedures. We strongly recommend that you copy important pictures from the hard disk.

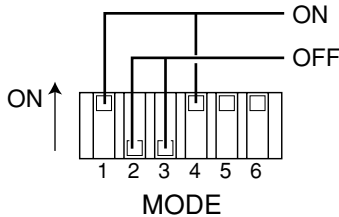

1. Press the [REC STOP] button or [STOP] button to stop recording or playback.

2. Turn off the power.

3. Set MODE switches #1 through 4 on the rear panel as follows:

- #1: ON
- #2: OFF
- #3: OFF
- #4: ON

4. Turn on the power.

The disk contents and setup data are initialized.

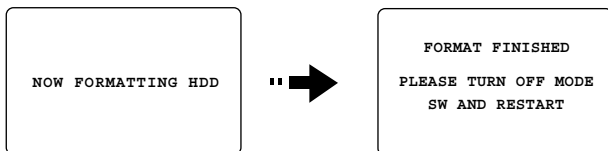

Notes:

- This will take about 40 minutes.
- When finished, be sure to carry out step 5.

5. Turn off the power, and return the MODE switches to the previous positions. Then turn on the recorder.

● Initializing Setup Data

SYSTEM INFORMATION			
HDD1 HOUR METER	10000H		
HDD2 HOUR METER	10000H		
HDD CAPACITY	XXX.XXG		
DEFAULT→	SET→		
SYSTEM VERSION	X.XX		
SYSTEM LOG	↓		

1. Open the SYSTEM INFORMATION window, then move the cursor to DEFAULT.

2. Press the JogDial to move the cursor to SET.

3. Press the JogDial.

4. Select YES with the JogDial.

YES: Initializing of setup data is enabled.

5. Press the JogDial.

SET DONE appears on the monitor after initializing.

6. Press the [SETUP/ESC] button.

The cursor moves to DEFAULT.

7. Hold down the [SETUP/ESC] button for 2 seconds to quit the setup.

Notes:

- After closing the setup menu, the system may automatically restart if any parameter on the network has been changed.
- The menu shown above is based on the assumption that an optional HDD is installed in the recorder. As shipped from the factory, the hour meter is set to 1 and the capacity to half.

● Initializing Settings for Network Setup Menu

1. Stop recording or playback if applicable, and turn off the power.

2. Set the MODE switches as shown in the figure.

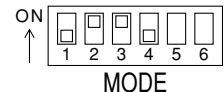

3. Turn on the power. Wait for a few minutes until initialization is completed.

4. Return the MODE switches to the previous positions. Then press the [STOP] button.

Note: These procedures reset the settings exclusively for network setup menus: USER SETUP, HOST SETUP, FTP SETUP, MAIL SETUP, and NETWORK VIDEO SETUP.

■ Main Menu (WJ-HD220 MAIN MENU)

The main menu is located at the top of the menu tree from where every menu window starts.

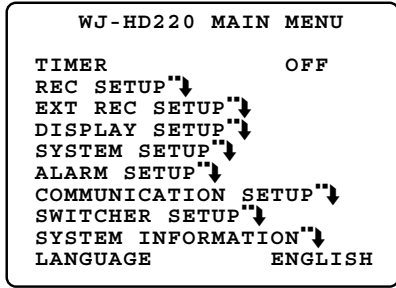

1. Hold down the [SETUP/ESC] button for 2 seconds. The main menu appears.
2. Select a setup menu you wish to program using the [▲] or [▼] button, and press the [SET] (JogDial). The selected setup menu opens. The following pages will detail each setup menu.

■ Timer Recording Setup (TIMER REC)

This menu assigns a timer to start recording by use of an external timer or the internal timer. When the internal timer (INT) is set, there are four programs assignable to the weekly and/or daily schedule. Each program can contain up to four events along with start and end time, and recording-mode. Alarm recording will be carried out when an alarm operates within the scheduled time zone.

When the external timer (EXT) is set and the connected timer switch turns on to supply power, the recorder will start power-on recording.

1. Select a timer mode using the JogDial.
 - OFF:** Does not use any timer, and manual recording is available.
 - INT:** Carries out internal timer recording according to the program.
 - EXT:** Carries out power-on recording.
2. Press the JogDial to validate the selection. When INT is selected, the TIMER REC menu opens.

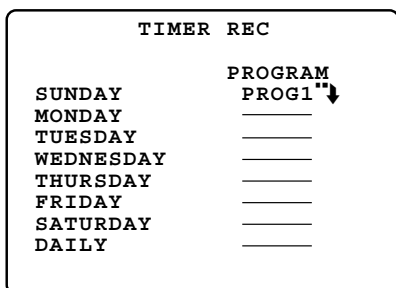

3. Move the cursor to the desired line using the [▲] or [▼] button.
4. Select any parameter from PROG1 to PROG4 using the JogDial, and press the JogDial. The PROG1-4 SETUP menu opens.

● Program "1-4" Setup (PROG1-4 SETUP)

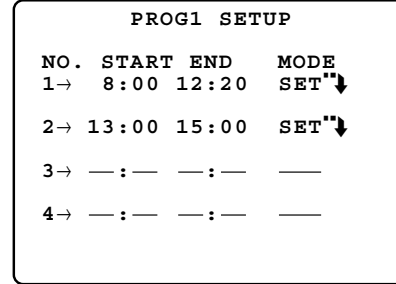

1. Select the event number with the [▲] or [▼] button, and press the JogDial. The cursor moves to the START position. After this operation, the [▲] and [▼] buttons move the cursor to the right and left.
2. Select a start time (START) using the JogDial, and press the [▲] button to move to the next position.

Available START times: From 0:00 to 23:59 in the 24-hour system.

3. Select an end time (END) in the same way as above and press the [▲] button to move the cursor to the MODE position.

Available END times: From 0:00 to 24:00 in the 24-hour system.

Notes: There are some restrictions on programming.

- An event, except the first event (NO 1), can be programmed only if the immediately preceding event has been set up.
- The start time should be later than the end time of the immediately preceding event.
- The end time should be later than the start time of the event.
- An end time set at 24:00 will cancel all following events.
- When you set both the start and end time of an event to the same hour, the event will not be recorded.
- When planning to record all day long, set the start time to 00:00 and the end time to 24:00 for the final event.
- When planning to record through midnight: Set 24:00 for the end time of the final event of the day.

Set 00:00 for the start time of the initial event of the next day.

- A combination camera will move to the preset position if an alarm arises and the position has been assigned beforehand in TRIGGER ACTION SETUP of the REC SETUP menu.

4. Press the JogDial while the cursor is on SET"↓ to open the event programming menu.

● Recording Mode Setup (PROG1-4 SETUP, NO. 1-4)

PROG1 NO.1 SETUP	
REC MODE	SF-24H
REC RATE	30FPS
REC QUALITY	SUPER FINE
ALM REC MODE	SF-24H
REC RATE	30FPS
REC QUALITY	SUPER FINE
PRE ALM REC	0S
POST ALM REC	10S
DYNAMIC REC	OFF
TRIGGER ACTION SETUP"	↓
CAM REC SETUP"	↓

Parameters for internal timer recording are assigned to each event (NO. 1-4) of the program (PROG 1-4) in this menu. There are five recording modes available: super fine (SF), fine (FQ), normal (NQ), long-time (EX) and optional (SP). If combined with audio recording (-A), the number of recording modes doubles. The remaining recording time (shown as xx in the list below) is determined by the selected recording mode (10 options) and resolution (2 options) in the SYSTEM SETUP menu.

In the SP mode, the field rate and picture quality are variable and can be selected at option in the range of 0.1 to 30 FPS with five quality level options respectively. After the recording mode is selected, the available recording time is determined and displayed.

Rec Mode	Quality	Audio Record	Note
SF-xxxH	Super Fine	N/A	
FQ-xxxH	Fine	N/A	
NQ-xxxH	Normal	N/A	
EX-xxxH	Long time	N/A	
SF-AxxxH	Super Fine	Available	
FQ-AxxxH	Fine	Available	
NQ-AxxxH	Normal	Available	
EX-AxxxH	Long time	Available	
SP-AxxxH	Optional setup	Available	Field rate, quality selected optionally
SP-xxxH	Optional setup	N/A	Field rate, quality selected optionally

Notes:

- By selecting a recording time, the recording rate (REC RATE) and the recording quality (REC QUALITY) will be automatically calculated and displayed. For details, refer to the provided booklet "REC MODE TABLES for WJ-HD220".

- Even if preset to 30 or 15 FPS, the actual recording rate may drop to 7.5 FPS at worst while busy multi tasks such as playback, remote-access playback, remote-access live image, FTP access, multi-split display, or video motion detection are carried out simultaneously. The status display will indicate "**PLAY" while playing back the images recorded with a rate different from the preset.
- Suffix "xxx" following "SP-" is specified in REC MODE TABLE in the ADDENDUM attached to the manual.

1. Move the cursor to MODE, and press the JogDial. The mode area will be highlighted.

2. Select a recording mode using the JogDial, and press the Jogdial. Audio data will be recorded when a mode with hyphen A is selected.

Available recording mode: SF, FQ, NQ, EX, SP, SF-A, FQ-A, NQ-A, EX-A, and SP-A

3. When SP or SP-A is selected, specify a recording rate (REC RATE) using the JogDial, and press the JogDial.

Available recording rates: From 0.1 to 30 FPS

4. When SP or SP-A is selected, specify a recording quality (REC QUALITY) using the JogDial, and press the JogDial.

Available recording qualities: SUPER FINE, FINE, NORMAL, EXTENDED

● Alarm Recording Mode Setup (ALM REC MODE)

Alarm events arising within the time zone specified by the program will start recording with the preset parameters. Refer to "PROG NO. SETUP" described above in this menu for operating procedures and available parameters, since they are very similar.

● Pre-alarm Recording (PRE ALM REC)

Picture recording will start prior to the alarm activation at the time specified by this setting.

1. Move the cursor to PRE ALARM REC with the [▲] or [▼] button.

2. Select the desired pre-recording time with the JogDial, and press the JogDial.
The default is 0S.

Available times (seconds): 0S, 1S, 2S, 3S, 4S, and 5S

● Post-alarm Recording (POST ALM REC)

This setting specifies the duration of alarm recording after an alarm input. Functions active during alarm recording are buzzer beeping, ALARM LED indication, "ALARM" status display, and the ALARM OUT signal.

1. Move the cursor to POST ALARM REC with the [▲] or [▼] button.
2. Select the desired duration with the JogDial.
The default value is 10 seconds.
The unit will revert to the previous status when the time has elapsed.

Available times (seconds): 5, 10, 20, 30

Available times (minutes): 1, 1.5, 2, 3, 6

Continue: Recording continues until the [RESET] button is pressed, or the RESET IN signal is supplied to the rear panel.

Manual: Recording continues for as long as the alarm input is active, or at least for 10 seconds if the input turns inactive earlier.

● Dynamic Recording (DYNAMIC REC)

This setting specifies the recording pattern on the disk when one or more alarms operate.

1. Move the cursor to DYNAMIC REC with the [▲] or [▼] button.
2. Select the parameter with the JogDial, and press the JogDial.
The default is OFF.

ALM-MULTI: Alarmed channels are recorded with priority over others.

OFF: All channels are recorded with the same priority.

● Trigger Action Setup (TRIGGER ACTION SETUP)

This setting specifies the two roles of alarm recording and alarm control functions (Refer to page 47) in the post-alarm sequence.

TRIGGER ACTION SETUP		
CAM	MODE	PRESET
1→	REC&ALM	--
2→	REC&ALM	--
3→	REC&ALM	--
4→	REC&ALM	--
5→	REC&ALM	
6→	REC&ALM	
7→	REC&ALM	
8→	REC&ALM	

When combination cameras are connected to VIDEO IN 1-4 on the rear panel, you can select a preset position for cameras 1-4. The camera will move to the preset position when an alarm other than VMD arises for the camera.

Notes:

- The preset position assignment on the TRIGGER ACTION SETUP menu is not available for each PROG n (1 - 4) SETUP menu, but available only for the REC SETUP menu.
- You need to preset desired positions for the camera prior to operation.
- VMD will not move the camera to the preset position.

1. Move the cursor to TRIGGER ACTION SETUP \downarrow , and press the JogDial.
The TRIGGER ACTION SETUP menu opens.
2. Move the cursor to the channel.
3. Select a mode with the JogDial, and press the JogDial.
The default is REC&ALM.
OFF: Disables alarm recording or warning.
REC&ALM: Enables both alarm recording and warning.
REC: Enables alarm recording, but disables warning.
4. The cursor is at the PRESET column. Select a preset parameter with the JogDial, and press the JogDial.
1-64: Moves the camera to the specified preset position.
HOME: Moves the camera to the home position.
--: Does not move the camera.
5. Repeat steps 2, 3 and 4 until all channels are set.
6. Press the [SETUP/ESC] button to return to the PROG1 SETUP, NO. 1 menu.

● Camera Recording Setup (CAM REC SETUP)

This setting is provided for the purpose of saving disk space. Setting allows each camera channel to be enrolled in all recording modes or exclusively in alarm recording.

CAM REC SETUP	
CAM	MODE
1	REC
2	REC
3	REC
4	ALM-ONLY
5	REC
6	ALM-ONLY
7	REC
8	REC

1. Move the cursor to CAM REC SETUP, and press the [SET] button. The CAM REC SETUP menu opens.
2. Move the cursor to the camera channel with the [▲] or [▼] button.

3. Select the parameter with the JogDial, and press the JogDial.

The default is REC.

REC: The channel is recorded in alarm recording, timer recording and manual recording mode.

ALM-ONLY: The channel is recorded only when the alarm operates.

4. Repeat steps 2 and 3 until all channels are set.
5. Press the [SETUP/ESC] button to return to the PROG1 SETUP, NO. 1 menu.

Manual Recording Setup (REC SETUP)

The WJ-HD220 will record image and audio data either with or without timer restrictions. Manual recording is available when OFF is selected for TIMER in WJ-HD220 MAIN MENU; the timer schedule does not apply. Alarm recording will also be carried out with parameters specified in this menu.

REC SETUP	
REC MODE	SF-24H
REC RATE	30FPS
REC QUALITY	SUPER FINE
ALM REC MODE	SF-24H
REC RATE	30FPS
REC QUALITY	SUPER FINE
PRE ALM REC	0S
POST ALM REC	10S
DYNAMIC REC	OFF
TRIGGER ACTION SETUP	↵
CAM REC SETUP	↵

Refer to ● Recording Mode Setup PROG1-4 SETUP, NO. 1-4 for operating procedures and available parameters.

Externally Specified Recording Mode (EXT REC SETUP)

This setting allows changing the recording mode from the ongoing one to an optional one specified here when turning on the switch connected externally to the EXT REC terminal.

1. Move the cursor to EXT REC MODE with the [▲] or [▼] button.
2. Select the desired mode with the JogDial, and press the JogDial.
Refer to page 26 for the recording mode parameters.
3. Press the [SETUP/ESC] button to return to WJ-HD220 MAIN MENU.

Display Setup (DISPLAY SETUP)

You can program the display of information on the monitor, such as clock, time and date, and so forth.

DISPLAY SETUP	
CLOCK→	JAN15.04 11:05
TIME&DATE DISP.	TYPE1 24H
TIME&DATE POSI.	R-LOWER
TIME&DATE EMB.	OFF
STATUS DISP.	ON
STATUS POSI.	R-LOWER
HDD FULL	1%
REMOTE LED	ON
HDD CHECK	0:00
CAMERA TITLE	↵

● Clock (CLOCK)

1. Press the JogDial (SET) to move the cursor to the desired position.
2. Rotate the JogDial clockwise to increase the parameter, or counter-clockwise to decrease. The positions indicate the year, month, day, hour, and minute respectively.

The default is "JAN 01. 04 0:00".
MMM DD. YY HH:MM

3. Press the JogDial (SET) to validate the selection.
4. Press the [▲] or [▼] button to select the next item, or press the [SETUP/ESC] button to quit the display setup.

● Time & Date (TIME&DATE DISP.)

1. Select a display type with the JogDial.
The default is TYPE1.

TYPE1 24H: Time and date are displayed in one line in the 24-hour system.

TYPE1 12H: Time and date are displayed in one line in the AM-PM system.

TYPE2 24H: Time and date are displayed in two lines in the 24-hour system.

TYPE2 12H: Time and date are displayed in two lines in the AM-PM system.

OFF: Does not display time and date.

JAN15.04 20:00:00
TYPE1

JAN15.04 20:00:00
TYPE2

2. Press the JogDial (SET) to validate the selection.
3. Press the [▲] or [▼] button to select the next item, or press the [SETUP/ESC] button to quit the display setup.

Notes:

- When a 9-split screen is displayed, only TYPE1 24H is available.
- If "TIME&DATE EMB." is set to ON and a display type except OFF is selected, the type will be embedded in the recorded data. If OFF is selected, TYPE1 24H will be embedded in the data.
- The embedded time and date are displayed, but the time and date display is hidden to avoid overlapping them when both are set to ON and a single playback is viewed.

● Time & Date Position (TIME&DATE POSI.)

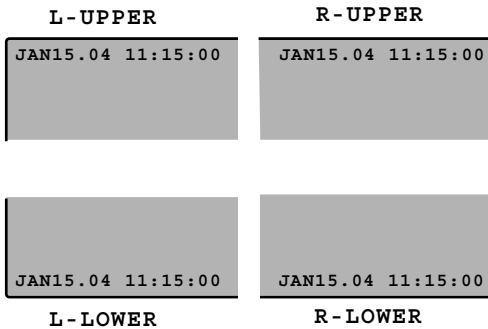

1. Select a display position with the JogDial.
The default is R-LOWER.
- R-LOWER:** Displays time & date in the lower right corner.
R-UPPER: Displays time & date in the upper right corner.
L-LOWER: Displays time & date in the lower left corner.
L-UPPER: Displays time & date in the upper left corner.

2. Press the JogDial (SET) to validate the selection.
3. Press the [▲] or [▼] button to select the next item, or press the [SETUP/ESC] button to quit the display setup.

Notes:

- When the 9-split screen is displayed, the time and date position is fixed to R-LOWER.
- The time and date display will be embedded in the recorded data in the position specified here, if TIME&DATE EMB. is set to ON.

● Time & Date Embedded (TIME&DATE EMB.)

You can select either recording with time and date display embedded or not. The display position and type in the recorded data depend on the setups described above.

1. Select ON or OFF with the JogDial.
The default is OFF.
- ON:** Time & date display is embedded.
OFF: Time & date display is not embedded.

2. Press the JogDial (SET) to validate the selection.
3. Press the [▲] or [▼] button to select the next item, or press the [SETUP/ESC] button to quit the display setup.

Notes:

- TYPE1 24H will be embedded in the recorded data if TIME&DATE DISP is set to OFF and TIME&DATE EMB. is set to ON.
- The embedded time and date are displayed, but the time and date display is hidden to avoid overlapping them when both are set to ON and a single playback is viewed.

● Status Display (STATUS DISP.)

1. Select ON or OFF with the JogDial.
The default is ON.
- ON:** Status display is enabled.
OFF: Status display is disabled.
2. Press the JogDial (SET) to validate the selection.
 3. Press the [▲] or [▼] button to select the next item, or press the [SETUP/ESC] button to quit the display setup.

● Status Position (STATUS POSI.)

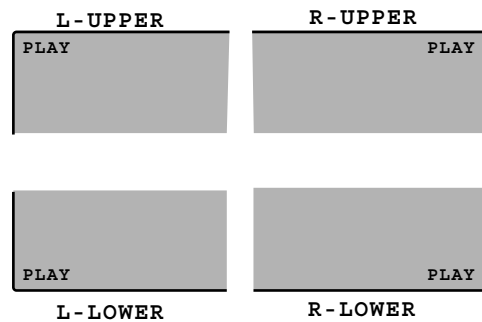

1. Select a display position with the JogDial.
The default is R-LOWER.

R-LOWER: Displays status in the lower right corner.

R-UPPER: Displays status in the upper right corner.

L-LOWER: Displays status in the lower left corner

L-UPPER: Displays status in the upper left corner.

2. Press the JogDial (SET) to validate the selection.
3. Press the [▲] or [▼] button to select the next item, or press the [SETUP/ESC] button to quit the display setup.

Note: When the 9-split screen is displayed, the status position is fixed to R-LOWER.

● Disk Capacity Warning (HDD FULL)

The recorder monitors the disk capacity to warn the operator that the available capacity is nearing its end when STOP is selected for DISK END MODE. There are two warning levels. First, the FULL indicator on the front panel blinks when the remaining capacity has reached the preset value. Finally, the buzzer beeps when the disk is full, provided that the DISK END BUZZER parameter in the SYSTEM SETUP is set to ON. At the same time, the FULL indicator turns on.

```
DISPLAY SETUP
CLOCK→ JAN15.04  11:05
TIME&DATE DISP.TYPE1 24H
TIME&DATE POSI.R-LOWER
TIME&DATE EMB. OFF
STATUS DISP. ON
STATUS POSI. R-LOWER
HDD FULL 1%
REMOTE LED ON
HDD CHECK 0:00
CAMERA TITLE"↓
```

1. Select the desired value with the JogDial.
The default is 1 %.
1% - 99%: The FULL indicator blinks when the remaining capacity reaches the selected value.
2. Press the JogDial (SET) to validate the selection.
3. Press the [▲] or [▼] button to select the next item, or press the [SETUP/ESC] button to quit the display setup.

● Remote LED (REMOTE LED)

The remote LED on the front panel will indicate or ignore the remote controlled status of the recorder via the network.

```
DISPLAY SETUP
CLOCK→ JAN15.04  11:05
TIME&DATE DISP.TYPE1 24H
TIME&DATE POSI.R-LOWER
TIME&DATE EMB. OFF
STATUS DISP. ON
STATUS POSI. R-LOWER
HDD FULL 1%
REMOTE LED ON
HDD CHECK 0:00
CAMERA TITLE"↓
```

1. Select either ON or OFF with the JogDial.
The default is OFF.
ON: REMOTE LED turns on when the network controls the recorder.
OFF: REMOTE LED is deactivated.
2. Press the JogDial (SET) to validate the selection.
3. Press the [▲] or [▼] button to select the next item, or press the [SETUP/ESC] button to quit the display setup.

● Disk Check (HDD CHECK)

S.M.A.R.T. (Self-Monitoring Analysis and Reporting Technology) is activated or deactivated for HDD check.

```
DISPLAY SETUP
CLOCK→ JAN15.04  11:05
TIME&DATE DISP.TYPE1 24H
TIME&DATE POSI.R-LOWER
TIME&DATE EMB. OFF
STATUS DISP. ON
STATUS POSI. R-LOWER
HDD FULL 1%
REMOTE LED ON
HDD CHECK 0:00
CAMERA TITLE"↓
```

1. Select either ON or OFF with the JogDial.
The default is OFF.
ON 0:00-23:00: The recorder checks the HDD at the specified time every day.
OFF: Check is deactivated.
2. Press the JogDial (SET) to validate the selection.
3. Press the [▲] or [▼] button to select the next item, or press the [SETUP/ESC] button to quit the display setup.

Note: Recording will resume after a one-second intermission when HDD is checked.

● Camera Title (CAMERA TITLE)

Camera title and display position are specified for each camera.

CAMERA TITLE		
CAM	TITLE	POSI.
1	OFF	
2	ON→ 2●●●●	R-LOWER
3	ON→ 3●●●●	L-LOWER
4	OFF	
5	OFF	
6	OFF	
7	OFF	
8	OFF	

- In the DISPLAY SETUP menu, move the cursor to CAMERA TITLE"↓, and press the JogDial to open the CAMERA TITLE menu.
- Move the cursor to the camera you wish to program using the [▲] or [▼] button.
- Select either ON or OFF with the JogDial.
The default is ON for all cameras.

ON: Enables camera title display, title registration, and position selection.

OFF: Disables the camera title functions.

- Press the JogDial (SET) to validate the selection.
When ON is selected, go to the following steps. The cursor moves to the title edit area.
When OFF is selected, return to step 2 above, or press the [SETUP/ESC] button to escape from the CAMERA TITLE menu.

5. <Editing>

- 5-1 Select a character for the digit with the JogDial.
Each title is identical to the camera number: 1, 2, 3, and so forth as the default.
Available characters are as follows.

0 ~ 9 A ~ Z ! % &
() * - / : . ?
← → ↑ ↓ •

- 5-2 Press the JogDial to validate the selection for the digit.
The selected character is displayed on the digit, and the cursor goes to the right digit.
- 5-3 Press the [▼] button to move the cursor back to the previous digit.
- 5-4 Repeat steps 5-1, 5-2 and 5-3 until all digits are entered.
- 5-5 Press the JogDial when the cursor is on the right end digit to validate the entered title. The cursor moves to the POSI. column.

Note: A bullet (centered dot) stands for a space used for deleting entered characters.

6. Select a display position with the JogDial.
The default setting for cameras 1, 2, 5, and 6 is R-LOWER, for cameras 3, 4, 7, and 8 R-UPPER.

R-LOWER: Displays the camera title in the lower right corner.

R-UPPER: Displays the camera title in the upper right corner.

L-LOWER: Displays the camera title in the lower left corner.

L-UPPER: Displays the camera title in the upper left corner.

Note: When the 9-split screen is displayed, the camera title position is fixed to R-LOWER.

7. Press the [▲] or [▼] button to select the next item, or press the [SETUP/ESC] button to quit the display setup.

■ System Setup (SYSTEM SETUP)

There are two pages of the system setup. To turn a new page, continue to move the cursor with the [▲] or [▼] button.

SYSTEM SETUP (1 OF 2)	
PASSWORD LOCK	OFF
ALL→	*****
OPERATION→	*****
KEYLOCK BUZZ	ON
SKIP ALM-RECALL	1PAGE
SIMUL REC&PLAY	ON
ALTER DETECT	OFF
DISK END MODE	CONTINUE
DISK END BUZZ	ON

SYSTEM SETUP (2 OF 2)	
PLAY PRIORITY	LOCAL
TIME ADJUST SETUP"↓	
AUTO ERASING	OFF
RESOLUTION→	NORMAL→
HDD SAFETY MODE	OFF

● Password Lock Setup (PASSWORD LOCK)

A five-digit password is entered to protect all settings, recorded pictures, and operating status against erroneous operation and tampering. Settings alone can be also protected from unauthorized access. While the LOCK indicator on the front panel is on, a message "NOW KEY LOCKED!" is displayed to warn unauthorized operators. If accessed in this condition, the buzzer beeps.

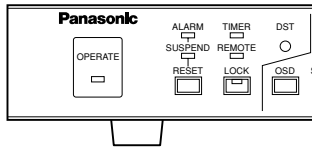

SYSTEM SETUP (1 OF 2)	
PASSWORD LOCK	OFF
ALL→	*****
OPERATION→	*****
KEYLOCK BUZZ	ON
SKIP ALM-RECALL	1PAGE
SIMUL REC&PLAY	ON
ALTER DETECT	OFF
DISK END MODE	CONTINUE
DISK END BUZZ	ON

1. Move the cursor to PASSWORD LOCK with the [▲] or [▼] button.

2. Select either ON or OFF with the JogDial, and press the JogDial.
The default is OFF.

ON: The buttons are password protected. The recorder enters the button lock mode if neither a button nor the JogDial is operated within a period of five minutes.

OFF: No password protection is applied.

3. Move the cursor to ALL→ or OPERATION→ with the [▲] or [▼] button.

ALL: Allows both normal operations and setup operations.

OPERATION: Allows only normal operations. Setup operations are not allowed.

4. Press the JogDial.
The preset password appears.
The default is "12345" for both ALL and OPERATION.

<New password setting>

5. Select a digit, rotating the JogDial.

6. Enter a number with the numeric button, and press the JogDial.
The cursor moves one digit to the right.

7. Repeat steps 5 and 6 until all digits are entered.

8. Press the [SETUP/ESC] button to confirm the entered password.
Go back to step 3 if you have not yet set the OPERATION password.

● Keylock Buzzer Setup (KEYLOCK BUZZ)

SYSTEM SETUP (1 OF 2)	
PASSWORD LOCK	OFF
ALL→	*****
OPERATION→	*****
KEYLOCK BUZZ	ON
SKIP ALM-RECALL	1PAGE
SIMUL REC&PLAY	ON
ALTER DETECT	OFF
DISK END MODE	CONTINUE
DISK END BUZZ	ON

1. Move the cursor to KEYLOCK BUZZ with the [▲] or [▼] button.

2. Select either ON or OFF with the JogDial, and press the JogDial.
The default is ON.

ON: Buzzer beeps when unauthorized access takes place.

OFF: Buzzer does not sound.

● Skip Alarm Recall Setup (SKIP ALARM RECALL)

Alarm log pages are recalled on the monitor when the JogDial is pressed for 2 seconds. When searching in the log, you may need to skip pages. The page will skip the specified number forward or backward from the displayed page when rotating the JogDial.

SYSTEM SETUP (1 OF 2)	
PASSWORD LOCK	OFF
ALL→	*****
OPERATION→	*****
KEYLOCK BUZZ	ON
SKIP ALM-RECALL	1PAGE
SIMUL REC&PLAY	ON
ALTER DETECT	OFF
DISK END MODE	CONTINUE
DISK END BUZZ	ON

1. Move the cursor to SKIP ALM RECALL with the [▲] or [▼] button, and press the JogDial.

2. Select the number of skip pages with the JogDial, and press the JogDial.
The default is 1 page.

Available skip pages: 1, 5, 10, 20, 50 pages

● Simultaneous Recording & Playback (SIMUL REC&PLAY)

This setting specifies whether to allow simultaneous playback and recording.

1. Move the cursor to SIMUL REC&PLAY with the [▲] or [▼] button.
2. Select on or off with the JogDial, and press the JogDial. The default is ON.

ON: Allows simultaneous recording and playback including remote-access playback and FTP access. The default recording rate is 15 FPS, and the highest rate is 30 FPS.

OFF: Places priority on recording triggered by pressing the REC button or by an alarm input. Playback including remote-access playback and FTP access will be interrupted if recording starts. The default recording rate is 15 FPS, and the highest rate is 30 FPS.

Notes:

- A 30 FPS recording rate will decrease to 15 FPS when playback, remote-access playback, or FTP access is carried out simultaneously with recording.
- Simultaneous playback will pause prior to a time space depending on the recording rate when the playback area on the disk nears the recording area. This is to avoid the access collision caused by the simultaneous recording and playback in an area on the disk.
 - 0.1 FPS: 20 minutes maximum
 - 1 FPS: 2 minutes maximum
 - 7.5 FPS: 15 seconds maximum
 - 15 FPS: 7 seconds maximum
- Even if preset to 30 or 15 FPS, the actual recording rate may drop to 7.5 FPS at worst while busy multi-tasks such as playback, remote-access playback, remote-access live image, FTP access, multi-split display, or video motion detection are carried out simultaneously. The status display will indicate "*→PLAY" while playing back the images recorded with a rate different from the preset.

● Alteration Detection Setup (ALTER DETECT)

You can enable or disable the recorder to add alteration-detection signals in the JPEG data supplied to the network. The default is OFF.

1. Move the cursor to ALTER DETECT.
2. Select ON or OFF with the JogDial and press the JogDial.

ON: Detects alterations.

OFF: Does not detect.

Notes:

- When set to ON, the data transmission rate on the network will slow down.
- Ask your dealer whether alterations are found in the image data distributed via the network if necessary.

● Disk End Mode Setup (DISK END MODE)

The menu offers the following options at the point where the available recording space on the disk is used up: [STOP], [CONTINUE]

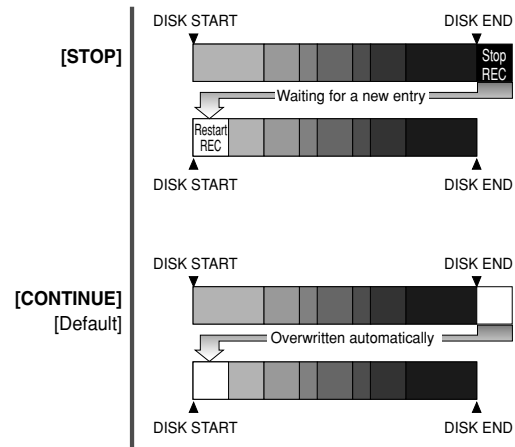

SYSTEM SETUP (1 OF 2)	
PASSWORD LOCK	OFF
ALL→	*****
OPERATION→	*****
KEYLOCK BUZZ	OFF
SKIP ALM-RECALL	1PAGE
SIMUL REC&PLAY	ON
ALTER DETECT	OFF
DISK END MODE	CONTINUE
DISK END BUZZ	ON

1. Move the cursor to DISK END MODE with the [▲] or [▼] button.
2. Select the desired mode with the JogDial, and press the JogDial. The default is CONTINUE.

STOP: Stops recording until a new mode other than STOP is selected.

CONTINUE: Old data is automatically overwritten from the disk start.

Note: Remaining capacity will be displayed on the monitor by turning the JogDial counter-clockwise in recording mode when STOP is selected.

● Disk End Buzzer (DISK END BUZZ)

The buzzer can be set up to beep at the point where the disk is full (remaining space 0 %). The setting is available only when STOP is set for DISK END MODE.

1. Move the cursor to DISK END BUZZ with the [▲] or [▼] button.
2. Rotate the JogDial to select the desired parameter. The default is ON.

ON: Enables the buzzer beep at the disk end (remaining space 0 %).

OFF: Disables the buzzer beep.

● Play Priority Setup (PLAY PRIORITY)

This setting places priority on a specific access point for playing back the image data when access collisions take place.

1. Move the cursor to PLAY PRIORITY.
2. Select an access point with the JogDial and press the JogDial.

LOCAL: Places priority on front panel operations.

NET PLAY: Places priority on network access.

FTP GET: Places priority on access to the FTP.

NONE: The latest operation has priority over others.

● Time Adjust Setup (TIME ADJUSTING)

IN and OUT terminals for a calibration signal are provided on the rear panel. The master unit supplies the calibration signal to the slave units once at the specified hour every day. The slave unit accepts the signal through the IN terminal, and corrects its internal timer to the hour as far as the clock deviates within 15 minutes after or before the hour. This is convenient for synchronizing the internal clock with other connected devices.

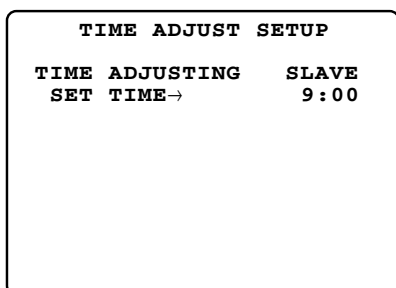

1. Move the cursor to TIME ADJUST SETUP"↓ in the SYSTEM SETUP with the [▲] or [▼] button, and press the JogDial. The TIME ADJUST SETUP menu appears.

2. Select either MASTER or SLAVE with the JogDial, and press the JogDial. The default is SLAVE.

MASTER: The recorder supplies the calibration OUT signal to the slave units.

SLAVE: The internal timer of the recorder is supplied the calibration signal from the master.

3. Select the hour with the JogDial, and press the JogDial.

The hours: From 00:00 to 23:00

Note: You need not set the hour when SLAVE is selected.

4. Press the [SETUP/ESC] button to go back to the SYSTEM SETUP menu.

● Auto Erasing Setup (AUTO ERASING)

The redundant records on the disk can be erased every day at 24:00 midnight. The number of days specified by this setting stand for the number of days the records will be protected from the present, while the records older than that will be erased.

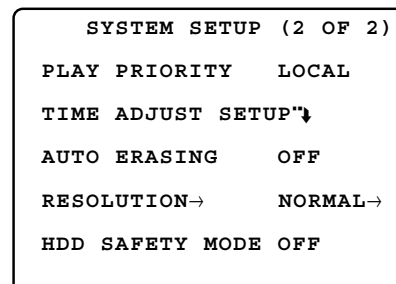

1. Move the cursor to AUTO ERASING with the [▲] or [▼] button.
2. Select the desired number of days with the JogDial, and press the JogDial.

OFF: Auto erasing is not applied.

1 DAY: Only today's records from 00:00 onward are protected. Records before 24:00 yesterday are erased.

2 to 10DAYS: Records before the specified number of days are erased.

14, 30, 45, 60, 90, 120, 150, 180DAYS: Same as above.

Notes:

- The number of days includes today as 1 day, therefore 2DAYS covers today and yesterday.
- Auto erasing is implemented at 24:00 midnight. Playback will stop once when the time reaches 24:00, then will restart with a different portion based on the renewed day count.

● Resolution (RESOLUTION)

Notes:

- We recommend that you perform this setup before starting to operate the system. Changing the resolution is an irrevocable procedure that results in the erasure of all data previously recorded.
- When a new resolution is selected, the screen MAIN MENU changes to a camera image. The recorder then reboots with the new resolution applied.

1. Move the cursor to RESOLUTION and press the JogDial.
2. A password prompt is displayed. Enter a registered password using CAM SEL buttons 1-8.

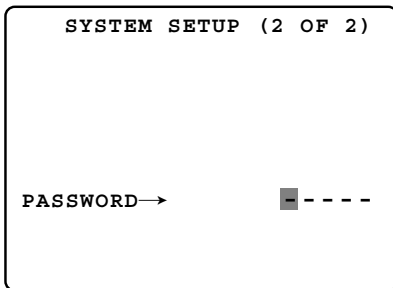

3. If the correct password is entered, the prompt screen returns to the previous menu and resolution selection becomes possible.
4. Rotate the JogDial to select a resolution and press the JogDial.
The default is NORMAL.

NORMAL: Normal resolution

SIF: Source Image Format (lower than NORMAL)

5. Confirmation prompt is displayed.

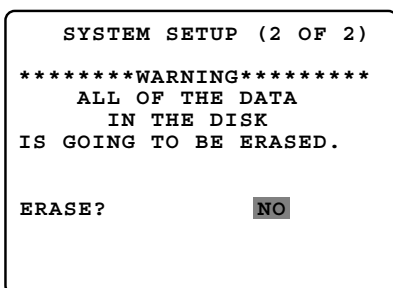

6. If you do not need to change the resolution, press the [SETUP/ESC] button. The menu will return to step 1 above.
7. If you intend to change it, rotate the JogDial to select YES and press the JogDial.

The recorded data will be erased while "NOW ERASING" is displayed for a few seconds.

● HDD Safety Mode (HDD SAFETY MODE)

A hard disk drive can be damaged if it is moved and shocked while its motor is revolving. This menu is provided for HDD protection purposes and enables you to stop the motors from starting even when the recorder is being powered. Use this when you cannot switch off the recorder and you have to mount or dismount the units.

1. Move the cursor to HDD SAFETY MODE.
2. Select ON or OFF with the JogDial and press the JogDial.
The default setting is OFF.

ON: Stops the HDD motors.

OFF: Keeps HDD motors revolving.

3. When you select ON, hold down the [SETUP/ESC] button for 2 seconds.
The recorder closes the setup menu and enters power-up procedures.
4. A message "DO NOT MOVE HDD" appears when power-up procedures are completed.
Wait for about 30 seconds while the green indicators in the numeric buttons 1-8 on the front panel turn on and off every 2 seconds.

```
*** HDD SAFETY MODE ***  
  
DO NOT MOVE HDD!  
  
WAIT UNTIL ALL  
HDD MOTORS STOP.  
  
-STILL IN PROCESS  
FOR STOP-
```

5. A message "ALL HDD MOTORS STOPPED" appears.
The indicators 1-8 light up in green for two seconds and in amber for two seconds. Now you can move the units.

```
*** HDD SAFETY MODE ***  
  
ALL HDD MOTORS STOPPED.  
NOW YOU CAN MOVE UNIT.  
  
SELECT OFF AND PUSH JOG  
TO RESTART.  
  
HDD SAFETY MODE ON
```

6. After you mount the units in the rack, move the cursor to ON. Select OFF with the JogDial and press the JogDial.

OFF: Escapes from the menu and restarts power-up procedures.

A message "SET DONE!" appears on the screen and the recorder enters normal operation when power-up procedures are completed.

Note: While HDD motors are stopped, the following inputs will be disabled.

- Input events for recording: button operation, VMD and lapse of preset record start time
- Inputs to ALARM/REMOTE port: alarm inputs
- Hour meter increment

■ Alarm Setup (ALARM SETUP)

The digital disk recorder accepts alarm signals supplied from connected devices such as sensors or camera site equipment. The recorder itself also generates an alarm signal when the preset motion detection is activated. Any alarm signal starts recording with the preset recording mode, field rate, and picture quality specified in the REC MODE menu described earlier. Alarm recording stops when the preset time has elapsed, the alarm [RESET] button on the front panel is pressed, or the ALARM RESET IN signal is supplied from the connected device. The recorder outputs an alarm recovery signal from the rear panel.

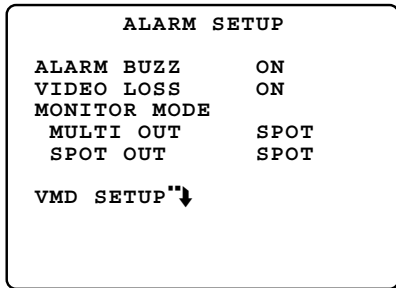

● Alarm Buzzer (ALARM BUZZ)

Enables or disables buzzer beeping when an alarm operates.

1. Move the cursor to ALARM BUZZ with the [▲] or [▼] button.
2. Rotate the JogDial to select ON or OFF.
The default is ON.

ON: Buzzer beeps while alarm is active.
OFF: Buzzer does not beep.

● Video Loss (VIDEO LOSS)

Enables or disables video loss detection.

1. Move the cursor to VIDEO LOSS with the [▲] or [▼] button.
2. Rotate the JogDial to select ON or OFF.
The default is ON.

ON: Enables the recorder to detect video loss.
OFF: Ignores video loss.

● Monitor Mode (MONITOR MODE)

This setting specifies whether to allow the display on the multiscreen monitor and spot monitor to change from the currently displayed picture to the alarmed channel when an alarm operates.

1. Move the cursor to MULTI OUT or SPOT OUT with the [▲] or [▼] button.
2. Select the parameter with the JogDial, and press the JogDial.
The default is SPOT.

SPOT: Switches to the picture of the alarmed channel.
OFF: Retains the previous display mode.

● Video Motion Detection (VMD SETUP)

A VMD or Video Motion Detector senses changes in the video signals within a preset area and supplies alarm output. When a change is detected, the recorder starts recording. The detection sensitivity and area are selected on this menu.

1. Move the cursor to VMD SETUP with the [▲] or [▼] button, and press the JogDial. The VMD SETUP window opens.

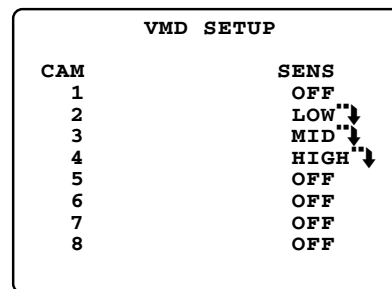

2. Move the cursor to the desired line.
3. Rotate the JogDial to select the desired parameter, and press the JogDial.
The default is OFF.

LOW: Low sensitivity
MID: Medium sensitivity
HIGH: High sensitivity
OFF: Motion detection is disabled.

The area setup window appears with an asterisk when other than OFF is selected. The asterisk represents the upper-left or bottom-right of the detection area. The division lines are not actually displayed on the monitor.

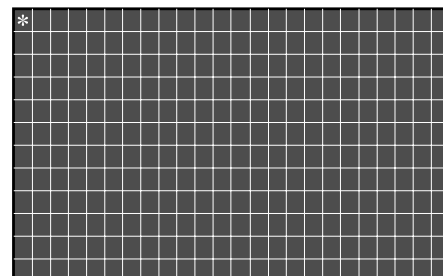

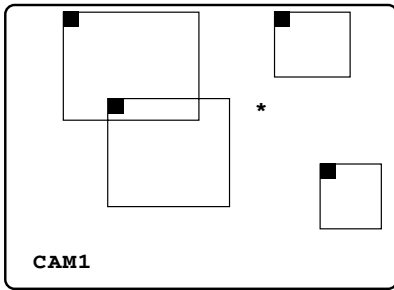

Notes:

- Areas adjacent to the time and date display will be excluded from VMD when TIME&DATE EMB is set to ON. Set it to OFF when you need to include these areas.
- VMD should be used when the input to the unit is from an ordinary camera. Select [OFF] to avoid useless VMD when a video multiplexer or combination camera supplies the input to the unit.
- Set ALARM SUSPEND to ON when you do not want VMD to be activated during the VMD setup.
- There may be cases where VMD does not sufficiently detect changes, since it detects the changes in luminance.
- The detection area may include areas slightly outside the border.
- The buzzer will beep if detection takes place during the area setup.

4. Set the upper-left end of the detection area. Move the asterisk to the right or left with the JogDial, and up or down by pressing the [▲] or [▼] button.

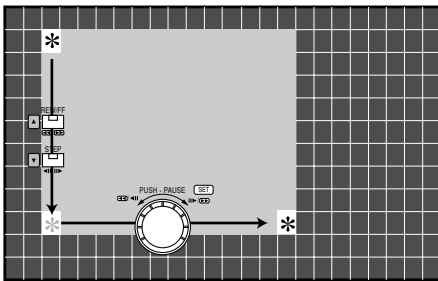

5. Press the JogDial to enter the upper-left end of the detection area. The asterisk position is highlighted.
6. Set the bottom-right end of the detection area similar to steps 3 and 4 above.
7. Press the JogDial. The area is highlighted. Up to 4 areas can be selected. These may partially overlap. Repeat steps 3 to 6 to select more areas. To deselect an area, move the cursor to the upper-left end of the area, and press the JogDial.

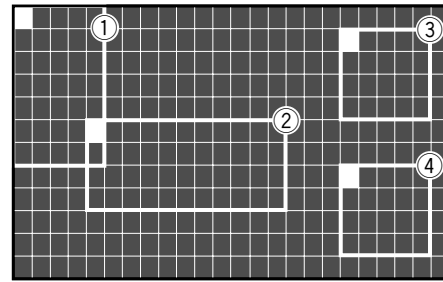

■ Communication Setup (COMMUNICATION SETUP)

Communication parameters are set to match those of the connected devices and the system configuration. The serial port setup and network setup are made.

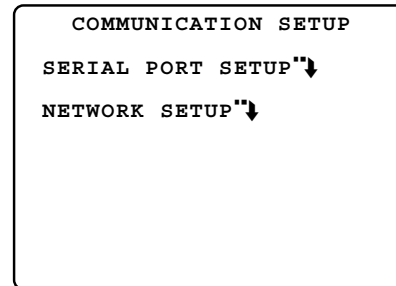

■ Serial Port Setup (SERIAL PORT SETUP)

The SERIAL PORT SETUP menu appears when it is selected in the COMMUNICATION SETUP menu.

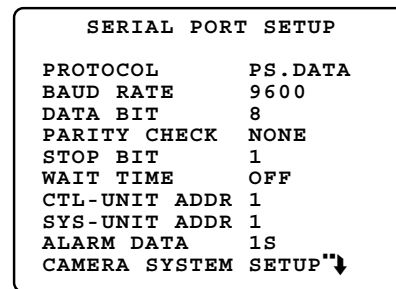

Note: Parameters marked with * on the following pages are default settings applicable to RS-232C.

● Protocol (PROTOCOL)

1. Move the cursor to PROTOCOL with the [▲] or [▼] button.
2. Select a suitable protocol with the JogDial, and press the JogDial. The default is PS·DATA.

PS·DATA: Select when the communication chain uses the PS·DATA protocol.

This selection enables the DATA terminal on the rear panel for communication.

RS-232C: Select when a protocol other than PS·DATA is used.

This selection enables the RS-232C terminal on the rear panel for communication.

Note: Parallel use of the DATA and RS-232C terminals is not possible.

● Baud Rate (BAUD RATE)

1. Move the cursor to BAUD RATE with the [▲] or [▼] button.
2. Select the rate with the JogDial, and press the JogDial.
The default value is 9600 bits per second.

4800: 4 800 bps

9600: 9 600 bps*

19200: 19 200 bps

● Data Bit (DATA BIT)

1. Move the cursor to DATA BIT with the [▲] or [▼] button.
2. Select the bit length with the JogDial.
The default value is 8 bits.

7: 7 bits* ; select when using RS-232C protocol.

8: 8 bits

● Parity Check (PARITY CHECK)

1. Move the cursor to PARITY CHECK with the [▲] or [▼] button.
2. Select the check mode with the JogDial.
The default is NONE.

NONE: No parity check

EVEN: Even parity

ODD: Odd parity*

● Stop Bit (STOP BIT)

1. Move the cursor to STOP BIT with the [▲] or [▼] button.
2. Select the number of stop bits with the JogDial.
The default is 1.

1: 1 bit*

2: 2 bits

● Wait Time (WAIT TIME)

The unit retransmits data after waiting the specified time if there is no response from the connected device.

1. Move the cursor to WAIT TIME with the [▲] or [▼] button.
2. Select the waiting time with the JogDial.
The default is OFF.

OFF: Retransmission is disabled. *

100MS: 100 m seconds

200MS: 200 m seconds

1S: 1 second

● Control Unit Address (CTL-UNIT ADDRESS) (only for PS·DATA)

When the recorder performs as a controller in the system, the unit address can be set from the setup menu on the monitor.

1. Move the cursor to CTL-UNIT ADDRESS with the [▲] or [▼] button.
2. Select the address with the JogDial.
The default value is 1.

Assignable address: From 1 to 99, must be unique in the chain.

Note: Assign an address except 1 to WJ-HD220 when using a system controller in the system.

● System Unit Address (SYS-UNIT ADDRESS) (exclusive to PS·DATA)

When the recorder performs as a system unit, the unit address can be set from the setup menu on the monitor.

1. Move the cursor to SYS-UNIT ADDRESS with the [▲] or [▼] button.
2. Select the address with the JogDial.
The default value is 1.

Assignable address: From 1 to 99, must be unique in the chain.

● Alarm Data (ALARM DATA) (exclusive to PS-DATA)

The recorder pauses before sending a notice to the connected system controller when an alarm operates.

1. Move the cursor to ALARM DATA with the [▲] or [▼] button.
2. Select the parameter with the JogDial, and press the JogDial.
The default is 1S.

OFF: Select this when no system controller is connected.

0S: Does not pause.

1S: Pauses 1 second.

5S: Pauses 5 seconds.

● Camera System Setup (CAMERA SYSTEM SETUP) (exclusive to PS-DATA)

This menu is provided for camera related setups such as camera numbers, cable loss compensation, and data communications. Cable loss compensation and data communication setups are not applicable to cameras 5-8, because only cameras connected to VIDEO IN 1-4 can communicate with the recorder via the coaxial cable.

CAMERA SYSTEM SETUP			
CAM	NUM	COMP	DATA
1 →	001	S	ON
2 →	002	S	ON
3 →	003	S	ON
4 →	004	S	ON
5 →	005		
6 →	006		
7 →	007		
8 →	008		

1. Move the cursor to CAMERA SYSTEM SETUP and press the JogDial.
2. Move the cursor to a camera and press the JogDial.
The cursor moves to the NUM (camera number) column.
3. Select a number by rotating the JogDial.
The default is the same as the camera port numbers 1-8.

Assignable numbers: 001-128

4. Press the JogDial. The cursor moves to the COMP (compensation) column.
5. Select an appropriate compensation parameter depending on the cable distance by rotating the JogDial. Selection is applicable to CAM 1-4 only.

The default is S (short distance). M stands for medium and L for long.

S: ≤ 500 m

M: 500 m – 900 m

L: 900 m – 1 200 m

6. Press the JogDial. The cursor moves to the DATA column.
7. Select ON or OFF with the JogDial and press the JogDial. Selection is applicable to CAM 1-4 only.
The default is ON.

ON: Enables data communications by use of PSD commands multiplexed on the coaxial cable.

OFF: Disables coaxial-multiplexed communications.

Note: Selecting OFF is recommended when cameras having no PSD communications are connected.

8. Repeat steps 2-7 above for other cameras.
9. Press the [SETUP/ESC] button to go back to the SERIAL PORT SETUP.

■ Network Setup (NETWORK SETUP)

NETWORK SETUP	
LINE SPEED	AUTO
HTTP PORT	→ 00080
DHCP	OFF
IP ADDR	→192.168.000.010
NETMASK	→255.255.255.000
GATEWAY	→192.168.000.001

Note: The system will restart after the menu setup window is closed when any parameter in this window has been changed.

● Line Speed (LINE SPEED)

1. Move the cursor to LINE SPEED with the [▲] or [▼] button.
2. Select the parameter with the JogDial, and press the JogDial.
The default is AUTO.

AUTO: The speed is automatically selected.

100M_FULL: 100 mega byte, full duplex

100M_HALF: 100 mega byte, half duplex

10M_FULL: 10 mega byte, full duplex

10M_HALF: 10 mega byte, half duplex

● HTTP Port (HTTP PORT)

Set an HTTP port number.
The default is 80.

Available port numbers: From 00000 to 65535, except the "well-known port" numbers assigned by IANA (Internet Assigned Numbers Authority)

● Dynamic Host Configuration Protocol (DHCP)

Dynamic Host Configuration Protocol is enabled or disabled.
The default is OFF.

Note: When ON is selected, you cannot enter the IP address, netmask, or gateway. The host gives these parameters.
The given parameters will be displayed after getting the IP address from the DHCP server.

● IP Address (IP ADDR)

The default is "192.168.000.010".

● Netmask (NETMASK)

The default is "255.255.255.000".

● Gateway (GATEWAY)

The default is "192.168.000.001".

■ Switcher Setup (SWITCHER SETUP)

```
SWITCHER SETUP
START DISPLAY
MULTI OUT      QUAD-4A
SPOT OUT       1CH
MULTI SEL MODE ALL
SEQUENCE SETUP"↓
CAMERA VIEW SETUP"↓
SECRET VIEW    OFF
```

Video switcher functions are programmed in this menu setup.

● Start Display (START DISPLAY)

The image in the selected form will be displayed on the multiscreen monitor and spot monitor when the recorder is turned on.

The default is QUAD-4A for MULTI OUT and 1 for SPOT OUT.

Single image: CH 1 to CH 8*

Quad image: QUAD-4A (including 1-4), QUAD-4B (including 5-8)

Multi image: 9SCREEN (including 1-8)

Sequence: SPOT SEQ*, MULTI SEQ

Note: The spot monitor can display only CH 1-8* and SPOT SEQ* while the multiscreen monitor can display all forms listed above.

● Multiscreen Selection (MULTI SEL MODE)

When pressing the [MULTI SCREEN SEL] button on the front panel, the monitor display will change as follows depending on the setup.

QUAD ONLY: QUAD-4A → QUAD-4B → QUAD-4A

ALL: QUAD-4A → QUAD-4B → 9SCREEN → QUAD-4A

● Sequence Setup (SEQUENCE SETUP)

```
SEQUENCE SETUP
MULTI SEQ SETUP"↓
SEQUENCE TIMING  INT
AUTO SKIP        ON

SPOT SEQ SETUP"↓
SEQUENCE TIMING  INT
AUTO SKIP        ON
```

1. Move the cursor to SEQ SETUP in the SWITCHER SETUP menu, and press the JogDial.
The SEQUENCE SETUP menu opens.
2. Select either MULTI SEQ SETUP or SPOT SEQ SETUP with the [▲] or [▼] button, and press the JogDial. The selected menu opens.

● Multiscreen Sequence Setup (MULTI SEQ SETUP)

Open the QUAD SEQ SETUP menu to program the sequence steps for displaying quad-split and single input images.

MULTI SEQ SETUP		
STEP	CAM	SEC
1 →	QUAD-4A	2S
2 →	QUAD-4B	2S
3 →	-	2S
4 →	-	2S
5 →	-	2S
6 →	-	2S
7 →	-	2S
8 →	-	2S

1. Move the cursor to the desired step using the [▲] or [▼] button.

2. Select a camera number with the JogDial, and press the JogDial.

The default camera number is identical to the step number.

Available cameras: From 1 to 8 individually, 4A(1-4), or 4B(5-8)

Note: The recorder will skip any step assigned "-".

3. Select the duration for the step with the JogDial, and press the JogDial.

Available durations: 2-30S

4. Repeat steps 1, 2, and 3 until all steps are programmed, or press the [SETUP/ESC] button to return to the SEQUENCE SETUP menu.

5. Move the cursor to SEQUENCE TIMING in the SEQ SETUP menu.

Select INT or EXT with the JogDial, and press the JogDial.

The default is INT.

INT: Forwards the step when the assigned time elapses.

EXT: Forwards the step when the SEQ IN signal is input to the rear panel.

6. Move the cursor to AUTO SKIP with the [▲] or [▼] button.

Select ON or OFF with the JogDial, and press the JogDial.

The default is ON.

ON: The sequence skips any step where no video is input.

OFF: The step will be displayed as a blackout screen.

● Spot Sequence Setup (SPOT SEQ SETUP)

Open the SPOT SEQ SETUP menu to program the sequence steps for displaying single input images.

SPOT SEQ SETUP		
STEP	CAM	SEC
1 →	1	2S
2 →	2	2S
3 →	3	2S
4 →	4	2S
5 →	5	2S
6 →	6	2S
7 →	7	2S
8 →	8	2S

1. Move the cursor to the desired step using the [▲] or [▼] button.

2. Select a camera number with the JogDial, and press the JogDial.

The default camera number is identical to the step number.

Available cameras: From 1 to 8.

Note: The recorder will skip any step assigned "-".

3. Select the duration for the step with the JogDial, and press the JogDial.

Available durations: 2-30S

4. Repeat steps 1, 2, and 3 until all steps are programmed, or press the [SETUP/ESC] button to return to the SEQUENCE SETUP menu.

5. Procedures for SEQUENCE TIMING are the same as step 5 in MULTI SEQ SETUP.

6. Procedures for AUTO SKIP are the same as in step 6 of MULTI SEQ SETUP.

● Camera View Setup (CAMERA VIEW SETUP)

Open the CAMERA VIEW SETUP menu to program the live image of each camera channel to be displayed or vailed on the monitor.

CAMERA VIEW SETUP	
CAM	MODE
1	ON
2	ON
3	ON
4	ON
5	OFF
6	OFF
7	OFF
8	OFF

1. Move the cursor to the desired camera using the [▲] or [▼] button.
2. Select ON or OFF with the JogDial, and press the JogDial.
The default is ON.

ON: Live image of the channel is displayed.

OFF: Blackout image is displayed.

3. Repeat steps 1 and 2 until all channels are programmed, or press the [SETUP/ESC] button to return to the SWITCHER SETUP menu,

Notes:

- Recording will be carried out regardless of this setting.
- The recorded images of the channel will be played back and displayed on the monitor even if OFF is selected.

● Secret View Setup (SECRET VIEW SETUP)

This will help to watch shoplifters without being recognized in a store where, for example, cameras and spot monitors are installed on the sales floors and a multiscreen monitor is installed in a control room. The spot monitor will black out its screen when the multi-screen monitor is switched to the single live mode to focus on the potential shoplifter. The default setting is OFF.

ON: Enables the secret view function.

OFF: Disables the secret view function.

■ System Information (SYSTEM INFORMATION)

SYSTEM INFORMATION			
HDD1	HOUR	METER	10000H
HDD2	HOUR	METER	10000H
HDD	CAPACITY		XXX.XXG
	DEFAULT→		SET→
SYSTEM	VERSION		X.XX
SYSTEM	LOG"		↓

● HDD Hour Meter (HDD HOUR METER)

The meter shows how many hours each hard disk has been operated in playback, recording and idle. The built-in HDD needs replacement when the hour meter reads around 30 000 H.

● HDD Capacity (HDD CAPACITY)

The total usable capacity of the built-in hard disk is indicated.

● Default (DEFAULT)

This enables the recorder to restore all setup data to the default values.

1. Press the JogDial to move the cursor to DEFAULT.
2. When the cursor is on SET→, press the JogDial again.
3. Select YES or NO with the JogDial, and press the JogDial.
The default is NO.

NO: Current setup data is retained.

YES: Current setup data is reset to the default values.

When all setup data are reset to the defaults, "SET DONE" is displayed for a few seconds and then changes to SET→.

Note: The recorder will restart when the network setup has been changed and the menu is closed.

● System Version (SYSTEM VERSION)

This line displays the version number of the installed system software. You will need the version number when updating the software.

● System Log (SYSTEM LOG)

The system log is displayed on the monitor with event numbers, dates, times, and causes.

SYSTEM LOG (1 OF 10)			
NO.	DATE	TIME	CAU
99	FEB28.04	6:50:06	WR1
98	FEB28.04	5:23:51	HD1
97	FEB20.04	10:10:23	HD2
96	FEB15.04	23:50:42	RV1
95	FEB11.04	23:52:10	FLL
94	JAN31.04	19:43:32	TML
93	JAN30.04	19:50:14	LS1
92	JAN15.04	19:52:54	FL%
91	JAN10.04	10:40:22	TM4
90	JAN01.04	10:50:20	LS1

Abbreviation	Cause	Description
TML	Thermal error	Temperature exceeds the operating range.
WR1	Writing error	Writing error on HDD
WR2		
RV1	HDD automatically removed	Master HDD
RV2		Slave HDD
HD1	S.M.A.R.T detects an error on HDD.	Master HDD
HD2		Slave HDD
FL%	HDD XX%	Warning, HDD is nearing to the end.
FLL	HDD FULL	HDD is FULL.
TM*	ALM	Terminal alarm event was logged, but no picture recorded. * = 1-8
VM*	VMD	VMD event was logged, but no picture recorded. * = 1-8
LS*	LOSS	Video input loss on channel # (*). * = 1-8
PC*	PC	PC alarm was logged, but no picture recorded. * = 1-8
POW	Power	Power disconnection due to electricity failure/trouble has been detected.
ERR	Error	Errors other than shown above

■ Language (LANGUAGE)

Language selection is available for display on the multi-screen monitor and for HTML on the browser.

1. Move the cursor to LANGUAGE.
2. Select a language with the JogDial and press the JogDial.
The default is ENGLISH.

Available languages: ENGLISH, FRENCH, GERMAN, ITALIAN, SPANISH, RUSSIAN, CHINESE

Notes:

- When Russian or Chinese is selected, HTML will display in the selected language, but the multiscreen monitor will display in English. See the table below.
- The recorder will exit from the setup menu and automatically start rebooting after you change the language.

Options	Multiscreen Display	HTML Display
ENGLISH	English	English
FRANCAIS	French	French
DEUTSCH	German	German
ITALIANO	Italian	Italian
ESPAÑOL	Spanish	Spanish
RUSSIAN	English	Russian
CHINESE	English	Chinese

OPERATING PROCEDURES

Controlling Video Inputs & Monitors

Operations on the front panel can control video inputs on the spot monitor or multiscreen monitor.

■ On the Spot Monitor

● Selecting the Spot Monitor

1. Press the [SPOT/MULTI] button to turn the LED in the button on. The spot monitor is ready to be operated.

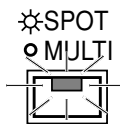

2. Follow the descriptions below for each monitoring mode on the spot monitor.

● Viewing a Single Live

A selected live image is displayed on the spot monitor until a new input selection is made.

1. Press any numeric button from 1 - 8.

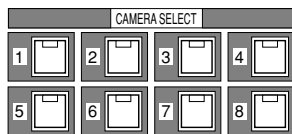

The selected image appears on the monitor.

2. Press another numeric button to select a new input.

● Viewing a Single Live Sequence

The spot monitor can display a single live sequence. A series of input images is displayed in succession on the spot monitor. One sequence can be programmed in the SPOT SEQ SETUP menu setup with an input assignment and display duration for each step.

1. Select the spot monitor.
2. Press the [SEQUENCE] button to run the sequence. The LED in the [SEQUENCE] button lights up.

Spot monitor

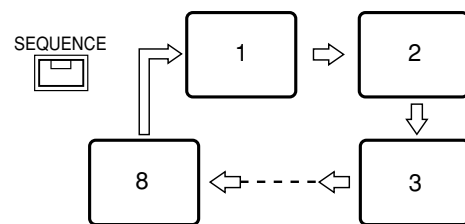

While running, the LED of the input image presently displayed on the monitor will illuminate in the corresponding numeric button.

3. During the sequence, press the [SEQUENCE] button to pause. The LED in the [SEQUENCE] button blinks.

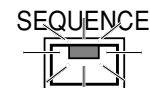

4. Press the [SEQUENCE] button to restart the sequence. The LED turns to a steady light.
5. Press any of the numeric buttons to quit the sequence and return to spot monitoring.

Notes:

- The Auto Skip function can be programmed in the menu setup to be applied to the sequence to skip any steps where no video signal is present.
- You can individually run a sequence on the spot monitor and on the multiscreen monitor. Select a monitor with the [SPOT/MULTI] button, then press the SEQ button to start or pause a sequence on the respective monitor.

■ On the Multiscreen Monitor

● Selecting the Multiscreen Monitor

1. Press the [SPOT/MULTI] button to turn the LED in the button off. The multiscreen monitor is ready to be operated.



2. Follow the descriptions below for each monitoring mode on the multiscreen monitor.

● Viewing a Single Live

The multiscreen monitor can display a single live spot image.

Operating procedures are the same as for "On the Spot Monitor" except for selecting the multiscreen monitor.

● Zooming a Single Live

A single live or playback image on the multiscreen monitor can be zoomed.

1. Display the desired single live or playback image on the multiscreen monitor pressing the [ZOOM] button an appropriate number of times.

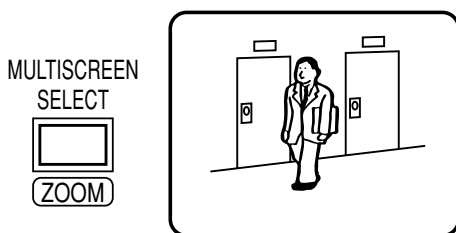

2. Hold down the [ZOOM] button for 2 seconds to enlarge the image.

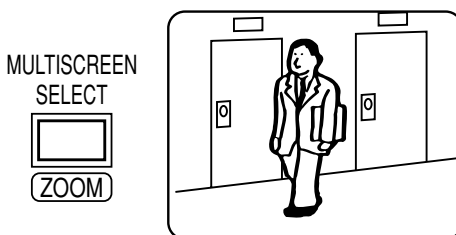

3. Rotate the JogDial to move the zoomed area to the right and left, or press the [▲] or [▼] button to move the area up or down.

4. Press the JogDial repeatedly to select an appropriate enlargement ratio.

Pressing the JogDial : Increases the ratio (x2 → x4)

5. Hold down the [ZOOM] button for 2 seconds to cancel the zoom mode.

Notes:

- The maximum zooming ratio (x4) will be reduced to x2 when SIF is selected for RESOLUTION in the SYSTEM SETUP menu.
- To quit enlargement
 - While displaying a zoomed live image, pressing the [PLAY] button will quit enlargement and start normal playback.
 - While displaying a zoomed playback image, pressing the [STOP] button will quit enlargement and display a live image.
 - For other cases, hold down the [ZOOM] button for 2 seconds.
- The images on the screen may wave vertically when enlarging live or playback images in the SIF mode. It is recommended that you select NORMAL for RESOLUTION when the display quality is considered much important.

● Viewing a Quad Live Sequence

A series of quad and single images is displayed in succession on the multiscreen monitor. One sequence can be programmed in the MULTI SEQ SETUP menu with an input assignment and display duration for each step.

1. Select the multiscreen monitor.
2. Press the [SEQUENCE] button to run the sequence. The LED in the [SEQUENCE] button lights up.

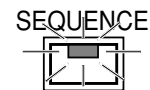

Note: During the sequence, the LEDs of the [CAMERA SELECT] buttons light up corresponding to the selected cameras that send images to the monitor.

Multiscreen monitor

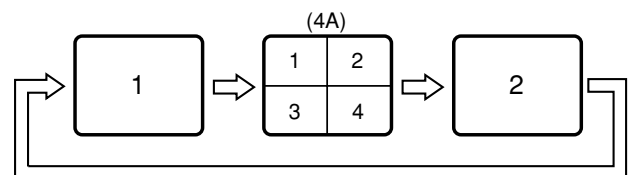

3. During the sequence, press the [SEQUENCE] button to pause. The LED in the [SEQUENCE] button blinks.
4. Press the [SEQUENCE] button to restart the sequence. The LED turns to a steady light.

- Press any of the numeric buttons to quit the sequence and return to spot monitoring.

Notes:

- The Auto Skip function can be programmed in the menu setup to be applied to the sequence to skip any steps where no video signal is present.
- You can individually run a sequence on the spot monitor and on the multiscreen monitor. Select a monitor with the [SPOT/MULTI] button, then press the SEQ button to start or pause a sequence on the respective monitor.

● Viewing a Multiscreen Live

The multiscreen monitor can display multiscreen live images. The available split patterns are: Quad A (input 1, 2, 3, 4), Quad B (input 5, 6, 7, 8), and 9-split (input 1-8).

- Press the [MULTI SCREEN SELECT] button repeatedly. The pattern changes every time the button is pressed depending on the setup for MULTI SEQ SETUP. When ALL is selected: Pattern 4A → Pattern 4B → Pattern 9 → Pattern 4A

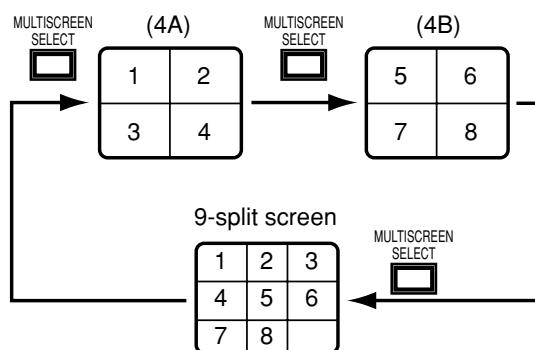

When QUAD ONLY is selected:
Pattern 4A → Pattern 4B → Pattern 4A

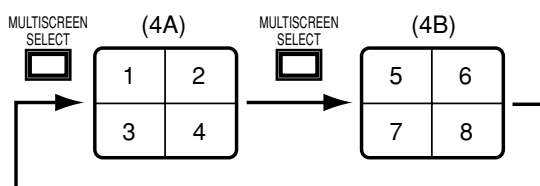

Alarm Control Function

The recorder performs alarm functions to warn the system operators when an event has occurred.

■ Alarm Input

There are four alarm inputs to the recorder that allow the recorder to output warnings.

● Connected Alarm Sensors

A maximum of eight sensors can be connected to the terminals on the rear panel. Sensors may be installed in such places as parking lots or reception desks where cars and visitors come and go.

● Built-in Motion Detector

The recorder detects motion for each of the eight video inputs, based on certain changes in the video signal.

● Built-in Video Loss Detector

The recorder detects any disconnection of the video inputs. The images of the disconnected channel will not be recorded.

● PC Alarm

The recorder receives an alarm from a PC.

■ Alarm Output

The following outputs will be performed when TRIGGER ACTION SETUP is set to REC&ALM in the REC SETUP menu. Only recording will be performed when set to REC, and no action will take place when set to OFF.

● Front Panel Indicators

When an alarm is received, the ALARM indicator blinks and the LED in the corresponding [CAMERA SELECT] button blinks. More LEDs will blink when more alarm inputs arise. The LED will stop blinking when the preset time has elapsed (Auto Reset), when the [RESET] button is pressed on the front panel (Manual Reset), when the external reset signal is received on the rear panel (External Reset), or when the video signal lost on any channel is restored (Video Loss). The ALARM indicator will change from blinking to a steady light when Auto Reset or External Reset is implemented. This steady light notifies the system operator that there have been alarm activations that have not yet been manually reset.

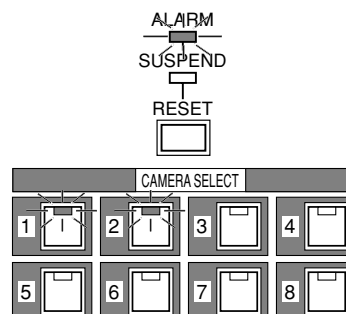

● Monitor Display

There are two monitoring modes, alarm associated (SPOT) mode and alarm ignore (OFF) mode, depending on the selection for MONITOR MODE in the ALARM SETUP menu. Typical cases are described below for each setup.

Alarm Associated Mode

- The image of the alarmed input is displayed on the multiscree monitor in single spot mode, interrupting whatever live, playback, single or multiple image previously displayed. When a new alarm is received, the last activated input image will be displayed.
- The blinking camera title and "ALARM" indication on the monitor will be alternately. For example, when an alarm is received from CH1, "CH1 ALARM" will be displayed on the monitor.

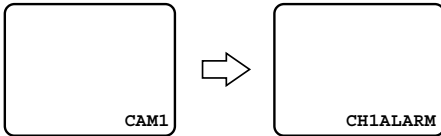

- Combination cameras connected to VIDEO IN 1-4 can be aimed at the preset position if is specified for PRESET in the TRIGGER ACTION SETUP of the REC SETUP menu.
- When a camera signal loss has occurred, the monitor display switches to a blackout screen with the channel number indicated, for example, "CH 1 LOSS".

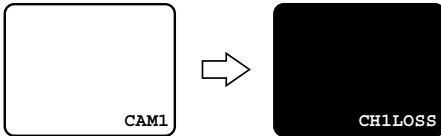

Alarm Ignore Mode

- The images being displayed will remain on the monitor screen when an alarm arises, but the "ALARM" status indication will appear.

The following outputs for each channel will be enabled or disabled depending on the settings made in the TRIGGER ACTION SETUP menu.

- The following will be disabled when OFF is selected for the channel.
- The following will be enabled when REC&ALM is selected for the channel.
- Only alarm recording will be enabled when REC is selected for the channel.

● Alarm Recording

The recorder starts alarm recording with the preset rate and picture quality, if applicable. See ALARM RECORDING for details.

● Alarm Buzzer

The buzzer sounds when an alarm is input, if applicable.

● Alarm Log Recall and Search

The alarm events are stored in the log for later reference.

● Alarm Status Output

The active status and recovery status are output to the external devices via the terminals on the rear panel.

● Alarm Notice Mail

When connected to the Ethernet, the recorder sends an e-mail to notify the preset URL that the alarm is activated.

● Resetting Alarm

See below.

● Suspending Alarm

See below.

■ Resetting Alarm

The activated alarm is reset by any of the inputs: manual (all) reset, auto reset, external reset, or pressing the [REC STOP] button.

Resetting changes the status of the recorder as follows.

- The recorder stops alarm recording.
- The buzzer, if activated, stops beeping.
- The recorder outputs an alarm recovery signal from the rear panel.
- The Alarm Out signal on the rear panel is reset.

● Manual (All) Reset

Pressing the [RESET] button on the front panel will clear all operating alarms, and allow the blinking or lit ALARM indicator to go off.

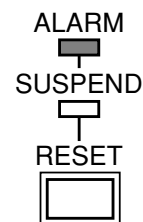

● Auto Reset

The activated alarm event is reset when the AUTO RESET time has elapsed, or the lost video has been recovered. The ALARM indicator changes from blinking to a steady light.

● External Reset

The activated alarm event except video motion detection, is reset when the recorder receives an external reset signal from the connected device via the REMOTE/ALARM connector on the rear panel.

The ALARM indicator changes from blinking to a steady light.

● Pressing REC STOP Button

Pressing the [REC STOP] button resets alarm status and recording when MONITOR MODE is set to OFF. When SPOT is set, only the [ALARM RESET] button will reset alarm status and recording.



■ Suspending Alarm Input

This function may be convenient during setup procedures. When enabled, any alarm input is ignored and the recorder performs as follows.

- The alarm event will be stored in the alarm log.
- The recorder enters alarm recording.
- The alarm buzzer does not sound.
- The SUSPEND indicator lights up.

1. Hold down the alarm [RESET] button and [LOCK] button simultaneously to enable the suspension function. The SUSPEND indicator lights up.

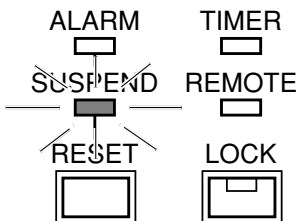

2. Do the same as above to reset the suspension function. The indicator turns off.

■ Alarm Log Recall & Search

The ALARM RECALL window displays the alarm event log in chronological order with event numbers, dates, times, and the activation sources. A maximum of 9 999 events can be stored, and older records will be erased when more events arise.

ALARM NO.	RECALL DATE	YEAR03 TIME	ALM
1543	OCT30	23:58:12	T1
1542	OCT30	23:52:54	V2
1541	OCT30	23:40:29	V3
1540	OCT30	23:39:50	T4
1539	OCT30	23:35:41	P2
1538	OCT30	23:30:22	P1
1537	OCT30	23:25:55	T2
1536	OCT30	23:21:09	T2
(TOTAL 1543EVENTS)			
TO SEARCH PUSH T&D KEY			

ALARM NO.	RECALL DATE	YEAR03 TIME	ALM
0003	OCT20	23:52:54	V2
0002	OCT20	23:51:54	V2
0001	OCT20	23:50:54	V2
PUSH JOG→DATA CLEAR			
(TOTAL 1543EVENTS)			
TO SEARCH PUSH T&D KEY			

T: Alarm terminal was activated.

V: VMD was activated.

P: Alarm event notification from the PC.

Note: In some cases the log displayed in the ALARM RECALL list may apply to the previous alarm record that was overwritten after selecting CONTINUE for the DISK END MODE. This is because the alarm log is updated later than the image data.

● To Browse through Log

1. Hold down the JogDial for 2 seconds. The monitor displays the ALARM RECALL list.
2. Rotate the JogDial to scroll up or down the page. Scrolling speed is selected in the menu setup.
3. Hold down the JogDial for 2 seconds to quit the ALARM RECALL list and go back to the previous window.

● To Sort by Channel

1. Hold down the JogDial for 2 seconds to display the ALARM RECALL list. The log of all channels appears.
2. Press the desired channel [CAM SEL] button. The indicator on the button lights up, and only the log of the selected channel will be displayed.
3. Press another channel button to select a new channel.

- To return to the all-channel list, press the button of the selected channel (now lit) or the [MULTISCREEN SELECT] button.

● To Search for Playback

- Move the cursor to the desired event in the list, using the [▲] or [▼] button.
- Press the [PLAY] button to play back the recorded picture. The LED in the [PLAY] button lights up. The alarm log on the monitor disappears.
- Press the [STOP] button to stop playback. The alarm log appears again on the monitor.
- Hold down the JogDial for 2 seconds to quit the alarm log search.

● To Erase Log

All event records can be erased.

- Move the cursor to "PUSH → DATA CLEAR", then press the JogDial.
- Rotate the JogDial to select YES or NO.

YES: Enables the log erasure.

NO: Disables the log erasure.

- Press the JogDial to carry out the selection.

Note: You can access pictures recorded on the disk by time & date search even after they have been erased.

Recording

Notes:

- When SIMUL REC&PLAY (simultaneous recording and playback) is set to OFF in the setup, any recording will stop playback and start the recording. Playback is unavailable while recording.
- When set to ON, recording is available while playing back.
- The recording rate will degrade to 15 FPS while displaying a quad split screen.

■ Internal Timer Recording

When INT is set for TIMER in the WJ-HD220 MAIN menu, the presets made in the internal timer will take effect. Internal timer recording begins when the preset start time comes and continues until the preset end time comes. Up to four programs, containing four events each, can be assigned to the weekly and/or daily schedule.

PROG1 SETUP			
NO.	START	END	MODE
1→	8:00	12:20	SET"↓
2→	13:00	15:00	SET"↓
3→	—:—	—:—	—
4→	—:—	—:—	—

Notes:

- When SIMUL REC&PLAY is set to OFF, a preset recording interrupts playback and starts at the preset start time.
- When you set both the start and end time of an event to the same hour, the event will not be recorded.
- When planning to record all day long, set the start time to 00:00 and the end time to 24:00 for the final event.
- When planning to record through midnight:
Set 24:00 for the end time of the final event of the day.
Set 00:00 for the start time of the initial event of the next day.

Power-on Recording

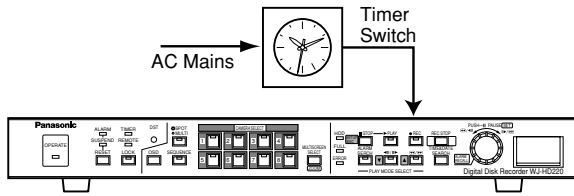

For power-on recording, select EXT for TIMER in the WJ-HD220 MAIN menu. The recorder starts recording when AC power is supplied.

This enables the disk recorder to start recording everyday at a specific time by the use of a timer switcher that controls the AC mains supplied to the recorder. The power switch on the rear of the recorder must be turned on in this case.

Manual Recording

Manual recording is available when OFF is set for TIMER in the WJ-HD220 MAIN menu. The menu setup can exempt specific inputs from manual recording for the purpose of preserving disk capacity. The recording mode (SF-24, for example), picture quality (fine) and recording rate (30 fps) are set in the menu setup by specifying two of the three parameters. SF-24H is an example having a picture quality of especially fine grade and 48 hours of recording capacity.

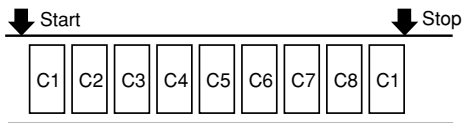

1. Press the [REC] button on the front panel to start recording. The indicator in the [REC] button lights up while the [CAM SEL] button of the channel indicates and the channel image is displayed on the multiscreen monitor.

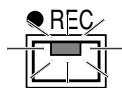

Orange: The channel image is not displayed.

Yellow: The channel image is displayed.

The multiscreen monitor displays the recording images while the corresponding input indicators on the front panel light in yellow.

2. Hold down the [REC STOP] button for 2 seconds to stop recording. The REC indicator turns off.

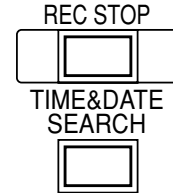

Alarm Recording

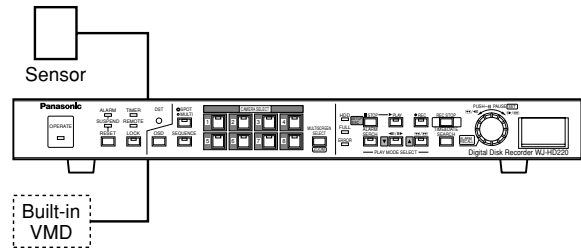

Alarm recording starts when an externally connected sensor is turned on, the built-in VMD (Video Motion Detector) or the built-in video loss detection is activated.

Alarm recording will proceed, then stop when the post-recording time has elapsed.

If more than one alarm arise, for instance ALM1 and ALM2, the images of the alarmed inputs are recorded on the disk as shown in the figure.

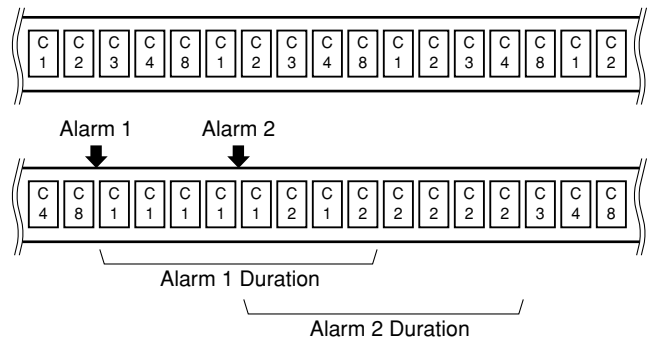

Note: HDD indicator will continue to blink for a period equivalent to the specified pre-alarm time at the end of alarm recording.

Playback

In playback modes, the recorded image data are played back.

Notes:

- Alarm recording will interrupt playback if SIMUL REC&PLAY is set to OFF, or will allow playback to continue if set to ON.
- Operation of the [PLAY] button will be ignored if the disk is empty, for instance, when the recorder is used for the very first time or right after formatting of the disk.
- The latest recorded image is displayed on the monitor right after recording finishes. Search for the desired image by skip playback before starting playback.

Normal Playback

The pictures recorded on the disk are played back sequentially.

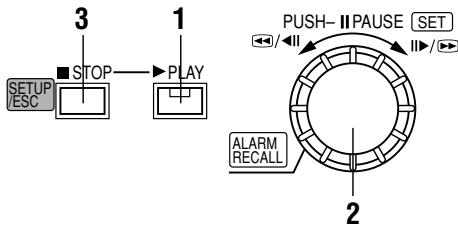

1. Press the [PLAY] button to start playback.
2. Press the JogDial [PUSH-PAUSE] to pause and restart playback.
3. Press the [STOP] button to stop playback.

Skip Playback

Picture search is available in quick forward and backward playback. The monitor displays the skip speed as 1/2PLAY, PLAY, 2PLAY, 1FF, 2FF, 3FF, and so forth. The asterisk indicates that images are played back continuously without skipping.

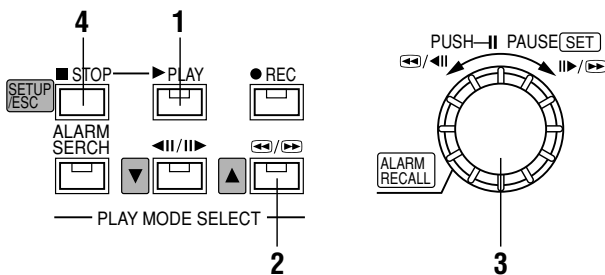

1. Press the [PLAY] button to start playback.
2. Press the [REW/FF] button to start skip playback. The LED in the button lights up.

3. Rotate the JogDial clockwise to move forward in the recorded data or counter-clockwise to move backward. The more turns you rotate the JogDial, the faster the skip speed will be.

4. Press the [STOP] button to stop playback.

Step Playback

A minute search is made for a desired picture field by field.

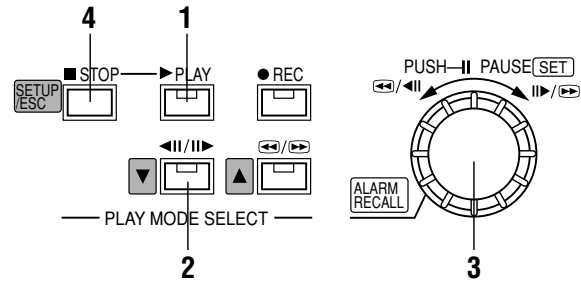

1. Press the [PLAY] button to start playback.
2. Press the [STEP] button to start step playback. The LED in the button blinks.
3. Rotate the JogDial clockwise to advance to the next later field or counter-clockwise to rewind to the next older.
4. Press the [STOP] button to stop playback.

Alarm Search Playback

Alarm records on the disk are searched while viewing the beginning image of the record.

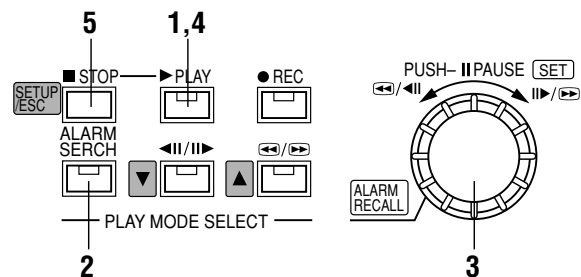

1. Press the [PLAY] button to start playback.
2. Press the [ALARM SEARCH] button to start alarm search playback. The LED in the button lights up.
3. Rotate the JogDial one click clockwise or counter-clockwise. The display advances to the beginning of the next later or next older record. Repeat until the desired record is displayed.

4. Press the [PLAY] button to play back the searched record.

5. Press the [STOP] button to stop playback.

Note: "Alarm Search Playback" and "Alarm Log Recall" are similar, but different in operations. Refer to ■ Alarm Log Recall & Search on page 49.

■ Time & Date Search Playback

A picture record of a specified time and date is played back.

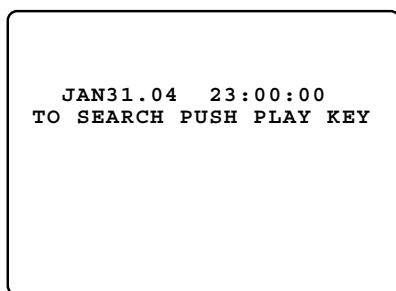
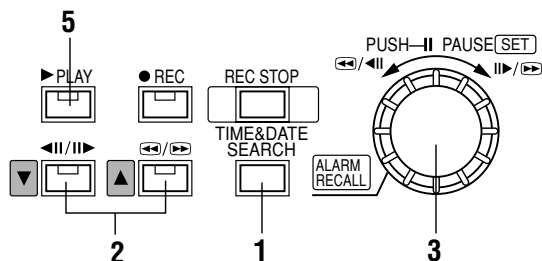

1. Press the [TIME&DATE SEARCH] button. The monitor displays the time & date search window.
2. Press the [▲] or [▼] button to move the cursor to the next position.
3. Rotate the JogDial clockwise to increase the parameter or counter-clockwise to decrease it.
4. Repeat steps 2 and 3 above until the desired parameters are selected.
5. Press the [PLAY] button to start playback. The monitor displays the single spot image when an input is selected or the nine-split image when all input is specified. The recorder stops searching when the playback reaches the end of the record.

6. Repeat from step 1 to search for another time and date or press the [TIME&DATE SEARCH] button to cancel the function. Pressing the [STOP] button will also end the searching.

Note: Searching may take the recorder 18 seconds at worst

■ Multiscreen Playback

You can view a multiple playback image displayed in 4-split or 9-split pattern on the monitor at a time.

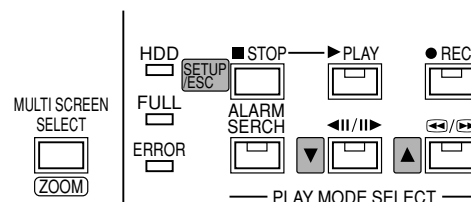

- Normal Playback
Press the [PLAY] button to start normal playback. The image data recorded on the disk are sequentially played back, and the monitor displays images in the single display mode or multiscreen display mode.
- Multiscreen Playback
Press the [MULTI SCREEN SELECT] button an appropriate number of times. The monitor display changes as follows. The LEDs in the [MULTI SCREEN SELECT] button and respective input buttons will light up.

Single Image → Quad A (4A/comprising inputs 1, 2, 3, and 4) → Quad B (4B/inputs 5, 6, 7, and 8) → Nine-split (inputs 1 - 8) → Quad A → Quad B → Nine-split
- Specific Input Playback
Press the respective input button. The images of the selected input are played back continuously and displayed on the monitor.
- Stop Playback
Press the [STOP] button to stop playback.
Note: When the playback proceeds to where recording is executed on the disk, the recorder will pause playback and freeze the displayed image on the monitor.

Lock/Unlock Buttons

■ Password Verification

When a locked button is pressed, the key locked warning appears on the monitor for 2 seconds, then it changes to the password prompt.

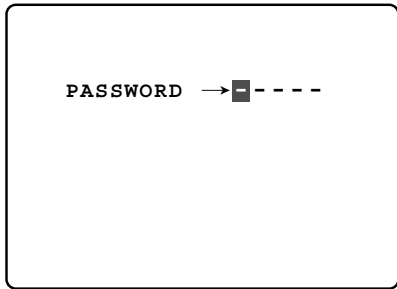

1. Enter your five-digit password using the [CAM SELECT] buttons (1-8). The buzzer shortly beeps once, and the entered digit changes from "-" to "*" on the monitor.
2. The prompt window will display "KEY UNLOCKED!" for 2 seconds, and the buzzer beeps twice if the correct password is entered. The monitor returns to the previous display. The recorder allows access to the front panel controls if a button operation takes place within 5 seconds of password entry.
3. Retry verification when password error appears on the monitor.

The recorder will exit from verification if there is no operation within 30 seconds.

■ Enabling Button Lock

1. You need to register passwords in the SYSTEM SETUP window prior to operating your system.
2. Press the [LOCK] button for 2 seconds. The buzzer shortly beeps twice, and the LED in the button lights up. The "KEY LOCK DONE!" message appears on the monitor.

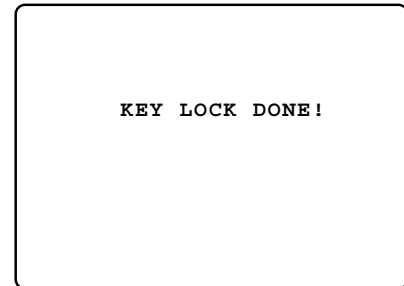

Note: Set PASSWORD LOCK to OFF if you do not want the recorder to revert to button lock mode when no operation takes place within 5 minutes.

WJ-HD220 NETWORK OPERATION

PREPARATIONS

■ System Requirements

Your personal computer must meet the following minimum requirements.

OS:

One of the following operating systems:

Windows98 Second Edition

Windows2000

Windows Millennium Edition

WindowsXP Professional or Home Edition

Browser:

One of the following browser software:

Microsoft Internet Explorer 5.5SP2, 6.0

Note: The Netscape browsers are not applicable.

Display:

1 024 x 768 pixels or more

Trademarks

Microsoft, Windows, WindowsXP and Internet Explorer are either registered trademarks or trademarks of Microsoft Corporation in the United States of America and/or other countries.

■ Connection

System connection examples are shown.

<Direct Connection with a PC>

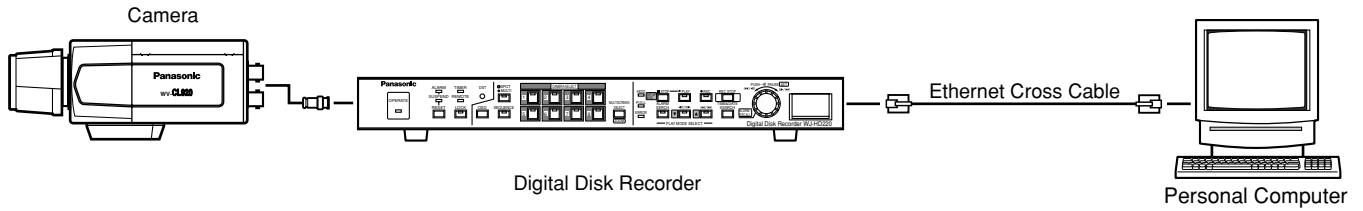

• Connection with a Client PC via Hub

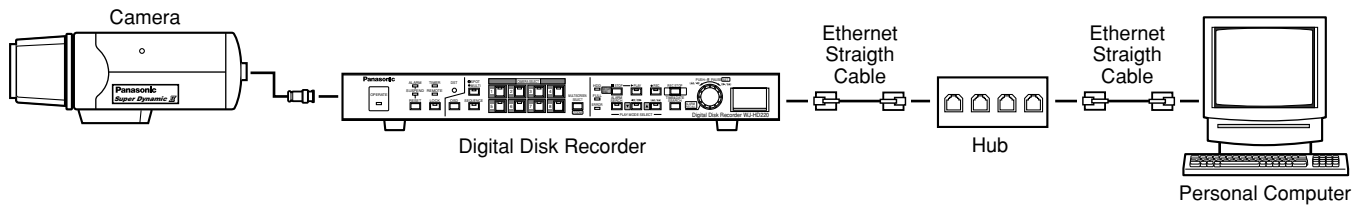

<System Expansion>

A maximum of four PCs can access the recorder at a time.

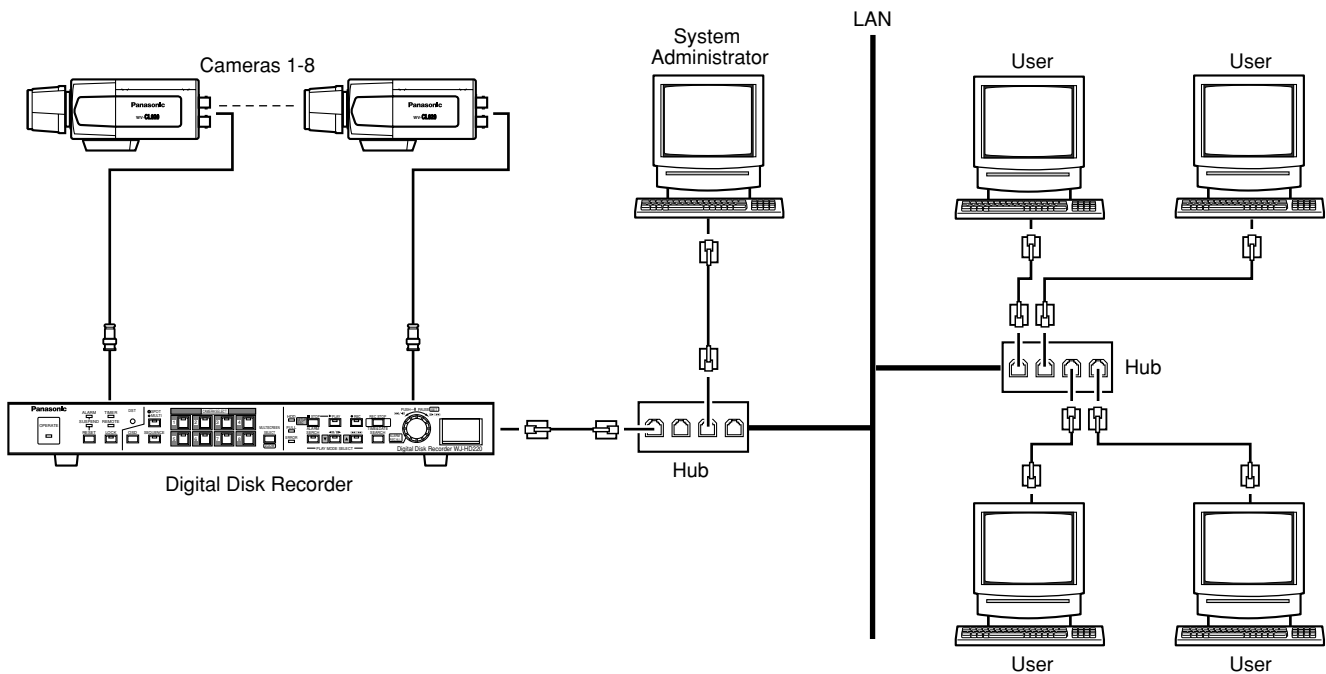

■ Main Page and Control Panel

Start your PC WWW browser. Type <http://192.168.0.10/> (or the IP Address set for WJ-HD220) / in the URL (Uniform Resource Locators) space.

The browser displays the **Main Control Panel** of the WJ-HD220 homepage as shown in the figure.

Notes:

- Specify "http://192.168.0.10/" when a client PC is connected alone.
- Specify "http://: (IP address previously set for the WJ-HD220)" such as a LAN connection.
- A maximum of four PCs can access the recorder at a time.

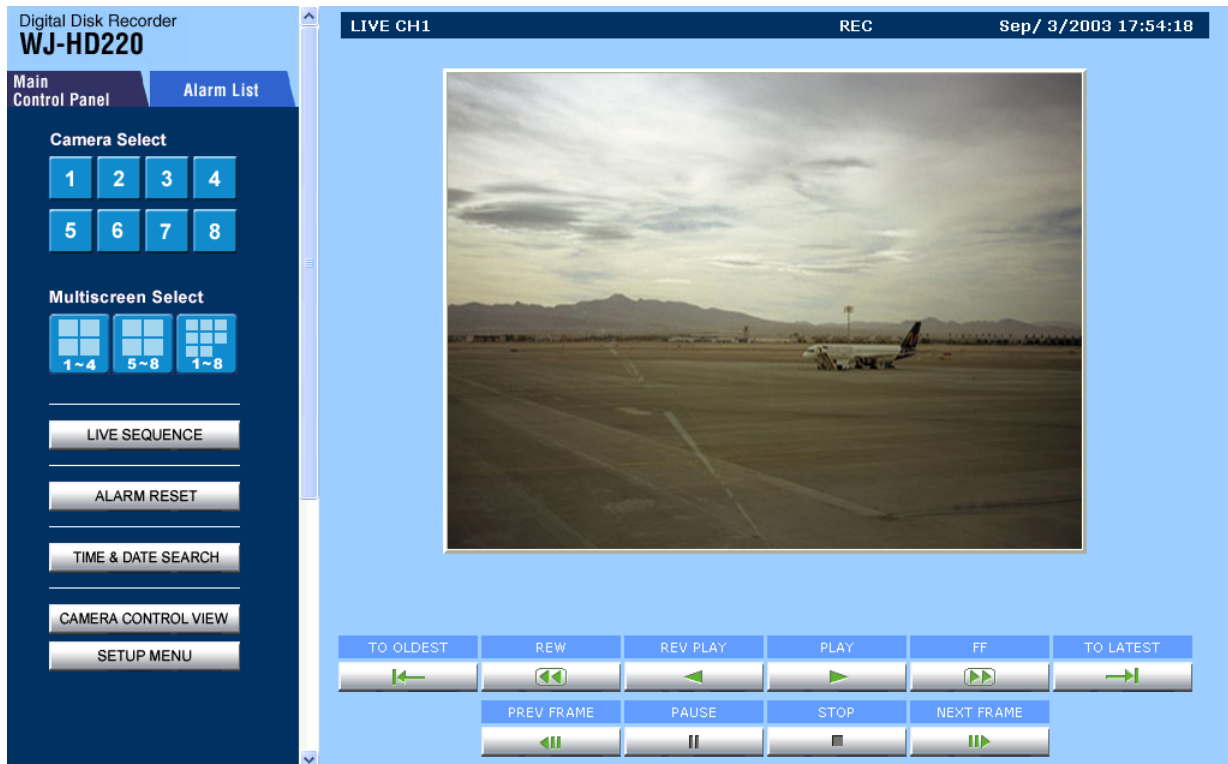

About Picture Quality

Picture quality transferred via the network depends on the recorder's status as follows.

Recorder Status	Displayed Quality
Timer recording	Preset recording quality
Pre-alarm period	Preset alarm recording quality
Except pre-alarm period	Preset manual recording quality
Playback	Recorded quality on the disk

WJ-HD220 SETUP

■ To Access Setup Menus

There are fourteen setup menus to adapt the WJ-HD220 to your requirements.

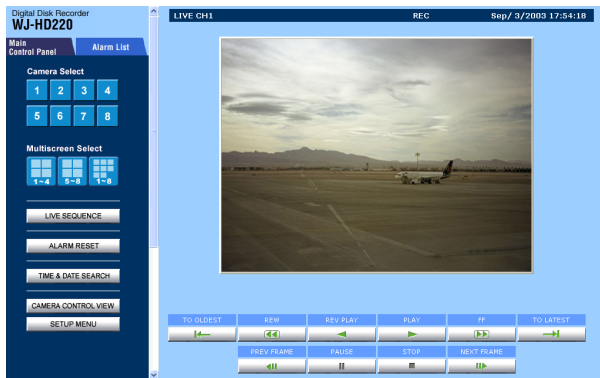

1. On the **Main Control Panel**, click the [SETUP MENU] button. The setup menu opens.



2. Click the buttons to open the respective windows.

<Main Setup Menu>

TIMER SETUP: Specifies the schedule and parameters for timer recordings.

REC SETUP: Specifies the parameters for manual and alarm recordings.

EXT REC SETUP: Selects optional parameters to be applied to the recording while the switch connected externally to the EXT REC terminal turns on.

DISPLAY SETUP: Specifies time-and-date and other displays of status information.

SYSTEM SETUP: Specifies password-protection, and simultaneous REC&PLAY.

ALARM SETUP: Specifies alarm-related monitoring mode, and VMD (video motion detector) mode.

COMMUNICATION SETUP: Specifies parameters for serial and network communications.

SWITCHER SETUP: Specifies sequence and multi-split patterns.

SYSTEM INFORMATION: Displays various system information.

<Network Setup Menu>

USER SETUP: Specifies users, passwords, and access levels.

HOST SETUP: Specifies hosts and access levels.

FTP SETUP: Specifies parameters for transmitting files.

MAIL SETUP: Specifies senders, and receivers.

NETWORK VIDEO SETUP: Specifies application software for video translation, and sequence steps.

3. To return to the **MAIN CONTROL PANEL**, click the [Main Control Panel] tab or [BACK] button in the window.

■ Timer Setup (TIMER SETUP)

● Timer Recording (TIMER REC)



OFF: Runs recording when manually operated, not using any timer. Recording parameters are specified in the REC SETUP window.

INT: Runs recording with the programmed picture quality within the time zone scheduled on the internal timer.

EXT: Runs recording when the externally connected timer switch turns on and supplies power to the recorder (Power-on recording). Recording parameters are specified in the REC SETUP window.

Note: Buttons in the setup menus may appear with a thicker border when using a browser in WindowsXP.

● Program Assignment (TIMER REC)

When internal timer (INT) is selected, programs can be assigned on a weekly and/or daily basis.

Assignable programs: PROG1 – PROG4, OFF

● Programming (PROGRAM SETUP)

There are four programs, each containing four events having a start and end time, and a recording mode.

- Select ON or OFF for each event.
ON: Applies the schedule and mode to the program.
OFF: Does not apply.
- Enter the start and end times.
Assignable START times: From 00:00 to 23:59
Assignable END times: From 00:00 to 24:00
- Click the SET button.
- Click the mode SETUP button. The PROG1-4 No.1-4 window opens.

● Recording Mode Setup (PROG1-4 NO.1-4 SETUP)

Parameters for internal timer recording are assigned to each event (NO.1-4) of the program (PROG1-4) in this window. There are five recording modes available: super fine (SF), fine (FQ), normal (NQ), long-time (EX) and optional (SP). If combined with audio recording (-A), the number of recording modes doubles. The selected recording mode determines the remaining recording time displayed on the monitor.

In the SP mode, the field rate and picture quality are variable, and can be selected at option in the range of 0.1 to 30 FPS with five quality level options respectively. After the recording mode is selected, the available recording time is determined and displayed.

Rec Mode	Quality	Audio Record	Note
SF-xxxH	Super Fine	N/A	
FQ-xxxH	Fine	N/A	
NQ-xxxH	Normal	N/A	
EX-xxxH	Long time	N/A	
SF-AxxxH	Super Fine	Available	
FQ-AxxxH	Fine	Available	
NQ-AxxxH	Normal	Available	
EX-AxxxH	Long time	Available	
SP-AxxxH	Optional setup	Available	Field rate, quality selected optionally
SP-xxxH	Optional setup	N/A	Field rate, quality selected optionally

Notes:

- By selecting a recording time, the recording rate (REC RATE) and the recording quality (REC QUALITY) will be automatically calculated and displayed. For details, refer to the provided booklet "REC MODE TABLES for WJ-HD220".

- Even if preset to 30 or 15 FPS, the actual recording rate may drop to 7.5 FPS at worst while busy multi task such as playback, remote-access playback, remote-access live image, FTP access, multi-split display, or video motion detection are carried out simultaneously. The status display will indicate "*→PLAY" while playing back the images recorded with a rate different from the preset.
- The suffix "xxx" following "SP-" is specified in REC MODE TABLE in the ADDENDUM attached to the manual.

1. Select a recording mode. Audio data will be recorded when a mode with hyphen A is selected.

Available recording modes: SF, FQ, NQ, EX, SP, SF-A, FQ-A, NQ-A, EX-A, and SP-A

2. When SP or SP-A is selected, specify a recording rate (REC RATE).

Available recording rates: From 0.1 to 30 FPS

3. When SP or SP-A is selected, specify a recording quality (REC QUALITY).

Available recording qualities: SUPER FINE, FINE, NORMAL, EXTENDED

● Alarm Recording Mode Setup (ALM REC MODE)

Recording of alarm events arising within the time zone specified by the program will start with the preset parameters.

Refer to "PROG NO. SETUP" described above for operating procedures and available parameters, since they are very similar.

● Pre-alarm Recording (PRE ALM REC)

Available times (seconds): 0S, 1S, 2S, 3S, 4S, and 5S

● Post-alarm Recording (POST ALM REC)

Available times (seconds): 5, 10, 20, 30

Available times (minutes): 1, 1.5, 2, 3, 6

Continue: Recording continues until the [RESET] button is pressed, or the RESET IN signal is supplied to the rear panel.

Manual: Recording continues while the alarm input is active, or at least for 10 seconds if the input turns inactive earlier.

● Dynamic Recording (DYNAMIC REC)

ALM-MULTI: Alarm activated channels are recorded with priority over others.

OFF: All channels are recorded with the same priority.

■ Trigger Action Setup (TRIGGER ACTION SETUP)

This menu specifies the actions the recorder will take for each event when an alarm arises. The program number and event number in the second line of the menu will disappear when the screen is changed from the REC SETUP menu.

CAMERA	MODE
1	REC&ALARM
2	REC&ALARM
3	REC&ALARM
4	REC&ALARM
5	REC&ALARM
6	REC&ALARM
7	REC&ALARM
8	REC&ALARM

SET

BACK

● Mode (MODE)

OFF: Disables alarm recording, logging, or warning.

REC&ALARM: Enables all alarm recording, logging and warning.

REC: Enables alarm recording, but disables warning.

Notes:

- Moving the combination cameras to the preset position can be set only from the REC SETUP menu, not from the Program 1-4 menu.
- To open the menu for setting positions, click the [TRIGGER ACTION SETUP] button in the REC SETUP menu.

Click the [SET] button when items have been set properly.

■ Camera Recording Setup (REC CAMERA SETUP)

CAMERA	MODE
1	<input type="radio"/> ALARM-ONLY <input type="radio"/> REC
2	<input type="radio"/> ALARM-ONLY <input type="radio"/> REC
3	<input type="radio"/> ALARM-ONLY <input type="radio"/> REC
4	<input type="radio"/> ALARM-ONLY <input type="radio"/> REC
5	<input type="radio"/> ALARM-ONLY <input type="radio"/> REC
6	<input type="radio"/> ALARM-ONLY <input type="radio"/> REC
7	<input type="radio"/> ALARM-ONLY <input type="radio"/> REC
8	<input type="radio"/> ALARM-ONLY <input type="radio"/> REC

SET

BACK

Click CAMERA REC SETUP in the system setup window to open the menu.

This menu is provided for the purpose of saving disk space. Each camera channel can be recorded only when an alarm operates, while it will not be recorded in non-alarm status.

ALARM-ONLY: Records the camera channel only when the alarm operates.

REC: Records the camera channel regardless of alarm or non-alarm status.

■ Manual Recording Setup (REC SETUP)

RECORD MODE	SF	96H
SP FRAMERATE		
SP QUALITY		
ALARM REC MODE	SF	96H
SP FRAMERATE		
SP QUALITY		
PRE ALARM RECORD	0 SEC	
POST ALARM RECORD	10 SEC	
DYNAMIC RECORD	<input type="radio"/> OFF	<input type="radio"/> ALARM-MULTI

SET

TRIGGER ACTION SETUP

REC CAMERA SETUP

Manual recording will take effect when OFF (not INT or EXT) is selected in the Timer Mode Selection TIME REC window. The parameters for alarm recording will be applied except for the scheduled time zone if INT is selected.

Click the [REC SETUP] button on the setup control panel to open the window.

Refer to ● Recording Mode Setup PROG1-4 SETUP, NO. 1-4 for operating procedures and available parameters.

■ Trigger Action Setup (TRIGGER ACTION SETUP)

This menu appears when the [TRIGGER ACTION SETUP] button in the REC SETUP menu is clicked.

● Mode (MODE)

CAMERA	MODE	PRESET
1	REC&ALARM	--
2	REC&ALARM	--
3	REC&ALARM	--
4	REC&ALARM	--
5	REC&ALARM	
6	REC&ALARM	
7	REC&ALARM	
8	REC&ALARM	

SET

BACK

OFF: Disables alarm recording logging, and warning.

REC&ALARM: Enables alarm recording logging, and warning.

REC: Enables alarm recording, but disables warning.

● Camera Preset Position (PRESET)

When combination cameras are connected to VIDEO IN 1-4 on the rear panel and positions are specified beforehand, you can assign a position to cameras 1-4.

1-64: Moves the camera to the specified preset position.

HOME: Moves the camera to the home position.

--: Does not move the camera.

Note: Preset move will not function for cameras 5-8 or for cameras 1-4 if they are cameras other than combination cameras.

Click the [SET] button when the items have been set properly.

■ Externally Specified Recording Mode (EXT REC SETUP)

EXTERNAL RECORD MODE	SF	96H
SP FRAMERATE		
SP QUALITY		

SET

This window specifies the recording mode and parameters that will be changed when the switch externally connected to the EXT REC terminal is turned on.

Refer to ● Recording Mode Setup PROG1-4 SETUP, NO. 1-4, for operating procedures and available parameters.

■ Display Setup (DISPLAY SETUP)

CLOCK SETUP | Sep | 10 | 2003 | 11 | 43

SET

TIME&DATE DISPLAY	TYPE1 24H
TIME&DATE POSITION	Right-Lower
TIME&DATE EMBEDDED	<input type="radio"/> OFF <input type="radio"/> ON
STATUS DISPLAY	<input type="radio"/> OFF <input type="radio"/> ON
STATUS POSITION	Right-Lower
HDD FULL	1 (1 to 99%)
REMOTE LED	<input type="radio"/> OFF <input type="radio"/> ON
HDD CHECK	OFF

SET

CAMERA TITLE SETUP

Time and date display and other displays of status information are specified in this window.

● Clock Setup (CLOCK SETUP)

Select a month, and type a day, year, hour, and minute.

● Time and Date Display (TIME&DATE DISPLAY)

TYPE1 24H: Time and date are displayed in one line in the 24-hour system.

TYPE1 12H: Time and date are displayed in one line in the AM-PM system.

TYPE2 24H: Time and date are displayed in two lines in the 24-hour system.

TYPE2 12H: Time and date are displayed in two lines in the AM-PM system.

OFF: Time & date display is disabled.

● Time and Date Position (TIME&DATE POSITION)

Right-Lower: Displays time & date in the lower right corner.

Right-Upper: Displays time & date in the upper right corner.

Left-Lower: Displays time & date in the lower left corner.

Left-Upper: Displays time & date in the upper left corner.

● Time & Date Embedded (TIME&DATE EMBEDDED)

ON: The display will be embedded and recorded with the image data.

OFF: The display will not be recorded.

● Status Display (STATUS DISPLAY)

ON: Status display is enabled.

OFF: Status display is disabled.

● Status Display Position (STATUS POSITION)

Right-Lower: Displays status in the lower right corner.

Right-Upper: Displays status in the upper right corner.

Left-Lower: Displays status in the lower left corner.

Left-Upper: Displays status in the upper left corner.

● HDD Full (HDD FULL)

1% - 99%: The FULL indicator blinks when the remaining capacity reaches the selected value. This will take effect when DISK END MODE is set to STOP in the RECORD SETUP.

● Remote LED (REMOTE LED)

ON: REMOTE LED turns on when the network controls the recorder.

OFF: REMOTE LED is deactivated.

● HDD Check (HDD CHECK)

ON 0:00 - 23:00: The recorder checks the HDD at the specified time every day.

OFF: Check is deactivated.

Click the [SET] button when all items have been set properly.

Click the [CAMERA TITLE SETUP] button to open the CAMERA TITLE window.

■ Camera Title (CAMERA TITLE)

CAMERA TITLE			
CAMERA	TITLE (length=0 to 5)		POSITION
1	<input type="radio"/> OFF <input checked="" type="radio"/> ON	1	Right-Lower ▾
2	<input type="radio"/> OFF <input checked="" type="radio"/> ON	2	Right-Lower ▾
3	<input type="radio"/> OFF <input checked="" type="radio"/> ON	3	Right-Upper ▾
4	<input type="radio"/> OFF <input checked="" type="radio"/> ON	4	Right-Upper ▾
5	<input type="radio"/> OFF <input checked="" type="radio"/> ON	5	Right-Lower ▾
6	<input type="radio"/> OFF <input checked="" type="radio"/> ON	6	Right-Lower ▾
7	<input type="radio"/> OFF <input checked="" type="radio"/> ON	7	Right-Upper ▾
8	<input type="radio"/> OFF <input checked="" type="radio"/> ON	8	Right-Upper ▾

Usable characters: 0to9 AtoZ(Capital Letter) space ! % & () * - . / : ?
l(←) r(→) u(↑) d(↓)

[SET]

● On/Off (ON/OFF)

ON: Displays the camera title.

OFF: Hides the camera title.

● Title (TITLE)

Usable characters: Are shown in the window.

Number of digits: 5 digits maximum.

● Title Position (POSITION)

Right-Lower: Displays the title in the lower right corner.

Right-Upper: Displays the title in the upper right corner.

Left-Lower: Displays the title in the lower left corner.

Left-Upper: Displays the title in the upper left corner.

Click the [SET] button when all items have been set properly.

■ System Setup (SYSTEM SETUP)

SYSTEM SETUP	
PASSWORD LOCK	<input checked="" type="radio"/> OFF <input type="radio"/> ON
PASSWORD ALL (retype) (Digits 1 to 8 are usable. Length is 5)
PASSWORD OPERATION (retype) (Digits 1 to 8 are usable. Length is 5)
KEYLOCK BUZZER	<input type="radio"/> OFF <input checked="" type="radio"/> ON
SKIP ALARM RECALL	1 ▾ (pages)
SIMULTANEOUS REC&PLAY	<input type="radio"/> OFF <input checked="" type="radio"/> ON
ALTER DETECT	<input type="radio"/> OFF <input checked="" type="radio"/> ON
DISK END MODE	<input type="radio"/> STOP <input checked="" type="radio"/> CONTINUE
DISK END BUZZER	<input type="radio"/> OFF <input checked="" type="radio"/> ON
PLAY PRIORITY	LOCAL ▾
TIME ADJUSTING	<input checked="" type="radio"/> SLAVE <input type="radio"/> MASTER => SET TIME 0.00 ▾

[SET]

● Password Lock (PASSWORD LOCK)

Buttons on the front panel of the WJ-HD220 will be password-protected or freed.

ON: Enables password-protection.

OFF: Disables password-protection.

● Password All (PASSWORD ALL)

Enter a five-digit password comprising 1 through 8 to protect normal operations and setup operations from unauthorized access.

Available numerals: From 11111 to 88888

● Password Operation (PASSWORD OPERATION)

Enter a five-digit password to protect normal operations from unauthorized access.

Available numerals: From 11111 to 88888

● Keylock Buzzer (KEYLOCK BUZZER)

The buzzer will beep or not when a locked button is pressed.

ON: Enables the buzzer beep.

OFF: Disables the buzzer beep.

● Skip Alarm Recall (SKIP ALARM RECALL)

Specify the number of pages to be skipped in the alarm log. The alarm log page will jump the specified pages when the JogDial is rotated.

Available skip pages: 1, 5, 10, 20, 50

● Simultaneous Recording and Playback (SIMULTANEOUS REC&PLAY)

There may be cases where recording is essential while playback is in progress.

ON: Allows both recording and playback at a time.

OFF: Allows exclusively recording or playback.

Note: The recording rate may be sacrificed in the following cases.

- Recording and playback/FTP access are carried out simultaneously.
- A multi-split screen is displayed.
- VMD (video motion detection) is enabled.
- A PC accesses the live images via the network.

● **Alteration Detection (ALTER DETECT)**

You can enable or disable the addition of alteration-detection signals in the JPEG data supplied to the network. The default is OFF.

ON: Detects alterations.

OFF: Does not detect.

Note: When set to ON, the data transmission rate on the network will slow down.

● **Disk End Mode (DISK END MODE)**

STOP: Stops recording until a mode other than [STOP] is selected.

CONTINUE: Old data is automatically overwritten from the disk start.

● **Disk End Buzzer (DISK END BUZZER)**

ON: Enables the buzzer beep at the disk end (remaining space = 0 %).

OFF: Disables the buzzer beep.

● **Play Priority (PLAY PRIORITY)**

This setting places priority on a specific access point for playing back the image data when access collisions take place.

LOCAL: Places priority on front panel operations.

NET PLAY: Places priority on network access.

FTP GET: Places priority on access to the FTP.

NONE: The latest operation has priority over others.

● **Time Adjusting (TIME ADJUSTING)**

The internal timer built into the WJ-HD220 is calibrated once a day via the Time Adjust In and Out terminals on the rear panel.

SLAVE: Accepts the calibration signal from the master.

MASTER: Supplies the calibration signal to the slave units at the specified hour every day.

■ Alarm Setup (ALARM SETUP)

ALARM BUZZER	<input type="radio"/> OFF <input type="radio"/> ON
VIDEO LOSS DETECT	<input type="radio"/> OFF <input type="radio"/> ON
MONITOR MODE(MULTI)	<input type="radio"/> OFF <input type="radio"/> SPOT
MONITOR MODE(SPOT)	<input type="radio"/> OFF <input type="radio"/> SPOT

SET

VMD SETUP

● Alarm Buzzer (ALARM BUZZER)

ON: Buzzer beeps while alarm is active.
OFF: Buzzer does not beep.

● Video Loss Detection (VIDEO LOSS DETECT)

OFF: Deactivates the video loss detection.
ON: Activates the detection.

● Multiscreen Monitor Mode (MONITOR MODE (MULTI))

SPOT: Switches to the picture of the channel where alarm has operated.
OFF: Retains the previous display mode.

● Spot Monitor Mode (MONITOR MODE (SPOT))

SPOT: Switches to the picture of the channel where alarm has operated.
OFF: Retains the previous display mode.

Click the [SET] button when all items have been set properly.

■ Video Motion Detector Setup (VMD SETUP)

CAMERA	SENSITIVE	AREA
1	OFF	
2	OFF	
3	OFF	
4	OFF	
5	OFF	
6	OFF	
7	OFF	
8	OFF	

BACK

● Sensitivity (SENSITIVE)

LOW: Low sensitivity
MID: Medium sensitivity
HIGH: High sensitivity
OFF: Motion detection is disabled.

Click the [SET] button when all items have been set properly.

Click the [SETUP] button to open the area setup window.

■ VMD Area Setup (VMD AREA SETUP)

CH1

DELETE SET

BACK

Drag a maximum of four areas with the mouse to specify the detection areas.

Click the [SET] button when all items have been set properly.

■ Communication Setup (COMMUNICATION SETUP)



Click the [SERIAL PORT SETUP] or [NETWORK SETUP] button. The respective window opens.

■ Serial Port Setup (SERIAL PORT SETUP)

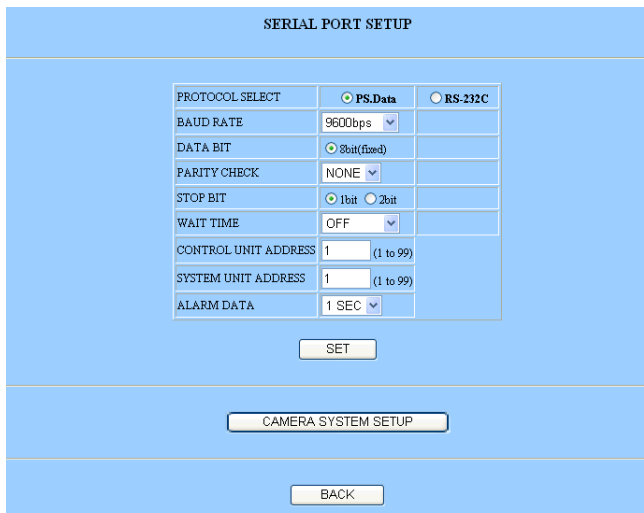

● Protocol Selection (PROTOCOL SELECT)

PS·DATA: Select when the communication chain uses the PS·DATA protocol.

When selected, the DATA terminal on the rear panel can be used.

RS-232C: Select when other than PS·DATA is used.

When selected, the RS-232C terminal on the rear panel can be used.

● Baud Rate (BAUD RATE)

4800: 4 800 bps

9600: 9 600 bps

19200: 19 200 bps

● Data Bit (DATA BIT)

7: 7 bits

8: 8 bits

● Parity Check (PARITY CHECK)

NONE: No parity check

EVEN: Even parity

ODD: Odd parity

● Stop Bit (STOP BIT)

1 bit: 1 bit

2 bit: 2 bits

● Wait Time (WAIT TIME)

OFF: Retransmission is disabled.

100 MSEC: 100 m seconds

200 MSEC: 200 m seconds

1 SEC: 1 second

● Control Unit Addresses

(CONTROL UNIT ADDRESS) (only for PS·DATA)

Assignable address: From 1 to 99, must be unique in the chain.

● System Unit Address (SYSTEM UNIT ADDRESS) (only for PS·DATA)

Assignable addresses: From 1 to 99, must be unique in the chain.

● Alarm Data (ALARM DATA)

OFF: Select this when no system controller is connected.

0 SEC: Does not pause.

1 SEC: Pauses for 1 second.

5 SEC: Pauses for 5 seconds.

Click the [SET] button when all items have been set properly.

Click the [CAMERA SYSTEM SETUP] button. The CAMERA SYSTEM SETUP window opens.

■ Camera System Setup (CAMERA SYSTEM SETUP) (only for PS·DATA)

CAMERA SYSTEM SETUP

CAMERA	NUMBER	COMPENSATION	DATA
1	1 (1 to 128)	S	ON
2	2 (1 to 128)	S	ON
3	3 (1 to 128)	S	ON
4	4 (1 to 128)	S	ON
5	5 (1 to 128)		
6	6 (1 to 128)		
7	7 (1 to 128)		
8	8 (1 to 128)		

[SET]

[BACK]

● Camera Number (CAMERA No.)

The camera number assigned to the port is used when a system controller accesses the camera.

Assignable numbers: From 1 to 128, must be unique in the chain.

● Compensation level (COMPENSATION)

Video signal loss can be compensated for the length of the coaxial cable. "S" stand for short-distance, "M" for medium, and "L" for long.

S: ≤ 500 m

M: 500 m – 900 m

L: 900 m – 1 200 m

● Data Communication (DATA)

ON: Enables data communications by use of PSD commands multiplexed on the coaxial cable.

OFF: Disables coaxial-multiplexed communications.

Click the [SET] button when all items have been set properly.

■ Network Setup (NETWORK SETUP)

NETWORK SETUP

LINE SPEED	AUTO
HTTP SERVER PORT	80
DHCP ON/OFF	<input checked="" type="radio"/> OFF (Static Address) <input type="radio"/> ON (Dynamic Address)
IP ADDRESS	192.168.0.10
NETMASK	255.255.255.0
DEFAULT GATEWAY	192.168.0.1

● Line Speed (LINE SPEED)

AUTO: The speed is automatically selected.

100Mbps (FULL DUPLEX): 100 mega byte, full duplex

100Mbps (HALF DUPLEX): 100 mega byte, half duplex

10Mbps (FULL DUPLEX): 10 mega byte, full duplex

10Mbps (HALF DUPLEX): 10 mega byte, half duplex

● HTTP Server Port (HTTP SERVER PORT)

Enter from the keyboard. The default setting is 80.

● DHCP On/Off (DHCP ON/OFF)

Select ON or OFF for DHCP (Dynamic Host Configuration Protocol).

IP Address (IP ADDRESS)

The IP address is displayed. Enter from the keyboard.

Netmask (NETMASK)

The netmask is displayed. Enter from the keyboard.

Default Gateway (DEFAULT GATEWAY)

The default gateway is displayed. Enter from the keyboard.

● Domain Name Service (DOMAIN NAME SERVICE)

DOMAIN NAME SERVICE	<input type="radio"/> OFF (Only IP Address) <input checked="" type="radio"/> MANUAL (Also Domain Name) <input type="radio"/> AUTO (Also Domain Name)
DOMAIN NAME	localdomain
DNS SERVER ADDRESS	0.0.0.0

DYNAMIC DNS	<input type="radio"/> OFF <input checked="" type="radio"/> ON
DDNS HOST NAME	WJ-HD220
DDNS USER NAME	
DDNS PASSWORD	
DDNS ACCESS INTERVAL	6HOURS

[SET & REBOOT]

SNMP COMMUNITY	public
SNMP CONTACT	
SNMP SYSTEM NAME	
SNMP SYSTEM LOCATION	

[SET]

[BACK]

OFF: Disables DNS, only IP address usable.

MANUAL: Enables DNS.

AUTO: Enables DNS.

Domain Name (DOMAIN NAME)

Enter from the keyboard.

DNS Server Address (DNS SERVICE ADDRESS)

Enter from the keyboard.

● Dynamic DNS (DYNAMIC DNS)

OFF: Does not use DDNS.

ON: Uses DDNS.

DDNS Host Name (DDNS HOST NAME)

Enter from the keyboard.

DDNS User Name (DDNS USER NAME)

Enter from the keyboard.

DDNS Password (DDNS PASSWORD)

Enter from the keyboard.

DDNS Access Interval (DDNS ACCESS INTERVAL)

Enter from the keyboard.

● Simple Network Management Protocol

Note: " (double quotation) cannot be used for SNMP.

SNMP Community (SNMP COMMUNITY)

Enter from the keyboard.

SNMP Contact (SNMP CONTACT)

Enter from the keyboard.

SNMP System Name (SNMP SYSTEM NAME)

Enter from the keyboard.

SNMP System Location (SNMP SYSTEM LOCATION)

Enter from the keyboard.

Click the [SET] button when all items have been set properly.

The WJ-HD220 will restart, and you will be requested to enter the URL as described earlier in Main Page and Control Panel.

■ Switcher Setup (SWITCHER SETUP)

This window specifies sequence setups only for the WJ-HD220. The browser's sequence is set up in LIVE SEQUENCE SETUP on page 77.

The screenshot shows the SWITCHER SETUP window with the following configuration:

- COMMON SETUP**
 - START DISPLAY(MULTI): QUAD 4A
 - START DISPLAY(SPOT): CH 1
 - MULTI SELECT MODE: QUAD ONLY ALL
- MULTI SEQUENCE SETUP**
 - SEQUENCE TIMING: INT EXT
 - AUTO SKIP: OFF ON
- SPOT SEQUENCE SETUP**
 - SEQUENCE TIMING: INT EXT
 - AUTO SKIP: OFF ON
- CAMERA VIEW SETUP**
 - SECRET VIEW: OFF ON

A 'SET' button is located at the bottom of the window.

● Common Setup (COMMON SETUP)

Multiscreen monitor Start Display (START DISPLAY (MULTI))

Spot monitor Start Display (START DISPLAY (SPOT))

The image in the selected form will be displayed on the multiscreen monitor and spot monitor when the unit is turned on.

Single image: CH 1 – CH 8*

Quad image: QUAD-4A (including 1-4), QUAD-4B (including 5-8)

Multi image: 9-SCREEN (including 1-8)

Sequence: SPOT SEQUENCE*, MULTI SEQUENCE

Note: The spot monitor can display only a single image or spot sequence while the multiscreen monitor can display any of the forms listed above.

Multiscreen Selection Mode (MULTI SELECT MODE)

When the [MULTISCREEN SELECT] button on the front panel is pressed, the monitor display will be switched as follows depending on the setup.

QUAD ONLY: QUAD-4A → QUAD-4B → QUAD-4A

ALL: QUAD-4A → QUAD-4B → 9-SCREEN → QUAD-4A

● Multiscreen Sequence Setup (MULTI SEQUENCE SETUP)

Sequence Timing (SEQUENCE TIMING)

INT: The time preset on the internal timer allows the sequence to move a step forward.

EXT: The SEQ IN signal on the rear panel allows the sequence to move a step forward.

Auto Skip (AUTO SKIP)

ON: The sequence skips any step where no video is input.

OFF: The sequence does not skip the step.

Click the button to open the Multi Sequence Setup window.

● Spot-screen Sequence Setup (SPOT SEQUENCE SETUP)

Sequence Timing (SEQUENCE TIMING)

INT: The time preset on the internal timer allows the sequence to move a step forward.

EXT: SEQ IN signal to the rear panel allows the sequence to step forward.

Auto Skip (AUTO SKIP)

ON: The sequence skips any step where no video is input.

OFF: The sequence does not skip the step.

Click the button to open the Spot Sequence Setup window.

● Camera View Setup (CAMERA VIEW SETUP)

Secret View (SECRET VIEW)

ON: The spot monitor screen will be blacked out when the multiscreen monitor displays images in the single live mode.

OFF: The spot monitor continues to display images regardless of the multiscreen monitor status.

Click the button to open the Camera View Setup window.

Note: The secret view function will be useful to watch shoplifters without being recognized in a store where, for example, cameras and spot monitors are installed on the sales floors and a multiscreen monitor is installed in a control room. The spot monitor will black out its screen when the multi-screen monitor is switched to the single live mode to focus on the potential shoplifter.

■ Multi Sequence Setup (MULTI SEQUENCE SETUP)

MULTI SEQUENCE SETUP

STEP	CAMERA CH	TIME (2 to 30)
1	QUAD 4A	2 sec
2	QUAD 4B	2 sec
3	OFF	2 sec
4	OFF	2 sec
5	OFF	2 sec
6	OFF	2 sec
7	OFF	2 sec
8	OFF	2 sec

SET

BACK

- **Camera Channel (CAMERA CH)**

1 - 8: The selected camera image will be displayed in single spot mode.

QUAD 4A: Camera images 1 through 4 will be displayed in quad-split mode.

QUAD 4B: Camera images 5 through 8 will be displayed in quad-split mode.

- **Time (TIME)**

Available times: 2-30 S

Click the [SET] button when all items have been set properly.

■ Spot Sequence Setup (SPOT SEQUENCE SETUP)

SPOT SEQUENCE SETUP

STEP	CAMERA CH	TIME (2 to 30)
1	CH 1	2 SEC
2	CH 2	2 SEC
3	CH 3	2 SEC
4	CH 4	2 SEC
5	CH 5	2 SEC
6	CH 6	2 SEC
7	CH 7	2 SEC
8	CH 8	2 SEC

SET

BACK

- **Camera Channel (CAMERA CH)**

1 - 8: The selected camera image will be displayed.

OFF: The blackout screen will be displayed.

- **Time (TIME)**

Available times: 2-30 S

■ Camera View Setup (CAMERA VIEW SETUP)

CAMERA VIEW SETUP

CAMERA	MODE
1	<input type="radio"/> OFF <input checked="" type="radio"/> ON
2	<input type="radio"/> OFF <input checked="" type="radio"/> ON
3	<input type="radio"/> OFF <input checked="" type="radio"/> ON
4	<input type="radio"/> OFF <input checked="" type="radio"/> ON
5	<input type="radio"/> OFF <input checked="" type="radio"/> ON
6	<input type="radio"/> OFF <input checked="" type="radio"/> ON
7	<input type="radio"/> OFF <input checked="" type="radio"/> ON
8	<input type="radio"/> OFF <input checked="" type="radio"/> ON

SET

BACK

- **Mode (MODE)**

ON: The live image of the channel is displayed.

OFF: The blackout image is displayed.

Click the [SET] button when all items have been set properly.

■ System Information (SYSTEM INFORMATION)

SYSTEM INFORMATION		
HDD HOUR METER	DISK1	30000 HOURS
	DISK2	30000 HOURS
HDD CAPACITY		240.00 GB
RESOLUTION		SIF
SYSTEM VERSION		3.14
MAC ADDRESS		01:23:45:AB:CDEF
IP ADDRESS		192.168.0.10
SUBNET MASK		255.255.255.0
GATEWAY		192.168.0.1
DOMAIN NAME		localdomain
DNS SERVER ADDRESS		133.185.9.51

● Gateway (GATEWAY)

The gateway is displayed.

● Domain Name (DOMAIN NAME)

The domain name is displayed when it is set to ON in the network setup.

● DNS Server Address (DNS SERVER ADDRESS)

The DNS server address is displayed when it is set to ON in the network setup.

Click the [SYSTEM LOG] button to review errors derived from hardware.

Click the [ERROR INFORMATION] to review errors derived from network connections.

● HDD Hour Meter (HDD HOUR METER)

Each meter shows how many hours the digital hard disk recorder has been operated in playback, recording and idle. The built-in HDD needs replacement when the hour meter reads around 30 000 H.

● HDD Capacity (HDD CAPACITY)

The total usable capacity of the built-in hard disk is indicated.

● Resolution (RESOLUTION)

The selected resolution is displayed.

NORMAL: Normal resolution

SIF: Source Image Format (lower than NORMAL)

● System Software Version (SYSTEM VERSION)

This line displays the version number of the installed system software.

● MAC Address (MAC ADDRESS)

A MAC (Media Access Control) address is displayed.

● IP Address (IP ADDRESS)

The IP address is displayed.

● Subnet Mask (SUBNET MASK)

The subnet mask is displayed.

■ System Log (SYSTEM LOG)

SYSTEM LOG

THERMAL = THERMAL ERROR
 WRITE1/2 = HDD WRITE ERROR
 REMOVE1/2 = HDD LINKAGE ERROR
 HDD1/2CHK = HDD CHECK ERROR
 FULL = HDD IS FULL
 NR FULL = HDD IS NEARLY FULL
 VMD1-8 = VMD ALARM REC ERROR
 TERM1-8 = TERMINAL ALARM REC ERROR
 PC1-8 = PSD/RS232C ALARM REC ERROR
 LOSS1-8 = VIDEO LOSS
 POWER = HD220 POWER OFF
 ERROR = UNDEFINED ERRORS

No.	Date	CAUSE
99	Dec/31/2003 19:00:00	THERMAL
98	Dec/31/2003 18:00:00	HDD1CHK
97	Dec/31/2003 17:00:00	FULL
96	Dec/31/2003 16:00:00	WRITE2
95	Dec/31/2003 15:00:00	VMD1
94	Dec/31/2003 14:00:00	VMD2
93	Dec/31/2003 13:00:00	VMD4
92	Dec/31/2003 12:00:00	VMD6
15	Jan/01/2003 15:00:00	POWER
14	Jan/01/2003 14:00:00	PC1
13	Jan/01/2003 13:00:00	TERM4
12	Jan/01/2003 12:00:00	LOSS2
11	Jan/01/2003 11:00:00	LOSS5
10	Jan/01/2003 10:00:00	HDD1CHK
09	Jan/01/2003 09:00:00	HDD1CHK
08	Jan/01/2003 08:00:00	HDD2CHK
07	Jan/01/2003 07:00:00	HDD2CHK
06	Jan/01//200 06:00:0	TERM2
05	Jan/01/2003 05:00:00	TERM3
04	Jan/01/2003 04:00:00	TERM7
03	Jan/01/2003 03:00:00	REMOVE2
02	Jan/01/2003 02:00:00	NR FULL
01	Jan/01/2003 01:00:00	HDD1CHK

Error causes are abbreviated as shown at the top of the window.

■ Error Information on Network Connections (ERROR INFORMATION (FTP, SMTP, DDNS))

Up to 100 errors are displayed. The list is updated by discarding old records when new events arise.

ERROR INFORMATION (FTP, SMTP, DDNS)

No.	Date	Error
100	Aug/11/2003 09:42:29	<DDNS> Cannot connect to DDNS server
99	Aug/11/2003 09:35:55	<DDNS> Cannot connect to DDNS server
98	Aug/08/2003 13:00:16	<DDNS> Connection error to DNS server(Cannot resolve server name.)
97	Aug/08/2003 09:15:52	<DDNS> Cannot connect to DDNS server
96	Aug/08/2003 09:11:13	<DDNS> Connection error to DNS server(Cannot resolve server name.)
95	Aug/07/2003 18:13:23	<SMTP> Connection error to DNS server(Cannot resolve server name.)
5	Aug/14/2003 16:16:45	<SMTP> Undefined error
4	Aug/14/2003 16:12:11	<SMTP> Authentication error (POP3)
3	Aug/14/2003 16:00:56	<SMTP> Undefined error
2	Aug/14/2003 16:00:52	<SMTP> Cannot connect to SMTP server
1	Aug/11/2003 11:57:01	<SMTP> Undefined error

Refer to Appendix ■ Network Error Information for details.

■ User Setup (USER SETUP)

A maximum of 16 users can be registered.

● User Authorization (USER AUTHORIZATION)

OFF: Allows free access.

ON: Verifies the password and access level for a maximum of sixteen users.

Click the [SET] button.

● User Name (USER NAME)

Enter from the keyboard. The default is "admin".

● Password (PASSWORD)

Enter from the keyboard. The default is "admin".

● Access Level (ACCESS LEVEL)

The default is [1].

[1] ADMINISTRATOR: Allows access to the setup parameters, live and playback images.

[2] LIVE MONITORING & PLAYBACK: Bans access to the setup parameters.

[3] LIVE MONITORING ONLY: Allows only monitoring of live images.

Click the [SET] button when all items have been set properly.

● Deleting Users (DELETE USER)

Enter or select the user name you wish to erase, and click the [DELETE] button.

■ Host Setup (HOST SETUP)

A maximum of 8 hosts can be registered.

● Host Authorization (HOST AUTHORIZATION)

OFF: Allows free access.

ON: Verifies the host address and access level for a maximum of eight hosts.

Click the [SET] button.

● Set Host Allowed to Access (SET HOST ALLOWED TO ACCESS)

HOST ADDRESS: enter from the keyboard.

Click the [SET] button.

● Deleting Hosts (DELETE HOST)

Enter or select the host address you wish to erase, and click the [DELETE] button.

Note: Do not enter text lines effective as the HTML tag from the keyboard to the input columns. Otherwise, the menu setup using HTML files may malfunction. If this happens, you need to initialize the settings by referring to ■ Initializing described in page 24.

■ FTP Client Setup (FTP CLIENT SETUP)

FTP CLIENT SETUP

BASIC SETUP

SERVER ADDRESS	<input type="text"/>
LOGIN USER NAME	<input type="text"/>
LOGIN PASSWORD	<input type="text"/> (retype) <input type="text"/>
MODE	<input checked="" type="radio"/> SEQUENTIAL <input type="radio"/> PASSIVE

● Basic Setup (BASIC SETUP)

Server Address (SERVER ADDRESS)

Enter the server address.

Login User Name (LOGIN USER NAME)

Enter the user name.

Login Password (LOGIN PASSWORD)

Enter the password.

Mode (MODE)

Available modes: SEQUENTIAL, PASSIVE

Click the [SET] button.

● FTP Send by Periodic Timer (FTP SEND BY PERIODIC TIMER)

FTP SEND BY PERIODIC TIMER

FTP SENDING	<input checked="" type="radio"/> OFF <input type="radio"/> ON																								
SERVER DIRECTORY	<input type="text"/>																								
FILE NAME	<input checked="" type="radio"/> DATE AND TIME BASE <input type="radio"/> Serial No.: from 1 to 99999999 (MAX=99999999)																								
INTERVAL	1 <input type="text"/> SECONDS 1-1440(SEC),1-1440(MIN)																								
CHANNEL TO SEND	<table border="1"> <tr> <td>CH1</td><td>CH2</td><td>CH3</td><td>CH4</td><td>CH5</td><td>CH6</td><td>CH7</td><td>CH8</td> </tr> <tr> <td><input checked="" type="radio"/> OFF</td><td><input checked="" type="radio"/> OFF</td><td><input checked="" type="radio"/> OFF</td><td><input checked="" type="radio"/> OFF</td><td><input checked="" type="radio"/> OFF</td><td><input checked="" type="radio"/> OFF</td><td><input checked="" type="radio"/> OFF</td><td><input checked="" type="radio"/> OFF</td> </tr> <tr> <td><input type="radio"/> ON</td><td><input type="radio"/> ON</td><td><input type="radio"/> ON</td><td><input type="radio"/> ON</td><td><input type="radio"/> ON</td><td><input type="radio"/> ON</td><td><input type="radio"/> ON</td><td><input type="radio"/> ON</td> </tr> </table>	CH1	CH2	CH3	CH4	CH5	CH6	CH7	CH8	<input checked="" type="radio"/> OFF	<input checked="" type="radio"/> OFF	<input checked="" type="radio"/> OFF	<input checked="" type="radio"/> OFF	<input checked="" type="radio"/> OFF	<input checked="" type="radio"/> OFF	<input checked="" type="radio"/> OFF	<input checked="" type="radio"/> OFF	<input type="radio"/> ON	<input type="radio"/> ON	<input type="radio"/> ON	<input type="radio"/> ON	<input type="radio"/> ON	<input type="radio"/> ON	<input type="radio"/> ON	<input type="radio"/> ON
CH1	CH2	CH3	CH4	CH5	CH6	CH7	CH8																		
<input checked="" type="radio"/> OFF	<input checked="" type="radio"/> OFF	<input checked="" type="radio"/> OFF	<input checked="" type="radio"/> OFF	<input checked="" type="radio"/> OFF	<input checked="" type="radio"/> OFF	<input checked="" type="radio"/> OFF	<input checked="" type="radio"/> OFF																		
<input type="radio"/> ON	<input type="radio"/> ON	<input type="radio"/> ON	<input type="radio"/> ON	<input type="radio"/> ON	<input type="radio"/> ON	<input type="radio"/> ON	<input type="radio"/> ON																		

FTP Sending (FTP SENDING)

ON: Sends the channel images at the specified interval.

OFF: Does not send.

Server Directory (SERVER DIRECTORY)

Enter the directory where you store the image data.

File Name (FILE NAME)

File Name Rule: Date & time basis, Serial numbering

Interval (INTERVAL)

Available times: 1 - 1 440 seconds, 1 - 1 440 minutes

Channel to Send (CHANNEL TO SEND)

OFF: Does not send the channel image.

ON: Sends the channel image.

Click the [SET] button when all items have been set properly.

■ Mail Setup (MAIL SETUP)

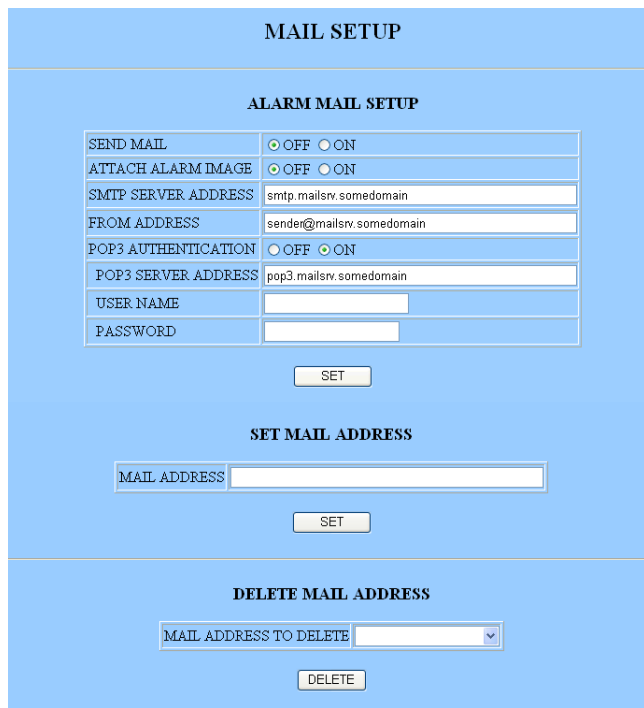

MAIL SETUP	
ALARM MAIL SETUP	
SEND MAIL	<input type="radio"/> OFF <input type="radio"/> ON
ATTACH ALARM IMAGE	<input type="radio"/> OFF <input type="radio"/> ON
SMTP SERVER ADDRESS	smtp.mailsrv.somedomain
FROM ADDRESS	sender@mailsrv.somedomain
POP3 AUTHENTICATION	<input type="radio"/> OFF <input checked="" type="radio"/> ON
POP3 SERVER ADDRESS	pop3.mailsrv.somedomain
USER NAME	
PASSWORD	

SET MAIL ADDRESS

MAIL ADDRESS

DELETE MAIL ADDRESS

MAIL ADDRESS TO DELETE

User Name (USER NAME)

Enter the user name of the sender's account.

Password (PASSWORD)

Enter the password of the sender's account.

Click the [SET] button.

● Set Mail Address (SET MAIL ADDRESS)

Enter from the keyboard, and click the [SET] button. A maximum of four addresses can be set.

● Delete Mail Address (DELETE MAIL ADDRESS)

Enter or select the address you wish to erase, and click the [DELETE] button.

Note: Use the VIEW.HTML to open the attached image and view it in the normal aspect. Otherwise, it will be vertically reduced to half size.

● Alarm Mail Setup (ALARM MAIL SETUP)

Sending Mail (SEND MAIL)

OFF: Does not send.

ON: Sends an e-mail to a maximum of four recipients when an alarm operates.

Attaching Alarm Image (ATTACH ALARM IMAGE)

OFF: Does not attach.

ON: Attaches the image of the alarmed channel to the mail.

SMTP Server Address (SMTP SERVER ADDRESS)

Enter the SMTP server name or its IP address where you wish to send a mail. The SMTP server name can be used only when DNS is set to "AUTO" or "MANUAL".

Sender Address (FROM ADDRESS)

Enter from the keyboard.

POP3 Authentication (POP3 AUTHENTICATION)

ON: Enables authentication with POP3 before SMTP.

OFF: Does not use authentication.

POP3 Server Address (POP3 SERVER ADDRESS)

Enter the SMTP server name or its IP address where you wish to send a mail if POP3 authentication is set to ON. The server name can be used only when DNS is set to "AUTO" or "MANUAL".

■ Network Video Setup (NETWORK VIDEO SETUP)

NETWORK VIDEO SETUP

LIVE & PLAY IMAGE SETUP

VIDEO RATE: MIDDLE

SET

LIVE SEQUENCE SETUP

USE SEQUENCE: OFF ON

AUTO SKIP: OFF ON

STEP	CAM CH	TIME
1	CH 1	FAST
2	CH 2	FAST
3	CH 3	FAST
4	CH 4	FAST
5	CH 5	FAST
6	CH 6	FAST
7	CH 7	FAST
8	CH 8	FAST

SET

● Live & Playback Image Setup (LIVE & PLAY IMAGE SETUP)

Video Rate (VIDEO RATE)

Applicable rates: FAST, MIDDLE, SLOW, VERY SLOW

Click the [SET] button.

● Live Sequence Setup (LIVE SEQUENCE SETUP)

Use Sequence (USE SEQUENCE)

OFF: Does not run the sequence.

ON: Runs the sequence.

Auto Skip (AUTO SKIP)

OFF: Displays any step where no video is input as a blackout screen.

ON: Skips any step where no video is input.

Camera Channel (CAM CH)

Available channels: CH1 - CH8, OFF

Duration (TIME)

Available durations: FAST, MIDDLE, SLOW, VERY SLOW

Click the [SET] button.

■ Main Panel

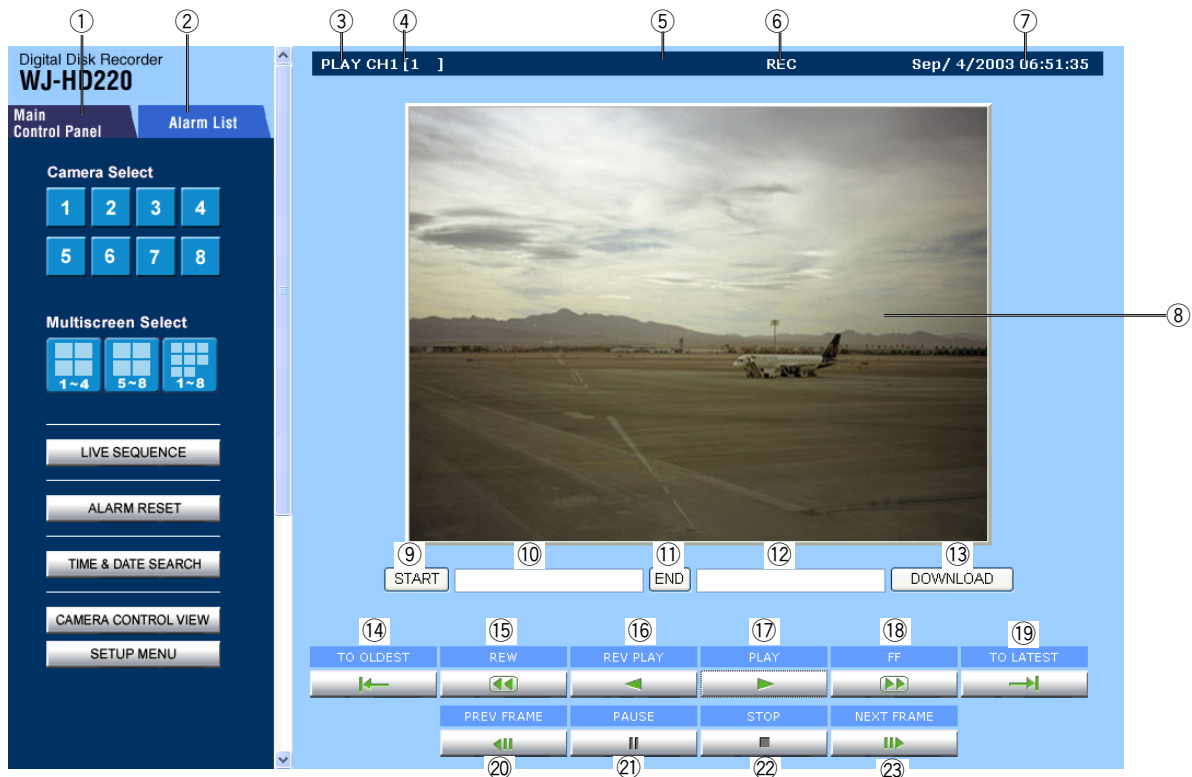

① **Main Control Panel Tab**

Opens the main control panel.

② **Alarm List Tab**

Opens the alarm list.

③ **Network Status Display**

LIVE, LIVE SEQ, PLAY, REV PLAY, >> (FF), << (REW). PAUSE and AL (playback of alarm record) are displayed.

④ **Channel Number Display (CH)**

The channel number of the image is displayed.

⑤ **System Log Display**

System errors up to the present are displayed. Refer to the system log for details.

⑥ **Recorder Status Display**

REC or REC/ALARM CH# is displayed.

⑦ **Time Display**

Time and date are displayed.

⑧ **Image Display Area**

The selected image is displayed.

Notes:

- Buttons and areas from ⑨ to ⑬ will appear only after the [PLAY] button is clicked.
- An interval between start time and end time of up to 30 minutes is allowed.
- Refer to Appendix for opening the downloaded files.

- ⑨ **Start Button (START)**
While playing back, clicking this button will specify the start point for downloading.
- ⑩ **Start Time Display Area**
Displays the start time of the recorded image that you are to download.
- ⑪ **End Button (END)**
While playing back, clicking this button will specify the end point for downloading.
- ⑫ **End Time Display Area**
Displays the end time of the recorded image that you are to download.
- ⑬ **Download Button (DOWNLOAD)**
Pulls out the time range specified for the image data from the start to end time.
- ⑭ **To the Oldest Frame Button (TO OLDEST)**
Jumps the recorded image to the oldest frame of the record.
- ⑮ **Rewind Button (REW)**
Rewinds the recorded image on the WJ-HD220 to the start position.
- ⑯ **Reverse Play Button (REV PLAY)**
Changes the playback direction backwards.
- ⑰ **Play Button (PLAY)**
Plays back the recorded image.
- ⑱ **Fast Forward Button (FF)**
Fast-forwards the recorded image on the WJ-HD220 to the end position.
- ⑲ **To the Latest Frame Button (TO LATEST)**
Jumps the recorded image to the latest frame of the record.
- ⑳ **Previous Frame Button (PREV FRAME)**
Returns the frame one step to the previous.
- ㉑ **Pause Button (PAUSE)**
Pauses the playback image.
- ㉒ **Stop Button (STOP)**
Stops playbacks including REW, PREV FRAME, PAUSE, PLAY, NEXT FRAME, and FF.
- ㉓ **Next Frame Button (NEXT FRAME)**
Forwards the frame one step to the next while pausing.



- ㉔ **Add Favorite Button (ADD FAVORITE)**
Registers the IP address (or URL when using DDNS) to the favorite of the browser.
- ㉕ **Recording Button (REC)**
Starts recording.
- ㉖ **Recording Stop Button (REC STOP)**
Stops recording.

■ Main Control Panel

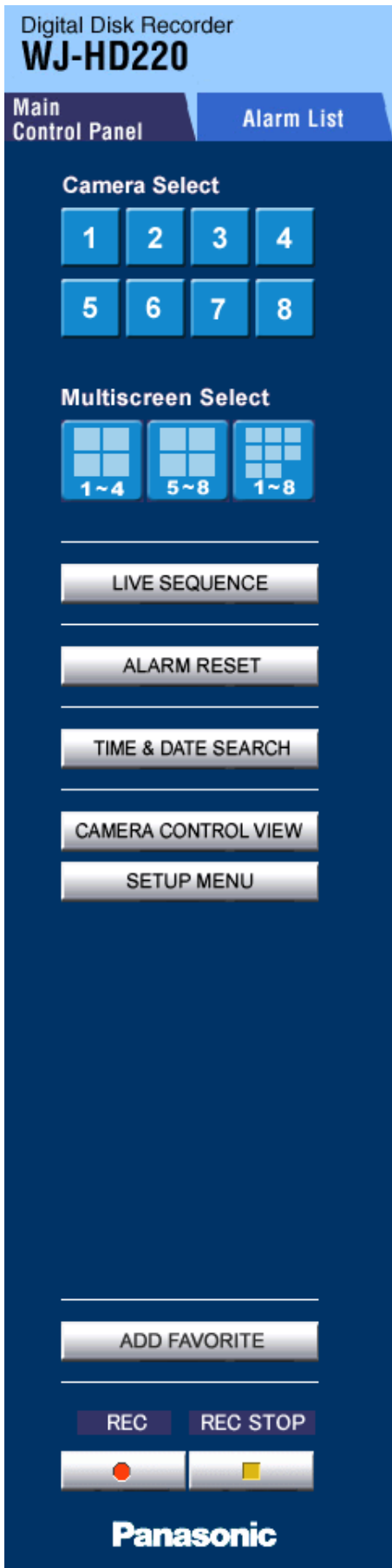

● Camera Selection Button (Camera Select)

Click any of the buttons.

The selected camera channel will be displayed in the image area.

● Multiscreen Selection Button (Multiscreen Select)

Clicking the button displays the respective multiscreen.



● Live Sequence Button (LIVE SEQUENCE)

Clicking the [LIVE SEQUENCE] button runs a series of live images in the preset sequence and for the preset display time.

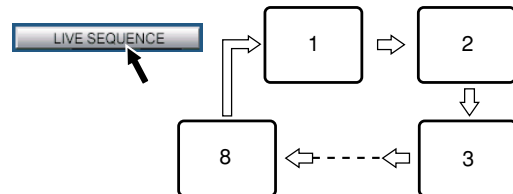

● Alarm Reset Button (ALARM RESET)

The activated alarm event is reset.

● Time & Date Search Button (TIME&DATE SEARCH)

Clicking the button will display the time and date search dialog.

1. Specify the date and time.
2. Click the [OK] button.

The image will be searched, and displayed in the image area.

Note: Searching may take 18 seconds at worst particularly when the recorder runs simultaneous recording and playback, and/or when the targeted image is of small size.

● Camera Control View Button (CAMERA CONTROL VIEW)

The camera control buttons appear on the bottom of the screen when you click the [CAMERA CONTROL VIEW] button. These buttons enable you to adjust images of combination cameras.



ZOOM (WIDE/TELE) buttons zoom the image in or out.

FOCUS (FAR/NEAR/AUTO) buttons adjust the focus of the image. When AUTO is clicked, the camera will adjust the focus by itself.

IRIS (CLOSE/OPEN/RESET) buttons adjust the iris of the image. When RESET is clicked, the iris will return to the factory default setting.

AUTO PAN (ON/OFF) buttons allow the camera to pan endlessly within the preset range.

PRESET allows the camera to turn to the preset position specified by the number.

PAN/TILT Control:

Clicking the desired direction in the image display area will move the camera if it is mounted on a pan/tilt table. The image display area is assigned panning/tilting function with the mouse click. The 25-split (5x5) areas are invisible, but each represents a moving direction: up, down, right or left.

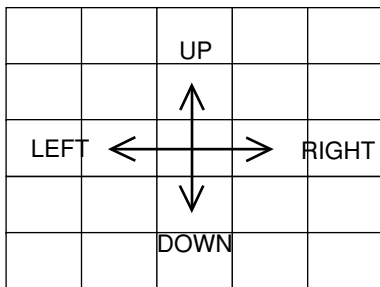

The **Camera Setup (CAM SETUP)** button opens the camera setup menu and a small panel (CAMERA SETUP) having nine buttons.

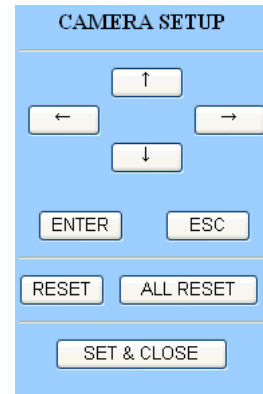

The **Up/Down button (↑/↓)** moves the cursor up and down.

The **Right/Left button (←/→)** moves the cursor right and left or selects parameters.

The **Enter button (ENTER)** validates the selection or opens a lower layer menu.

The **Escape button (ESC)** returns to a higher layer.

The **Reset button (RESET)** opens the special menu if clicked when the cursor is on SPECIAL in the menu.

The **All Reset button (ALL RESET)** resets all settings of the camera to the default if clicked when the cursor is on CAMERA RESET in the special menu.

The **Set & Close button (SET & CLOSE)** validates the settings and closes the menu.

Note: Setup items and operating methods may vary depending on the camera. Refer to the instructions included with the connected cameras.

■ Alarm List

Clicking the alarm list tab on the main control panel opens the list.

Alarm events are listed with event numbers, dates, channel numbers, and event types.

Click a line to play back the recorded image of the event.

CH SORT rearranges the listing order to start with the camera channel you specified. The listing will be sorted by date and time if ALL is specified.

PREV button returns the list page to previous one.

NEXT button opens the next page.

Alarm List Search button opens the search dialog.

Event types are abbreviated as follows in the list.

TERM: The alarm terminal on the rear of the WJ-HD220 is activated.

VMD: The built-in Video Motion Detector operates.

PC: The recorder received an alarm from a PC.

Digital Disk Recorder
WJ-HD220

Main Control Panel Alarm List

Alarm List			
No.	DATE	CH	TYPE
2667	Dec/31/2003 20:00:00	1	TERM
2666	Dec/31/2003 19:00:00	2	VMD
2665	Dec/31/2003 18:00:00	3	VMD
2664	Dec/31/2003 17:00:00	4	TERM
2663	Dec/31/2003 16:00:00	5	TERM
2662	Jan/01/2003 15:00:00	1	TERM
2661	Jan/ 1/2003 14:00:00	2	TERM
2660	Jan/ 1/2003 13:00:00	3	TERM
2659	Jan/ 1/2003 12:00:00	4	TERM
2658	Jan/ 1/2003 11:00:00	5	TERM
2657	Jan/ 1/2003 10:00:00	1	TERM
2656	Jan/ 1/2003 09:00:00	2	TERM
2655	Jan/ 1/2003 08:00:00	3	TERM
2654	Jan/ 1/2003 07:00:00	4	TERM
2653	Jan/ 1/2003 06:00:00	5	TERM
2652	Jan/ 1/2003 05:00:00	1	PC
2651	Jan/ 1/2003 04:00:00	2	PC
2650	Jan/ 1/2003 03:00:00	3	PC
2649	Jan/ 1/2003 02:00:00	4	TERM
2648	Jan/ 1/2003 01:00:00	5	TERM

CH SORT ALL ▾

PREV NEXT

ALARM LIST SEARCH

Specify the month, day, year, and time of the event you wish to search. If other than ALL is selected, only images of the specified channel will be displayed.

Click the [OK] button. The dialog box disappears, and the closest event will be displayed.

Note: Searching may take 18 seconds at worst particularly when the recorder runs simultaneous recording and playback, and/or when the targeted image is of small size.

ALARM LIST SEARCH

DATE (M/D/Y) Jan ▾ / 1 / 2003

TIME (H:M:S) 0 : 0 : 0

CH ALL ▾

OK CANCEL

■ HTTP Download and Viewing Images

When accessing the WJ-HD220 from the browser, and the [DOWNLOAD] button is clicked in playback, the image data and viewer software are downloaded as an "exe" file to your PC.

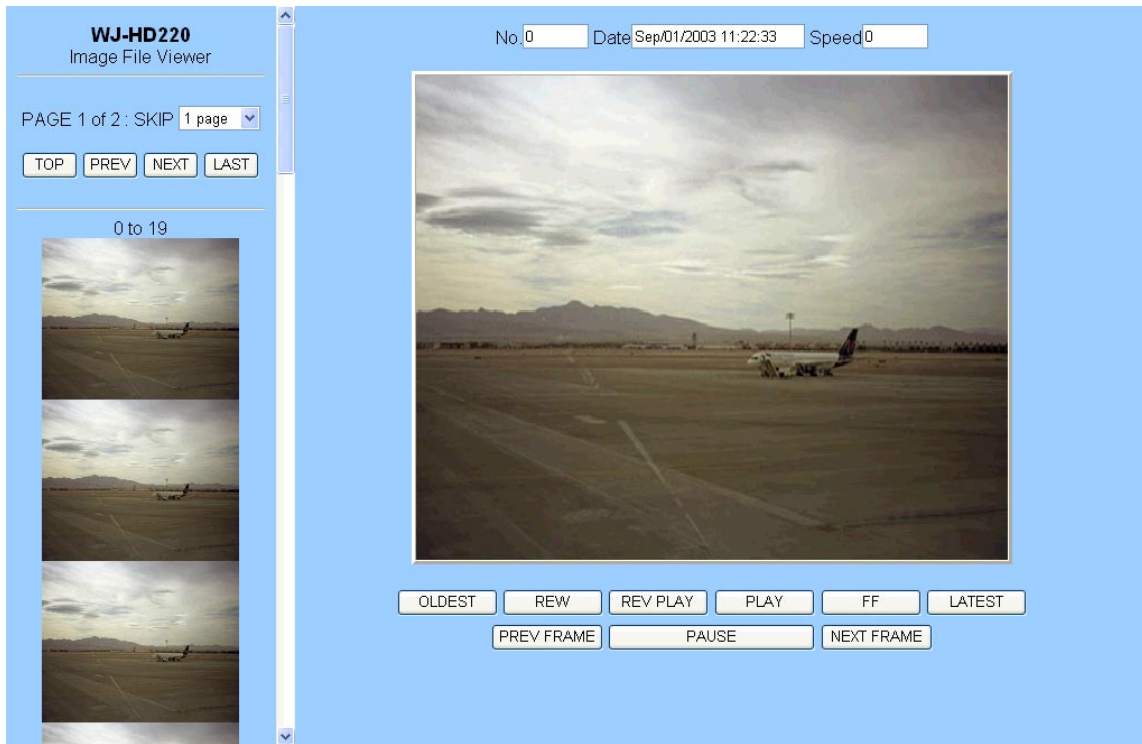

1. Move the file to an appropriate folder.
2. Double-click the file to expand it to the following.
Image file (.jpg)
index.html

Expanded images can be displayed by executing "index.html". Using other applications may display the image vertically reduced to half size.

3. Display "index.html" using the web browser.

SKIP: Jumps the number of the thumbnails.
TOP: Returns to the top page.
PREV: Returns to the previous page.
NEXT: Goes to the next page.
LAST: Jumps to the last page.

Frame No.: Indicates the frame number of the displayed image.

Date: Indicates the date when the image was recorded.

Speed: Indicates the playback speed.

OLDEST: Goes to the oldest frame of the record.

REW: Changes the reverse-playback speed by clicking.

REV PLAY: Starts playing back in descending order of the file name.

PLAY: Starts playing back in ascending order of the file name.

FF: Changes the forward-playback speed by clicking.

LATEST: Goes to the latest frame of the record.

PREV FRAME: Pauses after returning a frame.

PAUSE: Pauses the image display.

NEXT FRAME: Pauses after forwarding a frame.

TROUBLESHOOTING

Phenomenon	Cause	What to do
Power is not turned on.	Power cord not properly connected	Connect the power cord to AC outlet.
Error message "HDD ERROR" is displayed on the monitor.	No disk available	Refer to HDD MAINTENANCE in Appendix to confirm the HDD status. Consult your dealer when a malfunction is found.
Error message "CH n LOSS (n=1-8)" is displayed on the monitor.	Disconnection of camera, camera cable, or VIDEO IN BNC.	Connect the respective camera, cable, or connector properly.
Error message "THERMAL ERROR" is displayed on the monitor.	Ventilation blocked, or failure of cooling fan	Remove obstacles, or consult your dealer for servicing.
Administrator password cannot be recalled.		Reset the recorder to the factory defaults (page 24) and enter a new password.
DISK MENU appears when turning on the power.	HDD status may have changed, or a malfunction may have occurred.	Check the HDD status referring to HDD MAINTENANCE. Consult your dealer when a malfunction is confirmed.
Camera picture is not displayed on the monitor.	Lens cap not removed from the camera, some device is not turned on, or brightness and contrast of the monitor are improperly adjusted.	Detach the lens cap, turn on the device, or adjust the monitor.
Nine-split display does not function.	QUAD ONLY may be set for MULTI SELECT MODE.	Set it to ALL.
Setup menus supplied from the Matrix Switcher are not recorded.	The WJ-HD220 does not record non-interlace video.	
When accessing via the network:		
Remote operations are not accepted while BUSY indicator is lit.	Front panel buttons on the recorder are being operated, or more than four PCs access the recorder.	Wait until the preceding accesses end.
Slow image refreshment and/or slow response to operations	Network is busy.	Wait until the preceding accesses end.
Intermittent sound reproduction	Network is busy.	
No click sound desired.	Default setting is ON.	Change the setting as follows: Control Panel → Sound Multimedia → Sound Tab → Explorer → OFF
Cannot search alarm image in the list	Specified date may be later. DISK END MODE is set to CONTINUE. Over 9 999 of alarm events arose.	Enter a date that is a little older than the one you wish to search. Old image data are overwritten and cannot be searched. Old records were discarded.

SPECIFICATIONS & APPENDIX

SPECIFICATIONS

General

Power Source Required:	120 V AC, 60 Hz
Power Consumption:	45 W
Ambient Operating Temperature:	+5 °C - +45 °C (41 °F - 113 °F)
Ambient Operating Humidity:	Less than 85 %
Dimensions:	420 mm (W) x 44 mm (H) x 350 mm (D) 16-9/16" (W) x 3-7/16" (H) x 13-3/4" (D)
Weight:	5.2 kg (11.4 lbs.)

Input

Video Input:	1.0 V[p-p]/75 Ω Composite video signal with 75 Ω Automatic Termination / Looping through (x8)
Audio Input:	-10 dB 10 k Ω unbalanced, RCA standard jack

Image Process

Compression System:	JPEG
Pixel Rate:	720 x 240 (Effective pixels 672 x 224)
Refresh Rate:	30 FPS maximum

Output

Video Output:	1.0 V[p-p]/75 Ω Composite video signal/Looping through (x8)
Video Output Front Panel:	1.0 V[p-p]/75 Ω Composite video signal (x1)
Audio Output:	-10 dB 600 Ω unbalanced, RCA standard jack (x1)
Audio Output Front Panel:	-10 dB 600 Ω unbalanced, RCA standard jack (x1)
Spot Monitor Output:	1.0 V[p-p]/75 Ω Composite video signal (x1)
Multiscreen Monitor Output:	1.0 V[p-p]/75 Ω Composite video signal (x1)

Control Port

Alarm/Remote Port:	25-pin Full Pitch D-sub connector (x1) Alarm Input 1-8, Alarm Reset Input, EXT REC Input, Time Adjust Input, Sequence Input: Low-active, Non-voltage N.O. Contact, ≥ 100 ms Alarm Recovery Output 1, Disk End Status Output, Time Adjust Output, Warning Output, REC Status Output, Sequence Output: Low-active, Open-collector, 24 VDC 100 mA max. Alarm Output 1, Play Status Output: Low-active, Open-collector, 12 VDC 100 mA max. Alarm Output 2: High-active, 12 V 4.7 k Ω Alarm Recovery Output 2: High-active, 12 V DC 220 Ω
RS-485 (PS•Data):	6-conductor modular jack (RJ-11)
RS-232C:	9-pin Full Pitch D-sub connector
10/100BASE-TX Port:	10Base-T and 100Base-TX, 8-conductor modular jack (RJ-45) Protocol Installed: TCP/IP, HTTP, FTP, SMTP, SNMP, DNS, DDNS Security: Password-protected



















































































Weight and dimensions shown are approximate.
Specifications are subject to change without notice.

STANDARD ACCESSORIES

Rack Mounting Bracket	2 pcs.
Screw for Rack Mounting Bracket (M3x10)	6 pcs.
Absorber	4 pcs.
Sleeve	4 pcs.
Hard Disk Fixing Screw	4 pcs.
Earth Lug	1 pc.

Remote Control from System Controller

A system controller having PS•Data capability can control the WJ-HD220. The table compares operations of the WJ-HD220 and of the system controller WV-CU360. Make certain that the protocol selection for the WJ-HD220 is set to PS•Data.

Item	WJ-HD220	WV-CU360	Note
Setup menu display on/off	Hold down 2 seconds 	Hold down 2 seconds 	Button lock is released automatically by opening the setup menu.
Setup item selection	 	 	
Parameter selection Alarm list page turn		 	
Cursor return to setup or last screen restored		 	
Alarm list display on/off	Hold down 2 seconds 	 →  	
Alarm event search		 	
Lower layer menu	 Press	 	
Alarm record playback		 	
Recording		 →  → 	
Playback and recording stop		 →  → 	
Playback stop		 →  → 	Exclusive use to stop playback
Recording stop		 →   → 	Exclusive use to stop recording
Playback		 →  → 	
Pause		 →  → 	
Step playback FWD	 	 →  → 	
Step playback REW	 	 →  → 	
Skip playback FWD	 	 →   → 	 → 1PLAY → 2PLAY 3FF ← 2FF ← 1FF ←
Skip playback REW	 	 →   → 	 → 1PLAY → 2PLAY 3REW ← 2REW ← 1REW ←
Jump to latest	 Press JogDial	 →  → 	The top of the latest record will be accessed.
Jump to oldest	 Press JogDial	 →  → 	The top of the oldest record will be accessed.

Item	WJ-HD220	WV-CU360	Note
Daylight saving	DST 	→ 1 → 3 →	
Timer REC mode		→ 1 → 4 →	OFF, INT or EXT selectable
Status display on/off	OSD 	→ 1 → 9 →	
Button lock off	Enter your password.	→ 3 → 0 →	
Button lock on	LOCK 	→ 3 → 1 →	
Multiscreen pattern selection	MULTISCREEN SELECT 	MULTI SCREEN SELECT 	
Multiscreen monitor	SPOT MULTI 	1 →	
Spot monitor	SPOT MULTI 	2 →	
Camera selection		[Num Button] →	
Alarm reset	RESET 	ALM RESET 	
Alarm suspension	RESET LOCK 	ALM SUSPEND 	Hold down simultaneously
Electric zoom in/out	MULTISCREEN SELECT 	EL-ZOOM 	Enlarged portion can be moved with the Joystick.
Sequence start	SEQUENCE 	SEQUENCE 	Select a camera to stop the sequence.
Display/hide Time&Date search window while opening the alarm list	TIME&DATE SEARCH 	MON 	
Display Time&Date search window	TIME&DATE SEARCH 	→ 7 → 8 →	
Hide Time&Date search window	TIME&DATE SEARCH 	Hold down 2 seconds 	
Item selection for Time&Date search window			
Time and date selection for Time&Date search		STILL EL-ZOOM 	
Implement Time&Date search	PLAY 	CAM 	

■ RS-232C Communication Protocol

The following pages detail the elements for communication between the Digital Disk Recorder and the personal computer. Be sure to select RS-232C for PROTOCOL in the COMMUNICATION SETUP window. For BAUD RATE, DATA BIT and PARITY settings, refer to COMMUNICATION SETUP. For cable connection refer to RS-232C CONNECTION.

1. Transmission Command

The PC sends messages to the Recorder in the format shown below. Also refer to the command table shown later.

Code	[STX] [Transmission Command] : [p1] : [p2] : : [pn] [ETX]
ASCII	(02H) ()----- () (03H)

[p] stands for parameter. Parameters are omitted when there is no need to specify them in the command.

2. Response Command

The Recorder returns messages in reply to the PC's messages with the following formats.

(1) Reception Command

When the reception was completed successfully, the Recorder sends back the "ACK code 06H" to the PC, and then the response command below.

Code	[STX] [Response Command] : [p1] : [p2] : : [pn] [ETX]
ASCII	(02H) ()----- () (03H)

Parameters are omitted when the command format includes neither data nor status to send back.

(2) Reception error

The recorder sends back the "NAK code 15H", followed by the parameters shown below. The Recorder then resets the reception buffer and enters waiting mode for the next message. Parameter "e" identifies the error status.

Code	[NAK] [e]
ASCII	(15H)

"e" value 1: Parity error (31H)
 2: Framing error (33H)
 3: Overrun error (34H)

(3) Parameter error

The Recorder returns the "ACK code 06H", if the transmission code was not processed properly for some reason, followed by an error code as shown below.

Code	[STX] ERE [ETX]
ASCII	(02H) (45H) (03H)

Note: The Recorder returns [ACK] or [NAK] to the PC within 20 ms after the reception of [ETX] in a transmission.

● Command Table

Basic Operation

Item	Transmission Command (ASCII)	Response (ASCII)	Parameter (ASCII)
Fast Forward to the end	OFF	OFF	
Pause	OPA	OPA	
Play	OPL	OPL	
Recording	ORC	ORC	
Rewind to the top	ORW	ORW	
Skip&Play Forward	OSF:n	OSF	n=0F Normal speed n=1F x2 speed n=2F x5 speed n=3F x50 speed n=5F x100 speed n=0S Normal speed n=1S 1/2 speed n=+ Increment n=- Decrement
Stop	OSP:n	OSP	n=P stops PLAY n=R stops REC no parameter stops PLAY and REC
Skip&Play Rewind	OSR:n	OSR	Refer to OSF.
Forward a field	OVF	OVF	
Rewind a field	OVR	OVR	
Camera Selection	OCS:cccc	OCS:cccc	cccc=00001 – 00008 (decimal) cccc=+ 1 up cccc=- 1 down
Monitor Selection	OMS:mmmm	OMS:mmmm	mmmm=0001 Multi-screen Monitor mmmm=0002 Spot Monitor
Button Lock	MKL:n	MKL	n=0 Unlock n=1 Lock
EL-zoom	OZM:m	OZM:m (m=0-4)	m=0 EL-zoom OFF m=1 EL-zoom ON m=2 2-fold m=4 4-fold m=+ x1 → x2 → x4 → x1 m=- x4 → x2 → x1 → x4

Alarm Control

Item	Transmission Command (ASCII)	Response (ASCII)	Parameter (ASCII)
Alarm Suspension	MAD:n	MAD:n	n=0 Suspension disabled n=1 Suspension enabled
Alarm History Display	OAE:n	OAE	n=0 Display hides n=1 Display appears n=+ Toggle
Alarm Reset	OAL:n	OAL	n=0 Manual reset n=1 Auto reset
Alarm History Clear	OAR	OAR	
Alarm Picture Search	SAS:nnd (:p)	SAS	n=01 Skip number (fixed) d=F Search later d=B Search older p=L Search and PLAY p=A Search and PAUSE

Setup Control

Item	Transmission Command (ASCII)	Response (ASCII)	Parameter (ASCII)
Cursor Moves	DCR:n1n2	DCR	n1=A Right n1=C Upward n1=E Left n1=G Downward n2=1 Move a step n2=2 Move multi steps n1n2=PD Move to lower layer n1n2=P+ Move to upper layer n1n2=P- Turn a newer page n1n2=PU Turn an older page
Key Lock	MKL:n	MKL	n=0 Lock OFF n=1 Lock ON
Recording Event Setup	MRM:n	MRM	n=0 Normal recording n=1 Internal timer recording n=2 External timer recording
Summer Time Setup	MST:n	MST	n=0 Standard time n=1 Summer time
Setup	MSU:n	MSU:n	n=0 End setup n=1 Begin setup
Date&Time Setup	TSU:yyyymmddhhnn	TSU	yyyy=Year mm=Month dd=Day hh=Hour (24-hour system) nn=Minute

Miscellaneous Control

Item	Transmission Command (ASCII)	Response (ASCII)	Parameter (ASCII)
OSD Show/Hide	DIN:n	DIN	n=+ Toggle n=0 Hidden n=1 Shown
Communication Check	RCK	RCK	
Time&Date Search	ZTS:yyyymmddhhnnss	ZTS	yyyy=Year mm=Month dd=Day hh=Hour (24-hour system) nn=Minute ss=Second
Time&Date Search Window	ZTL:n	ZTL	n=7 Search window displayed n=0 Search window hidden
Alarm Log Search Window	ZTM:n	ZTM	n=1 Alarm log search displayed n=0 Alarm log search hidden

Data Log Control

Item	Transmission Command (ASCII)	Response (ASCII)	Parameter (ASCII)
Log Total Size Inquiry	ILB:k	ILB:k:bbbbbb	k=0 Alarm log bbbbbb=00001 to 09999 (in decimal)
Log Erase	ILC:n	ILC:n	n=0 Alarm log n=1 System log
Log Recorded Size Inquiry	ILQ:k	ILQ:k:bbbbbb:dddd:(:E)	k=0 Alarm log bbbbbb=00001 - 09999 (Oldest log) dddd=00001 - 09999 (Size of log) E=Overwrite
Log Readout	ILR:k:sssss:mmmmm	ILR:k:<log data s1>s1 <log data s2>s2 <log data sn>F	k=0 Alarm log sssss=00001 - 09999 Start Address mmmmm=00001-00100 Decimal # of log <log data sn>=yyyymmddhhnnss sn=0-9 and F Cyclic number (F is put at data end)

Media Control

Item	Transmission Command (ASCII)	Response (ASCII)	Parameter (ASCII)
Disk End Notice Setup	MDE:n	MDE	n=0 End is not notified n=1 End is notified
Disk End Notice		HDE	

Inquiry

Item	Transmission Command (ASCII)	Response (ASCII)	Parameter (ASCII)
Remaining Size Inquiry	QHR	QHR:nnn	nnn=000-100 Decimal %
ID Inquiry	QID	QID:WJ-HD220	
Key Lock Status Inquiry	QKM	QKM:n	n=0 Lock OFF n=1 Lock ON
Alarm Info Inquiry	QLD:n	QLD:n (Alarm Information)	<p>In Transmission command: n=0 Event report n=1 Date&time report</p> <p>In Response command: n=0 No alarm event n=1 Alarm has been reset n=2 Alarm activated k=0 VMD n=2 PC alarm</p> <p>Alarm Information: k1:y1y1m1m1d1d1h1h1n1n1s1s1: k2:y2y2m2m2d2d2h2h2n2n2s2s2...</p>
Status Inquiry	QSR	QSR: [status1]:[status2]:...[status13]	<p>mad:1 Alarm suppression On mad:0 Alarm suppression Off mkl:1 Button locked mkl:0 Button unlocked msu:1 Setup operation msu:0 Normal operation oms:0001 Multiscreen monitor oms:0002 Spot monitor ocs:cccc cccc= Camera # (00001 - 00008) otc:0 4-split screen otc:2 9-split screen oqt:01n n=F Sequence running n=P Sequence pausing oae:1 Alarm log displayed oae:0 Alarm log Hidden orc Recording osp:R Pause while recording opl Playback opa Pause osf:0F - 5F Fast playback 0F= x1, 1F≈ x2, 2F≈ x5, 3F≈ x50 4F=Not applicable, 5F≈ x100 osf:0S - 1S Slow playback 0S= 1/1, 1S≈ 1/2 osr:0F - 5F Reverse fast playback 0F= x1, 1F≈ x2, 2F≈ x5, 3F≈ x50 4F=Not applicable, 5F≈ x100 osr:0S - 1S Reverse slow playback 0S= 1/1, 1S≈ 1/2 osp:P Stop ztl:7 Search screen displayed ztl:0 Search screen hidden ztm:1 Alarm log search displayed ztm:0 Alarm log search hidden</p>
Software Version Inquiry	QRV	QRV: (Version numbers)	System version number

■ HDD Maintenance

● When to Maintain HDD

HDD maintenance is required in the following cases.

- When FULL indicator lights up
- When ERROR indicator lights up
- When an optional hard disk is added
- When you wish to format the HDD or to remove link
- When HDD reaches its life time (around 30 000 hours, displayed in the SYSTEM INFO window)

● Who to Maintain HDD

Caution: Addition, replacement, and other HDD maintenance should be performed by qualified service personnel.

● Power-on Procedures

After power-on, the recorder confirms the HDD status and displays corresponding messages on the monitor.

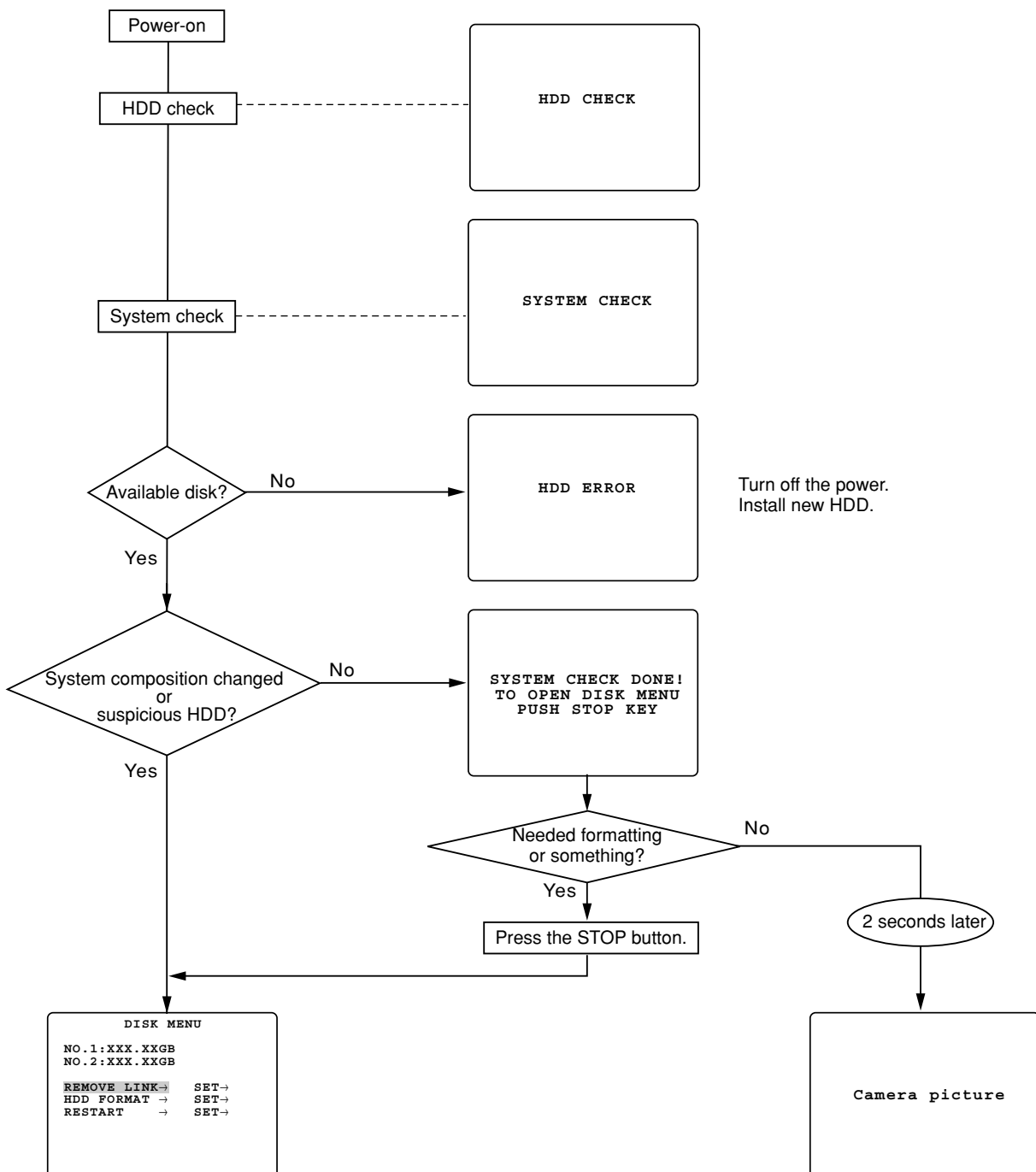

● When Full Indicator is Lit (Resetting Disk End)

● FULL Indicator

The FULL indicator will light up when STOP is set to DISK END MODE, provided that the disk space nears the end.

To reset it, do the following.

● DISK END Setup

1. Hold down the [STOP] button for 2 seconds to open the MAIN MENU.

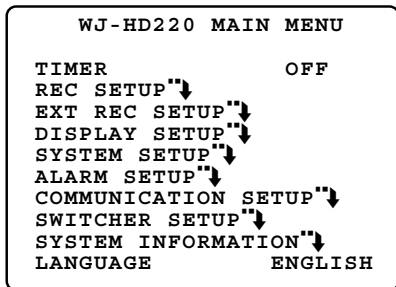

2. Select SYSTEM SETUP, and press the JogDial to open the SYSTEM SETUP menu.

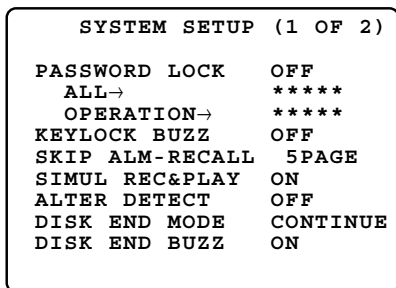

3. Move the cursor to DISK END MODE, and rotate the JogDial to select CONTINUE. Then press the JogDial.

STOP: Stops recording at the disk end.

CONTINUE: Overwrites from the start of the disk.

4. Press the [STOP] button to return to the MAIN MENU.
5. Hold down the [STOP] button for 2 seconds to return to normal operations.
The recorder starts operating in continuous mode up to the disk end.

If you wish the recorder to revert to STOP for DISK END MODE, repeat above steps 1 through 5, but select STOP in step 3.

● When Error Indicator is Lit

Refer to your dealer for servicing when this happens.

● HDD Check

The recorder checks the hard disk when the recorder is turned on, or when the HDD CHECK time specified in the menu setup comes during operation.

The recorder warns you of any error detected as follows.

Error indicator blinks.

Warning Out terminal on the rear panel turns active.

"HDD ERROR" will appear when there is no disk installed in the recorder.

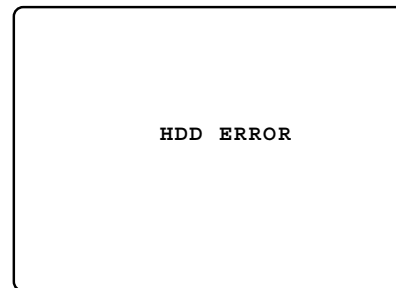

When this happens, turn off the power. New disk(s) should be installed on the recorder, referring to INSTALLATION.

● When Error Detected

1. Turn off the recorder, and turn it on again. It will perform as follows.

DISK MENU is displayed.

Error indicator blinks.

Buzzer beeps every 5 seconds.

2. Press any buttons other than [STOP] to stop the indicator blinking and buzzer beep.
3. See DISK MENU on the next page for further operations.

● DISK MENU

● Disk Menu

The menu appears if the hard disk error is found during power-up.

The buzzer beeps every 5 seconds, and the ERROR indicator turns off.

Press any button other than [STOP] to mute the buzzer beep.

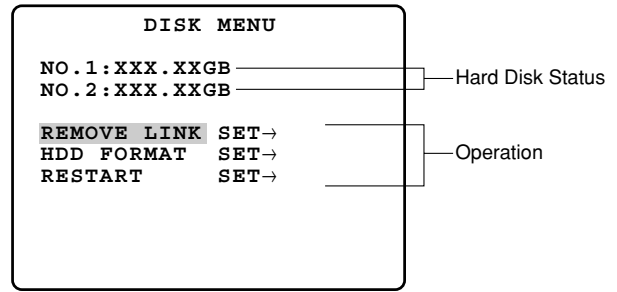

The hard disk status and required operations are shown in the table.

Abbreviation	Status	Required	Note
Capacity	Normal status	–	
ERR	Writing error	Format, remove link ,or replace HDD if erred even after formatting.	WR1 or WR2 appears in SYSTEM LOG when indicating a writing error.
	LOST or * status was left for one minute.	Same as above.	
*	Awaiting format	Restart or Format	All existing HDD have been previously used in another WJ-HD220.
LOST	HDD physically removed	Remove link, or add a new HDD.	HDD is removed without executing REMOVE LINK command.
ADD	HDD added, and awaiting format	Format	
–	Previous time and this time, HDD physically or logically removed		REMOVE LINK command has been previously carried out.

You can implement any of the following operations as necessary.

REMOVE LINK: Logically removes the HDD link.

HDD FORMAT: Formats the HDD.

RESTART: Closes the menu, and restarts the recorder.

The menu can also be displayed manually when you need to format the HDD or remove the logical link.

1. Turn off the power of the recorder once, and turn it on again.
The multiscreen monitor displays the message "SYSTEM CHECK DONE! TO OPEN DISK MENU, PUSH STOP KEY".
2. Press the [STOP] button.
The DISK MENU opens.
3. Select REMOVE LINK, HDD FORMAT, or RESTART.

Auto-remove

When no button is pressed for one minute after opening the DISK MENU, the recorder will logically remove a disk that meets any of the conditions below.

- An HDD has been categorized as " * ", "LOST", or "ERR".
- Restart was repeated 3 times due to writing error.

● Removing Logical Link (REMOVE LINK)

This command logically disconnects the faulty HDD from the recorder and is applicable to an HDD of *, ERR, or LOST status.

You may use this command before physically removing the faulty HDD, or when you continue to operate the system after logically removing the faulty HDD.

1. Display the DISK MENU window.

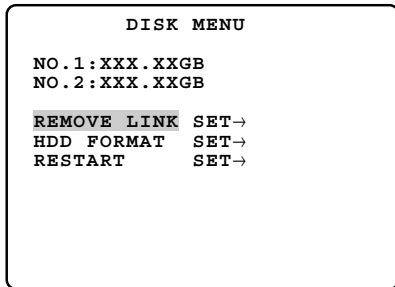

2. Move the cursor to REMOVE LINK.
3. Select YES with the JogDial, and press the JogDial.

YES: Logically removes the faulty HDD.

When **YES** is selected, the display YES will turn to SET DONE for 5 seconds, and the window will return to normal operation.

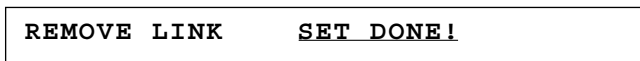
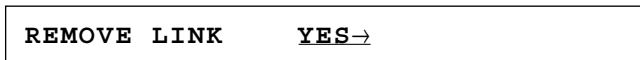

When the [STOP] button is pressed, the window returns to that of step 1.

Select RESTART to return to normal operation.

Note: The window of step 1 appears following the "ERROR" message when this command is used under the conditions below:
 A single HDD or no HDD exists.
 Both HDDs malfunction.

● Formatting HDD (HDD FORMAT)

This command initializes the HDD format and is applicable to HDDs of *, ERR, or ADD status.

Caution: Formatting is an irreversible procedure. We strongly recommend that, before formatting, you either save the recorded data into the server via the network, or you save the data on VCR tapes via the REC OUT terminal.

1. Display the DISK MENU window.

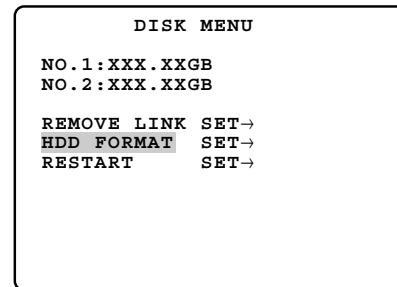

2. Move the cursor to HDD FORMAT, and press the JogDial.
 The password prompt appears.



3. Enter the ALL password using the CAM SELECT buttons 1 through 8. The default password is 12345.



Access to the HDD will be possible if the correct password is entered.

4. Rotate the JogDial to select the HDD you wish to format, and press the JogDial.

1: Formats HDD #1.

2: Formats HDD #2.

ALL: Formats HDD #1 and #2.

The window prompts you to confirm whether the HDD is to be formatted or not.

5. Select YES or NO rotating the JogDial, and press the JogDial.

YES: Carries out formatting. Wait until the process ends.

When **YES** is selected, the display will turn to NOW FORMATTING. It will change to HDD FORMAT → SET DONE when formatting is completed.

NOW FORMATTING

HDD FORMAT SET DONE!

When the [STOP] button is pressed, the window returns to that of step 1.

Select RESTART to return to normal operation.

● Restarting (RESTART)

This command closes the DISK MENU, and returns to normal operation.

1. Display the DISK MENU.

```
DISK MENU
NO.1:XXX.XXGB
NO.2:XXX.XXGB

REMOVE LINK SET→
HDD FORMAT SET→
RESTART SET→
```

2. Move the cursor to RESTART.

RESTART SET→

3. Press the JogDial.

RESTART **NO**

4. Rotate the JogDial to select a restarting parameter.

YES: Escapes from the DISK MENU, and enters normal operation.

PLAY ONLY: Enters a special mode that prohibits recording, but allows playback.

Notes:

- The PLAY ONLY mode can be utilized when you verify a transplanted HDD removed from another disk recorder that malfunctioned.
- In normal operation after selecting the PLAY ONLY mode, "STOP (PO)" appears in the status display while camera pictures are displayed, but not in playback. "PO" stands for PLAY ONLY.

5. Press the JogDial to execute the selection, or press the [STOP] button to return to the above step 1.

A message "SET DONE!" appears, and the recorder restarts.

RESTART **SET DONE**

Notes:

- Follow the procedures described above when the DISK MENU appears again after restarting. This happens when the settings have been changed.
- To cancel the PLAY ONLY mode, follow these procedures described above and select YES for RESTART.

■ Mail Contents

The recorder sends e-mails to the specified addresses when SEND MAIL is set to ON. An e-mail contains the following information.

● Alarm Notice Mail

A JPEG image file with an HTML file will be sent when specified to attach.

WJ-HD220 (Sender IP Address) STATUS REPORT	
DATE:	Jan31.03 00:00:00
PORT:	nCH
URL:	http://Sender IP address:Port Number/

Note: URL is displayed when DDNS is applied. The port number except 80 is displayed.

● Error Notice Mail

WJ-HD220 (Sender IP Address) STATUS REPORT	
DATE:	Jan31.03 00:00:00
STATUS:	Abbreviated Cause
URL:	http://Sender IP address:Port Number/

Note: URL is displayed when DDNS is applied. The port number except 80 is displayed.

Abbreviation	Cause
THERMAL ERROR	Out of operating temperature range
DISK WARNING OF "DiskType"	S.M.A.R.T. detected error on HDD. "DiskType" MASTER: Error on HDD1 SLAVE: Error on HDD2
REMAINS HDD CAPACITY **%	Warning on remaining HDD capacity (**%). An e-mail is sent when the remaining capacity drops below the preset value for HDD FULL. Until DISK END status is rest, an e-mail is sent every time the capacity is reduced by 1 %. A remaining capacity of less than 1 % will be rounded to 0 %.
HDD IS FULL	Resetting the DISK END status is needed to resume recording.
"DiskType" IS LOGICALLY REMOVED	The type of disk has failed and has been logically removed. "DiskType" MASTER: Error on HDD1 SLAVE: Error on HDD2
VIDEO LOSS nCH	Video loss is detected on channel "n". Repair the camera or cable disconnection.
NO "Type" RECORD DUE TO FULL DISK	Alarm-recording triggered by "Type" was not possible due to shortage of the space. "Type" VMD TRIGGERED: VMD alarm TERMINAL TRIGGERED: Terminal alarm PC TRIGGERED: PC alarm
UNDEFINED ERROR	Errors other than the above have occurred

■ Network Security

● WJ-HD220 Security Function

Host/User Authentication

Access can be limited by setting the authentication function to ON in the menu setup.

Note: Be sure to change the password from the default setting "admin" to your own.

Changing the HTTP Port Number

Changing the port number will limit unauthorized accesses such as port scanning.

● For More Security

Using Routers

Authentication is doubled by use of routers: dividing into subnet, and verifying IP addresses by the recorder and the routers.

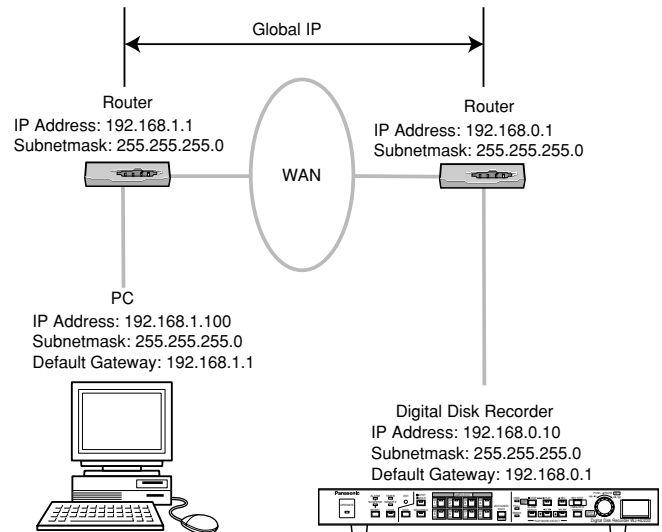

Using Fire Wall

A fire wall will apply packet filtering and protocol filtering to secure the recorder against unauthorized access.

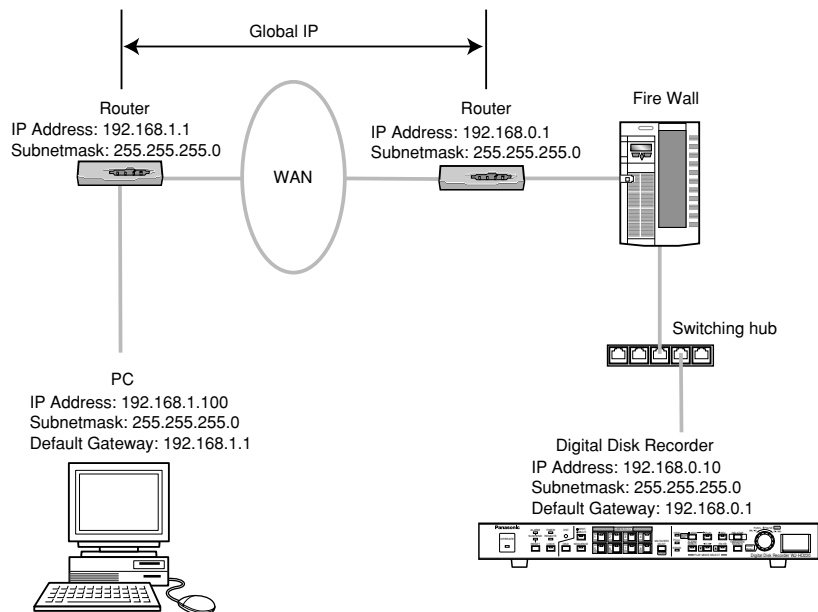

■ Network Error Information

● SMTP Errors

Type	Message	Details
POP3 server error	Authentication error (POP3)	User name or password may be incorrect. Reconfirm mail settings.
	Cannot connect to POP3 server	<ul style="list-style-type: none">• IP address for the server may be incorrect. Reconfirm settings.• POP3 server may be out of order. Ask your system administrator.
SMTP server error	Connection error to DNS server (Cannot resolve server name)	<ul style="list-style-type: none">• Designation for DNS server may be incorrect. Reconfirm DNS settings.• DNS server may be out of order. Ask your system administrator.
	Cannot connect to SMTP server	<ul style="list-style-type: none">• IP address for the server may be incorrect. Reconfirm address settings.• SMTP server may be out of order. Ask your system administrator.
Connection error	MAIL FROM command error	Sender mail address may be incorrect. Reconfirm address settings.
	RCPT TO command error	Destination mail address may be incorrect. Reconfirm address settings.
Internal error	Undefined error	Some trouble with the mailing functions. Reconfirm mail settings.

● FTP Errors

Type	Message	Details
FTP server error	Connection error to DNS server (Cannot resolve server name)	<ul style="list-style-type: none">• Designation for DNS server may be incorrect. Reconfirm DNS settings.• DNS server may be out of order. Ask your system administrator.
	Cannot connect to FTP server	<ul style="list-style-type: none">• IP address for the server may be incorrect. Reconfirm address settings.• FTP server may be out of order. Ask your system administrator.

(To be continued)

● FTP Errors

Type	Message	Details
Connection error	File transfer error	File transfer may have failed. Reconfirm network connection status.
	Passive mode error	FTP error occurred in passive mode. Reconfirm settings for FTP client.
	Log-out failed	Errors occurred regarding server connection. Ask your system administrator.
	Directory change failed	Settings for file directory may be incorrect. Reconfirm settings for FTP client.
	User name or password incorrect	User name or password may be incorrect. Reconfirm settings for FTP client.
Internal error	Undefined command error	Command error occurred regarding server connection. Ask your system administrator.
	Undefined error	Some trouble with file transfer functions. Reconfirm settings for FTP client.

● DDNS Errors

Type	Message	Details
DNS server error	Connection error to DNS server (Cannot resolve server name)	<ul style="list-style-type: none">• Designation for DNS server may be incorrect. Reconfirm DNS settings.• DNS server may malfunction. Ask your system administrator.
Connection error	Cannot connect to DDNS server	<ul style="list-style-type: none">• IP address for the server may be incorrect. Reconfirm settings for IP address.• DDNS server may malfunction. Ask your system administrator.
	User name or password incorrect	User name or password may be incorrect. Reconfirm settings for DDNS.
	IP address update failed	DDNS settings may be incorrect. Reconfirm settings for DDNS.
Internal error	Undefined error	Some trouble with DDNS functions. Reconfirm settings for DDNS.

Panasonic System Solutions Company,
Unit Company of Panasonic Corporation of North America

Security Systems

www.panasonic.com/security

For customer support, call 1.877.733.3689

Executive Office: Three Panasonic Way 2H-2, Secaucus, New Jersey 07094

Zone Office

Eastern: Three Panasonic Way, Secaucus, New Jersey 07094

Central: 1707 N. Randal Road, Elgin, IL 60123

Southern: 1225 Northbrook Parkway, Suwanee, GA 30024

Western: 6550 Katella Ave., Cypress, CA 90630

Panasonic Canada Inc.

5770 Ambler Drive, Mississauga,

Ontario, L4W 2T3 Canada (905)624-5010

<http://www.panasonic.ca>

Panasonic Sales Company

Division of Panasonic Puerto Rico Inc.

San Gabriel Industrial Park 65th Infantry Ave. KM. 9.5 Carolina

P.R. 00985(809)750-4300

Free Manuals Download Website

<http://myh66.com>

<http://usermanuals.us>

<http://www.somanuals.com>

<http://www.4manuals.cc>

<http://www.manual-lib.com>

<http://www.404manual.com>

<http://www.luxmanual.com>

<http://aubethermostatmanual.com>

Golf course search by state

<http://golfingnear.com>

Email search by domain

<http://emailbydomain.com>

Auto manuals search

<http://auto.somanuals.com>

TV manuals search

<http://tv.somanuals.com>