

# Panasonic®



Omnivision VL

## DVD/VCR DECK Operating Instructions Model No. PV-D4763S



### MULTI FORMAT PLAYBACK



\*Ability to play back may depend on recording conditions.

LSQT0676A

# Important Safeguards and Precautions

**FOR YOUR SAFETY, READ AND RETAIN ALL SAFETY AND OPERATING INSTRUCTIONS. HEED ALL WARNINGS IN THE MANUAL AND ON THE UNIT**

## INSTALLATION

### 1 POWER SOURCE CAUTION

Operate only from a power source indicated on the unit or in this manual. If necessary, have your Electric Utility Service Company or Video Products Dealer verify the power source in your home.

### 2 POLARIZED OR GROUNDING PLUG

As a safety feature, this product comes with either a polarized power cord plug (one blade is wider than the other), or a three-wire grounding type plug.

### POLARIZED PLUG CAUTION:

This plug will only fit into an outlet one way. If you cannot fully insert the plug, try reversing it. If it still will not fit, have an electrician install the proper wall outlet. Do not defeat the safety feature by tampering with the plug.

### GROUNDING PLUG CAUTION:

This plug will only fit into a three-hole grounding outlet. If necessary, have an electrician install the proper outlet. Do not defeat the safety feature by tampering with the plug.

### 3 POWER CORD

Make sure power cords are routed so that they are not likely to have anything rest on them, roll over them, or be in the way of walking traffic. If an extension cord is used, make sure it also has either a polarized or grounded plug and that the cords can be securely connected. Frayed cords, damaged plugs, and damaged or cracked wire insulation are hazardous and should be replaced by a qualified service technician. Overloaded outlets and extension cords are fire hazards and should be avoided.

### 4 DO NOT BLOCK VENTILATION HOLES

Ventilation openings in the cabinet release heat generated during operation. If they are blocked, heat build-up inside the unit can cause failures that may result in a fire hazard or heat damage to cassettes or discs.

For protection, follow these rules:

- Never cover ventilation slots or the unit while in use, or operate the unit when placed on a bed, sofa, rug, or other soft surface.
- Avoid built-in installation, such as a book case or rack, unless proper ventilation is provided.

### 5 PLACEMENT: AVOID EXTREMELY HOT LOCATIONS OR SUDDEN TEMPERATURE CHANGES

Do not place the unit over or near heater or radiator, in direct sunlight, inside closed vehicles, in high temperature [over 104°F (40°C)], or in over 75% humidity. If the unit is suddenly moved from a cold place to a warm one, moisture may condense in the unit and on the tape causing damage. Never subject the unit to vibration, impact, or place it so that the surface is tilted as internal parts may be seriously damaged.

### 6 TO AVOID PERSONAL INJURY

- Do not place unsecured equipment on a sloping surface.
- Do not place this unit on any support that is not firm, level, and adequately strong. The unit could fall causing serious injury to a child or adult and damage to the unit.
- An appliance and cart combination should be moved with care. Quick stops, excessive force, and uneven surfaces may cause the appliance and cart combination to overturn.
- Carefully follow all operating instructions and use the manufacturer's recommended accessories when operating this unit or connecting it to any other equipment.



## OUTDOOR ANTENNA INSTALLATION

### 1 SAFE ANTENNA AND CABLE CONNECTION

If an outside antenna or cable system is connected to the equipment, be sure the antenna or cable system is grounded so as to provide some protection against built up static charges and voltage surges.

Section 810 of the National Electrical Code, ANSI/NFPA 70 (in Canada, part 1 of the Canadian Electrical Code) provides information with respect to proper grounding of the mast and supporting structure, grounding of the lead-in wire to an antenna discharge unit, size of grounding conductors, location of antenna discharge unit, connection to grounding electrodes and requirements for the grounding electrode.

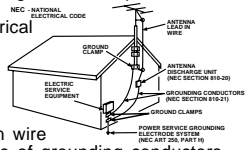

### 2 KEEP ANTENNA CLEAR OF HIGH VOLTAGE POWER LINES OR CIRCUITS

An outside antenna system should be located well away from power lines, electric light or power circuits and where it will never come into contact with these power sources if it should happen to fall. When installing an outside antenna, extreme care should be taken to avoid touching power lines, circuits or other power sources as this could be fatal. Because of the hazards involved, antenna installation should be left to a professional.

## USING THE UNIT

If the unit has been in storage or moved to a new location, refer first to the INSTALLATION section of these safeguards.

### 1 KEEP THE UNIT AWAY FROM WATER OR MOISTURE OF ANY KIND.

**2 IF EQUIPMENT IS EXPOSED TO RAIN, MOISTURE, OR STRONG IMPACT**, unplug the unit and have it inspected by a qualified service technician before use.

### 3 DURING AN ELECTRICAL STORM

During a lightning storm, whether indoors or outdoors, or before leaving the unit unused for extended periods of time, disconnect all equipment from the power source as well as the antenna and cable system.

### 4 WHEN THE UNIT IS PLUGGED IN

- Never expose the unit to rain or water. **DO NOT OPERATE** if liquid has been spilled into the unit. Immediately unplug the unit, and have it inspected by a service technician. Fire and shock hazards can result from electrical shorts caused by liquid contact inside.
- Never drop or push any object through openings in the unit. Some internal parts carry hazardous voltages and contact can cause electric shock or fire hazard. Do not put any foreign object on the disc tray.
- Avoid placing the unit directly above or below your TV set as this may cause electrical interference. Keep all magnets away from electronic equipment.

### 5 USING ACCESSORIES

Use only accessories recommended by the manufacturer to avoid risk of fire, shock, or other hazards.

### 6 CLEANING THE UNIT

Unplug the unit. Then, use a clean, dry, chemically untreated cloth to gently remove dust or debris. **DO NOT USE** cleaning fluids, aerosols, or forced air that could over-spray, or seep into the unit and cause electrical shock. Any substance such as wax, adhesive tape, etc. may mar the cabinet surface. Exposure to greasy, humid, or dusty areas may adversely affect internal parts.

## SERVICE

### 1 DO NOT SERVICE THIS PRODUCT YOURSELF

If, after carefully following the detailed operating instructions, this product does not operate properly, do not attempt to open or remove covers, or make any adjustments not described in the manual. Unplug the unit and contact a qualified service technician.

### 2 IF REPLACEMENT PARTS ARE REQUIRED

Make sure the service technician uses only parts specified by the manufacturer, or those having the same safety characteristics as the original parts. The use of unauthorized substitutes may result in fire, electric shock, or other hazards.

### 3 HAVE THE SERVICE TECHNICIAN PERFORM A SAFETY CHECK

After any service or repairs to the unit, request the service technician to conduct a thorough safety check as described in the manufacturer's service literature to ensure that the unit is in safe operating condition.

# Safety Precautions/Mesures de sécurité

**WARNING:** To prevent fire or shock hazard, do not expose this equipment to rain or moisture.

**CAUTION:** To prevent electric shock, match wide blade of plug to wide slot, fully insert.

**Avertissement:** Afin de prévenir tout risque d'incendie ou de chocs électriques, ne pas exposer cet appareil à la pluie ou à une humidité excessive.

**Attention:** Pour éviter les chocs électriques, introduire la lame la plus large de la fiche dans la borne correspondante de la prise et pousser jusqu'au fond.

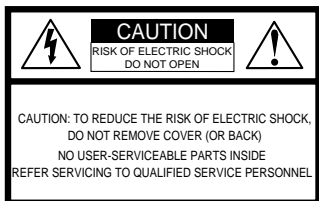

This symbol warns the user that uninsulated voltage within the unit may have sufficient magnitude to cause electric shock.

Therefore, it is dangerous to make any kind of contact with any inside part of this unit.



This symbol alerts the user that important literature concerning the operation and maintenance of this unit has been included. Therefore, it should be read carefully in order to avoid any problems.

## CAUTION:

UNIT IS A CLASS I LASER PRODUCT.  
HOWEVER THIS UNIT USES A VISIBLE LASER BEAM WHICH COULD CAUSE HAZARDOUS RADIATION EXPOSURE IF DIRECTED.  
BE SURE TO OPERATE THE UNIT CORRECTLY AS INSTRUCTED.

WHEN THIS UNIT IS PLUGGED TO THE WALL OUTLET, DO NOT PLACE YOUR EYES CLOSE TO THE OPENING OF THE DISC TRAY AND OTHER OPENINGS TO LOOK INTO THE INSIDE OF THIS UNIT.

USE OF CONTROLS OR ADJUSTMENTS OR PERFORMANCE OF PROCEDURES OTHER THAN THOSE SPECIFIED HEREIN MAY RESULT IN HAZARDOUS RADIATION EXPOSURE.

DO NOT OPEN COVERS AND DO NOT ATTEMPT TO REPAIR YOURSELF. REFER SERVICING TO QUALIFIED PERSONNEL.

## CAUTION:

LASER RADIATION  
WHEN OPEN DO NOT  
STARE INTO BEAM.

## ATTENTION:

RAYONNEMENT  
LASER EN CAS  
D'OUVERTURE.  
NE PAS REGARDER  
DANS LE FAISCEAU.

(Inside of product)

## FCC NOTE:

This equipment has been tested and found to comply with part 15 of the FCC Rules. These limits are designed to provide reasonable protection against harmful interference when operated in a residential environment. If this equipment does cause interference to radio or television reception, which can be determined by turning the equipment off and on, use the equipment in another location and/or utilize an electrical outlet different from that used by the receiver.

If necessary, consult the dealer or an experienced radio/TV technician for help. The user may find the booklet, "Something About Interference" available from FCC local regional offices helpful.

## FCC Caution:

To assure continued compliance, (example- use only shielded interface cables when connecting to other devices.) Any changes or modifications not expressly approved by the party responsible for compliance could void the user's authority to operate this equipment.

**FCC Warning:** Any unauthorized changes or modifications to this equipment would void the user's authority to operate.

## Region Management Information:

This DECK is designed and manufactured to respond to the Region Management Information that is recorded on a DVD disc. If the Region number described on the DVD disc does not correspond to the Region number of this DECK, this DECK cannot play this disc.

- The Region number for this DECK is "1".
- The Player will play DVD-Video marked with labels containing "1" or "ALL".

Example:



# Before Using

## Congratulations

on your purchase of one of the most sophisticated and reliable products on the market today. Used properly, it will bring you years of enjoyment. Please fill in the information below. The serial number is on the tag located on the back of your DECK.

- Date of Purchase \_\_\_\_\_
- Dealer Purchased From \_\_\_\_\_
- Dealer Address \_\_\_\_\_
- Dealer Phone No. \_\_\_\_\_
- Model No. **PV-D4763S** \_\_\_\_\_
- Serial No. \_\_\_\_\_

## Accessories

- Remote Control LSSQ0377
- Batteries 2 "AA"

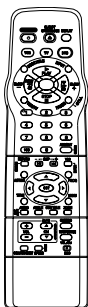

- RF Coaxial Cable LSJA0372



To order accessories, call toll free 1-800-332-5368.

## Loading the Batteries

- 1) Open cover.
- 2) Insert batteries as marked.
- 3) Close cover.

- Battery replacement caution**
- Do not mix old and new batteries.
- Do not mix alkaline with manganese batteries.

## Record/ Playback Time

Only use tapes with the **VHS** mark in this DECK.

Tape Speed Setting	Type of Video Cassette		
	T60	T120	T160
SP (Standard Play)	1 Hour	2 Hours	2 Hours 40 Minutes
LP (Long Play)	2 Hours	4 Hours	5 Hours 20 Minutes
SLP (Super Long Play)	3 Hours	6 Hours	8 Hours

## Head Cleaning

Playing older or damaged tapes may eventually cause video heads to become clogged.

### Video Head Clog Sensor

During playback, this screen appears if clogging is detected. To remove screen, press **PLAY** on the remote or DECK.

VIDEO HEADS MAY NEED CLEANING PLEASE INSERT HEAD CLEANING CASSETTE OR REFER TO MANUAL

END :PLAY

- Use "dry" type head cleaning cassette only. (Part No. NV-TCL30PT is recommended.)
- Follow cleaning tape instructions carefully. Excessive use of tape can shorten head life.
- If head clog symptoms persist, contact your nearest servicenter by visiting our Web Site (see p. 65).

## Built-in Head Cleaner

A clean video head helps produce a clear picture. So, we have equipped your DECK with a built-in, non-chemical head cleaning system that helps prevent clogging of the video heads. Cleaning is performed each time you load or unload a video cassette.

- This feature is preventative only. If your video heads are seriously clogged, consider the use of a chemical non-abrasive head cleaning kit or take your DECK to a Servicenter.

## Features for a Quality Picture (VCR)

### Digital Auto Picture

Automatically controls the video output signal for less noise depending on the tape condition.

### Digital Auto Tracking

Continuously analyzes the signal and adjusts for optimum picture quality.

### Manual Tracking Control (to reduce picture noise)

Use during Playback and Slow Motion mode to reduce picture noise.

Press **CH (TRACKING)** ▲/▼ on the remote control or on DECK until the picture clears up.

To return to Auto Tracking, press **POWER** off, then on again a few seconds later.



### V-Lock Control (to reduce picture jitter)

In Still mode, **CH (TRACKING)** ▲/▼ operate as a V-Lock control.

# Table of Contents

## DVD / VCR

Important Safeguards and Precautions	2, 3
Before Using	4
DECK / Disc / Cassette Information	6, 7
Location of Controls	8 ~ 10
Displays (On Screen Displays and Multi Function Display)	11
Connections	12 ~ 15
Initial Setup for Basic Connections (Ready to Play)	16, 17

## VCR

Reset Language, Channels, Clock, VCR's Output Channel	18, 19
Playback/ Record on a Tape	20, 21

## DVD

Basic DVD Operation	22, 23
---------------------	--------

Timer Recording	24, 25
MTS Broadcast/ VHS Hi-Fi Stereo System	26, 27
Multi-Brand Control Feature	28, 29
Tape Operation (Search System)	30 ~ 32
Special VCR Features	33, 34
Copying Your Tapes (Dubbing)	35

Disc Operation	36 ~ 41
DVD-RAM Operation (DVD-RAM only)	42, 43
DVD Operation using On-Screen Displays	44 ~ 48
MP3/WMA/JPEG Playback Operation	49 ~ 51
DVD Lock Feature	52
Settings for DVD Operation	53 ~ 57
SD Card	58, 59
Language Code List	60

## DVD / VCR

Warning and Instruction Displays	61
Before Requesting Service	62, 63
Limited Warranty	64, 65
Customer Services Directory	65
Spanish (Español) Quick Use Guide	66 ~ 71
Index	BC

Initial Setup  
(Connection)

Basic  
Operation

VCR  
Operation

DVD  
Operation

For Your  
Information

# DECK / Disc / Cassette Information

## Prevent Accidental Tape Erasure

Break off the tab to prevent recording.

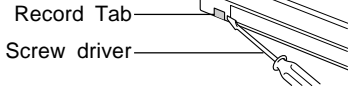

To record again

Cover the hole with cellophane tape.

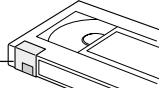

## Cleaning DECK

Use a soft cloth or dusting attachment of a vacuum cleaner to remove dust from the ventilation holes on the back sides and bottom of the cabinet. Plastic surfaces are easily scratched and can be marred by alcohol and various solvents. Avoid excessive use of oil-based furniture polishes since the materials used in the cabinet will accumulate more dust. We recommend using a non-abrasive, antistatic cleaner and polisher.

## Disc formats supported by this DECK

DECK can play back discs bearing any of the following marks:

Logo	Disc type
	DVD-RAM (Version 1.1 of the Video Recording Format a unified video recording standard)
	DVD (DVD-Video)
	DVD-R (DVD-Video formatted discs [finalized])
	DVD-Audio
	Video CD
	CD (CD-DA) CD-R/CD-RW (CD-DA, Video CD formatted discs [finalized]) WMA, MP3, JPEG

[Discs Played 8cm (3") or 12cm (5")]

### Discs which cannot be played

- DVD with Region No. other than "1" or "ALL"
- PAL discs (the audio on DVD-Audio can be played), DVD-ROM, DVD-RW, DVD+RW, CD-ROM, CDV, CD-G, CVD, SVCD, SACD, Divx Video Disc and Photo-CD

## DVD-RAM discs

DVD-RAM discs must meet the following conditions for this unit to be able to play them.

Type	<ul style="list-style-type: none"> <li>• Non-cartridge discs</li> <li>• Discs that can be removed from their cartridges (TYPE 2 and 4)</li> </ul>
Capacity	<ul style="list-style-type: none"> <li>• 12 cm (5") 9.4 GB (double-sided) and 4.7 GB (single-sided)</li> <li>• 8 cm (3") 2.8 GB (double-sided)</li> </ul>

- Remove TYPE 2 and 4 discs from their cartridges before use, then return them when you are finished. Read the instructions for the disc carefully.

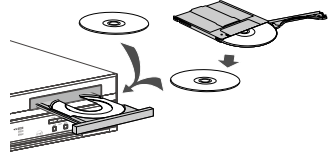

- Some parts of the disc, for example where one program ends and another begins, may not play smoothly.

## Specifications

<b>Power Source:</b>	120 V AC, 60 Hz
<b>Power Consumption:</b>	Power On: Approx. 32 watts, Power Off: Approx. 4 watts
<b>Video Signal:</b>	EIA Standard NTSC color
<b>Video Recording System:</b>	4 rotary heads helical scanning system
<b>Audio Track:</b>	1 track (Normal), 2 channel (Hi-Fi Audio Sound)
<b>Tuner:</b>	
<b>Broadcast Channels:</b>	VHF 2 ~ 13, UHF 14 ~ 69
<b>CABLE Channels:</b>	Midband A through I (14 ~ 22), Superband J through W (23 ~ 36) Hyperband AA ~ EEE (37 ~ 64), Lowband A-5 ~ A-1 (95 ~ 99) Special CABLE channel 5A (01), Ultraband 65 ~ 94, 100 ~ 125
<b>Input/Output Terminal:</b>	Audio/Video Line Input/Output, RF Input/Output
<b>Input Terminal:</b>	Audio/Video Line Input (Front)
<b>Output Terminal:</b>	S-Video Output (DVD only), Component Video Output (DVD only) Audio Output 2 (L), (R)
<b>Operating Temperature:</b>	5 °C ~ 40 °C (41 °F ~ 104 °F)
<b>Operating Humidity:</b>	10 % ~ 75 %
<b>Weight:</b>	4.9 kg (10.8 lbs).
<b>Dimensions:</b>	430 (W) x 95.5 (H) x 344 (D) mm 16-15/16" (W) x 3-12/16" (H) x 13-9/16" (D) inch
<b>Discs Played</b>	
<b>(1) DVD-Video Disc</b>	5" (12 cm) single-sided single-layer
<b>DVD-Audio Disc</b>	5" (12 cm) single-sided double-layer 5" (12 cm) double-sided double-layer (one layer per side)
<b>DVD-RAM Disc</b>	3" (8 cm) single-sided single-layer 3" (8 cm) single-sided double-layer 3" (8 cm) double-sided double-layer (one layer per side)
	5" (12 cm) 9.4 GB (double-sided) and 4.7 GB (single-sided) 3" (8 cm) 2.8 GB (double-sided)
<b>(2) Compact Disc</b>	5" (12 cm) disc
(CD-DA, Video CD)	3" (8 cm) disc
(CD-R/CD-RW, MP3, WMA, JPEG)	
<b>Digital Audio Output:</b>	Digital Optical Connector
<b>Pickup:</b>	Wavelength: 655 nm (DVD), 790 nm (Video CD/CD) Laser power: CLASS II

Note: • Designs and specifications are subject to change without notice.

## Definition of Terms (DVD)

<b>Angle:</b>	Some DVD discs feature scenes simultaneously shot from different angles. The ANGLE button can be used to view the scene from different angles. (ANGLE Indicator lights on DECK when a scene recorded at different angles is detected.)
<b>Chapter Number:</b>	Titles are subdivided into numbered sections. You can quickly search for a favorite scene using these numbers.
<b>DVD:</b>	A high-density optical disc on which high-quality pictures and sound have been digitally recorded. DVD incorporates new video compression technology (MPEG II) and high-density recording technology which allow entire movies to be recorded with incredible playback quality.
<b>Playback Control:</b>	With Video CD (version 2.0), scenes or information may be selected for viewing or listening from an interactive menu that appears on the TV screen.
<b>Subtitles:</b>	Written dialogue which appears at the bottom of the screen.
<b>Time Number:</b>	The elapsed play time from the start of a disc or title. Use to quickly find scenes. (May not work with some discs.)
<b>Title Number:</b>	For DVD discs with two or more titles, the title is numbered as title 1, title 2, etc.
<b>Track Number:</b>	Numbers assigned to tracks on Video CDs and CDs to allow specific tracks to be quickly located.
<b>Video CD:</b>	CD containing picture and sound with same quality level as video tape. This DECK also supports Video CDs with playback control (version 2.0).

Apparatus Claims of U.S. Patent Nos. 4,631,603, 4,577,216, 4,819,098 and 4,907,093, licensed for limited viewing uses only.

This product incorporates copyright protection technology that is protected by method claims of certain U.S. Patents and other intellectual property rights owned by Macrovision Corporation and other rights owners. Use of this copyright protection technology must be authorized by Macrovision Corporation, and is intended for home and other limited viewing uses only unless otherwise authorized by Macrovision Corporation. Reverse engineering or disassembly is prohibited.

# Location of Controls

## Remote Control

EJECT/OPEN / CLOSE

pp. 20

**Bold:** VCR Function  
*Italic:* DVD Function  
***Bold Italic:*** VCR and DVD Functions  
**Normal:** Others

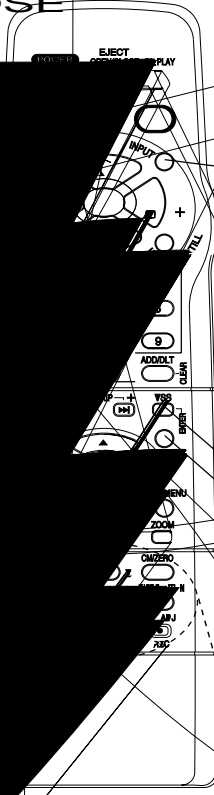

44

28

**SLOW+**  
pp. 20,

**STOP**  
22

ENTER  
28

**PROGRAM** p. 24

**SELECT**

▼  
MENU /

38, 43

**COMMERCIAL SKIP  
ZERO SEARCH**  
pp. 31, 32

▼  
pp. 4, 21

TAPE POSITION

RECORD  
p. 21

When this button is pressed in VCR mode, the tape is ejected.  
This button is inoperative if pressed during recording.  
When pressed in DVD mode, the disc tray opens or closes.



## Front View of DECK

**Bold:** VCR Function  
*Italic:* DVD Function  
***Bold Italic:*** VCR and DVD Functions  
 Normal: Others

**STOP/EJECT**  
p. 20

**FAST FORWARD/SEARCH**  
p. 20

**PLAY**  
p. 20

**REWIND/SEARCH**  
p. 20

Remote  
Sensor

**POWER**

**Audio/Video  
Input Connector 2  
(LINE 2)** p. 35

**CHANNEL ▲/▼  
TRACKING/V-LOCK**  
pp. 4, 21

**REC**  
p. 21

**Cassette  
Compartment**

*Disc Tray*

**OPEN/CLOSE**  
p. 22

**Multi Function  
Display**  
p. 11

**SD Card slot**  
p. 58

**PROGRESSIVE**  
p. 10

**PAUSE**  
p. 23

**SKIP ►►**  
**SKIP ◄◄**  
p. 23

**PLAY**  
p. 22

**STOP**  
p. 22

**If the disc cannot be removed...**  
 First, unplug DECK. Then, prepare a rigid wire (e.g. an extended paper clip) and, applying moderate force, insert it straight into the hole at the base of the tray. The tray will eject a little. Now, pull the tray all the way out and remove the disc.

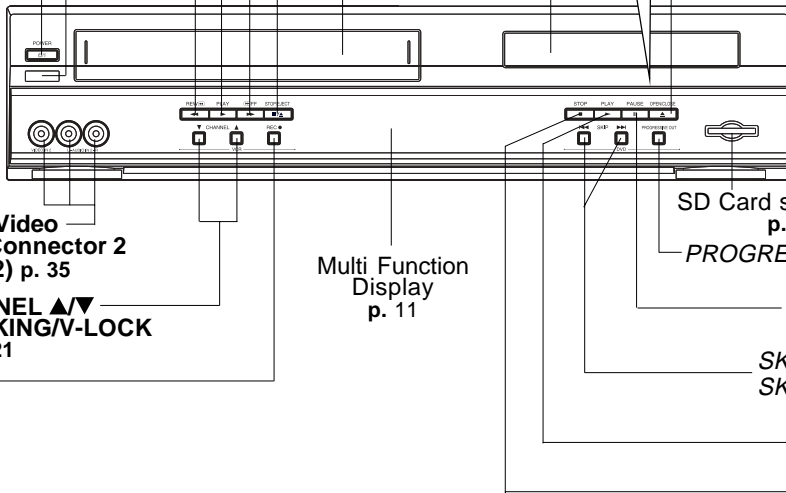
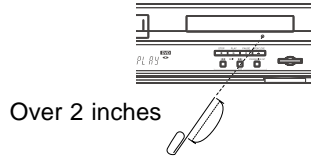

## Reset All Memory Functions

Use when moving DECK to new location, or if a mistake was made in the Initial Setup section (return to Factory Setting).

• Make sure a tape is not inserted in the DECK.

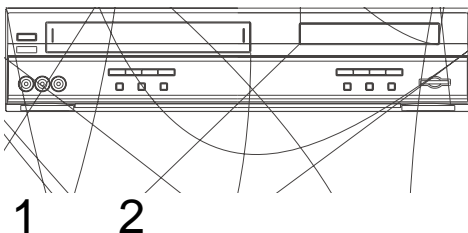

- 1 Turn DECK Power on.
- 2 Press and hold both **VCR PLAY** and **CHANNEL ▲** on the DECK for more than 5 seconds.
  - The power shuts off.
- 3 Do "Initial Setup (Ready to Play)" on page 16.

# Location of Controls (continued)

## Rear View of DECK

**Bold:** VCR Function

*Italic:* DVD Function

**Bold Italic:** VCR and DVD Functions

### AC Power Plug

- While plugged into an AC outlet, this DECK consumes 4 W of electrical power in off mode.

*Component Video Output Connector (Y, P<sub>B</sub>, P<sub>R</sub>) (DVD Only)*  
**p. 13**

*5.1ch Analog Audio Output Connector (CENTER, SUB WOOFER, SURROUND L/R, FRONT L/R) (DVD Only)*  
**p. 15**

**VHF/UHF Antenna Output Terminal**  
**p. 12**

**VHF/UHF Antenna Input Terminal**  
**p. 12**

**Video Output Connector**  
**p. 12**

**Video Input Connector**  
**p. 35**

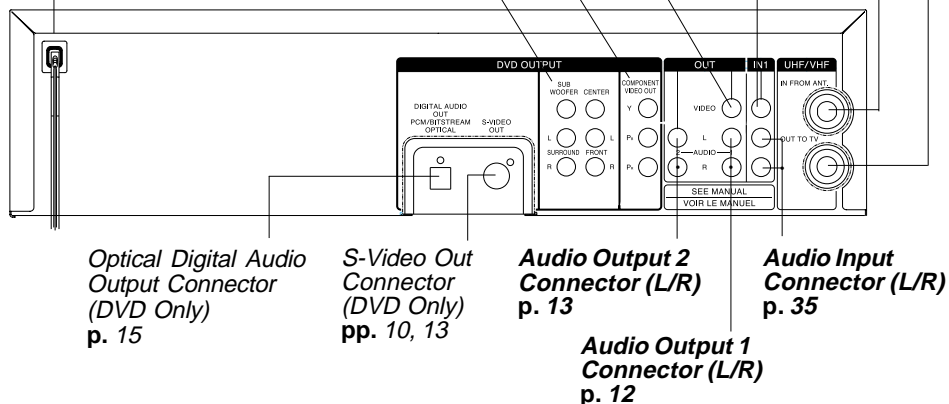

The following table shows the status of the output jacks when in VCR or DVD mode.

	<b>Video Output Audio Out 1 Audio Out 2</b>	<i>Component Video Output</i>	<i>S-VIDEO OUT</i>
<b>VCR</b>	YES	N/A	N/A
<i>DVD</i>	YES	YES	

- Note** • PROG functions on the remote are not available when using Component Video Output and S-VIDEO OUT. Please set TV to either RF INPUT or VIDEO INPUT, and then press PROG.

### To enjoy PROGRESSIVE SCAN video

- (1) Connect *Component Video Output* to the component video input terminals of a television. (See p. 13.)
- (2) When the PROGRESSIVE button is pressed, the ON lamp lights up (see p. 9) and the PROGRESSIVE SCAN signal is output from the *Component Video Output Connector*.

#### Notes

- The PROGRESSIVE button can be operated when the DECK is in DVD function mode.
- The screen may shift off-center when using progressive output. Please adjust the screen position if this occurs. (Refer to your TV manual.)
- The DECK outputs video signals (not PROGRESSIVE SCAN) from the "VIDEO OUT" and "S-VIDEO OUT" terminals when the ON lamp is lit.

# Displays (On Screen & Multi Function)

## On Screen Displays (VCR)

### Function & Channel Displays

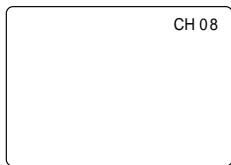

When a function button is pressed, e.g. PLAY, or you change channels, a 5-second display appears.

### Blank Tape/ No Video Signal Indications

Whenever a blank section of a tape comes up in Play mode, or when the selected channel has no broadcast signal with Weak Signal Display Feature (p. 33) set to OFF, the TV screen will turn solid blue.

### VCR Status & Clock Displays

To display or remove overlay at right,

→ press DISPLAY.

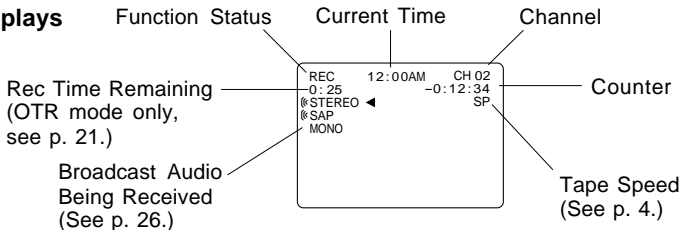

## Multi Function Display

### VCR mode Indicator

Lights up when DECK is VCR mode.

### Tape Indicator

Lights up when a tape is inserted.

### DISC Indicator

Lights up when a disc is inserted.

### DVD mode Indicator

Lights up when DECK is DVD mode.

### Timer Indicator

Lights up when DECK is set for Timer Recording, or when One Touch Recording (OTR) is used. Flashes when Timer Recording is set, but a tape has not been inserted into DECK and when a power interruption occurs during Timer Programming.

### VCR REC Indicator

Lights up during recording.

### CD/MP3/WMA Indicator

CD : Lights when a Video or Audio CD is inserted.  
MP3/WMA : Lights when an MP3 or WMA file is played.

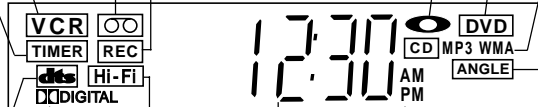

### DTS Indicator

Lights up when DTS formatted DVD is played. (DVD only)

### Hi-Fi Indicator

Lights up when Hi-Fi audio is monitored in Play mode.

### AM/PM Indicator

### Clock/ Status/ Channel/ Speed Display

Displays the current time. Briefly displays DECK status when a function button is pressed. Briefly displays the channel number, or "L1" or "L2" when a channel or line input is selected. Briefly displays the recording speed when SPEED is pressed.

### ANGLE Indicator

Lights up when a scene recorded at different angles is detected. (See p. 37.) (DVD only).

### Dolby Digital Indicator

Lights up when "Dolby Digital" formatted DVD is played. (DVD only)

# Connections

## Basic Connections

- If your TV has AUDIO and VIDEO IN terminals, connect them to DECK for higher quality picture and sound.
- You can enjoy stereo sound even if your TV is not stereo by connecting a stereo amplifier to DECK.
- Connect DECK and TV with an RF Coaxial Cable (a) (supplied) or an AV Cable (b) (not supplied) as shown in the figure below.

### ■ DSS Receiver → DECK → TV    ■ DECK → TV    ■ Cable Box → DECK → TV

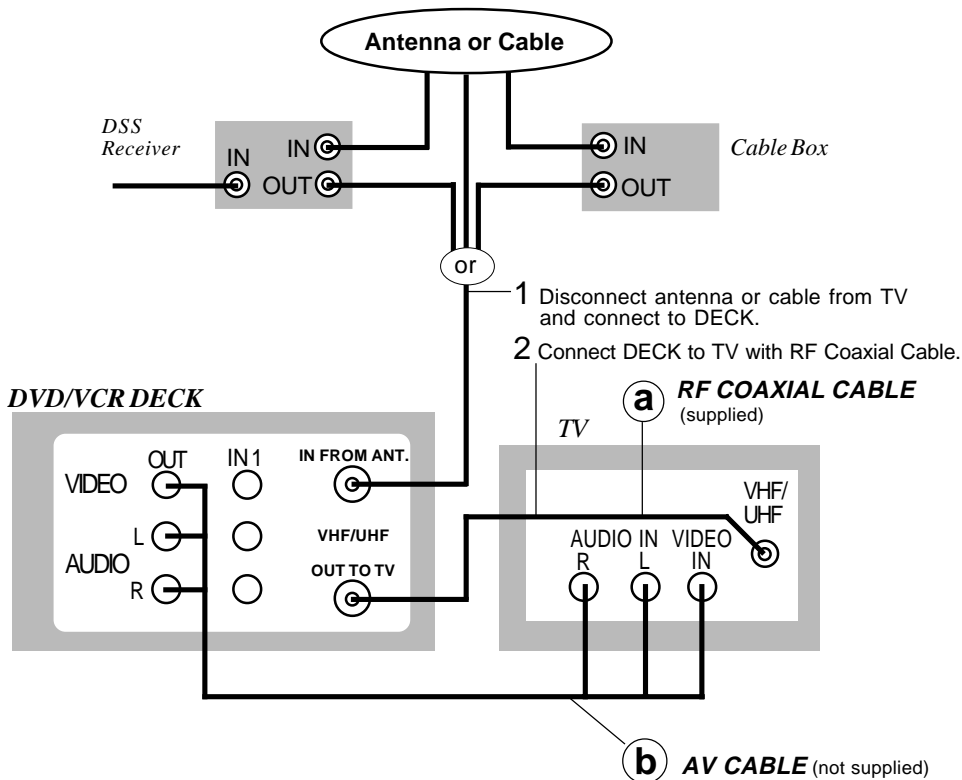

#### WARNING

When using "Nut type" RF coaxial cables, tighten with fingers only. Overtightening may damage terminals.

#### Note to CABLE system installer

This reminder is provided to call the CABLE system installer's attention to Article 820-40 of the NEC in USA (and to the Canadian Electrical Code in Canada) that provides guidelines for proper grounding and, in particular, specifies that the cable ground shall be connected to the grounding system of the building, as close to the point of cable entry as practical.

## Other Connections

### ■ With a Cable Box (DECK → Cable Box → TV)

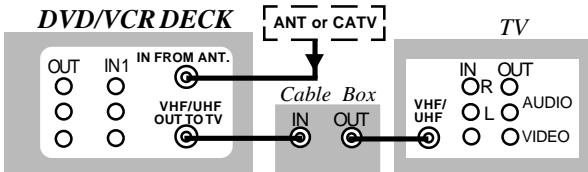

### ■ Connect With Two Cable Boxes

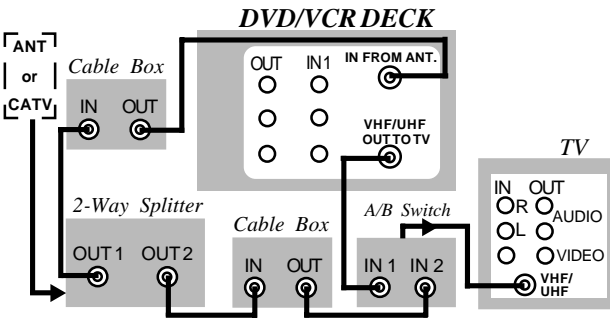

## You Can

- view any (including scrambled) channel.
- use Remote Control to select channels without using Multi-brand control feature.

## You Cannot

- record scrambled channels.

## You Can

- record and view both scrambled and unscrambled channels if additional equipment is added. This connection requires: two converter boxes, an A/B switch, and a 2-way splitter.

## You Cannot

- view a channel other than the one selected for any type of recording.
- do a Timer recording of a channel unless you select it on the Cable Box.

## Connections For DVD Only (enjoying higher picture quality)

- ① Connect AUDIO OUT2 (L, R) to the AUDIO IN (L, R) of the TV. (audio input for COMPONENT or S-VIDEO mode).
- ② If your TV has COMPONENT VIDEO INPUT, connect to COMPONENT VIDEO OUT. If your TV does not have COMPONENT VIDEO INPUT but has S-VIDEO INPUT, connect to S-VIDEO OUT.
- ③ When in DVD mode, set your TV to either COMPONENT VIDEO IN or S-VIDEO IN.

### Notes

- You can watch DVDs through the S-VIDEO or COMPONENT VIDEO, VHF/UHF OUT TO TV, and VIDEO OUT connections to your TV. The VCR and TUNER pictures are available only from the VIDEO OUT and VHF/UHF OUT TO TV connections to your TV.
- PROG functions on the remote are not available when using S-VIDEO OUT and COMPONENT Video Output. Please set TV to either RF INPUT or VIDEO INPUT, and then press PROG.
- TV must have capability to accept and display a progressive scan signal to use PROGRESSIVE mode. Consult your TV operating instructions.

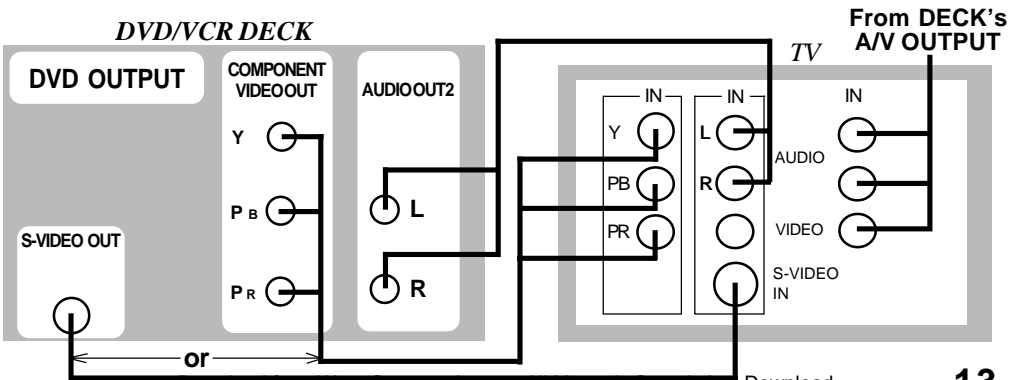

# Connections (continued)

## Audio Connections



### Ready Checklist

- Turn down the volume, then turn DECK, as well as other equipment to be connected, off before proceeding with connection.
- Do not block ventilation holes of any of the equipment and arrange them so that air can circulate freely.
- Read through the instructions before connecting other equipment.
- Ensure that you observe the color coding when connecting audio and video cables.

### ■ Connecting Amplifier (2ch stereo system)

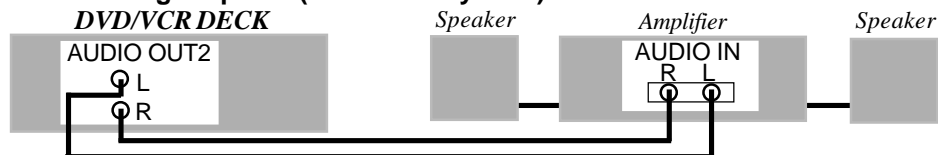

### Enjoying digital audio output from the digital audio output connector

#### Notes on audio output from the optical digital audio output connector

Disc	Sound recording format	Optical digital audio output from connector
DVD	Dolby Digital	Dolby Digital bitstream (1 - 5.1 ch) or PCM (48 kHz sampling/16 bit only)*1
	Linear PCM (48/96/192/44.1/88.2/176.4 kHz 16/20/24bit)	Linear PCM (2 ch) (48 kHz sampling/16 bit or 44.1 kHz sampling/16 bit)*2
	DTS	Bitstream or PCM (48 kHz sampling/16 bit only)*1
Video CD	MPEG 1	PCM (44.1 kHz sampling)
CD	Linear PCM	Linear PCM (44.1 kHz sampling)
MP3	MP3	Linear PCM (It depends on the MP3 file)
WMA	WMA	Linear PCM (It depends on the WMA file)

\*1 The type of audio output from the connector can be selected by the Settings for DVD Operation. (See p. 54.)

\*2 Sound having 96/192 kHz sampling is converted into 48 kHz sampling (or 88.2/176.4 kHz sampling is converted into 44.1 kHz sampling) when it is output from the DECK's optical digital audio output connector.

#### For your reference:

- Dolby Digital is a digital sound compression technique developed by the Dolby Laboratories Licensing Corporation. Supporting 5.1-channel surround sound, as well as stereo (2-channel) sound, this technique enables a large quantity of sound data to be efficiently recorded on a disc.
- Linear PCM is a signal recording format used in CDs. While CDs are recorded in 44.1 kHz/16 bit, DVDs are recorded in 44.1 kHz/16 bit ~ 192 kHz/24 bit.

Manufactured under license from Digital Theater Systems, Inc. US Pat. No. 5,451,942, 5,956,674, 5,974,380, 5,978,762 and other world-wide patents issued and pending. "DTS" and "DTS Digital Surround" are registered trademarks of Digital Theater Systems, Inc. Copyright 1996, 2000 Digital Theater Systems, Inc. All rights reserved.

Manufactured under license from Dolby Laboratories.

"Dolby" and the double-D symbol are trademarks of Dolby Laboratories.

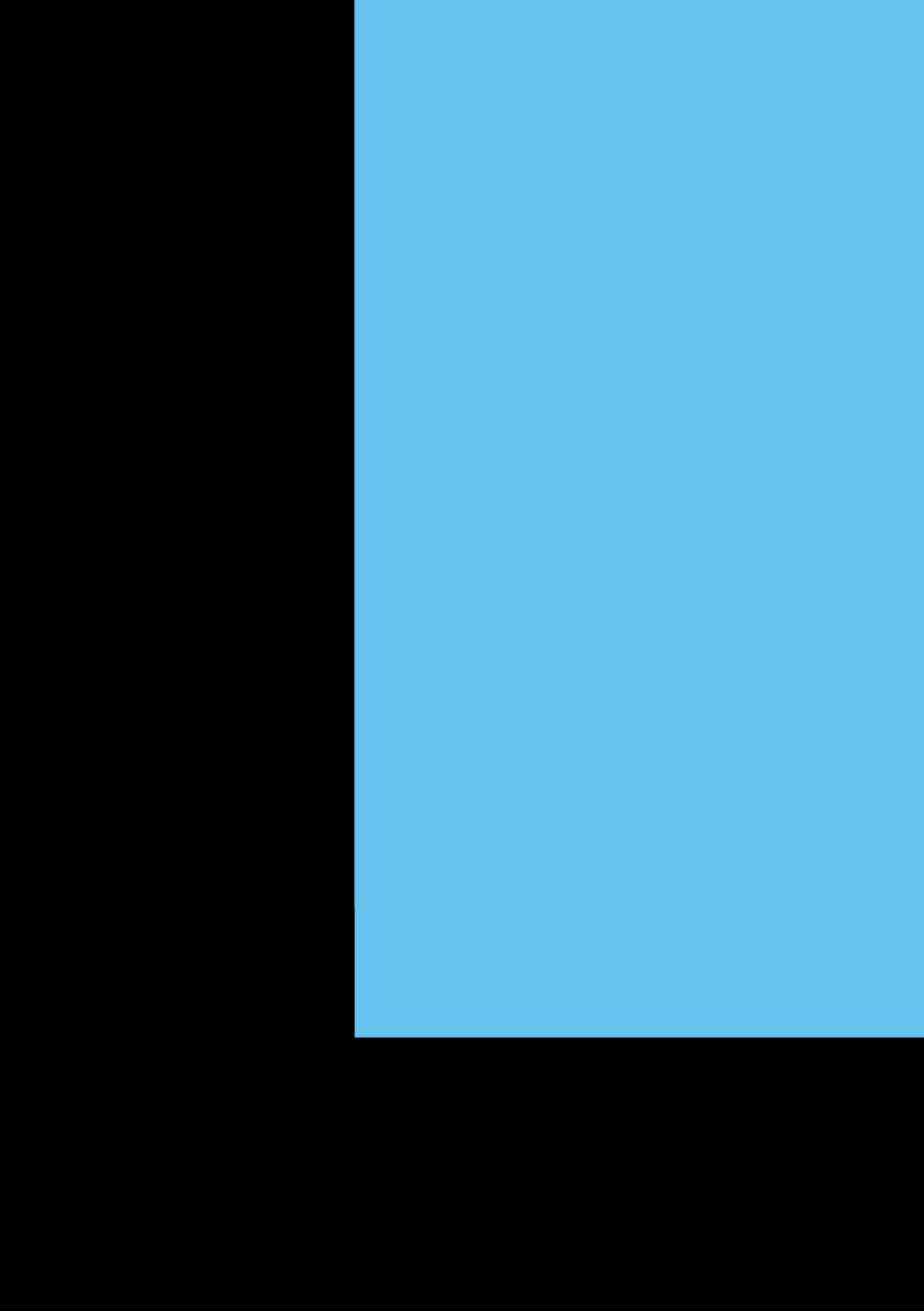

# Initial Setup for Basic Connections (Ready to Play)

## Before doing Initial Setup

- 1 Turn TV on.
- 2 See connections (a) RF Coaxial Cable Connection and (b) AV Cable Connection on page 12.  
<RF Coaxial Cable Connection>  
Set TV to channel 3.  
<AV Cable Connection>  
Set TV to VIDEO.
- 3 [DECK → TV]
  - Go to "Initial Setup (Ready to Play)." (See below.)[Cable Box → DECK → TV], [DSS → DECK → TV]
  - Turn on Cable Box and set it to your Public Broadcasting Station (PBS) channel in your time zone.
  - If you use a DSS Receiver, it must be turned off.

## Initial Setup (Ready to Play)

- 1 Press VCR on remote for VCR mode.
- 2 Plug DECK Power Cord into AC wall outlet. DECK comes on and auto channel and clock set starts.
  - If screen below does not appear, check DECK - TV connection and, if TV is tuned to channel 3, try switching it to channel 4.
  - To change VCR's output channel, please refer to "VCR's Output Channel" on page 19.

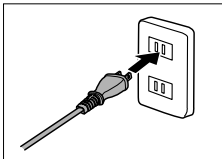

### Plugging the AC Power Plug into an AC outlet

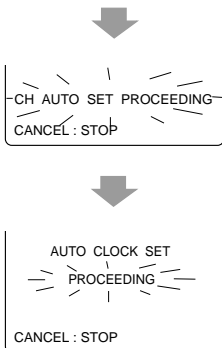

### Notes

- Function buttons are inoperative during Initial Setup.
- To remove a cassette during Auto Set, press EJECT on the remote or STOP/EJECT twice on the DECK. In this case, settings must be made manually. (See p. 18.)
- Depending on conditions, Auto Clock Set may take longer than 30 minutes. If so, press STOP to stop setup and perform settings manually. (See p. 18.)

*Continued on next page...*





the  
g

# Reset Language, Channels, Clock,

1

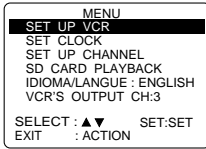

Press **ACTION\*** to display MENU.

2

## Language

1) Press **▲▼** to select language item.

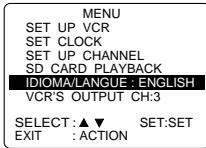

2) Press **SET** repeatedly to change language item as shown below.

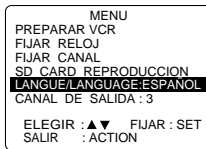

For Spanish



For French

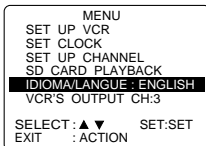

For English

3) Press **ACTION** to exit.

## Channels

2) Press **▲▼** to select "ANTENNA," then press **SET** to set your antenna system ("TV" or "CABLE.")

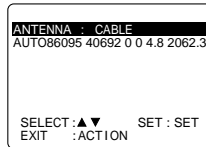

3) Press **▲▼** to select "AUTO SET," then press **SET**.

• If you use a Cable Box, set it to the PBS channel in your time zone.

• After Channel Auto Set is finished, Auto Clock Set will be performed.

## Clock

2) Press **▲▼** to select "MANUAL," and press **SET**. (For Auto Clock Set, select "AUTO CLOCK SET.")

("TIME ZONE ADJUST" appears only when auto clock is set.)

3) Press **▲▼** and **◀** to select, then set the date, time, and DST (Daylight Saving Time).

4) Press **ACTION** to start Clock and exit this mode.

**\*Important:** If a remote control button does not work when pressed, press the VCR button on the remote and try the button again.

## Time Zone Adjust

(Only when Auto Clock is set.)

1) Press **▲▼** to select "SET CLOCK," and press **SET**.

## VCR's Output Channel

1) Press **▲▼** to select "VCR'S OUTPUT CH.," and press **SET**.

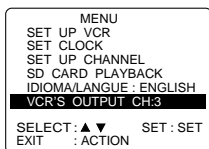

2) Press **▲▼** to select "TIME ZONE ADJUST,"

2) Press **SET**.

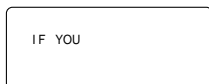

3) Press **ACTION**.

and press **SET** to subtract or add hour(s) as necessary.

3) Press **ACTION** twice.

After 3 seconds

• "TIME ZONE ADJUST" returns to "0" if clock is set manually.

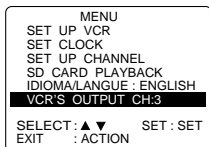

• To Make Corrections, repeat steps 1) ~ 3).

## Add or Delete a Channel

To add channel:

Select channel with **NUMBER** keys and press **ADD/DLT**.

CHANNEL 08 ADDED

To delete channel:

Select channel with **CH ▲▼** or **NUMBER** keys and press **ADD/DLT**.

CHANNEL 08 DELETED

## DST (Daylight Saving Time)

DECK auto adjusts clock for DST. (p. 17.)

**Spring (First Sunday in April)**

DST:ON → Sets clock ahead one hour.

**Autumn (Last Sunday in October)**

DST:ON → Turns clock back one hour.

- If your area does not observe Daylight Saving Time, select DST:OFF.
- Keep these time changes in mind when programming DECK for timer recordings.

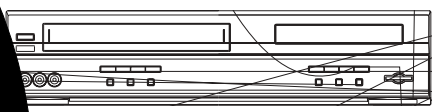

SF = Standard Play

LP = Long Play

LP = Long Play

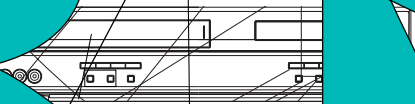

TITLE MENU

Dogs

of the world

**\*Important:** If a remote control button does not work when pressed, press the DVD button on the remote and try the button again.

## ■ Forward/Reverse Scene Search

Press **FF/SLOW+** or **REW/SLOW-** during play.

Press **PLAY** to release.

- Starting forward/reverse search during play started from menu on Video CDs may recall menu.
- Search speed, slow at first, increases with each additional press of the button up to 5 levels.

## ■ Forward/Reverse Chapter/Track Skip

Press **SKIP ►►** or **◄◄ SKIP** during play.

Each press skips a chapter (DVD-Video) or track (DVD-Audio/Video CD/CD).

- Pressing **◄◄ SKIP** once midway through a chapter/track returns to the start of that chapter/track. Each additional press skips back one chapter/track.
- Pressing **SKIP ►►** or **◄◄** during play started from menu on Video CDs may recall menu.

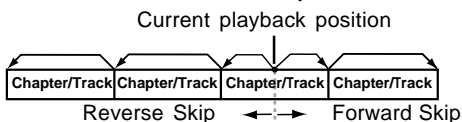

## ■ Still Picture or Pause

Press **PAUSE/STILL** during play.

Press **PLAY** to release.

- **DVD/Video CD** : DECK will enter still picture mode.
- **CD** : DECK will enter pause mode.

## ■ Frame by Frame Picture (DVD/Video CD)

Press **PAUSE/STILL** in still mode.

Press **PLAY** to release.

- Each press advances picture one frame.
- Hold button down for consecutive frame advance.
- Whether pictures are advanced by "FRAME" or "FIELD" is selected automatically. (See p. 57.)

## ■ Slow Motion Picture (DVD/Video CD)

Press **FF/SLOW+** or **REW/SLOW-** in still mode.

Press **PLAY** to release.

- Slow motion speed, slow at first, is increased with each additional press of the button up to 5 levels.
- Reverse slow motion is not available for Video CDs.

## Auto-Power Off Function

Power turns off after DECK has been in Stop mode (DVD) for about 5 minutes.

- When  appears on the screen while a button is being operated, it means that the corresponding operation is prohibited by DECK or the disc.

## V.S.S. (Virtual Surround Sound)

Press **VSS** in DVD mode.

## Resume Function

DECK memorizes the point where **STOP ►** is displayed on screen.

Press **PLAY** to resume play from this point. Pressing **STOP** again or opening the tray cancels **RESUME**, however, **RESUME** is not canceled when power is turned off and on.

- **RESUME** works only with discs for which elapsed play time is displayed during play.

## Enjoy Video CDs featuring playback control without using menus (Video CDs only)

1. Do steps 1-4 (previous page). When menu appears, **press STOP**.
2. Press **NUMBER keys** to select desired track (play begins).
  - Check disc for track numbers.
  - Press "1" to start at beginning of disc.

### To Resume Menu use,

Press **STOP** and press **PLAY**, then the menu will be displayed.

Now, go to step 5 (previous page).

### Notes

- Please read the disc jacket for operation information.
- If a single sided disc is placed in upside down, "THIS TYPE OF DISC CANNOT BE PLAYED. PLEASE INSERT A DIFFERENT DISC" is displayed.
- Remove disc and press DECK POWER off when not in use.
- Disc continues to rotate with menu displayed even after play is done. Press **STOP** to clear menu display when

# Timer Recording

## ✓ Ready Checklist

- All connections are made. (pp. 12 ~ 15)
- TV and DECK are plugged in.
- Clock set correctly. (p. 18)
- Tape has rec.tab. (p. 6)
- Remote is in VCR mode. (Press VCR.)
- Sufficient tape remaining for recording time.

## 1 Press **PROG\*** to display Program.

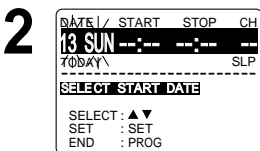

### Example

Today

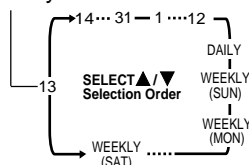

**1) To set record DATE, press ▲▼ to select: 1~31= one time, or DAILY= MON~ FRI, or WEEKLY= same time each week and press SET.**

• See selection order left.

**2) To set remaining items, press ▲▼ to select and press SET to set START/ STOP times, CH (channel) or LINE input (p. 35), and tape speed (SP, LP, SLP).**

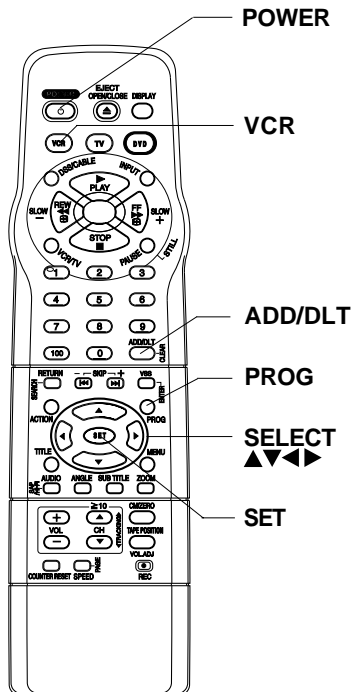

**Press PROG** to end programming.

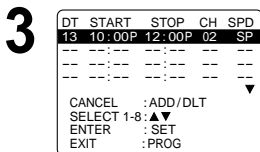

**To Enter More Programs, press ▲▼ to select and press SET to set an unused program number, and then repeat step 2.**

Or  
**Press PROG** to exit.

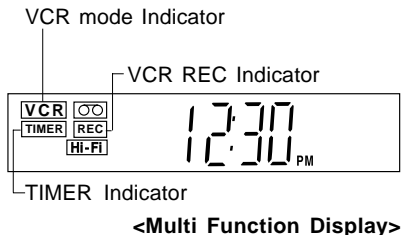

- The "Timer" Indicator lights up on DECK.
- You can do Timer Recording with the power on or off.
- **"TIMER REC WILL START SOON"** appears on-screen for 2 minutes before Timer Recording starts. If DECK is in DVD mode, no message appears, but the VCR REC Indicator, the VCR mode indicator and "REC" will flash on Multi function Display.



**\*Important:** If a remote control button does not work when pressed, press the VCR button on the remote and try the button again.

## Review, Replace or Clear Program Contents:

(Recording is not in progress)

1

2

DT	START	STOP	CH	SPD
7	9:00A	12:00A	08	SP
8	10:00P	12:00P	02	SP
10	8:00P	9:00P	10	SP
SU	9:00P	10:00P	L1	LP

CANCEL :ADD/DLT  
SELECT 1-8:▲▼  
ENTER :SET  
EXIT :PROG

Press ▲▼  
to select number and  
press SET  
to display.

### To cancel a Timer Recording in progress...

Hold down STOP in VCR mode for  
a few seconds to cancel the Timer  
Recording.

(The "TIMER" Indicator goes out  
on Multi Function Display.)

- Any future daily or weekly recording  
will be performed as programmed.

## 3 To Replace program...

DATE	START	STOP	CH
7 SUN	9:00A	12:00A	08
70BAY			SP

-----  
SELECT START DATE

SELECT :▲▼  
SET :SET BACK:◀  
END :PROG

Repeat Step 2 (p. 24)  
to set new programs.

or

### To Clear program...

DT	START	STOP	CH	SPD
8	10:00P	12:00P	02	SP
10	8:00P	9:00P	10	SP
SU	9:00P	10:00P	L1	LP

CANCEL :ADD/DLT  
SELECT 1-8:▲▼  
ENTER :SET  
EXIT :PROG

Press ADD/DLT.

Press PROG

to end the programming.

### Notes

- If you are using a Cable Box, the VCR's channel for Timer Recording must be set to the Cable Box input channel and Cable Box must be manually set to the desired channel. Cable Box power must be left on.
- 2 minutes before Timer Recording is performed, "

### Important notes when using DSS Receiver

- When recording programs via DSS Receiver, DSS Receiver must be left on.
- When recording programs via an antenna or cable, DSS Receiver must be turned off.

# MTS Broadcast/ VHS Hi-Fi Stereo System

## Connection

Make the Audio/Video Connection as shown on pp. 12 ~ 15.

- You can use TV connected to a Stereo amplifier and speakers instead of Stereo TV.

## Receivable Broadcast Types

The following are possible audio broadcast types and on-screen displays.

The signal being received is indicated with an “Ⓒ” mark while the selected received audio mode is indicated with an arrow.

To display the broadcast signal being received,

→ **press DISPLAY\***.

### MTS Stereo and SAP broadcast

Multi-channel Television Sound Stereo (main language) and Secondary Audio Program (sub language) broadcasts are being received simultaneously. Select STEREO or SAP audio mode.

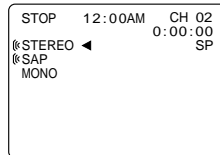

### MTS Stereo broadcast

Multi-channel Television Sound Stereo broadcast. Select STEREO audio mode.

- If stereo broadcast is weak and display flickers, select MONO audio mode for possible better results.

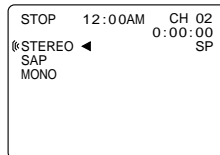

### SAP broadcast

Secondary Audio Program (sub language) broadcast. Select SAP audio mode for the sub language.

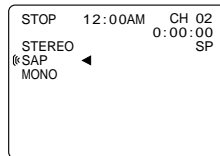

### MONO broadcast

Normal monaural sound broadcast.

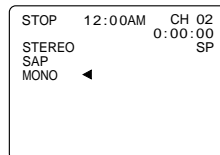

— DISPLAY

AUDIO  
(SAP/Hi-Fi)

Equipped with **dbx**<sup>®</sup>-TV Noise Reduction for true MTS reproduction. **dbx**<sup>®</sup>-TV Noise Reduction is required for good stereo separation and audio fidelity. **dbx**<sup>®</sup> is a registered trademark, and is licensed by **dbx**<sup>®</sup> Technology Licensing.

**\*Important:** If a remote control button does not work when pressed, press the VCR button on the remote and try the button again.

## Audio Mode for Recording

### 1 Press **AUDIO (SAP/Hi-Fi)** to display audio mode.

(Display disappears after 5 seconds.)

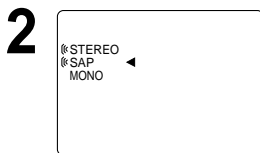

Press **AUDIO (SAP/Hi-Fi)** repeatedly to select desired mode.

- Refer to “Receivable Broadcast Types” on page 26.
- Arrow indicates selection.

### 3 Make a recording. See page 21.

## Audio Mode for Playback

### 1 Start playback. See page 20.

### 2 Press **AUDIO (SAP/Hi-Fi)** to display audio mode.

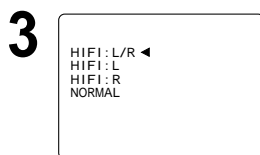

Press **AUDIO (SAP/Hi-Fi)** repeatedly to select desired mode.

- Select “HI-FI (L/R)” or “HI-FI (L)” or “HI-FI (R)” to listen to stereo recordings in stereo sound. Select “NORMAL” for monaural sound.
- Display disappears after 5 seconds.
- Arrow indicates selection.

### Notes

- Only tapes recorded in Hi-Fi stereo will playback with true stereo sound. Standard stereo tapes will playback in monaural sound.
- To listen to Hi-Fi stereo playback, the DECK AUDIO (L/R) jacks must be connected to a stereo TV or an external stereo amplifier and speakers. (See pp. 12, 14.)
- If tracking is adjusted during playback, Hi-Fi audio may revert to normal audio.
- Hi-Fi and normal audio playback volume level may differ.



## TV Brand Code Numbers

Panasonic .....	01, 02	Sylvania .....	05	JVC .....	11
Quasar .....	01, 02	Sharp .....	06, 07	Hitachi .....	12
RCA .....	03	Sony .....	08	Mitsubishi .....	07, 13
GE .....	03	Toshiba .....	09	Samsung .....	14
Zenith .....	04	Sanyo .....	10	Gold Star .....	15, 16, 17
Magnavox .....	05	Fisher .....	10		

## Cable Box Brand Code Numbers

Archer .....	44, 06, 01, 120, 05, 63, 126	Oak Sigma .....	46, 11, 129, 101
Cableview .....	29, 09, 01, 63, 120, 44, 42, 30 52, 04, 124, 126	Panasonic .....	17, 16, 08, 87, 109
Citizen .....	44, 52, 30, 63, 42, 04, 124, 126	Philips .....	23, 24, 20, 13, 07, 50, 128, 129
Curtis .....	08, 09, 25, 61, 53, 87	Pioneer .....	06, 05, 12
Century .....	44, 51, 75, 59, 126	Pulsar .....	04, 42, 63, 44, 30, 52, 124, 126
Cabletenna .....	29, 09, 01, 63, 120, 44, 126	Quest .....	06, 05, 12
Cable Cinema .....	29, 09, 01, 63, 120, 44, 126	Radio Shack .....	44, 51, 75, 59, 126
Diamond .....	29, 09, 01, 63, 120, 44, 126	RCA .....	17, 16, 08, 87, 109
Eagle .....	62, 40, 22, 13, 58, 20, 26, 107	Realistic .....	44, 51, 75, 59, 126
Eastern .....	28, 29, 130	Recoton .....	44, 51, 75, 59, 126
Explorer .....	08, 09, 25, 61, 53, 87	Regal .....	41, 14, 15, 28, 102, 104, 103, 130
Gemini .....	30, 04, 124	Regency .....	28, 29, 130
General Electric .....	01, 57, 120	Rembrandt .....	44, 42, 63, 29, 01, 32, 39, 120, 126
General Instruments . 01, 84, 83, 34, 03, 02, 04, 55 65, 66, 67, 68, 120, 106, 121, 122, 115, 117, 118, 124		Samsung .....	42, 06, 32, 05, 40
Gerrard .....	44, 51, 75, 59	Scientific Atlanta .....	08, 09, 25, 61, 53, 87
GC Electronics .....	44, 42, 63, 29, 30, 52, 04 124, 126	Sheritech .....	27
Hamlin .....	41, 14, 15, 28, 102, 104, 103, 130	Signal .....	26, 112
Hitachi .....	31	SL Marx .....	42, 06, 32, 40, 43, 44, 52, 63, 126
Jerrold .....	01, 84, 83, 34, 03, 02, 04, 55, 65, 66 67, 68, 120, 106, 121, 122, 115, 117, 118, 124	Sprucer .....	17, 16, 08, 87, 109
Jasco .....	30, 04, 124	Standard Components .....	32, 39, 42, 44, 126
Macom .....	31	Stargate .....	04, 42, 32, 40, 63, 44, 30, 52, 06 124, 126
Magnavox .....	26, 112	Sylvania .....	19, 18
Matsushita .....	17, 16, 08, 87, 109	Teknika .....	74, 35
Movietime .....	32, 39, 42, 44, 126, 38, 40	Telecaption .....	77, 127
Maestro .....	74, 35	Televue .....	40, 19, 38, 32, 42, 06
NEC .....	40, 19, 38, 32	Texscan .....	19, 18
NSC .....	40, 19, 38, 32	Tocom .....	34, 33, 01, 42, 66, 120
Novavision .....	08, 09, 25, 61, 53, 87	Toshiba .....	36
Next Level .....	01, 84, 83, 34, 03, 02, 04, 55, 65, 66 66, 67, 68, 120, 106, 121, 122	Unika .....	44, 42, 63, 29, 01, 126, 120
Oak .....	46, 11, 129, 101	Universal .....	52, 43, 44, 63, 42, 126

## DSS Brand Code Numbers

Toshiba .....	90	Optimus .....	94, 95
Hitachi/ Hughes .....	91, 99	Panasonic .....	96
Primestar .....	92	ProScan .....	97
Drake .....	93	RCA .....	97
Magnavox .....	94, 95	SONY .....	98, 105
Uniden .....	94, 95		

## Important Notes

- Some manufacturers use several codes for one brand. If the first code entered fails, try the next one listed.
- Some TV, Cable Box and DSS Receiver brands require you to turn on the power manually.  
Download from [www.Somanuals.com](http://www.Somanuals.com). All Manuals Search And Download.

# Tape Operation

## Search System

For each recording, an invisible index mark is placed on the tape. A program index and information are also included for timer recordings. These marks are used to access or scan recordings.

### Index Search

1

---

2

---

### Program End Search

Locates end point of recording for continuity.

1

---

2

---

Fig. 1

Fig. 2

Fig. 3

#### Note

- If Index Search is started very close to an index mark, that index mark may not be counted in the search.

#### Note



# Tape Operation (continued)

## Repeat Play

Set to playback a recording over and over.

**1** Press **ACTION\*** to display MENU.

**2** Press **▲▼** to select "SET UP VCR," and press **SET**.

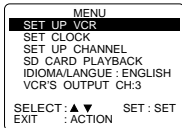

**3** Press **▲▼** to select "REPEAT PLAY," and press **SET** to set "ON" or "OFF."

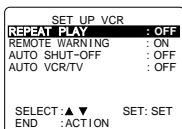

- Play repeats at tape end or if unrecorded portion over 30 sec. is detected.

**4** Press **ACTION** twice to return to normal screen.

### Note

- For repeat play in DVD mode, see page 48.

## Zero Search

To quickly return to a specified tape location.

**1** Press **DISPLAY** during play to display Counter.

**2** Press **COUNTER RESET** at desired position to reset to "0:00:00".

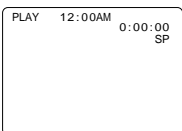

**3** Continue to record, playback etc.

**4** Press **STOP**.

**5** Press **CM/ZERO** in Stop mode to start Zero Search.

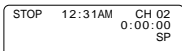
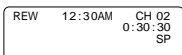

- DECK will go into FF or REW mode and stop at the last point the Counter was set to 0:00:00.

## VCR/TV Selector Feature

The VCR/TV selection can be set to auto or manual.

**1** Press **ACTION** to display MENU.

**2** Press **▲▼** to select "SET UP VCR," and press **SET**.

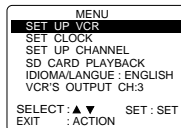

**3** Press **▲▼** to select "AUTO VCR/TV," and press **SET** to set "ON" or "OFF."

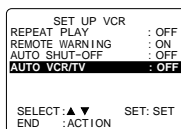

- OFF(Manual): You select "VCR" or "TV" mode using the VCR/TV button on the remote.
- ON(Auto): "VCR" mode is automatically set when VCR is turned on, or in Play mode.

**4** Press **ACTION** to return to normal screen.

### Note

- For more on VCR/TV selection, see "Record one station, watch another" and "Select channels at DECK" sections (see p. 21).





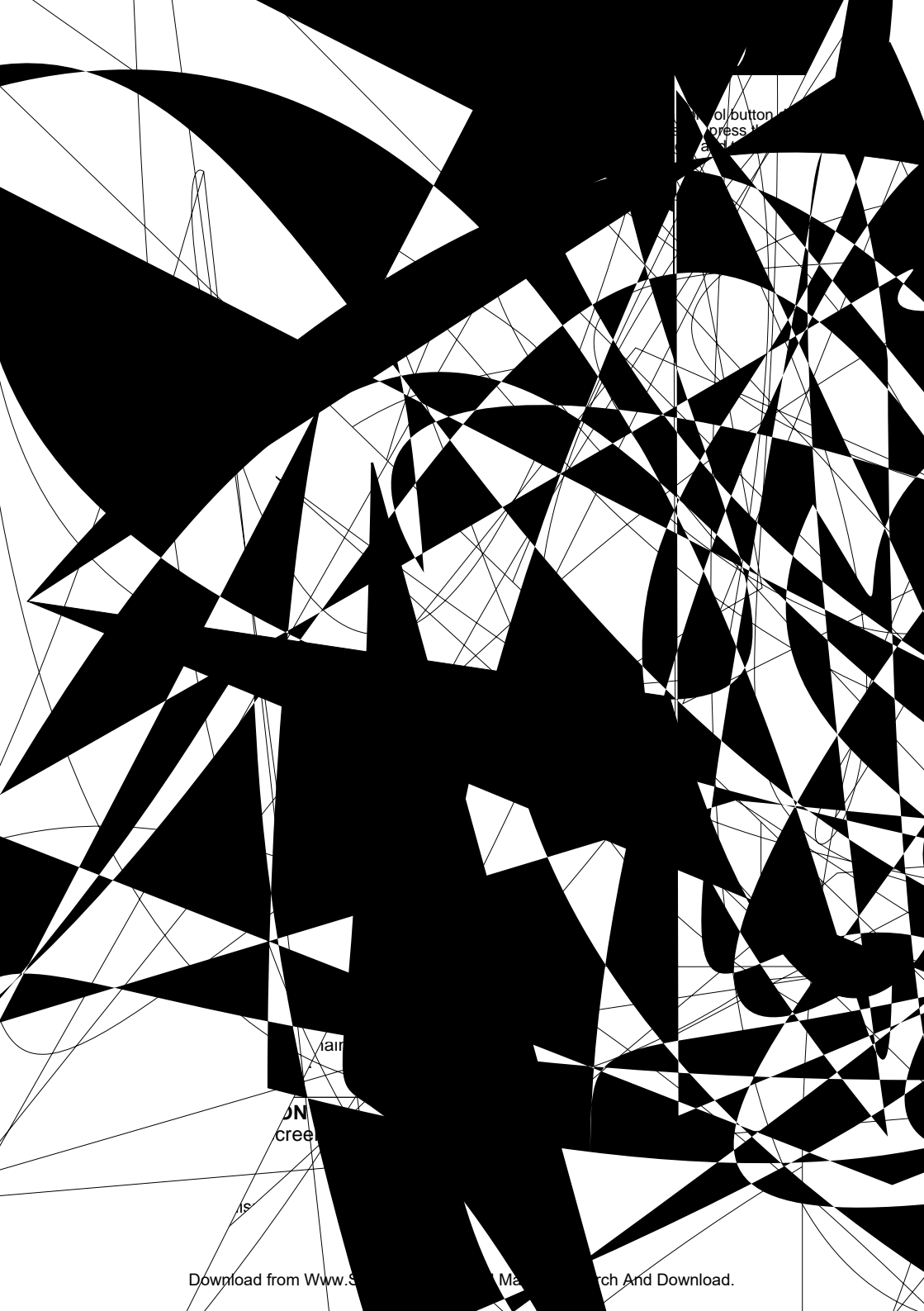

ol button  
press H  
a

ian  
ON  
cree

is

# Copying Your Tapes (Dubbing)

## Connection

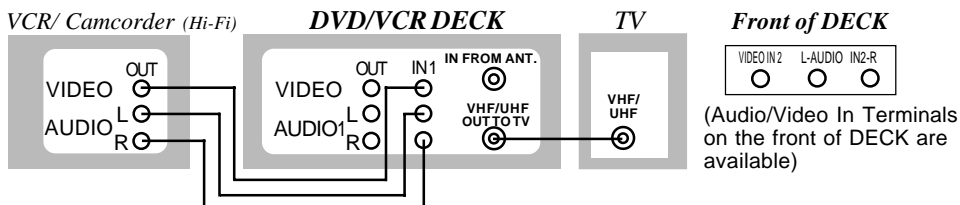

- ① Connect VIDEO OUT terminal on Playing VCR to VIDEO IN terminal on DECK. To monitor the dubbing, also connect TV as shown.
- ② Connect "L" and "R" AUDIO OUT terminals on Playing VCR to "L" and "R" AUDIO IN terminals on DECK.  
In place of Playing VCR, you can use other equipment, such as a Camcorder. Simply connect the unit's Audio/Video outputs to DECK.

### Playing (Source) VCR

### Recording (Editing) DECK

- |  |  |
|--|--|
| <ol style="list-style-type: none"> <li>1 Insert a pre-recorded tape.</li> </ol>  | <ol style="list-style-type: none"> <li>Insert a blank tape with record tab.</li> </ol>   |
| <ol style="list-style-type: none"> <li>2 _____</li> </ol>  | <ol style="list-style-type: none"> <li>Press <b>INPUT</b> to set DECK Input mode to LINE for Video Input.<br/>(See "Selecting the Input Mode" below.)</li> </ol> |
| <ol style="list-style-type: none"> <li>3 Press <b>PLAY</b>, then <b>PAUSE/STILL</b> immediately to enter PLAY/PAUSE mode.</li> </ol> | <ol style="list-style-type: none"> <li>Press <b>REC</b>, then <b>PAUSE/STILL</b> immediately to enter REC/PAUSE mode.</li> </ol>                                 |
| <p>The operation of steps 4 and 5 must be done on the playing and recording VCRs at the same time.</p>                               |  |
| <ol style="list-style-type: none"> <li>4 Press <b>PLAY</b> to start dubbing. Playing VCR starts playback.</li> </ol>                 | <ol style="list-style-type: none"> <li>Press <b>PAUSE/STILL</b> to start dubbing. DECK starts recording.</li> </ol>  |
| <ol style="list-style-type: none"> <li>5 Press <b>STOP</b> to stop dubbing.</li> </ol>   | <ol style="list-style-type: none"> <li>Press <b>STOP</b> to stop dubbing.</li> </ol>   |

### ■ To Monitor Dubbing on TV

- 1 Turn TV on and tune to the Recording VCR channel (CH 3 or CH 4).
- 2 If Auto VCR/TV (see p. 32) is set to "OFF," press VCR/TV on the remote to be VCR mode.

### ■ Selecting the Input Mode

- Method 1: Press **INPUT** repeatedly.  
Channel Number ↔ LINE1 ↔ LINE2
- Method 2: Press **CH ▲/▼**.  
Display will change as below.

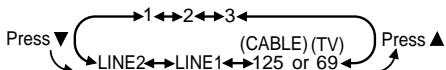

- "L1" or "L2" lights up on Multi Function Display (about 4 seconds) when LINE1 or LINE2 is selected.
- LINE1: For rear audio/video connection.  
LINE2: For front audio/video connection.

**Note** • Dubbing tapes protected with Copy Guard will result in poor quality recordings.

**Caution:** • Unauthorized exchanging and/or copying of copyrighted recordings may be copyright infringement.  
• Please note that some tapes cannot be dubbed on DECK. Also, it is not possible to dub DVD/ Video CD/ CD to VHS tapes using DECK.

# Disc Operation

## Subtitle Language (DVD only)

You can select a different subtitle language (if offered) than the one set at the Settings for DVD Operation.  
(See p. 53.)

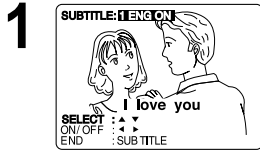

**Press SUB TITLE\*** in Play mode to display the subtitle selection on-screen.

- Display disappears after 5 seconds.
- When no subtitles are offered, “.” will be displayed instead of the language number.

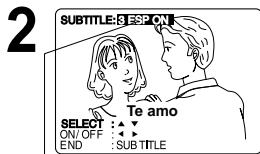

**Press ▲▼** to select a language.

**Press ◀▶** to select “ON” or “OFF.”

Subtitle language being played back (see chart, right).

### Notes

- If after several presses of the button the language does not change, language selection is not offered on the disc.
- When disc is removed, subtitles revert to initial setting language. If the initial language is not recorded on the disc, the disc's priority language will appear.
- With DVD-RAM, the subtitle can only be set to ON/OFF. The subtitle language cannot be selected.

## Audio Soundtrack Language (DVD only)

You can change the audio soundtrack language, selected at the Settings for DVD Operation, to a different language if available. (See p. 53.)

(This operation works only with discs on which multiple audio soundtrack languages are recorded.)



**Press AUDIO** in Play mode to display the audio selection on-screen.

- Display disappears after 5 seconds.
- Audio attribute 1 type, sampling frequency, bit No. of the disc or number of speaker channel.



**Press ▲▼** to select desired language.

Audio soundtrack language being played back (see chart, above right).

## ✓ Ready Checklist

- Please read “Basic DVD Operation” on page 22.

### [Subtitle language]

### [Audio sound track language]

ENG	English
FRA	French
DEU	German
ITA	Italian
ESP	Spanish
NLD	Dutch
SVE	Swedish
NOR	Norwegian
DAN	Danish
POR	Portuguese
RUS	Russian
JPN	Japanese
CHI	Chinese
KOR	Korean
MAL	Malay
VIE	Vietnamese
THA	Thai
*	Other

- Change the No. by **pressing ▲▼**, and **press SET**.

### [Audio attribute 1 type, sampling frequency, bit No. of the disc (see p. 54.)]

LPCM	44.1 kHz	16 bit	Linear PCM disc
	192 kHz	20 bit 24 bit	
Dolby Digital	1 ch - 5.1 ch	Dolby Digital disc	
DTS	1 ch - 5.1 ch	DTS disc	

### Notes

- If, after several presses of the AUDIO button the language does not change, language selection is not offered on the disc.
- When disc is removed, language reverts to initial setting. If this language is not recorded on the disc, the language recorded will be heard.
- With DVD-RAM, Audio Soundtrack Language cannot be set. Audio stream and Audio mode (LR/L/R) setting can be made. Audio stream operation method is the same as Audio Soundtrack Language. Press ▶ to move the cursor to Audio mode, then press ▲▼ to select LR/ L/ R.

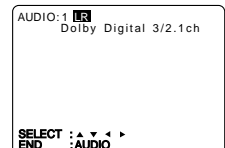

- The subtitle can't find its position
- The picture zooms in and out
- During picture freeze, "ZOOM2" appears for 2 seconds.
- Zooming, on screen, doesn't work in poor picture or doesn't operate at all.

# Disc Operation (continued)

## Title Menu (DVD only)

Some DVDs have more than one title, e.g. movies. If the disc offers a title menu, you can select the desired title number. (Operation may vary according to the disc.)

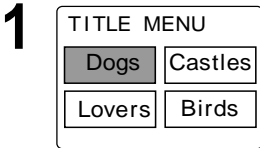

<Example>

Press **TITLE\*** in Play mode to display the title screen.

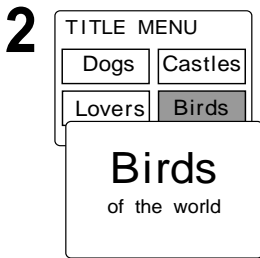

<Example>

Press **▲▼◀▶** or **NUMBER keys** to select a title, and press **SET** or **PLAY** to start playing.

\* "Pressing **SET** or **PLAY**" is not necessary when using **NUMBER keys**.

## DVD Menu (DVD only)

DVDs may offer a special menu. This menu may include guides to unique contents, audio/subtitle languages, etc. Although contents and operation may vary, the following steps show basic steps for using the menu.

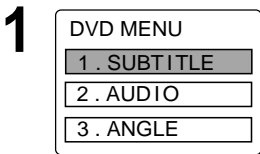

<Example>

Press **MENU** in Play mode to display DVD MENU.

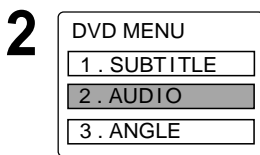

<Example>

Press **▲▼◀▶** or **NUMBER keys** to select an item, and press **SET** or **PLAY** to perform.

\* "Pressing **SET** or **PLAY**" is not necessary when using **NUMBER keys**.

Repeat step 2 if there is more than one menu.

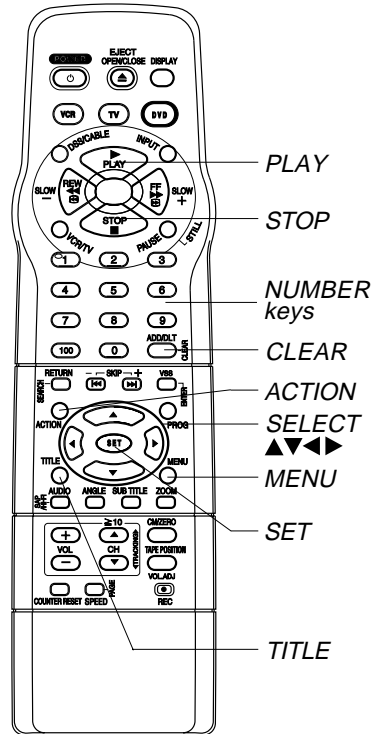

\*Important: if a remote control button does not work when pressed, press the DVD button on the remote and try the button again.

## Program Play (Video CD/CD only)

You can program specific tracks and order of play.

**1** Press **ACTION** to display DVD MAIN MENU.



Press **▲▼** to select "PLAY MODE," and press **SET** to display.

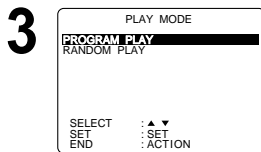

Press **▲▼** to select "PROGRAM PLAY," and press **SET** to display.

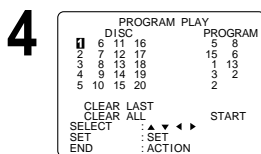

Press **▲▼◀▶** to select a track number (Track numbers on disc are displayed.), and press **SET**.

- Repeat step 4 to select another track.
- The selected track is added on the right side.

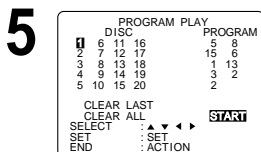

Press **▲▼◀▶** to select "START," and press **SET** to start play of programs in the sequence selected.

- To cancel, press **STOP** during play, then press **CLEAR**.

### Notes

- Up to 15 tracks can be programmed.
- "◀" or "▶" (depending on disc) indicates additional PROGRAM PLAY screen. Press **▲▼◀▶** for next or previous screen.
- To clear the last program one by one Press **▲▼◀▶** to move to "CLEAR LAST" and press **SET**. (Pressing **CLEAR** on remote control also clears last program.)
- To clear all programs Press **▲▼◀▶** to move to "CLEAR ALL" and press **SET**. (Programs are also cleared when the power is turned off or the disc is removed.)

## ✓ Ready Checklist

- DECK is in DVD mode, press DVD.
- Video CD or CD is inserted.

## Program Repeat Play (Video CD/CD only)

**1** Do operation steps 1 through 5 at left on this page.

**2** Press **DISPLAY** to display Disc Information screen. (Disc Information Screen)

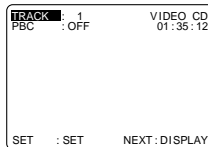

**3** Press **DISPLAY** to display DECK Information screen.

**4** Press **SET** to enter Select mode. Cursor move to "OFF." (DECK Information Screen)

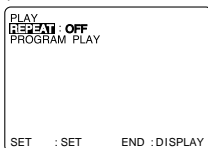

**5** Press **▲▼** to select "DISC." (DECK Information Screen)

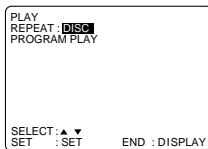

**6** Press **SET** to set mode. Cursor move to "REPEAT." To cancel, select "REPEAT : OFF" in step 5, then press **SET**.

# Disc Operation (continued)

## Random Play (Video CD/CD only)

Tracks are played in a random order.

**1** Press **ACTION**\* to display DVD MAIN MENU.



Press **▲▼** to select "PLAY MODE," and press **SET** to display.

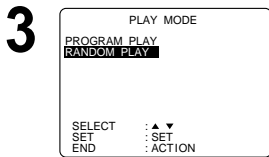

**2** Press **▲▼** to select "RANDOM PLAY," and press **SET** to begin random play.

• To cancel, press **STOP** during play, then press **CLEAR**.

## Ready Checklist

DECK is in DVD mode, press DVD.

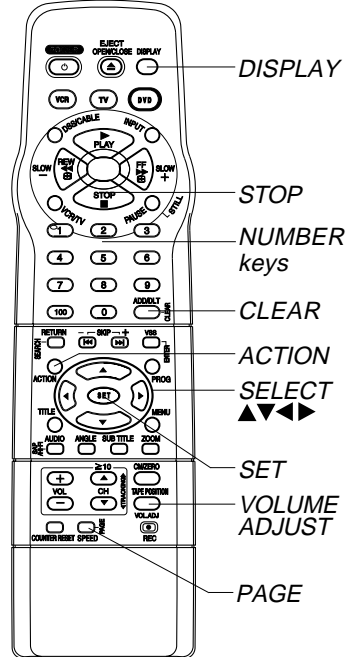

## Setting the VOLUME ADJUST

Some DVDs are recorded in lower than average volume levels. For these DVDs, this DECK can be set so that the average volume is increased.

Press **VOL.ADJ** repeatedly to change "ON" ↔ "OFF."

- "ON" or "OFF" lights up on Multi Function Display (about 3 seconds) when press VOL.ADJ.

	VOLUME ADJUST "OFF"	VOLUME ADJUST "ON"
Some DVD [Volume level is low]	Volume is the original level.	Volume level is increased when played back.

- "ON" is set ..... When a DVD is played back, the average volume is increased.
- "OFF" is set .... The volume level recorded on the disc is played back just as it is.

### Notes

- This feature is available only for Dolby Digital sound tracks.
- When audio equipment is connected, setting the Sound Output level to "OFF" is recommended.
- If the sound becomes abnormal while playing a disc, set the Sound Output level to "OFF."



\*Important: if a remote control button does not work when pressed, press the DVD button on the remote and try the button again.

## DVD-Audio Operation

This DECK, equipped with a 192 kHz/ 24 bit Audio D/A converter, supports DVD-Audio recorded with high quality sound.

The DVD-Audio feature includes "Still Image Skip" and "Bonus Group Playback" functions. (See below.)

Please refer to "Basic DVD Operation" on pages 22 and 23.

### Still Image Skip

DVD-Audio still images (only if contained) can be skipped over.

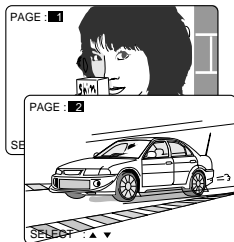

#### Press **PAGE**

in Play or Pause mode to display the still image and page number.

Each press of **PAGE** changes page number as shown below.

- Pressing **PAGE** on the last page returns to **PAGE 1**.

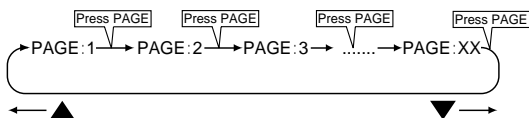

#### Note

- Still Image Skip function not available with all discs.

### Bonus Group playback

Some DVD-Audio discs contain Bonus Group tracks which can be played by entering a 4-digit secret code.

**1** Press **DISPLAY** in stop mode to display "On-Screen Displays."

#### Note

- During playback, Bonus Group tracks cannot be selected.

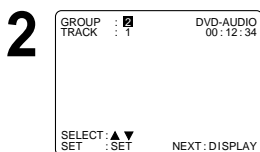

Press **▲▼** to select "GROUP," and press **SET**.

Press **▲▼** or **NUMBER keys** to select bonus group number, and press **SET** (see pp. 44, 45.)

#### Notes

- If the proper secret code is already entered, Bonus Group tracks can be selected. (Secret code enter screen is skipped.)
- This code is specifically for the disc and differs from Parental Lock secret code (p. 52). Please refer to disc jacket instructions.

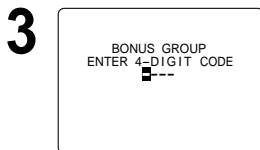

Press **NUMBER keys**

to enter bonus group secret code, and press **SET**.

**To Make Corrections**

Press **◀** repeatedly to move the cursor.

Press **NUMBER keys** to make the correction.

#### Note

- When the proper secret code has been entered, Bonus Group track 1 playback begins. If a mistake is made, the secret code enter screen is redisplayed.

**4** Press **CLEAR** to return to normal screen.

# DVD-RAM Operation (DVD-RAM only)

You can enjoy playing your personally recorded/edited DVD-RAM discs on this DECK.

## Note

- This DECK was designed for playback only. DVD-RAM recording is not possible.

## Play a DVD-RAM

- 1 Do steps 1 ~ 3 on page 22.**
  - Play begins from the first program title recorded on the DVD-RAM.
- 2 Press *TITLE*\* or *MENU*** to display Direct Navigator or Play List menu for easy title or scene selection.
  - See below for Direct Navigator or next page for Play List information.
- 3 Press *STOP*** to stop playing.
- 4 Press *OPEN/CLOSE*** to eject the disc.

## Direct Navigator

If the DVD-RAM features Direct Navigator, a list of recorded titles is displayed. Simply select a title number and start playback. (Operation can vary with disc used.)

- 1 Press *TITLE*** in Play/Stop mode to display the Direct Navigator menu.

- 2 Press ◀▶** to select a page and **press ▲▼** to select a title (Program No.).

Then, **press *SET*** or ***PLAY*** to start playing.

- "Pressing SET or PLAY" is not necessary when using NUMBER keys.

**Using NUMBER keys starts playing automatically.**

The number of available titles varies with each disc.

**<Input**      1 digit number      1 ●● 1  
**Example>**    2 digit number      12 ●● ≥ 10 1 2  
                  3 digit number      123 ●●● 100 1 2 3

- 3 Press *TITLE*** to clear Direct navigator menu. (Press ***ACTION*** to display DVD MAIN menu.)

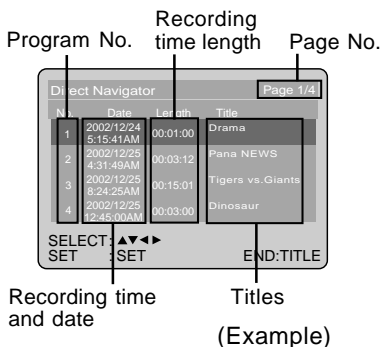

**1** Press **MENU**  
in Play/Stop mode to display the Play List menu.

**2** Press **◀▶ MENU**



Play List				Page 1/5
No.	Date	Length	Title	
1	2002/12/24 5:15:41AM	00:01:00	Movie Picture Playback	
2	2002/12/25 4:31:49AM	00:03:12	Still Picture Playback	
3	2002/12/25 8:24:25AM	00:15:01	Hybrid Playback	
4	2002/12/25 2:45:00AM	00:03:00	Partial Playback	

SELECT: ▲▼▶▶  
SET :SET END:MENU

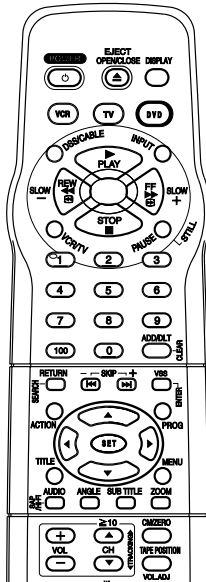

# DVD Operation using On-Screen Displays

When **DISPLAY** is pressed, On-Screen Displays show disc information (title/chapter/track number, elapsed playing time) and DECK information (repeat play, play mode).



## Ready Checklist

- DECK is in DVD mode, press DVD.

**1** Press **DISPLAY\*** in Play or Stop mode to display "On-Screen Displays."

- Each press of **DISPLAY** changes the on-screen display as follows. (Refer to pp. 44 ~ 48.)

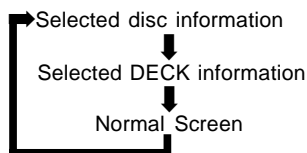

### Note

- DISPLAY** button does not function while DVD MAIN MENU or Direct Navigator or Play List is displayed.

**2** Press **▲▼** (or **◀▶**) to select an item, and press **SET**.

**3** Press **▲▼** or **NUMBER** keys to select the setting, and press **SET**.

**<Example of DVD-Video>** When numbers are displayed (e.g. title number), **NUMBER** keys are also available.

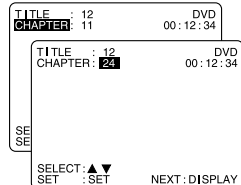

- If the number entered is not on the disc, the entry will have no effect. Re-enter the correct number.

**<Example of DVD-Audio>**

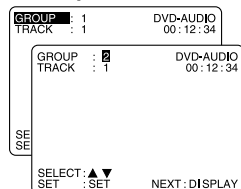

- For more details, refer to the disc operation information.

**To return to normal screen, press CLEAR or DISPLAY repeatedly.**

**<Example of Video CD>**

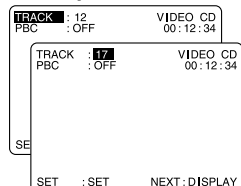

**<Example of DVD-RAM>**

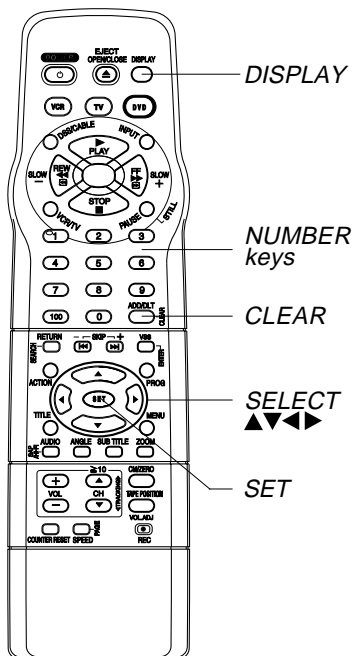
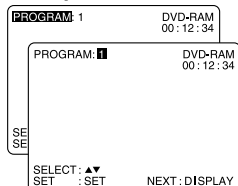

### Notes

- When **DISPLAY** button is pressed during playback of a Video CD with Playback control, **NUMBER** keys are not available on the displayed screen. In this case, press **DISPLAY** again to remove the displayed screen.
- When appears on the screen while a button is being operated, it means that the corresponding operation is prohibited by DECK or the disc.

\*Important: if a remote control button does not work when pressed, press the DVD button on the remote and try the button again.

## Detailed Descriptions of each On-Screen Display

### ■ Disc information screen (for DVD-Video)

#### 1. TITLE No.

- Select "TITLE", and press **SET**.
- Change the No. by pressing **▲▼** or **NUMBER keys**, and press **SET**.

#### 2. CHAPTER No.

- Select "CHAPTER", and press **SET**.
- Change the No. by pressing **▲▼** or **NUMBER keys**, and press **SET**.

#### 3. Disc currently being played

#### 4. Elapsed playing time

The screen may be changed by selecting the elapsed time.

- Select the elapsed playing time ("xx:xx:xx"), and press **SET**.
- Change the elapsed time by pressing **NUMBER keys**.

Hours → Minutes → Seconds are entered in order.

If the time entered is not on the disc, the entry will have no effect. Re-enter the correct time.

e.g., press 0 - 1 - 2 - 3 - 4 - 5 for 01 : 23 : 45.

Hour Minutes Seconds

- This function does not work with some discs.

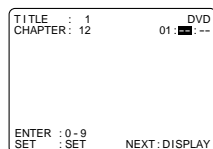
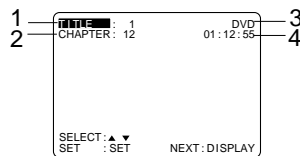

If SET is pressed while making entries, unit returns to the condition it was in before entries were made.

### ■ Disc information screen (for DVD-Audio)

#### A. GROUP No.

- Select "GROUP", and press **SET**.
- Change the No. by pressing **▲▼** or **NUMBER keys**, and press **SET**.

#### B. TRACK No.

- Select "TRACK", and press **SET**.
- Change the No. by pressing **▲▼** or **NUMBER keys**, and press **SET**.

#### C. Disc currently being played

#### D. Elapsed playing time

The screen may be changed by selecting the elapsed time.

- Select the elapsed playing time ("xx:xx:xx"), and press **SET**.
- Change the elapsed time by pressing **NUMBER keys**.

Hours → Minutes → Seconds are entered in order.

If the time entered is not on the disc, the entry will have no effect. Re-enter the correct time.

e.g., press 0 - 1 - 2 - 3 - 4 - 5 for 01 : 23 : 45.

Hour Minutes Seconds

- This function does not work with some discs.

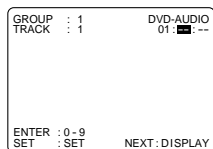
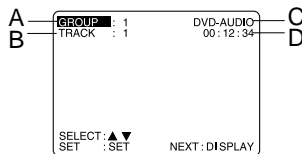

If SET is pressed while making entries, unit returns to the condition it was in before entries were made.

DVD  
Operation

#### Note

- When  appears on the screen while a button is being operated, it means that the corresponding operation is prohibited by DECK or the disc.

# DVD Operation using On-Screen Displays (continued)

## ■ Disc information screen (for Video CD/ CD)

### 1. TRACK No.

- Select "TRACK", and press **SET**.\*
- Change the No. by pressing **▲▼** or **NUMBER keys**, and press **SET**.

### 2. Playback control ON/OFF

[Video CD with playback control only]

<input type="radio"/> ON	Video CD menu play is displayed.
<input type="radio"/> OFF	Video CD menu play is not displayed.

### 3. Disc currently being played

Video CD  CD

### 4. Elapsed playing time

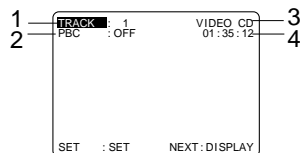

## ■ Disc information screen (for DVD-RAM)

### A. Direct Navigation (PROGRAM) or PLAY LIST No.

- Select "PROGRAM" or "PLAY LIST", and press **SET**.
- Change the No. by pressing **▲▼** or **NUMBER keys**, and press **SET**.

### B. Disc currently being played

### C. Elapsed playing time

The screen may be changed by selecting the elapsed time.

- Select the elapsed playing time ("xx:xx:xx"), and press **SET**.
- Change the elapsed time by pressing **NUMBER keys**.

Hours → Minutes → Seconds are entered in order. If the time entered is not on the disc, the entry will have no effect.

Re-enter the correct time.

e.g., press 0 - 1 - 2 - 3 - 4 - 5 for 01 : 23 : 45.

Hour Minutes Seconds

- This function does not work with some discs.

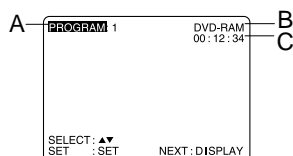

Direct Navigation  
(PROGRAM)

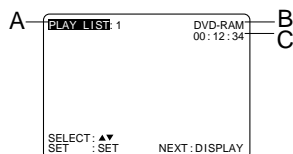

PLAY LIST

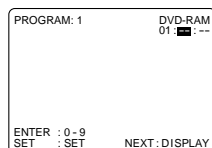

If SET is pressed while making entries, unit returns to the condition it was in before entries were made.

## Notes

- Track No. and the elapsed playing time are not displayed during play started from menu of Video CDs with playback control.
- When  appears on the screen while a button is being operated, it means that the corresponding operation is prohibited by DECK or the disc.

\*Important: if a remote control button does not work when pressed, press the DVD button on the remote and try the button again.

## ■ DECK information screen (for DECK)

### 1. Repeat Play

- Select "REPEAT", and press **SET**.
- Change the desired mode during play by **pressing ▲▼**, and press **SET**.

DVD-Video	CHAPTER	TITLE	OFF
DVD-Audio	TRACK	GROUP	OFF
DVD-RAM	(PROGRAM)	PROGRAM	DISC
	(PLAY LIST)	PLAY LIST	ALL PLAY LIST
Video CD/CD	TRACK	DISC	OFF

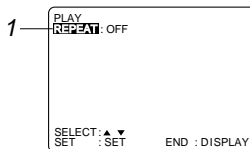

### 2. Play mode [Video CD/ CD only] (See p. 39 or 40.)

PROGRAM PLAY	program play
RANDOM PLAY	random play
----	normal play

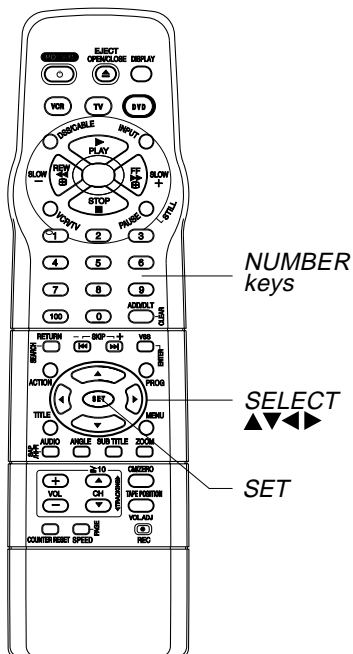
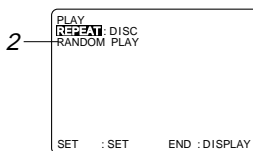

DVD  
Operation

# DVD Operation using On-Screen Displays (continued)

## For your reference

### • CHAPTER/TITLE REPEAT PLAY (DVD-Video)

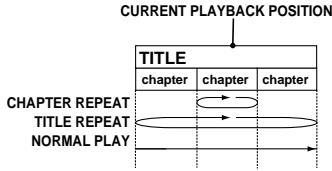

### • TRACK/GROUP REPEAT PLAY (DVD-Audio)

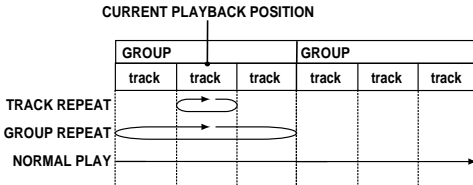

### • TRACK/DISC REPEAT PLAY (Video CD/CD)

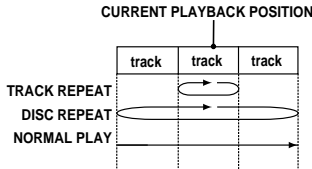

### • PROGRAM/DISC REPEAT PLAY (DVD-RAM [PROGRAM])

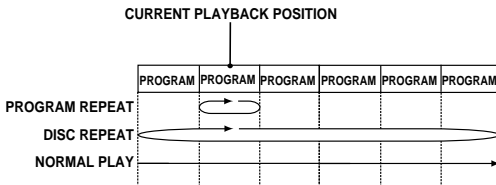

### • PLAY LIST/ALL PLAY LIST REPEAT PLAY (DVD-RAM [PLAY LIST])

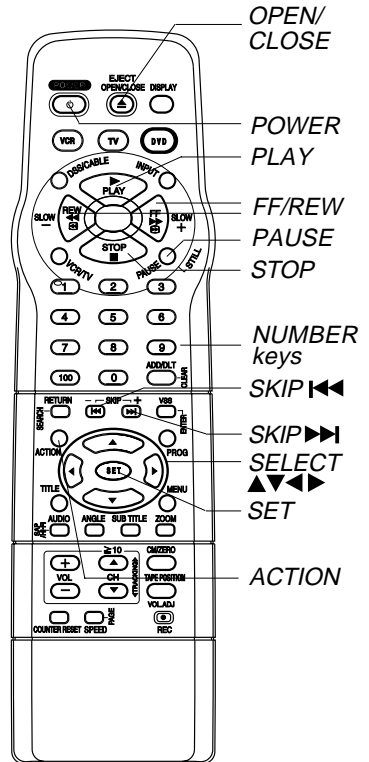
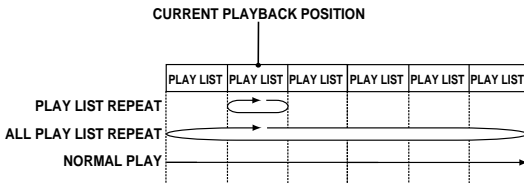

**Note** • For repeat play in VCR mode, see p. 32.

\*Important: if a remote control button does not work when pressed, press the DVD button on the remote and try the button again.



# MP3/WMA/JPEG Playback Operation

This unit can play MP3/WMA/JPEG format CD-R or CD-RW recorded for personal use on a PC, etc. Some discs may not play due to the condition of the recording.

**1** Press **POWER\*** on the remote or **DECK**.

**2** Press **OPEN/CLOSE**, then place an MP3/WMA/JPEG disc into the disc tray.  
Press **OPEN/CLOSE** to close.

**3**

- MP3/WMA/JPEG menu is displayed.
- Playback starts automatically (except JPEG files).
- CD directory is displayed.

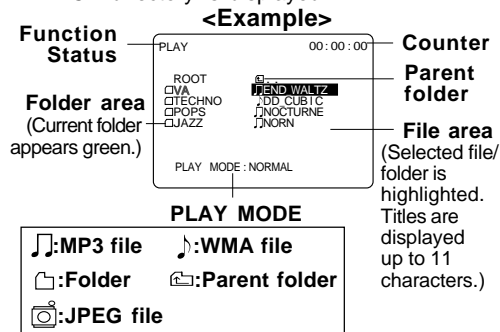

**<Example>** (Diagram left shows CD directory structure as displayed in example OSD above.)

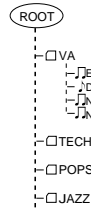

### Notes

- Only File (not Folder) area operation is possible.
- Files are displayed in the following order:  
(!...0,1,...9,A,B,.....Z).

**4**

- **Select file** (During STOP mode)
  - 1) Press **▲▼** to select an MP3/WMA file (🎵/🎵).  
➔ MP3/WMA Playback (see right)
  - 2) Press **▲▼** to select a JPEG file (📷).  
➔ JPEG Playback (see p. 50)
  - 3) Press **SKIP▶▶|** (next) or **◀◀SKIP** (previous) to skip a file/folder page (7files) in the File area.
- **Select folder** (During STOP mode)
  - 1) Press **▲▼** to select a folder (📁).
  - 2) Press **SET** to display files/folders contained in the folder.
- **Select parent folder** (During STOP mode)
  - 1) Press **▲▼** to select a folder (📁).
  - 2) Press **SET** to make changes to the previous directory display.

**5** Press **ACTION** to return to the DVD MAIN MENU. (→ Press **ACTION** again to return to the MP3/WMA/JPEG MENU.)

## MP3/WMA Playback

Do steps 1~3 on left.

**a** Press **▲▼** to select an MP3/WMA file (🎵/🎵).  
(During STOP mode)

**b** Press **SET** or **PLAY** to start playback.

- **Forward/Reverse Search**  
Press **FF/SLOW+** or **REW/SLOW-** during play.  
Press **PLAY** to release.
  - Search speed, slow at first, increases with each additional press of the button up to 5 levels.
- **Forward/Reverse Track Skip**  
Press **SKIP▶▶|** or **◀◀SKIP** during play.  
Each press skips a track.
  - If pressed within first 3 seconds of playback, skips to the previous track. If over 3 seconds, returns to top of track. (◀◀SKIP only.)
  - Put DECK in Stop mode before performing folder/file selection (see step 4.)
- **Pause**  
Press **PAUSE** during play.  
Press **PLAY** to release.

**c** Press **STOP** to stop play.

**d** Press **OPEN/CLOSE** to eject the disc.  
The MP3/WMA/JPEG MENU is closed automatically.

**Note** • Copyright protected files and files containing errors cannot be played back. The DECK skips to the next file.

- **Select PLAY MODE [MP3/WMA Playback]** (During STOP mode)
  - 1) Press **◀▶** to move cursor to PLAY MODE.
  - 2) Press **▲▼** to select the desired PLAY MODE (see below).

### [PLAY MODE]

**NORMAL:**  
All MP3/WMA files are selected and played back one time only.

**SINGLE REPEAT:**  
The selected MP3/WMA file is played back repeatedly.

**FOLDER REPEAT:**  
The MP3/WMA files contained in the selected folder are played back repeatedly. However, folders below the selected folder are not played back.

**DISC REPEAT:**  
All MP3/WMA files are played back repeatedly.

# MP3/WMA/JPEG Playback Operation (continued)

## JPEG Playback

You can play back JPEG images.

**Displayable Image Size:** 32x32~7680x7680 pixels

**Note** • Some JPEG format may not be played back.

Do steps 1~3 on page 49.

**1** Press **▲▼** to select an JPEG file (📷).

**2** Press **SET** or **PLAY**.  
Selected JPEG file is displayed.

[JPEG Playback Screen]

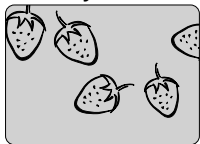

<Example>

- Returned on the MP3/WMA/JPEG MENU  
➔ Press **STOP**. (See p. 49)
- Next/Previous Search  
➔ Press **SKIP▶▶|** or **|◀◀ SKIP**.
- Start Slide-show ➔ Press **FF/SLOW+** or **REW/SLOW-**. (below)
- Enlarging an image ➔ Press **ZOOM**. (P. 51)
- Rotating an image ➔ Press **ANGLE**. (P. 51)

**3** Press **STOP** to return to the MP3/WMA/JPEG MENU.

## JPEG Slide-show

(During JPEG Playback.)

JPEG files are displayed automatically (about every 3 seconds) as a slide-show.

**1** Press **FF/SLOW+** or **REW/SLOW-**.

<Example>



Image changes every 3 seconds.

- **Cancel slide show**  
➔ Press **STOP** to return to the MP3/WMA/JPEG MENU. (See p. 49)
- **Still picture**  
➔ Press **STILL** (only SLIDE).  
➔ Press **PLAY** to release.
- **Forward/Reverse File Skip**  
➔ Press **SKIP▶▶|** or **|◀◀ SKIP**.  
Each press skips a file.

**2** Press **ACTION** to return to the DVD MAIN MENU.

■ Select **PLAY MODE [JPEG Slide-show]**

(During STOP mode) (See p. 49)

- 1) Press **◀▶** to move cursor to **PLAY MODE**.
- 2) Press **▲▼** to select the desired **PLAY MODE** (see below).

### [PLAY MODE]

#### NORMAL:

All JPEG files are selected and played back one time only.

#### SINGLE REPEAT:

The selected JPEG file is played back repeatedly.

#### FOLDER REPEAT:

The JPEG files contained in the selected folder are played back repeatedly. However, folders below the selected folder are not played back.

#### DISC REPEAT:

All JPEG files are played back repeatedly.

<Example>

Operation can be done when files are in order, such as in the diagram below.

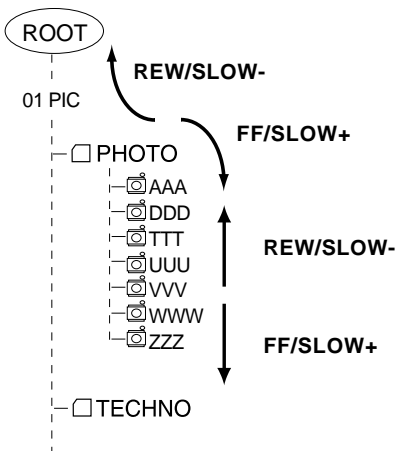

## JPEG Zoom

(During JPEG Playback.)

You can enlarge specific portions of a JPEG picture and select the zoom ratio using the ZOOM button on the remote during JPEG Playback screen.

**Set Zoom size.**

Press **ZOOM** repeatedly to change display as follows.

➔ Press **STOP** to return to the MP3/WMA/JPEG MENU.

- You can enlarge the center portion of the image to one of 2 magnifications.
- Operation can be done during Rotation (below).

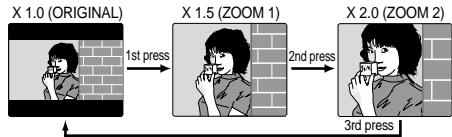

- Use the ▲, ▼, ◀ and ▶ buttons to move the position up, down, left and right. (Position cannot be changed on X1.0 ORIGINAL images.)

## JPEG Rotation

(During JPEG Playback.)

You can rotate a JPEG picture using the ANGLE button on the remote during JPEG Playback screen. (The JPEG picture will be rotated 90° clockwise.)

**Set rotation.**

Press **ANGLE** repeatedly to change display as below.

➔ Press **STOP** to return to the MP3/WMA/JPEG MENU.

- Operation can be done during Zoom (above).
- The vertical/horizontal ratio of rotated JPEG images may vary when they are displayed.

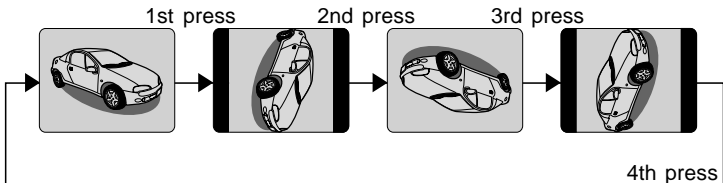

MPEG Layer-3 audio decoding technology licensed from Fraunhofer IIS and Thomson multimedia.

**MP3**  
PLAYBACK

Windows Media, and the Windows logo are trademarks, or registered trademarks of Microsoft Corporation in the United States and/or other countries. WMA is a compression format developed by Microsoft Corporation. It achieves the same sound quality as MP3 with a file size that is smaller than that of MP3.



# DVD Lock Feature

**\*Important:** If a remote control button does not work when pressed, press the DVD button on the remote to power on and try the button again.

You can prevent playback of DVDs of a specific rating level which may be unsuitable for children.

- Some DVDs are encoded with a rating level. If the disc rating is higher (stricter) than the one you preset, playback will be prohibited.

## DVD Lock (DVD-Video only)

A 4-digit code must be entered to view a blocked program or change rating settings.

**1** Press **ACTION\*** to display DVD MAIN MENU.

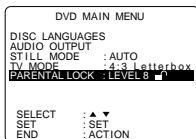

**2** Press **▲▼** to select "PARENTAL LOCK," and press **SET** to display.

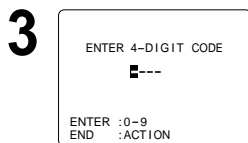

**3**

- 1) Press **NUMBER keys** to enter your secret code.
- 2) Enter same secret code again for confirmation.
- 3) Press **SET** to display.

**To Make Corrections**  
Press **◀** repeatedly to move the cursor.  
Press **NUMBER keys** to make the correction.

- Step 2) not necessary when changing rating or secret code.
- Take care that you are not observed entering the secret code.

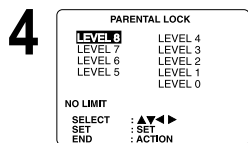

**4** Press **▲▼◀▶** to select rating level, and press **SET** to select "LOCKED" or "UNLOCKED."

**LEVEL 0 :** LOCK ALL, Playback of all DVDs, CDs, Video CDs, WMA, MP3 and JPEG is prohibited. (Use to prohibit play of mature theme DVDs not encoded with rating level.)

**LEVEL 1 :** mature theme DVDs

**LEVEL 2 :** DVDs expressly for children can be played back.

**LEVEL 3 to 7 :** DVDs for general audiences/children can be played back. (DVDs with mature content are prohibited.)

**LEVEL 8 :** NO LIMIT: (Factory preset)  
All DVDs can be played back.



### Ready Checklist

- DECK is in DVD mode, press DVD.

### Caution

**Discs not encoded with rating level will play even if the jacket states it is for mature audiences. For these discs, the DVD Lock Ratings will not work.**

<When DVD Lock is activated>

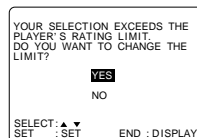

After DVD Lock is set and a blocked DVD is played, this message will appear. The message may differ depending on the disc.

**To continue viewing a blocked program for now,**

Press **▲▼** to select "YES" and SET. Then, enter your 4 digit secret code (see step 3 left).

When "NO" is selected, blocked programs cannot be viewed.

<When blocked programs>

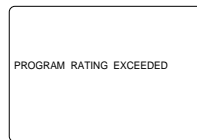

### Change your secret code

- You will need your current code. Do steps 1 ~ 2 left. Enter current secret code. Press **CLEAR** to clear the code. Do step 4 to enter new code.

### Note

- DO NOT forget your secret code.

# Settings for DVD Operation

**1** Press **ACTION** to display DVD MAIN MENU.

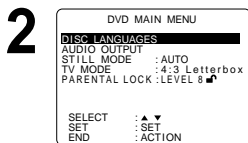

Press **▲▼** to select an item, and press **SET**.

## DISC LANGUAGES (See below)

All languages offered on the disc can be set. If the language not offered is set, the original disc language will be selected.

## AUDIO OUTPUT (See p. 54.)

You can set the audio output that comes from the digital audio output terminal.

## STILL MODE (See p. 57.)

To select "FIELD" (Field still) or "FRAME" (Frame still) to prevent jitter or make small text or fine patterns clearly visible in a still picture. When "AUTO" is set "FIELD" or "FRAME" is selected automatically.

## TV MODE (See p. 57.)

To select whether the video material for a wide-screen will be played back in the Pan & Scan style, Letterbox style or 16 : 9 style.

## Disc Languages (DVD only)

To select and set the language of the audio soundtrack, subtitles, or title/DVD menus for all discs to be played.



Press **▲▼** to select "DISC LANGUAGES," and press **SET** to display screen.



Press **▲▼** to select an item, and press **SET** repeatedly for desired language. (Please refer right.)

**5** Press **ACTION** to redisplay DVD MAIN MENU and go to step 2 to setup another item. Or, press **ACTION** twice to exit.

Once initial settings are done, they remain in memory (even after power off) until changed. This means DECK will operate under the same conditions (especially DVDs) each time.



## Ready Checklist

DECK is in DVD mode, press DVD.

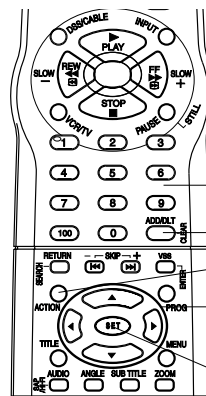

NUMBER keys

CLEAR

ACTION

SELECT

▲▼◀▶

SET

## "AUDIO" selections

(Factory preset: English)

To select the audio soundtrack language.

**English/Spanish/French/Japanese**

**Original:** Original disc language

**OTHER \*\*\*\*:** Other language selection\*1

## "SUBTITLE" selections

(Factory preset: AUTO)

To select the subtitle language.

**AUTO:** Same language selected for "AUDIO"

- If language set for "AUDIO" is used in playback, subtitles will not appear.
- If another language is used during playback, the subtitles will appear in the language selected at "AUDIO" setup.

**English/Spanish/French/Japanese**

**OTHER \*\*\*\*:** Other language selection\*1

## "MENU" selections

(factory preset: English)

To select the language used in title menus or DVD menus.

**English/Spanish/French/Japanese**

**OTHER \*\*\*\*:** Other language selection\*1

To enter **OTHER \*\*\*\*** code number,

Press **NUMBER** keys (Please refer to language codes on page 60).

To make corrections, press **◀** repeatedly to delete language code number, and correct.

\*1 If the selected language is not offered, the original disc language is selected.

# Settings for DVD Operation (continued)

## Audio Output

Select the digital output to be output from the optical digital audio output connector of DECK.

**1** Press **ACTION**<sup>®</sup> to display DVD MAIN MENU.

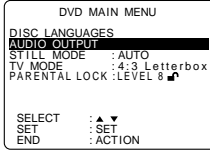

Press **▲▼** to select "AUDIO OUTPUT," and press **SET** to display screen.

**2**

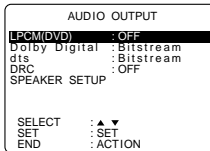

Press **▲▼** to select an item, and press **SET** repeatedly for output. (See below.)

### ■ "LPCM (DVD)" selections

**OFF:** Linear PCM of less than 48 kHz/16 bit is output. When playing DVDs recorded in linear PCM of over 48 kHz/20 bit, no digital audio is output. (Factory preset)

**PCM:** When playing DVDs recorded in linear PCM of 48 kHz/20 bit/24 bit or more, digital audio converted to 44.1 kHz/16 bit or 48 kHz/16 bit is output. (Digital output of PCM audio is restricted to 48 kHz/16 bit or below for copyright protection.)

### ■ "Dolby Digital" selections

**Bitstream:** Dolby Digital bitstream (1 ch - 5.1 ch) is output. (Factory preset)

**PCM:** When you have connected an amplifier that doesn't have a built-in Dolby Digital decoder.

### ■ "dts" selections

**Bitstream:** DTS bitstream is output. (Factory preset)

**PCM:** When you have connected an amplifier that doesn't have a built-in DTS decoder.

### ■ "DRC (Dynamic Range Compression)" selections

**OFF:** Normal audio range is selected. (Factory preset)

**ON:** For dynamic sound even at low volume, this is useful for late-night listening. [Dolby Digital DVDs only].

### ■ SPEAKER SETUP

➔ See pages 55, 56, 57.

**4** Press **ACTION** to redisplay DVD MAIN MENU and go to step 2 to setup another item.

Or, press **ACTION** twice to exit.



### Ready Checklist

DECK is in DVD mode, press DVD.

Type of amplifier to be connected	Recommended setting		
	LPCM (DVD)	Dolby Digital	DTS
No amplifier is connected	---	---	---
AV amplifier (with digital audio input connector) without Dolby Digital/DTS decoder	PCM	PCM*1	PCM*1
AV amplifier including Dolby Digital decoder	PCM	Bitstream	PCM
AV amplifier including Dolby Digital/DTS decoder	PCM	Bitstream	Bitstream*2

• Make settings according to amplifier connected to optical audio output as shown in above table.

\*1 When connecting an amplifier (with an optical digital input connector) which does not contain the Dolby Digital or DTS decoder, be sure to select "PCM". If "Bitstream" is selected, starting DVD play may cause such a high level of noise as to be harmful to your ears and damage the speakers.

\*2 When a DTS decoder is connected, please select "Bitstream" in "dts".

**\*Important:** If a remote control button does not work when pressed, press the DVD button on the remote and try the button again.

## Speaker Output Setup

Set the number of speakers connected to the receiver (amplifier, decoder.) (See pp. 14, 15.)

**1** Do steps 1~3 on page 54.

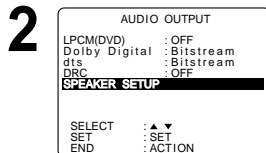

Press **▲▼** to select "SPEAKER SETUP," and press **SET** to display SPEAKER SETUP screen.

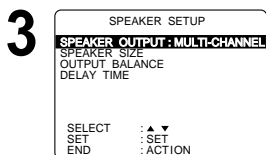

Press **▲▼** to select "SPEAKER OUTPUT," and press **SET** repeatedly. (See below.)

### ■ SPEAKER OUTPUT

**MULTI-CHANNEL:** (Factory preset)

Use this setting when 3 or more speakers are connected. In this case, it is necessary to set [SPEAKER SIZE], [OUTPUT BALANCE], and [DELAY TIME].

**2-CHANNEL:**

When 2 speakers are connected, it is not necessary to set [SPEAKER SIZE], [OUTPUT BALANCE], and [DELAY TIME] (these setting menu are not displayed.)

**4** Press **ACTION** three times to exit.

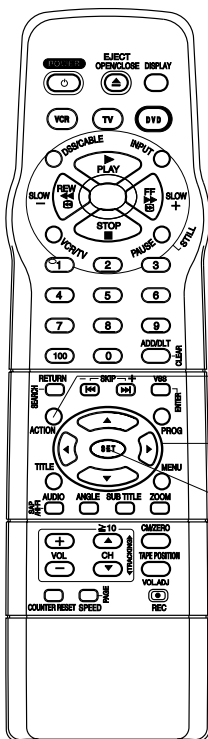

ACTION

SELECT

SET

## Speaker Size Setup

Speaker frequency properties and the existence of speakers is set.

**1** Do steps 1~2 of "Speaker Output Setup" above.

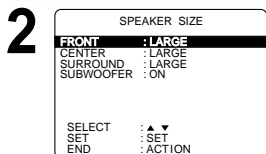

Press **▲▼** to select "SPEAKER SIZE," and press **SET** to display SPEAKER SIZE screen. Press **▲▼** to select an item, and press **SET** repeatedly. (See below table.)

Menu item	Setting	Remark
FRONT	LARGE(factory preset)	When the front speakers (R/L) supports low-frequency (under 100 Hz) reproduction.
	SMALL	Select when the front speakers (R/L) does not support low-frequency reproduction.**
CENTER	LARGE(factory preset)	When the center speaker supports low-frequency (under 100 Hz) reproduction.
	SMALL	Select when the center speaker does not support low-frequency reproduction.
	NONE	If there is no center speaker.
SURROUND	LARGE(factory preset)	When the surround speakers (R/L) supports low-frequency (under 100 Hz) reproduction.
	SMALL	Select when the surround speakers (R/L) does not support low-frequency reproduction.
	NONE	If there is no surround speaker.
SUBWOOFER	ON(factory preset)	If there is a subwoofer.
	OFF	If there is no subwoofer speaker.**

**3** Press **ACTION** four times to exit.

\*\* If SUBWOOFER is set to "OFF," the front speakers are set to LARGE automatically.





\*Important: If a remote control button does not work when pressed, press the DVD button on the remote and try the button again.

## Test Signal Setup

This feature assists in the setting of OUTPUT BALANCE. Starting with (L) front speaker, a test sound is output in clockwise order. While the test signal is output, adjust the output of the center speaker and Surround speaker (R/L).

(See "OUTPUT BALANCE." P. 56.)

### 1 Do steps 1~2 of "Output Balance Setup" on page 56.

**2**

OUTPUT BALANCE	
CENTER	: 0dB
SURROUND(R)	: 0dB
SURROUND(L)	: 0dB
SUBWOOFER	: 0dB
TEST SIGNAL	: OFF
SELECT	: ▲ ▼
SET	: SET
END	: ACTION

**Press ▲▼** to select "TEST SIGNAL," and **press SET.** (See below.)

No sound will come from the subwoofer. Adjust as desired when playing a disc. While the TEST SIGNAL is output, if the setting change in the OUTPUT BALANCE (p. 56) is under 2 seconds, the output will switch to the next speaker. The speaker name from which the TEST SIGNAL is currently being output is displayed.

(Example; "TEST SIGNAL : CENTER")

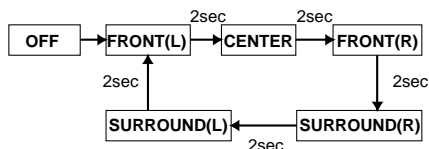

### 3 Press ACTION four times to exit.

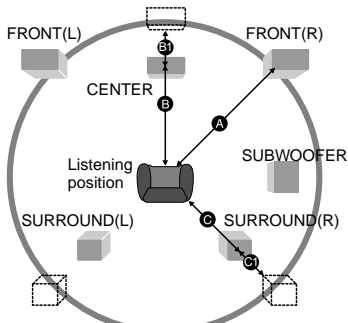

<Speaker Position>

## TV Mode Example

[Pan & Scan (Factory preset)]

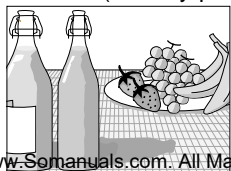

[Letterbox]

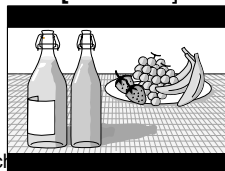

## Still Mode

Set to reduce jitter in a displayed still picture or a motion picture.

### 1 Press ACTION to display DVD MAIN MENU.

**2**

DVD MAIN MENU	
DISC LANGUAGES	AUDIO OUTPUT
STILL MODE	: AUTO
TV MODE	: 4:3 Letterbox
PARENTAL LOCK	: LEVEL 8
SELECT	: ▲ ▼
SET	: SET
END	: ACTION

**Press ▲▼** to select "STILL MODE," and **press SET** repeatedly for mode. (See below.)

**AUTO:** "FIELD" (Field still) or "FRAME" (Frame still) is automatically selected during the still mode. (Factory preset)

**FIELD:** "FIELD" (Field still) is always selected. This setting will reduce jitter when compared with "AUTO" on some discs.

**FRAME:** "FRAME" (Frame still) is always selected. Some texts and fine patterns will be seen clearly when compared with "AUTO" on some discs.

### 3 Press ACTION to exit this mode.

## TV Mode

Set the screen display style for wide-screen video material playback.

### 1 Press ACTION to display DVD MAIN MENU.

**2**

DVD MAIN MENU	
DISC LANGUAGES	AUDIO OUTPUT
STILL MODE	: AUTO
TV MODE	: 4:3 Letterbox
PARENTAL LOCK	: LEVEL 8
SELECT	: ▲ ▼
SET	: SET
END	: ACTION

**Press ▲▼** to select "TV MODE," and **press SET** repeatedly for mode. (See below.)

**4:3 Pan & Scan (Factory preset) :** Wide-screen video data is played in Pan & Scan style (left and right of screen is trimmed.)

- Video data not formatted in Pan & Scan will play in letterbox style.

**4:3 Letterbox :** Wide-screen video data is played in Letterbox style (top and bottom of screen has black margin).

**16:9 :** Set "16:9" when using Wide-screen TV.

### 3 Press ACTION to exit this mode.

# SD Card

## JPEG Playback

Still image data (JPEG) made with a digital camera, digital video camera, or PC can be played back using an SD Memory Card/MultiMediaCard.

**Compatible Card** : An SD Memory Card and MultiMediaCard can be used in this DECK.

**Displayable Image Formats** : DCF format 1.1 compliant

Baseline JPEG format Y Cb Cr (compressed format)  
(Sampling ratios 4:4:4, 4:2:0, 4:2:2, 4:1:1)  
(80 x 60 ~ 5120 x 3840 pixels)

Exif2.1 image data contained in [IMEXPORT] folder used for data transfer between the equipment with SD Memory Card.

- Notes**
- JPEG files altered and saved on a PC as "grayscale" format cannot be displayed.
  - Some parts of an image may not be displayed or the image may be displayed on a smaller scale depending on the size of the image.

### 1 Insert the SD Card. <DVD mode, VCR mode>

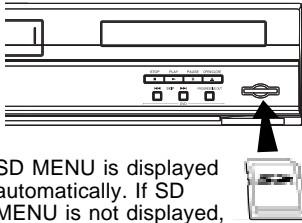

SD MENU is displayed automatically. If SD MENU is not displayed, reinsert the SD Card.

<If in VCR mode with SD card already inserted.>

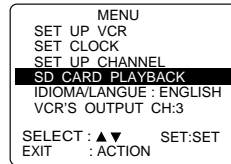

Press ACTION.  
Press ▲▼ to select "SD CARD PLAYBACK."  
Press SET to display.

#### Note

- During Timer REC, the above menu is not displayed. To display the SD Menu, reinsert the SD Card.

### 2 SD MENU DISPLAY

SINGLE PLAY  
SLIDE SHOW

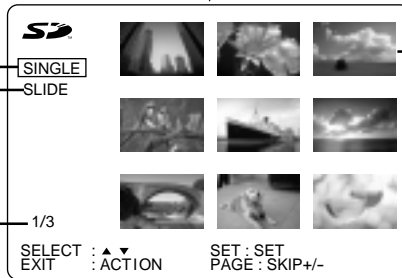

#### INDEX AREA

This area is used to display the files stored within the SD Card.

#### Note

- Up to 1000 files can be displayed.

#### ■ SINGLE PLAY

A single image, selected from the index area, can be enlarged and played back. Also, functions, such as zoom, rotation and applying image information can be performed.

→ See "SINGLE PLAY mode" on page 59.

#### ■ SLIDE SHOW

A slide show presentation can be composed, including various image transition effects and transition speeds.

→ See "SLIDE SHOW mode" on page 59.

#### ■ Return to VCR Mode,

→ Press ACTION.

#### Note

- "SD" blinks while data is being read.

#### Multi Function Display

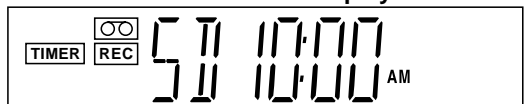

"SD" appears when in SD mode.

## SINGLE PLAY mode

Do steps 1 - 2 on p. 58.

1



Press ▲▼ to select "SINGLE," and press SET. Press ▲▼◀▶ to move cursor to desired file in INDEX AREA.

(Press SKIP +/- to display next/previous page of 9 thumbnail files), Press SET to display file in large size.

Press SKIP+ → next image.  
Press SKIP- → previous image.

### ■ ZOOM (Enlarge Image)

Image can be displayed 2 or 4 times normal size.

→ Press ZOOM repeatedly.

### ■ ROTATE

Image can be rotated clockwise in 90° increments.

→ Press ANGLE repeatedly.

■ Start Slide-show → Press PLAY. (See below.)

■ Display file information screen → Press DISPLAY.

2 Press ACTION to exit this mode.

## Notes

- Once selected, image is displayed in about 3 sec. ("SD" appears while data is read. DO NOT remove SD Card during data reading.)
- Deck buttons are inoperative. Use remote control.
- If cursor is at top of the INDEX AREA, pressing "▲" selects previous page. If cursor is at bottom of the INDEX AREA, pressing "▼" selects next page.
- If Rotate is operated while Zoom (X2 or X4) is displayed, the unit will revert to X1 (ORIGINAL) magnification.

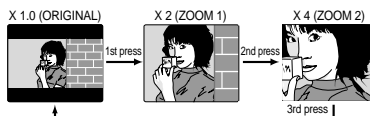

## File information screen

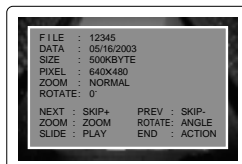

[START]  
Starts slide show.

[SPEED]  
FAST:  
Image transition every 2 seconds.

MEDIUM:  
Image transition every 5 seconds.

SLOW:  
Image transition every 10 seconds.

[Transition]  
NORMAL:  
Image transition one by one.

WIPE:  
Image transition from top to bottom.

SPLIT:  
Image transition beginning at the center and splitting to the left and right.

BLIND:  
Image transition in a series of band-like shapes that resemble window blinds.

## SLIDE SHOW mode

Do steps 1 - 2 on p. 58.

1

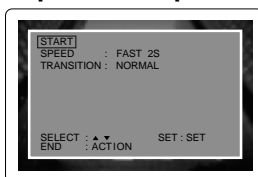

SLIDE MENU

Press ▲▼ to select "SLIDE," and press SET. Press ▲▼◀▶ to move cursor to desired file in INDEX AREA.

(Press SKIP +/- to display next/previous page of 9 thumbnail files).

Press SET to display SLIDE MENU.

Press ▲▼ to select an item (see right), and press SET repeatedly to set.

2 START SLIDE SHOW.



### ■ PAUSE

Press PAUSE. → Press PLAY to release.

■ Press SET to return SLIDE MENU (above).

3 Press ACTION to exit this mode.

# Language Code List

Enter the appropriate code number for the initial settings "AUDIO", "SUBTITLE" and/or "MENU" (see p. 53).

Code	Language	Code	Language	Code	Language	Code	Language
6565	Afar	7079	Faroese	7678	Lingala	8375	Slovak
6566	Abkhazian	7082	French	7679	Laothian	8376	Slovenian
6570	Afrikaans	7089	Frisian	7684	Lithuanian	8377	Samoan
6577	Ameharic	7165	Irish	7686	Latvian, Lettish	8378	Shona
6582	Arabic	7168	Scots Gaelic	7771	Malagasy	8379	Somali
6583	Assamese	7176	Galician	7773	Maori	8381	Albanian
6588	Aymara	7178	Guarani	7775	Macedonian	8382	Serbian
6590	Azerbaijani	7185	Gujarati	7776	Malayalam	8385	Sundanese
6665	Bashkir	7265	Hausa	7778	Mongolian	8386	Swedish
6669	Byelorussian	7273	Hindi	7779	Moldavian	8387	Swahili
6671	Bulgarian	7282	Croatian	7782	Marathi	8465	Tamil
6672	Bihari	7285	Hungarian	7783	Malay	8469	Telugu
6678	Bengali; Bangla	7289	Armenian	7784	Maltese	8471	Tajik
6679	Tibetan	7365	Interlingua	7789	Burmese	8472	Thai
6682	Breton	7378	Indonesian	7865	Nauru	8473	Tigrinya
6765	Catalan	7383	Icelandic	7869	Nepali	8475	Turkmen
6779	Corsican	7384	Italian	7876	Dutch	8476	Tagalog
6783	Czech	7387	Hebrew	7879	Norwegian	8479	Tonga
6789	Welsh	7465	Japanese	7982	Oriya	8482	Turkish
6865	Danish	7473	Yiddish	8065	Panjabi	8484	Tatar
6869	German	7487	Javanese	8076	Polish	8487	Twi
6890	Bhutani	7565	Georgian	8083	Pashto, Pushto	8575	Ukrainian
6976	Greek	7575	Kazakh	8084	Portuguese	8582	Urdu
6978	English	7576	Greenlandic	8185	Quechua	8590	Uzbek
6979	Esperanto	7577	Cambodian	8277	Rhaeto-Romance	8673	Vietnamese
6983	Spanish	7578	Kannada	8279	Romanian	8679	Volapük
6984	Estonian	7579	Korean	8285	Russian	8779	Wolof
6985	Basque	7583	Kashmiri	8365	Sanskrit	8872	Xhosa
7065	Persian	7585	Kurdish	8368	Sindhi	8979	Yoruba
7073	Finnish	7589	Kirghiz	8372	Serbo-Croatian	9072	Chinese
7074	Fiji	7665	Latin	8373	Singhalese	9085	Zulu

# Warning and Instruction Displays

These displays will alert you to a missed operation or provide further instructions.

OSD	Caution	Page
PLEASE SET CLOCK BY PRESSING ACTION KEY	If you attempt to set or review a Timer Recording and the Clock is not set...	24
PLEASE PREPARE FOR TIMER REC	If DECK is not in Stop mode or a cassette with record tab is not inserted 2 minutes before a Timer Recording is about to begin...	24 25
CHECK CASSETTE RECORD TAB	If you press REC on the remote control or DECK, and a cassette is inserted with no record tab...	6
NO CASSETTE	If you press PLAY, FF, REW, or REC on the remote control or DECK without a cassette inserted...	20 21
TO CANCEL TIMER REC HOLD DOWN STOP KEY FOR APPROX 3 SEC	If you press STOP or POWER during a Timer Recording... (visible in VCR mode only)	25
VIDEO HEADS MAY NEED CLEANING PLEASE INSERT HEAD CLEANING CASSETTE OR REFER TO MANUAL  END : PLAY	If head cleaning becomes necessary while playing back a tape...	4
VCR LOCK ACTIVATED	If you press a function button other than STOP/EJECT or POWER while DECK is in VCR Lock mode...	33
REMOTE CONTROL IS SET TO CABLE/DSS MODE USE VCR : VCR KEY USE DVD : DVD KEY	If you press an invalid key on the remote while in CABLE/DSS mode...	28 29 34
REMOTE CONTROL IS SET TO TV MODE USE VCR : VCR KEY USE DVD : DVD KEY	If you press an invalid key on the remote while in TV mode...	28 29 34
PLEASE CHECK THE DISC, AND FOR STAINS OR SCRATCHES ON DISC	If you press PLAY, and DECK reads data from a stained or scratched disc in DVD mode.	6
THIS DISC MAY NOT BE PLAYED IN YOUR REGION	Playback of a disc with different region number was attempted. Only discs marked region "1", "ALL", or those that include "1" are playable on this DECK.	3
THIS TYPE OF DISC CANNOT BE PLAYED. PLEASE INSERT A DIFFERENT DISC	An unusable disc is inserted in the DECK.	6
CANNOT PLAY THIS FILE	This file format cannot be played. (Appears during MP3/WMA/JPEG file playback)	49
THIS FILE IS PROTECTED	This file is copyright protected and cannot be played back. (Playback is prohibited.) (WMA only)	49
IT IS PROHIBITED TO COPY DVD/VIDEO CD/CD TO VHS	If you press REC in DVD mode...	21
DATA ERROR	An image file could not be displayed. The file is corrupt or the format is incompatible.	58
CARD ERROR	SD Memory Cards that have been formatted to FAT32 specifications cannot be used.	58

# Before Requesting Service

Check the following points if you are having trouble with your DECK.

<b>Power</b>	<b>Correction</b>
No power...	<ul style="list-style-type: none"> <li>• Completely insert Power Plug into an AC outlet.</li> <li>• Set POWER button to on.</li> <li>• Make sure power source is active.</li> </ul>
Power turns itself off...	<ul style="list-style-type: none"> <li>• Auto power-off (shutoff) occurs after about 5 min. in DVD mode with no operation, or if there is no broadcast signal in TV or Playback mode. Turn the power back on. (pp. 23, 33)</li> </ul>
<b>Recording &amp; Playback</b>	<b>Correction</b>
TV program cannot be recorded...	<ul style="list-style-type: none"> <li>• Check connections between DECK, external antenna, and TV.</li> <li>• Check channel selections.</li> <li>• Make sure your antenna system (CABLE or TV) is correctly set. (Channels [p. 18])</li> <li>• Make sure cassette record tab is intact. (p. 6)</li> </ul>
Timer recording cannot be performed...	<ul style="list-style-type: none"> <li>• Confirm that clock is set to current time and date.</li> <li>• Make sure Cable/DSS box (if used) is left on and tuned to channel to be recorded.</li> <li>• Set recording start/stop times correctly. (p. 24)</li> <li>• Timer recording may not be performed or continued if a power interruption occurs before or during a Timer Recording, even after power is restored.</li> </ul>
There is no playback picture, or the playback picture is noisy or contains streaks...	<ul style="list-style-type: none"> <li>• Select channel 3 or 4 on TV to match VCR output channel (3 or 4) (p. 16) or select LINE.</li> <li>• Set VCR/TV selector to "VCR."</li> <li>• Adjust TRACKING control in either direction. (p. 4)</li> <li>• Try Head Cleaning. (p. 4)</li> </ul>
During special effects playback, picture may contain some vertical jitter when using a TV with an Automatic Vertical Hold Control...	<ul style="list-style-type: none"> <li>• Set TV's Vertical Hold Control to MANUAL, then adjust.</li> </ul>
DECK cannot be controlled...	<ul style="list-style-type: none"> <li>• Make sure DECK power is on.</li> <li>• Check Remote batteries.</li> <li>• Make sure VCR LOCK is set to off. (p. 33)</li> <li>• Make sure Remote is in proper mode. (p. 28)</li> <li>• Make sure Timer Recording is not in progress.</li> </ul>
<b>Remote Control</b>	<b>Correction</b>
DECK cannot be remote controlled...	<ul style="list-style-type: none"> <li>• Make sure DECK power is on.</li> <li>• Make sure Remote is in VCR mode.</li> <li>• Aim Remote Control directly at remote sensor on DECK. (p.9)</li> <li>• Avoid any object blocking signal path.</li> <li>• Check Remote batteries. (p. 4)</li> <li>• Exposing DECK remote sensor to direct fluorescent or outdoor light may cause signal interference.</li> </ul>
PROG buttons do not respond...	<ul style="list-style-type: none"> <li>• PROG functions are not available in COMPONENT Video Output and S-VIDEO OUT. Set TV to either RF IN or VIDEO IN. (p. 10)</li> <li>• Check Remote batteries. (p. 4)</li> <li>• Press VCR or DVD button for DVD/VCR mode. (p. 28)</li> </ul>

Check the following points if you are having trouble with your DECK.

DVD/ Video CD/ CD	Correction
Play fails to start even when PLAY is pressed...	<ul style="list-style-type: none"> <li>This DECK cannot play discs other than DVDs, Video CDs and CDs.</li> <li>The disc may be dirty and require cleaning.</li> </ul>
Play starts but then stops immediately...	<ul style="list-style-type: none"> <li>Be sure disc is installed with label side up.</li> </ul>
Picture is distorted during rapid advance or rapid reverse...	<ul style="list-style-type: none"> <li>The picture will be somewhat distorted at times: this is normal.</li> </ul>
No Forward/Reverse Scene Search play...	<ul style="list-style-type: none"> <li>Some discs may have sections which prohibit Forward/Reverse Scene Search. (p. 23)</li> </ul>
Play does not start even when title is selected...	<ul style="list-style-type: none"> <li>Confirm the "DVD LOCK" setting. (p. 52)</li> </ul>
Audio soundtrack and/or subtitle language is not the one selected at the initial settings...	<ul style="list-style-type: none"> <li>If the audio soundtrack and/or subtitle language selected at DVD initial settings does not exist on the disc, it will not be accessible.</li> </ul>
No subtitles...	<ul style="list-style-type: none"> <li>Subtitles appear only when available on disc.</li> <li>"OFF" is selected at the changing subtitle language. Select "ON" at the "Subtitle Languages" section (p. 36) to display the subtitles.</li> </ul>
Alternative audio soundtrack (or subtitle) language cannot be selected...	<ul style="list-style-type: none"> <li>Alternative language cannot be selected with discs which do not contain more than one language.</li> <li>For some discs, alternative language cannot be selected with the AUDIO or SUB TITLE button. Try selecting it from the DVD MAIN MENU if available.</li> </ul>
Angle cannot be changed...	<ul style="list-style-type: none"> <li>This function is dependent on software availability. Even if disc has multiple angles, they may be recorded for specific scenes only (ANGLE indicator on DECK lights up). (p. 37)</li> </ul>
Miscellaneous	Correction
Programs cannot be viewed on TV...	<ul style="list-style-type: none"> <li>Make sure TV is set to output of DECK.</li> <li>Check connections between DECK, external antenna, and TV.</li> <li>Set VCR/TV selector to "TV." (p. 21)</li> <li>Make sure proper signal source is selected.</li> </ul>
Video cassette cannot be inserted...	<ul style="list-style-type: none"> <li>Insert the cassette with window side up; record tab facing you.</li> </ul>
Video cassette ejects when a recording is started or the power is turned off for timer recording...	<ul style="list-style-type: none"> <li>Make sure cassette record tab is intact. (p. 6)</li> </ul>
In Stop mode, the motor (CYLINDER) continues to rotate...	<ul style="list-style-type: none"> <li>To enable Quick play mechanism, the cylinder will rotate for about 3 minutes. This reduces response time from Stop to Play mode.</li> </ul>
The disc cannot be removed..	<ul style="list-style-type: none"> <li>First, unplug DECK. Then, prepare a rigid wire (e.g. an extended paper clip) and, applying moderate force, insert it straight into the hole at the base of the tray. The tray will eject a little. Now, pull the tray all the way out and remove the disc. (p. 9)</li> </ul>

If you cannot resolve the problem, please call the Customer Call Center for product assistance at 1-800-211-PANA (7262).

To locate an authorized servicer, please call toll free 1-800-211-PANA (7262).

or send e-mail to [consumerproducts@panasonic.com](mailto:consumerproducts@panasonic.com) Search And Download.

# Limited Warranty

PANASONIC CONSUMER ELECTRONICS COMPANY,  
DIVISION OF MATSUSHITA ELECTRIC  
CORPORATION OF AMERICA  
One Panasonic Way  
Secaucus, New Jersey 07094

PANASONIC SALES COMPANY,  
DIVISION OF MATSUSHITA  
ELECTRIC OF PUERTO RICO, INC.,  
AVE. 65 de Infantería, Km. 9.5  
San Gabriel Industrial Park  
Carolina, Puerto Rico 00985

## Panasonic DVD/VCR Deck Limited Warranty

### Limited Warranty Coverage

If your product does not work properly because of a defect in materials or workmanship, Panasonic Consumer Electronics Company or Panasonic Sales Company (collectively referred to as "the warrantor") will, for the length of the period indicated on the chart below, which starts with the date of original purchase ("Limited Warranty period"), at its option either (a) repair your product with new or refurbished parts, or (b) replace it with a new or a refurbished product. The decision to repair or replace will be made by the warrantor.

Product or Part Name	Parts	Labor
DVD/VCR Deck	One (1) Year	Ninety (90) Days
Rechargeable Batteries (in exchange for defective item)	Ten (10) Days	Not Applicable

During the "Labor" Limited Warranty period there will be no charge for labor. During the "Parts" warranty period, there will be no charge for parts. You must mail-in your product during the warranty period. If non-rechargeable batteries are included, they are not warranted. This Limited Warranty only applies to products purchased and serviced in the United States or Puerto Rico. This Limited Warranty is extended only to the original purchaser and only covers product purchased as new. A purchase receipt or other proof of original purchase date is required for Limited Warranty service.

### Mail-In Service

For assistance in the continental U.S.A. in obtaining repairs please ship the product to:

**Panasonic Services Company**  
**Customer Servicer**  
**Suite B**  
**4900 George McVay Drive**  
**McAllen, TX 78503**

For assistance in Puerto Rico call Panasonic Sales Company (787)-750-4300 or fax (787)-768-2910.

When shipping the unit carefully pack and send it prepaid, adequately insured and preferably in the original carton. Include a letter detailing the complaint and provide a day time phone number where you can be reached.

**IF REPAIR IS NEEDED DURING THE LIMITED WARRANTY PERIOD THE PURCHASER WILL BE REQUIRED TO FURNISH A SALES RECEIPT/PROOF OF PURCHASE INDICATING DATE OF PURCHASE, AMOUNT PAID AND PLACE OF PURCHASE. CUSTOMER WILL BE CHARGED FOR THE REPAIR OF ANY UNIT RECEIVED WITHOUT SUCH PROOF OF PURCHASE.**



## Limited Warranty Limits And Exclusions

This Limited Warranty ONLY COVERS failures due to defects in materials or workmanship, and DOES NOT COVER normal wear and tear or cosmetic damage. The Limited Warranty ALSO DOES NOT COVER damages which occurred in shipment, or failures which are caused by products not supplied by the warrantor, or failures which result from accidents, misuse, abuse, neglect, mishandling, misapplication, alteration, faulty installation, set-up adjustments, misadjustment of consumer controls, improper maintenance, power line surge, lightning damage, modification, or commercial use (such as hotel, office, restaurant, or other business), rental use of the product, or service by anyone other than a Factory Servicenter or other Authorized Servicer, or damage that is attributable to acts of God.

**THERE ARE NO EXPRESS WARRANTIES EXCEPT AS LISTED UNDER "LIMITED WARRANTY COVERAGE". THE WARRANTOR IS NOT LIABLE FOR INCIDENTAL OR CONSEQUENTIAL DAMAGES RESULTING FROM THE USE OF THIS PRODUCT, OR ARISING OUT OF ANY BREACH OF THIS WARRANTY.** (As examples, this excludes damages for lost time, cost of having someone remove or re-install an installed unit if applicable, travel to and from the servicer, loss of or damage to media or images, data or other recorded content. The items listed are not exclusive, but are for illustration only.)

**ALL EXPRESS AND IMPLIED WARRANTIES, INCLUDING THE WARRANTY OF MERCHANTABILITY, ARE LIMITED TO THE PERIOD OF THE LIMITED WARRANTY.**

Some states do not allow the exclusion or limitation of incidental or consequential damages, or limitations on how long an implied Limited Warranty lasts, so the exclusions may not apply to you.

This Limited Warranty gives you specific legal rights and you may also have other rights which vary from state to state. If a problem with this product develops during or after the Limited Warranty period, you may contact your dealer or Servicenter. If the problem is not handled to your satisfaction, then write to the warrantor's Consumer Affairs Department at the addresses listed for the warrantor.

**PARTS AND SERVICE, WHICH ARE NOT COVERED BY THIS LIMITED WARRANTY, ARE YOUR RESPONSIBILITY.**

# Customer Services Directory

For Product Information, Operating Assistance, Literature Request, Dealer Locations, and Customer Service inquiries please visit Web Site:

<http://www.panasonic.com>

*You can purchase parts, accessories, locate your nearest servicenter and more by visiting our Web Site or E-mail us via web:*

[http://www.panasonic.com/consumer\\_electronics/support/customerfeedback.asp](http://www.panasonic.com/consumer_electronics/support/customerfeedback.asp)

Contact:

1-800-211-PANA (7262),

Monday-Friday 9 am-9 pm; Saturday-Sunday 10 am-7 pm, EST.

For hearing or speech impaired TTY users, TTY : 1-877-833-8855

## Accessory Purchases

1-800-332-5368 (Customer Orders Only)

1-800-237-9080 (Fax Only)

(Monday-Friday 9 am-8 pm, EST.) Panasonic Services Company

20421 84th Avenue South, Kent, WA 98032

(Accepts Visa, MasterCard, Discover Card, American Express, and Personal Check)

<http://www.pasc.panasonic.com> or email to [parts@panasonic.com](mailto:parts@panasonic.com)

For hearing or speech impaired TTY users, TTY : 1-866-605-1277

## Service in Puerto Rico

Matsushita Electric of Puerto Rico, Inc. Panasonic Sales Company/ Factory Servicenter:

Ave. 65 de Infantería, Km. 9.5, San Gabriel Industrial Park, Carolina, Puerto Rico 00985

Phone (787)750-4300 Fax (787)768-2910

For Your  
Information

## CONEXIONES/CONFIGURACION INICIAL (READY TO PLAY)

Realice la conexión de la antena o TV por cable antes de enchufar el cable de CA.

EL DVD/VCR iniciará automáticamente la fijación de los canales y del reloj al enchufar el cable de CA.

## CONEXIONES

### Para Ant/Cable → DVD/VCR → TV

- 1 Conecte el cable de la antena al terminal IN FROM ANT del DVD/VCR.
- 2 Conecte el terminal OUT TO TV del DVD/VCR a la entrada de la antena VHF/UHF del TV con el cable RF incluido.

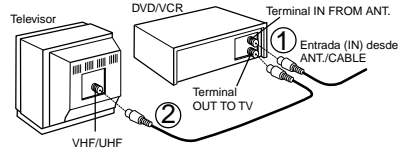

### Para Sistema Digital de Satellite (DSS)/ Convertidor de cable → DVD/VCR → TV

- 1 Conecte la salida de convertidor de cable al terminal IN FROM ANT.
- 2 Conecte el terminal OUT TO TV del DVD/VCR a la entrada de la antena VHF/UHF del TV con el cable RF incluido.

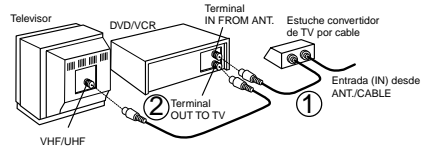

## CONFIGURACION INICIAL

- 1 Encienda el TV y cambie al canal 3.
- 2 Enchufe el cable de CA. El DVD/VCR se encenderá e iniciará las fijaciones de los canales y del reloj.

- Si no aparece la pantalla de abajo, compruebe la conexión del DVD/VCR-TV y si el canal del TV está a 3, intente cambiando al canal 4.
- Para cambiar el canal de salida del DVD/VCR, consulte las instrucciones de "Canal de salida del VCR" (informaciones en inglés página 19).

### Enchufe el cable de CA.

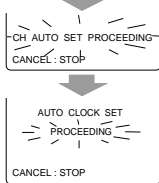

Al inicio, el idioma de la pantalla está fijado a inglés.

Para cambiar el idioma, seleccione la pantalla MENU (informaciones en inglés página 18).

Si está usando un convertidor de TV por cable y en su area hay un canal de Public Broadcast Station (PBS), ajuste su convertidor al canal PBS de su area. Si está usando un receptor DSS, este debe estar apagado.

### Nota

- Los botones de funciones no funcionan durante la configuración inicial.
- Para retirar un cassette durante el ajuste automático, presione EJECT en el control remoto o STOP dos veces en el aparato. En este caso, los ajustes de los canales y la hora se deben hacer manualmente. Para los ajustes seleccione la pantalla MENU (informaciones en inglés página 18).
- Dependiendo de las condiciones, el ajuste automático puede durar más de 30 minutos. En ese caso, presione STOP para detener el ajuste automático y realice los ajustes manualmente en la pantalla MENU.

- 3 Las fijaciones se realizan automáticamente. Cuando termina las fijaciones, aparecerá la siguiente pantalla.



Si aparece en la pantalla "AUTO CLOCK SET IS INCOMPLETE (FIJACION AUTOMATICA DEL RELOJ ES INCOMPLETO)", Ajuste el reloj como se describe a continuación.

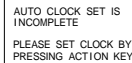

## AJUSTE MANUAL DEL RELOJ

Si la fijación ha sido incompleta.

- 1 Presione la tecla ACTION en el control remoto para visualizar la pantalla del menú SET CLOCK.

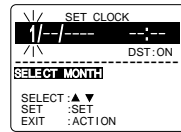

- 2 Presione ▲ ▼ para seleccionar el mes y SET para ajustar. De la misma forma, seleccione y ajuste la fecha, año, hora y DST (hora de verano).



- 3 Presione dos veces la tecla ACTION para poner el RELOJ en marcha y salir.

### PRECAUCION

Al usar cables coaxiales RF del tipo "tuerca", apriételos solamente con los dedos. Un apriete excesivo puede dañar los terminales.

## Operaciones básicas para la reproducción

- 1 Inserte un cassette.**
  - La alimentación del DECK se activa. En la Pantalla de Visualización Multi Función se ilumina "VCR".
- 2 Presione PLAY** para reproducir el cassette.
  - Si el cassette no tiene la lengüeta de prevención de grabación (página 6), se inicia la reproducción automáticamente.

### Detalles especiales durante la grabación

- **Presione FF/SLOW+ o REW/SLOW-** para búsqueda de escenas hacia delante/ hacia atrás. **Presione PLAY** para liberar. Durante la búsqueda, cada vez que **presione FF/SLOW+ o REW/SLOW-** se cambia la velocidad como sigue:  
 [SLP] aprox. 21X ↔ aprox. 9X  
 [LP] aprox. 9X ↔ aprox. 7X  
 [SP] aprox. 7X ↔ aprox. 3X  
 Si la imagen se interrumpe con la velocidad de 21x, 9x o 7x, cambie la velocidad a 9x, 7x o 3x.
  - **Presione PAUSE/STILL** para imagen Fija (Congelada).  
**Presione PLAY** para liberar.
  - **Presione PAUSE/STILL** en el modo de imagen fija para imágenes cuadro a cuadro.  
**Presione PLAY** para liberar.
  - **Presione FF/SLOW+ o REW/SLOW-** en el modo de imagen fija para cambiar la velocidad de las imágenes a cámara lenta.
- 3 Presione STOP** para detener el cassette.
    - **Presione REW/SLOW- o FF/SLOW+** en el modo de parada para rebobinado/avance rápido del cassette.
    - **Presione EJECT** en el control remoto, o **STOP/EJECT** en el DECK para expulsar el cassette.

## Operaciones básicas para la grabación

- 1 Inserte el cassette con lengüeta de protección de grabación (página 6).**
- 2 Presione CH ▲/▼, o las teclas de números** para seleccionar el canal.
- 3 Presione SPEED** para seleccionar la velocidad de grabación (página 6).
  - SP = Reproducción estándar,
  - LP = Larga duración,
  - SLP = Superlarga duración.
- 4 Presione REC** para comenzar a grabar.
  - Para eliminar escenas indeseadas, presione PAUSE/STILL para hacer una pausa, y al presionar nuevamente continua la grabación.
  - No podrá ver otro canal durante la grabación.

- 5 Presione STOP** para detener la grabación.

## Programación fácil para la grabación con temporizador

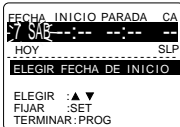
- 1 Presione PROG** para visualizar la pantalla de Programación.
- 
  - 1) Para ajustar la FECHA de grabación, presione ▲▼** para seleccionar:  
 1-31 = una vez, o  
 DIARIO = a la misma hora de lunes a viernes, o  
 SEMANA = a la misma hora cada semana y  
 presione SET para ajustar.

### Orden para elegir

Ejemplo

Fecha de hoy — 

- 2) Para ajustar los ítems que quedan, presione ▲▼** para seleccionar y **presione SET** para ajustar los tiempos de INICIO/ PARADA, CANAL, o entrada de LINEA (página 35), y velocidad del cassette (SP, LP, SLP).  
**Presione PROG** para finalizar PROGRAM.

3

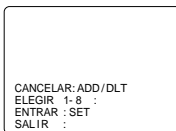

- Presione ▲▼** para seleccionar un número que no está usando para ingresar mas programas y **presione SET** para ajustar.  
 Luego repita el paso 2.  
 O  
**Presione nuevamente PROG** para salir.

### ■ Grabación de un toque

- Presione REC** repetidamente para ajustar la hora de grabación (30 min - 4 horas).
- La videograbadora termina la grabación a una hora programada.

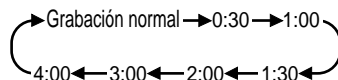

## Operaciones básicas del DVD

- 1** Presione **POWER** en el control remoto o el aparato.
- 2** Presione **DVD** para seleccionar el modo DVD.
- 3**
  - 1) Presione **OPEN/CLOSE**.
  - 2) Ponga un disco en la bandeja de disco.
    - Sujete el disco sin tocar ninguna de sus superficies, póngalo con el lado donde esté impreso el título hacia arriba, alinéelo con las guías y póngalo en su posición apropiada. Disco de 3" (8 cm) / Disco de 5" (12 cm)
- 4** Presione **PLAY** para iniciar la reproducción. La bandeja del disco se cierra automáticamente.
  - Si está usando un DVD interactivo (Interactive DVD) o un Video CD con control de reproducción (playback control) y aparece un menú de títulos (TITLE MENU) en la pantalla, siga al paso 5.
- 5** Presione **▲▼◀▶** o las teclas numéricas para seleccionar el artículo deseado. Presione **SET** o **PLAY** para la reproducción. Si usa las teclas numéricas, la reproducción comienza automáticamente.
- 6** Presione **STOP** para parar la reproducción.
- 7** Presione **OPEN/CLOSE** para expulsar el disco.

### ■ Para buscar una escena particular Búsqueda hacia adelante

Presione **FF/SLOW+** en el modo de reproducción.

### Búsqueda hacia atrás

Presione **REW/SLOW-** en el modo de reproducción. (Para liberar, presione **PLAY**)

### ■ Para saltar un capítulo o una pista Salto hacia adelante

Presione **SKIP ►►** en el modo de reproducción. Un capítulo (Video DVD) o una pista (Audio DVD/Video CD/CD) se salta cada vez que se oprime la tecla.

### Salto hacia atrás

Presione **◄◄ SKIP** en el modo de reproducción.

### ■ Para ver una imagen fija

Presione **PAUSE/STILL** durante la reproducción. (Para liberar, presione **PLAY**)

### ■ Para ver imágenes cuadro a cuadro (DVD/Video CD)

Presione **PAUSE/STILL** en el modo de imagen fija. La imagen avanza un cuadro cada vez que presiona la tecla. (Para volver a la reproducción normal, presione **PLAY**)

### ■ Para ver en cámara lenta (DVD/Video CD)

Presione **FF/SLOW+** o **REW/SLOW-** en el modo de imagen fija. (Para liberar, presione **PLAY**)

## Funcionamiento del DVD utilizando visualizaciones en pantalla

Quando se presiona **DISPLAY**, la visualización en pantalla muestra la información del disco (título / capítulo / número de lista, tiempo transcurrido de reproducción, audio / idioma del subtítulo, y ángulo) e información (repetir la reproducción, modo reproducción, Karaoke vocal encendido / apagado, etc.).

### 1 Presione **DISPLAY** en el modo reproducción o parada para visualizar las visualizaciones en pantalla.

• Cada vez que se presione **DISPLAY**, la visualización en pantalla cambia como se muestra a continuación.

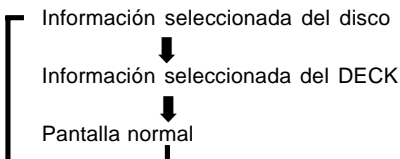

### 2 Presione **▲▼** (o **◀▶**) para seleccionar el ítem deseado.

Presione **SET** para ajustar.

### 3 Presione **▲▼** para seleccionar el ajuste deseado.

Presione **SET** para ajustar.

Para volver a la pantalla normal, Presione repetidamente **CLEAR** o **DISPLAY**.

### <Ejemplo (Video DVD)>

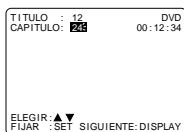
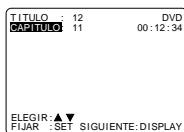

### <Ejemplo (Video CD)>

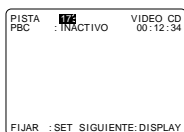
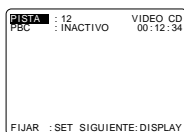

### <Ejemplo (Audio DVD)>

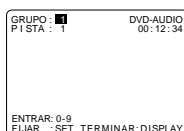
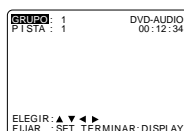





## Ejecución de JPEG con Tarjeta SD

Los datos de imagen fija (JPEG) creados mediante la cámara digital, la cámara de video digital o el PC se pueden ejecutar utilizando una tarjeta SD/MMC.

Inserte la tarjeta SD

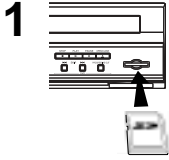

<El modo VCR y la tarjeta SD ya han sido insertados.>



**Presione ACTION.**  
Presione **▲▼** para seleccionar "SD CARD REPRODUCCION," y presione **SET** para visualizar la pantalla del MENU SD.

### Nota

- Durante la grabación el menú de arriba no se visualiza. Para visualizar el menú SD, reinserte la tarjeta SD.

Cambia la pantalla MENU SD automáticamente.

## 2 VISUALIZACION DEL MENU SD.

EJECUCION UNICA  
MUESTRA-DIAPOSITIVA

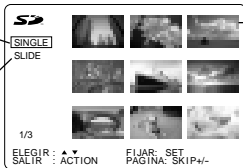

**AREA DEL INDICE**  
Este área se utiliza para visualizar los archivos almacenados en la tarjeta SD.

Presione **▲▼** para seleccionar "SINGLE" o "SLIDE", y presione **SET**.

### ■ SINGLE (EJECUCIÓN ÚNICA)

Este modo permite ampliar y ejecutar una sola imagen seleccionada del índice de visualización. Además, este modo permite aplicar a la imagen varias funciones, incluidas el zoom, la rotación e información de la imagen.

**Ampliar una imagen (ZOOM) → Presione ZOOM PARA GIRAR → Presione ANGLE**

**Iniciar la muestra-diapositiva → Presione PLAY (vea debajo)**

**Visualizar la pantalla de información del archivo → Presione DISPLAY.**

### ■ SLIDE SHOW (MUESTRA DIAPOSITIVA)

Este modo permite que se visualice una secuencia de imágenes, una detrás de la otra. Además, también permite seleccionar imágenes para visualizarlas, y la selección de ajuste para los efectos de transición de la pantalla y la velocidad de transición.

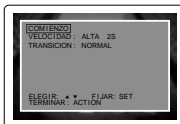

Presione **▲▼◀▶** para seleccionar (vea a la derecha), y presione **SET** repetidamente.

**3 presione ACTION** para salir de cada modo.

## Configuración de los altavoces

**1 Presione POWER** en el control remoto o el aparato.

**2 Presione DVD** para seleccionar el modo DVD.

**3 Presione ▲▼** para seleccionar "AJUSTE DE ALTAVOCES," y presione **SET** para visualizar la pantalla AJUSTE DE ALTAVOCES.

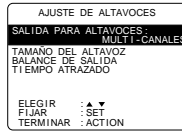

**4 Presione ▲▼** para seleccionar, y presione **SET** para fijar.

### ■ SALIDA PARA ALTAVOCES

Fije el número de altavoces conectados al DECK.

**MULTI-CANALES** (Predeterminado en fábrica)

Cuando están conectados 3 o más altavoces.

**2 CANALES**

Cuando están conectados 2 altavoces.

### ■ TAMAÑO DEL ALTAVOZ

Se determinan las propiedades de frecuencia del altavoz y la existencia de los altavoces.

**FRENTE** (GRANDE [predeterminado en fábrica]/ PEQUEÑO)

**CENTRO** (GRANDE [predeterminado en fábrica]/ PEQUEÑO/NINGUNO)

**ENVOLVENTE** (GRANDE [predeterminado en fábrica]/PEQUEÑO/NINGUNO)

**SUBWOOFER** (ENCENDIDO [predeterminado en fábrica]/APAGADO)

### ■ BALANCE DE SALIDA

Ajuste la salida de nivel de volumen para los altavoces.

**CENTRO, ENVOLVENTE(DER)/(IZQ), SUBWOOFER**

-6db ~ +6db (0db: predeterminado en fábrica)

### SEÑAL PRUEBA

El sonido de prueba es la salida en sentido de las manecillas del reloj.

### ■ TIEMPO ATRAZADO

Configurar el tiempo atrazado. Da a la salida de sonido un efecto retrasado que le ofrece la ilusión de encontrarse en la posición de escucha ideal.

**5 Presione ACTION** tres o cuatro veces para salir.

### [VELOCIDAD]

Fije el tiempo de transición

**ALTA**(2 seg)/**MEDIANA**(5 seg)/**BAJA**(10 seg)

### [TRANSICION]

**NORMAL:** Para que las imágenes pasen una a una.

**DESLIZAR:** Para que las imágenes pasen de arriba abajo.

**DIVICIONES:** Para que las imágenes pasen empezando por el centro y partiéndose a la izquierda y la derecha.

**COLUMNAS:** Para que las imágenes pasen en una serie de formas tipo bandas asemejándose a las persianas de una ventana.

## DECK & VCR

<b>A</b>	<b>ACTION</b> button .....	8, 18
	Accessories .....	4
	ADD/DELETE button (Add or Delete a Channel) .....	8, 19
	Audio Broadcast types (Stereo/SAP/Mono) .....	26
	Audio Mode (Playback, Recording) .....	27
	Auto Operation Functions .....	31
	Auto Shut-Off .....	33
<b>B</b>	Batteries .....	4
<b>C</b>	Channel ("SET UP CHANNEL") .....	18
	Channel Up/Down, Tracking/V-Lock Button .....	4, 8
	Clock ("SET CLOCK") .....	18
	Commercial Skip .....	31
	Connections .....	12 - 15
	Copy Your Tapes (Dubbing) .....	35
	COUNTER RESET button .....	8, 32
	Customer Services Directory .....	65
<b>D</b>	DISPLAY button .....	8, 11
	DSS/CABLE mode button .....	8, 28
	DST (Daylight Saving Time) .....	19
<b>E</b>	EJECT button .....	8, 20
	ENTER button (For tuning TV Channel) .....	8, 28
<b>F</b>	FAST FORWARD/SEARCH button .....	8, 20
<b>H</b>	Head Cleaning .....	4
<b>I</b>	Index Search .....	30
	Indicator (Multi Function Display) .....	11
	Initial Setup (Ready to Play) .....	16, 17
	INPUT button .....	8, 35
<b>L</b>	Limited Warranty .....	64, 65
	Location of Controls (Remote, DECK) .....	8 - 10
<b>M</b>	Multi-Brand Control .....	28, 29
<b>O</b>	On-Screen Displays (VCR) .....	11
	One Touch Recording .....	21
<b>P</b>	PAUSE/STILL button (Still Picture) .....	8, 20
	PLAY button (Playback a Tape) .....	8, 20
	POWER button .....	8
	PROG button (PROGRAM) .....	8, 24
	Program Clear, Review, Replace .....	25
	Program End Search .....	30
<b>Q</b>	Quality Picture .....	4
<b>R</b>	REC button (Record on a Tape) .....	8, 21
	Record Tab .....	6
	Remote Sensor .....	9
	Remote Warning .....	34
	Repeat Play .....	32
	Reset All Memory Functions .....	9
	REWIND/SEARCH button .....	8, 20
<b>S</b>	SAP/Hi-Fi .....	27
	SEARCH (Index and Program End Search) .....	30
	SLOW+/SLOW- button (Slow Motion Picture) .....	8, 20
	Spanish Quick Use Guide .....	66 - 71
	Specifications .....	o...HD9... button (
	REWITw [(R72)Tj.F:1.1.Tf95.44ay.....[(Qual9.88(8)47,8(8)47 28(	
	Timer.Tc.:0.Tw.TD7.92.....2....8....5( )4-7.9Z7.....	



## Free Manuals Download Website

<http://myh66.com>

<http://usermanuals.us>

<http://www.somanuals.com>

<http://www.4manuals.cc>

<http://www.manual-lib.com>

<http://www.404manual.com>

<http://www.luxmanual.com>

<http://aubethermostatmanual.com>

Golf course search by state

<http://golfingnear.com>

Email search by domain

<http://emailbydomain.com>

Auto manuals search

<http://auto.somanuals.com>

TV manuals search

<http://tv.somanuals.com>