

Panasonic[®]

Operating Instructions

Digital HD Video Cassette Recorder

Model No. **AJ-HD1800P**

Model No. **AJ-HD1800E**

DVCPRO HD

EX

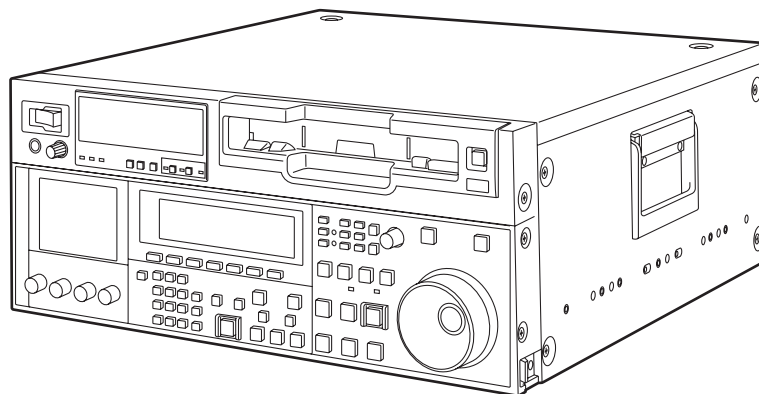

Before operating this product, please read the instructions carefully and save this manual for future use.

Read this first!

For AJ-HD1800P and AJ-HD1800E

■ THIS EQUIPMENT MUST BE GROUNDED

To ensure safe operation, the three-pin plug must be inserted only into a standard three-pin power outlet which is effectively grounded through normal household wiring. Extension cords used with the equipment must have three cores and be correctly wired to provide connection to the ground. Wrongly wired extension cords are a major cause of fatalities. The fact that the equipment operates satisfactorily does not imply that the power outlet is grounded or that the installation is completely safe.

For your safety, if you are in any doubt about the effective grounding of the power outlet, please consult a qualified electrician.

CAUTION:

The mains plug of the power supply cord shall remain readily operable.

The AC receptacle (mains socket outlet) shall be installed near the equipment and shall be easily accessible. To completely disconnect this equipment from the AC mains, disconnect the mains plug from the AC receptacle.

CAUTION:

- KEEP THE TEMPERATURE INSIDE THE RACK BETWEEN 5°C to 40°C (41°F to 104°F).
- BOLT THE RACK SECURELY TO THE FLOOR SO THAT IT WILL NOT TOPPLE OVER WHEN THE UNIT IS DRAWN OUT.

CAUTION:

In order to maintain adequate ventilation, do not install or place this unit in a bookcase, built-in cabinet or any other confined space. To prevent risk of electric shock or fire hazard due to overheating, ensure that curtains and any other materials do not obstruct the ventilation.

CAUTION:

TO REDUCE THE RISK OF FIRE OR SHOCK HAZARD AND ANNOYING INTERFERENCE, USE THE RECOMMENDED ACCESSORIES ONLY.

WARNING:

- TO REDUCE THE RISK OF FIRE OR SHOCK HAZARD, DO NOT EXPOSE THIS EQUIPMENT TO RAIN OR MOISTURE.
- TO REDUCE THE RISK OF FIRE OR SHOCK HAZARD, KEEP THIS EQUIPMENT AWAY FROM ALL LIQUIDS. USE AND STORE ONLY IN LOCATIONS WHICH ARE NOT EXPOSED TO THE RISK OF DRIPPING OR SPLASHING LIQUIDS, AND DO NOT PLACE ANY LIQUID CONTAINERS ON TOP OF THE EQUIPMENT.

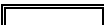
 indicates safety information.

IMPORTANT

“Unauthorized recording of copyrighted television programmes, video tapes and other materials may infringe the rights of copyright holders and contravene copyright laws.”

Operating precaution

Operation near any appliance which generates strong magnetic fields may give rise to noise in the video and audio signals. If this should be the case, deal with the situation by, for instance, moving the source of the magnetic fields away from the unit before operation.

For AJ-HD1800P

	CAUTION RISK OF ELECTRIC SHOCK DO NOT OPEN	
CAUTION: TO REDUCE THE RISK OF ELECTRIC SHOCK, DO NOT REMOVE COVER (OR BACK). NO USER-SERVICEABLE PARTS INSIDE. REFER TO SERVICING TO QUALIFIED SERVICE PERSONNEL.		



The lightning flash with arrowhead symbol, within an equilateral triangle, is intended to alert the user to the presence of uninsulated "dangerous voltage" within the product's enclosure that may be of sufficient magnitude to constitute a risk of electric shock to persons.



The exclamation point within an equilateral triangle is intended to alert the user to the presence of important operation and maintenance (service) instructions in the literature accompanying the appliance.

Notice (U.S.A. only):

This product has a fluorescent lamp that contains a small amount of mercury. It also contains lead in some components. Disposal of these materials may be regulated in your community due to environmental considerations. For disposal or recycling information, please contact your local authorities, or the Electronics Industries Alliance:
<<http://www.eiae.org>>

FCC Note:

This equipment has been tested and found to comply with the limits for a class A digital device, pursuant to Part 15 of the FCC Rules. These limits are designed to provide reasonable protection against harmful interference when the equipment is operated in a commercial environment. This equipment generates, uses, and can radiate radio frequency energy, and if not installed and used in accordance with the instruction manual, may cause harmful interference to radio communications. Operation of this equipment in a residential area is likely to cause harmful interference in which case the user will be required to correct the interference at his own expense.

Warning:

To assure continued FCC emission limit compliance, the user must use only shielded interface cables when connecting to external units. Also, any unauthorized changes or modifications to this equipment could void the user's authority to operate it.

CAUTION:

This apparatus can be operated at a voltage in the range of 100 – 240 V AC. Voltages other than 120 V are not intended for U.S.A. and Canada.

CAUTION:

Operation at a voltage other than 120 V AC may require the use of a different AC plug. Please contact either a local or foreign Panasonic authorized service center for assistance in selecting an alternate AC plug.

 indicates safety information.

For AJ-HD1800E

Caution for AC Mains Lead

FOR YOUR SAFETY PLEASE READ THE FOLLOWING TEXT CAREFULLY.

This product is equipped with 2 types of AC mains cable. One is for continental Europe, etc. and the other one is only for U.K.

Appropriate mains cable must be used in each local area, since the other type of mains cable is not suitable.

FOR CONTINENTAL EUROPE, ETC.

Not to be used in the U.K.

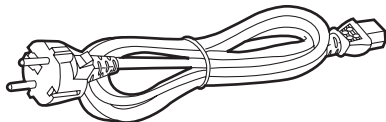

FOR U.K. ONLY

If the plug supplied is not suitable for your socket outlet, it should be cut off and appropriate one fitted.

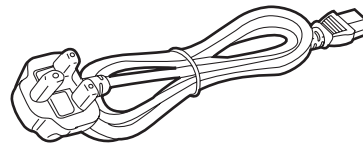

FOR U.K. ONLY

This appliance is supplied with a moulded three pin mains plug for your safety and convenience.

A 13 amp fuse is fitted in this plug.

Should the fuse need to be replaced please ensure that the replacement fuse has a rating of 13 amps and that it is approved by ASTA or BSI to BS1362.

Check for the ASTA mark  or the BSI mark  on the body of the fuse.

If the plug contains a removable fuse cover you must ensure that it is refitted when the fuse is replaced.

If you lose the fuse cover the plug must not be used until a replacement cover is obtained.

A replacement fuse cover can be purchased from your local Panasonic Dealer.

How to replace the fuse

1. Open the fuse compartment with a screwdriver.

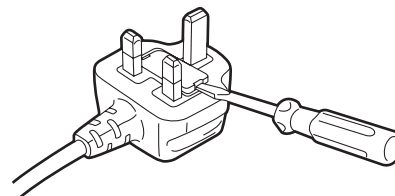

2. Replace the fuse.

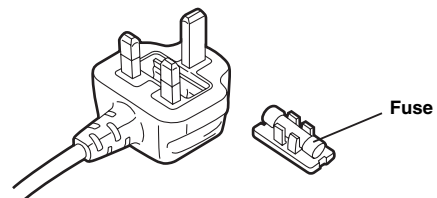

■ DO NOT REMOVE PANEL COVERS BY UNSCREWING THEM.

To reduce the risk of electric shock, do not remove the covers. No user serviceable parts inside. Refer servicing to qualified service personnel.

 indicates safety information.

IMPORTANT SAFETY INSTRUCTIONS

- 1) Read these instructions.
- 2) Keep these instructions.
- 3) Heed all warnings.
- 4) Follow all instructions.
- 5) Do not use this apparatus near water.
- 6) Clean only with dry cloth.
- 7) Do not block any ventilation openings. Install in accordance with the manufacturer's instructions.
- 8) Do not install near any heat sources such as radiators, heat registers, stoves, or other apparatus (including amplifiers) that produce heat.
- 9) Do not defeat the safety purpose of the polarized or grounding-type plug. A polarized plug has two blades with one wider than the other. A grounding-type plug has two blades and a third grounding prong. The wide blade or the third prong are provided for your safety. If the provided plug does not fit into your outlet, consult an electrician for replacement of the obsolete outlet.
- 10) Protect the power cord from being walked on or pinched particularly at plugs, convenience receptacles, and the point where they exit from the apparatus.
- 11) Only use attachments/accessories specified by the manufacturer.
- 12) Use only with the cart, stand, tripod, bracket, or table specified by the manufacturer, or sold with the apparatus. When a cart is used, use caution when moving the cart/ apparatus combination to avoid injury from tip-over.
- 13) Unplug this apparatus during lightning storms or when unused for long periods of time.
- 14) Refer all servicing to qualified service personnel. Servicing is required when the apparatus has been damaged in any way, such as power-supply cord or plug is damaged, liquid has been spilled or objects have fallen into the apparatus, the apparatus has been exposed to rain or moisture, does not operate normally, or has been dropped.



Contents

Read this first!	2	Turning on the power and inserting the cassette	25
General outline	7	STOP and STANDBY modes	25
Standard accessories	7	Recording	26
Features	8	Playback	27
Parts and their functions	10	Playback phase adjustment	27
Front panel (1)	10	Jog/Shuttle	28
Front panel (2)	11	Jog Mode	28
Front panel (3)	12	Shuttle Mode	28
Front panel (4)	13	Manual Editing	29
Front panel (5)	14	Preroll	29
Front panel (6)	15	Automatic Editing (deck-to-deck)	30
Front panel (7)	16	Switch settings and adjustments	30
Front panel (8)	17	Selecting the editing mode.....	31
Rear panel	19	Registering the edit points.....	31
Connections	21	Checking the edit points.....	32
Example of connections performed for one VTR.....	21	Modifying edit points	32
Example of connections performed for two VTRs (deck-to-deck)	21	Previewing.....	33
Example of connections in 23/24 Hz or 25/50 Hz (HD) mode	22	Automatic editing.....	33
Example of connections in 25/50 Hz (SD) mode	22	Reviewing.....	33
Example of connections with an editing controller	23	Audio Split Editing	34
Concerning tapes	24		

Contents (continued)

Variable memory function.....	36	Display saving function	123
Variable memory function selection.....	36	Rack mounting.....	124
Outline	36	Video head cleaning	125
Variable memory playback operation procedure.....	36	Condensation.....	125
Variable memory editing operation procedure.....	37	Maintenance	125
Function menus	38	Error messages.....	126
General description.....	38	DIAG menu	126
Allocating the function keys	39	Warning messages	128
<HOME>.....	40	Error messages.....	129
<VIDEO>.....	49	RS-232C interface	131
<AUDIO>	51	Hardware specifications.....	131
<TC>	53	Software specifications (protocol)	132
<CUE>	54	Connector signals	137
<DIAG>	57	EMERGENCY EJECT	138
<MENU>	59	Specifications	139
<ASSEMBLE>.....	60		
<INSERT>.....	61		
<SETUP MENU/SYSTEM MENU>	62		
<FILE>	64		
<PF1/PF2>.....	66		
<CARD>	71		
<50P IN/OUT ASSIGN>	74		
System menus	80		
Setup menus	83		
<BASIC>.....	83		
<OPERATION>	87		
<INTERFACE>	90		
<EDIT>	91		
<TAPE PROTECT>.....	93		
<TIME CODE>.....	94		
<VIDEO>	96		
<AUDIO>	102		
<DIF>	110		
<MENU>	111		
<How to switch the system frequency>	112		
<Menu management accompanying switching the system frequency>.....	113		
<Menus which are displayed>.....	113		
Time code and user bits.....	118		
Time code.....	118		
User bits.....	118		
Setting the internal time code	118		
Setting the external time code	119		
Cue time registration, preroll and cue-up.....	119		
Time code and user bits playback	119		
Time code recorded on the unit	120		
Superimpose screen	122		
Selecting the audio recording channels and monitor output.....	123		
Audio recording channels	123		
Monitor output channels	123		

General outline

This unit is a multi-format VTR capable of recording and playing back HD signals (1080i/59.94 Hz, 1080i/50 Hz, 720p/59.94 Hz, 720p/50 Hz) in DVCPRO HD-LP* format using a small cassette tape 1/4 inch wide, HD (DVCPRO HD-LP/DVCPRO HD) and SD (DVCPRO50/DVCPRO) recorded in DVCPRO format as well as conventional consumer DV/DVCAM tapes.

A down-converter as a standard feature verifies all tapes using analog composite signals and SD SDI output.

Furthermore, output signals converted to 1080/24PsF can be obtained from the 720/24p over 60p source recorded with the variable frame rate camera. These signals can be used for cinema as well.

Similarly, each of the following output signals can be obtained.

- 720/25p over 60p sources can be converted to 1080/25 PsF or 576i format output signals.
- 720/50p over 60p sources can be converted to 720/50p, 1080/50i or 576i format output signals.

By mobilizing highly efficient digital compression technology to assure a high picture quality, this VTR significantly minimizes deterioration in the picture quality and sound quality during the dubbing process.

It features a compact size of 4U and a lightweight design that enables it to be carried around with ease, and to be readily installed in a 19-inch rack.

The equipment is set up using an interactive system whereby the operator manipulates the function buttons on the front panel and observes the menu screens on the front panel's LCD monitor.

In terms of the editing features, this VTR is capable of both assemble editing and insert editing.

* DVCPRO HD-LP has the same format as DVCPRO HD EX described in the operation manual for our camera recorder.

Standard accessories

Power cord (AJ-HD1800P) 1
Power cord (AJ-HD1800E) 2

Features

Compact size and light weight

This is a 4U digital VTR. Using the rack-mounting adapters (AJ-MA75P: optional accessory), it can also be easily housed in a 19-inch rack.

Up to 126 minutes of recording

Using the DVCPRO HD-LP recording system, up to 126 minutes of material can be recorded on the 1/4-inch XL-size cassette tape.

High picture quality

The VTR's high picture quality is achieved by 4:2:2 HD component signal recording using a recording rate (100 Mbps) which is 4 times higher than that of the existing DVCPRO format.

1080i/720p, 59.94 Hz/60 Hz/50 Hz signal switching

By making menu selections, the signals of the respective formats can be recorded and played back.

No guarantees are made for the recording in 1080-60 Hz.

Frame rate conversion function

By making menu selections, the VTR can output signals after converting them to the 1080/24PsF format when it plays back a tape recorded by a variable frame rate camera at a frame rate of 24fps.

When playing back a tape recorded at a frame rate of 25 fps, the tape's signals can be converted to the 1080/25 PsF or 576i format and output. When playing back a tape recorded at a frame rate of 50 fps, the tape signals can be converted to the 1080/50i or 576i format and output.

<Notes>

- Use tapes that are shot with a variable frame rate camera.
- Do not use dubbed or edited tapes. The tape control information may be lost, making it impossible to convert the signals for playback.

Gamma correction of cinema for film

This feature corrects the image from a variable frame rate camera in cinema gamma mode for film to an image with film quality.

SDI interface

The VTR comes with an HD/SD serial digital interface as a standard accessory.

Playback compatibility with DVCPRO systems

Besides DVCPRO HD-LP recording and playback, the VTR can also play back tapes which have been recorded using the existing DVCPRO HD, DVCPRO50 and DVCPRO systems.

Consumer-use DV tapes (SP) and DVCAM tapes can also be played back on this VTR.

Digital slow motion/dial jog

Panasonic's unique digital slow motion technology enables clear playback (of tapes recorded using the DVCPRO HD-LP system) at speeds ranging from $-1\times$ to $+2\times$.

<Note>

Some noise may occur during slow playback (using an external controller) at speeds of almost exactly $-1\times$ or $+2\times$.

Search speed

Search speed enables tapes (recorded using the DVCPRO HD-LP system) to be played back with color images at speeds of up to 100 times in the forward or reverse direction.

Time codes

This VTR comes with a built-in time code generator (TCG)/time code reader (TCR).

In addition to the internal time code, an external time code can also be input and recorded as the LTC on the VTR.

UMID information recording and playback

This unit supports the recording/playback of UMID (Unique Material Identifier) information in the SMPTE 330M standard. UMID information can be confirmed with the diagnostic menu.

VTRs that do not support the recording/playback of UMID information will not playback UMID information correctly. In addition, when VTRs that do not support recording/playback of UMID information are connected to this unit, UMID information will not be recorded correctly.
--

VANC data recording/playback

VANC data packets that added to the Y stream of HD SDI can be recorded with the video signal. In addition, VANC data packets can be played back with the Y stream of HD SDI.

Features (continued)

Multi-functional interfaces

● Serial digital input/output connector

The VTR comes with an HD component serial interface input/output connector. This one BNC connector enables HD component video signals and 8-channels digital audio signals to be interfaced. (SMPTE 292M, 296M, 299M)

It is also equipped with an HD/SD format converter as a standard accessory so that SD component serial signals can also be output. (SMPTE 259M-C, 272M-A, ITU-R BT.656-4)

● Analog video output connector

Composite signals are output during DVCPRO50- or DVCPRO-compatible playback, DV playback, DVCAM playback and down-conversion.

● AES/EBU audio input/output connectors

Digital audio input/output connectors for 8 channels are featured as a standard accessory.

● Up-conversion recording of SD signals

SD component serial signals (SMPTE 259M-C, 272M-A, ITU-R BT.656-4) can be up-converted and recorded as HD signals.

● 9-pin RS-422A and RS-232C remote control connectors

In addition to the standard 9-pin serial remote (RS-422A) control connector, the VTR is provided with RS-232C and 50-pin parallel remote control connectors. The RS-422A facility enables parallel operation if a loop connection has been established between the VTR and another VTR.

● IEEE1394 digital input/output

It is possible to input and output data in accordance with the IEEE 1394 standard.

<Note>

INSERT and ASSEMBLE editing will not work when [1394] is selected as the menu item No.600 (VIDEO IN SEL).

<Playback formats and output formats>

Playback format	Output format
DVCPRO HD-LP, DVCPRO HD	DVCPRO HD, DVCPRO50, DV
DVCPRO50	DVCPRO50, DV
DVCPRO	DVCPRO, DV
DV, DVCAM	DV
In case of EE and REC modes:	DVCPRO HD, DVCPRO50, DV

<Note>

When any of the settings below is established, no signals will be output from the IEEE1394 digital interface.

- When "60/24" is selected as the menu item No.030 HD FREQUENCY setting
- When "23/24," "25 (HD)," "25 (SD)," "50 (HD)," or "50 (SD)" is selected in menu item No. 025 SYSTEM FREQ.
- When the edit mode is selected while the output format is set to other than DVCPRO HD.

8-channel high-sound-quality digital audio

The 8-channel PCM audio feature allows for not only independent editing but mixing as well on all 8 channels. One channel is provided for the analog cue track.

Menu-driven setup

The setup settings, which are conducted prior to operating the VTR, are performed while the operator views the setup menus either on the VTR's LCD monitor or on a TV monitor.

Multi-functional front panel with LCD monitor

The front panel's multiple functions, including the LCD monitor for monitoring images, the function buttons and large-size display panel, are contained within the 4U dimensions and designed to improve operating ease.

Parts and their functions

Front panel (1)

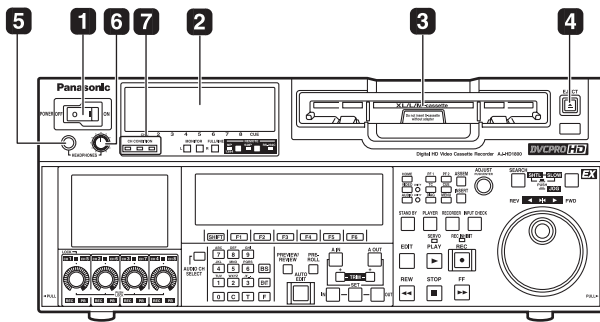

1 POWER switch

2 Audio level meter

The audio information is displayed here.

- The levels of the CH1, CH2, CH3, CH4, CH5, CH6, CH7 and CH8 PCM audio signals and level of the CUE track signal are displayed here.
- The levels of the input signals are displayed during recording and when EE is selected. During playback, the levels of the playback signals are displayed. In the INPUT CHECK status, the levels of the input signals are displayed for CH1 to CH8.
- Input signal display for each of the channels
The indicators for the selected input signals light.
(When the SD SDI input is selected, the SDI indicator lights. When the 1394 input is selected, the HD lights.)
If no input signal is selected, the AES/HDSDI/SDI/1394 indicator blinks while the ANA indicator lights continuously.
When the internal signal (INT SG) is selected, all AES/ANA/HD SDI indicators light.
All indicators are off in 23/24 Hz mode or 25 Hz (HD, SD) and 50 Hz (HD, SD) mode.

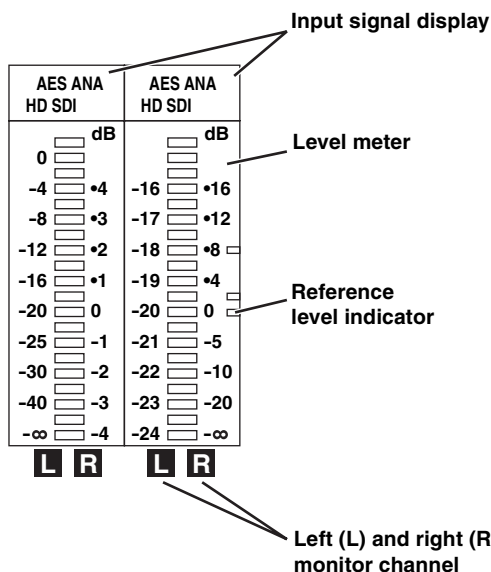

3 Cassette insertion slot

If the slot's orange plate is visible, it means that a cassette tape is already inserted.

4 EJECT button

When this button is pressed, the cassette is unloaded, and a few seconds later it is ejected automatically. When CTL appears on the counter display, the display is reset.

5 Headphones jack

The sound heard during recording, playback or editing can be monitored through headphones when stereo headphones are connected to this jack.

6 Volume control dial

This control dial is used to adjust the volume level of the headphones and monitor output. Whether the volume level of the monitor output is to be coupled together with that of the headphones to this dial or separated can be selected using the setup menu item No.712 (MONI OUT). (Note that the volume level of the headphones is coupled at all times.) When the volume levels have been separated, the UNITY value (prescribed value) applies to the monitor output.

7 Channel condition lamps

These lamps light to indicate the error rate status. (Green→amber→red)

Green: This lights when the error rates for the video and audio playback signals are both at acceptable levels.

Amber:

This lights when the error rate for either the video or audio playback signals has deteriorated. The playback picture and sound remain unaffected even while this lamp is lighted.

Red: This lights when correction or interpolation has been engaged for either the video or audio playback signals.

Front panel (2)

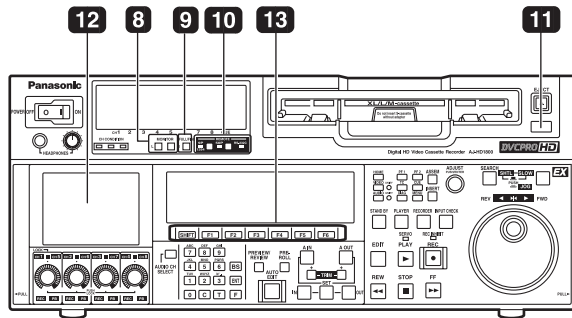

8 MONITOR SELECT buttons

These buttons are used to select the audio signals which are to be output to the monitor L and R connectors and headphones jack.

- When OFF has been selected as the **[F6] M MIX** setting on the <AUDIO SHIFT2> menu (factory setting):

Each time the L (or R) button is pressed, the signal to be output to the monitor L (or R) connector is changed in the following sequence and displayed on the audio level meter: CH1 → CH2 → CH3 → CH4 → CH5 → CH6 → CH7 → CH8 → CUE → CH1, etc.

- When L, R or L/R has been selected as the **[F6] M MIX** setting on the <AUDIO SHIFT2> menu:

At this setting, the signals of a multiple number of channels can be mixed and output.

When the number key corresponding to the channel whose signals are to be monitored is pressed while the L (or R) button is held down, that channel is selected and its signals are displayed on the audio level meter. By performing the same operation, the selected channel can be de-selected.

However, a maximum of only two channels from CH1 to CH4 and a maximum of only two channels from CH5 to CH8 can be selected.

Example of channels which can be selected:

CH1 + CH3 + CH5 + CH8 → OK

CH1 + CH2 + CH4 → NG

9 METER (FULL/FINE) selector button

This button is used to select the scale display for the audio level meter.

FULL mode:

According to the settings in SETUP MENU No. 763 (METER SCALE)*, the range from $-\infty$ dB to 0 dB or the range from $-\infty$ dB to +20 dB is displayed.

FINE mode:

According to the settings in SETUP MENU No. 763 (METER SCALE)*, the range from -24 dB to -15 dB or the range from -4 dB to +5 is displayed at intervals of every 0.5 dB.

The reference level is displayed with the reference level indicator ■ on the right side of the level meter. The reference level can be changed in SETUP MENU No. 776 (REF LEVEL)

* This menu is not displayed for AJ-HD1800E.

10 REMOTE buttons and RS-232C display

These buttons are used when this VTR is to be controlled from an external component using the REMOTE, RS-232C or parallel connector.

9P 1394:

Press the button for 2 seconds or more, the LED lights, and the unit can be controlled by a device connected through the REMOTE connector, the (IN/OUT) connector, or the DVCPRO/DV connector. Release the control by pressing the button for 2 seconds or more.

50P:

When this button is pressed for 2 or more seconds, its LED lights, and it is possible to control the VTR from a unit which has been connected using the 50-pin parallel mode connector. Release the control by pressing the button for 2 seconds or more.

RS-232C display:

This LED lights when communication has been enabled between the VTR and the unit which has been connected to the RS-232C connector. The display can be switched in SETUP MENU No.204 (RS232C SEL).

11 AUTO OFF lamp

This lamp lights when a problem has occurred with the VTR's operation, and details of the problem appear on the time code display.

12 LCD monitor

The monitor is operated as a simple monitor for playing back tapes or displaying EE images and menu display.

If the VTR is left in a state where no controls on the front panel are operated or where the tape is not running, the monitor display is automatically turned off in order to protect the monitor. When the next VTR operation is started, the monitor display comes back on.

<Note>

Some images may not be displayed. Use another monitor to check the images.

13 Function buttons

These buttons operate the function menu (refer to page 38).

[SHIFT] :

This is used to switch pages on the current function menu.

[F1] to [F6] :

These are used to change the settings of the setting items enclosed in the frame at the bottom of the time code display.

To change a setting, keep pressing the corresponding function button (**[F1]** to **[F6]**) until the desired numerical value appears; alternatively, press the corresponding function button to highlight the setting of the setting item, and then turn the ADJUST dial until the desired numerical value is obtained.

Parts and their functions (continued)

Front panel (3)

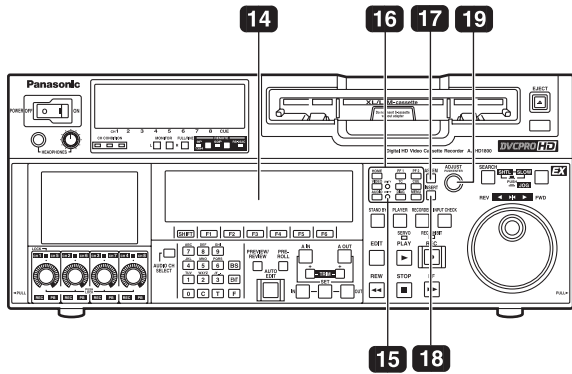

14 Time code display

The data, VTR status information, tape format information or warning information which corresponds to the direct menu buttons appear on this display. (See page 38 and following for details of the displays.)

15 UNITY lamps

VIDEO UNITY lamp

This lights if all image output levels of the HD/SD are UNITY.

AUDIO UNITY lamp

This lights if the UNITY level applies for the PCM or CUE AUDIO input or output level. (The lighting of the lamp complies with the setting selected for setup menu item No.142 (AUDIO UNITY).)

16 Direct menu buttons

These buttons are used to switch directly to the function menus on the time code display.

HOME:

The most basic settings of recording, playback and time code operations are selected on this menu.

VIDEO:

The basic input and output settings for the video signals are selected on this menu. The level of the HD output signals can also be adjusted on this screen.

AUDIO:

The basic input and output settings for the audio signals are selected on this menu.

PF1: This enables user-defined menu items to be registered in the function keys.

PF2: This enables user-defined menu items to be registered in the function keys.

TC: The settings related to the time code are selected on this menu. Superimposing the time code on the display can also be set on this screen.

CUE: This enables up to 60 cue points to be set. In the PAGE mode, 10 pages with 6 cue points on each page are provided so that the cue points can be managed on a page-by-page basis.

DIAG: This enables confirmation of information such as the warning/hour-meter/UMID. On the SHIFT screen, the error log files can be checked and deleted.

MENU:

On this menu, it is possible to transfer operation to the screen on which operations (adjustments and saving data in or loading it from the internal memory and SD memory card) relating to the SYSTEM and SETUP menus are to be performed.

See page 38 and following for further details on each of the function menus.

17 ASSEM button

This button is used to perform assemble editing.

When it is pressed, the <ASSEMBLE> menu appears on the time code display. Setting ASSEM to ON using [F1] enables assemble editing, and the lamp of the ASSEM button lights.

Even after operation is transferred by another direct menu, the assemble mode will remain established while the ASSEM button lamp is lighted.

Press the [F1] button when the <ASSEMBLE> menu is displayed to turn OFF the ASSEM item on the screen. The ASSEM button lamp now goes off and the assemble mode is released.

18 INSERT button

This button is used to perform insert editing. When it is pressed, the <INSERT> menu appears on the time code display, and the function menu for selecting the signals to be edited is displayed.

To select the signals to be edited, press the function key, and highlight the display. The highlighted display indicates that those signals are selected.

To release the selection, press the same function key again.

Use [F1] to [F6] to select the V, A1, A2, A3, A4 and CUE signals; use [SHIFT] + [F2] to [F6] to select the A5, A6, A7, A8 and TC signals.

19 ADJUST dial (ADJ dial)

This is used for the menu and other operations.

Front panel (4)

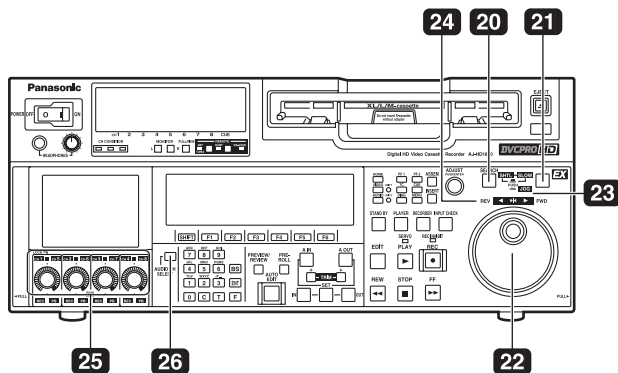

20 Search button

Press this button to shift to the search mode. Set the search dial to the shuttle mode and turn to any position, and then press this button to start playback at the rate set with the search dial.

21 SHTL/SLOW button

This is the button to select SHTL or SLOW for the search dial. Every time this button is pressed, the search dial shifts alternately between the SHTL and SLOW modes.

22 Search dial

This is the dial to search the edit point. The mode shifts alternately between SHTL/SLOW and JOG each time the dial is pressed, and the lamp for either JOG, SHTL, or SLOW lights. When the power is turned on, the unit operates once the dial returns to the STILL position.

SHTL (shuttle) mode:

While the lamp is lit for SHTL of JOG/SHTL/SLOW, turn the dial and stop at any position to play back images at the rate indicated by the position of the dial. When the dial is at the center position, images become still pictures.

SLOW mode:

While the lamp is lit for SLOW of JOG/SHTL/SLOW, turn the dial all the way to the left to play back images at a rate 4.9 times slower than the standard rate. When the dial is at the center position, images become still pictures. Turn the dial all the way to the right to play back images at a rate 4.9 times faster than the standard rate. SLOW speed can be selected in SETUP MENU No. 308 (VAR FWD MAX) and No. 309 (VAR REV MAX). The rate at the click point can be selected in the SETUP MENU No. 313 (CLICK POINT).

JOG mode:

In this mode, there are no clicks when turning the dial. Playback speed is determined by how far the dial is turned. The maximum rate can be selected in SETUP MENU No. 310 (JOG FWD MAX) and No. 311 (JOG REV MAX)

23 JOG/SHTL/SLOW lamp

This lamp indicates the search dial mode.

JOG:

This lamp lights in JOG mode.

SHTL/SLOW:

This lamp lights in SHTL/SLOW mode.

24 REV, STILL and FWD lamps

These lamps light to reflect the way in which the search dial is operated.

REV: This lights when the dial is turned counterclockwise, and the tape runs in the REV direction while the search button lamp is lighted.

STILL: While the JOG lamp is lighted, this lights when the dial rotation is stopped, and the tape also stops running.

While the SHTL/SLOW lamp is lit, it lights when the dial is at the still-picture position.

FWD: This lights when the dial is turned clockwise, and the tape runs in the FWD direction while the search button lamp is lighted.

25 Audio input and output level control dials

These are used to adjust the recording or playback levels of the CH1, CH2, CH3, CH4, CH5, CH6, CH7 and CH8 PCM audio signals.

- Switching between the LOCK or UNLOCK status for the volume level operations

When a dial is pressed, the LED above the dial either lights (LOCK) or goes off (UNLOCK). In the LOCK (lighted) status, only the display segments corresponding to the current audio level light, and the audio level remains unchanged even when the dial is turned. In the UNLOCK (off) status, the display segments corresponding to the current audio level and all the display segments below light, and the audio level can be changed.
- Switching between UNITY or VAR

UNITY or VAR can be selected when the dial knob is pressed while holding down the **[F]** key among the number keys in the UNLOCK status. The position of the segment lighted at the center indicates the UNITY level.
- Switching between REC or PB

The AUTO, REC or PB volume level function can be selected using **[F1]** of "AUDIO SHIFT2" on the AUDIO function menu. With AUTO, the recording controls are automatically selected during recording or in the EE or INPUT CHECK status, and the playback controls are automatically selected during playback.
- Switching between CH1—CH4 and CH5—CH8

The **26** audio channel selector button is used to switch between these two sets of channels.

<Notes>

- The CUE audio input/output level is adjusted in SETUP MENU No. 790 (CUE REC VOL) and No. 791 (CUE PB VOL).
- While the input is 1394, the audio input level cannot be adjusted.

Front panel (5)

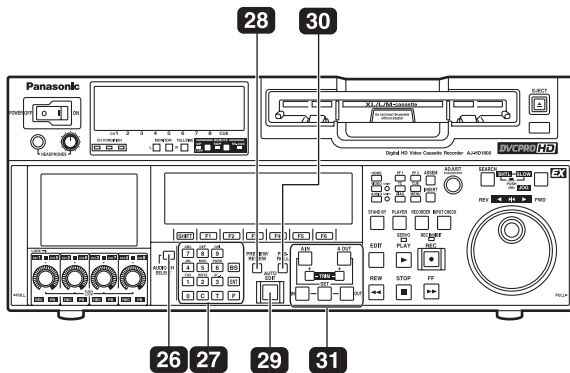

26 Audio channel selector button

Use this button to select whether the audio controls for channels CH1 to CH4 or for channels CH5 to CH8 are to be controlled.

Each time it is pressed, the channel display LED above the audio control is selected.

27 Number keys

Use these keys to input the numerical values of the CUE points, edit points, etc.

By pressing a number keys from **[1]** to **[9]** while the **[F]** key is held down, alphabet letters from A to F which are used for the user bits or letters from A to Z which are used to compose filenames can be input.

Since a multiple number of letters are allocated to each number key, keep tapping the number key until the desired letter is selected. To change the input position, use the ADJUST dial, and then proceed with the input.

29 PREVIEW/REVIEW button

PREVIEW:

When the button is pressed after an edit point has been registered, the tape travels and the editing can be previewed without actually performing the editing.

If the button is pressed when the IN point has not been registered, the point where it was pressed is registered as the IN point, and preview is executed using this IN point.

REVIEW:

When the button is pressed after a section has been edited, the just edited section is played back, and it can be reviewed on the recorder's monitor.

29 AUTO EDIT button

When this button is pressed after the edit points have been registered, automatic editing is initiated.

If the button is pressed when the IN point has not been registered, automatic editing is initiated with the point where the button was pressed serving as the IN point.

30 PREROLL button

This button is used to locate where a transmission or manual editing starts on the tape.

When it is pressed, the tape travels to the preroll point and it stops there.

When the cue time has been registered on the HOME, PF1 or PF2 screen:

The tape is prerolled from the registered cue time using the preroll time which was set using **[F1]** (PREROL) on the <HOME SHIFT> menu.

When the search mode is established on the CUE screen:

The tape is prerolled from the selected cue point using the preroll time which was set using **[F5]** (CU-ROL) on the <CUE SHIFT> menu.

The preroll operation is not performed when the selected cue point has not been registered or when the cue point registration mode is established.

In all other situations:

The tape is prerolled from the registered IN point (or the current tape position when the IN point has not been registered) using the preroll time which was set using **[F1]** (PREROL) on the <HOME SHIFT> menu.

If the PREROLL button is pressed when the IN point has not been registered, the current tape position is automatically registered as the IN point [but only when ENA has been selected as the setup menu item No.305 (AUTO ENTRY) setting].

When the PREROLL button is pressed together with the IN (A IN) or OUT (A OUT) button, the tape can be cued up to the registered point concerned. To cue up the tape for the cue time registered on the HOME, PF1 or PF2 screen, press the PREROLL button while holding down the **[F]** key among the number keys.

31 IN (A IN), SET and OUT (A OUT) buttons

When the IN (A IN) or OUT (A OUT) button is pressed together with the SET button, the IN (A IN) or OUT (A OUT) point is registered. The A IN and A OUT buttons are used to register audio IN and OUT points that differ from the corresponding video points during audio split editing. When an IN (A IN) or OUT (A OUT) point has been registered, the lamp of the IN (A IN) or OUT (A OUT) button which has registered that point lights. When these buttons are pressed after points have been registered, the IN (A IN) or OUT (A OUT) point value appears on the counter display.

When the **[C]** button is pressed while holding down the IN (A IN) or OUT (A OUT) button, the registration of the IN (A IN) or OUT (A OUT) point is cleared.

Parts and their functions (continued)

Front panel (6)

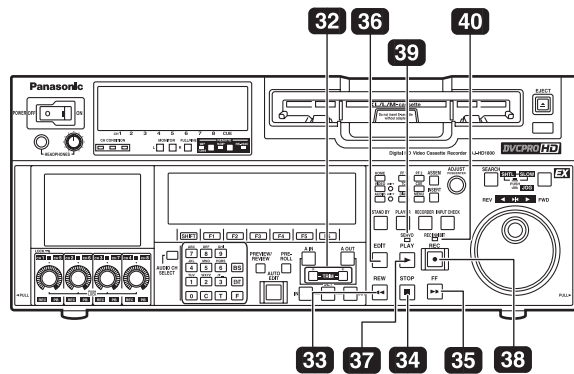

32 TRIM buttons

These buttons are used to make fine adjustments to the IN or OUT point.

By pressing the **+** or **-** button while the IN (A IN) button or OUT (A OUT) button is held down, the registered edit point can be adjusted in 1-frame increments. When the **+** button is pressed, the point is moved ahead by one frame; conversely, when the **-** button is pressed, it is moved back by one frame.

The playback phase can be adjusted by pressing the **+** or **-** button while holding down the PLAY button.

33 REW button

When this button is pressed, the tape is rewound.

The rewinding speed can be selected using setup menu item No.102 (FF.REW MAX).

34 STOP button

When this button is pressed, the tape stops traveling, and if TAPE is selected as the **[F1]** OUTPUT setting on the <HOME> menu, still pictures can be monitored.

Even in the stop mode, the drum continues to rotate, and the tape remains tightly wound around the drum. Therefore, when the VTR is left in the stop mode beyond a specific period of time, it is automatically set to the standby OFF mode in order to protect the tape. The VTR is set to the stop mode immediately after the cassette has been installed.

35 FF button

When this button is pressed, the tape is fast forwarded.

The fast forwarding speed can be selected using setup menu item No.102 (FF.REW MAX).

36 EDIT button

This button is pressed together with the PLAY button during playback to initiate manual editing.

When the button is pressed in the stop mode, the input signals in the mode selected by the <ASSEMBLE> menu or <INSERT> menu can be monitored in the EE mode.

When the STOP button is pressed, the original picture and sound are restored.

During playback, search, fast forwarding or rewinding, the input signals in the mode selected by the <ASSEMBLE> menu or <INSERT> menu can be monitored in the EE mode while the button is held down.

<Note>

No guarantees are made for the sound played back in the search mode.

37 PLAY button

Press this button to start playback.

When this button is pressed together with the REC button, recording starts; when this button is pressed together with the EDIT button during playback, manual editing starts.

However, manual editing will not be initiated if the servo is not locked. When only the PLAY button is pressed during manual editing, editing is exited, and the playback mode is established.

38 REC button

When this button is pressed together with the PLAY button, recording starts.

39 SERVO lamp

This lamp lights when the drum servo or capstan servo locks.

40 REC INHIBIT lamp

This lights or goes off in accordance with the status of the accidental erasure prevention tab on the cassette tape and the setting which has been selected for **[F6]** REC INH on the <HOME> menu. Recording onto the tape is inhibited while the lamp is lighted.

Cassette tape's accidental erasure prevention tab status	REC INH menu setting	REC INHIBIT lamp status	Description of operation
Recording disabled	—	Lighted* (or blinks slowly).	All recording operations are inhibited.
Recording enabled	OFF	Off	All recording operations are permitted.
	ALL	Lighted	All recording operations are inhibited.
	PRE	Blinks rapidly	Recording operations involving the overwriting of existing material are inhibited.
	NORM	Blinks rapidly	Normal recording operations are inhibited. Editing is possible.
	V/CTL	Blinks rapidly	Recording of video signals and CTL signals are inhibited.

* Whether the REC INHIBIT lamp is to light or blink is selected by the No.114 REC INH LAMP setup menu item setting.

<Note>

When SETUP MENU No. 18 (SP MODE INH) is set to ON, data cannot be recorded onto a tape that was formatted in any other format than DVCPRO HD-LP. If the menu is set to OFF, data can be recorded.

Front panel (7)

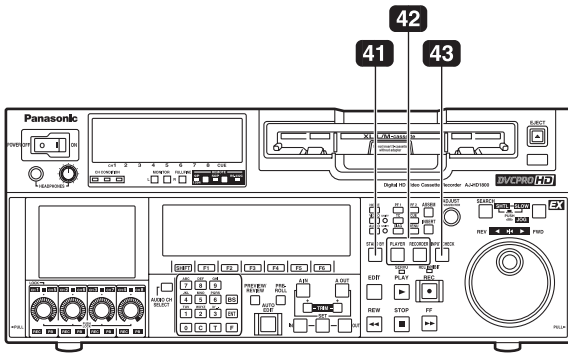

41 STANDBY button

While the head drum is rotating, the button's lamp lights to indicate that the standby ON mode is now established. The same tape tension is applied as in the regular stop mode.

If the button is pressed in the stop mode, the standby OFF mode is established followed by the half loading mode. At this time, its lamp goes off.

When the VTR is left in the stop mode beyond a specific period of time, it is automatically set to the standby OFF mode in order to protect the tape.

In the standby OFF mode, if this button or the STOP button is pressed, the VTR is set to the standby ON mode. If a button other than the STOP button is pressed, the VTR is set to the mode that corresponds to the button pressed.

The time taken by the VTR to transfer to the standby OFF mode can be selected using a setup menu item.

42 PLAYER and RECORDER buttons

These buttons are operated if the VTR is to be used as a recorder to conduct editing operations with a VTR equipped with an RS-422A serial interface remote control connector (9 pins). Neither button works when the VTR is used on its own.

PLAYER:

When this button is pressed, its lamp lights to indicate that the player connected to the VTR can be operated by remote control. The VTR's editing and tape transport system buttons can now be used to control the player.

RECORDER:

When this button is pressed, its lamp lights to indicate that the editing and tape transport system buttons can now be used to operate the recorder (this VTR).

- When the PLAYER button or RECORDER button is pressed while ENA has been selected as the setup menu item No.200 (PARA RUN) setting, the lamps of both buttons light to indicate that the VTR now serves as the master unit for parallel run operations. However, when this setting is used, it is no longer possible to perform external control from the REMOTE connector (9 pins).

43 INPUT CHECK button

Only while this button is held down are the input signals from the monitor output connector output to enable the input video and audio signals to be monitored.

The time code generator can be checked on the time code display.

Select LATCH as the setup menu item No.517 (TCG OUT) setting in order to continue displaying the time code generator value even after the INPUT CHECK button has been released.

<Notes>

- The INPUT CHECK function does not work for the CUE signal. Input signals can be monitored in the EE mode.
- The monitor operation varies with the VIDEO/AUDIO input selection. For details, refer to the INPUT CHECK output specifications on pages 17 and 18.

Parts and their functions (continued)

Front panel (8)

INPUT CHECK output specifications

VIDEO

Input selection (MENU 600)	INT SG	HD SDI	SD SDI	1394
Output system				
HD SDI (MONITOR)	INT SG*	HD SDI	MUTE (BLACK)	1394*
SD SDI (MONITOR)	INT SG*	MUTE (BLACK)	SD SDI	1394*
LCD (MONITOR)	INT SG*	HD SDI*	SD SDI	1394*
VIDEO OUT3	INT SG*	HD SDI*	SD SDI*	1394*

* Only output from the internal signal processing circuit is delayed.

<Notes>

- Signals for INT SG input are selected in Menu No. 601.
- INPUT CHECK is disabled when 23/24 Hz mode or 25 Hz (HD, SD) mode and 50 Hz (HD, SD) mode are selected.
- INPUT CHECK is disabled during tape playback when INT SG or 1394 is selected.
- INPUT CHECK is disabled in VIDEO OUT3. It returns to the normal output state.

Parts and their functions (continued)

INPUT CHECK output specifications (continued)

AUDIO (EE mode)

MONITOR L/R and HEAD PHONE L/R interlock with the MONITOR SELECT button on the front panel.

AUDIO Input selection	INT SG				SDI			
VIDEO Input selection	INT SG	HD SDI	SD SDI	1394	INT SG	HD SDI	SD SDI	1394
Output system								
HD SDI (MONITOR)	INT SG*	INT SG*	MUTE	1394*	HD SDI*	HD SDI*	MUTE	1394*
SD SDI (MONITOR)	INT SG*	MUTE	INT SG*	1394*	HD SDI*	MUTE	SD SDI*	1394*
MONITOR L	INT SG*	INT SG*	INT SG*	1394*	HD SDI*	HD SDI*	SD SDI*	1394*
MONITOR R	INT SG	INT SG	INT SG*	1394*	HD SDI*	HD SDI*	SD SDI*	1394*
HEAD PHONE L	INT SG*	INT SG*	INT SG*	1394*	HD SDI*	HD SDI*	SD SDI*	1394*
HEAD PHONE R	INT SG*	INT SG*	INT SG*	1394*	HD SDI*	HD SDI*	SD SDI*	1394*

AUDIO Input selection	AES/EBU				ANALOG			
VIDEO Input selection	INT SG	HD SDI	SD SDI	1394	INT SG	HD SDI	SD SDI	1394
Output system								
HD SDI (MONITOR)	AES/EBU*	AES/EBU*	MUTE	1394*	ANALOG*	ANALOG*	MUTE	1394*
SD SDI (MONITOR)	AES/EBU*	MUTE	AES/EBU*	1394*	ANALOG*	MUTE	ANALOG*	1394*
MONITOR L	AES/EBU*	AES/EBU*	AES/EBU*	1394*	ANALOG*	ANALOG*	ANALOG*	1394*
MONITOR R	AES/EBU*	AES/EBU*	AES/EBU*	1394*	ANALOG*	ANALOG*	ANALOG*	1394*
HEAD PHONE L	AES/EBU*	AES/EBU*	AES/EBU*	1394*	ANALOG*	ANALOG*	ANALOG*	1394*
HEAD PHONE R	AES/EBU*	AES/EBU*	AES/EBU*	1394*	ANALOG*	ANALOG*	ANALOG*	1394*

* Only output from the internal signal processing circuit is delayed.

AUDIO (Tape mode)

MONITOR L/R and HEAD PHONE L/R interlock with the MONITOR SELECT button on the front panel.

AUDIO Input selection	INT SG				SDI			
VIDEO Input selection	INT SG	HD SDI	SD SDI	1394	INT SG	HD SDI	SD SDI	1394
Output system								
HD SDI (MONITOR)	INT SG* ¹	TAPE* ²	MUTE	1394* ¹	HD SDI* ¹	TAPE* ²	MUTE	1394* ¹
SD SDI (MONITOR)	INT SG* ¹	MUTE	TAPE* ²	1394* ¹	HD SDI* ¹	MUTE	TAPE* ²	1394* ¹
MONITOR L	INT SG* ¹	INT SG* ¹	INT SG* ¹	1394* ¹	HD SDI* ¹	HD SDI* ¹	SD SDI* ¹	1394* ¹
MONITOR R	INT SG* ¹	INT SG* ¹	INT SG* ¹	1394* ¹	HD SDI* ¹	HD SDI* ¹	SD SDI* ¹	1394* ¹
HEAD PHONE L	INT SG* ¹	INT SG* ¹	INT SG* ¹	1394* ¹	HD SDI* ¹	HD SDI* ¹	SD SDI* ¹	1394* ¹
HEAD PHONE R	INT SG* ¹	INT SG* ¹	INT SG* ¹	1394* ¹	HD SDI* ¹	HD SDI* ¹	SD SDI* ¹	1394* ¹

AUDIO Input selection	AES/EBU				ANALOG			
VIDEO Input selection	INT SG	HD SDI	SD SDI	1394	INT SG	HD SDI	SD SDI	1394
Output system								
HD SDI (MONITOR)	AES/EBU* ¹	TAPE* ²	MUTE	1394* ¹	ANALOG* ¹	TAPE* ²	MUTE	1394* ¹
SD SDI (MONITOR)	AES/EBU* ¹	MUTE	TAPE* ²	1394* ¹	ANALOG* ¹	MUTE	TAPE* ²	1394* ¹
MONITOR L	AES/EBU* ¹	AES/EBU* ¹	AES/EBU* ¹	1394* ¹	ANALOG* ¹	ANALOG* ¹	ANALOG* ¹	1394* ¹
MONITOR R	AES/EBU* ¹	AES/EBU* ¹	AES/EBU* ¹	1394* ¹	ANALOG* ¹	ANALOG* ¹	ANALOG* ¹	1394* ¹
HEAD PHONE L	AES/EBU* ¹	AES/EBU* ¹	AES/EBU* ¹	1394* ¹	ANALOG* ¹	ANALOG* ¹	ANALOG* ¹	1394* ¹
HEAD PHONE R	AES/EBU* ¹	AES/EBU* ¹	AES/EBU* ¹	1394* ¹	ANALOG* ¹	ANALOG* ¹	ANALOG* ¹	1394* ¹

*1 Only output from the internal signal processing circuit is delayed.

*2 The playback sounds from the same tape as the main line system are output.

<Notes>

- Noise may occur if VIDEO INPUT does not synchronize with OUTREF.
- Signals at the time when INT SG input is selected can be selected in Menu No. 761.
- INPUT CHECK is disabled while playing back a tape when INT SG or 1394 is selected.

Rear panel

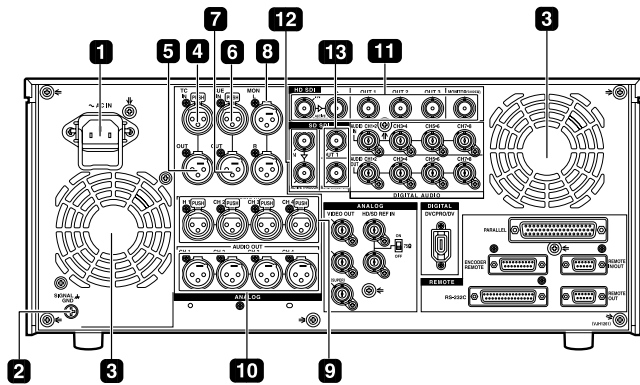

1 AC IN socket

Using the power cord supplied, connect one end to this socket and the other end to the power outlet.

2 SIGNAL GND terminal

This is connected to the signal ground terminal on the component connected to this VTR in order to minimize noise. It is not a safety ground.

3 Fan

The fan is used to cool down the VTR.

When the fan stops due to an abnormal condition, the warning symbol (W) is displayed on the time code display section and a warning beep is sounded.

If the VTR is made to continue operating in the warning status, the temperature inside the deck rises, and when it exceeds the safety temperature, all the VTR's operations will be shut down.

4 TIME CODE IN connector

This connector is used to record an external time code onto the tape.

5 TIME CODE OUT connector

During playback, the playback time code is output through this connector. During recording, the time code generated by the internal time code generator is output.

6 CUE IN connector

The analog signals to be recorded on the CUE tracks are input through this connector.

Audio signals from a microphone can also be recorded by selecting the -60 dB input mode for setup menu item No.704 (CUE IN LV).

7 CUE OUT connector

The analog signals recorded on the CUE tracks are output through this connector.

8 MONITOR OUT connectors

The CH1, CH2, CH3, CH4, CH5, CH6, CH7 and CH8 PCM audio signals or CUE signals are output through these connectors.

9 ANALOG AUDIO IN connectors

These are the analog audio input connectors (for CH1, CH2, CH3 and CH4).

10 ANALOG AUDIO OUT connectors

These are the analog audio output connectors (for CH1, CH2, CH3 and CH4).

11 HD SERIAL DIGITAL COMPONENT AUDIO VIDEO IN/OUT connector/ACTIVE THRU

The HD digital component audio and video signals complying with the SMPTE 292M, 296M and 299M standards are input and output through this connector.

Signals with the time code, menu or other superimposed information are output from the HD SDI MONITOR.

For INPUT CHECK, refer to the INPUT CHECK output table on pages 17 and 18.

12 SD SERIAL DIGITAL COMPONENT AUDIO VIDEO IN connector/ACTIVE THRU

This is an input connector for SD SDI signals that comply with the SMPTE 259M-C, 272M-A, or ITU-R BT.656-4 standards. The SD SDI input acts as an up converter and records data.

13 SD SERIAL DIGITAL COMPONENT AUDIO and VIDEO OUT connectors

The digital component audio and video signals complying with the SMPTE 259M-C or 272M-A standard are output from these connectors. Video signals are output during DVCPRO50M/25M/DV/DVCAM compatible playback and down-converting output. Video images are output from the SD SDI MONITOR together with supers such as the TC/Menu.

Using setup menu item No.606 (SD MONI O SEL), it is also possible to make the SD SDI MONITOR output the same output as SD SDI OUT1 (no information superimposed).

When "SD SDI" has been selected as the **[F1]** (VID IN) setting on the <VIDEO> menu and "THRU" has been selected as the No.107 (EE MODE SEL) setting, no information is superimposed onto the SD SDI MONITOR output signals in the EE mode, and the same output as SD SDI OUT1 is delivered.

- For INPUT CHECK, refer to the INPUT CHECK output table on pages 17 and 18. Note that the signals are muted during cross conversion.

<Note>

In the 23/24 Hz mode, the system phase of the SD SDI output and analog composite video output is subject to change when the tape has been set to travel at the normal speed (1×) so that the HD SDI output and phase will be aligned.

Rear panel (continued)

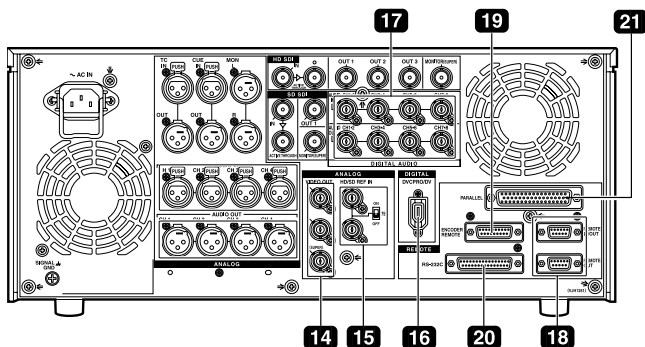

14 ANALOG COMPOSITE VIDEO OUT connectors

The analog composite video signals are output through these connectors. They are output during DVCPRO50M, 25M, DV or DVCAM interchangeable playback or when signals are down-converted and output.

Video signals containing superimposed information can be output through the VIDEO OUT 3 connector. Whether the superimposing is to be set ON or OFF is selected using the setup menu item No.005 (SUPER).

15 HD/SD REF IN connector and 75 Ω terminal switch

These are the input connectors for the HD/SD reference video signals and the loop-through output connector. To terminate signals, turn the switch [ON].

<Notes>

- To use the connector as the HD reference, input the positive-negative bipolar three-value synchronization signal. Input signals that conform to the input signal or the tape format.
- To use the connector as the SD reference, input black burst signals must comply with SMPTE170M and ITU624-4.

16 IEEE1394 digital input/output

The IEEE1394 digital interface is available for input and output. Use a 6-pin type connector. Bus power is not supported.

<Notes>

- Ensure that the connections with other devices are made on a 1:1 basis.
- When an IEEE1394 cable has been connected to the IEEE1394 digital input/output connector, do not apply any strong external force as this may damage the connector.
- When error code E-92 (1394 INITIAL ERROR) appears, disconnect the connecting cables and re-connect them or turn off the unit's power and turn it back on.
- The AV signals may be disrupted when the power of the connected devices is turned on or off and when the 1394 cable is connected or disconnected.
- When the input signals are switched or the mode is transferred, it may take a few seconds for the system to stabilize. Proceed with the recording operation only after the system has stabilized.
- The following situation applies when recording is to be performed by selecting the IEEE1394 digital interface input, and it applies with the signals which are output by the IEEE1394 digital interface.
 - When playback signals other than regular 1× speed playback signals have been input, no guarantees are made for the pictures and sound which will be recorded or for the EE-type pictures and sound.
- The following situation applies when the video input selection has been set as the IEEE1394 digital interface.
 - The SDI signals, the analog video output signals and time code output signals become irregular in the EE mode. Do not use these signals for recording purposes. (The teletext signals and other signals superimposed onto the video output signals also become irregular.)

- During SLOW/STILL playback, unprocessed video and audio signals are output as the IEEE1394 digital interface output. When these video and audio signals are monitored using another device, they may differ from the video and audio signals played back by this unit. When the equipment for non-linear editing is connected to this unit, do not start any other application program than software for the non-linear edit. Non-linear editing equipment may garble the output video picture.

Be absolutely sure to bear the following points in mind when connecting the IEEE1394 cable.

- Ensure that the unit and all of the connected devices are each grounded (or connected to a common ground) before use. If it is not possible to ground the unit and devices, turn off the power of the unit and of all the connected devices before connecting or disconnecting the IEEE1394 cable.
- When the unit is to be connected to a device equipped with a 4-pin type of connector, connect the unit's connector (6-pin type) first.
- When connecting the unit with a PC equipped with a 6-pin type of connector, connect the 1394 cable as dictated by the shapes of the IEEE1394 connectors. Bear in mind that inserting a plug the wrong way round may damage the unit.

Right

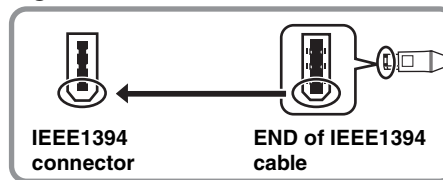

Wrong

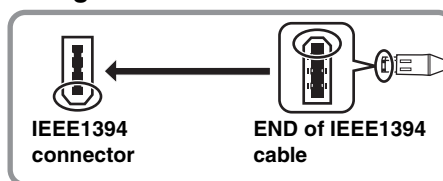

17 DIGITAL AUDIO IN and OUT connectors

These are the input and output connectors of the digital audio signals that comply with the AES/EBU standards.

18 Remote control connectors

The unit can be operated externally by connecting two units or an external controller to one unit.

Two remote control connectors are provided: one for IN/OUT uses and the other for OUT uses only.

IN/OUT: For connection with an external controller

For connection during deck-to-deck operations

OUT: For connection during parallel run operations

For loop-through uses

19 ENCODER REMOTE connector

An external encoder remote controller is connected to this connector when the video output signal settings are to be adjusted from an external component.

20 RS-232C connector

Data communication is available by connecting the unit to a personal computer.

21 PARALLEL REMOTE connector

The unit can be operated externally with the 50-pin parallel remote.

Connections

Example of connections performed for one VTR

Set the REMOTE LED **10** on the front panel to the off status (LOCAL mode).

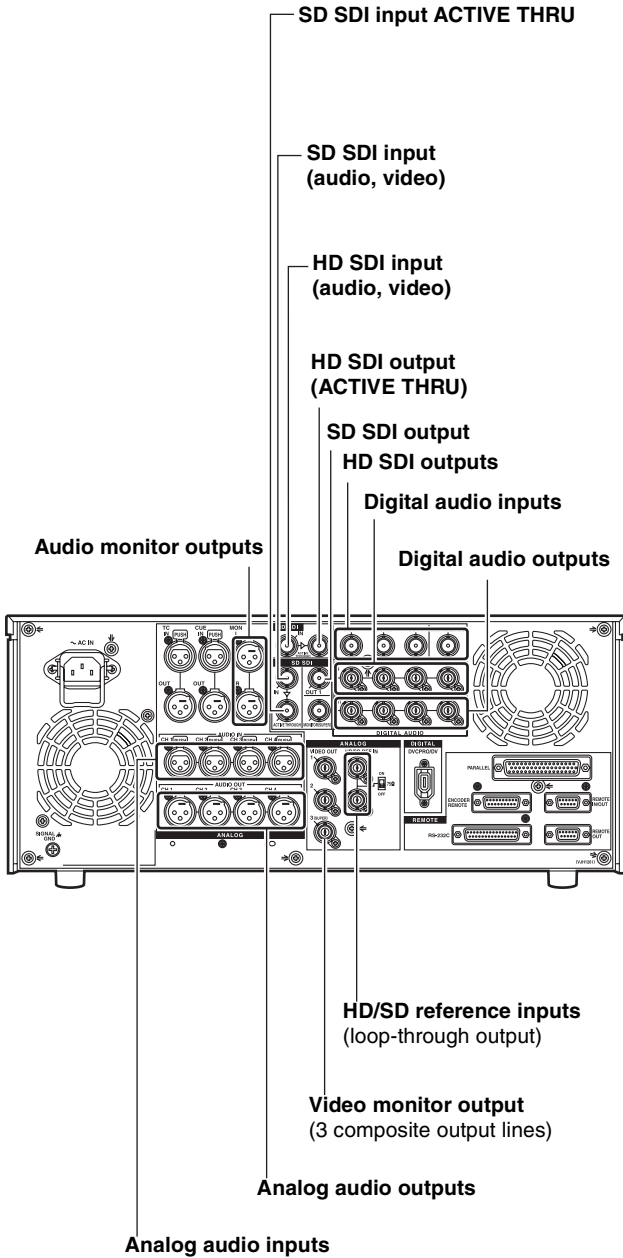

Example of connections performed for two VTRs (deck-to-deck)

Source side:

Press the "9P 1394" REMOTE button on the front panel for 2 or more seconds to set the VTR to the REMOTE status. (The LED lights.)

Recorder side:

Set the REMOTE LED **10** on the front panel to the off status (LOCAL mode).

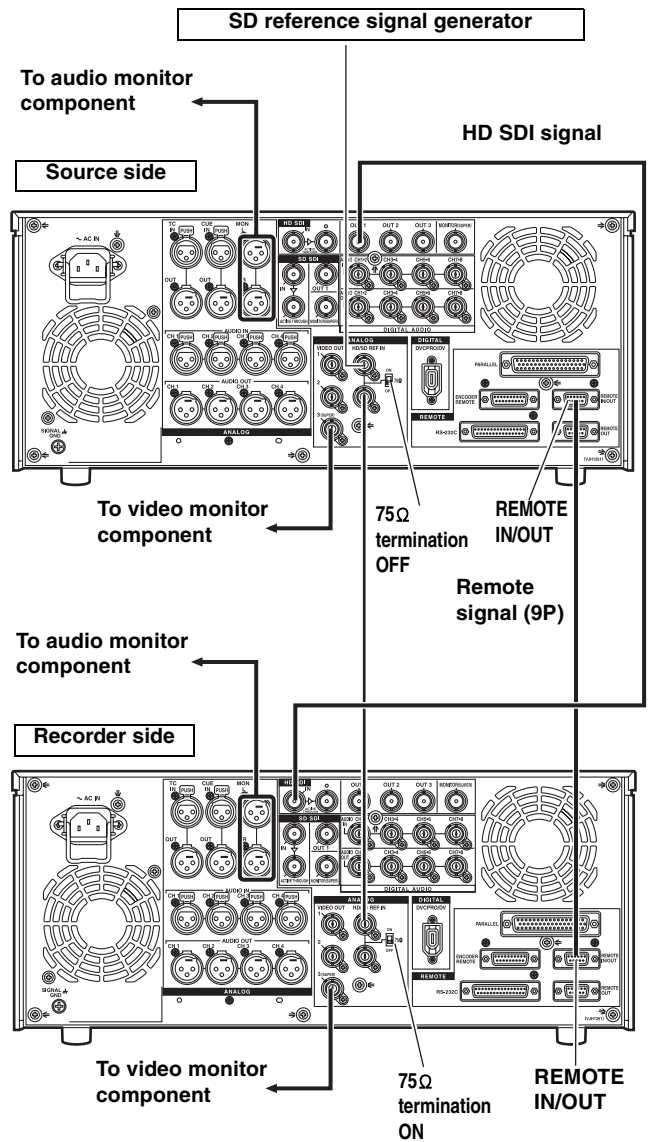

Connections (continued)

Example of connections in 23/24 Hz or 25/50 Hz (HD) mode

When a tape recorded with a frame rate of 24 fps (25/50 fps) using a variable frame rate camera is played back on the unit, data can be converted and output in 1080/24 psf (1080/25 psf or 1080/50i) and recorded on the AJ-HD3700 series. Shown in the figure below is an example of the deck-to-deck connections.

Input the 48 Hz (or 50 Hz) reference signal as the REF input.

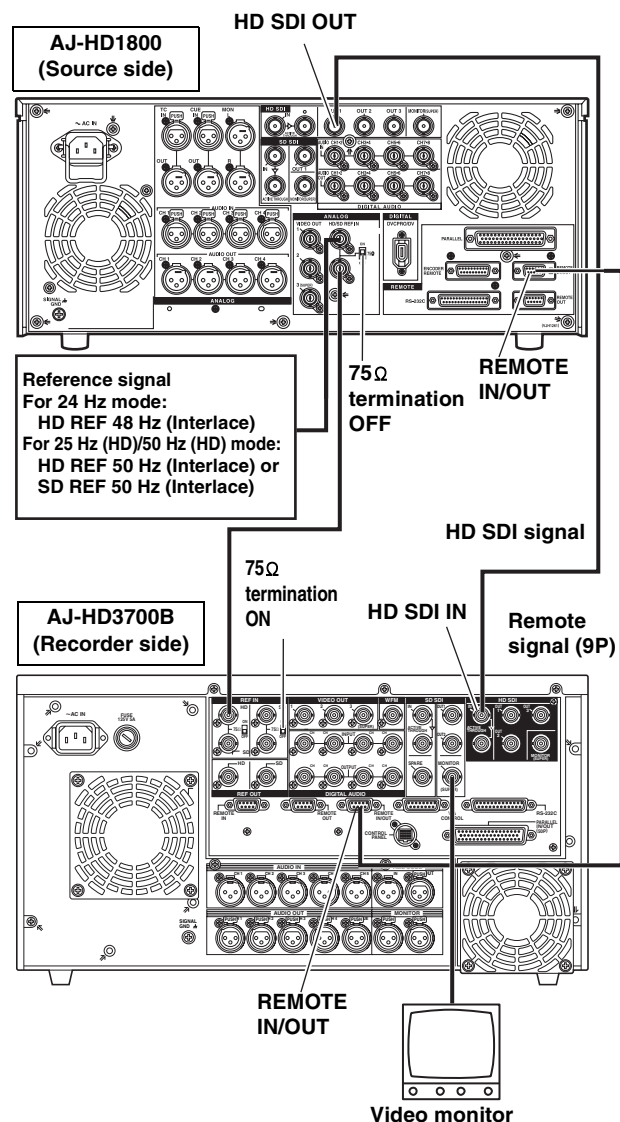

<Notes>

- When the tape begins to travel at 1× speed, the video may be disturbed and the audio muted for several frames in order to synchronize the REF input with the tape.
- VITC signals are not output to the SD SDI and VIDEO OUT connectors in the 23/24 Hz mode.
- In the 25/50 (HD) Hz mode, the output video signals of the SD SDI and VIDEO OUT connectors are delayed by approximately 1 field in relation to the HD SDI output.
- HD SDI output is muted in the 25/50 Hz (SD) mode.

Example of connections in 25/50 Hz (SD) mode

When a tape recorded with a frame rate of 25/50 fps using a variable frame rate camera is played back on the unit, data can be converted and output in 576/50i and recorded in the SD-VTR. An example of a connection between decks is shown in the following illustration.

Input the 50 Hz reference signal to the SD REF input connector as the REF input.

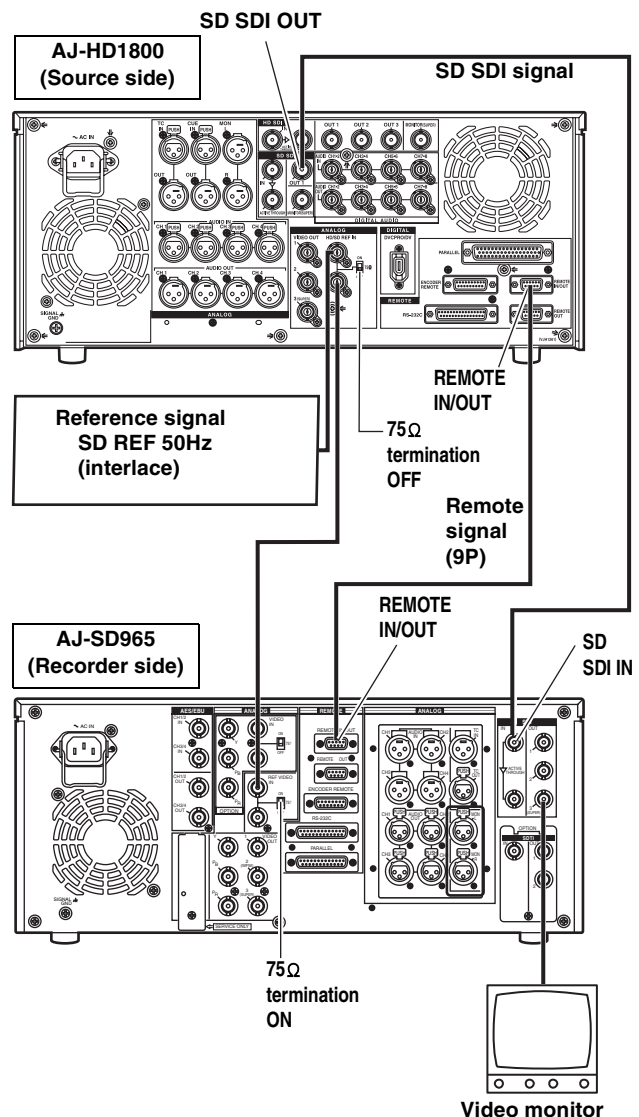

Note concerning tapes played back by this VTR

- Use tapes which have been shot by a variable frame rate camera.
- Do not use tapes which are copies of shot tapes or edited tapes. Doing so will cause the tape management information to be lost, and normal conversion and playback may not be possible as a result.
- To convert a tape recorded at frame rates other than 24 fps (25/50 fps) into 1080/24 psf (1080/25 psf or 1080/50i), use the frame rate converter (optional AJ-FRC27).

Connections (continued)

Example of connections with an editing controller

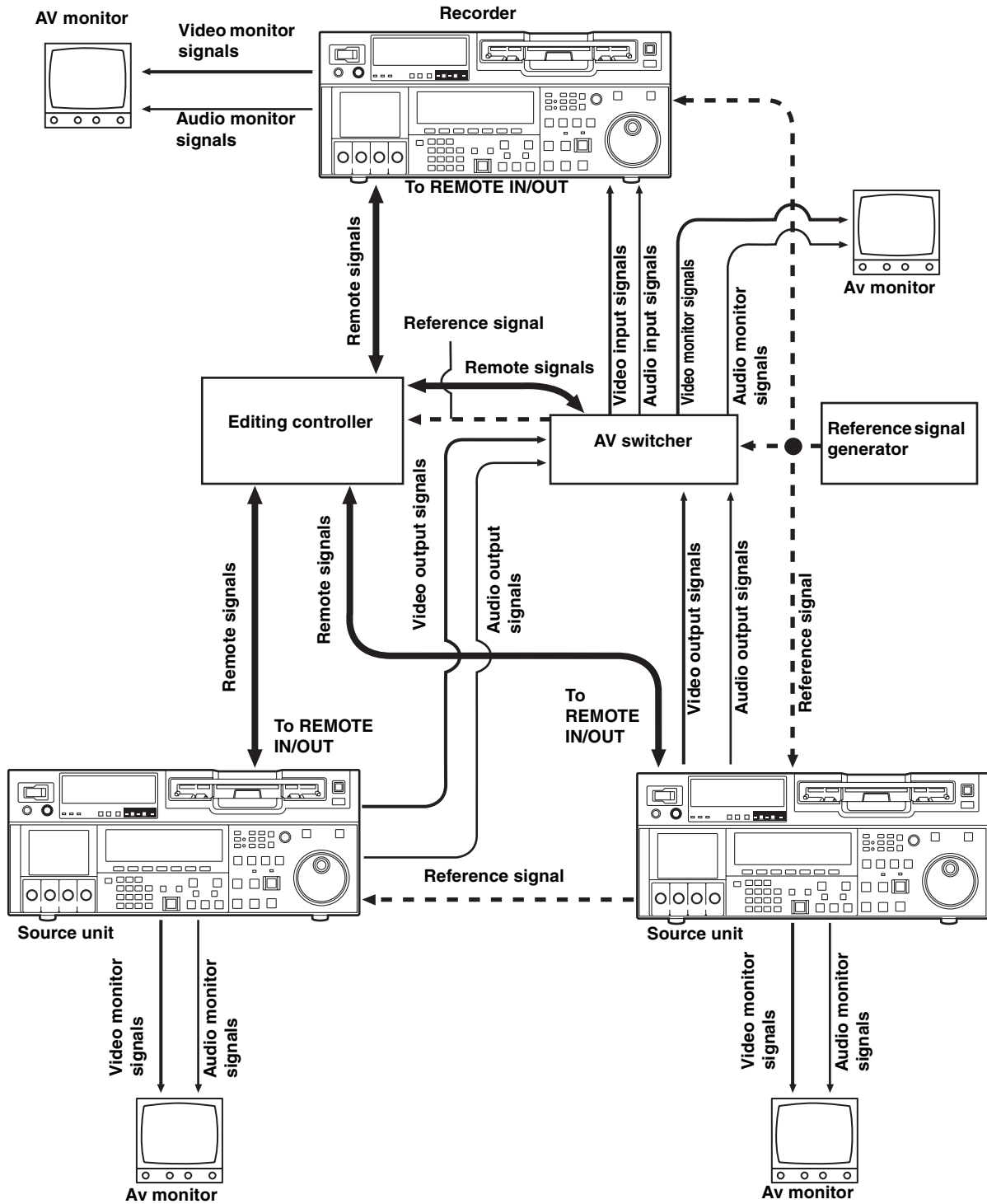

<Note>

When disconnecting the remote signals (9P) from one component and re-connecting them to another component, check the settings, etc. of the editing controller.

Concerning tapes

Consumer-use DV and DVCAM cassettes (Standard DV and DVCAM cassettes, mini DV and DVCAM cassettes)

Use a cassette adapter (AJ-CS455P) when a mini DV or DVCAM cassette is to be used.

Note that inserting a mini DV or DVCAM cassette without the use of a cassette adapter will cause malfunctioning.

Also note that long-duration mini DV cassettes (80 minutes in the standard mode and 120 minutes in the LP mode) cannot be used.

<Precautions when playing back consumer-use DV and DVCAM tapes>

- It is not possible to play back consumer-use tapes which have been recorded in the LP mode.
- The maximum transport speed of a consumer-use DV or DVCAM cassette tape is 32×.
- The maximum still time for a consumer-use DV or DVCAM cassette tape is 10 seconds.
- From the perspective of protecting consumer-use DV and DVCAM cassette tapes, minimize the number of times the tapes are cued up at the same place as far as possible.
- When consumer-use DV and DVCAM cassette tapes are used, the maximum time for STILL TIMER is set to 10 seconds and the total time elapsing when the VTR is left standing in the STILL mode (When the STEP FWD mode is selected) is set to 1 minute.
- When editing material which has been recorded onto a consumer-use DV or DVCAM cassette tape, first record the material onto a DVCPRO HD tape or another VTR used for broadcasting applications.
- Noise may occur when performing slow playback using consumer-use DV or DVCAM cassette tapes.

It is recommended that tapes bearing the Panasonic brand be used as the consumer-use DV tapes.

M cassettes

Tapes capable of up to 33 minutes of recording or playback (AJ-HP33EMG: for AJ-HD1800E)

L cassettes

Tapes capable of up to 64 minutes of recording or playback (AJ-HP64ELG)

XL cassettes

Tapes capable of up to 126 minutes of recording and playback (AJ-HP126EXG)

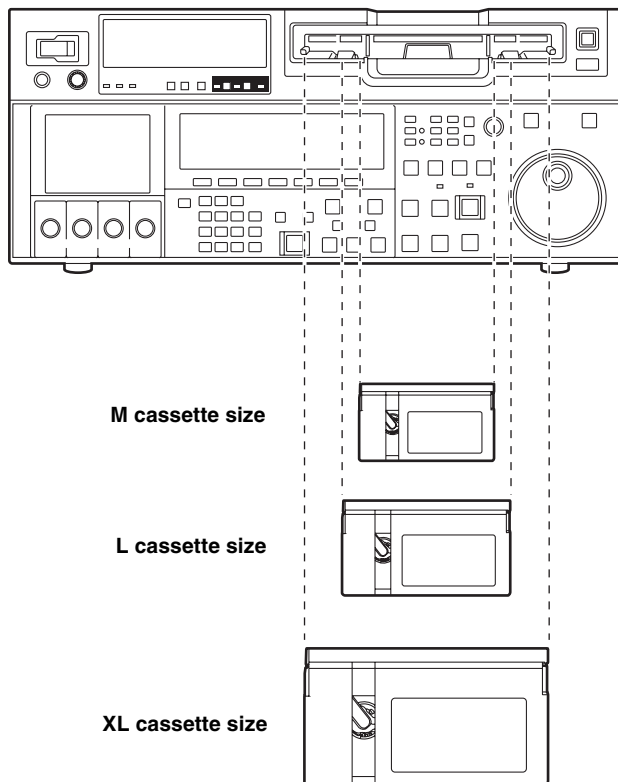

Align the cassette with the center of the insertion slot, and push it in gently.

The cassette tape will be loaded automatically.

<Notes on cassette insertion>

- Set the cassette level with the cassette slit and insert straight.
- Do not put your hand in the cassette slit.
- Insert an M/L-cassette between the left/right M/L-cassette guides.
- If the cassette slit is exposed to the strong direct rays of the sun, a malfunction in the tape travel may occur.

Turning on the power and inserting the cassette

Before starting to operate the VTR, check whether the equipment has been connected properly.

- 1 Turn on the VTR's power.
- 2 Check that the AUTO OFF lamp is off.
If condensation or some other problem has occurred, the AUTO OFF lamp lights, and no further operations can be performed.
- 3 Insert the cassette tape.
Without forcing it, insert the cassette tape at the prescribed position.
- 4 Check that the STOP lamp is lighted.
When the tape is inserted, the cylinder starts rotating automatically, the tape is loaded, and the VTR is set to the STOP mode. The EJECT lamp goes off.

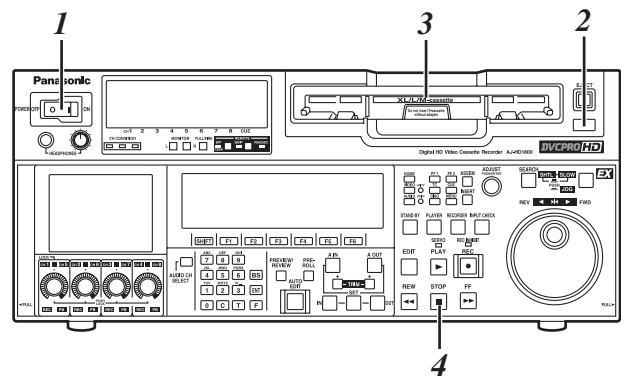

STOP and STANDBY modes

- 1 The VTR is set to the STOP mode when its STOP button is pressed.
The STOP lamp lights, and the tape stops running.
 - In order to protect the tape, the VTR is set to standby OFF after the time set by setup menu item No.400 (STILL TIMER) has elapsed. If the STOP, REW, FF or PLAY button is now pressed, the VTR will be set to the corresponding mode.
- 2 The VTR is set to the STANDBY ON/OFF mode when its STAND BY button is pressed.
The standby ON mode is established while the button's lamp is lighted. When the button is pressed in the standby OFF mode, the VTR is set to the standby ON mode.
When the button is pressed while the VTR is in the STOP mode, it is set to the standby OFF mode and the half-loading status, and the button's lamp goes off.

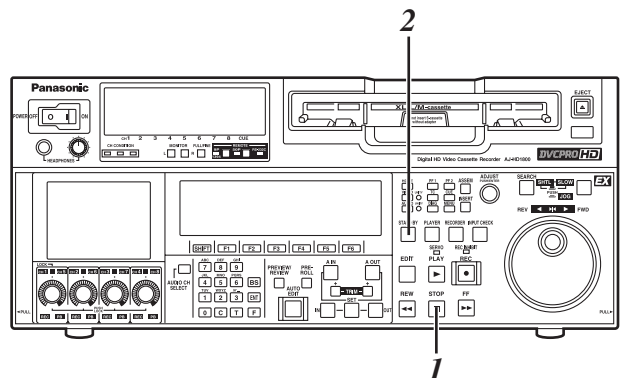

<Precautions for STILL TIMER setting>

The cumulative total standby time at the same place increases when programs are transmitted or the same material is used repeatedly. In order to protect the tape, keep the standby time at the same place on the tape as short as possible by, for instance, selecting a maximum of 30 seconds or so as the setup menu item No.400 (STILL TIMER) setting.

Recording

- 1 Set the accidental erasure prevention tab on the cassette tape to the "REC" position, and insert the tape.
- 2 Press the STOP button to set the VTR to the stop mode.
- 3 Select "EE" as the OUTPUT setting using [F1] on the <HOME> menu. EE pictures now appear on the TV monitor.
- 4 Check that the REC INHIBIT lamp is off.
If the lamp is lighted, select "OFF" as the R INH setting using [F6] on the <HOME> menu.
If the inserted cassette has been formatted in a format other than DVCPRO HD-LP, recording is prohibited by default (factory settings) as set in SETUP MENU No. 118 (SP MODE INH).
- 5 Select the video and audio input signals, and adjust the audio levels.

Selecting the video and audio input signals

- ① Connect the signals to be recorded.
- ② Select the input signals using [F1] on the <VIDEO> menu and [F1] to [F6] on the <AUDIO> menu or <AUDIO SHIFT1> menu

Adjust the audio levels

- ① Adjust the audio input levels of the CH1, CH2, CH3, CH4, CH5, CH6, CH7, CH8 audio signals and analog cue signal selected on the AUDIO menu.
When the audio UNITY lamp on the front panel is lighted, the audio signals will be recorded at the appropriate levels.
 - ② Before adjusting the recording level, check that the REC LED is lighted and that the audio adjustment dial is in the unlocked status (LOCK LED off).
If the dial is in the LOCK status (LOCK LED lighted), press it. The LOCK LED goes off, and the lock is released.
In addition, the analog cue audio recording level is adjusted using setup menu item No.790 (CUE REC VOL) so that it will not exceed -20 dB.
- 6 Press the PLAY button while holding down the REC button.
The REC and PLAY lamps light, and recording starts.
 - 7 When the STOP button is pressed, the recording ends, and the VTR is set to the stop mode.

<Notes>

- During recording, check that the SERVO lamp is lighted. The playback pictures will be disturbed if it is blinking or off.
- If analog signals (ANA1 to ANA4) have been selected as the CH5 to CH8 input signals on the AUDIO menu, their recording levels are tied in with the recording levels which have been set for the CH1 to CH4 signals.
- The audio playback level of 1394 output cannot be adjusted.

Playback

- 1** Insert the cassette tape, and set the VTR to the STOP mode.
- 2** Press the PLAY button.
Normal playback commences.
- 3** Adjust the audio playback levels.
Before adjusting the playback levels, check that the PB LED is lighted and that the audio adjustment dial is in the unlocked status. If the dial is locked (indicated by the lighted LOCK LED), press it. The LOCK LED goes off, and the lock is released. The analog cue audio level is adjusted using setup menu item No.791 (CUE PB VOL). Normally, the VTR is kept in the UNITY status (the segment display of the control lights at the center).
- 4** To end the playback, press the STOP button. The VTR is now set to the STOP mode.

<Notes>

- During playback, check that the SERVO lamp is lighted.
The playback pictures will be disturbed if the lamp is off or blinking.
- The audio playback level of 1394 output cannot be adjusted.

Playback phase adjustment function

If two VTRs are to be used to play the same program, the playback phase between the VTRs can be adjusted by changing the playback speed of one of the VTRs.

- 1** Press the TRIM button (“+” or “-” button) while holding down the PLAY button. Each time it is pressed, the playback speed is accelerated or decelerated in increments of the number of playback framing fields selected by the setup menu item No.109 (CAP.LOCK) setting.
The SERVO lamp remains off while the tape is being played at the accelerated or decelerated speed.
- 2** Upon completion of the playback phase adjustment, release the PLAY button.
The VTRs now return to the standard playback speed, and the SERVO lamp lights.

Jog/Shuttle

Jog Mode

- 1** Push in the search dial.
Confirm that the JOG lamp lights.
- 2** Turn the search dial.
The dial's click-stops are released, and the tape is played back at the speed corresponding to the speed at which the dial is turned.
The maximum jog speed can be changed by selecting the setup menu item No.310 (JOG FWD MAX) and No.311 (JOG REV MAX) settings.
When the dial is no longer turned, a still picture will appear.
- 3** To transfer the VTR from the jog mode to another mode, press the button that corresponds to the mode concerned.

<Note>

The default setting for the search dial is the direct search mode for moving to the shuttle mode/jog mode/variable mode.

It is possible to set the mode to the search mode only when the search button is pressed by changing the setting in SETUP MENU No. 100 (SEARCH ENA) to [KEY].

Shuttle Mode

- 1** Press the search dial to return the pressed dial to the original position.
The SHTL lamp lights, and the mode becomes the shuttle mode.
 - Immediately after turning on the power, turn the search dial to the center position.
- 2** Press the SHTL/SLOW button to shift to [SHTL] or [SLOW].
- 3** Turn the search dial.
 - When the lamp lights for [SHTL] of JOG/SHTL/SLOW, the playback rate will vary within the range from 0 to +/-32 times. The range can be changed to +/-9.8, +/-16, and +/-32 times in SETUP MENU No. 101 (SHTL MAX). When the dial is at the center position, images become still pictures.
 - When the lamp lights for [SLOW] of JOG/SHTL/SLOW, the playback rate will vary within the range from -4.9 to +4.9 times. The maximum rate can be switched in SETUP MENU No. 308 (VAR FWD MAX) and No. 309 (VAR REV MAX). However, noise may be generated unless the rate is set within the range from -1.0 to +2.0 times. For recording tapes other than the DVCPRO HD-LP recording tape, noise may be generated unless the rate is set within the range from -1.0 to +1.1 times. When the dial is at the center position, images become still pictures.
- 4** To move from the Shuttle mode to other modes, press the STOP button or other buttons.

<Notes>

- From the audio monitor output, audio can be played back when the rate is within the range from -32 to +32 times. However, you must select [PCM] in SETUP MENU No. 746 (MONI CH SEL).
- Audio playback in search mode may contain some noise.

Manual Editing

1 Select the editing mode.

ASSEM button:

Assemble (frame-to-frame continuity) editing is performed using this button.

INSERT button:

Insert editing is performed using this button.

2 On the time code display, select the channels to be edited.

ASSEM:

Set ASSEM to ON using the **[F1]** button.

INSERT :

To select V, A1, A2, A3, A4 and CUE channels, press the **[F1]** to **[F6]** buttons; to select A5, A6, A7, A8 and TC channels, press the **[SHIFT] + [F2]** to **[SHIFT] + [F6]** buttons. The highlighted channels will now be edited.

3 Press the PLAY button.

4 While monitoring the TV monitor, search the position where the editing is to be started (IN point), and press the PLAY and EDIT buttons together at this position.

5 Similarly, while monitoring the TV monitor, search the position where the editing is to be terminated (OUT point), and press the PLAY or STOP button at this position. The VTR is set to the PLAY or STOP mode, and the editing is terminated.

Preroll

Press the PREROLL button.

The VTR now performs the preroll operation.

When the cue time has been registered on the HOME, PF1 or PF2 screen:

The tape is prerolled from the registered cue time using the preroll time which was set using **[F1]** (PREROL) on the <HOME SHIFT> menu.

When the search mode is established on the CUE screen:

The tape is prerolled from the selected cue point using the preroll time which was set using **[F5]** (CU-ROL) on the <CUE SHIFT> menu.

The preroll operation is not performed when the selected cue point has not been registered or when the cue point registration mode is established.

In all other situations:

The tape is prerolled from the registered IN point (or the current tape position when the IN point has not been registered) using the preroll time which was set using **[F1]** (PREROL) on the <HOME SHIFT> menu.

If the PREROLL button is pressed when the IN point has not been registered, the current tape position is automatically registered as the IN point [but only when ENA has been selected as the setup menu item No.305 (AUTO ENTRY) setting].

<Note>

The time code or CTL signal must be continuously recorded between the edit IN point and preroll point.

Automatic Editing (deck-to-deck)

“Editing” refers to the work involved in using pre-recorded tapes to bring different contents together or delete unnecessary parts and bring together only the necessary parts.

The basic editing steps are as follows.

- 1 Using the REMOTE button, set the player to REMOTE and the recorder to LOCAL (ensure that the REMOTE LED is not lighted).
- 2 Select the editing mode (ASSEM or INSERT).
- 3 Register the edit points of the recorder and player.
- 4 Check and modify, if necessary, the edit points.
- 5 Preview the material before editing it.
- 6 Proceed with the editing (AUTO EDIT).
- 7 Review the edited results.

Switch settings and adjustments

When using this VTR as the recorder

Set the VTR to the LOCAL status (which is indicated when the REMOTE LED is OFF).

Set the POWER switch to ON.

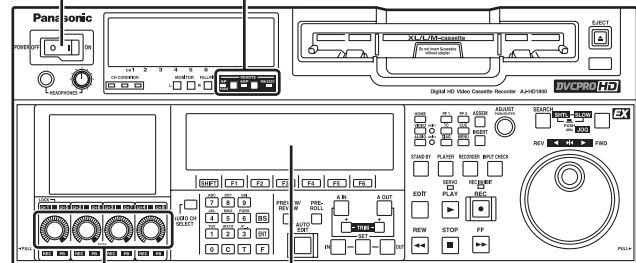

Adjust the recording levels.

Switch the time counter display to TC or CTL.

When using this VTR as the player

Press the 9P button for 2 or more seconds to set the VTR to the REMOTE status which is indicated when the REMOTE LED is ON.

Set the POWER switch to ON.

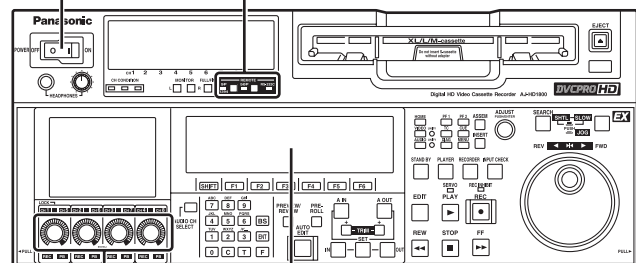

Adjust the playback levels.

Switch the time counter display to TC or CTL.

Automatic Editing (deck-to-deck) (continued)

Selecting the editing mode

1 Select the editing mode.

ASSEM button:

Assemble (frame-to-frame continuity) editing is performed in this mode.

INSERT button:

Insert editing is performed in this mode.

2 On the time code display, select the channels to be edited.

ASSEM :

Set ASSEM to ON using the **[F1]** button.

INSERT :

To select V, A1, A2, A3, A4 and CUE channels, press the **[F1]** to **[F6]** buttons; to select A5, A6, A7, A8 and TC channels, press the **[SHIFT]** + **[F2]** to **[SHIFT]** + **[F6]** buttons. The highlighted channels will now be edited.

3 Press the **PLAYER** or **RECORDER** button to select the VTR which is to be operated. (Settings when two VTR units are connected.)

PLAYER :

Press this button if the player VTR is to be operated to register the edit points.

RECORDER :

Press this button if the recorder VTR (this VTR) is to be operated to register the edit points.

[ASSEM screen]

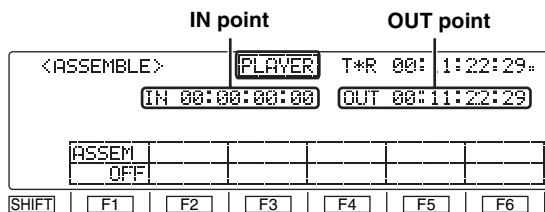

[INSERT screen]

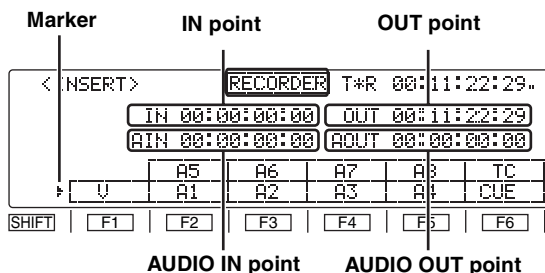

Registering the edit points

1 Locate the edit IN point by performing the jog or shuttle operation. Set the tape to the still picture status at the desired position.

For a detailed description of the jog and shuttle operations, refer to page 28.

2 Press the **IN** button and **SET** button together. The edit IN point is now registered. The edit IN point value appears on the display.

3 Locate the edit OUT point by performing the jog or shuttle operation. Set the tape to the still picture status at the desired position.

4 Press the **OUT** button and **SET** button together. The edit OUT point is now registered. The edit OUT point value appears on the display.

5 The edit points can be registered directly using the number keys.

1. Select the <ASSEMBLE> or <INSERT> menu.
2. Press the **[T]** button to highlight the edit point. Turn the **ADJUST** dial to move the highlighting to the IN point or OUT point.
3. Press the **[T]** button again, and input the desired edit point directly using the number keys. Turn the **ADJUST** dial to move from one digit to the next.
4. Press the **[ENT]** button to register the point. To abort the registration at any time, press the **[C]** button.

To reset a particular edit point (to 00:00:00:00), press the **[T]** button, align the highlighting with the edit point concerned, and press the button again.

Next, press the **[F]** button and **[0]** button together. Finally, press the **[ENT]** button to register the point.

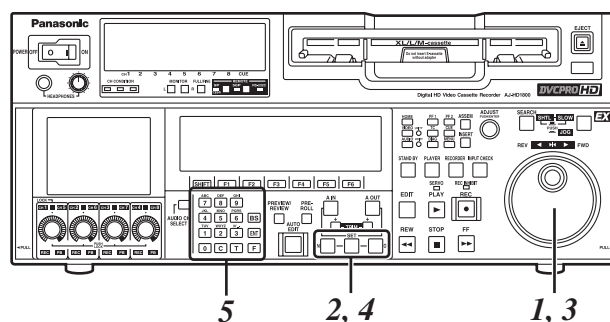

Match frame processing function

When two VTRs are used to perform the editing operations, there will be a total of 4 edit points: the IN and OUT points for the player and the IN and OUT points for the recorder. However, the last point is automatically calculated so only three of the edit points need to be registered.

Negative duration function

Use setup menu items No.300 (IN/OUT DEL) and No.301 (NEGA FLASH) in combination.

Automatic Editing (deck-to-deck) (continued)

Checking the edit points

- 1 Press the IN (or OUT) button to check the edit point.
The value of the registered edit point appears on the display.
- 2 While holding down the IN (or OUT) button, press the PREROLL button to check the picture at the edit point.
The tape is cued up to the edit IN (or OUT) point, and a still picture of the point appears.
 - If "STOP" has been selected as the setup menu item No.307 (AFTER CUE-UP) setting, the VTR is set to the EE mode provided that EE has been selected as the <HOME> menu **F1** (OUTPUT) setting.
- 3 By holding down the IN and OUT buttons at the same time, check the editing duration. The duration appears on the display.

How the duration is calculated

- When two edit points have been set
The duration between the two points is calculated.
- When only one edit point has been set
The duration between the data which has been set and the current address is calculated.
- When no edit points have been set
The duration of the previously edited section is calculated.

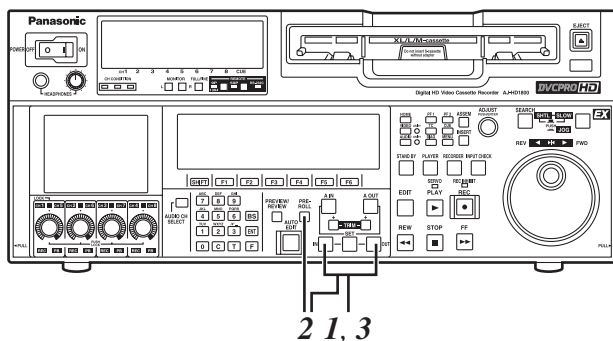

Modifying edit points

- 1 Re-registering an edit point
Locate the new edit point by performing the jog or shuttle operation, and press the IN (or OUT) button and SET button at the same time to re-register the edit point.
- 2 Modifying an edit point in 1-frame increments (trimming function)
Press the TRIM button while holding down the IN (or OUT) button.
Each time the + button is pressed, the point is moved ahead by one frame.
Conversely, each time the - button is pressed, the point is moved back by one frame.
- 3 Resetting edit points
 - ① Resetting both an edit IN point and OUT point
Press **F4** (TC CLR = RESET) on the <HOME> menu.
(This takes effect only in the CTL mode.)
 - ② Resetting either an edit IN point or OUT point
Press the **C** button among the number keys while holding down the IN (or OUT) button.

<Notes>

- An edit OUT point can be reset even while editing is in progress.
- In the eject mode, the IN and OUT points are automatically reset.

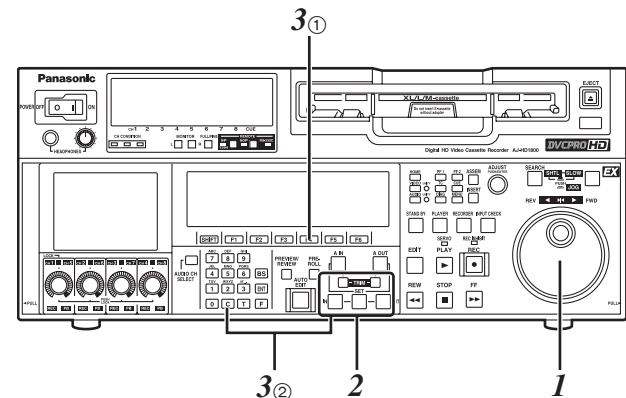

Automatic Editing (deck-to-deck) (continued)

Previewing

I After the edit points have been registered, press the PREVIEW button.
Regular preview is now conducted.

<Notes>

- If the edit IN point has not been registered, the position where the PREVIEW button was pressed is registered as the edit IN point.
- To stop the preview at any time, press the STOP button.
- When the PREVIEW button is pressed again after the IN point during the course of a preview, the preview will start again from the beginning.
- When the edit OUT point is reached, the tape is postrolled, after which it stops automatically.

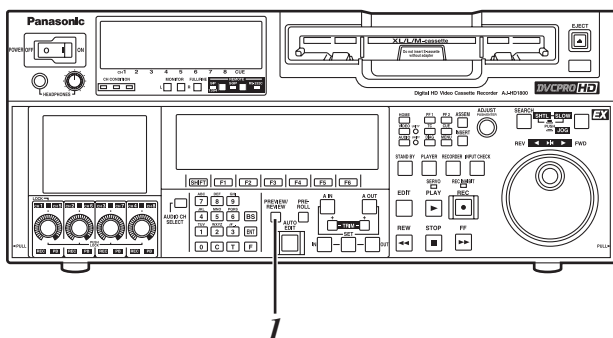

<Note>

The registered points are automatically cleared after editing has been executed. However, the previous edit points can be recalled by pressing the TRIM+ (or TRIM-) button and SET button at the same time.

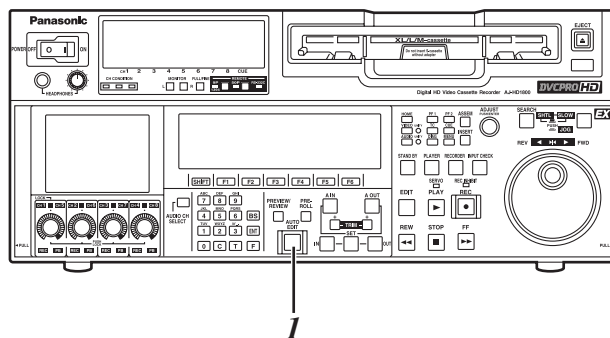

Reviewing

I Upon completion of the editing, press the REVIEW button.
Review is now started by the recorder.

- To stop the review at any time, press the STOP button.
- When the edit OUT point is reached, the tape is postrolled, after which it stops.

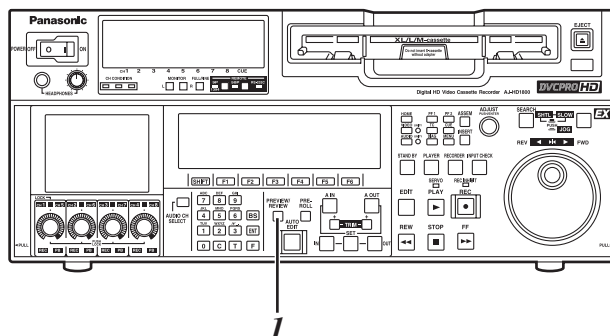

Automatic editing

I Press the AUTO EDIT button.
Automatic editing is now executed.

- To suspend editing at any time, press the STOP button.
- When the edit OUT point is reached, the tape is postrolled, after which it stops.

Postrolling

In the case of assemble editing, editing continues for about 2 seconds after the edit OUT point is passed, and the tape is then returned to the OUT point, after which it stops.

In the case of insert editing, the PLAY mode is established after the edit OUT point has been passed, and the tape is then returned to the OUT point, after which it stops.

Retry function

Even when the STOP button has been pressed to suspend editing, editing can be repeated from the beginning simply by pressing the AUTO EDIT button again.

Auto tag function

If, upon completion of editing, when the AUTO EDIT button is pressed although the next edit point has not yet been registered, the previous edit OUT point is registered as the IN point, and editing is executed.

To release the auto tag mode, press one of the transport system buttons (such as the PLAY button).

Audio Split Editing

The video edit points and audio edit points can be registered independently, and editing can be executed with the video points offset from the audio points.

Audio edit points cannot be registered when the assemble editing mode has been selected.

After registering the edit points, proceed with the same operations as for insert editing.

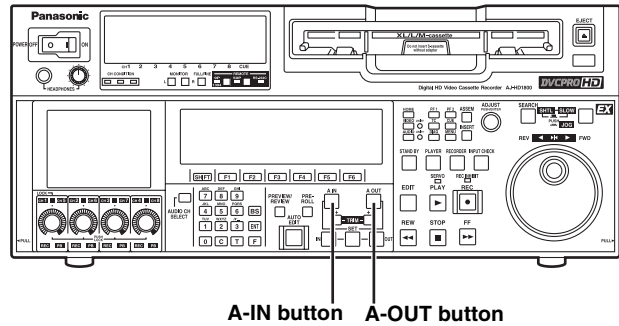

■ Registering the edit points

Video IN point:

While holding down the IN button, press the SET button.

Video OUT point:

While holding down the OUT button, press the SET button.

Audio IN point:

While holding down the A-IN button, press the SET button.

Audio OUT point:

While holding down the A-OUT button, press the SET button.

<Note>

If the editing mode is changed to assemble editing after the audio edit points have been registered, the audio edit points will be cleared.

■ Clearing the edit points

Video IN point:

While holding down the IN button, press the **C** button among the number keys.

Video OUT point:

While holding down the OUT button, press the **C** button among the number keys.

Audio IN point:

While holding down the A-IN button, press the **C** button among the number keys.

Audio OUT point:

While holding down the A-OUT button, press the **C** button among the number keys.

■ Modifying the edit points

Video IN point:

While holding down the IN button, press the TRIM+ button or TRIM- button.

Video OUT point:

While holding down the OUT button, press the TRIM+ button or TRIM- button.

Audio IN point:

While holding down the A-IN button, press the TRIM+ button or TRIM- button.

Audio OUT point:

While holding down the A-OUT button, press the TRIM+ button or TRIM- button.

■ Cueing the tape up to the edit points

Cue-up to video IN point:

While holding down the IN button, press the PREROLL button.

Cue-up to video OUT point:

While holding down the OUT button, press the PREROLL button.

Cue-up to audio IN point:

While holding down the A-IN button, press the PREROLL button.

Cue-up to audio OUT point:

While holding down the A-OUT button, press the PREROLL button.

■ Duration display

The duration can be indicated on the display.

Between the video IN and OUT points:

Press the IN button and OUT button at the same time.

Between the audio IN and OUT points:

Press the A-IN button and A-OUT button at the same time.

Match frame processing function

When two VTRs are used to perform the audio split editing operations, there will be a total of 8 edit points: the video IN and OUT points for the player, the video IN and OUT points for the recorder, the audio IN and OUT points for the player, and the audio IN and OUT points for the recorder.

When five of the eight edit points are registered, the remaining three points are automatically calculated so only five of the edit points can be registered.

■ When a VTR not equipped with the split editing function is used as the player

When a VTR for which the video and audio edit points cannot be set independently is used as the player, split editing is still possible by setting the audio IN point and OUT point in the recorder and setting the data of three points as the video edit points.

<Note>

If, during audio split editing, the video OUT point (or audio OUT point) only is registered without the audio OUT (or video OUT point) having been registered and automatic editing is then executed, editing will continue until either the audio OUT point (or video OUT point) is registered or the STOP button is pressed to suspend the editing operation.

Variable memory function

Variable memory function selection

The variable memory mode can be selected by setting **[F6]** (VARMEM) on the <HOME SHIFT> menu to "ON."
When **[F6]** (VARMEM) is set to "OFF," the variable memory mode is canceled, and the regular mode is established.

<Note>

Bear in mind that when the 23/24 Hz, 25 Hz (HD or SD), 50 Hz (HD or SD) mode has been selected as the system menu item No.25 (SYSTEM FREQ) setting, **[F6]** (VARMEM) will no longer appear on the display and the variable memory mode cannot be selected.

Outline

This VTR is provided with two variable memory functions, as follows. These functions can be used in the variable memory mode.

Variable memory playback:

Any section of the tape can be played back at variable speeds in the VAR mode, the changes in the speed can be stored in the memory, and the tape can be played back at the memorized speed.

Variable memory editing:

Using the VTR as a controller (recorder in the deck-to-deck mode) to control the playback speed of the player, editing can be performed in the variable speed mode.

Variable memory playback operation procedure

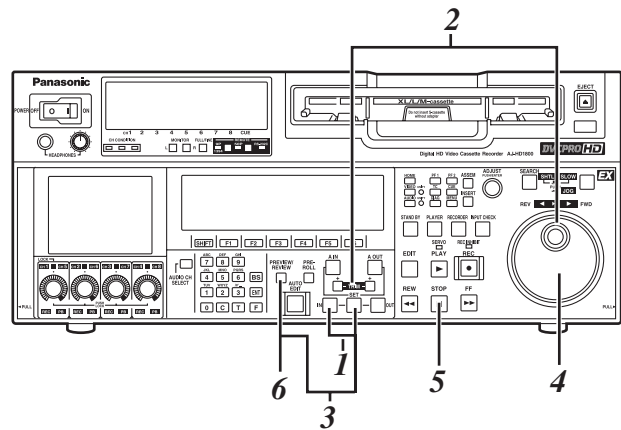

To perform variable memory playback operations, set the VTR to the variable memory mode, and take the steps below.

- 1 Register the IN point using the SET button and IN button. There is no need to set the OUT point for variable memory playback.
- 2 Set the initial speed ($-1.0\times$ to $+2.0\times$) using the search dial while holding down the SET button.
- 3 When the SET button and PREVIEW/REVIEW button are pressed at the same time, the tape is automatically prerolled and played back at the initial speed setting up to the IN point.
- 4 After the tape has passed the IN point, turn the search dial to store the playback speed in the memory.
- 5 Press the STOP button to stop the tape.
- 6 When the PREVIEW/REVIEW button is pressed, variable memory playback is performed at the memorized speed.

<Notes>

- After passing the IN point, the tape is played back in accordance with the settings in the memory, and it continues to run at the last speed stored in the memory until the STOP button is pressed.
- Whatever is stored in the memory will be cleared when the VTR exits the variable memory mode. It is also cleared when the POWER switch is set to "OFF."

Variable memory function (continued)

Variable memory editing operation procedure

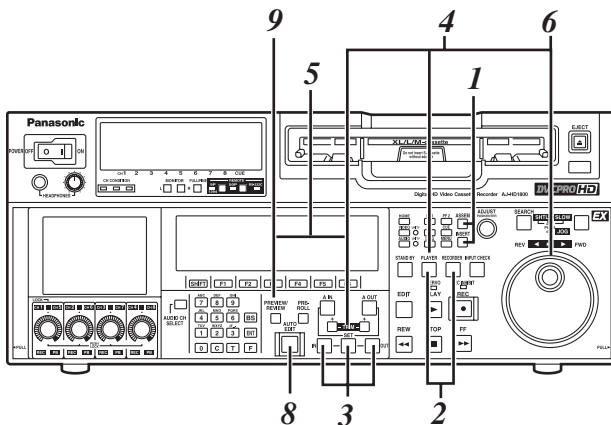

To perform variable memory editing operations, set this VTR, which is connected as the recorder to the variable memory mode, and take the steps below.

- 1** Select the editing mode on the <ASSEMBLE> or <INSERT> menu.
- 2** Select the VTR to be operated by pressing the RECORDER or PLAYER button.
- 3** Register the IN and OUT points using the SET button and IN and OUT buttons. The player's OUT point cannot be registered.
- 4** Press the PLAYER button to select the player VTR, and then set the initial speed using the search dial while holding down the SET button.
- 5** When the SET button and PREVIEW/REVIEW button are pressed at the same time, the tapes in both the player and recorder are automatically prerolled, and the player VTR plays back the tape at the initial speed setting up to the IN point.
- 6** After the tape has passed the IN point, turn the search dial to store the playback speed of the player VTR in the memory.
- 7** When the tape passes the OUT point that was set by the recorder, the storing of the playback speed in the memory ends.
- 8** When the AUTO EDIT button is pressed, variable memory editing is executed. Once editing has been executed, the memorized speeds will be cleared except for the initial speed which is not cleared.
- 9** By pressing the PREVIEW/REVIEW button, the edited results can be checked.

<Notes>

- Whatever is stored in the memory will be cleared when the VTR exits the variable memory mode. It is also cleared when the POWER switch is set to "OFF."
- Phase synchronization is not performed during playback up to the IN point of the variable memory editing. Therefore, depending on the VTR used as the player and its speed setting, no guarantees are made for the accuracy of the IN point.
- When conducting variable memory editing in the speed range of $-1.0\times$ to $+2.0\times$, use VTRs with which these speeds are guaranteed for both the recorder and player.

Function menus

The function menus are used to set the functions which are frequently used.
The function menus are selected directly using the direct menu buttons on the front panel.

General description

General menus

<HOME>, <HOME SHIFT>

The most basic settings for recording, playback and TC operations are set on these menu screens.

<VIDEO>, <VIDEO SHIFT>

The basic input/output settings for the video signals are performed and, moreover, the level of the HD output signals can also be adjusted on these menu screens.

<AUDIO>, <AUDIO SHIFT1>, <AUDIO SHIFT2>

The basic input/output settings for the audio signals are performed on these menu screens.

<TC>, <TC SHIFT>

The TC-related settings are performed on these menu screens.

The settings for superimposing time codes on the display can also be performed on these menu screens.

<PF1 FT>, <PF1 BK>, <PF2 FT>, <PF2 BK>

Up to 24 frequently used menu items which have been registered can be used on these menu screens.

<CUE>, <CUE SHIFT>

A maximum of 60 cue points can be set on these menu screens. In the PAGE mode, 10 pages with 6 cue points on each page are provided so that the cue points can be managed on a page-by-page basis.

<DIAG>, <DIAG SHIFT>

Information such as Warnings/Hour meter/UMID can be confirmed.

On the SHIFT window, error log files can be confirmed, deleted, and stored or retrieved from an SD memory card.

<MENU>, <MENU SHIFT>

It is possible to move the operation (adjusting, storing, or retrieving from internal memory and an SD memory card) window related to the SYSTEM and the SETUP menu.

<ASSEMBLE>

The ASSEMBLE editing mode is selected on this menu screen.

<INSERT>

The INSERT editing mode and editing channels are selected on this menu screen.

Special menus

<<SYSTEM MENU>>

The SYSTEM menu is displayed on-screen, enabling various adjustments to be made.

<<SETUP MENU>>

The SETUP menu is displayed on-screen, enabling various adjustments to be made.

<<FILE>>

The current setting information, including the SETUP menu contents, can be provided with titles and either saved in or loaded from the backup memory in one of 4 variations.

<<PF1 FT ASSIGN>>, <<PF1 BK ASSIGN>>

<<PF2 FT ASSIGN>>, <<PF2 BK ASSIGN>>

The SETUP menu items which can be registered are displayed on-screen, and they can be registered into or deleted from the function buttons.

<<IC CARD/MENU>>

Up to eight kinds of current settings, including the contents of the SETUP menu with titles, can be stored or retrieved from an SD memory card.

<<IC CARD/ERR LOG>>

Up to eight kinds of the error logs with titles can be stored or retrieved from an SD memory card.

<<IC CARD/MULT CUE>>

Up to eight kinds of MULTI CUE menus with titles can be stored or retrieved from an SD memory card.

<<50P IN ASSIGN>>, <<50P OUT ASSIGN>>

Using the front panel controls and on-screen menus, the functions are registered into the input pins of the parallel remote (50PIN) connector and the statuses are registered into its output pins.

Function menus (continued)

Allocating the function keys

Menu (6 types)	Menu hierarchy	Items allocated to function keys					
		F1	F2	F3	F4	F5	F6
HOME	1st	OUTPUT		TC/CTL	TC CLR	CMP MD	R INH
	2nd (SHIFT)	PREROL		OUTREF	CAPSTN		VARMEM
VIDEO	1st	VID IN	INT SG			UP CON	DW CON
	2nd (SHIFT)			V LV	C LV	HUE	SUP LV
	3rd (F+SHIFT)	BRIGHT	COLOR	CONTRAST	BACK L		
AUDIO	1st	A1 IN	A2 IN	DIN 12	A3 IN	A4 IN	DIN 34
	2nd (SHIFT)	A5 IN	A6 IN	DIN 56	A7 IN	A8 IN	DIN 78
	3rd (SHIFT)	VOLUME		RECCUE			M MIX
TC	1st	TC SRC		TCG MD	TCG RG	RUN MD	DF MOD
	2nd (SHIFT)	SUPER	C HPOS	C VPOS	DISPLY	C TYPE	TIMER
PF1	1st	No factory settings (any items can be allocated to any keys).					
	2nd (SHIFT)						
PF2	1st						
	2nd (SHIFT)						
CUE MULTICUE function	1st	PREV	NEXT	MODE	CLR	AL CLR	
	2nd (SHIFT)		CARD	PAGE	ROTATE	CU-ROL	
DIAG ERROR LOG function	1st	WARN	HOURS	UMID	DIF1	DIF2	
	2nd (SHIFT)	STEP	CARD			AL CLR	
MENU	1st	FILE	CARD		SYSTEM	SETUP	
	2nd (SHIFT)	PF1 FT	PF1 BK	PF2 FT	PF2 BK	50P IN	50P OT
ASSEM		ASSEM					
INSERT			A5	A6	A7	A8	TC
		V	A1	A2	A3	A4	CUE
SYSTEM SYSTEM MENU (ON SCREEN)				CANCEL	RESET	SET	EXIT
SETUP SETUP MENU (ON SCREEN)		↑ PREV	↓ NEXT	CANCEL	RESET	SET	EXIT
FILE USER FILE BACKUP function		PLOAD	LOAD ←	SAVE →		LOCK	EXIT
PF1,PF2 MENU ASSIGN function		↑ PREV	↓ NEXT	CANCEL	RESET	SET	EXIT
CARD IC CARD function (MENU) IC CARD function (ERRLOG) IC CARD function (MULTI CUE)		FORMAT	SAVE ←	LOAD →	DELETE	LOCK	EXIT
50PIN 50pin ASSIGN function		↑ PREV	↓ NEXT	CANCEL	RESET	SET	EXIT

Function menus (continued)

<HOME>

The most basic settings for recording, playback and TC operations are set on this menu screen.

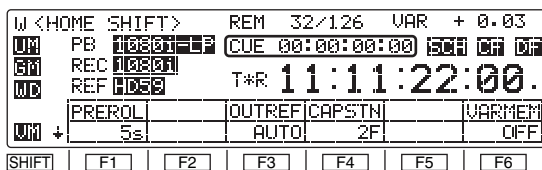
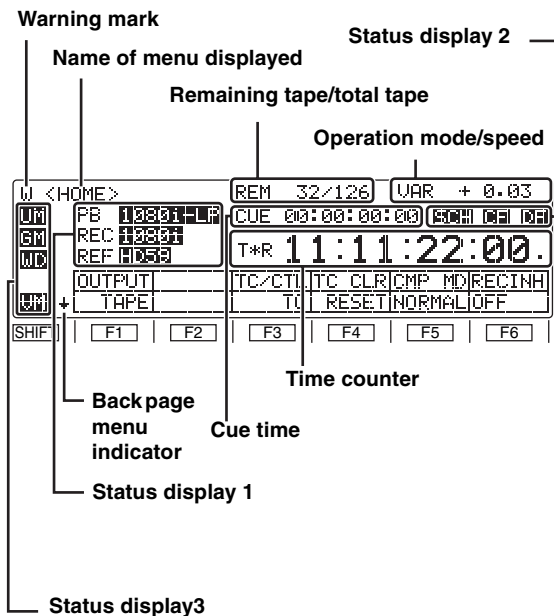

How to switch the settings

Toggle:

Each time a function button is pressed, the setting is changed or entered.

F + toggle*:

When a function button is pressed while the F button is held down, the setting can be changed or entered each time.

Toggle + ADJ:

When a function button is pressed, the setting is highlighted, and the status in which the setting can be changed is established.

The ADJUST dial is used to change the setting.

When the same function button is pressed again and the highlighting is released, the setting is entered.

Press:

When a function button is pressed, the setting can be changed while the button is held down or at the instant when it is pressed. When the function button is released, the original setting is restored.

F + press*:

When a function button is pressed while the F button is held down, the setting can be changed while the button is held down or at the instant when it is pressed. When the function button is released, the original setting is restored.

* When only the function button is pressed, message display "Press [F] + [F5]" etc. blinks.

Function button

[F1] to [F6]:

These buttons control the functions displayed in the Function Menu.

<Note>

Changes in the settings made with the function buttons that control the Setup Menu are reflected in the system immediately, but about 5 seconds is required to store the settings. To turn off the power after changing the settings, wait about 5 seconds or more and then turn off the power.

[SHIFT]:

This button shifts the display alternately between the current function menu and the back page menu.

Back Page Menu Indicator

↓: This is displayed when the front page menu is displayed.

↑: This is displayed when the back page menu is displayed.

Function button operation inhibited indicator

This is displayed when the [BS] button is pressed while the [F] button is held down. When it appears, the operation of the function buttons can be inhibited. When the button is pressed again while the [F] button is held down, the display is cleared, and it becomes possible to operate the function buttons.

Warning symbol

When a warning occurs on the unit, the warning symbol (W) blinks. (For details, refer to the Function Menu <DIAG> on page 57.)

Function menus (continued)

<HOME> (continued)

Display menu name

	Display menu name	Description of menu	
General menu	<HOME>	<HOME SHIFT>	The most basic settings for recording, playback, and time code operation are made.
	<VIDEO>	<VIDEO SHIFT>	The basic input/output settings for video signals are made. The level of HD output signals is also adjusted on this screen.
	<AUDIO>	<AUDIO SHIFT1> <AUDIO SHIFT2>	The basic input/output settings for audio signals are made.
	<TC>	<TC SHIFT>	Various settings related to the time code are set. Superimposing the time code is also set on this screen.
	<PF1 FT>	<PF1 BK>	Up to 24 frequently used menu items can be registered. Press F1 (PF1)/F2 (PF2) on the <MENU SHIFT> screen to display the menu items that can be registered on the connected video monitor and the LCD monitor.
	<PF2 FT>	<PF2 BK>	
	<CUE>	<CUE SHIFT>	Up to 60 cue points can be set. In PAGE mode, 6 cue points can be managed on a single page and (6 pieces × 10 pages) of the cue points in total can be managed on a page-by-page basis.
	<DIAG>	<DIAG> SHIFT>	<ul style="list-style-type: none"> The Warning/Hour meter can be confirmed on this screen. The error log files can be confirmed, deleted, and/or stored in/called from the SD memory card on the SHIFT screen.
	<MENU>	<MENU SHIFT>	This is used for moving to the operation (adjustment, storing in/calling from the internal memory, and an SD memory card) screen for SYSTEM SETUP MENU.
	<ASSEMBLE>		This selects the ASSEMBLE edit mode.
	<INSERT>		This selects the INSERT edit mode and the editing channels.
Special menu	<<SYSTEM MENU>>		The SYSTEM menu is displayed on the connected video monitor and the LCD monitor and can be adjusted.
	<<SETUP MENU>>		The SETUP MENU is displayed on the connected video monitor and the LCD monitor and can be adjusted.
	<<FILE>>		It is possible to record the present information on up to four settings, including the Setup Menu contents in backup memory with titles, and to then recall the records from memory.
	<<PF1 FT ASSIGN>> <<PF1 BK ASSIGN>>		It is possible to display the Setup Menu items that can be registered on the connected video monitor and the LCD monitor and register them on the function buttons.
	<<PF2 FT ASSIGN>> <<PF2 BK ASSIGN>>		
	<<IC CARD/MENU>>		It is possible to record information on up to eight current settings, including the Setup Menu contents on an SD card with titles and to then retrieve the records from the card.
	<<IC CARD/ERR LOG>>		It is possible to record up to eight separate error log entries on an SD card with titles and to then retrieve the records from the card.
	<<IC CARD/MULT CUE>>		It is possible to record up to eight separate entries in the multi-cue menu on an SD card with titles and to then retrieve the records from the card.
	<<50P IN ASSIGN>> <<50P OUT ASSIGN>>		The functions for the input terminal of the parallel remote connectors (50 pins) and the status for the output connectors can be registered using the front panel, the connected monitor, and the LCD monitor.

System frequency display during 24 Hz, 25 Hz (HD and SD), 50 Hz (HD and SD) modes

When the 23/24 Hz mode, the 25 Hz (HD, SD) mode or the 50 Hz (HD, SD) mode is selected in System Menu No. 25 (SYSTEM FREQ), the selected system frequency is indicated on function button **F1** to confirm the current system frequency mode.

<div style="border: 1px solid black; padding: 2px; display: inline-block;">SYSTEM</div> <div style="border: 1px solid black; padding: 2px; display: inline-block;">23/24</div> <div style="border: 1px solid black; padding: 2px; display: inline-block;">F1</div>	23/24	The 23/24 Hz mode is selected.
	25 (HD)	The 25(HD) Hz mode is selected.
	25 (SD)	The 25(SD) Hz mode is selected.
	50 (HD)	The 50 (HD) Hz mode is selected.
	50 (SD)	The 50 (SD) Hz mode is selected.

Function menus (continued)

<HOME> (continued)

Status display 1

VTR	Description of settings		
PB	Playback format This displays the format used for playback.	1080i LP	These settings indicate the DVCPRO HD-LP recording and playback mode.
		720p LP	
		1080i SP	These settings indicate the DVCPRO HD-SP playback mode.
		720p SP	
		50M	These settings indicate the DVCPRO (50 Mbps format) playback mode. <Note> In the case of "50Mp", the format can be determined; however, images and audio will not play back properly.
		50Mp	
		25M	
		DV	These settings indicate the DVCPRO (25 Mbps format), DV and DVCAM playback modes.
		DVCAM	
REC*1	Recording format This displays the format used for recording.	1080i	The tape is recorded using the 1080i format.
		720p	The tape is recorded using the 720p format.
TM INFO*2	Tape management information This displays the frame rate (shooting speed) information which is recorded on a tape shot by a variable frame rate camera.	- - -	A cassette tape has not been inserted.
		24P	These settings indicate the recorded frame rate.
		24PA	
		25P	
		INVALID	The tape management information is invalid. <Note> In some cases, the tape management information may be erroneously overwritten by insert editing or tape dubbing, and it may not be possible to play back properly.
REF	Output reference This displays the output reference status.	HD23	The HD REF input signal has been selected as the reference. The frame frequency is 23.98 Hz.
		HD24	The HD REF input signal has been selected as the reference. The frame frequency is 24 Hz.
		HD25	The HD REF input signal has been selected as the reference. The frame frequency is 25 Hz.
		HD50	The HD REF input signal has been selected as the reference. The field frequency is 50 Hz.
		HD59	The HD REF input signal has been selected as the reference. The field frequency is 59.94 Hz.
		HD60	The HD REF input signal has been selected as the reference. The field frequency is 60 Hz.
		IN50	The HD serial input signal has been selected as the reference. The field frequency is 50 Hz.
		IN59	The HD serial input signal has been selected as the reference. The field frequency is 59.94 Hz.
		IN60	The HD serial input signal has been selected as the reference. The field frequency is 60 Hz.
		INT23	The signal (23.98 Hz) from the internal generator has been selected as the reference.
		INT24	The signal (24 Hz) from the internal generator has been selected as the reference.
		INT25	The signal (25 Hz) from the internal generator has been selected as the reference.
		INT50	The signal (50 Hz) from the internal generator has been selected as the reference.
		INT59	The signal (59.94 Hz) from the internal generator has been selected as the reference.
		INT60	The signal (60 Hz) from the internal generator has been selected as the reference.
		NTSC59	The SD REF input signal has been selected as the reference. The field frequency is 59.94 Hz.
		PAL50	The SD REF input signal has been selected as the reference. The field frequency is 50 Hz.
		INT50P	The SD REF input signal has been selected by the OUT REF setting. Since the SD REF signal is not input, the signal (50 Hz) from the internal generator is selected as the reference.

*1: This status is not displayed when the 23/24 Hz, 25 Hz (HD or SD) or 50 Hz (HD or SD) mode has been selected as the system menu item No.25 (SYSTEM FREQ) setting.

*2: This status is not displayed when the 59/60 Hz or 50 Hz mode has been selected as the system menu item No.25 (SYSTEM FREQ) setting.

Function menus (continued)

<HOME> (continued)

Status display 2

Indicator	Description of setting
SCH	This lights when the SCH phase of the SDREF signal is within the prescribed range.
CF	This lights when color framing is locked.
DF	This lights during recording or playback in the drop frame mode. <Note> If the time code data could not be read properly ("T*R" is displayed), the display of the previous status is held.

Status display 3

Indicator	Description of setting
UM	For EE mode, this indicates that UMID information is available in input information. When a tape is played back, this indicates that UMID information is available on the tape.
WD	When [SQUEEZ] is selected in Setup Menu No. 620 (DOWNCON MODE) and down convert output is set to wide screen, this indicates that wide screen information is recorded on the tape for SD tape playback.
GM	This indicates that the gamma function is selected in Setup Menu No. 693 (GAMMA SEL).
VM	This is indicated when the function button F6 (VERMEM) of <HOME SHIFT> is turned [ON]. Whenever VM is displayed, the variable memory is operable. (For details, refer to [Variable memory function].)

Operation mode (speed) display

This indicates the current operation mode (including the speed display).

Display	Operation mode
EJECT	Eject mode
STANDBY OFF	Standby OFF mode
T.RELEASE	Tension release mode
STOP	Stop mode
PREROLL	Preroll mode
PLAY	Playback mode
PLAY +	Special playback (playback phase adjustment) mode (FWD direction)
PLAY -	Special playback (playback phase adjustment) mode (REV direction)
REC	Recording mode
JOG	Jog mode
REV/STILL/FWD	
VAR (speed) [-4.9 to +4.9]	Slow mode
SHTL (speed) [-32.0 to +32.0]	Shuttle mode
FF	Fast forwarding mode
REW	Rewinding mode
EDIT	Editing mode
AUTO EDIT	Automatic editing mode
PREVIEW	Preview mode
REVIEW	Review mode
When function F6 (VERMEM) on <HOME SHIFT> is "ON"	
DSPD (speed) [-1.0 to +2.0]	Initial speed setting of variable memory
DSMP (speed) [-1.0 to +2.0]	Playback speed memory mode of variable memory
DPLY (speed) [-1.0 to +2.0]	Playback mode of variable memory
DPRV (speed) [-1.0 to +2.0]	Preview mode of variable memory editing
DEDT (speed) [-1.0 to +2.0]	Execution mode of variable memory editing

Function menus (continued)

<HOME> (continued)

Playback reference signal specifications for tape playback

During tape playback, the video output reference signals are as shown in the table below.

In the 59.94 Hz/60 Hz or 50 Hz mode

Input signals		Menu item No.031				
REF_IN	INPUT	AUTO	INPUT*1	HD_REF	SD_REF	E-AUTO
HD_REF_IN	Input	HD_REF_IN	INPUT	HD_REF_IN	Internal SD	HD_REF_IN
		Complies with HD_REF_IN frequency	Complies with INPUT frequency	Complies with HD_REF_IN frequency	59.94Hz	Complies with HD_REF_IN frequency
	Not input	HD_REF_IN	Internal HD	HD_REF_IN	Internal SD	HD_REF_IN
		Complies with HD_REF_IN frequency	Complies with menu item No.030 frequency	Complies with HD_REF_IN frequency	59.94Hz	Complies with HD_REF_IN frequency
SD_REF_IN	Input	SD_REF_IN	INPUT	Internal HD	SD_REF_IN	SD_REF_IN
		59.94Hz	Complies with INPUT frequency	Complies with menu item No.030 frequency	59.94Hz	59.94Hz
	Not input	SD_REF_IN	Internal HD	Internal HD	SD_REF_IN	SD_REF_IN
		59.94Hz	Complies with menu item No.030 frequency	Complies with menu item No.030 frequency	59.94Hz	59.94Hz
None	Input	INPUT	INPUT	Internal HD	Internal SD	INPUT
		Complies with INPUT frequency	Complies with INPUT frequency	Complies with menu item No.030 frequency	59.94Hz	Complies with INPUT frequency
	Not input	Internal HD	Internal HD	Internal HD	Internal SD	Internal HD
		Complies with menu item No.030 frequency	Complies with menu item No.030 frequency	Complies with menu item No.030 frequency	59.94Hz	Complies with menu item No.030 frequency

*1 If "1394" or "INT SG (internal standard signal)" is selected for the video input signal, the video output reference signal will always be "Internal HD."

<Notes>

- When [E-AUTO] is selected in MENU No. 031 (OUT REF), the system operates when [INPUT] is selected in edit mode or when [AUTO] is selected in any mode other than edit mode.
- When using the SD → HD up-converter and HD → HD cross-converter, input the HD tri-level sync signal that supports the HD output format in order to initiate operation using HD_REF_IN.
- During SD tape playback, operation is not possible in the 60 Hz mode.
- When the HD SDI output signals are output at 60 Hz/24 Hz, the SD SDI signal is output in the NO SYNC status, and the analog composite signals are output in black-and-white mode (burst OFF).
- All the HD SDI output, SD SDI output, analog composite output, analog component output, audio output and TC output signals are output in phase with the REF input.

Function menus (continued)

<HOME> (continued)

In the 23.98 Hz/24 Hz mode

Input signals	Playback reference signal
REF_IN	
HD_REF_IN	HD_REF_IN
	Complies with HD_REF_IN frequency
None	Internal HD
	Complies with menu item No.030 frequency

In the 25 Hz (HD), 25 Hz (SD), 50 Hz (HD) or 50 Hz (SD) mode

Input signals	Menu item No.031				
	REF_IN	AUTO	INPUT	HD_REF	SD_REF
HD_REF_IN	HD_REF_IN	Internal HD	HD_REF_IN	Internal SD	HD_REF_IN
	Complies with HD_REF_IN frequency	50Hz	Complies with HD_REF_IN frequency	50Hz	Complies with HD_REF_IN frequency
SD_REF_IN	SD_REF_IN	Internal HD	Internal HD	SD_REF_IN	SD_REF_IN
	50Hz	50Hz	50Hz	50Hz	50Hz
None	Internal HD	Internal HD	Internal HD	Internal SD	Internal HD
	50Hz	50Hz	50Hz	50Hz	50Hz

<Notes>

In the 25 Hz (SD) or 50 Hz (SD) mode, black signals are output from the HD SDI output connectors.

Internal HD:

With HD tape playback as the reference, operation uses a 74 MHz clock signal in the free-run mode.

Internal SD:

With SD tape playback as the reference, operation uses a 4fsc clock signal in the free-run mode.

When "90H" is selected as the menu item No.26 HD SYS H ADV, the HD output is output with a phase 90H ahead of the SD output.

When the SD REF signal is input, the REF input and SD output signals are in-phase, and when the HD REF signal is input, the REF input and HD output signals are in-phase.

- The audio output and TC output signals are output in-phase with the HD output signals.
- With the 720p format, there is a phase difference of 120H.

Function menus (continued)

<HOME> (continued)

Registering TCG values

1 Selecting the values

Press the **[F3]** TC/CTL button to select TC.

Press the **[T]** button. The selected item (cue time or TC) is now highlighted.

Turn the ADJUST dial to select TC.

Again press the **[T]** button. A single digit is highlighted, and the mode for inputting numerical values is established.

<Notes>

- The UBG value and cue time can be registered in the same way. The CTL value cannot be registered.
- TC or UB can be registered only when the internal time code generator has been selected.

2 Inputting numbers and letters

Press the **[0]** to **[9]** number keys to input numerical values.

Use the **[F]** and **[7]** buttons to input A, B and C, and the **[F]** and **[8]** buttons to input D, E and F.

To move the input digit, turn the ADJUST dial.

To input a minus sign, press the **[F]** and TRIM- buttons when the left-most digit is highlighted.

To input a "plus" symbol, press **[F]** and the TRIM+ button or press **[0]** when the digit to the far left is inverted. (The display goes blank.)

To clear all the digits to zero, press the **[F]** and **[0]** buttons.

<Notes>

- Every time when the **[7]** button is pressed while pressing the **[F]** button, the display changes in the following sequence: A → B → C → A → B and so on.
The same applies when D, E and F are input using **[F]** and **[8]**.
- If, when "REV" has been selected as the setup menu item No.144 (TC INPUT) setting, the **[F]** button is released while a letter is being input, the displayed character will be entered.
- Letters can be input only while a UBG value is being registered.
- The input of a minus number is possible only while the cue time is being registered after "±12h" is selected as the setup menu No.002 (TAPE TIMER) setting and CTL is selected by the **[F3]** TC/CTL button.
- If "REV" has been selected as the setup menu item No.144 (TC INPUT) setting, the input starts from the highest order digit (the display appears from the far right). However, turning the ADJUST dial once will restore the NORMAL input mode.

3 Entering the input values

Press the **[ENT]** button. The value input is registered, and the normal display is restored.

<Notes>

- To cancel the registration, press the **[C]** button.
- If the input value is outside the registration enable range, the **[INVALID]** alarm blinks, and the value cannot be registered until it has been corrected.

Function menus (continued)

<HOME> (continued)

Function button/ item	Switching method	Setting	Corresponding setup menu item	Description of setting
F1 OUTPUT	Toggle	<u>TAPE</u> <u>EE</u>	No. 140 OUTPUT	For selecting the output signals. <In the STOP mode> TAPE: In the STOP mode, the signals played back from the tape are output. During recording or editing (*), simultaneous playback signals are output. *: Setup menu item No.302 (CONF EDIT) must be set. EE: The input signals selected by the setup menu items No.600 (VIDEO IN SEL) and No.713 (CH1 IN SEL) to No.724 (D IN SEL 78) settings are output.
F2 ---	---	---	---	---
F3 TC/CTL*2	Toggle	<u>TC</u> <u>UB</u> <u>CTL</u>	---	For selecting the time counter display. TC: The time code value is displayed. UB: The user bits value is displayed. CTL: The control signal (time data) is displayed.
F4 TC CLR*1	Press	<u>RESET</u>	---	For resetting the time counter display. If the [F4] button is pressed while the control signal (time data) is displayed on the time counter, it is reset to zero.
F5 CMP MD	F + toggle	<u>NORMAL</u> <u>DARK</u>	No. 689 COMP MODE	Refer to the SETUP menu. <Note> When the 23/24 Hz mode, 25 Hz (HD, SD) mode, or the 50 Hz (HD, SD) mode or the 50 Hz mode is selected in Setup Menu No. 25 (SYSTEM FREQ), this item is not displayed.
F6 R INH	F + toggle	<u>OFF</u> <u>ALL</u> <u>PRE</u> <u>NORM</u> <u>V/CTL</u>	No. 113 REC INH	Refer to the setup menu. <Note> The setting can be changed from OFF to ALL simply by operating the function button without pressing the [F] button.
F1(SHIFT) PREROL	Toggle + ADJ	<u>0s</u> --- <u>5s</u> --- <u>30s</u>	No. 000 P-ROLL TIME	Refer to the setup menu.
F2(SHIFT) ---	---	---	---	---
F3(SHIFT) OUTREF	F + toggle	<u>AUTO</u> <u>INPUT</u> <u>HD_REF</u> <u>SD_REF</u> <u>E-AUTO</u>	No. 031 OUT REF	Refer to the setup menu.
F4(SHIFT) CAPSTN	F + toggle	<u>2F</u> <u>4F</u>	No. 109 CAP. LOCK	Refer to the setup menu.
F5(SHIFT) ---	---	---	---	---
F6(SHIFT) VARMEM*1	Toggle	<u>OFF</u> <u>ON</u>	---	For selecting the variable memory mode. OFF: The variable memory mode is not used. ON: The status is established in which variable memory playback or variable memory editing is enabled.

*1 When the 23/24 Hz mode, 25 Hz (HD, SD) mode, or the 50 Hz (HD, SD) mode is selected in System Menu No. 25 (SYSTEM FREQ), this item is not displayed.

*2 When the 23/24 Hz mode, 25 Hz (HD, SD) mode, or the 50 Hz (HD, SD) mode is selected in System Menu No. 25 (SYSTEM FREQ), the CTL cannot be selected. The TC is selected when turning on the power.

The underlining () denotes the factory setting mode.

Function menus (continued)

<VIDEO>

The basic input/output settings for the video signals are set, and the level of the HD output signals can also be adjusted on these menu screens.

1. Video signal input switching, internal signal source type changing, and up-converter aspect ratio conversion

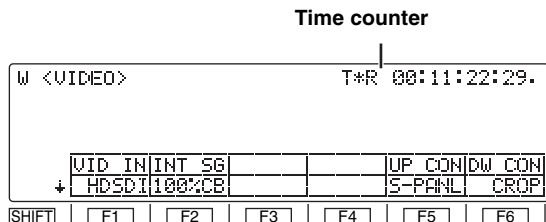

2. Video signal output level adjustments

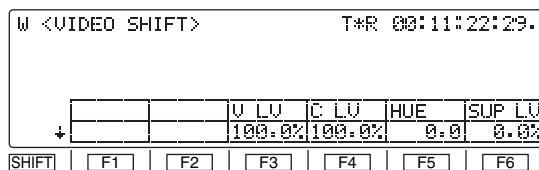

3. LCD monitor brightness and color adjustments

This display appears when the **F** + **SHIFT** are pressed. Refer to Setup Menu Nos. 670 to 673.

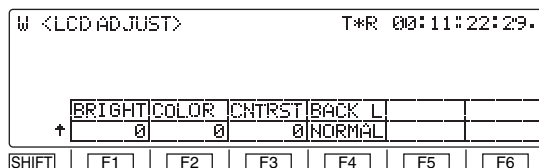

Function button/item	Switching method	Setting	Corresponding setup menu item	Description of setting
F1 VID IN	Toggle	INT SG HDSDI 1394 SDSDI	No. 600 VIDEO IN SEL	Refer to the setup menu.
F2 INT SG	Toggle	100%CB 75%CB SMPTE ARIB MB RAMP BLACK PLL EQ	No. 601 VIDEO INT SG	Refer to the setup menu.
F3	---	---	---	---
F4	---	---	---	---
F5 UP CON	Toggle	S-PANL CROP STRECH	No. 621 UPCONV MODE	Refer to the setup menu.
F6 DW CON	Toggle	CROP LT-BOX SQUEEZ 14:9 13:9	No. 620 DOWNCON MODE	Refer to the setup menu.

The underlining (___) denotes the factory setting mode.

Function menus (continued)

<VIDEO> (continued)

Function button/ item	Switching method	Setting	Corresponding setup menu item	Description of setting
When "CMPST" is selected as the setup menu item No.650 (STYLE) setting				
F1 (SHIFT) ---	---	---	---	---
F2 (SHIFT) ---	---	---	---	---
F3 (SHIFT) V LV	Toggle + ADJ	0.0% --- <u>100.0%</u> --200.0%	No. 662 V LEVEL	Refer to the setup menu. To return to the UNITY (100.0%) level, use [F] + Press.
F4 (SHIFT) C LV	Toggle + ADJ	0.0% --- <u>100.0%</u> --- 141.3%	No. 663 C LEVEL	Refer to the setup menu. To return to the UNITY (100.0%) level, use [F] + Press.
F5 (SHIFT) HUE (AJ-HD1800P) C PH (AJ-HD1800E)	Toggle + ADJ	-31.0 --- <u>0.0</u> --- +31.0	No. 664 HUE	Refer to the setup menu. To return to the UNITY (0.0) level, use [F] + Press.
F6 (SHIFT) SUP LV (AJ-HD1800P) BK LV (AJ-HD1800E)	Toggle + ADJ	-10.0% --- <u>0.0%</u> --- +10.0%	No. 665 SETUP LVL	Refer to the setup menu. To return to the UNITY (0.0%) level, use [F] + Press.
When "CMPNT" is selected as the setup menu item No.650 (STYLE) setting				
F1 (SHIFT) ---	---	---	---	---
F2 (SHIFT) ---	---	---	---	---
F3 (SHIFT) Y HD	Toggle + ADJ	0.0% --- <u>100.0%</u> ---141.3%	No. 653 Y LVL(HD)	Refer to the setup menu. To return to the UNITY (100.0%) level, use [F] + Press.
F4 (SHIFT) Pb HD	Toggle + ADJ	0.0% --- <u>100.0%</u> ---141.3%	No. 654 Pb LVL(HD)	Refer to the setup menu. To return to the UNITY (100.0%) level, use [F] + Press.
F5 (SHIFT) Pr HD	Toggle + ADJ	0.0% --- <u>100.0%</u> ---141.3%	No. 655 Pr LVL(HD)	Refer to the setup menu. To return to the UNITY (100.0%) level, use [F] + Press.
F6 (SHIFT) BK HD	Toggle + ADJ	-10.0% --- <u>0.0%</u> --- +10.0%	No. 656 BK LVL(HD)	Refer to the setup menu. To return to the UNITY (0.0%) level, use [F] + Press.

The underlining () denotes the factory setting mode.

Function menus (continued)

<AUDIO>

The basic input/output settings for the audio signals are set on these menu screens.

1. Audio signal input selection (CH1 - CH4)

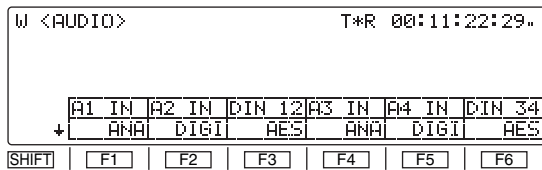

2. Audio signal input selection (CH5 - CH8)

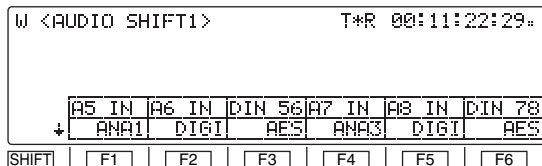

3. Audio volume control switching, CUE audio recording signal selection, and audio monitor mix switching

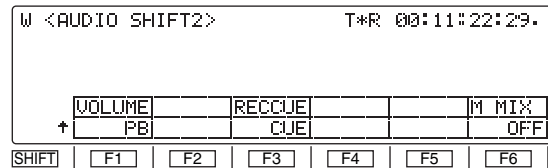

Function button/ item	Setting	Switching method	Corresponding setup menu item	Description of setting
F1 A1 IN*	Toggle	INT SG DIGI ANA	No. 713 CH1 IN SEL	Refer to the setup menu.
F2 A2 IN*	Toggle	INT SG DIGI ANA	No. 714 CH2 IN SEL	Refer to the setup menu.
F3 DIN 12	Toggle	AES SDI	No. 721 D IN SEL 12	Refer to the setup menu.
F4 A3 IN*	Toggle	INT SG DIGI ANA	No. 715 CH3 IN SEL	Refer to the setup menu.
F5 A4 IN*	Toggle	INT SG DIGI ANA	No. 716 CH4 IN SEL	Refer to the setup menu.
F6 DIN 34	Toggle	AES SDI	No. 722 D IN SEL 34	Refer to the setup menu.
F1(SHIFT1) A5 IN*	Toggle	INT SG DIGI ANA1	No. 717 CH5 IN SEL	Refer to the setup menu.
F2(SHIFT1) A6 IN*	Toggle	INT SG DIGI ANA2	No. 718 CH6 IN SEL	Refer to the setup menu.
F3(SHIFT1) DIN 56	Toggle	AES SDI	No. 723 D IN SEL 56	Refer to the setup menu.
F4(SHIFT1) A7 IN*	Toggle	INT SG DIGI ANA3	No. 719 CH7 IN SEL	Refer to the setup menu.
F5(SHIFT1) A8 IN*	Toggle	INT SG DIGI ANA4	No. 720 CH8 IN SEL	Refer to the setup menu.
F6(SHIFT1) DIN 78	Toggle	AES SDI	No. 724 D IN SEL 78	Refer to the setup menu.

* When the VIDEO input switch is set to 1394, all buttons from A1 IN to A8 IN become 1394 input.

The underlining () denotes the factory setting mode.

Function menus (continued)

<AUDIO> (continued)

Function button/ item	Switching method	Setting	Corresponding setup menu item	Description of setting
F1(SHIFT2) VOLUME	Toggle	<u>REC</u> PB <u>AUTO</u>	No. 141 VOLUME	Refer to the setup menu. For switching what is to be controlled by the audio volume controls. (The levels of all the CH1–CH8 channels are controlled.)
F2(SHIFT2) —	—	—	—	—
F3 (SHIFT2) RECCUE	Toggle	<u>CUE</u> CH1 CH2 CH3 CH4 CH5 CH6 CH7 CH8 CH1+2 CH3+4 CH5+6 CH7+8 CH1-8	No. 733 REC CUE	Refer to the setup menu. <Note> For 1394 input, audio is not recorded on the CUE track, and the sound is muted.
F4 (SHIFT2) —	—	—	—	—
F5 (SHIFT2) —	—	—	—	—
F6 (SHIFT2) M MIX	Toggle	<u>OFF</u> L R L/R	No. 737 MONI MIX	Refer to the setup menu.

The underlining () denotes the factory setting mode.

Function menus (continued)

<TC>

The TC-related settings are performed on these menu screens. Whether the TC is to be superimposed onto the display can also be set on this screen.

W <TC>						T*R 00:11:22:29.					
TC SRC	TCG MD	TCG RG	RUN MD	DF MOD							
+ INT	AUTO	TC&UB	REC	DF							
SHIFT	F1	F2	F3	F4	F5	F6					

W <TC SHIFT>						T*R 00:11:22:29.					
SUPER	C HPOS	C VPOS	DISPLY	C TYPE	TIMER						
+ ON	6	23	T&STA	WHITE	±12h						
SHIFT	F1	F2	F3	F4	F5	F6					

Function button/ item	Switching method	Setting	Corresponding setup menu item	Description of setting
F1 TC SRC	Toggle	When HD SDI, INT SG or 1394 is selected: INT EXT_L SLTC SVITC When SD SDI is selected: INT EXT_L VITC	No. 507 TC SOURCE	Refer to the setup menu.
F2	---	---	---	---
F3 TCG MD	Toggle	REGEN PRE AUTO	No. 503 TCG MODE	Refer to the setup menu.
F4 TCG RG	Toggle	TC&UB TC UB	No. 505 TCG REGEN	Refer to the setup menu.
F5 RUN MD	Toggle	REC FREE	No. 504 RUN MODE	Refer to the setup menu.
F6 DF MOD	F + toggle	DF NDF	No. 511 DF MODE	Refer to the setup menu.
F1 (SHIFT) SUPER	Toggle	OFF ON	No. 005 SUPER	Refer to the setup menu.
F2 (SHIFT) C HPOS	Toggle + ADJ	0 --- <u>6</u> --- 37	No. 007 CHARA H-POS	Refer to the setup menu.
F3 (SHIFT) C VPOS	Toggle + ADJ	0 --- <u>23</u> --- 32	No. 008 CHARA V-POS	Refer to the setup menu.
F4 (SHIFT) DISPLY	Toggle	TIME T&STA T&S&M T&RT T&YMD T&MDY T&DMY T&UB T&CLT T&T	No. 006 DISPLAY SEL	Refer to the setup menu.
F5 (SHIFT) C TYPE	Toggle	WHITE W/OUT	No. 009 CHARA TYPE	Refer to the setup menu.
F6 (SHIFT) TIMER	Toggle	±12h 24h	No. 002 TAPE TIMER	Refer to the setup menu.

The underlining () denotes the factory setting mode.

Function menus (continued)

<CUE>

A maximum of 60 cue points can be set on these menu screens. When "AUTO" has been selected as the **[F3]** (PAGE) setting on the AUTO PAGE mode <CUE SHIFT> menu, up to 10 pages of cue points with 6 cue points on each page can be managed on a page-by-page basis. The 60 cue points are indicated using the page number display and registered point display areas.

<Note>

Cue points cannot be registered, prerolled, etc. if a setting other than "ENA" has been selected as the setup menu item No.001 (LOCAL ENA) setting in the REMOTE mode.

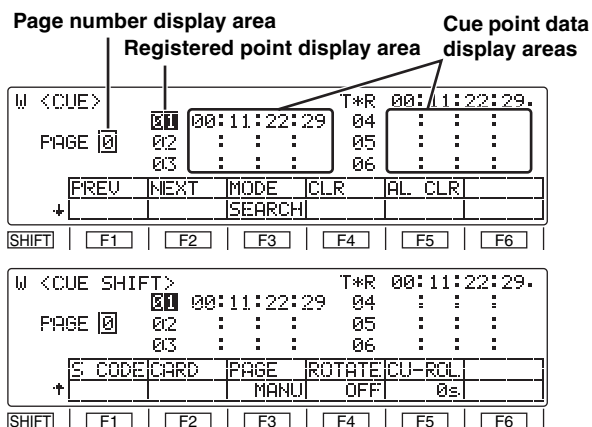

Page number display area

The page number from 0 to 9 is indicated here.

Registered point display area

On each page, six cue point data managed by registered point numbers are displayed. A point whose registered point number is highlighted is targeted for registration and search. Shown below is the correlation between the page numbers and registered point numbers.

Page no.	Registered points	Page no.	Registered points
0	01-06	5	51-56
1	11-16	6	61-66
2	21-26	7	71-76
3	31-36	8	81-86
4	41-46	9	91-96

Page operations

Pages can be scrolled in the forward or reverse direction using the **[F1]** (PREV) or **[F2]** (NEXT) function buttons.

- Depending on the setting selected for **[F4]** (ROTATE) on the <CUE SHIFT> menu, the following applies to scrolling pages in the forward direction.

When "OFF" is set:

Page 0 cannot be scrolled forward from page 9.

When "ON" is set:

Page 0 can be scrolled forward from page 9.

- In scrolling pages in the reverse direction, page 9 cannot be scrolled in reverse from page 0.

Moving to registered points

The highlighting on the registered point display area is moved by turning the ADJUST dial. It is moved in the ascending order of points when the dial is turned clockwise and in the descending order of points when it is turned counterclockwise. When "AUTO" has been selected as the **[F3]** (PAGE) setting on the <CUE SHIFT> menu, the highlighting can be moved also to the previous or next page.

- Depending on the setting selected for **[F4]** (ROTATE) on the <CUE SHIFT> menu, the following applies to moving the highlighting in the ascending order of points.

When "OFF" is set:

The highlighting cannot be moved from page 9 to page 0.

When "ON" is set:

The highlighting can be moved from page 9 to page 0.

- In moving in the descending order of points, the highlighting cannot be moved from page 0 to page 9.

Search point and registered point operations

Each time the **[F3]** (MODE) button of the <CUE> menu is pressed, the search mode and cue point registration mode are switched alternately. Perform the search point or registered point operations in the respective mode.

- When the power is turned on, the search point or registered point, whichever was established when the power was last turned off, is established.
- When the setting for **[F3]** (PAGE) or **[F4]** (ROTATE) on the <CUE SHIFT> menu has been changed, "01" (page 0/point no.1) is set for both the search and registered points.

Cue point registration mode

It is possible to register points to which the tape is to be prerolled. When the display page has been changed using the **[F1]** (PREV) or **[F2]** (NEXT) button on the <CUE> menu, the following applies depending on the setting for **[F3]** (PAGE) on the <CUE SHIFT> menu.

When "MANU" is set:

Both the search and registered points move to the top of the changed page.

When "AUTO" is set:

Only the registered point moves to the top of the changed page; the search point does not move.

Search mode

The desired search point can be selected, and the tape can be prerolled to that point.

When the display page has been changed using the **[F1]** (PREV) or **[F2]** (NEXT) button on the <CUE> menu, the following applies depending on the setting for **[F3]** (PAGE) on the <CUE SHIFT> menu.

When "MANU" is set:

Both the search and registered points move to the top of the changed page.

When "AUTO" is set:

Only the search point moves to the top of the changed page; the registered point does not move.

<CUE> (continued)

Cue point registration

Turn the ADJUST dial to highlight the point which is to be registered. When the **[SET]** button is pressed, the current tape position is registered as the cue point. The following applies depending on the setting for **[F3]** (PAGE) on the <CUE SHIFT> menu.

When "MANU" is set:

Operations are performed on the selected page. Press the **[SET]** button to register the points in succession (CUE*1 → CUE*2 → ... → CUE*6) on the selected page. (Any points already registered will be overwritten.)

The registration is automatically terminated when CUE*6 is registered on the page. (*1)

A change must be made to the points to be registered if more cue points are to be registered. Check that the cue point registration mode is established, change the page, and change the points to be registered. In this case, the search point will also move automatically to the top (CUE*1) of the changed page.

*1 If "ON" is selected as the **[F4]** (ROTATE) setting on the <CUE SHIFT> menu, the registration of the cue points will rotate on the same page in the following order: CUE*1 → CUE*2 → ... → CUE*6 → CUE*1 → CUE*2 → ...

When "AUTO" is set:

When a page become full during the cue point registration process, operation automatically moves to the next page, and registration continues. When CUE96 on the last page is reached, registration is automatically terminated. (*2)

A change must be made to the points to be registered if more cue points are to be registered. Check that the cue point registration mode is established, change the page, and change the points to be registered. In this case, the search point will not be changed.

*2 If "ON" is selected as the **[F4]** (ROTATE) setting on the <CUE SHIFT> menu, the registration of the cue points will rotate from page 9 (CUE96) to page 0 (CUE01).

When registering cue points by number

1. Turn the ADJUST dial to highlight the desired registered point display area
2. Press the **[T]** button twice. Only the "10's" hour digit of the selected cue point is now highlighted, and the change enable status is established.

<Note>

When "REV" has been selected as the setup menu item No.144 (TC INPUT) setting, the input of the number will start from the higher-order digit (it will be displayed starting from the far right).

3. Input the number using the number keys. Movement from one digit to the next is done automatically after one number has been input. The desired digit can also be selected by turning the ADJUST dial.
4. To enter the number, press the **[ENT]** button. When the display screen is switched or when the **[C]** button is pressed during the input process, the change enable status is released, and the setting is canceled.

Clearing registered points

Clearing all the registered points together

When **[F5]** (AL CLR) on the <CUE> menu is pressed while the **[F]** button is held down, all the cue point data currently selected is cleared. The range of the points which are cleared is as follows depending on the setting for **[F3]** (PAGE) on the <CUE SHIFT> menu.

When "MANU" is set:

All the points on the currently selected page are cleared.

When "AUTO" is set:

All the points on all the pages are cleared.

After clearing, the search and registered points appear as follows depending on the setting for **[F3]** (PAGE) on the <CUE SHIFT> menu.

When "MANU" is set:

A return is made to the top (CUE*1) of the page concerned

When "AUTO" is set:

A return is made automatically to the top (CUE01) of the first page.

- * Points are cleared whether "ENTRY" (cue point registration mode) or "SEARCH" (search mode) is selected as the setting for **[F3]** (MODE) on the <CUE> menu.

Clearing individual registered points

When the **[F4]** (CLR) button on the <CUE> menu is pressed, the currently selected cue point data is cleared.

- * The point is cleared only when "ENTRY" (cue point registration mode) is selected as the setting for **[F3]** (MODE) on the <CUE> menu.

Function menus (continued)

<CUE> (continued)

Search operations

Turn the ADJUST dial to highlight the desired registered point.

When the PREROLL button is pressed, the preroll operation is initiated. The tape will not be prerolled if no cue points have been registered.

Since the tape is not prerolled even if the PREROLL button is pressed when the cue point registration mode is established, be absolutely sure to check that the search mode is established.

[The time selected by the <CUE SHIFT> menu **F5** (CU-ROL) setting, which is different from the normal preroll time, takes effect as the preroll time in this mode.]

Function button/ item	Switching method	Setting	Corresponding setup menu item	Description of setting
F1 PREV	Press	—	—	For multi-cue page forward scrolling.
F2 NEXT	Press	—	—	For multi-cue page forward scrolling.
F3 MODE	Toggle	<u>SEARCH</u> <u>ENTRY</u>	—	For selecting the search or cue point registration mode.
F4 CLR	Press	—	—	For clearing the currently selected cue data. ENTRY must be selected as the F3 (MODE) setting.
F5 AL CLR	F+Press	—	—	When MANU is selected by SHIFT + F3 (PAGE): All the cue data on the currently displayed page is cleared. When AUTO is selected by SHIFT + F3 (PAGE): All the cue data on all the pages is cleared.
F6	—	—	—	—
F1 (SHIFT)	—	—	—	—
F2 (SHIFT) CARD	F+Press	—	—	For calling the MULTI CUE file operation menu.
F3 (SHIFT) PAGE	Toggle	<u>MANU</u> <u>AUTO</u>	No. 131 PAGE MODE	Refer to the setup menu.
F4 (SHIFT) ROTATE	Toggle	<u>OFF</u> <u>ON</u>	No. 132 ROTA MODE	Refer to the setup menu.
F5 (SHIFT) CU-ROL	Toggle + ADJ	<u>0s</u> --- 5s --- 15s	No. 011 CU-ROLL TIME	Refer to the setup menu.
F6(SHIFT)	—	—	—	—

The underlining () denotes the factory setting mode.

Function menus (continued)

<DIAG>

This enables confirmation of information such as the warning/hour-meter/UMID.

Verification, deletion of the error log file, retention/call to the SD memory card can do with the SHIFT picture.

Warning mark

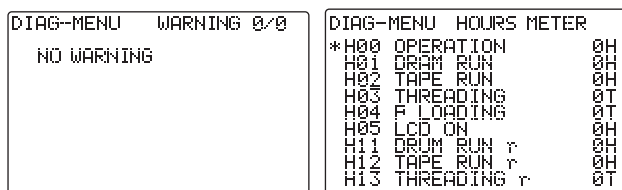
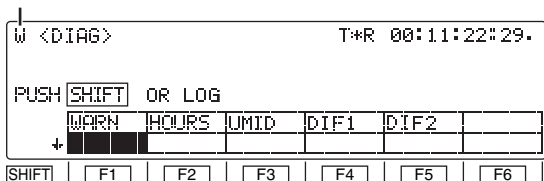

Warning display

When a warning occurs in this VTR, the warning mark (W) blinks at the top left of the screen. If [F1] (WARN) is now pressed, the details of the warning can be checked out on the LCD monitor.

When more than one warning has occurred, turn the ADJ dial to scroll through the messages.

Hour-meter display

When [F2] (HOURS) is pressed, the hour-meter information can be checked out on the LCD monitor.

UMID display

Press [F2] (UMID) to confirm the current UMID information for the image on the LCD monitor.

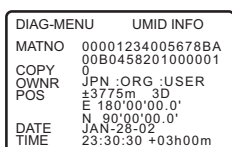

DIF Status display

Press [F4] (DIF1) or [F5] (DIF2) to display the different kinds of information about the current DIF (IEEE 1394 interface).

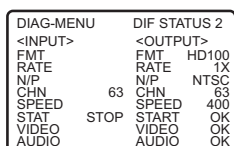
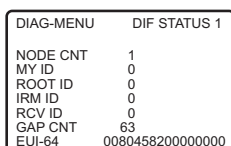

Error log function

The error log mode can be selected by pressing the [SHIFT] button and switching the screen to <DIAG SHIFT>.

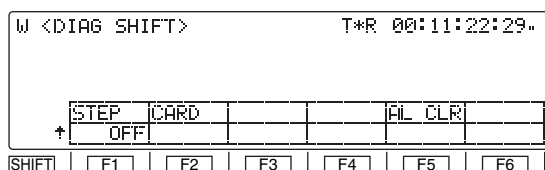

General description

When the following warnings have occurred while the tape is running, the warning messages, time codes and operating modes are saved, and a list of this information can be read out on the LCD monitor. Up to 99 warnings which have occurred can be saved. If the storage capacity of 99 warnings is exceeded, the processing that is conducted as a result is based on the setup menu item No.015 (AUTO STEP) setting.

Warning messages which are saved	Description (Refer to page 129 and following.)
NO RF	A blank section on the tape lasting more than 1 second has been detected. (During normal playback)
SV NOT LOCKED	The servo has been disengaged for more than 3 seconds. (During recording, normal playback or editing)
LOW RF	An envelope level which is about 1/3 of normal or a CTL level which is about 1/6 of normal has been detected for more than 1 second. (During recording, normal playback or editing)
HIGH ERROR RATE	The error rate has deteriorated, and correction or compensation has been applied to the video or audio playback signals. (During normal playback)

LCD monitor displays

Operation mode display

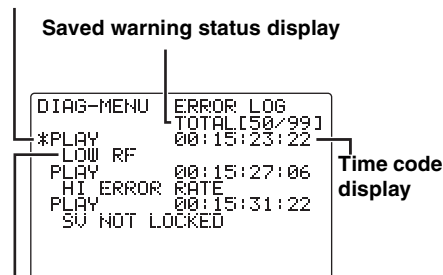

Warning display

Operation mode display

This indicates the operation mode at the point when the warning was saved.

Warning display

This indicates the warning message which is saved.

Saved warning status display

This indicates the number of the currently displayed warning which has been saved and the total number of warnings which have been saved.

Time code display

This indicates the time code at the point when the warning was saved.

Cueing up the tape to the warning point

The warning list displayed on the LCD monitor can be scrolled by turning the ADJ dial. When the warning occurrence point to be checked is selected and the PREROLL button is pressed, the tape is cued up to the position of the time code which has been saved.

Function menus (continued)

<DIAG> (continued)

Function button/ item	Switching method	Setting	Corresponding setup menu item	Description of setting
F1 WARN	—	—	—	For displaying the warning messages on the LCD monitor.
F2 HOURS	—	—	—	For displaying the hour-meter on the LCD monitor.
F3 UMID	—	—	—	The UMID information is displayed on the LCD monitor.
F4 DIF1	—	—	—	The DIF status 1 is displayed on the LCD monitor.
F5 DIF2	—	—	—	The DIF status 2 is displayed on the LCD monitor.
F6 —	—	—	—	—
F1 (SHIFT) STEP	Toggle	<u>OFF</u> ON	No. 015 AUTO STEP	Refer to the setup menu.
F2 (SHIFT) CARD	F+Press	—	—	For calling the error log file operation menu.
F3 (SHIFT) —	—	—	—	—
F4 (SHIFT) —	—	—	—	—
F5 (SHIFT) AL CLR	F+Press	—	—	For clearing error log files.
F6 (SHIFT) —	—	—	—	—

The underlining () denotes the factory setting mode.

Concerning the setup menu item No.015 (AUTO STEP) setting (factory setting: OFF)

Up to 99 warning messages can be saved by the error log function, and this setup menu item determines what kind of save processing is to be conducted when this storage capacity is exceeded.

OFF: 99 messages are set as the upper limit, and no further messages of warnings that occur will be saved.

ON: 99 messages are saved, and any further message of a warnings that occurs is saved in No.99. The warning messages already saved are each shifted down by one number in succession.

Messages saved when ON is selected as the setting

No. in which message is saved	Saved warning		No. in which message is saved	Saved warning
1/99	Warning 1	→	1/99	Warning 2
2/99	Warning 2		2/99	Warning 3
:	:		:	:
:	:		:	:
99/99	Warning 99		99/99	Warning 100

When up to 99 messages have been saved and the 100th warning has occurred

Function menus (continued)

<MENU>

These enable movement to the menu screens for operations (adjustments, saving data onto or loading it from the internal memory or SD memory cards) relating to the SYSTEM and SETUP menus.

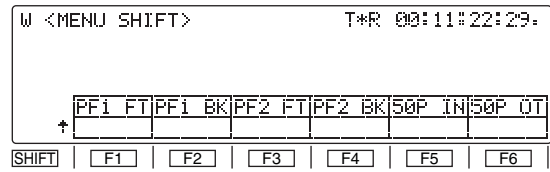
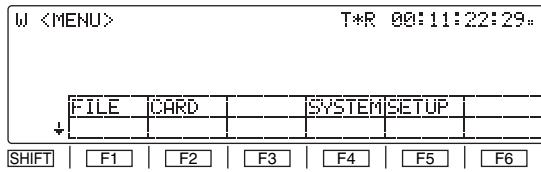

Function button/ item	Switching method	Setting	Corresponding setup menu item	Description of setting
F1 FILE	F+Press	—	—	For calling the operation menu for saving the SYSTEM and SETUP adjustment values (in the internal memory).
F2 CARD	F+Press	—	—	For calling the operation menu for saving the SYSTEM and SETUP adjustment values (onto the SD memory card).
F3 —	—	—	—	—
F4 SYSTEM	F+Press	—	—	For calling the SYSTEM adjustment operation menu.
F5 SETUP	F+Press	—	—	For calling the SETUP adjustment operation menu.
F6 —	—	—	—	—
F1 (SHIFT) PF1 FT	F+Press	—	—	For calling the PF1/function button assignment operation menu.
F2 (SHIFT) PF1 BK	F+Press	—	—	For calling the PF1/function button assignment operation menu.
F3 (SHIFT) PF2 FT	F+Press	—	—	For calling the PF2/function button assignment operation menu.
F4 (SHIFT) PF2 BK	F+Press	—	—	For calling the PF2/function button assignment operation menu.
F5 (SHIFT) 50P IN	F+Press	—	—	For calling the 50-pin (input pin) assignment operation menu.
F6 (SHIFT) 50P OT	F+Press	—	—	For calling the 50-pin (output pin) assignment operation menu.

*The underlining (—) denotes the factory setting mode.

Function menus (continued)

<ASSEMBLE>

The ASSEMBLE editing mode is selected on this menu screen.

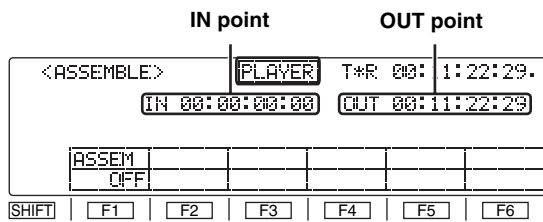

Automatic editing and manual editing

- When the editing mode has been selected (the **ASSEM** button is lighted), automatic editing or manual editing can be performed even after the ASSEMBLE screen has been exited.
- After the edit IN and OUT points have been registered (the **IN** and **OUT** buttons are lighted), the tape can be prerolled to an IN point or cued up to an IN or OUT point even after the ASSEMBLE screen has been exited.

Function button/ item	Switching method	Setting	Corresponding setup menu item	Description of setting
F1 ASSEM	Toggle	OFF ON	—	For setting the editing mode to ON or OFF. When the display is highlighted, the ASSEMBLE editing mode is set to ON, and the ASSEM button lights.
F2	—	—	—	—
F3	—	—	—	—
F4	—	—	—	—
F5	—	—	—	—
F6	—	—	—	—

The underlining (—) denotes the factory setting mode.

Function menus (continued)

<INSERT>

The INSERT editing mode and editing channels are selected on this menu screen.

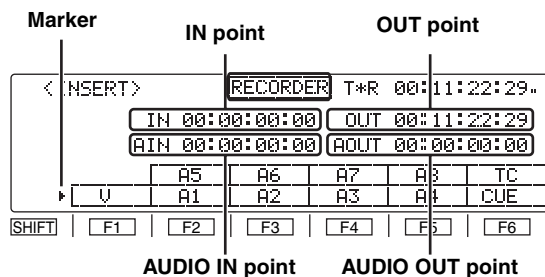

Registering the edit points

After the edit IN and OUT points have been registered, the **IN** and **OUT** buttons light.

Automatic editing and manual editing

- When the editing mode has been selected (the **INSERT** button is lighted), automatic editing or manual editing can be performed even after the INSERT screen has been exited.
- After the edit IN and OUT points have been registered (the **IN** and **OUT** buttons are lighted), the tape can be prerolled to an IN point or cued up to an IN or OUT point even after the INSERT screen has been exited.

Function button/item	Switching method	Setting	Corresponding setup menu item	Description of setting
F1 V	Toggle	—	—	<p>For setting the editing mode to ON or OFF and selecting the editing channels. With the exception of the function button (F1), two channels are allocated.</p> <p>Use the SHIFT button to move the marker up or down, and while specifying the channels, press the function buttons to select them. Pressing the SHIFT button on other screens serves a different purpose (screen switching) from its use here.</p> <p>For setting the editing mode to ON or OFF. When one of the channel displays is highlighted, the INSERT editing mode is set to ON, and the INSERT button lights.</p>
F2 A5, A1				
F3 A6, A2				
F4 A7, A3				
F5 A8, A4				
F6 TC, CUE				

Function menus (continued)

<SETUP MENU/SYSTEM MENU>

When the SETUP MENU or SYSTEM MENU operation menu is selected, a menu list appears on the monitor, and the respective items can be set.

SETUP menu

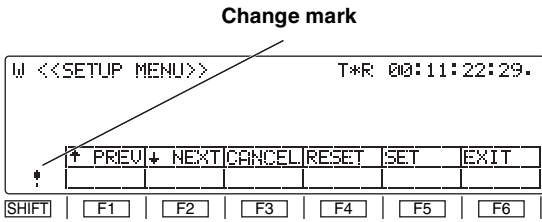

SYSTEM menu

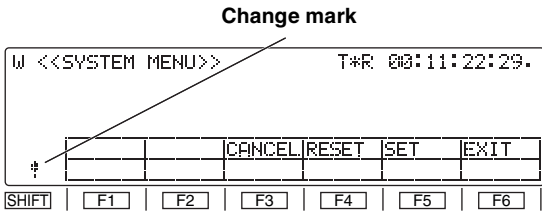

Monitor display menu

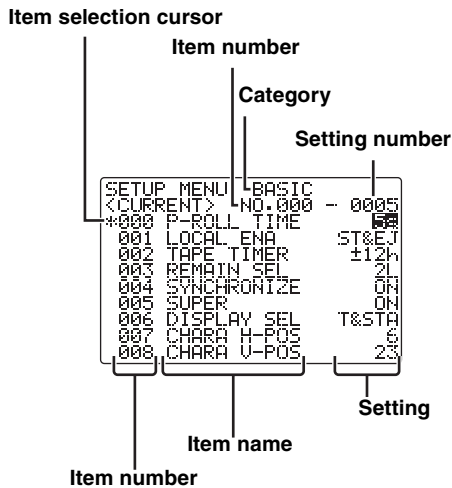

Settings

1 Selecting the menu items

Select the menu item by turning the ADJ dial. (The cursor is moved down when the dial is turned clockwise and up when it is turned counter-clockwise.)

- Forward or reverse page scrolling (SETUP menu only)
The menu list is organized by category, and the pages can be scrolled in the forward or reverse direction on a category by category basis.

F1 (↑ PREV) / **F2** (↓ NEXT)

<Note>

The screen may continue to scroll for a few moments after the ADJ dial has been turned.

2 Changing the settings

1. In the menu item selection status, press the ADJ dial.
At this time, the setting of the menu item indicated by the menu item selection cursor blinks on the monitor
2. Turn the ADJ dial to select the setting. (Turn it clockwise to move up through the settings and counterclockwise to move down through the settings.)
When the ADJ dial is pressed again, the menu item selection status is restored.

<Notes>

- Setting items which have submenus
A submenu is opened by pressing the **SHIFT** button. The same operations as the ones described above are then used to change the settings.
- Canceling individual items
When **F3** (CANCEL) is pressed, the setting operation is canceled, and the item selection status is restored.

3 Entering settings (After a setting has been entered, the menu operation is forcibly exited.)

Press **F5** (SET) to enter a setting.

4 Exiting the menu operation

When the **F6** (EXIT) button is pressed in the menu item selection status, the menu operation is exited, and the original operation screen is restored.

However, if the **F6** (EXIT) button is pressed after a setting has been changed without that setting having been entered, a confirmation message will be displayed.

Confirmation message

Confirmation item	Description of setting
EXIT confirmation	EXIT?
When an attempt has been made to exit the menu operation after a setting has been changed without that setting having been entered	F3:CANCEL F5:SET(and EXIT) F6:EXIT(without SET)

<Note>

The "!" mark appears at the bottom left of the screen when a setting has been changed.

Function menus (continued)

<SETUP MENU/SYSTEM MENU> (continued)

Flow of setting changes

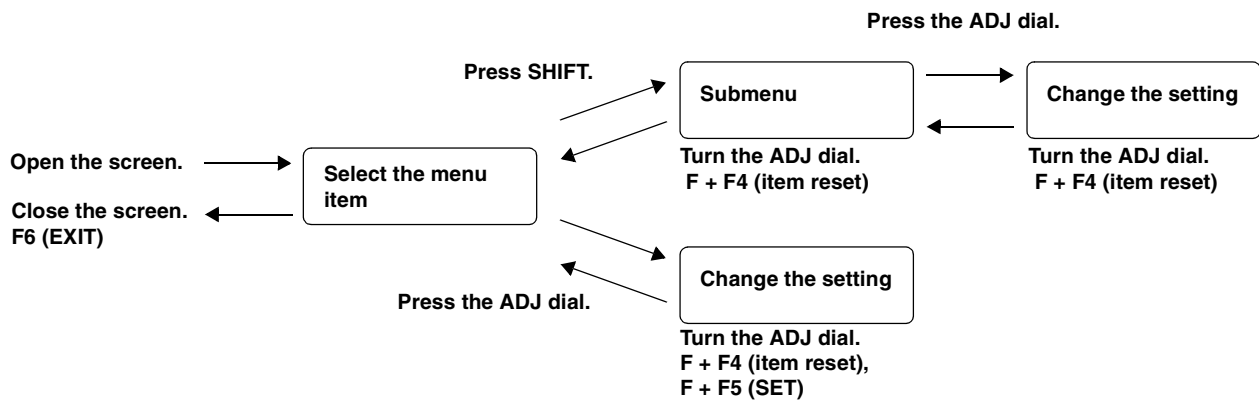

SETUP MENU function buttons

Function button/ item	Switching method	Setting	Corresponding setup menu item	Description of setting
F1 ↑ PREV	Press	—	—	For scrolling the on-screen menu pages in the reverse direction.
F2 ↓ NEXT	Press	—	—	For scrolling the on-screen menu pages in the forward direction.
F3 CANCEL	Press	—	—	—
F4 RESET	Press	—	—	For resetting an item (while a setting is being changed).
F5 SET	Press	—	—	For entering what has been set.
F6 EXIT	Press	—	—	For exiting the special menu (and transferring to the original menu). (Confirmation message provided)
F1 (SHIFT) F2 (SHIFT) F3 (SHIFT) F4 (SHIFT) F5 (SHIFT) F6 (SHIFT) —	—	—	—	—

SYSTEM MENU function buttons

Function button/ item	Switching method	Setting	Corresponding setup menu item	Description of setting
F1 F2 —	—	—	—	—
F3 CANCEL	Press	—	—	—
F4 RESET	Press	—	—	For resetting an item (while a setting is being changed).
F5 SET	Press	—	—	For entering what has been set.
F6 EXIT	Press	—	—	For exiting the special menu (and transferring to the original menu). (Confirmation message provided)
F1 (SHIFT) F2 (SHIFT) F3 (SHIFT) F4 (SHIFT) F5 (SHIFT) F6 (SHIFT) —	—	—	—	—

Function menus (continued)

<FILE>

The current setting information, including the SETUP menu contents, can be provided with titles and either saved in or loaded from the backup memory in one of 4 variations.

When **[F1]** (FILE) is pressed while the **[F]** button is held down on the <MENU> screen, the following function menu is displayed.

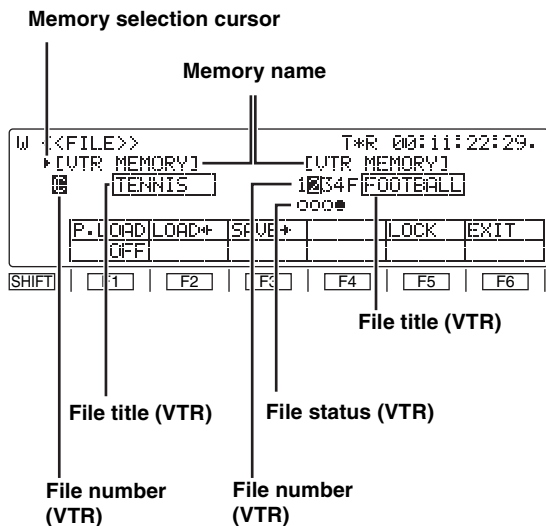

- This VTR comes with VTR MEMORY **[C]** for storing the current settings (*) and VTR MEMORY **[1]** to **[4]** for storing these settings as a backup.
- Each VTR MEMORY can be provided with a title.
- Data can be saved and loaded and titles can be copied between VTR MEMORY **[C]** and VTR MEMORY **[1]** to **[4]**.
- The file locking facility for preventing data from being overwritten can be engaged for VTR MEMORY **[1]** to **[4]**.

* The term "settings" used here refers to all the settings on the setup menus excluding the SYSTEM menu, what has been registered in the PF1 and PF2 menu items, and the contents of some of the function buttons.

Name of memory area	Initial title (up to 8 characters)
VTR MEMORY C	CURRENT
VTR MEMORY 1	USER1
VTR MEMORY 2	USER2
VTR MEMORY 3	USER3
VTR MEMORY 4	USER4

Settings

1 Selecting the memory target

Press the **[SHIFT]** button.

The operation target switches alternately between VTR MEMORY **[C]** and VTR MEMORY **[1]** to **[4]**.

2 Selecting the operation file in the selected memory

The number of the currently selected file is highlighted on the display. When the ADJ dial is turned, the highlighting moves to the left or right, enabling operation files to be selected.

3 Transferring files between memories

After selecting the operation file, press **[F2]** (LOAD).

The contents of files selected in VTR MEMORY **[1]** to **[4]** can be transferred to VTR MEMORY **[C]**.

When **[F]** is selected and **[F2]** (LOAD) is pressed, the factory setting mode is established.

Alternatively, when **[F3]** (SAVE) is pressed, the contents of a file in VTR MEMORY **[C]** can be transferred to a file selected in VTR MEMORY **[1]** to **[4]**.

(The titles are also transferred at the same time.)

4 Editing the title of the selected file

Press the ADJ dial after selecting the operation file.

The first digit of the title display area is highlighted, and the file title can be edited.

- To input a number, press the number keys.
- To input letters, tap the numbers keys until the letter to be input appears while holding down the **[F]** button.
- More than one letter is allocated to each number key.
- Turn the ADJ dial to move from one digit to the next in the title display area.
- To enter the title, press the ADJ dial again.

<Notes>

- When the display screen has been switched or the **[C]** button has been pressed during title editing, the editing enable status is canceled, and the setting becomes invalid.
- A space can be input by pressing the **[F]** button and **[3]** button.

Function menus (continued)

Settings

5 File overwrite inhibit facility

It is possible to lock the overwrite inhibit facility for individual files in VTR MEMORY 1 to 4. Select the file to be locked, and press F5 (LOCK) to lock it.

If F5 (LOCK) is pressed again, the facility is unlocked.

The locked or unlocked mode is displayed in the file status.

[○: Unlocked status, ●: locked status]

Function button/ item	Switching method	Setting	Corresponding setup menu item	Description of setting
F1 P. LOAD	Press	OFF USER1 USER2 USER3 USER4	A02 P.ON LOAD	Refer to the setup menu.
F2 LOAD←	Press	—	—	For downloading data to the current file.
F3 SAVE→	Press	—	—	For downloading data to the backup file.
F4 —	—	—	—	—
F5 LOCK	Press	—	—	For locking the backup file.
F6 EXIT	—	—	—	—
F1 (SHIFT) F2 (SHIFT) F3 (SHIFT) F4 (SHIFT) F5 (SHIFT) F6 (SHIFT) —	—	—	—	—

The underlining (—) denotes the factory setting mode.

Function menus (continued)

<PF1/PF2>

Up to 24 frequently used setup menu items can be registered. The items are registered on the function menus shown below. (No settings have been registered before the VTR leaves the factory.)

To display one of the function menus, press **[F1]** (PF1 FT), **[F2]** (PF1 BK), **[F3]** (PF2 FT) or **[F4]** (PF2 BK) while holding down the **[F]** button on the <MENU SHIFT> screen.

Selection marker

Registered menu number	Menu name				
<<PF1>>	REGISTER	T*#R	00:11:22:29.		
F1 023	FORMAT SEL	F4	:		
F2	:	F5	:		
F3 000	P-ROLL TIME	F6	:		
↑ PREV NEXT CANCEL RESET SET EXIT					
SHIFT	F1	F2	F3	F4	F5 F6

Item selection cursor

Item number	Category	Setting number
PF-ASSIGN	BASIC	
<PF1 FT>	NO.000	-- 0005
*000	P-ROLL TIME	5
001	LOCAL ENA	ST&EJ
002	TAPE TIMER	+12h
003	REMAIN SEL	ZL
004	SYNCHRONIZE	ON
005	SUPER	ON
006	DISPLAY SEL	T&STA
007	CHARA H-POS	6
008	CHARA U-POS	Z3

Registration

1 Selecting the function buttons

Turn the ADJ dial to move the selection marker, and select one of the function buttons **[F1]** to **[F6]** into which the menu items are to be registered.

2 Entering the function button

Press the ADJ dial.

The display of the function button entered is highlighted.

3 Selecting menu items

Turn the ADJ dial, and select the menu item for the function button which was selected in step **1** above.

4 Entering the menu items.

Press the ADJ dial.

The target of the ADJ dial operation returns to the front panel. Whatever was selected in step **3** above is displayed for the registered menu number and name.

5 To select a menu item for another function button, repeat steps **1** to **4** above.

6 Saving the settings in a PF registration file

To save what has been set in the function buttons in a PF registration file, press **[F5]** (SET).

If **[F6]** (EXIT) is pressed without the settings having been saved, the settings will be canceled.

When menu items are registered, they can be called simply by pressing the PF1 or PF2 direct menu button.

When [PF1] is pressed :

<PF1 FT>

When [PF1] is pressed after pressing [SHIFT] :

<PF1 BK>

When [PF2] is pressed :

<PF2 FT>

When [PF2] is pressed after pressing [SHIFT] :

<PF2 BK>

Clearing the menu items

1 Turn the ADJ dial to move the selection marker, and select one of the function buttons **[F1]** to **[F6]** whose menu items are to be cleared.

2 Press **[F4]** (RESET). The registered menu number and name displays will now go blank. To clear the menu items from other function buttons, repeat steps 1 and 2 above.

3 To save what has been set in the function buttons in a PF registration file, press **[F5]** (SET).

4 If **[F6]** (EXIT) is pressed without the settings having been saved, the above settings will be canceled.

Clearing all the function button settings

Press **[F4]** (RESET) while holding down the **[F]** button. All the registered menu number and name displays will now go blank.

All the contents of the PF registration file are cleared. (They cannot be restored.)

Function menus (continued)

<PF1/PF2> (continued)

Flow of function button registration

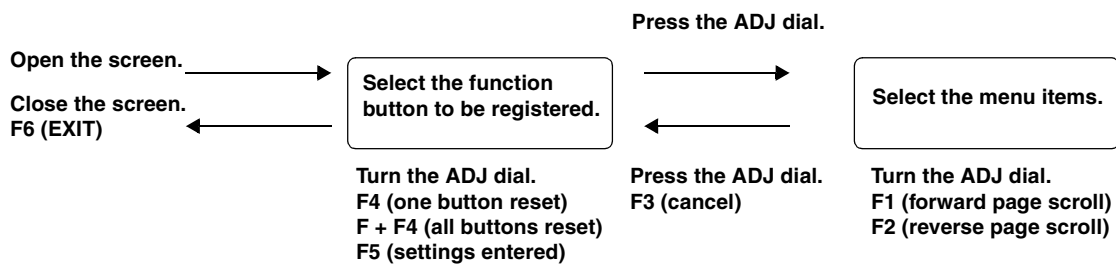

PF1/PF2 function buttons

Function button/item	Switching method	Setting	Corresponding setup menu item	Description of setting
F1 ↑ PREV	Press	---	---	For scrolling the on-screen menu pages in the reverse direction.
F2 ↓ NEXT	Press	---	---	For scrolling the on-screen menu pages in the forward direction.
F3 CANCEL	Press	---	---	For releasing the menu item selection status.
F4 RESET	Press	---	---	For clearing one button: what has been selected for the pin by the individual reset selection marker is cleared.
	F+Press			For clearing all the buttons: what has been registered in all the pins is deleted from the PF registration files.
F5 SET	Press	---	---	For entering the settings. (No confirmation message provided)
F6 EXIT	Press	---	---	For exiting the special menu (and transferring to the original menu). (Confirmation message provided)
F1 (SHIFT) F2 (SHIFT) F3 (SHIFT) F4 (SHIFT) F5 (SHIFT) F6 (SHIFT) ---	---	---	---	---

Function menus (continued)

<PF1/PF2> (continued)

PF1/PF2 function button names

When SETUP menu items have been registered in the function buttons, the names of these function buttons are displayed as set forth in the table below.

Setup menu item No.	Name of setup menu item	Function button name
000	P-ROLL TIME	PREROL
001	LOCAL ENA	L ENA
002	TAPE TIMER	TIMER
003	REMAIN SEL	REMAIN
004	SYNCHRONIZE	SYNCR
005	SUPER	SUPER
006	DISPLAY SEL	DISPLY
007	CHARA H-POS	C HPOS
008	CHARA V-POS	C VPOS
009	CHARA TYPE	C TYPE
010	MONI CONTROL	MONI C
011	CU-ROLL TIME	CU-ROL
015	AUTO STEP	STEP
020	SYS FORMAT	SYS FT
022	PB FORMAT	PB FT
023	FORMAT SEL	FMT SL
030	HD FREQUENCY	HD FRQ
031	OUT REF	OUTREF
100	SEARCH ENA	SEARCH
101	SHTL MAX	STL MX
102	FF.REW MAX	F/R MX
104	REF ALARM	REF AL
105	AUTO EE SEL	AT EE
106	EJECT EE SEL	EJ EE
107	EE MODE SEL	EE MD
108	PLAY DELAY	PL DLY
109	CAP.LOCK	CAPSTN
110	AUTO REW	AT REW
111	MEMORY STOP	MEM ST
112	FRZ MODE SEL	FRZ MD
113	REC INH	R INH
114	REC INH LAMP	INH LP
115	EJECT SW INH	EJ SW
116	EJECT LAMP	EJ LP
118	SP MODE INH	SP MD
119	CONFI REC	CNFI R

Setup menu item No.	Name of setup menu item	Function button name
131	PAGE MODE	PAGE
132	ROTA MODE	ROTATE
133	KEY BEEP	KEY BP
134	ALARM BEEP	AL BP
140	OUTPUT	OUTPUT
141	VOLUME	VOLUME
142	AUDIO UNITY	A UNI
143	CASSTT LIGHT	CAS LT
144	TC INPUT	TC IN
145	FRONT LCD	F LCD
146	SAVER DISP	SAVER
200	PARA RUN	PR RUN
202	ID SEL	ID SEL
204	RS232C SEL	RS232C
205	BAUD RATE	BAUD R
206	DATA LENGTH	DATA L
207	STOP BIT	ST BIT
208	PARITY	PARITY
209	RETURN ACK	RET AK
212	MASTER PORT	MSTR P
300	IN/OUT DEL	IO DEL
301	NEGA FLASH	NEGA F
302	CONFI EDIT	CONFI
303	AUD EDIT IN	AUD I
304	AUD EDIT OUT	AUD O
305	AUTO ENTRY	AT ENT
306	CF ADJ SEL	CF ADJ
307	AFTER CUE-UP	AF CUP
308	VAR FWD MAX	V F MX
309	VAR REV MAX	V R MX
310	JOG FWD MAX	J F MX
311	JOG REV MAX	J R MX
312	POSTROLL TM	POSROL
313	CLICK POINT	CLK PT
320	EDIT RPLCE1	RPLCE1
321	EDIT RPLCE2	RPLCE2
322	EDIT RPLCE3	RPLCE3
323	EDIT RPLCE4	RPLCE4
324	EDIT RPLCEC	RPLCEC

Function menus (continued)

<PF1/PF2> (continued)

Setup menu item No.	Name of setup menu item	Function button name
400	STILL TIMER	STILL
401	SRC PROTECT	SRC PT
402	DRUM STDBY	DRUM
403	STOP PROTECT	STP PT
500	VITC BLANK	VI BLK
501	VITC POS-1	VI PS1
502	VITC POS-2	VI PS2
503	TCG MODE	TCG MD
504	RUN MODE	RUN MD
505	TCG REGEN	TCG RG
506	REGEN MODE	REG MD
507	TC SOURCE	TC SRC
508	BINARY GP	BINARY
509	PHASE CORR	P CORR
510	TCG CF FLAG	TG CFF
511	DF MODE	DF MOD
512	TC OUT REF	TC REF
513	VITC OUT	VITC O
514	HD EMBD VITC	ENBD V
515	HD EMBD LTC	ENBD L
516	TC OUT ADV	TC ADV
517	TCG OUT	TCG O
600	VIDEO IN SEL	VID IN
601	VIDEO INT SG	INT SG
602	SDI IN MODE	SDI IN
603	V-MUTE SEL	V-MUTE
604	FREEZE SEL	FRZ SL
605	INTERPOLATE	INTPLT
606	SD MON O SEL	SD MOS
619	V_FILTER	V_FLTR
620	DOWNCON MODE	DW CON
621	UPCON MODE	UP CON
622	D/C RESP H	D/C RH
623	D/C RESP V	D/C RV
624	U/C RESP H	U/C RH
625	U/C RESP V	U/C RV
626	D/C ENH H	D/C EH
627	D/C ENH V	D/C EV
628	U/C ENH H	U/C EH
629	U/C ENH V	U/C EV
630	1080i→HD_OUT	1080HO
632	720p→HD_OUT	720pHO
636	SD→HD_OUT	SD HO

Setup menu item No.	Name of setup menu item	Function button name
638	IN U/C MODE	IUC MD
639	I U/C RESP H	IUC RH
640	I U/C RESP V	IUC RV
641	I U/C ENH H	IUC EH
642	I U/C ENH V	IUC EV
643	IN BLK LINE	I BK L
650	STYLE	STYLE
651	HUE STYLE (SD)	HUE S
653	Y LVL (HD)	Y HD
654	Pb LVL (HD)	Pb HD
655	Pr LVL (HD)	Pr HD
656	BK LVL (HD)	BK HD
658	Y LVL (SD)	Y SD
659	Pb LVL (SD)	Pb SD
660	Pr LVL (SD)	Pr SD
661	BK LVL (SD)	BK SD
662	V LEVEL	V LV
663	C LEVEL	C LV
664	HUE (AJ-HD1800P) C PHASE (AJ-HD1800E)	HUE (AJ-HD1800P) C PH (AJ-HD1800E)
665	SETUP LVL (AJ-HD1800P) BK LVL (AJ-HD1800E)	SUP LV (AJ-HD1800P) BK LV (AJ-HD1800E)
670	BRIGHTNESS	BRIGHT
671	COLOR LEVEL	COLOR
672	CONTRAST	CNTRST
673	BACKLIGHT	BACK L
676	BLK CLIP	B CLIP
680	CC (F1) BLANK	CC1 BK
681	CC (F2) BLANK	CC2 BK
682	VO SETUP (HD) (Only AJ-HD1800P)	VOS HD (Only AJ-HD1800P)
683	VO SETUP (SD) (Only AJ-HD1800P)	VOS SD (Only AJ-HD1800P)
684	EDH (SD)	EDH SD
685	ESR MODE (SD)	ESR SD
686	CCR MODE (SD)	CCR SD
687	SDI INDEX O	SDI IX
688	CC REC	CC REC
689	COMP MODE	CMP MD
690	UMID REC	UM REC
691	UMID GEN	UM GEN
692	UMID POS	UM POS
693	GAMMA SEL	GM SL
695	BLANK LINE	BK L

Function menus (continued)

<PF1/PF2> (continued)

Setup menu item No.	Name of setup menu item	Function button name
700	CH1 IN LV	A1 ILV
701	CH2 IN LV	A2 ILV
702	CH3 IN LV	A3 ILV
703	CH4 IN LV	A4 ILV
704	CUE IN LV	AC ILV
705	CH1 OUT LV	A1 OLV
706	CH2 OUT LV	A2 OLV
707	CH3 OUT LV	A3 OLV
708	CH4 OUT LV	A4 OLV
709	CUE OUT LV	AC OLV
710	MONIL OUT LV	ML OLV
711	MONIR OUT LV	MR OLV
712	MONI OUT	MONI O
713	CH1 IN SEL	A1 IN
714	CH2 IN SEL	A2 IN
715	CH3 IN SEL	A3 IN
716	CH4 IN SEL	A4 IN
717	CH5 IN SEL	A5 IN
718	CH6 IN SEL	A6 IN
719	CH7 IN SEL	A7 IN
720	CH8 IN SEL	A8 IN
721	D IN SEL12	DIN 12
722	D IN SEL34	DIN 34
723	D IN SEL56	DIN 56
724	D IN SEL78	DIN 78
725	REC CH1	REC A1
726	REC CH2	REC A2
727	REC CH3	REC A3
728	REC CH4	REC A4
729	REC CH5	REC A5
730	REC CH6	REC A6
731	REC CH7	REC A7
732	REC CH8	REC A8
733	REC CUE	RECCUE
734	PB FADE	PB FD
735	HD EMBD AUD	HDEM A
736	SD EMBD AUD	SDEM A
737	MONI MIX	M MIX
738	CH1 CUE SEL	A1 CSL
739	CH2 CUE SEL	A2 CSL
740	CH3 CUE SEL	A3 CSL
741	CH4 CUE SEL	A4 CSL
742	CH5 CUE SEL	A5 CSL
743	CH6 CUE SEL	A6 CSL
744	CH7 CUE SEL	A7 CSL
745	CH8 CUE SEL	A8 CSL
746	MONI CH SEL	MON CH
747	MON AUTO SEL	MON AT
748	MONI SEL INH	MS INH
749	AUDIO PB VR	APB VR
750	ANA CH1 SEL	AA1 SL

Setup menu item No.	Name of setup menu item	Function button name
751	ANA CH2 SEL	AA2 SL
752	ANA CH3 SEL	AA3 SL
753	ANA CH4 SEL	AA4 SL
754	SD SDI CH1 SL	SSA1SL
755	SD SDI CH2 SL	SSA2SL
756	SD SDI CH3 SL	SSA3SL
757	SD SDI CH4 SL	SSA4SL
758	JOG PROC	JOG P
759	DV PB ATT	DV ATT
760	REC PT MUTE	R PTMT
761	AUDIO INT SG	A INSG
762	AUD RATE CON	A RC
763	METER SCALE (Only AJ-HD1800P)	M SCL (Only AJ-HD1800P)
776	REF LEVEL	REF LV
785	IN IMP CH1SL	IMP A1
786	IN IMP CH2SL	IMP A2
787	IN IMP CH3SL	IMP A3
788	IN IMP CH4SL	IMP A4
789	IN IMP CUE SL	IMP C
790	CUE REC VOL	CR VOL
791	CUE PB VOL	CP VOL
880	DIF SPEED	DF SPD
882	DIF IN CH	DF ICH
883	DIF OUT CH	DF OCH
886	DIF CONFIG	DF CFG
890	DIF AUD OUT	DF AO
891	DIF DV AUDIO	DF DVA
892	DIF SIG CMD	DF CMD
894	HD→DIF OUT	HD DO
895	50M→DIF OUT	50M DO
896	25M→DIF OUT	25M DO
899	DIF SUPER	DF SPR
A02	P.ON LOAD	P.LOAD

Function menus (continued)

<CARD>

Different kinds of settings and information can be stored or retrieved from an SD memory card. When [F2] (CARD) is pressed on the <MENU> screen while the [F] button is held down, the function menu shown below is displayed.

[MENU/ERROR LOG/MULTI CUE]

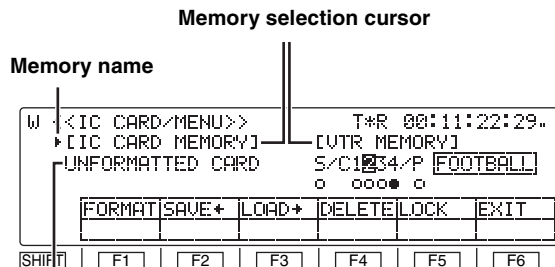

Warning message 1

SYSTEM MENU/SETUP MENU/ 50PIN ASSIGN

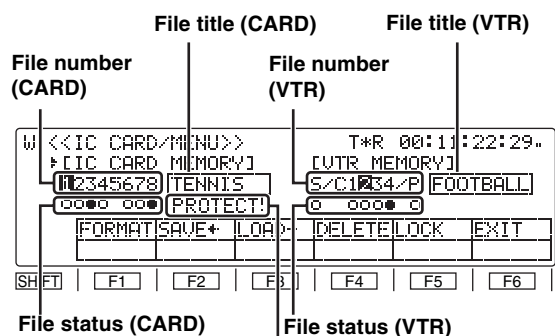

Warning message 2

MULTI CUE

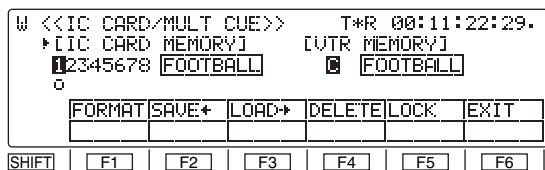

ERROR LOG

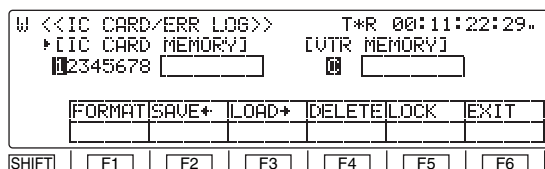

<Notes>

- The available capacity on an SD memory card is in the range from 8 MB to 2 GB.
- An SD memory card must be formatted on the unit.
- An SRAM card cannot be used.
- An SDHC memory card cannot be used.

Warning message 1

A warning message about the SD memory card is displayed.

NO CARD

No memory card is inserted.

UNFORMATTED CARD

The SD memory card is not formatted.

Warning message 2

PROTECT!

SD memory card protection is turned [ON].

ACCESS!

This is displayed for the editing operation of [F1] (FORMAT), [F2] (SAVE), [F4] (DELETE), [F5] (LOCK), and the file title (CARD).

	File status (CARD)	File status (VTR)
Blank	No storage files are present.	-----
○	Storage files are present. (Unlocked status)	The target file is in the unlocked status.
●	Storage files are present. (Locked status)	The target file is in the locked status.

To insert an SD memory card

Insert an SD memory card (optional) into the SD memory card slot on the front left side; make sure the card's notch is up.

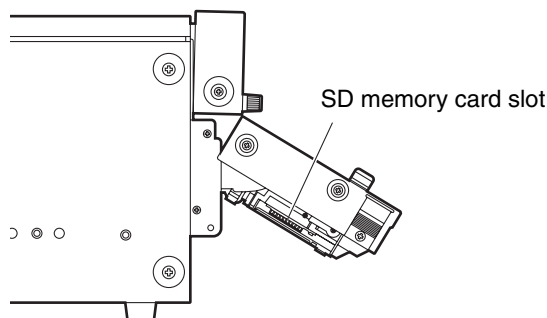

<Note>

Insert the SD memory card after confirming that the direction of the SD memory card is correct. If the card does not slide smoothly into the slot but meets some resistance, the card may be upside down or the direction may be incorrect. Do not forcibly push the card into the slot, rather confirm the direction again, and then insert the card correctly.

To eject the SD memory card

After confirming that "ACCESS!" is not displayed on Warning Message 2, push the SD memory card into the unit further. When the SD memory card is ejected from the slot, remove the card.

Notes on the following points for using and storing the card.

- Do not use or store the card in a hot, humid place.
- Do not expose the card to water.
- Prevent electrification of the card.
- When "ACCESS!" is displayed on the Warning Message 2, the unit is accessing the SD memory card. Do not remove the SD memory card while it is being accessed.

Function menus (continued)

<CARD> (continued)

[MENU/ERROR LOG/MULTI CUE]

SD Memory card data arrangement	Lock		VTR memory data layout	Lock	
SETUP MENU	1	Yes	SETUP MENU (what has been registered for the PF1, PF2 menu items, contents of some function buttons)	Current	No
	2			USER1	Yes
	3			USER2	Yes
	4			USER3	Yes
	5			USER4	Yes
	6				
	7				
	8				
50 PIN ASSIGN	1	Yes	50 PIN ASSIGN	Current	Yes
	2				
	3				
	4				
	5				
	6				
	7				
	8				
SYSTEM MENU	1	Yes	SYSTEM MENU	Current	Yes
	2				
	3				
	4				
	5				
	6				
	7				
	8				

SD Memory card data arrangement	Lock		VTR memory data layout	Lock	
MULTI CUE	1	Yes	MULTI CUE	Current	No
	2				
	3				
	4				
	5				
	6				
	7				
	8				
ERROR LOG	1	Yes	ERROR LOG	Current	No
	2				
	3				
	4				
	5				
	6				
	7				
	8				

- The SD memory card is capable of storing and retrieving the settings from the SETUP MENU (Current, USER1 to USER4)/SYSTEM MENU, the registered contents of 50PIN ASSIGN, the registered points of MULTI CUE, and the contents of the ERROR LOG.
- Titles can be provided for all the data files, and when the files are saved or loaded, the titles are also copied at the same time.
- The file lock prevents the files on an SD memory card from being overwritten.

Settings

1 Selecting the targeted memory

Press the **[SHIFT]** button

Targets shift alternately between the SD memory card and VTR MEMORY.

2 Selecting the operation files inside the selected memory

The number of the currently selected file is highlighted. Turn the ADJ dial to select the file to be operated.

- For SYSTEM MENU, SETUP MENU and 50PIN ASSIGN

The registration status indication for the SD memory card shifts automatically by selecting either S (SYSTEM MENU), C1234 (SETUP MENU), or P (50PIN ASSIGN) for VTR MEMORY.

3 Transferring files between memories

- **From VTR MEMORY to the SD memory card**

First select the operation file, and then press **[F2]** (SAVE).

- **From the SD memory card to VTR MEMORY**

After selecting the operation file, press **[F3]** (LOAD).

<Notes>

- The title is also transferred at the same time.
- After transferring files to the VTR MEMORY side, the storage process for files requires about 5 seconds. To turn off the power after transferring files, wait about 5 seconds or more after transferring the files and then turn off the power.

4 Editing the title of a selected file

First select the operation file, and then press the ADJ dial.

The first digit of the title display area is highlighted, indicating that the file title can now be edited.

- To input a number, press the number keys.
- To input letters, tap the numbers keys until the letter to be input appears while holding down the **[F]** button.
- More than one letter is allocated to each number key.
- Press the ADJ dial to move from one digit to the next on the title display area.
- To enter the title, press the ADJ dial again.

<Notes>

- When the display screen has been switched or the **[C]** button has been pressed during title editing, the editing enable status is canceled, and the setting becomes invalid.
- A space can be input by pressing the **[F]** button and **[3]** button.

Function menus (continued)

<CARD> (continued)

5 File overwrite inhibit facility

The file lock prevents the files on an SD memory card from being overwritten.

- **Locking a file**

Select the file to be locked, and press **[F5]** (LOCK).

- **Unlocking a file**

Press **[F5]** (LOCK) again.

<Note>

The locked or unlocked status is displayed in the file status.

[○: Unlocked status, ●: locked status]

Function button/ item	Switching method	Setting	Corresponding setup menu item	Description of setting
F1 FORMAT	F+Press	---	---	Formatting SD memory cards
F2 SAVE←	Press	---	---	Transferring data to SD memory cards
F3 LOAD→	Press	---	---	Transferring data from SD memory cards
F4 DELETE	F+Press	---	---	Deleting SD memory cards
F5 LOCK	Press	---	---	Locking SD memory card files/VTR MEMORY files
F6 EXIT	---	---	---	---
F1 (SHIFT) F2 (SHIFT) F3 (SHIFT) F4 (SHIFT) F5 (SHIFT) F6 (SHIFT) ---	---	---	---	---

Function menus (continued)

<50P IN/OUT ASSIGN>

Using the front panel controls and on-screen menus, functions are registered into the input pins of the parallel remote (50PIN) connector and the statuses are registered into its output pins.

When **[F5]** (50P IN) or **[F6]** (50P OT) is pressed while the **[F]** button is held down on the <MENU SHIFT> menu, the function menu shown below appears, and functions can be registered or deleted.

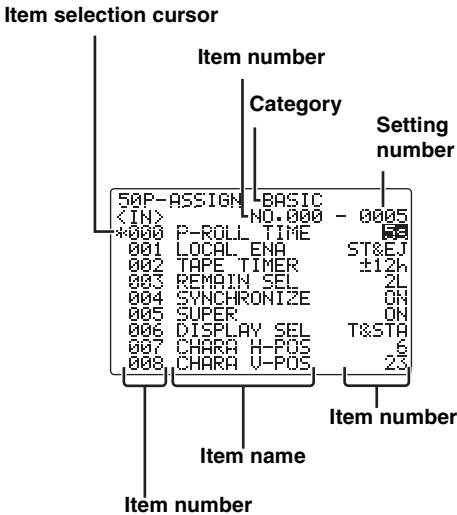
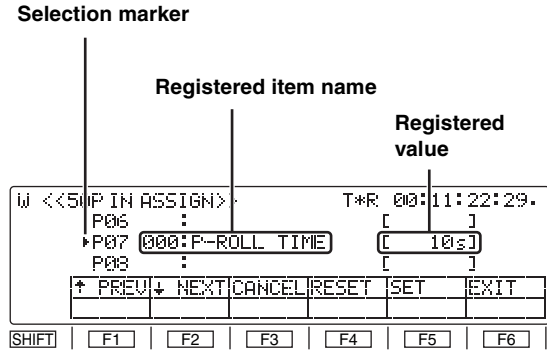

Registered item names

Setup menu items and 50PIN special menu items can be registered in the parallel remote connector pins, and the names of these menu items are displayed.

Registered values

One setting for the registered menu item is displayed in each of the pins.

When active signals are input to the IN pins in which the setup menu items mentioned above have been registered, the settings for the registered menu items take effect inside the VTR.

When the settings for the registered menu items tally with the registered values, active signals are output from the registered OUT pins.

Pins in which functions can be registered

IN pins: Pins 6 to 20, 22, 23, 25

OUT pins: Pin 21, 24, pins 32 to 46, 48

All other pins are reserved and cannot be changed.

IN pins		OUT pins	
		21	Range of pins to which any items can be assigned
		24	
		26	
1	REC	27	REC
2	PLAY	28	PLAY
3	FF	29	FF
4	REW	30	REW
5	STOP	31	STOP
6	Range of pins to which any items can be assigned	32	Range of pins to which any items can be assigned
↑		↑	
↓		↓	
20		46	
22		48	
23			
25			
		47	<GND>
		49	<GND>
		50	<GND>

Items which can be registered in the input and output pins

Items identical to the setup menu items can be registered in both the input and output pins. In addition, there are a set of special items can be also registered in the input pins and another set for the output pins.

<Note>

System menu and submenu items cannot be registered.

Item no.	Registration in input pins	Registration in output pins
000	Setup menu list	
100		
200		
300		
400		
500		
600		
700		
800		
B00	Special IN menu list	<No display>
C00	<No display>	Special OUT menu list

Function menus (continued)

<50P IN/OUT ASSIGN> (continued)

Registering functions in the input pins/Active inputs

Registering functions in the output pins/Active outputs

1 Selecting the 50-pin connector pins

Turn the ADJ dial to move the selection marker and select the pin of the 50-pin connector into which the menu item is to be registered.

2 Entering the 50-pin connector pins

Press the ADJ dial.
The entered 50-pin connector pin display is highlighted.

3 Selecting the menu item

Turn the ADJ dial and select the menu item for the pin of the 50-pin connector which was selected in step 1 above

4 Entering the menu item

Press the ADJ dial.
The on-screen setting display now blinks.

5 Selecting the setting

Turn the ADJ dial and select the setting for the menu item which was selected in step 3 above.

6 Entering the setting

Press the ADJ dial.
What is to be operated by the ADJ dial returns to the front panel. Whatever was selected in step 3 is displayed as the registered item name and whatever was selected in step 5 is displayed as the registered value.

7 To select menu items and settings for other 50-pin connector pins, repeat steps 1 to 6.

8 Saving the data in the 50-pin registration file

To save what has been set in the 50-pin connector in the 50-pin registration file, press **[F5]** (SET).
If **[F6]** (EXIT) is pressed without the above settings have been saved, those settings will be canceled.

Clearing

1 Turn the ADJ dial to move the selection marker and select the pin of the 50-pin connector whose menu item is to be cleared.

2 Press **[F4]** (RESET). The registered item name and registered value displays now go blank.

3 To clear the menu items in other 50-pin connector pins, repeat steps 1 and 2.

4 To save what has been set in the 50-pin connector in the 50-pin registration file, press **[F5]** (SET).
If **[F6]** (EXIT) is pressed without the above settings have been saved, those settings will be canceled.

Resetting all the items and values

Press **[F4]** (RESET) while holding down the **[F]** button. All the registered item names and registered values are now set to the factory settings. (These settings cannot be restored.)

Special IN menu list

No. SUPER DISPLAY	Description of setting
Functions not featured on the setup menua	
B00 STBY ON	For transferring to the STANDBY ON mode.
B01 STBY OFF	For transferring to the STANDBY OFF mode.
B02 STBY ONOFF	For alternately transferring to the STANDBY ON and OFF mode.
B03 EJECT	For transferring to the EJECT mode.
B04 CUE	For prerolling the tape to the IN point when the IN point has been registered; for prerolling the tape to the current point when the IN point has not been registered.
B05 IN SET	For registering the edit IN point.
B06 STILL	For transferring to the still picture (STILL) mode.
B07 422 REM ON	The 9-pin connector functions.
B08 422 REM OFF	The 9-pin connector does not function.
B09 TC EXT	For returning TC SOURCE to the previous EXT mode. (No switching occurs if the EXT mode is currently established)
B10 TC INT AUTO	For switching TC SOURCE to INT and TCG MODE to AUTO.
B11 TC EXT_L REG	For switching TC SOURCE to EXT_L and TCG MODE to REGEN.
SRC PROTECT and STOP PROTECT settings switched simultaneously	
B20 PROTECT HALF	For switching the tape protection mode operation to half-loading in the event that the VTR has been left standing in the STOP mode or the STILL mode while any of the search modes (JOG/SHTL/SLOW) was established.
B21 PROTECT T-REL	For switching the tape protection mode operation to tension release when the VTR has been left standing in the STOP mode or the STILL mode while any of the search modes (JOG/SHTL/SLOW) was established.
UPCON MODE and DOWNCON MODE settings switched simultaneously	
B22 UD FIT H	For switching the picture angle during down-conversion to letter box and the picture angle during up-conversion to the top/bottom cut status in the vertical direction.
B23 UD FIT-V	For switching the picture angle during down-conversion to the side cut mode and the picture angle during up-conversion to the side panel mode.
B24 UD FIT-HV	For switching the picture angle during down-conversion to the squeeze mode and the picture angle during up-conversion to the stretch mode.

Function menus (continued)

<50P IN/OUT ASSIGN> (continued)

Special OUT menu list

No. SUPER DISPLAY	Description of setting
C00 EJECT	EJECT status
C01 STBY ON	STANDBY ON status
C02 CUE	CUE-UP completed status
C03 STILL	STILL status
C04 PANEL STOP	Status in which the front panel STOP button is pressed down
C05 PRE CTL	Status of whether to inhibit overwrite during normal recording
C06 422 REM ON	9-pin connector function status
C07 REMOTE	50-pin connector function status
C08 REC INH1	Recording inhibit status 1
C09 REC INH2	Recording inhibit status 2
C10 CAS INH1	Tape recording inhibit status 1
C11 CAS INH2	Tape recording inhibit status 2
C12 TC SRC1	TC input status 1
C13 TC SRC2	TC input status 2
C14 DC1	Down-conversion status 1
C15 DC2	Down-conversion status 2
C16 DC3	Down-conversion status 3
C17 UC1	Up-conversion status 1
C18 UC2	Up-conversion status 2
C19 UD1	Up-conversion/down-conversion status 1
C20 UD2	Up-conversion/down-conversion status 2
C21 UD3	Up-conversion/down-conversion status 3
C22 ERR0	Error status 0
C23 ERR1	Error status 1
C24 ERR2	Error status 2
C26 CH GREEN	Channel condition green LED
C27 CH AMBER	Channel condition amber LED
C28 CH RED	Channel condition red LED

No. SUPER DISPLAY	Description of setting
C29 SERVO LOCK	Servo lock LED
C30 V UNITY	Video UNITY LED
C31 A UNITY	Audio UNITY LED

Function menus (continued)

<50P IN/OUT ASSIGN> (continued)

The statuses established by a multiple number of pins in the special OUT menu list are displayed. Pin status "1" signifies "active low" and "0" signifies "open."

Error statuses

C22 ERR0	C23 ERR1	C24 ERR2	Error status
0	0	0	SERVO NOT LOCKED (priority level 1)
0	0	1	SERVO LOCKED (priority level 4)
0	1	0	HIGH ERROR (amber) (priority level 3)
0	1	1	HIGH ERROR (red) (priority level 2)

TC input statuses

C12 TC SRC1	C13 TC SRC2	TC input status
0	0	External SLTC
0	1	External LTC
1	0	External SVITC (or external VITC with SD input)
1	1	INT

Tape recording inhibit statuses

C10 CAS INH1	C11 CAS INH2	Tape recording inhibit status
0	0	Cassette recording enabled
0	1	Cassette accidental erasure prevented

Recording inhibit statuses

C08 REC INH1	C09 REC INH2	Recording inhibit statuses
0	0	Overwriting prohibited during normal recording
0	1	All recording onto cassette prohibited
1	0	Recording inhibit mode other than the 2 above modes
1	1	Recording onto cassette enabled

Down-conversion statuses

C14 DC1	C15 DC2	C16 DC3	Down-conversion status
0	0	0	Squeeze mode
0	1	0	Side cut mode
1	0	0	Letter box mode
1	1	0	14:9
1	1	1	13:9

Up-conversion statuses

C17 UC1	C18 UC2	Up-conversion status
0	0	Stretch mode
0	1	Side panel mode
1	0	Top and bottom cut in vertical direction

Up-conversion down-conversion statuses

C19 UD1	C20 UD2	C21 UD3	Down-conversion status	Up-conversion status
0	0	0	Squeeze mode	Stretch mode
0	1	0	Side cut mode	Side panel mode
1	0	0	Letter box mode	Top and bottom cut in vertical direction
1	1	1	Any other combination	

Function menus (continued)

<50P IN/OUT ASSIGN> (continued)

50-pin assignment factory settings

Pin no.	I/O	Setting item
1	I	REC
2	I	PLAY
3	I	FF
4	I	REW
5	I	STOP
6	I	—
7	I	—
8	I	422 REMOTE ON
9	I	422 REMOTE OFF
10	I	LOCAL ENABLE
11	I	EJECT
12	I	IN SET
13	I	REC INH ALL
14	I	REC INH PRE
15	I	LOCAL DISABLE
16	I	TC EXT
17	I	TC INT&TCG MODE AUTO
18	I	—
19	I	—
20	I	STNDBY ON/OFF
21	O	ERR0 STATUS
22	I	—
23	I	CUE
24	O	ERR1 STATUS
25	I	—
26	Power supply	
27	O	REC STATUS
28	O	PLAY STATUS
29	O	FF STATUS
30	O	REW STATUS
31	O	STOP STATUS
32	O	422 REMOTE STATUS
33	O	EJECT STATUS
34	O	ERR2 STATUS
35	O	TC SRC1 STATUS
36	O	TC SRC2 STATUS
37	O	—
38	O	—
39	O	REC INH1 STATUS
40	O	REC INH2 STATUS
41	O	CUE STATUS
42	O	REMOTE STATUS
43	O	—
44	O	PRE CTL DETECTED STATUS

Pin no.	I/O	Setting item
45	O	LOCAL ENABLE STATUS
46	O	STANDBY ON STATUS
47	GND	
48	O	—
49	GND	
50	GND	

“—” denotes that nothing is subject to control or to a status.

<Notes>

- For a command, input TTL level signals; for an active low edge, input an electrical signal of 100 ms or more.
- For a status, a maximum open collector and sink current of 6 mA is output.

System menus

No./Item	Description of setting
05 ENCODER SEL	<p>For setting whether to perform the various adjustments for the video output signals using this VTR or using an external encoder remote controller.</p> <p>0000 REMOTE The various adjustments for the video output signals are performed by an external encoder remote controller.</p> <p>0001 LOCAL The various adjustments for the video output signals are performed using this VTR.</p> <p>0002 BOTH The various adjustments for the video output signals are performed using both this VTR and an external encoder remote controller.</p> <p><Notes></p> <ul style="list-style-type: none"> When an adjustment is made with the external encoder remote controller, the new values are reflected in the appropriate section of the Setup Menu. The adjusted values are stored on the unit approximately 5 seconds after making the adjustment. To turn off the power after making the adjustment with the external encoder remote controller, wait approximately 5 seconds or more after completion of the operation before turning the power off. For the IEEE 1394 digital output, settings are disabled in this menu.
06 V LEVEL CTRL	<p>For selecting what is to be controlled when the video output level is to be adjusted by an external encoder remote controller.</p> <p>0000 HD The HD video output level can be adjusted.</p> <p>0001 SD The SD video output level can be adjusted.</p> <p>0002 BOTH Both the HD and SD video output levels can be adjusted.</p> <p><Note> When [CMPST] is selected in Setup Menu No. 650 (STYLE), [BOTH] is selected by default regardless of the settings for this item.</p>

The underlining () denotes the factory setting mode.

Video output signal adjustments

The control matrix for the adjustments is shown in the table below.

Setting		Adjustment item	
05: ENCODER SEL	06: V LEVEL CTRL	653: Y LVL (HD)	658: Y LVL (SD)
		654: Pb LVL (HD)	659: Pb LVL (SD)
		655: Pr LVL (HD)	660: Pr VL (SD)
		656: BK LVL (HD)	661: BK LVL (SD)
REMOTE	HD	External encoder remote controller	No adjustments possible
	SD	No adjustments possible	External encoder remote controller
	BOTH	External encoder remote controller	External encoder remote controller
LOCAL	HD	This unit	This unit
	SD		
	BOTH		
BOTH	HD	External encoder remote controller/ this unit	This unit
	SD	This unit	External encoder remote controller/ this unit
	BOTH	External encoder remote controller/ This unit	External encoder remote controller/ this unit

External encoder remote controller:

Only adjustments of the external encoder remote controller are performed.

This unit :

Only adjustments of the setup menu items are performed.

External encoder remote controller/this unit :

Adjustments can be performed from both the external encoder remote controller and setup menus.

<Note>

Use the AJ-ER50, an optional accessory, as the external encoder remote controller. However, its VIDEO PHASE and SYNC PHASE controls will not work.

When "CMPST" has been selected as the setup menu item No.650 (STYLE) setting

Setting		Adjustment item
05: ENCODER SEL	06: V LEVEL CTRL	662: V LEVEL
		663: C LEVEL
		664: HUE 665: SETUP LVL
REMOTE	HD	External encoder remote controller
	SD	
	BOTH	
LOCAL	HD	This unit
	SD	
	BOTH	
BOTH	HD	External encoder remote controller/This unit
	SD	
	BOTH	

External encoder remote controller:

Only adjustments of the external encoder remote controller are performed.

This unit:

Only adjustments of the setup menu items are performed.

External encoder remote controller/This unit:

Adjustments can be performed from both the external encoder remote controller and setup menus.

<Note>

Use the MT-2000 (manufactured by Musashi and recommended by Panasonic) as the external encoder remote controller. However, its VIDEO PHASE, SYNC PHASE and SC PHASE controls will not work.

System menus (continued)

No./Item	Description of setting																								
12 SYS H (HD) ^{UP}	<p>For adjusting the HD SDI output system phase in 13.5nS steps. -: To advance the phase. +: To delay the phase.</p> <table border="1"> <tr> <td><59/60Hz></td> <td><23/24Hz></td> <td><50Hz></td> </tr> <tr> <td></td> <td></td> <td><25Hz(HD,SD)></td> </tr> <tr> <td></td> <td></td> <td><50Hz(HD,SD)></td> </tr> <tr> <td>0000 -2200</td> <td>0000 -2750</td> <td>0000 -2640</td> </tr> <tr> <td>: :</td> <td>: :</td> <td>: :</td> </tr> <tr> <td><u>2200</u> 0</td> <td><u>2750</u> 0</td> <td><u>2640</u> 0</td> </tr> <tr> <td>: :</td> <td>: :</td> <td>: :</td> </tr> <tr> <td>4400 2200</td> <td>5500 2750</td> <td>5280 2640</td> </tr> </table>	<59/60Hz>	<23/24Hz>	<50Hz>			<25Hz(HD,SD)>			<50Hz(HD,SD)>	0000 -2200	0000 -2750	0000 -2640	: :	: :	: :	<u>2200</u> 0	<u>2750</u> 0	<u>2640</u> 0	: :	: :	: :	4400 2200	5500 2750	5280 2640
<59/60Hz>	<23/24Hz>	<50Hz>																							
		<25Hz(HD,SD)>																							
		<50Hz(HD,SD)>																							
0000 -2200	0000 -2750	0000 -2640																							
: :	: :	: :																							
<u>2200</u> 0	<u>2750</u> 0	<u>2640</u> 0																							
: :	: :	: :																							
4400 2200	5500 2750	5280 2640																							
14 SYS SC (SD) ^{DW}	<p>For adjusting the system phase of the analog composite output and the SD SDI output Variable range: +/- 180 degrees or more -: Advance, +: Delay</p> <table border="1"> <tr> <td><59/60Hz></td> <td><50Hz></td> </tr> <tr> <td><23/24Hz></td> <td><25Hz(HD,SD)></td> </tr> <tr> <td></td> <td><50Hz(HD,SD)></td> </tr> <tr> <td>0000 -108</td> <td>0000 -115</td> </tr> <tr> <td>: :</td> <td>: :</td> </tr> <tr> <td><u>0108</u> 0</td> <td><u>0115</u> 0</td> </tr> <tr> <td>: :</td> <td>: :</td> </tr> <tr> <td>0216 108</td> <td>0230 115</td> </tr> </table> <p><Note> This is disabled for 60 Hz/24 Hz.</p>	<59/60Hz>	<50Hz>	<23/24Hz>	<25Hz(HD,SD)>		<50Hz(HD,SD)>	0000 -108	0000 -115	: :	: :	<u>0108</u> 0	<u>0115</u> 0	: :	: :	0216 108	0230 115								
<59/60Hz>	<50Hz>																								
<23/24Hz>	<25Hz(HD,SD)>																								
	<50Hz(HD,SD)>																								
0000 -108	0000 -115																								
: :	: :																								
<u>0108</u> 0	<u>0115</u> 0																								
: :	: :																								
0216 108	0230 115																								
15 VO SYS H (SD) ^{DW}	<p>For adjusting the system phase of the analog composite output 37nS step -: Advance, +: Delay</p> <table border="1"> <tr> <td><59/60Hz,></td> <td><50Hz></td> </tr> <tr> <td><23/24Hz></td> <td><25Hz(HD,SD)></td> </tr> <tr> <td></td> <td><50Hz(HD,SD)></td> </tr> <tr> <td>0000 -1716</td> <td>0000 -1728</td> </tr> <tr> <td>: :</td> <td>: :</td> </tr> <tr> <td><u>1716</u> 0</td> <td><u>1728</u> 0</td> </tr> <tr> <td>: :</td> <td>: :</td> </tr> <tr> <td>3432 1716</td> <td>3456 1728</td> </tr> </table>	<59/60Hz,>	<50Hz>	<23/24Hz>	<25Hz(HD,SD)>		<50Hz(HD,SD)>	0000 -1716	0000 -1728	: :	: :	<u>1716</u> 0	<u>1728</u> 0	: :	: :	3432 1716	3456 1728								
<59/60Hz,>	<50Hz>																								
<23/24Hz>	<25Hz(HD,SD)>																								
	<50Hz(HD,SD)>																								
0000 -1716	0000 -1728																								
: :	: :																								
<u>1716</u> 0	<u>1728</u> 0																								
: :	: :																								
3432 1716	3456 1728																								
16 SD SYS H (SD) ^{DW}	<p>For adjusting the system phase of the SD SDI output 37nS step -: Advance, +: Delay</p> <table border="1"> <tr> <td><59/60Hz,></td> <td><50Hz></td> </tr> <tr> <td><23/24Hz></td> <td><25Hz(HD,SD)></td> </tr> <tr> <td></td> <td><50Hz(HD,SD)></td> </tr> <tr> <td>0000 -1716</td> <td>0000 -1728</td> </tr> <tr> <td>: :</td> <td>: :</td> </tr> <tr> <td><u>1716</u> 0</td> <td><u>1728</u> 0</td> </tr> <tr> <td>: :</td> <td>: :</td> </tr> <tr> <td>3432 1716</td> <td>3456 1728</td> </tr> </table>	<59/60Hz,>	<50Hz>	<23/24Hz>	<25Hz(HD,SD)>		<50Hz(HD,SD)>	0000 -1716	0000 -1728	: :	: :	<u>1716</u> 0	<u>1728</u> 0	: :	: :	3432 1716	3456 1728								
<59/60Hz,>	<50Hz>																								
<23/24Hz>	<25Hz(HD,SD)>																								
	<50Hz(HD,SD)>																								
0000 -1716	0000 -1728																								
: :	: :																								
<u>1716</u> 0	<u>1728</u> 0																								
: :	: :																								
3432 1716	3456 1728																								

No./Item	Description of setting										
18 SCH (SD) ^{DW}	<p>For adjusting the SCH (Sub Carrier to Horizontal) phase of the analog composite output Press [SHIFT] to move to the sub menu window. To return from the sub menu window, press [SHIFT] again.</p>										
Submenu screen											
00 COARSE	<p>For adjusting the SCH phase in 90° steps (The SC phase changes, and the H phase remains unchanged.)</p> <table> <tr> <td>0000</td> <td>0</td> </tr> <tr> <td>0001:</td> <td>90</td> </tr> <tr> <td>0002:</td> <td>180</td> </tr> <tr> <td>0003:</td> <td>270</td> </tr> </table>	0000	0	0001:	90	0002:	180	0003:	270		
0000	0										
0001:	90										
0002:	180										
0003:	270										
01 FINE	<p>For adjusting the SCH phase over a total variable range of more than ±45°. -: To advance the phase. +: To delay the phase. (The SC phase changes, and the H phase remains unchanged.)</p> <table> <tr> <td>0000</td> <td>-32</td> </tr> <tr> <td>:</td> <td>:</td> </tr> <tr> <td><u>0032</u></td> <td>0</td> </tr> <tr> <td>:</td> <td>:</td> </tr> <tr> <td>0064</td> <td>32</td> </tr> </table>	0000	-32	:	:	<u>0032</u>	0	:	:	0064	32
0000	-32										
:	:										
<u>0032</u>	0										
:	:										
0064	32										

The underlining () denotes the factory setting mode.

*UP: This is for HD outputs (during HD tape playback or up-conversion outputs).

*DW: This is for SD outputs (during SD tape playback or down-conversion outputs).

System menus (continued)

No./Item	Description of setting
20 AV PHASE	<p>For adjusting the phase of the AUDIO output with the VIDEO output 20.8 microsecond steps</p> <p>– : The phase of audio output advances with respect to image output. + : The phase of audio output delays with respect to image output.</p> <p>0000 -100 : : 0100 0 : : 0200 100</p>
25 SYSTEM FREQ* ¹	<p>For selecting the system frequency.</p> <p>0000 59/60 The 59.94 Hz or 60 Hz system frequency is selected.</p> <p>0001 50i/25P*² The 50 Hz or 25 PsF system frequency is selected. At this setting, the 1080/25 PsF format signals can be recorded and played back in the same way as with the 1080/50i format.</p> <p>0002 23/24 The 23.98 Hz or 24 Hz system frequency is selected.</p> <p>0003 25(HD) The 25 Hz system frequency is selected. However, SD SDI output and analog composite output are delayed with respect to HD SDI output by about one field.</p> <p>0004 25(SD) The 25 Hz system frequency is selected. However, the black signal is output from HD SDI output.</p> <p>0005 50(HD) The 50 Hz system frequency is selected. However, SD SDI output and analog composite output are delayed with respect to HD SDI output by about one field.</p> <p>0006 50(SD) The 50 Hz system frequency is selected. However, the black signal is output from HD SDI output.</p> <p>59/60Hz mode A state selecting 0 (59/60) 50Hz mode A state selecting 1 (50i/25P) 23/24Hz mode A state selecting 2 (23/24) 25Hz(HD) mode A state selecting 3 (25 (HD)) 25Hz(SD) mode A state selecting 4 (25 (SD)) 50Hz(HD) mode A state selecting 5 (50 (HD)) 50Hz(SD) mode A state selecting 6 (50 (SD))</p> <p><Note> For the procedure to shift the system frequency, refer to page 112.</p> <p>*²The asterisk denotes the factory setting for AJ-HD1800E.</p>

No./Item	Description of setting
26 HD SYS H ADV	<p>For selecting the output whose HD output phase is to be advanced by 90H in relation to the SD output.</p> <p>0000 0H Both the HD and SD signals are output in phase with the HD and SD REF output signals.</p> <p>0001 90H The HD signals are output at a phase advanced by 90H from the SD output signals. When the SD REF signal is input, the REF input and SD output are in-phase, and when the HD REF signal is input, the REF input and HD output are inphase.</p> <p><Notes> ● The audio signals and TC signal are output in phase with the HD output. ● With the 720p format, there is a phase difference of 120H between them.</p>
30 MENU LOCK	<p>For selecting whether to set or release the system file lock mode.</p> <p>0000 OFF Lock released (changes enabled)</p> <p>0001 ON Lock set (changes prohibited)</p> <p><Notes> Even if [ON] is selected, the file is overwritten when the system file is retrieved from an SD memory card.</p>

*¹System switching

- Some of the system menu and setup menu items each have different settings for different operation modes [59/60 Hz, 50 Hz, 23/24 Hz, 25 Hz (HD or SD) and 50 Hz (HD or SD)]. These settings are saved separately.
(This concerns those items whose settings were described for each operation mode on the system menu and setup menu tables.)
- For further details, refer to <Menu management accompanying switching the system frequency> on page 113.
- **Since this VTR becomes a playback-only unit when the 23/24 Hz, 25 Hz (HD or SD) or 50 Hz (HD or SD) mode has been selected, the functions relating to EE, recording and editing are all set to the inhibited status. Neither is it possible to select CTL in such a case. (The related menus and function buttons are not displayed, and operation is prohibited.)**
For the instant when the tape begins to run at the 1× speed such as when it starts playing from the STOP status, the image is disrupted and the sound is muted for several frames because the tape is being synchronized with the REF input.

The underlining () denotes the factory setting mode.

Setup menus

<BASIC>

No./Item	Description of setting
000 P-ROLL TIME	<p>For setting the preroll time. Any time from 0 to 30 seconds can be set in 1-second increments.</p> <p>0000 0s : : 0005 5s : : 0030 30s</p> <p><Notes></p> <ul style="list-style-type: none"> ● During automatic editing (PREVIEW or AUTO EDIT), no operations are performed if the preroll time is set to 0 seconds. ● If the phases are to be synchronized between two decks for editing as per the setup menu item No.004 (SYNCHRONIZE) setting, set the preroll time to at least 2 seconds.
001 LOCAL ENA	<p>For selecting the transport system buttons which can be operated on the front panel in the REMOTE mode.</p> <p>0000 DIS No buttons can be operated.</p> <p>0001 <u>ST&EJ</u> Only the STOP and EJECT buttons can be operated.</p> <p>0002 ENA If the buttons except for the RECORDER and PLAYER buttons can be operated.</p> <p><Note> The following buttons and dials function at all times regardless of this setting: Audio input/output level control dials, audio channel selector buttons, number keys, function buttons, direct menu button, ASSEM button, INSERT button, ADJ dial, headphone volume control dial, MONITOR SELECT button, METER (FULL/FINE) selector switch, REMOTE button.</p>
002 ^{*1} TAPE TIMER	<p>For selecting the 12- or 24-hour system for the CTL counter display.</p> <p>0000 <u>±12h</u> 12-hour system display</p> <p>0001 24h 24-hour system display</p>
003 REMAIN SEL	<p>For selecting whether or not to display REMAIN (remaining tape time) on the superimposed display of the HD SDI MONITOR, SD SDI MONITOR and VIDEO OUT3 connectors.</p> <p>0000 OFF The remaining tape time is not displayed.</p> <p>0001 <u>2L</u> The remaining tape time is displayed on the second line.</p> <p>0002 1L The remaining tape time is displayed on the first line.</p> <p>0003 R/TTL The remaining tape time is displayed on the first line, and the total tape time is displayed on the second line.</p> <p><Notes></p> <ul style="list-style-type: none"> ● When setting 1 (2L) has been selected, the remaining tape time is not displayed if 0 (TIME) is selected as the setup menu item No.006 (DISPLAY SEL) setting. ● When setting 3 (R/TTL) has been selected, the remaining tape time is not displayed if 0 (TIME) is selected as the setup menu item No.006 (DISPLAY SEL) setting.

*1 When the 23/24 Hz mode, 25 Hz (HD, SD) mode, or 50 Hz (HD, SD) mode is selected in System Menu No. 25 (SYSTEM FREQ), this item is not displayed.

*The underlining () denotes the factory setting mode.

No./Item	Description of setting
004 ^{*1} SYNCHRONIZE	<p>For setting whether or not to synchronize the phases between two decks.</p> <p>0000 OFF The phases are not synchronized. The edit points will be off by several frames but editing will be commenced more promptly.</p> <p>0001 <u>ON</u> The phases are synchronized. Error-free editing can be performed.</p>
005 SUPER	<p>For selecting whether or not to superimpose the display of the time code or other data onto the HD SDI MONITOR, SD SDI MONITOR and VIDEO OUT3 connectors.</p> <p>0000 OFF The time code or other data is not displayed.</p> <p>0001 <u>ON</u> The time code or other data is displayed.</p> <p><Note></p> <ul style="list-style-type: none"> ● The 1394 output follows the settings in Setup Menu No. 899 (DIF SUPER). ● When the 23/24 Hz mode, 25 Hz (HD) mode, or 50 Hz (HD) mode is selected in System Menu No. 25 (SYSTEM FREQ), supers, such as time codes, are not displayed on the SD SDI MONITOR/VIDEO OUT 3 connector. When the 25 Hz (SD) mode or 50 Hz (SD) mode is selected, supers, such as time codes, are not displayed on the HD SDI MONITOR connector.
006 DISPLAY SEL	<p>For selecting the time code and other displays to be superimposed onto the HD SDI MONITOR, SD SDI MONITOR and VIDEO OUT3 connectors. In the following descriptions, [DATA] refers to the values for CTL/TC/UB selected in [F3] (TC/CTL).</p> <p>0000 TIME Only data are displayed.</p> <p>0001 <u>T&STA</u> Data and operating conditions are displayed.</p> <p>0002 T&S&M Data, operating conditions, and the mode are displayed</p> <p>0003 T&RT Data and REC TIME are displayed.</p> <p>0004 T&YMD Data and REC DATE (Year/Month/Day) are displayed.</p> <p>0005 T&MDY Data and REC DATE (Month/ Day/Year) are displayed.</p> <p>0006 T&DMY Data and REC DATE (Day/Month/Year) are displayed.</p> <p>0007 T&UB Data and user bits are displayed. However, when UB is selected in [F3] (TC/CTL) of the HOME menu, the time code is displayed immediately after user bits.</p> <p>0008 T&CTL Data and CTL are displayed. However, when CTL is selected in [F3] (TC/CTL) of the HOME menu, the time code is displayed immediately after CTL data.</p> <p>0009 T&T Data and the time code are displayed.</p> <p><Notes></p> <ul style="list-style-type: none"> ● When setting 2 (T&S&M) is selected, an error message appears if a warning or error has occurred. ● REC TIME and REC DATE are displayed only during DV or DVCAM format playback. The operation mode is displayed when the DVCPRO HD-LP, DVCPRO HD, DVCPRO50 or DVCPRO format is used.

Setup menus (continued)

<BASIC> (continued)

No./Item	Description of setting
007 CHARA H-POS	<p>For setting the character position in the horizontal direction for superimposed indications, such as time codes for HD SDI MONITOR/SD SDI MONITOR/VIDEO OUT3 connectors and superimposed indications from the IEEE 1394 digital interface.</p> <p>0000 0 : : 0006 6 : : 0037 37</p> <p><Note> When this menu item has been set, the displays are output to the HD SDI MONITOR, SD SDI MONITOR and VIDEO OUT3 connectors in the DISPLAY SEL status even when the SUPER OFF setting is established. However, if the menu has been exited, the SUPER OFF or ON setting is followed. Furthermore, CHARA TYPE is output as per the menu setting.</p>
008 CHARA V-POS	<p>For setting the character position in the vertical direction for superimposed indications, such as time codes for HD SDI MONITOR/SD SDI MONITOR/VIDEO OUT3 connectors and superimposed indications from the IEEE 1394 digital interface.</p> <p>0000 0 : : 0023 23 : : 0032 32</p> <p><Note> When this menu item has been set, the displays are output to the HD SDI MONITOR, SD SDI MONITOR and VIDEO OUT3 connectors in the DISPLAY SEL status even when the SUPER OFF setting is established. However, if the menu has been exited, the SUPER OFF or ON setting is followed. Furthermore, CHARA TYPE is output as per the menu setting.</p>
009 CHARA TYPE	<p>For setting the display type for the superimposed displays and for the HD SDI MONITOR, SD SDI MONITOR and VIDEO OUT3 connectors and superimposed indications from the IEEE 1394 digital interface as well as for the SETUP MENU, etc.</p> <p>0000 <u>WHITE</u> White characters on a black background. 0001 <u>W/OUT</u> White characters with black borders. <Note> CHARA TYPE is output as per the menu setting.</p>
010 ^{*1} MONI CONTROL	<p>For setting whether to forcibly set the recorder to the EE mode and output the player's playback signals to the monitor if the PLAYER button on the recorder is pressed when the monitor is connected only to the recorder during deck-to-deck editing.</p> <p>0000 <u>MANU</u> The recorder is not forcibly set to the EE mode. 0001 <u>AUTO</u> The recorder is forcibly set to the EE mode, and the player's playback signals are output.</p>

No./Item	Description of setting
011 CU-ROLL TIME	<p>For setting the preroll time in the MULTI CUE mode. Any time from 0 to 15 seconds can be set in 1-second increments.</p> <p>0000 0s : : 0005 5s : : 0015 15s</p>
015 AUTO STEP	<p>For selecting the save processing to be conducted when the memory capacity, which enables up to 99 warning messages to be saved, has been exceeded while the error log function is operating.</p> <p>0000 <u>OFF</u> 99 messages are set as the upper limit, and any more warning messages which subsequently occur are not saved in the memory. 0001 <u>ON</u> 99 messages are saved, and the next warning message that has subsequently occurred is saved as No.99. The warning messages already saved are each shifted down by one number in succession.</p>
020 ^{*1} SYS FORMAT	<p>For selecting the recording and playback formats including HD REF signals</p> <p>0000 <u>1080i</u> The 1080i format is selected. 0001 <u>720p</u> The 720p format is selected.</p>

*1 When the 23/24 Hz mode, 25 Hz (HD, SD) mode, or 50 Hz (HD, SD) mode is selected in System Menu No. 25 (SYSTEM FREQ), this item is not displayed.

The underlining () denotes the factory setting mode.

Setup menus (continued)

<BASIC> (continued)

No./Item	Description of setting
022 PB FORMAT	<p>For selecting the format in which the tape is to be played back.</p> <p>0000 MANU The format is determined by the setting selected for setup menu item No.023 (FORMAT SEL).</p> <p>0001 AUTO1 The unit follows the format recorded on the tape. Whenever the format is changed during playback, the playback format switches to others according to the changed format.</p> <p>0001 AUTO2 If the playback format does not change for 1 second or more after the SERVO lamp lights when starting playback, the current playback format is fixed. The fixed playback format is retained as is even if the format recorded on the tape is changed unless the playback mode is released.</p>
023 FORMAT SEL	<p>For selecting the format when "MANUAL" has been selected as the setup menu item No.022 (PB FORMAT) setting. If "AUTO" is selected as the setting, the format when playback starts is selected, and when the tape is played back, the format is automatically detected and matched with the format of the playback tape.</p> <p>0000 HD-LP The DVCPRO HD-LP format is selected, and the setup menu item No.020 (SYS FORMAT) setting is followed.</p> <p>0001 HD-SP The DVCPRO HD format is selected, and the setup menu item No.020 (SYS FORMAT) setting is followed.</p> <p>0002 422 The DVCPRO50 (422) format is selected.</p> <p>0003 411 The DVCPRO (411) format is selected.</p> <p>0005 DV The DV format is selected.</p> <p>0006 DVCAM The DVCAM format is selected.</p>
030 ^{*1} HD FREQUENCY	<p>For setting the field system frequency</p> <p>0000 59/23 The 59.94/23.98 Hz frequency is set.</p> <p>0001 60/24 The 60/24 Hz frequency is set.</p> <p><Notes></p> <ul style="list-style-type: none"> ● The set field frequency is enabled only when there is no input for the OUT REF settings. If there are any corresponding inputs, the field frequency coincides with the field frequency of the input. ● When the HD SDI output is output with 60 Hz/24 Hz, the SD SDI is output as NO SYNC, and the analog composite is output in the White/Black mode (burst off).

No./Item	Description of setting
031 ^{*2} OUT REF	<p>Video output reference</p> <p>0000 AUTO When the HD REF input signal is supplied, it is used as the reference. If it is not supplied but the SD REF input signal is supplied, the SD REF signal serves as the reference instead. If neither the HD REF nor SD REF input signal is supplied, the HD serial signal serves as the reference. If none of the HD REF, SD REF and HD serial signals are supplied, the internal sync signal serves as the reference.</p> <p>0001 INPUT When the serial input signal is supplied, it is used as the reference.</p> <p>0002 HD_REF The signal which is input to the HD REF IN connector is used as the reference.</p> <p>0003 SD_REF The signal which is input to the SD REF IN connector is used as the reference.</p> <p>0004 E-AUTO In edit mode, the state is the same as set in [INPUT]. In modes other than edit mode, the state is the same as set in [AUTO].</p> <p><Note> For details, refer to [Playback reference signal specifications for tape playback] (page 45).</p>

- *1: When the 50 Hz mode, 25 Hz (HD, SD) mode, or 50 Hz (HD, SD) mode is selected in System Menu No. 25 (SYSTEM FREQ), this item is not displayed.
- *2: When the 23/24 Hz mode is selected in System Menu No. 25 (SYSTEM FREQ), this item is not displayed.

*The underlining () denotes the factory setting mode.

Setup menus (continued)

<BASIC> (continued)

Formats in which the tape is played back

022: PB FORMAT	020: SYS FORMAT	023: FORMAT SEL	Playback format	
MANUAL	1080i	HD_LP	DVCPRO HD-LP(1080i)	
		HD_SP	DVCPRO HD(1080i)	
		50M	DVCPRO50(422)	
		25M	DVCPRO(411)	
		DV	DV	
		DVCAM	DVCAM	
		720p	HD_LP	DVCPRO HD-LP(720p)
	HD_SP	DVCPRO HD(720p)		
	50M	DVCPRO50(422)		
	25M	DVCPRO(411)		
	DV	DV		
	DVCAM	DVCAM		
	AUTO	-----	-----	DVCPRO HD-LP(1080i)/ DVCPRO HD(1080i)/ DVCPRO HD-LP(720p)/ DVCPRO HD(720p)/ DVCPRO50(422)/ DVCPRO(411)/ DV/DVCAM, automatic detection

<Notes>

- In the EJECT mode, the format selected by the setup menu item No.020 (SYS FORMAT) setting applies.
- If "AUTO" has been selected as the setup menu item No.022 (PB FORMAT) setting, the setup menu item No.023 (FORMAT SEL) setting is used as the format when the format is not detected (when the tape has just been inserted).

However, when "DV" or "DVCAM" has been selected, the VTR operation will be as if "HD-LP" has been selected.

Setup menus (continued)

<OPERATION>

No./Item	Description of setting
100 SEARCH ENA	<p>For selecting the direct search dial operation.</p> <p><u>0000</u> DIAL Direct search dial operations are performed.</p> <p>0001 KEY Unless the search button is pressed, the mode does not change to the search mode.</p>
101 SHTL MAX	<p>For selecting the maximum speed of shuttle operations.</p> <p>0000 x9.8 ×9.8 times normal speed</p> <p><u>0001</u> x16 ×16 times normal speed</p> <p>0002 x32 ×32 times normal speed</p> <p><Note> Depending on the tape format, the actual tape running speed differs slightly from what is indicated by the superimposed display.</p>
102 FF. REW MAX	<p>For setting the maximum speed of fast forward and rewind operations.</p> <p>0000 x16 ×16 times normal speed</p> <p>0001 x32 ×32 times normal speed</p> <p><u>0002</u> x50 ×50 times normal speed</p> <p>0003 x60 ×60 times normal speed</p> <p>0004 x100 ×100 times normal speed</p> <p><Note> The maximum speed is automatically limited to 50× for the DVCPRO HD and DVCPRO50 format and to 32× for the DV and DVCAM formats.</p>
104 REF ALARM	<p>For selecting whether a warning is to be displayed when the REF VIDEO signal has not been connected.</p> <p>0000 OFF A warning is not displayed.</p> <p><u>0001</u> ON A warning is displayed by the blinking STOP lamp.</p>
105 ^{*1} AUTO EE SEL	<p>For selecting the VTR mode which is to be set to the EE mode when "0 (EE)" is selected as the setup menu item No.140 (OUTPUT) setting.</p> <p>0000 S/F/R The EE mode is established when the VTR is in the STOP, FF or REW mode.</p> <p>0001 STOP The EE mode is established when the VTR is in the STOP mode only.</p>

*1: When the 23/24 Hz mode, 25 Hz (HD, SD) mode, or 50 Hz (HD, SD) mode is selected in System Menu No. 25 (SYSTEM FREQ), this item is not displayed.

The underlining () denotes the factory setting mode.

No./Item	Description of setting								
106 EJECT EE SEL	<p>For selecting the video and audio output statuses in the EJECT mode.</p> <p>0000 EE The EE mode is always established regardless of the setup menu item No.140 (OUTPUT) setting.</p> <p>0001 BLACK When setup menu item No.140 (OUTPUT) is set to: "EE": The EE mode is established. "TAPE": The BLACK mode is established for the video signals, and the audio signals are muted.</p> <p>0002 GRAY When setup menu item No.140 (OUTPUT) is set to: "EE": The EE mode is established. "TAPE": The GRAY mode is established for the video signals, and the audio signals are muted.</p> <p><Note> If [EE] is selected when the 23/24 Hz or 25 Hz (HD, SD), 50 Hz (HD, SD) mode is selected in System Menu No. 25 (SYSTEM FREQ), images are output in BLACK and voices are muted.</p>								
107 ^{*1} EE MODE SEL	<p>For selecting what signals are to be output when the EE mode is established.</p> <p>0000 NORMAL Signals delayed by an amount equivalent to the time taken for the signals to be processed internally are output.</p> <p>0001 THRU The signals are not processed internally but output in their original form with no delay.</p> <p><Note> When 1394 or INT-SG is selected in the video input, the system operates as "NORMAL" regardless of the settings in this item.</p>								
108 PLAY DELAY	<p>For setting the play startup time in 1-frame increments.</p> <p><u>0000</u> 0 : : 0015 15</p>								
109 ^{*1} CAP. LOCK	<p>For selecting the field unit for locking the playback framing.</p> <table style="width: 100%; border: none;"> <tr> <td style="width: 50%;"><u><59/60Hz></u></td> <td style="width: 50%;"><u><50Hz></u></td> </tr> <tr> <td>0000 2F</td> <td>0000 2F</td> </tr> <tr> <td>0001 4F</td> <td>0001 4F</td> </tr> <tr> <td></td> <td>0002 8F</td> </tr> </table>	<u><59/60Hz></u>	<u><50Hz></u>	0000 2F	0000 2F	0001 4F	0001 4F		0002 8F
<u><59/60Hz></u>	<u><50Hz></u>								
0000 2F	0000 2F								
0001 4F	0001 4F								
	0002 8F								
110 AUTO REW	<p>For selecting whether the tape is to be automatically wound back to its beginning when the tape-end has been detected.</p> <p>0000 OFF The tape stops when it reaches the tape-end.</p> <p>0001 ON The tape is rewound to its beginning.</p>								

Setup menus (continued)

<OPERATION> (continued)

No./Item	Description of setting
111*1 MEMORY STOP	<p>For selecting whether to automatically stop the VTR when the counter value is at the "0" position during CTL mode FF and REW operations.</p> <p>0000 OFF The VTR does not stop.</p> <p>0001 ON The VTR is automatically stopped.</p> <p><Notes></p> <ul style="list-style-type: none"> Either the stop or still picture (SHTL STILL or SLOW STILL) mode, whichever has been set using setup menu item No.307 (AFTER CUE-UP), is established when the VTR is stopped. If both the AUTO REW function and MEMORY function have been selected at the same time, the AUTO REW operation takes priority.
112 FRZ MODE SEL	<p>For selecting what playback images are to be output in the STANDBY OFF (HALF LOADING) mode and EJECT mode.</p> <p>0000 DIS The video output is muted.</p> <p>0001 STB OFF Only when the STANDBY OFF mode is established is the image which was being played back at that moment frozen and output.</p> <p>0002 SOF&EJ When either the STANDBY OFF mode or the EJECT mode is established, the image which was being played back at that moment is frozen and output.</p> <p><Notes></p> <ul style="list-style-type: none"> The status when the picture is frozen is determined by the setup menu item No.604 (FREEZE SEL) setting. In the EJECT mode, the frozen picture is output only when 1 (BLACK) or 2 (GRAY) has been selected as the setup menu item No.106 (EJECT EE SEL) setting. When the 720/24p over 60p source is used and the 23/24 mode is selected in System Menu item No. 25 (SYSTEM FREQ), playback cannot be frozen in EJECT mode.

Description of MEMORY STOP function

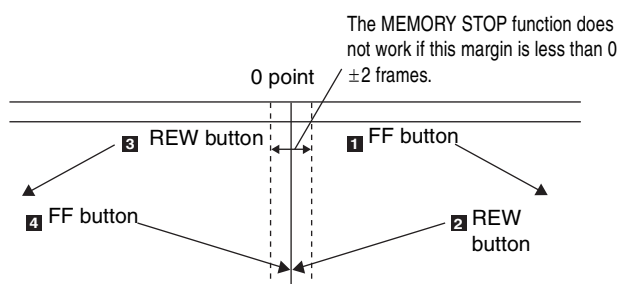

- If the FF button is pressed, the normal FF operation is performed since there is no 0 point in the direction of this operation.
- If the REW button is pressed, the PREROLL lamp lights (as does the SHTL lamp), the VTR prerolls the tape, and it automatically stops when the counter value is at the 0 position.
- If the REW button is pressed, the normal REW operation is performed since there is no 0 point in the direction of this operation.
- If the FF button is pressed, the PREROLL lamp lights (as does the SHTL lamp), the VTR prerolls the tape, and it automatically stops when the counter value is at the 0 position.

*1: When the 23/24 Hz mode, 25 Hz (HD, SD) mode, or 50 Hz (HD, SD) mode is selected in System Menu No. 25 (SYSTEM FREQ), this item is not displayed.

No./Item	Description of setting
113*1 REC INH	<p>For selecting whether to allow or inhibit recording on the cassette tape.</p> <p>0000 OFF Recording on the cassette tape is enabled when the cassette's accidental erasure prevention mechanism has been set to the recording enable position.</p> <p>0001 ALL All recording on the cassette tape is inhibited.</p> <p>0002 PRE Overwriting is inhibited during normal recording. This is the setting to activate the accidental erasure prevention function. While CTL is detected, the recording is inhibited, and when CTL cannot be detected, it is executed.</p> <p>0003 NORM Normal recording is inhibited. Use this setting when it is preferable to avoid using normal recording in all applications except for editing.</p> <p>0004 V/CTL The recording of the video and CTL signals is inhibited. Use this setting when it is preferable to avoid editing in all applications except for audio editing.</p> <p><Note> When the PRE, NORM or V/CTL setting has been selected, the REC INHIBIT lamp blinks (on for approx. 0.5 sec. and then off for approx. 0.5 sec.).</p>
114 REC INH LAMP	<p>For selecting whether the REC INHIBIT lamp is to blink or light when the cassette tape has been set to the accidental erasure protection mode.</p> <p>0000 LIGHT The lamp lights.</p> <p>0001 FLASH The lamp blinks.</p> <p><Note> When Setup Menu No. 113 (REC INH) is set to [ALL], the REC INHIBIT LAMP always lights regardless of the setting.</p>
115*1 EJECT SW INH	<p>For selecting whether to enable or disable the operation of the EJECT button on the VTR's front panel.</p> <p>0000 REC Operation is disabled while the VTR is in the recording mode.</p> <p>0001 OFF Operation is enabled in all modes.</p>
116 EJECT LAMP	<p>For selecting whether the EJECT lamp is to remain lighted or go off after the cassette tape has been ejected.</p> <p>0000 MODE1 The EJECT lamp remains lighted.</p> <p>0001 MODE2 The EJECT lamp goes off.</p>

Accidental erasure protection function

This function is used to prevent parts already recorded on a tape from being recorded over. Accidental erasure of pre-recorded tapes is prevented by positioning the CTL signal rec/play heads as shown in the figure below so that whether a recording has been made can be determined by the presence or absence of the CTL signal. When the REC/PLAY button is pressed with a pre-recorded tape, the tape runs but the REC button lamp blinks, the beeping alarm is sounded, and no signals are recorded.

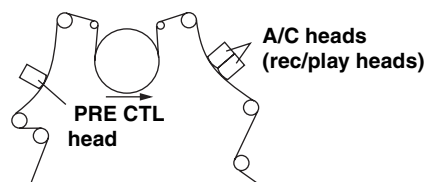

Rough sketch showing CTL head positions

Setup menus (continued)

<OPERATION> (continued)

No./Item	Description of setting
118* ¹ SP MODE INH	<p>For selecting whether to allow or inhibit recording on a tape which has been written by a format other than DVCPRO HD-LP.</p> <p>0000 OFF Recording on the cassette tape is allowed.</p> <p>0001 ON Recording on the cassette tape is inhibited.</p> <p><Note> When [OFF] is selected, the inhibition/permission state for recording to a cassette tape follows Setup Menu No. 113 (REC INH).</p>
119* ¹ CONFI REC	<p>For selecting whether or not to perform simultaneous playback during normal recording.</p> <p>0000 OFF According to the settings in Setup Menu No. 140 (OUTPUT), the simultaneous playback operation during normal recording shifts.</p> <p>EE : EE output TAPE : Simultaneous playback output</p> <p>0001 ON Regardless of the settings in Setup Menu No. 140 (OUTPUT), simultaneous playback is always applied during normal recording.</p>
131 PAGE MODE	<p>For selecting what cue point operation is to be performed when the multi cue function has been set to ON.</p> <p>0000 MANU Operation is confined within the selected page, and 6 cue points can be registered.</p> <p>0001 AUTO When the page whose cue points are being registered becomes full, operation is automatically transferred to the next page, and registration is continued. A total of 60 cue points on up to 10 pages can be registered.</p>
132 ROTA MODE	<p>For selecting whether to perform the registration operation if all the cue points have already been registered when the multi cue function has been set to ON.</p> <p>0000 OFF No further cue points are registered.</p> <p>0001 ON The registration operation is continued. If "MANU" has been selected as the setup menu item No.131 (PAGE MODE) setting, the next cue point is registered at CUE*1 on the page concerned; if "AUTO" has been selected, it is registered at CUE01.</p>
133 KEY BEEP	<p>For setting the volume of the sound heard when the keys are touched.</p> <p>0000 OFF 0001 LOW 0002 HIGH</p>
134 ALARM BEEP	<p>For setting the volume of the alarm tone.</p> <p>0000 OFF 0001 LOW 0002 HIGH</p> <p><Note> If the fan motor has shut down, the alarm tone is sounded at the HIGH volume level regardless of this setting.</p>

*1 When the 23/24 Hz mode, 25 Hz (HD, SD) mode, or 50 Hz (HD, SD) mode is selected in System Menu No. 25 (SYSTEM FREQ), this item is not displayed.

No./Item	Description of setting
140* ¹ OUTPUT	<p>For selecting the output signals.</p> <p>0000 EE The input signals selected by setup menu items No.600 (VIDEO IN SEL) and No.713 (CH1 IN SEL) to No.724 (D IN SEL 78) are output.</p> <p>0001 TAPE <In the STOP mode> The signals played back from the tape are output. <During recording or editing> The simultaneous playback signals are output.</p> <p><Note> Output signals when recording and editing are selected in Setup Menu No. 119 (CONFI REC) and No. 302 (CONFI EDIT).</p>
141* ¹ VOLUME	<p>For setting what is to be controlled by the audio volume controls on the front panel.</p> <p>0000 REC The controls function as REC volume controls.</p> <p>0001 PB The controls function as PB volume controls.</p> <p>0002 AUTO Normally, the controls function as PB volume controls. However, during recording or in the EE/ INPUT CHECK status, they automatically function as REC volume controls.</p>
142* ¹ AUDIO UNITY	<p>For selecting the conditions under which the AUDIO UNITY lamp on the front panel is to light.</p> <p>0000 IN The lamp lights when all the audio input levels are set to the UNITY level.</p> <p>0001 OUT The lamp lights when all the audio output levels are set to the UNITY level.</p> <p>002 IN/OUT The lamp lights when all the audio input and output levels are set to the UNITY level.</p>
143 CASSTT LIGHT	<p>For setting whether the lighting of the tape mechanism is to be set to ON or remain OFF.</p> <p>0000 OFF The mechanism does not light even when a cassette is inserted.</p> <p>0001 ON The mechanism lights when a cassette is inserted.</p>
144 TC INPUT	<p>For switching the preset registration method for the time code.</p> <p>0000 NORMAL The time code is input starting with the left-most digit.</p> <p>0001 REV The time code is input from the high-order digit but is displayed from the right-most digit.</p>
145 FRONT LCD	<p>For selecting whether the LCD monitor display on the front panel is to be turned on or off.</p> <p>0000 OFF The display is turned off.</p> <p>0001 ON The display is turned on or off in synchronization with the screen saver operation for the time code display area.</p>
146 SAVER DISP	<p>If the front operation or tape operation is not executed for some while, the time code display switches to the screen saver display. For selecting the screen saver display format.</p> <p>0000 BLACK To the black display</p> <p>0001 LOGO To display [EX] logo animation</p>

Setup menus (continued)

<INTERFACE>

No./Item	Description of setting
200 PARA RUN	<p>For selecting whether to operate two or more VTRs in synchronization.</p> <p><u>0000</u> DIS The VTRs are not operated in synchronization.</p> <p>0001 ENA The VTRs are operated in synchronization.</p> <p><Note> To operate the VTRs in synchronization, set all the VTRs to 1 (ENA). (Refer to page 16.)</p>
202 ID SEL	<p>For setting what ID information is to be returned to the controller.</p> <p>0000 OTHER For setting the ID information of a VTR other than DVCPRO</p> <p><u>0001</u> DVCPRO For setting the ID information of the DVCPRO</p> <p>0002 ORIG Set only for connecting with the Panasonic controller (AG-A850, optional).</p>
204 RS2323C SEL	<p>For selecting whether the RS-232C connector is to function.</p> <p><u>0000</u> OFF The RS-232C connector does not function.</p> <p>0001 ON The RS-232C connector functions.</p>
205 BAUD RATE	<p>For setting the RS-232C data transfer speed (baud rate).</p> <p>0000 300 0001 600 0002 1200 0003 2400 0004 4800 <u>0005</u> 9600</p>
206 DATA LENGTH	<p>For setting the RS-232C data length. (Unit: bits)</p> <p>0000 7 <u>0001</u> 8</p>
207 STOP BIT	<p>For setting the number of RS-232C stop bits. (Unit: bits)</p> <p><u>0000</u> 1 0001 2</p>
208 PARITY	<p>For setting whether the RS-232C parity bit is to be used and, if it is used, whether even or odd parity is to apply.</p> <p><u>0000</u> NON The parity bit is not used.</p> <p>0001 ODD The parity bit is used with an odd parity.</p> <p>0002 EVEN The parity bit is used with an even parity.</p>

No./Item	Description of setting
209 RETURN ACK	<p>For setting whether or not to return the ACK code when a command is received from RS-232C.</p> <p>0000 OFF The ACK code is not returned</p> <p><u>0001</u> ON The ACK code is returned.</p>
212 MASTER PORT	<p>For selecting the remote control connector for controlling the slave machine when this VTR is to be used as the master machine for deck-to-deck operations.</p> <p><u>0000</u> IN/OUT The IN/OUT connector is used.</p> <p>0001 OUT The OUT connector is used.</p> <p><Note> This setting takes effect only when the 9P button has been set to LOCAL (LED off).</p>

The underlining () denotes the factory setting mode.

Setup menus (continued)

<EDIT>

No./Item	Description of setting
300 IN/OUT DEL	<p>For selecting the operation to be performed when an edit point has been set incorrectly (when the OUT point comes before the IN point).</p> <p>0000 <u>MANU</u> Editing is not performed unless the illegal edit point is cleared or set properly.</p> <p>0001 <u>AUTO</u> The edit point which had already been input is cleared automatically.</p>
301 NEGA FLASH	<p>For selecting whether to show a negative display (time code display area) when the IN point is greater than the OUT point.</p> <p>0000 <u>OFF</u> A negative display is not shown.</p> <p>0001 <u>ON</u> A negative display is shown.</p>
302* ¹ CONFI EDIT	<p>For selecting whether to perform simultaneous playback during editing.</p> <p>0000 <u>OFF</u> Simultaneous playback is not performed.</p> <p>0001 <u>ON</u> Simultaneous playback is performed.</p> <p><Note> Regardless of the settings in Setup Menu No. 140 (OUTPUT), simultaneous playback is always performed during editing.</p>
303* ¹ AUD EDIT IN	<p>For selecting how to connect the digital audio edit IN points.</p> <p>0000 <u>CUT</u> Cut processing</p> <p>0001 <u>FADE</u> V-fade processing</p>
304* ¹ AUD EDIT OUT	<p>For selecting how to connect the digital audio edit OUT points.</p> <p>0000 <u>CUT</u> Cut processing</p> <p>0001 <u>FADE</u> V-fade processing</p>
305 AUTO ENTRY	<p>For selecting whether to register the IN points using the PREROLL button in cases where the IN points have not been registered.</p> <p>0000 <u>DIS</u> The IN points are not registered.</p> <p>0001 <u>ENA</u> The IN points are registered</p>
306* ¹ CF ADJ SEL	<p>For selecting the deck whose the color framing is to be adjusted during deck-to-deck editing.</p> <p>0000 <u>PLAYER</u> The player's IN and OUT points are adjusted (using the recorder as the reference).</p> <p>0001 <u>RECORD</u> The recorder's IN and OUT points are adjusted (using the player as the reference).</p>
307 AFTER CUE-UP	<p>For selecting the VTR's mode upon completion of the cue-up operation.</p> <p>0000 <u>STOP</u> The VTR is set to the STOP mode.</p> <p>0001 <u>STILL</u> The VTR is set to the still picture (SHTL STILL) mode.</p> <p>0002 <u>STILL2</u> The VTR is set to the still picture (SLOW STILL) mode.</p>

No./Item	Description of setting
308 VAR FWD MAX	<p>For setting the maximum speed of SLOW FWD.</p> <p>0000 <u>+4.9</u> +4.9 times normal tape speed</p> <p>0001 <u>+2</u> +2 times normal tape speed (+1.85 times normal tape speed for formats other than DVCPRO HD-LP)</p> <p>0002 <u>+1</u> +1 times normal tape speed</p> <p><Notes></p> <ul style="list-style-type: none"> At any setting other than 0 (+4.9), phase adjustments cannot be conducted from the editing controller. Depending on the format used, the actual tape running speed differs slightly from what is indicated by the superimposed display.
309 VAR REV MAX	<p>For setting the maximum speed of SLOW REV.</p> <p>0000 <u>-4.9</u> -4.9 times normal tape speed</p> <p>0001 <u>-2</u> -2 times normal tape speed (-1.85 times normal tape speed for formats other than DVCPRO HD-LP)</p> <p>0002 <u>-1</u> -1 times normal tape speed</p> <p><Note> Depending on the format used, the actual tape running speed differs slightly from what is indicated by the superimposed display.</p>
310 JOG FWD MAX	<p>For setting the maximum speed of JOG FWD.</p> <p>0000 <u>+4.9</u> +4.9 times normal tape speed</p> <p>0001 <u>+2</u> +2 times normal tape speed (+1.85 times normal tape speed for formats other than DVCPRO HD-LP)</p> <p>0002 <u>+1</u> +1 times normal tape speed</p> <p><Note> At any setting other than 0 (+4.9), phase adjustments cannot be conducted from the editing controller which performs these adjustments by the JOG command.</p>
311 JOG REV MAX	<p>For setting the maximum speed of JOG REV.</p> <p>0000 <u>-4.9</u> -4.9 times normal tape speed</p> <p>0001 <u>-2</u> -2 times normal tape speed (-1.85 times normal tape speed for formats other than DVCPRO HD-LP)</p> <p>0002 <u>-1</u> -1 times normal tape speed</p>
312* ¹ POSTROLL TM	<p>For setting the postroll time. Any time from 0 to 5 seconds can be set in 1-second increments.</p> <p>0000 <u>0s</u></p> <p>0001 <u>1s</u></p> <p>0002 <u>2s</u></p> <p>0003 <u>3s</u></p> <p>0004 <u>4s</u></p> <p>0005 <u>5s</u></p>

*1 When the 23/24 Hz mode, 25 Hz (HD, SD) mode, or 50 Hz (HD, SD) mode is selected in System Menu No. 25 (SYSTEM FREQ), this item is not displayed.

The underlining () denotes the factory setting mode.

Setup menus (continued)

<EDIT> (continued)

No./Item	Description of setting
313 CLICK POINT	<p>When the search dial from intermediate position turning to the right or the left with SLOW mode, the speed in the click point is set.</p> <p><u>0000</u> <u>±1</u> +/- 1 time speed</p> <p>0002 ±1.85 +/- 1.85 time speed (+ 1.85/- 1.5 times speed for format DVCPRO HD-LP)</p>
320 ^{*1} EDIT RPLCE1	<p>For setting the allocation of the channels for the analog audio presets of a controller when a controller without a function to control the edit presets of the digital audio signals is used to edit the digital audio signals of the VTR. The VTR's CH1 edit presets are set to ON or OFF following the analog audio signals specified by the controller.</p> <p>0000 N-DEF Not set.</p> <p><u>0001</u> <u>CH1</u> The analog CH1 edit presets are followed.</p> <p>0002 CH2 The analog CH2 edit presets are followed.</p> <p>0003 CH1+2 The analog CH1 or CH2 edit presets are followed.</p>
321 ^{*1} EDIT RPLCE2	<p>As with setup menu item No.320, the VTR's CH2 edit presets are set to ON or OFF following the analog audio signals specified by the controller.</p> <p>0000 N-DEF Not set.</p> <p>0001 CH1 The analog CH1 edit presets are followed.</p> <p><u>0002</u> <u>CH2</u> The analog CH2 edit presets are followed.</p> <p>0003 CH1+2 The analog CH1 or CH2 edit presets are followed.</p>
322 ^{*1} EDIT RPLCE3	<p>As with setup menu item No.320, the VTR's CH3 edit presets are set to ON or OFF following the analog audio signals specified by the controller.</p> <p><u>0000</u> <u>N-DEF</u> Not set.</p> <p>0001 CH1 The analog CH1 edit presets are followed.</p> <p>0002 CH2 The analog CH2 edit presets are followed.</p> <p>0003 CH1+2 The analog CH1 or CH2 edit presets are followed.</p>

*1 When the 23/24 Hz mode, 25 Hz (HD, SD) mode, or 50 Hz (HD, SD) mode is selected in System Menu No. 25 (SYSTEM FREQ), this item is not displayed.

The underlining () denotes the factory setting mode.

No./Item	Description of setting
323 ^{*1} EDIT RPLCE4	<p>As with setup menu item No.320, the VTR's CH4 edit presets are set to ON or OFF following the analog audio signals specified by the controller.</p> <p><u>0000</u> <u>N-DEF</u> Not set.</p> <p>0001 CH1 The analog CH1 edit presets are followed.</p> <p>0002 CH2 The analog CH2 edit presets are followed.</p> <p>0003 CH1+2 The analog CH1 or CH2 edit presets are followed.</p>
324 ^{*1} EDIT RPLCEC	<p>As with setup menu item No.320, the VTR's CUE edit presets are set to ON or OFF following the analog audio signals specified by the editor or controller.</p> <p><u>0000</u> <u>N-DEF</u> Not set.</p> <p>0001 CH1 The analog CH1 edit presets are followed.</p> <p>0002 CH2 The analog CH2 edit presets are followed.</p> <p>0003 CH1+2 The analog CH1 or CH2 edit presets are followed.</p>

Setup menus (continued)

<TAPE PROTECT>

No./Item	Description of setting
400 STILL TIMER	<p>For selecting the duration of the time taken after the VTR is left standing in the STOP or search STILL mode (JOG, SLOW or SHTL) before the tape protection mode is established. (Units: s = seconds, min = minutes)</p> <p>0000 0.5s 0001 5s 0002 10s 0003 20s 0004 30s 0005 40s 0006 50s 0007 1min <u>0008</u> 2min</p> <p><Note> When a DV or DVCAM tape is used, the time is set to 10 seconds even when a setting of 2 (10s) or longer is selected.</p>
401 SRC PROTECT	<p>When the time set in Setup Menu No. 400 (STILL TIMER) elapses in the Search Still (JOG/SLOW/SHTL) state, the unit automatically returns to the tape protection mode. This is for selecting the types of tape protection mode.</p> <p>0000 <u>STEP</u> STEP FWD 0001 <u>HALF</u> Half-loading 0002 <u>T-REL</u> Tension release</p> <p><Notes></p> <ul style="list-style-type: none"> ● When STEP FWD is selected, the VTR is automatically transferred to the standby OFF (half-loading) mode after it has been left standing in the STILL status for a total of 30 minutes (or 1 minute in the case of a DV or DVCAM tape). ● When, after tension release has been selected and the VTR has been transferred to the tension release mode, the VTR has been left standing in this mode for a total of 2 hours, it is automatically transferred to the standby OFF (half-loading) mode. However, in the case of a DV or DVCAM tape, the transfer to the tension release mode is inhibited, and the VTR operates as if STEP FWD has been selected. ● For an unused tape (except for a DV/DVCAM tape), the mode forcibly moves to the tension release mode 0.5 seconds after the STILL state.
402 DRUM STDBY	<p>For selecting whether the drum is to operate in the standby OFF (half-loading) mode.</p> <p>0000 OFF The drum stops rotating. <u>0001</u> ON The drum continues to rotate.</p>

<Precaution for STILL TIMER item setting>

The cumulative total standby time passed in the same location increases at such times when the same material is repeatedly used as is the case when programs are transmitted, for example.

To protect the tape, it is recommended to set the standby time at the same position as short as possible.

No./Item	Description of setting
403 STOP PROTECT	<p>When the time set in Setup Menu No. 400 (STILL TIMER) elapses in the STOP state, the unit automatically returns to the tape protection mode. This is for selecting the types of tape protection mode.</p> <p>0000 <u>STEP</u> STEP FWD <u>0001</u> <u>HALF</u> Half-loading 0002 <u>T-REL</u> Tension release</p> <p><Notes></p> <ul style="list-style-type: none"> ● When STEP FWD is selected, the VTR is automatically transferred to the standby OFF (half-loading) mode after it has been left standing in the STOP mode for a total of 30 minutes (or 1 minute in the case of a DV or DVCAM tape). ● When, after tension release has been selected and the VTR has been transferred to the tension release mode, the VTR has been left standing in this mode for a total of 2 hours, it is automatically transferred to the standby OFF (half-loading) mode. However, in the case of a DV or DVCAM tape, the transfer to the tension release mode is inhibited, and the VTR operates as if STEP FWD has been selected. ● For an unused tape (except for a DV/DVCAM tape), the mode forcibly moves to the tension release mode 0.5 seconds after the STILL state. ● For the DVCPRO HD-SP, DVCPRO50, or DVCPRO tapes, the mode forcibly moves to the tension release mode 0.5 seconds after the STILL state during the EE mode.

The underlining () denotes the factory setting mode.

Setup menus (continued)

<TIME CODE>

No./Item	Description of setting												
500* ² VITC BLANK	<p>For selecting whether or not to output the VITC signal at the positions selected by setup menu items No.501 (VITC POS-1) and No.502 (VITC POS-2).</p> <p>0000 BLANK The VITC signal is not output.</p> <p>0001 THRU The VITC signal is output.</p> <p><Note> Only the SD output takes effect at this setting.</p>												
501* ² VITC POS-1	<p>For setting the position where the VITC signal is to be inserted.</p> <table border="1"> <thead> <tr> <th><59/60Hz></th> <th><50Hz>, <25Hz(SD)>, <50Hz(SD)></th> </tr> </thead> <tbody> <tr> <td>0000 10L</td> <td>0000 7L</td> </tr> <tr> <td>: :</td> <td>: :</td> </tr> <tr> <td>0006 16L</td> <td>0004 11L</td> </tr> <tr> <td>: :</td> <td>: :</td> </tr> <tr> <td>0010 20L</td> <td>0015 22L</td> </tr> </tbody> </table> <p><Notes> <ul style="list-style-type: none"> The same line as the one selected by the setup menu item No.502 (VITC POS-2) or No.692(UMID POS) cannot be selected. Only the SD output takes effect at this setting. </p>	<59/60Hz>	<50Hz>, <25Hz(SD)>, <50Hz(SD)>	0000 10L	0000 7L	: :	: :	0006 16L	0004 11L	: :	: :	0010 20L	0015 22L
<59/60Hz>	<50Hz>, <25Hz(SD)>, <50Hz(SD)>												
0000 10L	0000 7L												
: :	: :												
0006 16L	0004 11L												
: :	: :												
0010 20L	0015 22L												
502* ² VITC POS-2	<p>For setting the position where the VITC signal is to be inserted.</p> <table border="1"> <thead> <tr> <th><59/60Hz></th> <th><50Hz>, <25Hz(SD)>, <50Hz(SD)></th> </tr> </thead> <tbody> <tr> <td>0000 10L</td> <td>0000 7L</td> </tr> <tr> <td>: :</td> <td>: :</td> </tr> <tr> <td>0008 18L</td> <td>0006 13L</td> </tr> <tr> <td>: :</td> <td>: :</td> </tr> <tr> <td>0010 20L</td> <td>0015 22L</td> </tr> </tbody> </table> <p><Notes> <ul style="list-style-type: none"> The same line as the one selected by the setup menu item No.501 (VITC POS-1) or No.692(UMID POS) cannot be selected. Only the SD output takes effect at this setting. </p>	<59/60Hz>	<50Hz>, <25Hz(SD)>, <50Hz(SD)>	0000 10L	0000 7L	: :	: :	0008 18L	0006 13L	: :	: :	0010 20L	0015 22L
<59/60Hz>	<50Hz>, <25Hz(SD)>, <50Hz(SD)>												
0000 10L	0000 7L												
: :	: :												
0008 18L	0006 13L												
: :	: :												
0010 20L	0015 22L												
503* ¹ TCG MODE	<p>For setting the synchronization of the internal time code generator.</p> <p>0000 REGEN The time code reader is synchronized with the time code which is read from the tape.</p> <p>0001 PRE Presetting is enabled at the operation panel or by the remote controller.</p> <p>0002 AUTO The REGEN and PRE settings are automatically switched in accordance with the operation mode. In the editing mode: REGEN is selected. In all other modes: PRE is selected.</p>												
504* ¹ RUN MODE	<p>For setting when the internal time code generator is to advance depending on the operation mode.</p> <p>0000 REC The time code generator is advanced during recording.</p> <p>0001 FREE The time code generator is advanced while the power is on regardless of which operation mode is established.</p>												

*1 When the 23/24 Hz mode, 25 Hz (HD, SD) mode, or 50 Hz (HD, SD) mode is selected in System Menu No. 25 (SYSTEM FREQ), this item is not displayed.

*2 When the 23/24 Hz mode, 25 Hz (HD) mode, or 50 Hz (HD) mode is selected in System Menu No. 25 (SYSTEM FREQ), this item is not displayed.

No./Item	Description of setting															
505* ¹ TCG REGEN	<p>For selecting the regeneration signal when REGEN has been selected as the TCG (time code generator) mode.</p> <p>0000 TC&UB Regeneration applies to both the time code and user bits.</p> <p>0001 TC Regeneration applies only to the time code only.</p> <p>0002 UB Regeneration applies only to the user bits only</p>															
506* ¹ REGEN MODE	<p>For selecting the editing mode range when the VTR is operating in the REGEN mode while performing editing operations with "AUTO" selected as the setup menu item No.503 (TCG MODE) setting.</p> <p>0000 AS&IN Regeneration applies during assemble or insert editing.</p> <p>0001 ASSEM Regeneration applies during assemble editing.</p> <p>0002 INSRT Regeneration applies during insert editing</p>															
507* ¹ TC SOURCE	<p>For selecting the time code to be used when HDSDI or SDDSDI has been selected as the setup menu item No.600 (VIDEO IN SEL) setting when an external time code is to be used.</p> <p>[When HDSDI has been selected]</p> <p>0000 INT The time code of the internal time code generator is used.</p> <p>0001 EXT_L LTC of the TIME CODE IN connector is used.</p> <p>0002 SLTC The LTC information added to the serial signals which are input to HD SDI IN is used.</p> <p>0003 SVITC The VITC information added to the serial signals which are input to HD SDI IN is used.</p> <p>[When SDDSDI has been selected]</p> <p>0000 INT The time code of the internal time code generator is used.</p> <p>0001 EXT_L LTC of the TIME CODE IN connector is used.</p> <p>0002 VITC The VITC information added to the serial signals which are input to SD SDI IN is used.</p> <p><Notes> <ul style="list-style-type: none"> If the VIDEO IN SEL input selection is changed, the time code is converted as shown below. </p> <table border="0"> <tr> <td>[HDSDI]</td> <td>↔</td> <td>[SDDSDI]</td> </tr> <tr> <td>INT</td> <td>↔</td> <td>INT</td> </tr> <tr> <td>EXT_L</td> <td>↔</td> <td>EXT_L</td> </tr> <tr> <td>SLTC</td> <td>↔</td> <td>EXT_L</td> </tr> <tr> <td>SVITC</td> <td>↔</td> <td>VITC</td> </tr> </table> <p>● When [1394] is selected in Setup Menu No. 600 (VIDEO IN SEL), the time code input for the IEEE 1394 digital input/output connector is used. However, the VITC information is not superimposed on the video signal during EE mode and when recording. Furthermore, LTC information and VITC information are not superimposed on the HD serial output.</p>	[HDSDI]	↔	[SDDSDI]	INT	↔	INT	EXT_L	↔	EXT_L	SLTC	↔	EXT_L	SVITC	↔	VITC
[HDSDI]	↔	[SDDSDI]														
INT	↔	INT														
EXT_L	↔	EXT_L														
SLTC	↔	EXT_L														
SVITC	↔	VITC														

The underlining () denotes the factory setting mode.

Setup menus (continued)

<TIME CODE> (continued)

No./Item	Description of setting
508* ¹ BINARY GP	<p>For setting how the user bits of the time code generated by the TCG is to be used.</p> <p>0000 000 NOT SPECIFIED (no character set specified)</p> <p>0001 001 ISO CHARACTER (8-bit character set complying with ISO646, ISO2022 standards)</p> <p>0002 010 UNASSIGNED 1(undefined)</p> <p>0003 011 UNASSIGNED 2(undefined)</p> <p>0004 100 UNASSIGNED 3(undefined)</p> <p>0005 101 PAGE/LINE</p> <p>0006 110 UNASSIGNED 4(undefined)</p> <p>0007 111 UNASSIGNED 5(undefined)</p>
509 PHASE CORR	<p>For selecting whether to exercise phase correction control over the LTC which is generated by the TCG.</p> <p>0000 OFF Phase correction control is not exercised.</p> <p>0001 ON Phase correction control is exercised.</p>
510* ¹ TCG CF FLAG	<p>For selecting whether to set the CF flag of the TCG to ON or OFF.</p> <p>0000 OFF The CF flag is set to OFF.</p> <p>0001 ON The CF flag is set to ON</p>
511* ² DF MODE	<p>For selecting the drop frame or non-drop frame mode for CTL and TCG.</p> <p>0000 DF The drop frame mode is selected.</p> <p>0001 NDF The non-drop frame mode is selected.</p> <p><Note> This DF mode setting takes effect only when LOCAL is selected or when "ENA" has been selected as the setup menu item No.001 (LOCAL ENA) setting.</p>
512* ¹ TC OUT REF	<p>For switching the phase of the time code, which is output from the TIME CODE OUT connector, in response to the external LTC input when a setting other than "INT" has been selected for setup menu item No.507 (TC SOURCE). (In EE mode only)</p> <p>0000 VOUT The phase is aligned with the output image.</p> <p>0001 TC IN The phase is aligned with the external time code input.</p>

SBC (sub code data) area:

This is an area on the helical track, and it is separate from the video and audio data area. The time codes, recording dates and times and other tape control information complying with SMPTE/EBU standards are stored here. As with the conventional LTC (linear time code), the time code can be read even during rewinding or fast forwarding. It can also be read out when the tape has stopped.

VAUX (video auxiliary data) area:

This area is to be found in the video data area on the helical track. The additional information relating to the video data is stored here.

*1 When the 23/24 Hz mode, 25 Hz (HD, SD) mode, or 50 Hz (HD, SD) mode is selected in System Menu No. 25 (SYSTEM FREQ), this item is not displayed.

*2 When the 23/24 Hz mode, 25 Hz (HD, SD) mode, 50 Hz (HD, SD) mode or 50 Hz mode is selected in System Menu No. 25 (SYSTEM FREQ), this item is not displayed.

No./Item	Description of setting
513 VITC OUT	<p>For selecting how to output the VITC which is superimposed on the output video signal.</p> <p>0000 SBC In the playback mode, the time code recorded in the SBC area is output.</p> <p>0001 VAUX In the playback mode, the time code recorded in the VAUX area is output.</p> <p><Note></p> <ul style="list-style-type: none"> ● The VITC information detected by the HD serial input is automatically recorded in the VAUX area when the video signals are recorded. ● When [23/24], [25 (HD)], [25 (SD)], [50 (HD)], or [50 (SD)] is selected in System Menu No. 25 (SYSTEM FREQ) and [VAUX] is selected, the output time codes may not be consecutive.
514 HD EMBD VITC	<p>For selecting whether to superimpose the VITC information on the HD serial output.</p> <p>0000 OFF The VITC information is not superimposed.</p> <p>0001 ON The VITC information is superimposed.</p>
515 HD EMBD LTC	<p>For selecting whether to superimpose the LTC information on the HD serial output.</p> <p>0000 OFF The LTC information is not superimposed.</p> <p>0001 ON The LTC information is superimposed.</p>
516* ¹ TC OUT ADV	<p>For selecting the processing to align the phase of the time code which is output from the TIME CODE OUT connector.</p> <p>Normally, the time code which is output from the TIME CODE OUT connector is aligned with the output video and audio. If so required by the connection with an external component or for some other reason, this item makes it possible to set the mode for aligning the phase with the input.</p> <p>0000 OFF The phase alignment processing is not conducted. The time code which is output from the TIME CODE OUT connector is aligned with the output video and audio.</p> <p>0001 EDIT During playback when an editing mode has been selected and during editing, the time code which is output from the TIME CODE OUT connector is aligned with the input video and audio. In all other modes, it is aligned with the output video and audio.</p>
517* ¹ TCG OUT	<p>For selecting whether to latch the TCG display and LTC output during INPUT CHECK.</p> <p>0000 MOMENT The INPUT CHECK mode is established only while the INPUT CHECK key is held down.</p> <p>0001 LATCH When the INPUT CHECK key is pressed, the INPUT CHECK mode is established; even when it is released, the mode remains unchanged. The selection is released when the video output is set to a mode other than the EE mode.</p>

The underlining () denotes the factory setting mode.

Setup menus (continued)

<VIDEO>

No./Item	Description of setting
600* ¹ VIDEO IN SEL	<p>For selecting the video signal which is to be input.</p> <p>0000 <u>INT SG</u> The internal signal selected by the VIDEO INT SG item is generated.</p> <p>0001 <u>HSDI</u> The serial video signal which has been input to the HD SDI IN connector is selected.</p> <p>0003 <u>1394</u> For selecting the compressed digital signals input to the DV connector (digital video interface). In this case, the audio input signals are also signals from the DV connector.</p> <p>0004 <u>SD SDI</u> For selecting the serial image signals input to the SD SDI IN connector</p>
601* ¹ VIDEO INT SG	<p>For selecting the type of internal signal.</p> <p>0000 <u>100%CB</u> A 100% color bar signal is selected.</p> <p>0001 <u>75%CB</u> A 75% color bar signal is selected.</p> <p>0002 <u>SMPTE</u> An SMPTE color bar signal is selected.</p> <p>0003 <u>ARIB</u> An ARIB color bar signal is selected.</p> <p>0004 <u>MB</u> A multiburst signal is selected.</p> <p>0005 <u>RAMP</u> A ramp signal is selected.</p> <p>0006 <u>BLACK</u> A black signal is selected.</p> <p>0007 <u>PLL</u> A PLL signal is selected.</p> <p>0008 <u>EQ</u> An EQ signal is selected.</p>
602* ¹ SDI IN MODE	<p>For selecting how to process the serial input.</p> <p>0000 <u>DR OFF</u> The 8 higher bits after rounding up the 2 lowest bits are recorded.</p> <p>0001 <u>DR ON</u> The signal with 8 higher bits, obtained by dynamic rounding, is recorded.</p>
603 V-MUTE SEL	<p>For selecting whether the image input signal is muted or not when blank parts of the tape are detected during playback</p> <p>0000 <u>N MUTE</u> The signals are not muted. (They are frozen.)</p> <p>0001 <u>GRAY</u> The signals are muted with gray.</p> <p>0002 <u>BLACK</u> The signals are muted with black.</p> <p>0003 <u>NOISE</u> The signals are muted with noise.</p>
604* ¹ FREEZE SEL	<p>For selecting the freeze mode of the still pictures and slow playback mode.</p> <p>0000 <u>FIELD</u> Field freeze, field slow</p> <p>0001 <u>FRAME</u> Frame freeze, frame slow</p>

The underlining () denotes the factory setting mode.

No./Item	Description of setting
605* ¹ INTERPOLATE	<p>During field slow playback, vertical interpolation is conducted automatically to minimize the up/down movement of the playback pictures. However, this setting enables the interpolation operation to be forcibly set to OFF.</p> <p>0000 <u>OFF</u> The interpolation is forcibly set to OFF</p> <p>0001 <u>AUTO</u> During slow playback, the interpolation is automatically set to ON</p>
606 SD MONI O SEL	<p>For switching the MONITOR output signal from SD SDI connector.</p> <p>0000 <u>MONI</u> The MONITOR signal is output.</p> <p>0001 <u>SDI</u> The same video signal as the one output from the SD SDI OUT1 connector is output.</p> <p><Note> When 1 (SDI) is selected, the time code and other information are not superimposed on the display.</p>
619* ⁴ V_FILTER	<p>This is used to select the method to process the images using the vertical filter during down-conversion.</p> <p>0000 <u>FIELD</u> The images are processed by field basis.</p> <p>0001 <u>FRAME</u> The images are processed by frame basis.</p> <p><Note> When "FRAME" has been selected, the resolution is improved, but the images may flicker.</p>
620* ² DOWNCON MODE	<p>For selecting the picture frame during down-conversion.</p> <p>0000 <u>FIT-V</u> Side cut mode</p> <p>0001 <u>FIT-H</u> Letter box mode</p> <p>0002 <u>FIT-HV</u> Squeeze mode</p> <p>0003 <u>14:9</u> Semi letter box 14:9</p> <p>0004 <u>13:9</u> Semi letter box 13:9</p>
621* ³ UPCON MODE	<p>For selecting the picture frame during up-conversion.</p> <p>0000 <u>FIT-V</u> Side panel mode</p> <p>0001 <u>FIT-H</u> Top and bottom cut in vertical direction</p> <p>0002 <u>FIT-HV</u> Stretch mode</p>
622 D/C RESP H	<p>For selecting the horizontal frequency band during down-conversion and line conversion (1080i ←→ 720p).</p> <p>0000 <u>WIDE</u></p> <p>0001 <u>STD</u></p>

*1 When the 23/24 Hz mode, 25 Hz (HD, SD) mode, or 50 Hz (HD, SD) mode is selected in System Menu No. 25 (SYSTEM FREQ), this item is not displayed.

*2 When the 23/24 Hz mode, 25 Hz (HD) mode, or 50 Hz (HD) mode is selected in System Menu No. 25 (SYSTEM FREQ), this item is not displayed.

*3 When the 25 Hz (HD, SD) mode or 50 Hz (HD, SD) mode is selected in System Menu No. 25 (SYSTEM FREQ), this item is not displayed.

*4 This item is displayed only when the 25 Hz (SD) mode is selected in System Menu No. 25 (SYSTEM FREQ)

Setup menus (continued)

<VIDEO> (continued)

No./Item	Description of setting
623 D/C RESP V	For selecting the vertical frequency band during down-conversion and line conversion (1080i ↔ 720p). 0000 <u>WIDE</u> 0001 STD
624*2 U/C RESP H	For selecting the horizontal frequency band during up-conversion and line conversion. 0000 STD 0001 NARROW
625*2 U/C RESP V	For selecting the vertical frequency band during up-conversion and line conversion. 0000 STD 0001 NARROW
626 D/C ENH H	For accentuating the horizontal contours during down-conversion and line conversion (1080i ↔ 720p). 0000 0dB 0001 +0.7dB 0002 <u>+1dB</u> 0003 +1.2dB 0004 +1.5dB 0005 2dB <Note> The numbers on the superimposed display are approximations only.
627 D/C ENH V	For accentuating the vertical contours during down-conversion and line conversion (1080i ↔ 720p). 0000 0dB 0001 +0.7dB 0002 <u>±1dB</u> 0003 +1.2dB 0004 +1.5dB 0005 2dB <Note> The numbers on the superimposed display are approximations only.
628*2 U/C ENH H	For accentuating the horizontal contours during up-conversion. 0000 0dB 0001 +0.7dB 0002 <u>±1dB</u> 0003 +1.2dB 0004 +1.5dB 0005 2dB <Note> The numbers on the superimposed display are approximations only.
629*2 U/C ENH V	For accentuating the vertical contours during up-conversion. 0000 0dB 0001 0.7dB 0002 <u>+1dB</u> 0003 1.2dB 0004 +1.5dB 0005 2dB <Note> The numbers on the superimposed display are approximations only.

No./Item	Description of setting
630*1 1080i → HD_ OUT	For selecting the HD output signal format during 1080i tape playback or in the 1080i EE mode. 0000 <u>1080i</u> 0001 720p <Note> When [SD SDI] is selected in Setup Menu No. 600 (VIDEO IN SEL), images are output in the format selected in Setup Menu No. 020 (SYS FORMAT) regardless of the settings in this menu.
632*3 720p → HD_ OUT	For selecting the HD output signal format during 720p tape playback or in the 720p EE mode. 0000 1080i 0001 <u>720p</u> <Note> When [SD SDI] is selected in Setup Menu No. 600 (VIDEO IN SEL), images are output in the format selected in Setup Menu No. 020 (SYS FORMAT) regardless of the settings in this menu.
636*1 SD → HD_ OUT	For selecting the HD output signal format while playing back an SD tape (DVCPRO50/DVCPRO/DV/DVCAM). 0000 <u>1080i</u> 0001 720p

- *1 When the 23/24 Hz mode, 25 Hz (HD, SD) mode, or 50 Hz (HD, SD) mode is selected in System Menu No. 25 (SYSTEM FREQ), this item is not displayed.
- *2 When the 25 Hz (HD, SD) mode or 50 Hz (HD, SD) mode is selected in System Menu No. 25 (SYSTEM FREQ), this item is not displayed.
- *3 When the 23/24 Hz mode, 25 Hz (HD, SD) mode, or 50 Hz (SD) mode is selected in System Menu No. 25 (SYSTEM FREQ), this item is not displayed.

The underlining () denotes the factory setting mode.

Setup menus (continued)

<VIDEO> (continued)

No./Item	Description of setting																
638 ^{*1} IN U/C MODE	<p>For selecting the up-conversion picture frame when SD SDI input signals are supplied.</p> <p><u>0000</u> <u>FIT-V</u> Side panel mode</p> <p>0001 <u>FIT-H</u> Top and bottom cut in vertical direction</p> <p>0002 <u>FIT-HV</u> Stretch mode</p>																
639 ^{*1} I U/C RESP H	<p>For selecting the horizontal frequency band during the up-conversion of SD SDI input signals.</p> <p><u>0000</u> <u>STD</u></p> <p>0001 <u>NARROW</u></p>																
640 ^{*1} I U/C RESP V	<p>For selecting the vertical frequency band during the up-conversion of SD SDI input signals.</p> <p><u>0000</u> <u>STD</u></p> <p>0001 <u>NARROW</u></p>																
641 ^{*1} I U/C ENH H	<p>For accentuating the horizontal contours during up-conversion of SD SDI input signals.</p> <table border="0"> <tr> <td>0000</td> <td>0dB</td> <td>0004</td> <td>+1.5dB</td> </tr> <tr> <td>0001</td> <td>+0.7dB</td> <td>0005</td> <td>+2dB</td> </tr> <tr> <td><u>0002</u></td> <td><u>+1dB</u></td> <td></td> <td></td> </tr> <tr> <td>0003</td> <td>+1.2dB</td> <td></td> <td></td> </tr> </table> <p><Note> The numbers on the superimposed display are approximations only.</p>	0000	0dB	0004	+1.5dB	0001	+0.7dB	0005	+2dB	<u>0002</u>	<u>+1dB</u>			0003	+1.2dB		
0000	0dB	0004	+1.5dB														
0001	+0.7dB	0005	+2dB														
<u>0002</u>	<u>+1dB</u>																
0003	+1.2dB																
642 ^{*1} I U/C ENH V	<p>For accentuating the vertical contours during up-conversion of SD SDI input signals.</p> <table border="0"> <tr> <td>0000</td> <td>0dB</td> <td>0004</td> <td>+1.5dB</td> </tr> <tr> <td>0001</td> <td>+0.7dB</td> <td>0005</td> <td>+2dB</td> </tr> <tr> <td><u>0002</u></td> <td><u>+1dB</u></td> <td></td> <td></td> </tr> <tr> <td>0003</td> <td>+1.2dB</td> <td></td> <td></td> </tr> </table> <p><Note> The numbers on the superimposed display are approximations only.</p>	0000	0dB	0004	+1.5dB	0001	+0.7dB	0005	+2dB	<u>0002</u>	<u>+1dB</u>			0003	+1.2dB		
0000	0dB	0004	+1.5dB														
0001	+0.7dB	0005	+2dB														
<u>0002</u>	<u>+1dB</u>																
0003	+1.2dB																
643 ^{*2} IN BLK LINE	<p>For selecting the input method for line 20 and line 21 of the video signal while the SD signal is input</p> <p><u>0000</u> <u>OFF</u> Not blank</p> <p>0001 <u>ON</u> Blank</p>																
650 STYLE	<p><u>0000</u> <u>CMPNT*</u> Level adjustment mode for the component style</p> <p>0001 <u>CMPST</u> Level adjustment mode for the composite style</p> <p>* The asterisk denotes the factory setting for AJ-HD1800E.</p>																
651 ^{*3} HUE STYLE (SD) ^{*DW}	<p>For selecting the rotational axis of the chroma phase adjustment.</p> <p>0000 <u>Pb-Pr</u> The axis rotates in a perfect circle on the SDI (component style) vectorscope.</p> <p><u>0001</u> <u>U-V</u> The axis rotates in a perfect circle on the analog (composite style) vectorscope.</p>																

No./Item	Description of setting										
653 Y LVL (HD) ^{*UP}	<p>For adjusting the Y level of the HD SDI output. (-∞ to 0 dB to +3 dB)</p> <table border="0"> <tr> <td>0000</td> <td>0.0%</td> </tr> <tr> <td>:</td> <td>:</td> </tr> <tr> <td><u>1000</u></td> <td><u>100.0%</u></td> </tr> <tr> <td>:</td> <td>:</td> </tr> <tr> <td>1413</td> <td>141.3%</td> </tr> </table> <p><Note> This setting takes effect when "CMPNT" has been selected as the setup menu item No.650 setting.</p>	0000	0.0%	:	:	<u>1000</u>	<u>100.0%</u>	:	:	1413	141.3%
0000	0.0%										
:	:										
<u>1000</u>	<u>100.0%</u>										
:	:										
1413	141.3%										
654 Pb LVL (HD) ^{*UP}	<p>For adjusting the PB level of the HD SDI output. (-∞ to 0 dB to +3 dB)</p> <table border="0"> <tr> <td>0000</td> <td>0.0%</td> </tr> <tr> <td>:</td> <td>:</td> </tr> <tr> <td><u>1000</u></td> <td><u>100.0%</u></td> </tr> <tr> <td>:</td> <td>:</td> </tr> <tr> <td>1413</td> <td>141.3%</td> </tr> </table> <p><Note> This setting takes effect when "CMPNT" has been selected as the setup menu item No.650 setting.</p>	0000	0.0%	:	:	<u>1000</u>	<u>100.0%</u>	:	:	1413	141.3%
0000	0.0%										
:	:										
<u>1000</u>	<u>100.0%</u>										
:	:										
1413	141.3%										
655 Pr LVL (HD) ^{*UP}	<p>For adjusting the PB level of the HD SDI output. (-∞ to 0 dB to +3 dB)</p> <table border="0"> <tr> <td>0000</td> <td>0.0%</td> </tr> <tr> <td>:</td> <td>:</td> </tr> <tr> <td><u>1000</u></td> <td><u>100.0%</u></td> </tr> <tr> <td>:</td> <td>:</td> </tr> <tr> <td>1413</td> <td>141.3%</td> </tr> </table> <p><Note> This setting takes effect when "CMPNT" has been selected as the setup menu item No.650 setting.</p>	0000	0.0%	:	:	<u>1000</u>	<u>100.0%</u>	:	:	1413	141.3%
0000	0.0%										
:	:										
<u>1000</u>	<u>100.0%</u>										
:	:										
1413	141.3%										

- *1 When the 23/24 Hz mode, 25 Hz (HD, SD) mode, or 50 Hz (HD, SD) mode is selected in System Menu No. 25 (SYSTEM FREQ), this item is not displayed.
- *2 When the 23/24 Hz mode, 25 Hz (HD, SD) mode, 50 Hz (HD, SD) mode or 50 Hz mode is selected in System Menu No. 25 (SYSTEM FREQ), this item is not displayed.
- *3 When the 50 Hz mode, 25 Hz (HD, SD) mode, or 50 Hz (HD, SD) mode is selected in System Menu No. 25 (SYSTEM FREQ), this item is not displayed.

*UP: With HD output (HD tape playback or up-converted output)

*DW: With SD output (SD tape playback or down-converted output)

The underlining () denotes the factory setting mode.

Setup menus (continued)

<VIDEO> (continued)

No./Item	Description of setting
656 BK LVL (HD) ^{*UP}	<p>For adjusting the black level of the HD SDI output.</p> <p>50 -10.0%</p> <p> :</p> <p>150 0.0%</p> <p> :</p> <p>250 +10.0%</p> <p><Note> This setting takes effect when "CMPNT" has been selected as the setup menu item No.650 setting.</p>
658 Y LVL (SD) ^{*DW}	<p>For adjusting the Y level of SD SDI output and analog composite output (-∞ to 0 dB to +3 dB)</p> <p>0000 0.0%</p> <p> :</p> <p>1000 100.0%</p> <p> :</p> <p>1413 141.3%</p> <p><Note> This setting takes effect when "CMPNT" has been selected as the setup menu item No.650 setting.</p>
659 Pb LVL (SD) ^{*DW}	<p>For adjusting the PB level of SD SDI output and analog composite output (-∞ to 0 dB to +3 dB)</p> <p>0000 0.0%</p> <p> :</p> <p>1000 100.0%</p> <p> :</p> <p>1413 141.3%</p> <p><Note> This setting takes effect when "CMPNT" has been selected as the setup menu item No.650 setting.</p>
660 Pr LVL (SD) ^{*DW}	<p>For adjusting the PR level of SD SDI output and analog composite output (-∞ to 0 dB to +3 dB)</p> <p>0000 0.0%</p> <p> :</p> <p>1000 100.0%</p> <p> :</p> <p>1413 141.3%</p> <p><Note> This setting takes effect when "CMPNT" has been selected as the setup menu item No.650 setting.</p>
661 BK LVL (SD) ^{*DW}	<p>For adjusting the black level of SD SDI output and analog composite output</p> <p>50 -10.0%</p> <p> :</p> <p>150 0.0%</p> <p> :</p> <p>250 +10.0%</p> <p><Note> This setting takes effect when "CMPNT" has been selected as the setup menu item No.650 setting.</p>
662 V LEVEL	<p>For adjusting the black level of SD SDI output and analog composite output (-∞ to 0 dB to +6 dB)</p> <p>0000 0.0%</p> <p> :</p> <p>1000 100.0%</p> <p> :</p> <p>2000 200.0%</p> <p><Note> This setting takes effect when "CMPST" has been selected as the setup menu item No.650 setting.</p>

No./Item	Description of setting
663 C LEVEL	<p>For adjusting the chroma level of HD SDI, SD SDI, and analog composite output (-∞ to 0 dB to +3 dB)</p> <p>0000 0.0%</p> <p> :</p> <p>1000 100.0%</p> <p> :</p> <p>1413 141.3%</p> <p><Note> This setting takes effect when "CMPST" has been selected as the setup menu item No.650 setting.</p>
664 HUE (AJ-HD1800P) C PHASE (AJ-HD1800E)	<p>For adjusting the chroma phase of HD SDI, SD SDI, and analog composite output (Approx.- 30° to +30°)</p> <p>0000 -31.0</p> <p> :</p> <p>0062 0.0</p> <p> :</p> <p>0124 31.0</p> <p><Note></p> <ul style="list-style-type: none"> ● This setting takes effect when "CMPST" has been selected as the setup menu item No.650 setting. ● When the 50 Hz mode, 25 Hz (HD/SD) mode, or 50 Hz (HD/SD) mode is selected in System Menu No. 25 (SYSTEM FREQ), it is impossible to adjust the HD SDI output. ● The SD SDI and analog composite output can be adjusted only when a tape in SD format is played back, or cross conversion is set in Menu No. 630 (1080i → HD OUT) and No. 631 (720p → HD OUT).
665 SETUP LVL (AJ-HD1800P) BK LVL (AJ-HD1800E)	<p>For adjusting the setup (black) level of the HD SDI output, SD SDI output and VIDEO output. (-10% to +10%)</p> <p>50 -10.0%</p> <p> :</p> <p>150 0.0%</p> <p> :</p> <p>250 +10.0%</p> <p><Note> This setting takes effect when "CMPST" has been selected as the setup menu item No.650 setting.</p>
670 BRIGHTNESS	<p>For adjusting the brightness of the LCD monitor on the front panel.</p> <p>0000 -7</p> <p> :</p> <p>0007 0</p> <p> :</p> <p>0014 7</p>
671 COLOR LEVEL	<p>For adjusting the color density of the LCD monitor on the front panel</p> <p>0000 -7</p> <p> :</p> <p>0007 0</p> <p> :</p> <p>0014 7</p>

*UP: With HD output (HD tape playback or up-converted output)
*DW: With SD output (SD tape playback or down-converted output)

The underlining () denotes the factory setting mode.

Setup menus (continued)

<VIDEO> (continued)

No./Item	Description of setting
672 CONTRAST	For adjusting the contrast of the LCD monitor on the front panel. 0000 -7 : : 0007 0 : : 0014 7
673 BACKLIGHT	For adjusting the backlight 0000 <u>NORMAL</u> Normal mode 0001 HIGH The backlight is brighter than NORMAL.
676*2 BLK CLIP	This function clips the signals below the pedestal level for SD SDI OUT and composite OUT Y (luminance) signals. 0000 <u>OFF</u> The signals are not clipped. 0001 ON The signals are clipped.
680*1 CC (F1) BLANK *DW	For selecting ON or OFF for the closed caption signals in the first field. 0000 BLANK The signals are forcibly blanked. 0001 <u>THRU</u> The signals are not blanked
681*1 CC (F2) BLANK *DW	For selecting ON or OFF for the closed caption signals in the second field. 0000 BLANK The signals are forcibly blanked. 0001 <u>THRU</u> The signals are not blanked.
682 VO SETUP (HD)*UP (This menu is not displayed for AJ-HD1800E.)	This selects the composite output signal in HD mode. 0000 <u>THRU</u> The signal is output with no setup added. 0001 <u>ADD22L</u> The signal is output from line 22 with a 7.5% setup added. 0002 <u>ADD21L</u> The signal is output from line 21 with a 7.5% setup added. 0001 <u>ADD20L</u> The signal is output from line 20 with a 7.5% setup added.
683 VO SETUP (SD)*DW (This menu is not displayed for AJ-HD1800E.)	This selects the composite output signal in SD mode. 0000 <u>THRU</u> The signal is output with no setup added. 0001 <u>ADD22L</u> The signal is output from line 22 with a 7.5% setup added. 0002 <u>ADD21L</u> The signal is output from line 21 with a 7.5% setup added. 0001 <u>ADD20L</u> The signal is output from line 20 with a 7.5% setup added.
684 EDH (SD)*DW	For selecting whether EDH is superimposed on SD SDI output 0000 OFF EDH is not superimposed. 0001 <u>ON</u> EDH is superimposed

No./Item	Description of setting
685*1 ESR MODE (SD)*DW	For selecting the operation mode for edge subcarrier reduction (ESR) in the playback circuit. 0000 OFF ESR is forcibly set to OFF 0001 <u>AUTO</u> ESR is automatically set to ON or OFF in accordance with the VTR operation
686*1 CCR MODE (SD)*DW	For selecting the cross color processing during playback. 0000 OFF The cross color is output as is. 0001 ON The cross color can be reduced
687*3 SDI INDEX 0 *DW	For selecting whether to superimpose the VIDEO INDEX signal on the SD SDI output signal. 0000 OFF The VIDEO INDEX signal is not superimposed on the SD SDI output signal. 0001 ON The VIDEO INDEX signal is superimposed on the SD SDI output signal.
688*1 CC REC	For selecting whether to record the closed caption signals which are superimposed on the SD input signal. 0000 OFF The closed caption signals are not recorded on the tape. 0001 <u>ON</u> The closed caption signals are recorded on the tape if they are superimposed on the SD input signal. In this case, they are blanked, up-converted and then recorded.

- *1 When the 23/24 Hz mode, 25 Hz (HD, SD) mode, or 50 Hz (HD, SD) mode is selected in System Menu No. 25 (SYSTEM FREQ), this item is not displayed.
- *2 When the 50 Hz mode, 25 Hz (HD, SD) mode, or 50 Hz (HD, SD) mode is selected in System Menu No. 25 (SYSTEM FREQ), this item is not displayed.
- *3 When the 23/24 Hz mode, 25 Hz (HD) mode, or 50 Hz (HD) mode is selected in System Menu No. 25 (SYSTEM FREQ), this item is not displayed.

*UP: With HD output (HD tape playback or up-converted output)
*DW: With SD output (SD tape playback or down-converted output)

The underlining () denotes the factory setting mode.

Setup menus (continued)

<VIDEO> (continued)

No./Item	Description of setting
689* ¹ COMP MODE	<p>This is used to select the method to process the image compression during recording.</p> <p>0000 NORMAL The images are recorded using the regular compression processing.</p> <p>0001 DARK The images are recorded while minimizing the compressed image distortion which arises in the dark areas below about 10 IRE (70 mV).</p> <p><Notes></p> <ul style="list-style-type: none"> ● This setting is valid when recording in the 720p mode. ● When [DARK] is selected, the indication (c) blinks to the left of the second line of the superimposed indication.
690* ¹ UMID REC	<p>This selects whether or not to record the UMID information on the tape.</p> <p>0000 OFF UMID information is not recorded on the tape. The [EE] output is also blank.</p> <p>0001 ON The UMID set in menu No. 691 UMID GEN is recorded. If no Basic UMID is available in the input signals, a Basic UMID of the unit, which is newly generated, is recorded.</p> <p><Note> UMID information cannot be rewritten in this unit.</p>
691* ¹ UMID GEN	<p>This selects a UMID that is recorded when menu No. 690 UMID REC is turned "ON".</p> <p>0000 INT Newly created basic UMID information of this unit is always recorded.</p> <p>0001 EXT The UMID information of the input signals is recorded. If no UMID is available in the input signals, a Basic UMID of the unit, which is newly generated, is recorded.</p> <p><Note> The source pack (of the UMID information) of the input signal will be recorded on the tape, regardless of this menu's setting.</p>
692* ¹ UMID POS	<p>This sets the line on which the UMID information is to be superimposed.</p> <p>0000 BLANK 0001 12L : : 0006 17L : : 0008 19L</p> <p><Notes></p> <ul style="list-style-type: none"> ● The line selected for the menu item No. 501 VITC POS-1 and No. 502 VITC POS-2 settings cannot be selected for this item. ● Even if [F4] (RESET) is pressed while the settings are changed, the settings does not return to the factory settings. ● Metadata recorded on the tape will be output giving UMID information first priority. When metadata is output, set to a line other than the original multiplexed line or select "BLANK."

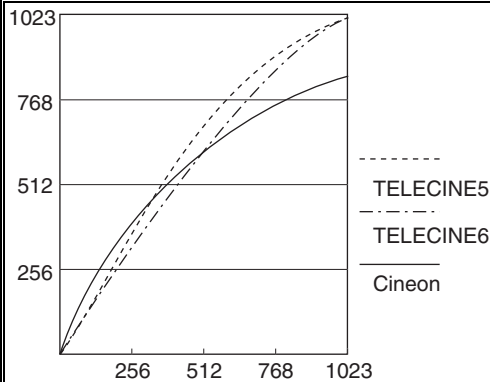
No./Item	Description of setting
693 GAMMA SEL	<p>This selects gamma correction.</p> <p>0000 OFF Gamma correction is not carried out.</p> <p>0001 GAMMA1 This corrects video images shot with the cine gamma FilmREC mode of the Varicam to images of film quality (equivalent to Telecine 5 of HD Gamma Corrector in AJ-GBX27G).</p> <p>0002 GAMMA2 This corrects video images shot with the cine gamma FilmREC mode of the Varicam to images of film quality (equivalent to Telecine 6 of HD Gamma Corrector in AJ-GBX27G).</p> <p>0003 GAMMA3 This converts video images shot with the cine gamma FilmREC mode of the Varicam into the Cineon curve appropriate for film recording.</p> <div style="text-align: right;">  </div> <p><Notes></p> <ul style="list-style-type: none"> ● Gamma correction is effective in the following conditions. <ul style="list-style-type: none"> ◆ When the VTR operation mode is VV (TAPE) and 720p is displayed in the system format. However, when the 23/24 mode is selected in System Menu No. 25 (SYSTEM FREQ), or 59/60 and 50i/25p are selected in System Menu No. 25 (SYSTEM FREQ), as well as performing the cross conversion from 720p to 1080i, gamma correction is not performed for SD output. ● If it is set to execute gamma correction, the GM indicator in the time code display lights constantly. ● When the power of the unit is turned OFF, the settings in this item also return to [OFF]. ● This item is not effective for 1394 output.

- *1 When the 23/24 Hz mode, 25 Hz (HD, SD) mode, or 50 Hz (HD, SD) mode is selected in System Menu No. 25 (SYSTEM FREQ), this item is not displayed.
- *2 When the 23/24 Hz mode, 25 Hz (HD, SD) mode, 50 Hz (HD, SD) mode or 50 Hz mode is selected in System Menu No. 25 (SYSTEM FREQ), this item is not displayed.

The underlining () denotes the factory setting mode.

Setup menus (continued)

<VIDEO> (continued)

No./Item	Description of setting
695* ¹ BLANK LINE	<p>For selecting ON or OFF for blanking for the vertical blanking period of the video signals during SD tape playback.</p> <p><u>0000</u> <u>BLANK</u> All the lines are forcibly blanked</p> <p>0001 THRU None of the lines are blanked.</p> <p>0002 <u>MANU</u> Blanking ON or OFF is selected on a line-by-line basis.</p> <p><Note></p> <ul style="list-style-type: none"> When [MANU] is set, press SHIFT to move to the sub window and select ON/OFF for the respective lines. To return from the sub window, press SHIFT again. Lines that are selected to be blanked in this item must be blanked in the same way before being up-converted when playing back the SD tape.
Submenu screen <59/60Hz>	
01 LINE 11&274 : : : 12 LINE 22&285	<p><u>0000</u> <u>BLANK</u> The lines are forcibly blanked.</p> <p>0001 THRU The lines are not blanked</p>
Submenu screen <50Hz>	
00 LINE 7&320 : : : 15 LINE 22&335	<p><u>0000</u> <u>BLANK</u> The lines are forcibly blanked.</p> <p>0001 THRU The lines are not blanked</p>

The underlining () denotes the factory setting mode.

<AUDIO>

No./Item	Description of setting
700* ¹ CH1 IN LV	<p>For selecting the audio input (CH1) reference level.</p> <p>0000 4dB <u>0001</u> <u>0dB</u> 0002 -3dB 0003 -20dB</p>
701* ¹ CH2 IN LV	<p>For selecting the audio input (CH2) reference level.</p> <p>0000 4dB <u>0001</u> <u>0dB</u> 0002 -3dB 0003 -20dB</p>
702* ¹ CH3 IN LV	<p>For selecting the audio input (CH3) reference level.</p> <p>0000 4dB <u>0001</u> <u>0dB</u> 0002 -3dB 0003 -20dB</p>
703* ¹ CH4 IN LV	<p>For selecting the audio input (CH4) reference level.</p> <p>0000 4dB <u>0001</u> <u>0dB</u> 0002 -3dB 0003 -20dB</p>
704* ¹ CUE IN LV	<p>For selecting the CUE input reference level.</p> <p>0000 4dB <u>0001</u> <u>0dB</u> 0002 -3dB 0003 -20dB 0004 -60dB</p>
705 CH1 OUT LV	<p>For selecting the audio output (CH1) reference level.</p> <p>0000 4dB <u>0001</u> <u>0dB</u> 0002 -3dB 0003 -20dB</p>
706 CH2 OUT LV	<p>For selecting the audio output (CH2) reference level.</p> <p><u>00000</u> 4dB <u>0001</u> <u>0dB</u> 0002 -3dB 0003 -20dB</p>
707 CH3 OUT LV	<p>For selecting the audio output (CH3) reference level.</p> <p>0000 4dB <u>0001</u> <u>0dB</u> 0002 -3dB 0003 -20dB</p>
708 CH4 OUT LV	<p>For selecting the audio output (CH4) reference level.</p> <p>0000 4dB <u>0001</u> <u>0dB</u> 0002 -3dB 0003 -20dB</p>

*1 When the 23/24 Hz mode, 25 Hz (HD, SD) mode, or 50 Hz (HD, SD) mode is selected in System Menu No. 25 (SYSTEM FREQ), this item is not displayed.

Setup menus (continued)

<AUDIO> (continued)

No./Item	Description of setting
709	For selecting the CUE output reference level.
CUE OUT LV	0000 4dB 0001 <u>0dB</u> 0002 -3dB 0003 -20dB
710	For selecting the audio monitor output (Lch) reference level.
MONIL OUT LV	0000 4dB 0001 <u>0dB</u> 0002 -3dB 0003 -20dB
711	For selecting the audio monitor output (Rch) reference level.
MONIR OUT LV	0000 4dB 0001 <u>0dB</u> 0002 -3dB 0003 -20dB
712	For selecting whether the volume of audio monitor output is interlocked to the volume adjustment knob or not.
MONI OUT	0000 UNITY The signals are output at a fixed level. 0001 <u>VAR</u> The signal output is coupled with the headphones volume control.
713 ^{*1,2}	For selecting the CH1 input signal.
CH1 IN SEL	0000 INT SG The internal signal is selected. 0001 <u>DIGI</u> Digital input signals are selected. 0002 ANA Analog input signals are selected. <Note> When DIGI has been selected, whether serial or AES is selected for the input is determined by the setting selected for setup menu item No.721 (D IN SEL 12).
714 ^{*1,2}	For selecting the CH2 input signal.
CH2 IN SEL	0000 INT SG The internal signal is selected. 0001 <u>DIGI</u> Digital input signals are selected. 0002 ANA Analog input signals are selected. <Note> When DIGI has been selected, whether serial or AES is selected for the input is determined by the setting selected for setup menu item No.721 (D IN SEL 12).
715 ^{*2}	For selecting the CH3 input signal.
CH3 IN SEL	0000 INT SG The internal signal is selected. 0001 <u>DIGI</u> Digital input signals are selected. 0002 ANA Analog input signals are selected. <Note> When DIGI has been selected, whether serial or AES is selected for the input is determined by the setting selected for setup menu item No.722 (D IN SEL 34).

No./Item	Description of setting
716 ^{*1,2}	For selecting the CH4 input signal.
CH4 IN SEL	0000 INT SG The internal signal is selected. 0001 <u>DIGI</u> Digital input signals are selected. 0002 ANA Analog input signals are selected. <Note> When DIGI has been selected, whether serial or AES is selected for the input is determined by the setting selected for setup menu item No.722 (D IN SEL 34).
717 ^{*1,2}	For selecting the CH5 input signal.
CH5 IN SEL	0000 INT SG The internal signal is selected. 0001 <u>DIGI</u> Digital input signals are selected. 0002 ANA Analog input signals are selected. (CH1 input) <Note> When DIGI has been selected, whether serial or AES is selected for the input is determined by the setting selected for setup menu item No.723 (D IN SEL 56).
718 ^{*1,2}	For selecting the CH6 input signal.
CH6 IN SEL	0000 INT SG The internal signal is selected. 0001 <u>DIGI</u> Digital input signals are selected. 0002 ANA Analog input signals are selected. (CH2 input) <Note> When DIGI has been selected, whether serial or AES is selected for the input is determined by the setting selected for setup menu item No.723 (D IN SEL 56).
719 ^{*1,2}	For selecting the CH7 input signal.
CH7 IN SEL	0000 INT SG The internal signal is selected. 0001 <u>DIGI</u> Digital input signals are selected. 0002 ANA Analog input signals are selected. (CH3 input) <Note> When DIGI has been selected, whether serial or AES is selected for the input is determined by the setting selected for setup menu item No.724 (D IN SEL 78).

*1 When the 23/24 Hz mode, 25 Hz (HD, SD) mode, or the 50 Hz (HD, SD) mode is selected in System Menu No. 25 (SYSTEM FREQ), this item is not displayed.

*2 When 1394 is selected in System Menu No. 600 (VIDEO IN SEL), it is the 1394 input regardless of the selection in this menu.

The underlining () denotes the factory setting mode.

Setup menus (continued)

<AUDIO> (continued)

No./Item	Description of setting
720*1,2 CH8 IN SEL	<p>For selecting the CH8 input signal.</p> <p>0000 INT SG The internal signal is selected.</p> <p>0001 DIGI Digital input signals are selected.</p> <p>0002 ANA Analog input signals are selected. (CH4 input)</p> <p><Note> When DIGI has been selected, whether serial or AES is selected for the input is determined by the setting selected for setup menu item No.724 (D IN SEL 78).</p>
721*1,2 D IN SEL12	<p>For selecting the CH1 and CH2 digital input signals.</p> <p>0000 AES AES/EBU</p> <p>0001 SDI Serial</p> <p><Note> When INT SG is selected for the video input signal, serial input for the audio signal becomes the HD SDI signal.</p>
722*1,2 D IN SEL34	<p>For selecting the CH3 and CH4 digital input signals.</p> <p>0000 AES AES/EBU</p> <p>0001 SDI Serial</p> <p><Note> When INT SG is selected for the video input signal, serial input for the audio signal becomes the HD SDI signal.</p>
723*1,2 D IN SEL56	<p>For selecting the CH5 and CH6 digital input signals.</p> <p>0000 AES AES/EBU</p> <p>0001 SDI Serial</p> <p><Note> When INT SG is selected for the video input signal, serial input for the audio signal becomes the HD SDI signal.</p>
724*1,2 D IN SEL78	<p>For selecting the CH7 and CH8 digital input signals.</p> <p>0000 AES AES/EBU</p> <p>0001 SDI Serial</p> <p><Note> When INT SG is selected for the video input signal, serial input for the audio signal becomes the HD SDI signal.</p>
725*1,3 REC CH1	<p>For selecting the input signals to be recorded on the audio CH1 track.</p> <p>0000 CH1 Audio input CH1 signals</p> <p>0001 CH2 Audio input CH2 signals</p> <p>0002 CH3 Audio input CH3 signals</p> <p>0003 CH4 Audio input CH4 signals</p> <p>0004 CH1+2 Audio input CH1 and CH2 mixed signals</p> <p>0005 CH3+4 Audio input CH3 and CH4 mixed signals</p>

No./Item	Description of setting
726*1,3 REC CH2	<p>For selecting the input signals to be recorded on the audio CH2 track.</p> <p>0000 CH1 Audio input CH1 signals</p> <p>0001 CH2 Audio input CH2 signals</p> <p>0002 CH3 Audio input CH3 signals</p> <p>0003 CH4 Audio input CH4 signals</p> <p>0004 CH1+2 Audio input CH1 and CH2 mixed signals</p> <p>0005 CH3+4 Audio input CH3 and CH4 mixed signals</p>
727*1,3 REC CH3	<p>For selecting the input signals to be recorded on the audio CH3 track.</p> <p>0000 CH1 Audio input CH1 signals</p> <p>0001 CH2 Audio input CH2 signals</p> <p>0002 CH3 Audio input CH3 signals</p> <p>0003 CH4 Audio input CH4 signals</p> <p>0004 CH1+2 Audio input CH1 and CH2 mixed signals</p> <p>0005 CH3+4 Audio input CH3 and CH4 mixed signals</p>
728*1,3 REC CH4	<p>For selecting the input signals to be recorded on the audio CH4 track.</p> <p>0000 CH1 Audio input CH1 signals</p> <p>0001 CH2 Audio input CH2 signals</p> <p>0002 CH3 Audio input CH3 signals</p> <p>0003 CH4 Audio input CH4 signals</p> <p>0004 CH1+2 Audio input CH1 and CH2 mixed signals</p> <p>0005 CH3+4 Audio input CH3 and CH4 mixed signals</p>

*1 When the 23/24 Hz mode, 25 Hz (HD, SD) mode, or the 50 Hz (HD, SD) mode is selected in System Menu No. 25 (SYSTEM FREQ), this item is not displayed.

*2 When 1394 is selected in System Menu No. 600 (VIDEO IN SEL), it is the 1394 input regardless of the selection in this menu.

*3 When 1394 is selected in System Menu No. 600 (VIDEO IN SEL), the mode is the factory setting mode regardless of the selection in this menu.

The underlining () denotes the factory setting mode.

Setup menus (continued)

<AUDIO> (continued)

No./Item	Description of setting
729*1,2 REC CH5	<p>For selecting the input signals to be recorded on the audio CH5 track.</p> <p>0000 <u>CH5</u> Audio input CH5 signals</p> <p>0001 <u>CH6</u> Audio input CH6 signals</p> <p>0002 <u>CH7</u> Audio input CH7 signals</p> <p>0003 <u>CH8</u> Audio input CH8 signals</p> <p>0004 <u>CH5+6</u> Audio input CH5 and CH6 mixed signals</p> <p>0005 <u>CH7+8</u> Audio input CH7 and CH8 mixed signals</p>
730*1,2 REC CH6	<p>For selecting the input signals to be recorded on the audio CH6 track.</p> <p>0000 <u>CH5</u> Audio input CH5 signals</p> <p>0001 <u>CH6</u> Audio input CH6 signals</p> <p>0002 <u>CH7</u> Audio input CH7 signals</p> <p>0003 <u>CH8</u> Audio input CH8 signals</p> <p>0004 <u>CH5+6</u> Audio input CH5 and CH6 mixed signals</p> <p>0005 <u>CH7+8</u> Audio input CH7 and CH8 mixed signals</p>
731*1,2 REC CH7	<p>For selecting the input signals to be recorded on the audio CH7 track.</p> <p>0000 <u>CH5</u> Audio input CH5 signals</p> <p>0001 <u>CH6</u> Audio input CH6 signals</p> <p>0002 <u>CH7</u> Audio input CH7 signals</p> <p>0003 <u>CH8</u> Audio input CH8 signals</p> <p>0004 <u>CH5+6</u> Audio input CH5 and CH6 mixed signals</p> <p>0005 <u>CH7+8</u> Audio input CH7 and CH8 mixed signals</p>

No./Item	Description of setting
732*1,2 REC CH8	<p>For selecting the input signals to be recorded on the audio CH8 track.</p> <p>0000 <u>CH5</u> Audio input CH5 signals</p> <p>0001 <u>CH6</u> Audio input CH6 signals</p> <p>0002 <u>CH7</u> Audio input CH7 signals</p> <p>0003 <u>CH8</u> Audio input CH8 signals</p> <p>0004 <u>CH5+6</u> Audio input CH5 and CH6 mixed signals</p> <p>0005 <u>CH7+8</u> Audio input CH7 and CH8 mixed signals</p>
733*1 REC CUE	<p>For selecting the input signals to be recorded on the CUE track.</p> <p>0000 <u>CUE</u> CUE IN</p> <p>0001 <u>CH1</u> Audio input CH1 signals</p> <p>0002 <u>CH2</u> Audio input CH2 signals</p> <p>0003 <u>CH3</u> Audio input CH3 signals</p> <p>0004 <u>CH4</u> Audio input CH4 signals</p> <p>0005 <u>CH5</u> Audio input CH5 signals</p> <p>0006 <u>CH6</u> Audio input CH6 signals</p> <p>0007 <u>CH7</u> Audio input CH7 signals</p> <p>0008 <u>CH8</u> Audio input CH8 signals</p> <p>0009 <u>CH1+2</u> Audio input CH1 and CH2 mixed signals</p> <p>0010 <u>CH3+4</u> Audio input CH3 and CH4 mixed signals</p> <p>0011 <u>CH5+6</u> Audio input CH5 and CH6 mixed signals</p> <p>0012 <u>CH7+8</u> Audio input CH7 and CH8 mixed signals</p> <p>0013 <u>CH1-8</u> Audio input CH1 to CH8 mixed signals</p> <p><Note> When the VIDEO input switch is set to 1394, audio is not recorded on the CUE track, and the sound is muted.</p>

*1 When the 23/24 Hz mode, 25 Hz (HD, SD) mode, or the 50 Hz (HD, SD) mode is selected in System Menu No. 25 (SYSTEM FREQ), this item is not displayed.

*2 When 1394 is selected in System Menu No. 600 (VIDEO IN SEL), the mode is the factory setting mode regardless of the selection in this menu.

The underlining () denotes the factory setting mode.

Setup menus (continued)

<AUDIO> (continued)

No./Item	Description of setting
734* ¹ PB FADE	<p>For selecting how to process the audio edit points (IN points and OUT points) during playback.</p> <p><u>0000</u> <u>AUTO</u> The status established during recording is followed.</p> <p>0001 <u>CUT</u> Forcibly cut</p> <p>0002 <u>FADE</u> Forcibly faded</p>
735 HD EMBD AUD	<p>For selecting whether to superimpose the audio data on the HD SDI output.</p> <p>0000 <u>OFF</u> The audio data is not superimposed.</p> <p><u>0001</u> <u>ON</u> The audio data is superimposed.</p>
736 SD EMBD AUD	<p>For selecting whether to superimpose the audio data on the SD SDI output.</p> <p>0000 <u>OFF</u> The audio data is not superimposed.</p> <p><u>0001</u> <u>ON</u> The audio data is superimposed.</p>
737 MONI MIX	<p>For selecting the mixed signals for the headphone monitor (Lch and/or Rch).</p> <p><u>0000</u> <u>OFF</u> Neither the Lch nor Rch signals are mixed.</p> <p>0001 <u>L</u> Only the Lch signals are mixed.</p> <p>0002 <u>R</u> Only the Rch signals are mixed</p> <p>0003 <u>L/R</u> Both the Lch and Rch signals are mixed.</p> <p><Notes></p> <ul style="list-style-type: none"> At the OFF setting, the signals to be output to monitor L (or monitor R) are switched to CH1, CH2, CH3 and so on each time the "L" or "R" button is pressed. The selected signals are displayed below the audio level meter. At the L, R or L/R setting, the signals of a multiple number of channels can be mixed and output. When the number key corresponding to the channel whose signals are to be monitored is pressed while the "L" (or "R") button is held down, that channel is selected. The selected channel is displayed below the audio level meter. (Alternatively, the same steps can be taken to de-select a channel which has already been selected.) However, only up to 2 channels among the CH1-CH4 channels and up to 2 channels among the CH5 to CH8 channels can be selected.
738 CH1 CUE SEL	<p>For selecting the CH1 output status of the main signal line in the search mode.</p> <p><u>0000</u> <u>OFF</u> The CUE signal is not output.</p> <p>0001 <u>ON</u> The CUE signal is output.</p> <p><Note> For details on the audio output statuses, refer to [Audio outputs in the search mode] (page 109).</p>

No./Item	Description of setting
739 CH2 CUE SEL	<p>For selecting the CH2 output status of the main signal line in the search mode.</p> <p><u>0000</u> <u>OFF</u> The CUE signal is not output.</p> <p>0001 <u>ON</u> The CUE signal is output.</p> <p><Note> For details on the audio output statuses, refer to [Audio outputs in the search mode] (page 109).</p>
740 CH3 CUE SEL	<p>For selecting the CH3 output status of the main signal line in the search mode.</p> <p><u>0000</u> <u>OFF</u> The CUE signal is not output.</p> <p>0001 <u>ON</u> The CUE signal is output.</p> <p><Note> For details on the audio output statuses, refer to [Audio outputs in the search mode] (page 109).</p>
741 CH4 CUE SEL	<p>For selecting the CH4 output status of the main signal line in the search mode.</p> <p><u>0000</u> <u>OFF</u> The CUE signal is not output.</p> <p>0001 <u>ON</u> The CUE signal is output.</p> <p><Note> For details on the audio output statuses, refer to [Audio outputs in the search mode] (page 109).</p>
742 CH5 CUE SEL	<p>For selecting the CH5 output status of the main signal line in the search mode.</p> <p><u>0000</u> <u>OFF</u> The CUE signal is not output.</p> <p>0001 <u>ON</u> The CUE signal is output.</p> <p><Note> For details on the audio output statuses, refer to [Audio outputs in the search mode] (page 109).</p>
743 CH6 CUE SEL	<p>For selecting the CH6 output status of the main signal line in the search mode.</p> <p><u>0000</u> <u>OFF</u> The CUE signal is not output.</p> <p>0001 <u>ON</u> The CUE signal is output.</p> <p><Note> For details on the audio output statuses, refer to [Audio outputs in the search mode] (page 109).</p>
744 CH7 CUE SEL	<p>For selecting the CH7 output status of the main signal line in the search mode.</p> <p><u>0000</u> <u>OFF</u> The CUE signal is not output.</p> <p>0001 <u>ON</u> The CUE signal is output.</p> <p><Note> For details on the audio output statuses, refer to [Audio outputs in the search mode] (page 109).</p>

*1 When the 23/24 Hz mode, 25 Hz (HD, SD) mode, or the 50 Hz (HD, SD) mode is selected in System Menu No. 25 (SYSTEM FREQ), this item is not displayed.

Setup menus (continued)

<AUDIO> (continued)

No./Item	Description of setting
745 CH8 CUE SEL	<p>For selecting the CH8 output status of the main signal line in the search mode.</p> <p><u>0000</u> OFF The CUE signal is not output.</p> <p>0001 ON The CUE signal is output.</p> <p><Note> For details on the audio output statuses, refer to [Audio outputs in the search mode] (page 109).</p>
746 MONI CH SEL	<p>For selecting the monitor output.</p> <p>0000 MANU The signal selected by the MONITOR SELECT button is output.</p> <p><u>0001</u> AUTO The PCM audio signal is output in the $-1.0\times$ to $+2.0\times$ speed range; the CUE signal is automatically output at all other speeds.</p> <p>0002 PCM The PCM audio signal is output in the $-32\times$ to $+32\times$ speed range.</p> <p><Notes> <ul style="list-style-type: none"> When "AUTO" is selected and a tape in any format except DVCPRO HD-LP is played back, the PCM audio signals are output in the $-1.0\times$ to $+1.1\times$ speed range. This setting takes effect when the L and R MONITOR SELECT switches on the VTR's front panel have selected a channel from CH1 to CH8. (If they have selected CUE, the CUE signal is output at all speeds regardless of this menu item's setting.) </p>
747 MON AUTO SEL	<p>For selecting the channel for the monitor output to be switched to CUE.</p> <p>When a setting other than "MANU" has been selected for setup menu item No.746 (MONI CH SEL), the CUE signal is automatically output to the monitor output in accordance with the operation mode, and the monitor channel to be switched to CUE is selected automatically.</p> <p><u>0000</u> L/R The CUE signal is output both to the Lch and Rch.</p> <p>0001 L The CUE signal is output to the Lch only.</p> <p>0002 R The CUE signal is output to the Rch only</p> <p><Note> For audio output conditions, refer to [Audio outputs in the search mode] (page 109).</p>
748 MONI SEL INH	<p>For selecting whether to enable or inhibit the operation of the MONITOR SELECT button on the front panel.</p> <p><u>0000</u> OFF The button's operation is enabled.</p> <p>0001 ON The button's operation is inhibited.</p> <p>0002 ON1 In the FULL display mode, operation is prohibited; in the FINE display mode only, operation is enabled.</p> <p><Note> Whether to enable or inhibit the button's operation can be selected for channels whose signals have not been mixed by the setup menu item No.737 (MONI MIX) setting.</p>

No./Item	Description of setting
749*1 AUDIO PB VR	<p>For selecting whether the playback level adjustment controls are to function in the EE mode when INT SG has been selected on the <AUDIO> function menu.</p> <p><u>0000</u> DIS The INT SG output level is fixed at the UNITY level.</p> <p>0001 ENA The INT SG output level can be varied using the playback level adjustment controls.</p>
750 ANA CH1 SEL	<p>For selecting the signal to be output to analog output CH1.</p> <p><u>0000</u> CH1 The CH1 signal is output</p> <p>0001 CH5 The CH5 signal is output</p>
751 ANA CH2 SEL	<p>For selecting the signal to be output to analog output CH2.</p> <p><u>0000</u> CH2 The CH2 signal is output.</p> <p>0001 CH6 The CH6 signal is output</p>
752 ANA CH3 SEL	<p>For selecting the signal to be output to analog output CH3.</p> <p><u>0000</u> CH3 The CH3 signal is output</p> <p>0001 CH7 The CH7 signal is output</p>
753 ANA CH4 SEL	<p>For selecting the signal to be output to analog output CH4.</p> <p><u>0000</u> CH4 The CH4 signal is output</p> <p>0001 CH8 The CH8 signal is output</p>
754 SD SDI CH1 SL	<p>For selecting the audio CH1 signal to be superimposed onto the SD SDI output.</p> <p><u>0000</u> CH1 The CH1 signal is output.</p> <p>0001 CH2 The CH2 signal is output.</p> <p>0002 CH3 The CH3 signal is output.</p> <p>0003 CH4 The CH4 signal is output.</p> <p>0004 CH5 The CH5 signal is output.</p> <p>0005 CH6 The CH6 signal is output.</p> <p>0006 CH7 The CH7 signal is output.</p> <p>0007 CH8 The CH8 signal is output.</p>

*1 When the 23/24 Hz mode, 25 Hz (HD, SD) mode, or the 50 Hz (HD, SD) mode is selected in System Menu No. 25 (SYSTEM FREQ), this item is not displayed.

The underlining () denotes the factory setting mode.

Setup menus (continued)

<AUDIO> (continued)

No./Item	Description of setting
755 SD SDI CH2 SL	<p>For selecting the audio CH2 signal to be superimposed onto the SD SDI output</p> <p>0000 CH1 The CH1 signal is output.</p> <p><u>0001</u> CH2 The CH2 signal is output.</p> <p>0002 CH3 The CH3 signal is output.</p> <p>0003 CH4 The CH4 signal is output.</p> <p>0004 CH5 The CH5 signal is output.</p> <p>0005 CH6 The CH6 signal is output.</p> <p>0006 CH7 The CH7 signal is output.</p> <p>0007 CH8 The CH8 signal is output.</p>
756 SD SDI CH3 SL	<p>For selecting the audio CH3 signal to be superimposed onto the SD SDI output</p> <p>0000 CH1 The CH1 signal is output.</p> <p>0001 CH2 The CH2 signal is output.</p> <p><u>0002</u> CH3 The CH3 signal is output.</p> <p>0003 CH4 The CH4 signal is output.</p> <p>0004 CH5 The CH5 signal is output.</p> <p>0005 CH6 The CH6 signal is output.</p> <p>0006 CH7 The CH7 signal is output.</p> <p>0007 CH8 The CH8 signal is output.</p>
757 SD SDI CH4 SL	<p>For selecting the audio CH4 signal to be superimposed onto the SD SDI output</p> <p>0000 CH1 The CH1 signal is output.</p> <p>0001 CH2 The CH2 signal is output.</p> <p>0002 CH3 The CH3 signal is output.</p> <p><u>0003</u> CH4 The CH4 signal is output.</p> <p>0004 CH5 The CH5 signal is output.</p> <p>0005 CH6 The CH6 signal is output.</p> <p>0006 CH7 The CH7 signal is output.</p> <p>0007 CH8 The CH8 signal is output.</p>
758 JOG PROC	<p>For selecting how to process the digital audio output slow signals in the JOG, VAR or SHTL mode.</p> <p>0000 OFF The sound without having the digital audio output slow signals processed is output even when the STILL mode is established.</p> <p><u>0001</u> ON The sound after having the digital audio output slow signals processed is output.</p>

No./Item	Description of setting
759 DV PB ATT	<p>For selecting the audio output level during DV format playback.</p> <p>0000 OFF The audio output level is not attenuated.</p> <p><u>0001</u> ON The audio output level is attenuated.</p>
760*1 REC PT MUTE	<p>For selecting whether to mute the sound at the joins between recordings during DV or DVCAM format playback.</p> <p>0000 OFF The sound is not muted.</p> <p>0001 ON The sound is muted</p>
761*1 AUDIO INT SG	<p>For selecting the type of internal signal.</p> <p>0000 TONE A sine wave signal is selected.</p> <p>0001 SILNCE A silent signal is selected.</p>
762 AUD RATE CON	<p>This item enables signals to be recorded and played back without passing them through the rate converter in the audio input/output section (without engaging the digital filter).</p> <p>0000 OFF The signals are recorded and played back without passing them through the rate converter.</p> <p><u>0001</u> ON The signals are recorded and played back after passing them through the rate converter.</p> <p><Note></p> <ul style="list-style-type: none"> ● ON/OFF control is exercised at the same time for CH1 to CH8. ON or OFF cannot be set independently for each channel. ● When the rate converter is turned OFF, video input must be synchronized with the reference signal selected in [OUT REF]. (If they are not synchronized, noise may be generated.) ● In the 60 Hz mode, noise may occur if OFF is set for the rate converter.
763 METER SCALE (This menu is not displayed for AJ-HD1800E.)	<p>For selecting the scale display of the audio level meter.</p> <p>0000 PEAK 0 The audio level is displayed with 0 dB as the maximum level.</p> <p>0001 REF 0 The audio level is displayed with 0 dB as the reference level.</p> <p><Note> When FS-18 or FS-12 is selected in Setup Menu No. 776 (REF LEVEL), the system operates as PEAK-0 regardless of the settings in this menu.</p>
776 REF LEVEL	<p>For setting the standard audio level (Headroom)</p> <p>0000 FS-20 — 20 dB</p> <p><u>0001</u> FS-18* — 18 dB</p> <p>0002 FS-12 — 12 dB</p> <p>* The asterisk denotes the factory setting for AJ-HD1800E.</p>

*1 When the 23/24 Hz mode, 25 Hz (HD, SD) mode, or the 50 Hz (HD, SD) mode is selected in System Menu No. 25 (SYSTEM FREQ), this item is not displayed.

The underlining () denotes the factory setting mode.

Setup menus (continued)

<AUDIO> (continued)

No./Item	Description of setting
785*1 IN IMP CH1SL	For setting the impedance of analog audio input (CH1) 0000 600 600 Ω 0001 HIGH High impedance
786*1 IN IMP CH2SL	For setting the impedance of analog audio input (CH2) 0000 600 600 Ω 0001 HIGH High impedance
787*1 IN IMP CH3SL	For setting the impedance of analog audio input (CH3) 0000 600 600 Ω 0001 HIGH High impedance

*1: This item is not displayed when the 23/24 Hz mode, 25 Hz (HD or SD) mode or 50 Hz (HD or SD) has been selected as the system menu item No.25 (SYSTEM FREQ) setting.

Audio outputs in the search mode

The table below lists the signals which are output to the monitor and main signal line and which are determined by how the settings of menu items No.738 to No.745, and No.746 and No.747 are combined.

No./Item	Description of setting
788*1 IN IMP CH4SL	For setting the impedance of analog audio input (CH4) 0000 600 600 Ω 0001 HIGH High impedance
789*1 IN IMP CUE SL	For setting the impedance of CUE input 0000 600 600 Ω 0001 HIGH High impedance
790*1 CUE REC VOL	For adjusting the recording level of the CUE audio signal. (−∞ to 0 dB to +12 dB) 0032 16 : : 0016 0 : : : : 0000 -16
791 CUE PB VOL	For adjusting the playback level of the CUE audio signal. (−∞ to 0 dB to +12 dB) 0032 16 : : 0016 0 : : : : 0000 -16

738 CH1 CUE SEL : 745 CH8 CUE SEL	746 MONI CH SEL	747 MON AUTO SEL	Monitor output		Main signal line output				
			Lch	Rch	CH1/CH3/CH5/CH7	CH2/CH4/CH6/CH8			
OFF	MANU	L/R	PCM*2	PCM*2	PCM*2	PCM*2			
		L							
		R							
	AUTO	L/R	CUE*3	CUE*3					
		L	CUE*3	PCM*2					
		R	PCM*2	CUE*3					
	PCM	L/R	PCM*4	PCM*4			PCM*5	PCM*5	
		L							
		R							
ON	MANU	L/R	PCM*2	PCM*2	PCM*2	PCM*2			
		L							
		R							
	AUTO	L/R	CUE*3	CUE*3			CUE*3	CUE*3	
		L	CUE*3	PCM*2			CUE*3	PCM*2	
		R	PCM*2	CUE*3			PCM*2	CUE*3	
	PCM	L/R	PCM*4	PCM*4			PCM*4	PCM*4	PCM*4
		L							PCM*5
		R							PCM*4

<Notes>

- *2: The PCM audio output is muted if the tape is played back at a speed in the −1.0× to +2.0× range (or at a speed in the −1.0× to +1.1× range for a format other than DVCPRO HD-LP).
- *3: In the case of the CUE audio output, the PCM signals are output if the tape is played back at a speed in the −1.0× to +2.0× range (or at a speed in the −1.0 to +1.1× range for a format other than DVCPRO HD-LP).
- *4: During fast forwarding or rewinding, the CUE signal is output automatically.
- *5: During fast forwarding or rewinding, this signal is muted.

Setup menus (continued)

<DIF>

No./Item	Description of setting
880* ¹ DIF SPEED	<p>For setting the transfer speed of the IEEE1394 digital interface output.</p> <p>0000 <u>S100</u> 100Mbps 0001 <u>S200</u> 200Mbps 0002 <u>S400</u> 400Mbps</p> <p><Note> When S100 has been selected as this item's setting, DVCPRO HD format signals cannot be input or output.</p>
882* ¹ DIF IN CH	<p>For setting the input channel.</p> <p>0000 0 : 0063 63</p> <p>The input channel is fixed at the channel corresponding to the number specified.</p> <p>0064 <u>AUTO</u> The input channel is not fixed at the channel corresponding to the number specified. The input channel is initialized to 63 when the power is turned on.</p>
883* ¹ DIF OUT CH	<p>For setting the output channel.</p> <p>0000 0 : 0063 63</p> <p>The input channel is fixed at the channel corresponding to the number specified.</p> <p>0064 <u>AUTO</u> The output channel is not fixed at the channel corresponding to the number specified. The output channel is initialized to 63 when the power is turned on.</p>
886* ¹ DIF CONFIG	<p>Menu item for expansion purposes. Normally, use DFLT as the setting.</p> <p>0000 <u>DFLT</u> 0001 1 : 0255 255</p>
890* ¹ DIF AUD OUT	<p>For setting the audio channels to which the signals from the IEEE1394 digital interface are to be output in the DV format when a DVCPRO HD tape or 50M format tape is played back or when a DV tape in 4ch mode is played by the audio signals and menu No. 891 DIF DV AUDIO is set to "LOCK48."</p> <p>0000 <u>CH1/2</u> CH1 and CH2 0001 <u>CH3/4</u> CH3 and CH4</p>
891* ¹ DIF DV AUDIO	<p>For setting forcible audio mode conversion when a DV tape is played back and the audio signals are output in the DV format.</p> <p>0000 <u>THRU</u> Normal setting (the signals simply pass through). 0001 <u>LOCK</u> Forcible conversion to the LOCK mode (no frequency conversion) 0002 <u>LOCK48</u> Forcible conversion to 48kHz/2CH/LOCK.</p>

*1 When the 23/24 Hz mode, 25 Hz (HD, SD) mode, or the 50 Hz (HD, SD) mode is selected in System Menu No. 25 (SYSTEM FREQ), this item is not displayed.

No./Item	Description of setting
892* ¹ DIF SIG CMD	<p>For setting how to reply when signals requesting a confirmation of the format is sent from an external device connected by the IEEE1394 digital interface.</p> <p>0000 <u>50M</u> DVDPRO50 is forcibly returned. 0001 <u>25M</u> DVDPRO is forcibly returned. 0002 <u>DV</u> DV is forcibly returned. 0003 <u>AUTO</u> The reply is the same format as the signal format output from the IEEE1394 digital interface.</p> <p><Note> When the unit is connected to a non-linear editing system using 50M, 25M, and DV signal format, the non-linear editing system may not operate properly. In this case, change the setting to return format information corresponding to the connected signal format in this menu and then start the system.</p>
894* ¹ HD → DIF OUT	<p>For setting the format of the signals to be output from the IEEE1394 digital interface in the EE mode, in recording or when a DVCPRO HD tape is played back.</p> <p>0000 <u>HD</u> DVCPRO HD 0001 <u>50M</u> DVCPRO50 0002 <u>DV</u> DV</p> <p><Note> When SD SDI is selected in Setup menu No. 600 (VIDEO IN SEL) and cross-conversion is provided, data will be output in the format selected in Setup menu No. 020 (SYS FORMAT) regardless of this menu selection.</p>
895* ¹ 50M → DIF OUT	<p>For setting the format of the signals to be output from the IEEE1394 digital interface when a 50M format tape is played back.</p> <p>0000 <u>50M</u> DVCPRO50 0001 <u>DV</u> DV</p> <p><Note> When DV is selected as this item's setting, the closed caption signals and time code (VITC) signals in the vertical blanking period are transmitted, but none of the other signals in the vertical blanking period are transmitted.</p>
896* ¹ 25M → DIF OUT	<p>For setting the format of the signals to be output from the IEEE1394 digital interface when a 25M format tape is played back.</p> <p>0000 <u>25M</u> DVCPRO 0001 <u>DV</u> DV</p>
899* ¹ DIF SUPER	<p>For setting whether the superimposed display is to be output from the IEEE1394 digital interface when the format is converted (from HD to 50M, from HD to DV, from 50M to DV or from 25M to DV).</p> <p>0000 <u>OFF</u> The superimposed text is not displayed. 0001 <u>ON</u> The superimposed text is displayed.</p> <p><Note> Only TCR is displayed.</p>

The underlining () denotes the factory setting mode.

Setup menus (continued)

<MENU>

No./Item	Description of setting
A02 P. ON LOAD	<p>This VTR is equipped with VTR MEMORY [C] for storing the current settings (All of the set values in the SETUP MENU, the contents of the registered items in the PF1/PF2 menu, some of the contents of the function buttons) and VTR MEMORY [1] to [4] for backing up VTR MEMORY [C]. Only the SETUP MENU of the selected VTR MEMORY [1] to [4] can be loaded and started on the VTR MEMORY [C].</p> <p>0000 OFF Operation is started using the previous settings.</p> <p>0001 USER1 The VTR MEMORY [1] data is loaded and operation started on the basis of this data.</p> <p>0002 USER2 The VTR MEMORY [2] data is loaded and operation started on the basis of this data.</p> <p>0003 USER3 The VTR MEMORY [3] data is loaded and operation started on the basis of this data.</p> <p>0004 USER4 The VTR MEMORY [4] data is loaded and operation started on the basis of this data.</p>

<Connections with Dolby-E* components>

When the VTR is to be connected to a Dolby-E encoder/decoder for recording or playing back Dolby-E data, set the audio input and output levels to UNITY, and select the following setup menu item settings.

No.303 AUD EDIT IN = CUT
 No.304 AUD EDIT OUT = CUT
 No.725 REC CH1 = CH1
 No.726 REC CH2 = CH2
 No.727 REC CH3 = CH3
 No.728 REC CH4 = CH4
 No.729 REC CH5 = CH5
 No.730 REC CH6 = CH6
 No.731 REC CH7 = CH7
 No.732 REC CH8 = CH8
 No.734 PB FADE = CUT
 No.758 JOG PROC = OFF
 No.762 AUD RATE CON = OFF

<Notes>

- Synchronize all devices in the system with the REF signal designated by the Dolby-E device.
- Dolby-E data cannot be recorded or played back in the 60 Hz mode.
- Adjust the timing with the video signals to cover the time taken by the Dolby-E component for encoding/decoding outside the VTR.
- Set the bit depth of the Dolby-E encoder/decoder to 16 bits.
- Noise will be output from the ANALOG AUDIO OUT connectors of the channels through which the Dolby-E data is passing.
- The audio level meter will deflect beyond the range of its markings for those channels through which the Dolby-E data is passing.
- Noise will be output when a tape on which Dolby-E data has been recorded is played back in the JOG or VAR mode.

* Dolby and the Double D symbol  are trademarks of Dolby Laboratories Licensing Corporation.

Setup menus (continued)

<How to switch the system frequency>

Follow the steps below to switch the system frequency [59/60 Hz, 50 Hz, 23/24 Hz, 25 Hz (HD) or 25 Hz (SD), 50 Hz(HD), 50 Hz(SD)].

- 1 Following the procedure for the <SETUP MENU/ SYSTEM MENU> (page 62) to change the system menu item No.25 (SYSTEM FREQ) setting.
- 2 Press **[F5]** (SET) to enter the setting, and after the function menu shown on the time code display area has been cleared, the following message appears.

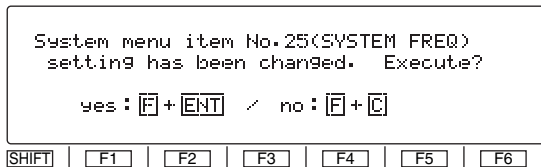

- 3 To make the setting entered in step 2 valid, press the **[F]** button while holding down the **[ENT]** button. The system is restarted, and the VTR starts operating in the selected mode.

- 4 To cancel the setting entered in step 2, press the **[C]** button while holding down the **[F]** button. The above message is cleared, and after the changed setting has been restored to the original system menu No.25 (SYSTEM FREQ) setting, operation returns to the SYSTEM menu operation screen.

<Note>

If the system menu No.25 (SYSTEM FREQ) setting has been changed while a cassette is inserted in the VTR, the cassette is automatically ejected.

The same procedure as above is also followed when the system menu No.25 (SYSTEM FREQ) setting has been changed by loading the data from an SD memory card in accordance with the <CARD> procedure (page 71).

Note that even if the change being made to the system menu item No. 25 setting is cancelled, other system menu items affected by the change will be updated, as will the associated file names.

<Selecting the recording/playback format and sync signals which support the operation mode>

No.25 SYSTEM FREQ	Format enabling recording	Format enabling playback	Sync signals
59/60	1080/59.94i (HD_LP) 720/59.94p (HD_LP) 720/60.00p (HD_LP)	1080/59.94i (HD_LP, HD_SP) 1080/60i (HD_LP, HD_SP) 720/59.94p(HD_LP, HD_SP) 720/60.00p (HD_LP, HD_SP) 480/59.94i (50M, 25M, DV, DVCAM)	HD_REF (59.94Hz, 60Hz) SD_REF (59.94Hz) The setting selected for setup menu item No.031 (OUT REF) applies.
50i/25P	1080/50i (HD_LP) 720/50p (HD_LP)	1080/50i (HD_LP, HD_SP) 720/50p (HD_LP) 576/50i (50M, 25M, DV, DVCAM) 576/25p over 50i (50M, 25M, DV)	HD_REF (50Hz) SD_REF (50Hz) The setting selected for setup menu item No.031 (OUT REF) applies.
23/24	None	1080/23.98p over 59.94i (HD_LP) 720/23.98p over 59.94p (HD_LP/HD_SP) 720/24p over 60.00p (HD_LP/HD_SP) 480/23.98p over 59.94i [2:3 mode] 480/23.98p over 59.94i [2:3:3:2 advance mode]	HD_REF (47.96Hz, 48Hz)
25 (HD)	None	720/25p over 60p 720/24p over 60p	HD_REF (50Hz) SD_REF (50Hz) The setting selected for setup menu item No.031 (OUT REF) applies.
25 (SD)	None	720/25p over 60p	SD_REF (50Hz)
50 (HD)	None	720/50p over 60p	HD_REF (50Hz) SD_REF (50Hz) The setting selected for setup menu item No.031 (OUT REF) applies.
50 (SD)	None	720/50p over 60p	SD_REF (50Hz)

Setup menus (continued)

<Menu management accompanying switching the system frequency>

The system menu and setup menu have some items whose settings differ and other items with which no selection options are displayed and whose settings are fixed, depending on the switching of the operation mode in response to the setting selected for system menu item No.25 (SYSTEM FREQ). (Refer to the table below.)

System menu and setup menu settings

- Each of the items whose settings differ is saved in the VTR MEMORY (current file and one of the backup files 1 to 4). The settings that correspond to each operation mode will be displayed so that the settings can be performed for each operation mode.

Registration of the <PF1> and <PF2> function buttons

- When the items whose settings differ have been registered in the <PF1> and <PF2> function buttons, the settings that correspond to each operation mode will be displayed so that the settings can be performed for each operation mode.
- If items, whose selection options are not displayed due to the operation mode, have been registered in the <PF1> or <PF2> function button, when an operation mode in which these options are not displayed is selected, what has been registered is saved but the function button itself will become blank and cannot be operated. Note that the registered contents on items that are not displayed will be deleted during the following operations.
 - When the set value in Setup Menu No. 600 (VIDEO IN SEL) changes from SD SDI to another set value or from another set value to SD SDI.
 - When the set value in Setup Menu No. 650 (STYLE) changes.

<50P IN/OUT> 50-pin connector registration

- When the items whose settings differ have been registered in the <50P IN/OUT> 50-pin connector pins, the settings corresponding to the operation modes are allocated to the IN and OUT pins on the basis of the setting numbers. However, when the upper limit value is exceeded, the value will be limited to this upper limit. What has been registered is saved, but bear in mind that when the data is registered again, it is saved by overwriting the existing data so that the previously registered data will be lost.
- If items, whose selection options are not displayed due to the operation mode, have been registered in the <50P IN/OUT> 50-pin connector, when an operation mode in which these options are not displayed is selected, what has been registered is saved but no operation is possible. Note that the registered contents on items that are not displayed will be deleted during the following operations.
 - When the set value in Setup Menu No. 600 (VIDEO IN SEL) changes from SD SDI to another set value, or from another set value to SD SDI,
 - When the set value in Setup Menu No. 650 (STYLE) changes.

<Menus which are displayed>

The menus displayed differ depending on the setting selected for menu item No.25 SYSTEM FREQ.

NO.	Menu item	System menu No.25 (SYSTEM FREQ)						
		59/60	23/24	50i/25P	25 (HD)	25 (SD)	50 (HD)	50 (SD)
05	ENCODER SEL							
06	V LEVEL CTRL							
12	SYS H (HD)							
14	SYS SC (SD)							
15	VO SYS H (SD)							
16	SD SYS H (SD)							
18	SCH (SD)							
20	AV PHASE							
25	SYSTEM FREQ							
26	HD SYS H ADV		No	No	No	No	No	No
30	MENU LOCK							
000	P-ROLL TIME							
001	LOCAL ENA							
002	TAPE TIMER		No		No	No	No	No
003	REMAIN SEL							
004	SYNCHRONIZE		No		No	No	No	No
005	SUPER							
006	DISPLAY SEL							
007	CHARA H-POS							
008	CHARA V-POS							
009	CHARA TYPE							
010	MONI CONTROL		No		No	No	No	No
011	CU-ROLL TIME							

Setup menus (continued)

NO.	Menu item	System menu No.25 (SYSTEM FREQ)						
		59/60	23/24	50i/25P	25 (HD)	25 (SD)	50 (HD)	50 (SD)
015	AUTO STEP							
020	SYS FORMAT		No		No	No	No	No
022	PB FORMAT							
023	FORMAT SEL							
030	HD FREQUENCY			No	No	No	No	No
031	OUT REF		No					
100	SEARCH ENA							
101	SHTL MAX							
102	FF. REW MAX							
104	REF ALARM							
105	AUTO EE SEL		No		No	No	No	No
106	EJECT EE SEL							
107	EE MODE SEL		No		No	No	No	No
108	PLAY DELAY							
109	CAP. LOCK		No		No	No	No	No
110	AUTO REW							
111	MEMORY STOP		No		No	No	No	No
112	FRZ MODE SEL							
113	REC INH		No		No	No	No	No
114	REC INH LAMP							
115	EJECT SW INH		No		No	No	No	No
116	EJECT JUMP							
118	SP MODE INH		No		No	No	No	No
119	CONFI REC		No		No	No	No	No
131	PAGE MODE							
132	ROTA MODE							
133	KEY BEEP							
134	ALARM BEEP							
140	OUTPUT		No		No	No	No	No
141	VOLUME		No		No	No	No	No
142	AUDIO UNITY		No		No	No	No	No
143	CASSTT LIGHT							
144	TC INPUT							
145	FRONT LCD							
146	SAVER DISP							
200	PARA RUN							
202	ID SEL							
204	RS232C SEL							
205	BAUD RATE							
206	DATA LENGTH							
207	STOP BIT							
208	PARITY							
209	RETURN ACK							
212	MASTER PORT							
300	IN/OUT DEL							
301	NEGA FRASH							
302	CONFI EDIT		No		No	No	No	No
303	AUD EDIT IN		No		No	No	No	No
304	AUD EDIT OUT		No		No	No	No	No
305	AUTO ENTRY							
306	CF ADJ SEL		No		No	No	No	No
307	AFTER CUE-UP							
308	VAR FWD MAX							
309	VAR REV MAX							
310	JOG FWD MAX							
311	JOG REV MAX							

Setup menus (continued)

NO.	Menu item	System menu No.25 (SYSTEM FREQ)						
		59/60	23/24	50i/25P	25 (HD)	25 (SD)	50 (HD)	50 (SD)
312	POSTROLL TM		No		No	No	No	No
313	CLICK POINT							
320	EDIT RPLCE1		No		No	No	No	No
321	EDIT RPLCE2		No		No	No	No	No
322	EDIT RPLCE3		No		No	No	No	No
323	EDIT RPLCE4		No		No	No	No	No
324	EDIT RPLCEC		No		No	No	No	No
400	STILL TIMER							
401	SRC PROTECT							
402	DRUM STDBY							
403	STOP PROTECT							
500	VITC BLANK		No		No		No	
501	VITC POS-1		No		No		No	
502	VITC POS-2		No		No		No	
503	TCG MODE		No		No	No	No	No
504	RUN MODE		No		No	No	No	No
505	TCG REGEN		No		No	No	No	No
506	REGEN MODE		No		No	No	No	No
507	TC SOURCE		No		No	No	No	No
508	BINARY GP		No		No	No	No	No
509	PHASE CORR							
510	TCG CF FLAG		No		No	No	No	No
511	DF MODE		No	No	No	No	No	No
512	TC OUT REF		No		No	No	No	No
513	VITC OUT							
514	HD EMBD VITC					No		No
515	HD EMBD LTC					No		No
516	TC OUT ADV		No		No	No	No	No
517	TCG OUT		No		No	No	No	No
600	VIDEO IN SEL		No		No	No	No	No
601	VIDEO INT SG		No		No	No	No	No
602	SDI IN MODE		No		No	No	No	No
603	V-MUTE SEL							
604	FREEZE SEL		No		No	No	No	No
605	INTERPOLATE		No		No	No	No	No
606	SD MON O SEL							
619	V_FILTER	No	No	No	No		No	No
620	DOWNCON MODE				No		No	
621	UPCON MODE				No	No	No	No
622	D/C RESP H							
623	D/C RESP V							
624	U/C RESP H				No	No	No	No
625	U/C RESP V				No	No	No	No
626	D/C ENH H							
627	D/C ENH V							
628	U/C ENH H				No	No	No	No
629	U/C ENH V				No	No	No	No
630	1080i→HD_OUT		No		No	No	No	No
632	720p→HD_OUT		No		No	No		No
636	SD→HD_OUT		No		No	No	No	No
638	IN U/C MODE		No		No	No	No	No
639	I U/C RESP H		No		No	No	No	No
640	I U/C RESP V		No		No	No	No	No
641	I U/C ENH H		No		No	No	No	No
642	I U/C ENH V		No		No	No	No	No
643	IN BLK LINE		No	No	No	No	No	No
650	STYLE							
651	HUE STYLE (SD)			No	No	No	No	No
653	Y LVL (HD)							

Setup menus (continued)

NO.	Menu item	System menu No.25 (SYSTEM FREQ)						
		59/60	23/24	50i/25P	25 (HD)	25 (SD)	50 (HD)	50 (SD)
654	Pb LVL (HD)							
655	Pr LVL (HD)							
656	BK LVL (HD)							
658	Y LVL (SD)							
659	Pb LVL (SD)							
660	Pr LVL (SD)							
661	BK LVL (SD)							
662	V LEVEL							
663	C LEVEL							
664	HUE (AJ-HD1800P)/C PHASE (AJ-HD1800E)							
665	SETUP LVL (AJ-HD1800P)/BK LVL (AJ-HD1800E)							
670	BRIGHTNESS							
671	COLOR LEVEL							
672	CONTRAST							
673	BACKLIGHT							
676	BLK CLIP			No	No	No	No	No
680	CC (F1) BLANK		No	No	No	No	No	No
681	CC (F2) BLANK		No	No	No	No	No	No
682	VO SETUP (HD) (Only AJ-HD1800P)			No	No	No	No	No
683	VO SETUP (SD) (Only AJ-HD1800P)			No	No	No	No	No
684	EDH (SD)							
685	ESR MODE (SD)			No	No	No	No	No
686	CCR MODE (SD)			No	No	No	No	No
687	SDI INDEX 0		No		No		No	
688	CC REC		No	No	No	No	No	No
689	COMP MODE		No		No	No	No	No
690	UMID REC		No		No	No	No	No
691	UMID GEN		No		No	No	No	No
692	UMID POS		No		No	No	No	No
693	GAMMA SEL							
695	BLANK LINE		No		No	No	No	No
700	CH1 IN LV		No		No	No	No	No
701	CH2 IN LV		No		No	No	No	No
702	CH3 IN LV		No		No	No	No	No
703	CH4 IN LV		No		No	No	No	No
704	CUE IN LV		No		No	No	No	No
705	CH1 OUT LV							
706	CH2 OUT LV							
707	CH3 OUT LV							
708	CH4 OUT LV							
709	CUE OUT LV							
710	MONIL OUT LV							
711	MONIR OUT LV							
712	MONI OUT							
713	CH1 IN SEL		No		No	No	No	No
714	CH2 IN SEL		No		No	No	No	No
715	CH3 IN SEL		No		No	No	No	No
716	CH4 IN SEL		No		No	No	No	No
717	CH5 IN SEL		No		No	No	No	No
718	CH6 IN SEL		No		No	No	No	No
719	CH7 IN SEL		No		No	No	No	No
720	CH8 IN SEL		No		No	No	No	No
721	D IN SEL12		No		No	No	No	No
722	D IN SEL34		No		No	No	No	No
723	D IN SEL56		No		No	No	No	No
724	D IN SEL78		No		No	No	No	No
725	REC CH1		No		No	No	No	No
726	REC CH2		No		No	No	No	No
727	REC CH3		No		No	No	No	No

Setup menus (continued)

NO.	Menu item	System menu No.25 (SYSTEM FREQ)						
		59/60	23/24	50i/25P	25 (HD)	25 (SD)	50 (HD)	50 (SD)
728	REC CH4		No		No	No	No	No
729	REC CH5		No		No	No	No	No
730	REC CH6		No		No	No	No	No
731	REC CH7		No		No	No	No	No
732	REC CH8		No		No	No	No	No
733	REC CUE		No		No	No	No	No
734	PB FADE		No		No	No	No	No
735	HD EMBD AUD							
736	SD EMBD AUD							
737	MONI MIX							
738	CH1 CUE SEL							
739	CH2 CUE SEL							
740	CH3 CUE SEL							
741	CH4 CUE SEL							
742	CH5 CUE SEL							
743	CH6 CUE SEL							
744	CH7 CUE SEL							
745	CH8 CUE SEL							
746	MONI CH SEL							
747	MON AUTO SEL							
748	MON SEL INH							
749	AUDIO PB VR		No		No	No	No	No
750	ANA CH1 SEL							
751	ANA CH2 SEL							
752	ANA CH3 SEL							
753	ANA CH4 SEL							
754	SD SDI CH1 SL							
755	SD SDI CH2 SL							
756	SD SDI CH3 SL							
757	SD SDI CH4 SL							
758	JOG PROC							
759	DV PB ATT				No	No	No	No
760	REC PT MUTE		No		No	No	No	No
761	AUDIN INT SG		No		No	No	No	No
762	AUD RATE CON							
763	METER SCALE (Only AJ-HD1800P)							
776	REF LEVEL							
785	IN IMP CH1SL		No		No	No	No	No
786	IN IMP CH2SL		No		No	No	No	No
787	IN IMP CH3SL		No		No	No	No	No
788	IN IMP CH4SL		No		No	No	No	No
789	IN IMP CUE SL		No		No	No	No	No
790	CUE REC VOL		No		No	No	No	No
791	CUE PB VOL							
880	DIF SPEED		No		No	No	No	No
882	DIF IN CH		No		No	No	No	No
883	DIF OUT CH		No		No	No	No	No
886	DIF CONFIG		No		No	No	No	No
890	DIF AUD OUT		No		No	No	No	No
891	DIF DV AUDIO		No		No	No	No	No
892	DIF SIG CMD		No		No	No	No	No
894	HD→DIF OUT		No		No	No	No	No
895	50M→DIF OUT		No		No	No	No	No
896	25M→DIF OUT		No		No	No	No	No
899	DIF SUPER		No		No	No	No	No
A02	P. ON LOAD							

Time code and user bits

Time code

The time code is used when the time code signal generated by the time code generator (time code signal generator) is to be recorded on the tape, its values are to be read by the time code reader (time code signal reader), and the absolute position of the tape is to be displayed in increments of hours, minutes, seconds and frames.

The time code is written in the sub-code area (data area) of the helical track. This enables insert editing to be conducted independently using the time code alone. In addition, the VTR's playback speed can be read from the stop mode to the slow motion playback up to high-speed playback (approx. 50× normal speed or approx. 100× normal speed when using a DVCPRO tape).

The time code values are indicated on the display and superimposed display.

TCR 00 : 07 : 04 : 23
↑ ↑ ↑ ↑
Hours Minutes Seconds Frames

User bits

The "user bits" refers to the 32-bit (8-digit) data frame among the time code signals which has been released to users. It enables operator numbers and other values to be recorded. The alphanumeric characters which can be used for the user bits are number 0 to 9 and letters A to F.

Setting the internal time code

- 1 Set the VTR to the stop mode.
- 2 Set **[F3]** TC/CTL on the <HOME> menu to TC.
- 3 Set **[F1]** SOURCE on the <TC> menu to INT (for selecting the internal time code).
- 4 Setting **[F5]** RUN MD on the <TC> menu
REC:
The time code advances simultaneously with the recording.
FREE:
The time code advances, like time, irrespective of the VTR operation.
- 5 Setting **[F3]** TCG MD on the <TC> menu
REGEN:
The continuity of the underlying time code in place prior to editing is maintained.
PRE:
The time code can be preset using the operation panel controls or remote controller.
AUTO:
The time code is automatically switched to REGEN or PRE depending on the VTR's operation mode: during editing, REGEN is selected; at all other times, PRE is selected.
- 6 Registering the TC preset values
Display the <HOME> menu.
<TC/UB>
● **Preset (in the preset enable status)**
 - ① When **[T]** among the number keys is pressed, the TC display switches to TCG (UBG), and the TCG value characters (all digits) are highlighted.
 - ② When **[T]** is pressed again, one digit is highlighted, and the change enable status is established.
 - ③ Input the desired value using the number keys.
The entire input value can be cleared by pressing **[0]** while **[F]** holding down .
 - ④ To input the letters used with the users bits, press **[F]** the same number key (toggle by tapping **[7]** or **[8]**) while holding down . To move from one digit to another, turn the ADJ dial.
 - ⑤ To enter the value, press the **[ENT]** key.
 - ⑥ When the display screen has been changed during the input process or if the **[C]** button has been pressed, the change enable status is released, and the setting is canceled.**<CTL>**
● **Reset**
Press **[F4]** (TC CLR).

Setting the external time code

- 1 Set the VTR to the stop mode.
- 2 Set **[F3]** TC/CTL on the <HOME> menu to TC.
- 3 If the video input has been set to HD SDI input or INT SG, set **[F1]** TC SRC on the <TC> menu to EXT-L, SLTC or SVITC.
- 4 If the video input has been set to SD SDI, set **[F1]** TC SRC on the <TC> menu to EXT-L or VITC.

<Note>

When 1394 is set for video input, the time code for 1394 input is selected regardless of the selection in **[F1]** TC SRC.

Cue time registration, preroll and cue-up (These functions work only on the HOME, PF1 and PF2 screens.)

● Registration

Register the cue time by pressing the **[SET]** button while holding down the **[F]** button.

● Presetting

When the **[T]** button is pressed, the characters of the cue time or TC/UB display are highlighted. Turn the ADJUST dial to highlight the characters of the cue time.

The subsequent steps in the registration procedure are the same as for TCG.

● Prerolling

Press the PREROLL button to preroll the tape to the currently registered CUE point.

● Queue up

Press the PREROLL button while pressing the **[F]** button to queue up to the currently registered cue point.

Time code and user bits playback

- 1 Set the VTR to the stop mode.
- 2 Set **[F3]** TC/CTL on the <HOME> menu to TC or UB.
TC:
The time code is displayed.
UB:
The user bits are displayed.
 - In the event that it has become impossible to read the time code, it is interpolated using the CTL signal.
- 3 Press the PLAY button.
Playback starts, and the time code appears on the display.
If **[F3]** (SUPER) on the <TC SHIFT> menu is set to ON, the time code value is superimposed onto the video signals from the VIDEO OUT3 connector.

<Notes>

- While a drop frame time code is being read, the colon between the seconds and frames is replaced with a period.
- If the time code signal is missing, it is interpolated automatically using the CTL signal. The following appears on the display.

T * R 00:01:04:07 *

An asterisk (*) appears here if the time code signal is missing.

“:”: 1st, 3rd field
“*”: 2nd, 4th fields
(It is not displayed when the speed exceeds $\pm 0.3 \times$ speed.)

In the drop frame mode, the colon between the seconds and frames is replaced with a period. (In the 59/60 Hz mode only)

Time code and user bits (continued)

Time code recorded on the unit

Menu No. 507 TC SOURCE	Video input signal selection	Time code to be recorded		
		SBC area	VAUX area	
INT	INT SG	Internal TCG value (refer to the table 1)		Not recorded
	HD SDI			SVITC *3 of the input video signal
	SD SDI			VITC *3 of the input video signal
	1394			Time code for the IEEE 1394 digital input (VAUX area)
EXT_L	INT SG	Time code for the TIME CODE IN connector input *1 (refer to the table 2)		Not recorded
	HD SDI			SVITC *3 of the input video signal
	SD SDI			VITC *3 of the input video signal
	1394			Time code for the IEEE 1394 digital input (SBC area)
SLTC (VITC when SD SDI is selected *4)	INT SG	Internal TCG value (refer to the table 1)		Not recorded
	HD SDI	SLTC of the input video signal *2	(refer to the table 2)	SVITC *3 of the input video signal
	SD SDI	VITC of the input video signal *2		VITC *3 of the input video signal
	1394	Time code for the IEEE 1394 digital input (SBC area)		Time code for the IEEE 1394 digital input (VAUX area)
SVITC (VITC when SD SDI is selected *4)	INT SG	Internal TCG value (refer to the table 1)		Not recorded
	HD SDI	SVITC of the input video signal *2	(refer to the table 2)	SVITC *3 of the input video signal
	SD SDI	VITC of the input video signal *2		VITC *3 of the input video signal
	1394	Time code for the IEEE 1394 digital input (SBC area)		Time code for the IEEE 1394 digital input (VAUX area)

*1 When no signal can be detected from the TIME CODE IN connector input, it is the internal TCG value.

*2 When no SLTC or SVITC can be detected from the input video signal, it is the internal TCG value.

*3 When no SVITC can be detected from the input video signal, nothing is recorded.

*4 When SD SDI is selected in the input selection, this becomes VITC. If the selected input signal is other than SD SDI and SLTC/SVITC is selected, VITC is selected when the input selection is set to SD SDI.

Time code and user bits (continued)

Time code recorded on the unit

Table 1

Menu			Time code to be recorded							
No.503 TCG MODE	No.505 TCG REGEN	No.506 REGEN MODE	At the time of normal recording		At the time of assemble editing		At the time of insert editing (time code selection)			
			TC	UB	TC	UB	TC	UB		
REGEN	TC&UB	---	INT_REGEN							
	TC		INT_REGEN	PRESET	INT_REGEN	PRESET	INT_REGEN	PRESET		
	UB		PRESET	INT_REGEN	PRESET	INT_REGEN	PRESET	INT_REGEN		
PRESET	---		PRESET							
AUTO	TC&UB	AS&IN	PRESET		INT_REGEN		INT_REGEN			
		ASSEM			PRESET		PRESET			
		INSRT			PRESET		INT_REGEN			
	TC	AS&IN	PRESET	INT_REGEN	PRESET	INT_REGEN	PRESET	PRESET		
		ASSEM		PRESET		INT_REGEN				
		INSRT		PRESET		INT_REGEN				
	UB	AS&IN	PRESET	REGEN						
		ASSEM		INT_REGEN		PRESET				
		INSRT		PRESET		INT_REGEN				

Table 2

Menu			Time code to be recorded							
No.503 TCG MODE	No.505 TCG REGEN	No.506 REGEN MODE	At the time of normal recording		At the time of assemble editing		At the time of insert editing			
			TC	UB	TC	UB	TC	UB		
REGEN	TC&UB	---	EXT_REGEN							
	TC		EXT_REGEN	PRESET	EXT_REGEN	PRESET	EXT_REGEN	PRESET		
	UB		PRESET	EXT_REGEN	PRESET	EXT_REGEN	PRESET	EXT_REGEN		
PRESET	TC&UB		EXT_REGEN							
	TC		EXT_REGEN	PRESET	EXT_REGEN	PRESET	EXT_REGEN	PRESET		
	UB		PRESET	EXT_REGEN	PRESET	EXT_REGEN	PRESET	EXT_REGEN		
AUTO	TC&UB	AS&IN	EXT_REGEN		INT_REGEN		INT_REGEN			
		ASSEM			EXT_REGEN		EXT_REGEN			
		INSRT			EXT_REGEN		INT_REGEN			
	TC	AS&IN	EXT_REGEN	PRESET	INT_REGEN	PRESET	INT_REGEN	PRESET		
		ASSEM			EXT_REGEN		INT_REGEN			
		INSRT			PRESET		INT_REGEN			
	UB	AS&IN	PRESET	EXT_REGEN	INT_REGEN		INT_REGEN			
		ASSEM			PRESET		EXT_REGEN			
		INSRT			PRESET	EXT_REGEN	INT_REGEN			

Selecting the audio recording channels and monitor output

Audio recording channels

The audio channels can be selected as shown below using the AUDIO setup menu items.

Recording track	Signals recorded
CH1	CH1/CH2/CH3/CH4/ CH1+CH2/CH3+CH4
CH2	CH1/CH2/CH3/CH4/ CH1+CH2/CH3+CH4
CH3	CH1/CH2/CH3/CH4/ CH1+CH2/CH3+CH4
CH4	CH1/CH2/CH3/CH4/ CH1+CH2/CH3+CH4
CH5	CH5/CH6/CH7/CH8/ CH5+CH6/CH7+CH8
CH6	CH5/CH6/CH7/CH8/ CH5+CH6/CH7+CH8
CH7	CH5/CH6/CH7/CH8/ CH5+CH6/CH7+CH8
CH8	CH5/CH6/CH7/CH8/ CH5+CH6/CH7+CH8
CUE	CUE/CH1/CH2/CH3/CH4/CH5/CH6/CH7/CH8/ CH1+CH2/CH3+CH4/CH5+CH6/CH7+CH8 / CH1 - CH8

Monitor output channels

When **[F6]** (M MIX) on the <AUDIO SHIFT2> menu is set to L, R or L/R, the signals of a multiple number of channels can be mixed and output.

When the number key corresponding to the channel whose signals are to be monitored is pressed while the "L" (or "R") button is held down, that channel is selected, and its signals are displayed on the audio level meter. (The same steps can also be taken to de-select a channel which has already been selected.) However, only up to 2 channels among the CH1-CH4 channels and only up to 2 channels among the CH5-CH8 channels are selected.

(Examples: CH1 + CH3 + CH5 + CH8 can be selected but CH1 + CH2 + CH4 cannot be selected.)

MONITOR SELECT switches

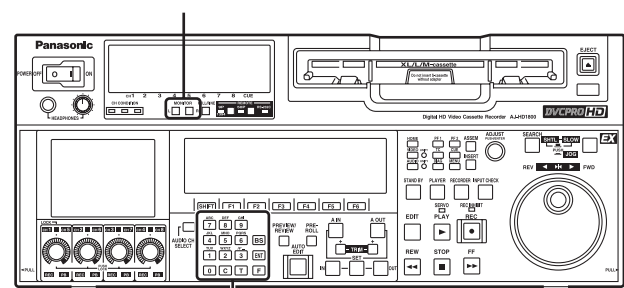

Number keys

Display saving function

This function is provided to extend the service life of the LCD monitor. It starts up if none of the front panel controls have been operated or the cassette tape has not been run at all for about 5 minutes.

While the saving function is working, the LCD monitor display goes blank, and the "EX" symbol appears on the time code display area. [The setting for displaying or not displaying the logo can be selected in Setup Menu No. 146 (SAVER DISP).]

To release the saving function, operate a button or dial on the front panel or issue a tape transport command from the controller. The operation performed to release the function will be executed after the function is released.

Rack mounting

The unit can be mounted into a 19-inch standard rack if the optional rack-mounting adapters (AJ-MA75P : option) are used. For the installation rails, it is recommended that the rail and bracket for 18-inch length (part number C-300-S-118) of Chassis Trak be used.

(The complete slide rail and bracket unit is not available from Panasonic.)

For further details, consult your dealer.

- 1 Attach the inner members of the slide rails. Refer to the figure below for the positions where they are screwed into place.

Positions where the right (R) inner member is screwed into place

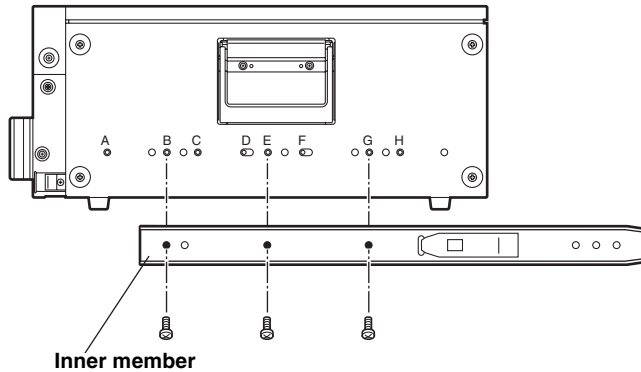

<Notes>

- The length of the screws used is subject to a restriction. Use screws which are less than 2/5 inch (10 mm) long.
- Attach the inner member at the same symmetrical positions on the left (L) side as well.
- Fix the members in place using 3 screws on each side (total: 6 screws).
- The letters shown in the figure are not actually marked on the side panels.

- 2 Attach the outer member brackets to the rack. Check that the height is the same for the left and right brackets.
- 3 Remove the four screws at the front used to attach the left and right side panels.

- 4 Attach the AJ-MA75P rack-mounting adapters using the same four screws.

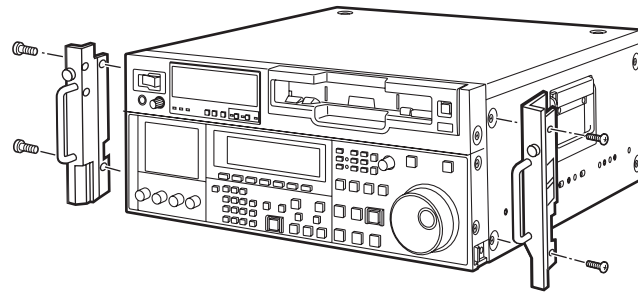

Rack-mounting adapters

- 5 Remove the four rubber feet on the bottom panel of the VTR, and install the VTR in the rack. After the VTR has been installed, check that it moves smoothly along the rails.

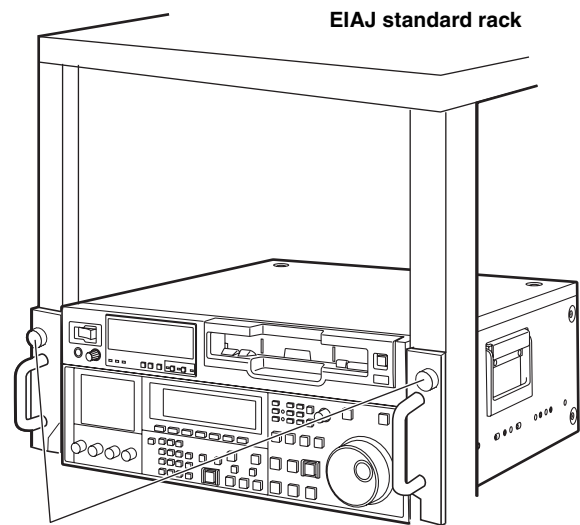

Fasten to rack with the fixing screws.

<CAUTIONS>

- Keep the temperature inside the rack to between 5°C and 40°C (41°F and 104°F).
- Bolt the rack securely to the floor so that it will not topple over when the VTR is pulled out.

Video head cleaning

This VTR is equipped with an auto head cleaning function which automatically reduces the amount of dirt on the video heads. In order to maximize the VTR's reliability, however, it is recommended that the video heads be cleaned as and when appropriate.

For further details on how to actually clean the heads, consult with one of Panasonic's service companies or with your dealer.

Condensation

Condensation occurs due to the same principle which is involved when droplets of water form on a window pane of a heated room. It occurs when the VTR or tape is moved between places where the temperature or humidity varies greatly or when, for instance:

- It is moved to a very humid place full of steam or a room immediately after it has been heated up.
- It is suddenly moved from a cold location to a hot or humid location.

After moving the VTR to such a location, leave it standing for about 10 minutes rather than switching on its power immediately.

If condensation has formed on or in the VTR, the AUTO OFF lamp lights, and the cassette tape is automatically ejected. Keep the power supplied and simply wait until the AUTO OFF lamp goes off. It is recommended that the video heads be cleaned after the AUTO OFF lamp has gone off.

Maintenance

Before proceeding with maintenance, be absolutely sure to set the power switch to OFF and take hold of the power plug and unplug it from the power outlet.

Use a soft cloth to clean the cabinet. To remove stubborn dirt, dilute some kitchen detergent, dip a cloth into the solution, wring it out well, and wipe. After having removed the dirt, take up any remaining moisture using a dry cloth.

<Note>

Do not use alcohol, benzene, paint thinners or other solvents. They can discolor the external parts surfaces and remove the finish.

Error messages

When a warning occurs in this VTR, the warning lamp lights up.

When the DIAG menu is opened, a description of the warning will appear on the front panel LCD area and TV monitor. Also, when an abnormal operation is detected in this VTR, the AUTO OFF lamp lights up, and a message appears on the time code display area.

DIAG menu

This displays the VTR information.

The VTR information includes the warning information and hour-meter (usage time) information. The DIAG menu appears on the front panel LCD display or on a TV monitor when the TV monitor is connected to the VIDEO OUT3 connector in the VTR's connector area.

■ Display of DIAG menu

- 1 Press the DIAG button.
The DIAG menu screen is now displayed on the TV monitor.
- 2 Press the function button on the time code display.

F1	(WARN): To display the warning information
F2	(HOURS): To display the hour meter information
F3	(UMID): To display the UMID information
F4	(DIF1): To display the DIF status 1 information
F5	(DIF2): To display the DIF status 2 information

The hour meter information display can be scrolled with the ADJ dial.
- 3 To exit the DIAG menu, press any other direct menu button.

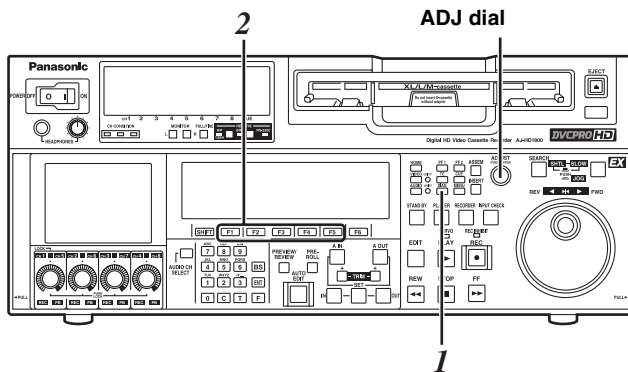

■ Displaying the warning information

- A warning message is displayed whenever a warning occurs (the warning lamp lights up). When no warnings have been detected, "NO WARNING" is displayed.
- When a multiple number of warnings occur, the descriptions of each warning can be checked by turning the ADJ dial.

Error messages (continued)

Warning messages

Priority	<ul style="list-style-type: none"> ● Display ● Description ● VTR operation and remedial action
Higher ↑	<p>E-92 1394 INITIAL ERROR This is displayed when the connections for the IEEE 1394 digital interface is invalid. VTR : The IEEE 1394 digital interface input/output is stopped.</p> <ul style="list-style-type: none"> ● When the cable is connected in a loop configuration, connect the cable again in a point-to-point configuration. If the cable is not connected in a loop configuration, turn the POWER switch from OFF to ON.
	<p>E-04 UNKNOWN SIG This is displayed when the input signal from the IEEE 1394 digital interface is not in the DVCPRO/DV format. VTR : The recording operation is disabled.</p> <ul style="list-style-type: none"> ● Confirm that 1394 input is connected properly.
	<p>E-90 NOT 1X 100M SIG This is displayed when the signal input into the IEEE 1394 digital interface is not at the 1X transfer speed in DVCPRO HD (100 Mbps) format. VTR : The recording operation is disabled.*1</p> <ul style="list-style-type: none"> ● Confirm the 1394 input signals.
	<p>E-16 INVALID VIDEO SIG This is displayed when the video signal input from the IEEE 1394 digital interface is invalid.</p> <ul style="list-style-type: none"> ● The warning is displayed during the recording operation only. In this case, the audio recording is muted. <p>VTR : The recording operation is disabled.*1</p> <ul style="list-style-type: none"> ● Confirm the 1394 input signals.
	<p>E-17 INVALID AUDIO SIG This is displayed when the audio signal input from the IEEE 1394 digital interface is invalid.</p> <ul style="list-style-type: none"> ● The warning is displayed during the recording operation only. In this case, the audio recording is muted. <p>VTR : The recording operation is disabled.*2</p> <ul style="list-style-type: none"> ● Confirm the 1394 input signals.
	<p>E-18 INVALID TC SIG This is displayed when the time code information from the IEEE 1394 digital interface is invalid.</p> <ul style="list-style-type: none"> ● The warning is displayed during the recording operation only. In this case, the time code generated internally is recorded. <p>VTR : The recording operation is disabled.*3</p> <ul style="list-style-type: none"> ● Confirm the 1394 input signals.
↓ Lower	<p>E-14 NO MATCH SIG This is displayed when the signal input into the IEEE 1394 digital interface has a different system format as the one set in the unit. VTR : The recording operation is disabled.*2</p> <ul style="list-style-type: none"> ● Confirm the 1394 input signals.

*1 The error indication is always displayed in EE mode. In this case, the black signals are recorded as the video signal and the audio signals are muted.

*2 The error indication is always displayed in EE mode. In this case, the audio signals are muted.

*3 The error indication is always displayed in EE mode. In this case, the time code for the internal time code generator of the unit is recorded as the time code signal.

Priority	<ul style="list-style-type: none"> ● Display ● Description ● VTR operation and remedial action
Higher ↑	<p>E-10 FAN STOP * Check that no foreign matter has accumulated on the fan. This is displayed when the fan motor has stopped. The name of the fan under abnormal conditions is displayed as indicated with an asterisk. Main: The main fan on the rear panel Power: The fan for the power supply on the rear panel Mecha: The fan built-in to the unit. VTR: Operation continues (and a warning beep is sounded regardless of the menu setting.) When the Main fan or the Power fan stops for 5 minutes or more, the power supply of the unit is forcibly turned OFF.</p> <ul style="list-style-type: none"> ● Check that no foreign matter has accumulated on the fan. ● Wait for several minutes after turning OFF the POWER switch and then turn it ON again.
	<p>E-09 NO RF This is displayed when a blank part of the tape lasting for 1 or more seconds has been detected during playback. When all of the following conditions have been met, it will be recognized as a blank part.</p> <ul style="list-style-type: none"> ● When no signals are output from any of the heads ● When the playback data cannot be read ● When the CTL signal is not present <p>VTR: Operation continues.</p> <ul style="list-style-type: none"> ● Check the tape. An unrecorded tape may have been inserted.
	<p>E-00 SERVO NOT LOCKED This is displayed when the servo is not locked for 3 or more seconds during playback, recording or editing. VTR: Operation continues.</p> <ul style="list-style-type: none"> ● Check the tape. A tape recorded using a system which does not allow playback may have been inserted.
	<p>E-93 INVALID TC MODE (in 23/24 Hz, 25 Hz (HD or SD) or 50 Hz (HD or SD) mode) This is displayed during playback if the time code has been recorded in the drop frame mode. The video output is disturbed and the audio output is muted at the time code drop point. The servo lock may be unlocked. VTR: Operation continues.</p> <ul style="list-style-type: none"> ● Check the tape. If a tape recorded using a variable frame rate camera is to be played back in this VTR, the time code must be recorded in the non-drop frame mode.
↓ Lower	<p>E-94 TC SEQUENCE UNMATCH (in 23/24 Hz, 25 Hz (HD or SD) or 50 Hz (HD or SD) mode) This is displayed during playback if the correlation between the active frame information and time code is irregular. The video output may not be uniform (the movements may not be smooth). VTR: Operation continues.</p> <ul style="list-style-type: none"> ● Check the tape. The active frame (first frame where the frame video is switched) information is recorded on a tape recorded using a variable frame rate camera. When such a tape is played back on this VTR, the 0 frame of the time code must be detected at the active frame position.

Error messages

Priority	<ul style="list-style-type: none"> ● Display ● Description ● VTR operation and remedial action
Higher ↑	<p>E-01 LOW RF This is indicated when the embed level of the video head during playback, recording, and editing is about 1/3 the normal level or less and is detected for 1 second or more, or when the CTL level of the A/C head is about 1/6 of the normal level or less and is detected for 1 second or more.</p> <ul style="list-style-type: none"> ● The CTL level is not detected when DV/DVCAM is played back. ● During recording and editing, only the embed level of simultaneous playback of video is detected. <p>VTR: Operation continues.</p> <ul style="list-style-type: none"> ● Execute the cleaning operation for the video and A/C heads.
↓ Lower	<p>E-02 HIGH ERROR RATE This is displayed when the error rate increases and correction or interpolation is performed for either the video or audio signals.</p> <p>VTR: Operation continues.</p> <ul style="list-style-type: none"> ● Clean the video heads.

Display	<ul style="list-style-type: none"> ● Description ● VTR operation and remedial action
E-20 DEW	<p>When condensation has been detected, the AUTO OFF lamp lights, the message display blinks, and the VTR transfers to the EJECT mode. After the tape has been ejected, the drum continues to rotate in order to dry out the condensation.</p> <p>When the condensation has cleared, the AUTO OFF lamp goes off, the message display is cleared, and the VTR is ready for operation again.</p> <ul style="list-style-type: none"> ● When condensation is detected in the EJECT mode, the drum starts rotating as soon as it is detected. ● When condensation is detected while a cassette is inserted, the drum stops rotating and starts rotating again after the tape has been ejected. <p>VTR: EJECT</p> <ul style="list-style-type: none"> ● Wait with the power on.
E-29 FRONT LOAD MOTOR	<p>If the cassette fails to move up even after 6 seconds have elapsed since the VTR transferred to the EJECT mode, the AUTO OFF lamp lights, and the message display blinks.</p> <p><Note> If the cassette fails to move down even after 6 seconds have elapsed since the cassette was inserted, the VTR transfers to the EJECT mode.</p> <p>VTR: Stops.</p> <ul style="list-style-type: none"> ● Set the POWER switch to OFF and then back to ON again.
E-31 LOADING MOTOR	<p>If the unloading operation fails to be completed within 6 seconds, the AUTO OFF lamp lights, and the message display blinks.</p> <p><Note> If the loading operation fails to be completed within 6 seconds, the VTR transfers to the EJECT mode (unloading mode).</p> <p>VTR: Stops.</p> <ul style="list-style-type: none"> ● Set the POWER switch to OFF and then back to ON again.
E-35 SERVO CONTROL ERROR	<p>When there is no response from the servo microcomputer for 1 or more seconds, the AUTO OFF lamp lights, and the message display blinks.</p> <p>VTR: Stops.</p> <ul style="list-style-type: none"> ● Set the POWER switch to OFF and then back to ON again.
E-37 SERVO COMM ERROR	<p>When the servo microcomputer does not follow the instructions of the system control microcomputer even after 10 seconds have elapsed, the AUTO OFF lamp lights, and the message display blinks.</p> <p>VTR: Stops.</p> <ul style="list-style-type: none"> ● Set the POWER switch to OFF and then back to ON again.

Error messages (continued)

Error messages (continued)

Display	<ul style="list-style-type: none"> ● Description ● VTR operation and remedial action
E-51 FRONT LOAD ERROR	<p>If the take-up reel has turned without engaging the tape for a specific period of time during the tape start or end processing operation while loading is being performed (at the half position), the AUTO OFF lamp lights, and the message display blinks.</p> <p>VTR: Stops.</p> <ul style="list-style-type: none"> ● Set the POWER switch to OFF and then back to ON again.
E-52 W-UP REEL NOT ROTA	<p>If, after the cassette has been inserted, the tape take-up reel has not wound up the tape while the total tape amount is not detected and while the tape is traveling, the AUTO OFF lamp lights, and the message display blinks.</p> <p>VTR: Stops.</p> <ul style="list-style-type: none"> ● Set the POWER switch to OFF and then back to ON again.
E-53 WINDUP ERROR	<p>If, after the total tape amount has been detected, the amount of tape wound up onto the take-up reel and the amount of tape supplied by the supply reel differ to an abnormal extent while the tape is traveling, the AUTO OFF lamp lights, and the message display blinks.</p> <p>VTR: Stops.</p> <ul style="list-style-type: none"> ● Set the POWER switch to OFF and then back to ON again.
E-55 UNLOAD ERROR	<p>If the tape has not been wound up during unloading, the AUTO OFF lamp lights, and the message display blinks.</p> <p>VTR: Stops.</p> <ul style="list-style-type: none"> ● Set the POWER switch to OFF and then back to ON again.
E-57 S-FF/REW TIMEOVER	<p>When the tape start or end processing operation is not completed, the AUTO OFF lamp lights, and the message display blinks.</p> <p>VTR: Stops.</p> <ul style="list-style-type: none"> ● Set the POWER switch to OFF and then back to ON again.
E-59 DRUM ROTA TOO SLOW	<p>If the rotational speed of the cylinder motor is abnormally slow, the AUTO OFF lamp lights, and the message display blinks.</p> <p>VTR: Stops.</p> <ul style="list-style-type: none"> ● Set the POWER switch to OFF and then back to ON again.
E-60 DRUM ROTA TOO FAST	<p>If the rotational speed of the cylinder motor is abnormally high, the AUTO OFF lamp lights, and the message display blinks.</p> <p>VTR: Stops.</p> <ul style="list-style-type: none"> ● Set the POWER switch to OFF and then back to ON again.
E-61 CAP ROTA TOO SLOW	<p>If the rotational speed of the cylinder motor is abnormally slow, the AUTO OFF lamp lights, and the message display blinks.</p> <p>VTR: Stops.</p> <ul style="list-style-type: none"> ● Set the POWER switch to OFF and then back to ON again.
E-64 S REEL ROTA TOO FAST	<p>If the supply reel motor rotates at an abnormally fast rate, the AUTO OFF lamp lights, and the message display blinks.</p> <p>VTR: Stops.</p> <ul style="list-style-type: none"> ● Set the POWER switch to OFF and then back to ON again.
E-67 T REEL ROTA TOO FAST	<p>If the take-up reel motor rotates at an abnormally fast rate, the AUTO OFF lamp lights, and the message display blinks.</p> <p>VTR: Stops.</p> <ul style="list-style-type: none"> ● Set the POWER switch to OFF and then back to ON again.

Display	<ul style="list-style-type: none"> ● Description ● VTR operation and remedial action
E-69 T REEL TORQUE ERR	<p>If an abnormal torque applied to the supply reel motor is detected or if an abnormal current flowing to the current-sensing resistor is detected, the AUTO OFF lamp lights, and the message display blinks.</p> <p>VTR: Stops.</p> <ul style="list-style-type: none"> ● Set the POWER switch to OFF and then back to ON again.
E-70 S REEL TORQUE ERR	<p>When the tape start or end processing operation is not completed, the AUTO OFF lamp lights, and the message display blinks.</p> <p>VTR: Stops.</p> <ul style="list-style-type: none"> ● Set the POWER switch to OFF and then back to ON again.
E-71 CAP TENSION ERROR	<p>If an abnormal tension is detected at the supply side in the capstan mode, the AUTO OFF lamp lights, and the message display blinks.</p> <p>VTR: Stops.</p> <ul style="list-style-type: none"> ● Set the POWER switch to OFF and then back to ON again.
E-72 REEL TENSION ERROR	<p>If an abnormal tension at the supply side is detected in the reel mode, the AUTO OFF lamp lights, and the message display blinks.</p> <p>VTR: Stops.</p> <ul style="list-style-type: none"> ● Set the POWER switch to OFF and then back to ON again.
E-73 REEL DIR UNMATCH	<p>If the take-up reel motor is running in the reverse direction, the AUTO OFF lamp lights, and the message display blinks.</p> <p>VTR: Stops.</p> <ul style="list-style-type: none"> ● Set the POWER switch to OFF and then back to ON again.
E-74 DRUM TORQUE ERROR	<p>If excess torque being applied to the cylinder motor is detected, this error number flashes on the display.</p> <p>VTR: Stops.</p> <ul style="list-style-type: none"> ● Set the POWER switch to OFF and then back to ON again.
E-FF	<p>If the tape start and tape end are detected at the same time either during or after loading, the AUTO OFF lamp lights, and the message display blinks.</p> <p>VTR: Stops.</p> <ul style="list-style-type: none"> ● Set the POWER switch to OFF and then back to ON again.

If the error message display persists even after the VTR has been shut down and started up again, consult your dealer.

RS-232C interface

The VTR can be operated by commands when the RS-232C interface is used. (Refer to the command tables on page 134.)

■ Condition for acknowledging commands from RS-232C interface

Setup menu item No.204

(RS232C SEL) : **ON**

If the above condition is not met,

[ACK]+[STX]ER001[EXT] is returned to the external component. Whether [ACK] is returned depends on the setting which has been selected for setup menu item No.209 (RETURN ACK).

Hardware specifications

External interface specifications

● Connector pin specifications

Connector: D-SUB 25-pin

(crossover cable supported)

Pin No.	Signal	Description
1	FG	Protective ground (frame ground)
2	RXD	Received data (data is sent to PC)
3	TXD	Transmitted data (data is received from PC)
4	CTS	Clear to send (shorted with pin 5)
5	RTS	Request to send (shorted with pin 4)
6	DTR	Data terminal ready (no processing)
7	SG	Signal ground
20	DSR	Data set ready (+ voltage output after communication enable status)

● Example of connection with controller (PC)

(Using crossover cable with D-SUB 25-pin connectors)

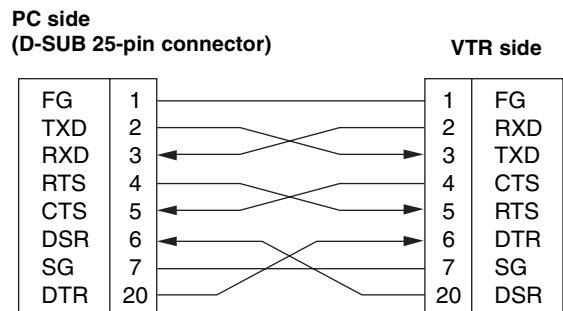

(Using crossover cable with D-SUB 9-pin and D-SUB 25-pin connectors)

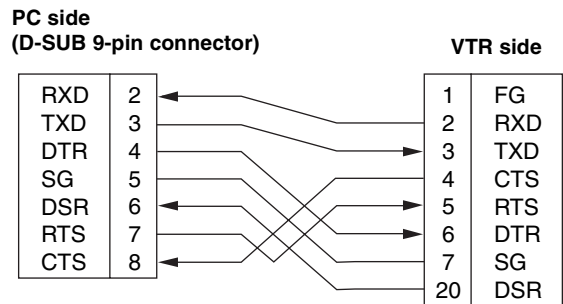

Software specifications (protocol)

1. Communication parameters

Communication system	Asynchronous, full duplex
Transfer rate	300, 600, 1200, 2400, 4800 or <u>9600</u> bps
Bit length	7 bits or <u>8 bits</u>
Stop bit	1 bit or 2 bits
Parity bit	<u>None</u> , odd or even
ACK code	<u>Returned</u> or not returned <Note> ACK is the code which is returned from the VTR to the controller when data has been successfully sent from the controller.

The underlining () denotes the factory setting mode.

The settings can be changed in the following Setup Menu.

Communication parameter	Setup menu item
Transfer rate	No.205 BAUD RATE
Bit length	No.206 DATA LENGTH
Stop bit	No.207 STOP BIT
Parity bit	No.208 PARITY
ACK code	No.209 RETURN ACK

2. Send format

[controller (PC) → VTR]

The following responses are for command instructions. Multiple responses may be made if necessary.

■ Data format

[STX]	[command]	[:]	[data]	[ETX]
02h	XX XX XX	3Ah	XX.....XX	03h

20H<XX<7FH

(XX=ASCII code: symbols, numbers, upper-case letters)

[command]:

This is the command identifier (3 bytes).

A 3-byte identifier (ASCII code: symbols, numbers, upper-case letters) is sent as the command.

[:]

The colon is the code serving as a delimiter between the command and data.

[data]:

Data (ASCII code: symbols, numbers, upper-case letters) can be added in the number of bytes required.

■ Outline of procedure for sending data from controller

- ① The send command starts with STX (start of text = 02h). The command is then identified by COMMAND which follows, and the data is added as required.
The command ends with ETX (end of text = 03h).
- ② When a different command is to be sent, a response is awaited from the VTR, and then the command is sent. (See page 133.)
- ③ If STX is sent again before ETX is sent, the receive data buffer inside the VTR is cleared. A command error is returned to the controller, and the data is newly processed with STX which was received again at the head.

3. Return format

[VTR → controller (PC)]

The following responses are made to the commands. If necessary, more than one response is made.

■ When the communication has ended successfully

1. The receive completion message is returned.

[ACK]
06h

2. The execution completion message is returned.

[STX]	[command]	[data]	[ETX]
02h	XX XX XX	XX.....XX	03h

[command]:

This is the message (data) which is returned or the execution completion message identifier.

[data]:

This is the data to be returned. It can be omitted.

example:

Send command	Return message (data)
[STX] OPL [ETX]	[ACK] [STX] OPL [ETX]

■ When the communication has ended unsuccessfully

[NACK]
15h

■ When processing is not possible due to incorrect data or problem with the VTR

1. The receive completion message is returned.

[ACK]
06h

2. An error code is returned.

[STX]	[E R N ₁ N ₂ N ₃]	[ETX]
02h	error code	03h

4. Error code table

ER001	: Invalid command
	● Unsupported command received
	● Command execution error
ER002	: Parameter error
ER102	: VTR mode error (front loading motor)
ER103	: VTR mode error (loading motor)
ER104	: VTR mode error (drum, capstan system)
ER105	: VTR mode error (reel system)
ER106	: VTR mode error (tension system)
ER108	: VTR condensation error
ER1FF	: VTR system error

RS-232C interface (continued)

5.Command table

■ Commands relating to operation control

<Notes>

- As the return (completion) message, [ACK] is returned when data is received, and only the execution message which is subsequently returned is listed in the table.
- If a command not listed in the table is received, ER001 (invalid command) is returned after [ACK].

VTR operation	Send command	Return (completion) message
STOP	[STX] OSP [ETX] ↔ [STX] OSP [ETX]	[STX] OSP [ETX]
	This command is for stopping the tape transport. The resulting output picture and sound statuses differ according to the setting selected for the setup menu item No.105 (AUTO EE SEL). For details, refer to the setup menus.	
EJECT	[STX] OEJ [ETX] ↔ [STX] OEJ [ETX]	[STX] OEJ [ETX]
	This command is for ejecting the cassette tape. The resulting output picture and sound statuses differ according to the setting selected for the setup menu item No.105 (AUTO EE SEL). For details, refer to the setup menus.	
PLAY	[STX] OPL [ETX] ↔ [STX] OPL [ETX]	[STX] OPL [ETX]
	This command is for starting playback.	
REWIND	[STX] ORW [ETX] ↔ [STX] ORW [ETX]	[STX] ORW [ETX]
	This command is for rewinding the tape. The resulting output picture and sound statuses differ according to the setting selected for the setup menu item No.105 (AUTO EE SEL). The maximum speed differs according to the setting selected for the setup menu item No.102 (FF. REW MAX). For details, refer to the setup menus.	
FAST FORWARD	[STX] OFF [ETX] ↔ [STX] OFF [ETX]	[STX] OFF [ETX]
	This command is for fast forwarding the tape. The resulting output picture and sound statuses differ according to the setting selected for the setup menu item No.105 (AUTO EE SEL). The maximum speed differs according to the setting selected for the setup menu item No.102 (FF. REW MAX). For details, refer to the setup menus.	
REC	[STX] ORC [ETX] ↔ [STX] ORC [ETX]	[STX] ORC [ETX]
	This command is for starting recording.	

VTR operation	Send command	Return (completion) message
SHTL FORWARD	[STX] OSF:data [ETX] ↔ [STX] OSF [ETX]	[STX] OSF [ETX]
	This is the forward direction shuttle command. data = n:speed data 0:STILL 1:×0.03 2:×0.1 3:×0.2 4:×0.5 5:×1 6:×2.0 (1.85× for formats other than DVCPROHD-LP) 7:×4.9 8:×9.8 9:×16 A:×32 <Note> The 16× and 32× speeds differ according to the setting selected for setup menu item No.101 (SHTL MAX).	
SHTL REVERSE	[STX] OSR:data [ETX] ↔ [STX] OSR [ETX]	[STX] OSR [ETX]
	This is the reverse direction shuttle command. data = n:speed data 0:STILL 1:×0.03 2:×0.1 3:×0.2 4:×0.5 5:×1 6:×2.0 (1.85× for formats other than DVCPROHD-LP) 7:×4.9 8:×9.8 9:×16 A:×32 <Note> The 16× and 32× speeds differ according to the setting selected for setup menu item No.101 (SHTL MAX).	
STANDBY OFF	[STX] OBF [ETX] ↔ [STX] OBF [ETX]	[STX] OBF [ETX]
	This command is for setting the VTR to standby OFF.	
STANDBY ON	[STX] OBN [ETX] ↔ [STX] OBN [ETX]	[STX] OBN [ETX]
	This command is for setting the VTR to standby ON.	

RS-232C interface (continued)

■ Commands relating to inquiries

<Notes>

- In terms of the return (completion) message, [ACK] is returned when data is received, and only the execution message which is subsequently returned is listed in the table.
- In the case of commands not listed in the table below, ER001 (invalid command) is returned after [ACK].

VTR operation	Send command	Return (completion) message
CTL/TC DATA REQUEST	[STX] QCD [ETX]	↔ [STX] CD data [ETX]
	<p>This command is for inquiring about the counter value.</p> <p>data =f w gh mm ss ff</p> <p>f = F</p> <p>w = S</p> <p>gh=</p> <p>With CTL:</p> <p>g = SP(20h):for a plus display -(2Dh):for a minus display</p> <p>h = 0 to 9:hours</p> <p>With TC:</p> <p>gh = 00 to 23:hours</p> <p>mm = 00 to 59:minutes</p> <p>ss = 00 to 59:seconds</p> <p>(525i system)</p> <p>ff = 00 to 29:frames</p> <p><Note> CTL or TC is returned, whichever corresponds to the front display mode.</p>	
STATUS REQUEST	[STX] QOP [ETX]	↔ [STX] * * * [ETX]
	<p>This command is for inquiring about the VTR's operation mode.</p> <p>* * * = OEJ: EJECT</p> <p>OFF: FAST FORWARD</p> <p>OPL: PLAY</p> <p>ORC: REC</p> <p>ORW: REWIND</p> <p>OSP: STOP (including STANDBY ON)</p> <p>SRS: (IN/OUT) PREROLL</p> <p>OBF: STAND BY OFF</p> <p>OSF: SHTL FORWARD</p> <p>OSR: SHTL REVERSE</p> <p>OJG: JOG FORWARD/REVERSE</p> <p>OSW: VAR FORWARD/REVERSE</p> <p>EAE: AUTO EDIT</p> <p>EON: EDIT ON (MANUAL EDIT)</p> <p>EPV: PREVIEW</p> <p>ERV: REVIEW</p>	
ID (VTR No.) REQUEST	[STX] QID [ETX]	↔ [STX] data [ETX]
	<p>This command is for inquiring about the VTR used.</p> <p>data =AJ-HD1800</p>	

RS-232C interface (continued)

■ Microsoft QuickBASIC sample program

```
CLS
STX$ = CHR$(&H2): ETX$ = CHR$ (&H3): NAK$ = CHR$(15): ACK$ = CHR$(&H6)
PRINT "*** RS-232C COMMUNICATION SAMPLE PROGRAM ***"
PRINT "Type Command 'QUIT' to quit."
PRINT

REM *** Communication Port Initial & Open ***
REM Port 1,9600Bps,No parity,8 bit data,1 stop bit
OPEN "COM1:9600,N,8,1" FOR RANDOM AS #1 LEN = 256

REM *** Input Command & Send Command ***
SendCmd:
INPUT "Input Command = "; SEND$
IF SEND$ = "QUIT" THEN GOTO ProgEnd
PRINT #1, STX$ + SEND$ + ETX$

REM *** Wait for Receive Command ***
WHILE LOC(1) = 0
    WAITKEY$ = INKEY$
    IF WAITKEY$ = "Q" THEN PRINT "*** Quit ***": GOTO ProgEnd

WEND

REM *** Receive Command ***
RecvCmd:
RCV$ = INPUT$(1, #1)
IF RCV$ = STX$ THEN RCV$ = "[Stx]"
IF RCV$ = ACK$ THEN RCV$ = "[Ack]"
IF RCV$ = NAK$ THEN RCV$ = "[Nak]"
IF RCV$ = ETX$ THEN BUFFER$ = BUFFER$ + "[Etx]": GOTO DispOut
BUFFER$ = BUFFER$ + RCV$
GOTO RecvCmd

REM *** Output Receive Command ***
DispOut:
PRINT "Receive Command = "; BUFFER$
PRINT
BUFFER$ = ""
GOTO SendCmd

REM *** End Program ***
ProgEnd:
CLOSE
END
```

Microsoft QuickBASIC is a trademark of Microsoft Corporation.

Connector signals

VIDEO IN

HD SERIAL IN (DIGITAL)	BNC × 1, active-through (BNC × 1)
HD/SD REF IN	BNC × 2, loop-through, 75Ω termination switch provided
SD SERIAL IN (DIGITAL)	BNC × 1, active-through (BNC × 1)

VIDEO OUT

HD SERIAL OUT (DIGITAL)	BNC × 4
SD SERIAL OUT (DIGITAL)	BNC × 2
ANALOG COMPOSITE OUT	BNC × 3

AUDIO IN

AUDIO IN (DIGITAL)	BNC × 4 (CH1/CH2, CH3/CH4, CH5/CH6, CH7/CH8), AES/EBU format
AUDIO IN (ANALOG)	XLR × 4(CH1, CH2, CH3, CH4)
HD SERIAL IN (DIGITAL)	BNC × 1, active-through (BNC × 1)
SD SERIAL IN (DIGITAL)	BNC × 1, active-through (BNC × 1)
CUE IN	XLR × 1
TIME CODE IN	XLR × 1

AUDIO OUT

AUDIO OUT (DIGITAL)	BNC × 4 (CH1/CH2, CH3/CH4, CH5/CH6, CH7/CH8), AES/EBU format
AUDIO OUT (ANALOG)	XLR × 4(CH1, CH2, CH3, CH4)
HD SERIAL OUT (DIGITAL)	BNC × 4
SD SERIAL OUT (DIGITAL)	BNC × 2
CUE OUT	XLR × 1
TIME CODE OUT	XLR × 1
MONITOR OUT	XLR × 2(LAAR)
HEADPHONES (FRONT)	M6

RS-422A REMOTE(9P)

● REMOTE IN/OUT

Pin No.	Signal
1	FRAME GROUND
2	TRANSMIT A
3	RECEIVE B
4	RECEIVE COMMON
5	_____
6	TRANSMIT COMMON
7	TRANSMIT B
8	RECEIVE A
9	FRAME GROUND

● REMOTE OUT

Pin No.	Signal
1	FRAME GROUND
2	RECEIVE A
3	TRANSMIT B
4	TRANSMIT COMMON
5	_____
6	RECEIVE COMMON
7	RECEIVE B
8	TRANSMIT A
9	FRAME GROUND

Connector signals (continued)

PARALLEL REMOTE (50P)

Refer to 50P IN/OUT ASSIGN on the function menu (page 74) for the connection pin signals.

RS-232C

(D-SUB 25-pin, crossover cable supported)

Pin No.	Signal	Description
1	FG	Protective ground (frame ground)
2	RXD	Received data (data is sent to PC)
3	TXD	Transmitted data (data is received from PC)
4	CTS	Clear to send (shorted with pin 5)
5	RTS	Request to send (shorted with pin 4)
6	DTR	Data terminal ready (no processing)
7	SG	Signal ground
20	DSR	Data set ready (+ voltage output after communication enable status)

ENCODER REMOTE(15P)

Pin No.	Signal
1	FRAME GROUND
4	REM (G)
7	REM RX (X) REMOTE CONTROL PROTOCOL RECEIVE
8	REM TX (X) REMOTE CONTROL PROTOCOL TRANSMIT
14	REM RX (Y) REMOTE CONTROL PROTOCOL RECEIVE
15	REM TX (Y) REMOTE CONTROL PROTOCOL TRANSMIT

EMERGENCY EJECT

Procedure to ejecting the tape manually in an emergency

If the cassette tape fails to be ejected even when the EJECT button is pressed, it can be ejected as follows.

● Follow the steps below after making absolutely sure that the unit's power has been turned off.

- 1 Remove the top panel.
- 2 Use a Phillips-head screwdriver to push in the red plastic gear (A) and turn it counterclockwise while keeping it pushed in. The mechanism that winds up the tape is activated by this, and it makes a latching sound. Ignore the sound, and turn the gear through about 10 revolutions.
<Note>
Turning the gear more than necessary will strain the cassette, possibly resulting in tape damage.
- 3 Check that the posts have unloaded the tape and that the tape is completely housed inside the cassette.
- 4 When the tape returns to the cassette case completely, remove the cassette by pressing and turning the red plastic gear (B) clockwise for front loading as shown in the illustration.
<Note>
When closing the cassette cover, take care not to catch the tape.

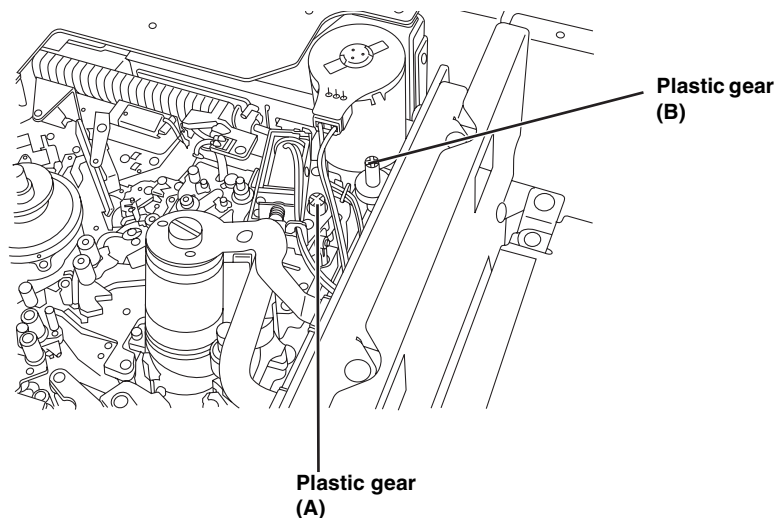

Specifications

[GENERAL]

Power supply: AC 100-240 V , 50/60 Hz
Power consumption: 125 W

 indicates safety information.

Operating ambient temperature:

5 °C to 40 °C (41 °F to 104 °F)

Operating ambient humidity:

10% to 80% (no condensation)

Storage temperature:

-20°C to 60°C (-4°F to 140°F)

Dimensions (W × H × D):

424 mm (max. 435.4 mm) × 175.2 mm × 417 mm

16-3/4 inches (max. 17-3/16 inches) × 6-15/16 inches ×

16-7/16 inches

(not including supporting feet, jacks and connectors, JOG dial and fan)

Weight:

19.5 kg (43.0 lb)

Recording format:

DVCPRO HD-LP

Video signals recorded:

1080i (50 Hz/59.94 Hz switching)

720p (50 Hz, 59.94 Hz and 60 Hz <only for Varicam> switching)

480i/59.94Hz

576i/50Hz

Audio signals recorded:

48 kHz, 16 bits, 8 channels

Recording tracks:

- Digital video/audio:

Helical track

- Time code:

Helical track (sub code area)

- Cue track:

1 track

- Control (CTL) track:

1 track

Tape speed:

67.64 mm/sec. (in 59.94 Hz mode)

67.70 mm/sec. (in 50 or 60 Hz mode)

Tape used:

Metal tape

Recording time:

126 minutes (using XL cassette)

92 minutes (using L cassette)

32 minutes (using M cassette)

FF/REW time:

Approx. 1 min. 30 sec.

(when XL cassette is used and $\pm 100\times$ speed is selected)

Search speed:

$\pm 100\times$

Digital slow:

-1 \times to +2 \times

(when playing back tapes recorded using the DVCPRO HD-LP format)

-1 \times to +1.1 \times

(when playing back tapes recorded using any other format)

Editing accuracy:

± 0 frames

(when time code is used, in 50 Hz, 59.94 Hz or 60 Hz mode)

Tape timer accuracy:

± 1 frame (when continuous CTL signal is used)

Servo lock time:

Less than 0.3 sec. (from standby ON)

Loading time:

Approx. 4 sec. (using M/L cassette),

Approx. 6 sec. (using XL cassette)

Audio split editing:

Provided

[VIDEO]

Sampling frequencies:

Y: 74.176 MHz

PB/PR: 37.088 MHz (1080/59.94i, 720/59.94p)

Y 74.25 MHz

PB/PR: 37.125 MHz (1080/50i, 720/50p)

Quantizing:

8 bits

Video compression method:

DV-Based Compression (SMPTE370M, 317M)

Video compression rate:

1/6.7

Error correction:

Reed-Solomon product code

Video recording bit rate:

100 Mbps

Video Input Connectors**HD serial digital input:**

BNC \times 1

(Complies with the SMPTE 292M/296M/299M standards),

BNC \times 1 (active-through)

SD serial digital input:

BNC \times 1

(Complies with the SMPTE 259M-C/272M-A, ITU-R

BT.656-4 standards),

BNC \times 1 (active-through)

Reference input

Black burst/HD3 value SYNC auto switching

BNC \times 2 (Loop through), 75 Ω ON/OFF switching

Video Output Connectors**HD serial digital output:**

BNC \times 3

(Complies with the SMPTE 292M/296M/299M standards)

BNC \times 1 (monitor output with superimposed display)

SD serial digital output:

BNC \times 1

(Complies with the SMPTE 259M-C/272M-A, ITU-R BT.656-4 standards)

BNC \times 1 (monitor output with superimposed display)

Analog composite output:

BNC \times 3

VIDEO1, VIDEO2, VIDEO3 (Super ON/OFF selectable)

To be output during SD playback or down-converting

[VIDEO] (continued)

Video signal adjustment ranges

- **Component style**
 - HD/SD SDI, composite output Y gain:**
−∞ to +3 dB
 - HD/SD SDI, composite output P_B gain:**
−∞ to +3 dB
 - HD/SD SDI, composite output P_R gain:**
−∞ to +3 dB
 - HD/SD SDI, composite output Y black level:**
±10%
- **Composite style**
 - HD/SD SDI, composite output video gain:**
−∞ to +6 dB
 - HD/SD SDI, composite output chroma gain:**
−∞ to +3 dB
 - HD/SD SDI, composite output chroma phase *1:**
±30°
 - HD/SD SDI, composite output setup:**
±10%
- **System phase**
 - HD serial digital output system phase**
 - 1080i: ±1.0H (13.5 nS step)
 - 59.94/60 Hz :±2200 Sample
 - 50 Hz :±2640 Sample
 - 23.98/24 Hz :±2750 Sample
 - 720p:±1.0H (13.5 nS steps)
 - 59.94/60 Hz :±1650 Sample
 - 50 Hz :±1980 Sample
 - SD serial digital/composite video output system phase**
 - ±1.0H (37 nS steps)
 - 59.94 Hz :±1716 Sample
 - 50 Hz :±1728 Sample
 - Composite video output SC phase:**
±180° or more

*1: Only the SD SDI composite output of SD tape playback is valid in the 50 Hz or 25 Hz mode.

[AUDIO]

Digital Audio

- Sampling frequency:**
48 kHz (synchronized with video)
- Quantizing:**
16 bits
- Frequency response:**
20 Hz to 20 kHz ±1.0 dB (at reference level)
- Dynamic range:**
Better than 90 dB (1 kHz, emphasis OFF)
- Distortion:**
Less than 0.05% (1 kHz, emphasis OFF, reference level)
- Crosstalk:**
Less than −80 dB (1 kHz, between 2 channels)
- Wow & flutter:**
Below measurable limit
- Headroom:**
20/18/12dB selectable

Cue Track

- Frequency response:**
300 Hz to 6 kHz ±3 dB

Audio Input Connectors

- Analog input (CH1 to CH4)**
XLR × 4, 600 Ω/high impedance (selectable),
+4/0/−3/−20 dBu selectable
- Digital input (CH1/CH2, CH3/CH4, CH5/CH6, CH7/CH8)**
BNC × 4, AES/EBU format
- HD serial digital input**
BNC × 1
(Complies with the SMPTE 292M/296M/299M standards)
BNC × 1 (active-through)
- SD serial digital input**
BNC × 1
(Complies with the SMPTE 259M-C/272M-A, ITU-R BT.656-4 standards)
BNC × 1 (active-through)
- Cue track input**
XLR × 1, 600 Ω/high impedance (selectable)
+4/0/−3/−20/−60 dBu switchable

Audio output Connectors

- Analog output (CH1 to CH4)**
XLR × 4, low impedance
+4/0/−3/−20 dBu switchable
- Digital output (CH1/CH2, CH3/CH4, CH5/CH6, CH7/CH8)**
BNC × 4, AES/EBU format
- HD serial digital output**
BNC × 4
(complies with SMPTE 292M/296M/299M standards)
- SD serial digital output**
BNC × 2
(Complies with the SMPTE 259M-C/272M-A, ITU-R BT.656-4 standards)
- Cue track output**
XLR × 1, low impedance
+4/0/−3/−20 dBu switchable
- Monitor output**
XLR × 2, low impedance
+4/0/−3/−20 dBu switchable
- Headphone output**
M6, 8 Ω, Level variable

Audio level adjustment range

- −∞ to +12 dB

Specifications (continued)

[OTHER INPUT/OUTPUT SIGNALS]

Time code input

XLR × 1, 0.5 Vp-p to 8.0 Vp-p, 10 k Ω

Time code output

XLR × 1, low impedance

2.0 \pm 0.5 Vp-p, (with 600 Ω load)

RS-422A input

D-sub 9-pin, RS-422A interface

RS-422A output

D-sub 9-pin, RS-422A interface

RS-232C

D-sub 25-pin, RS-232C interface

Parallel input/output

D-sub 50-pin

Encoder remote

D-sub 15-pin

1394 input/output connector

Connector: 6-pin type

Transmission rate: 400 Mbps, 200 Mbps, 100 Mbps selectable

Transmission data:

Complies with IEEE 1394-1995

Complies with IEC 61883 Part 1, Part 2

Control command:

Complies with AV/C Command Set

[MONITOR]

3.5-inch LCD color monitor, 21 megapixels

(4:3 aspect ratio)

[OPTIONAL ACCESSORIES]

Rack-mounting adapters:

AJ-MA75P

[ACCESSORIES]

Power supply cord × 1 (AJ-HD1800P)

Power supply cord × 2 (AJ-HD1800E)

Inrush current, measured according to European standard
EN55103-1: 10.4 A (240 V)

Weight and dimensions shown are approximate.
Specifications are subject to change without notice.

Information on Disposal for Users of Waste Electrical & Electronic Equipment (private households)



This symbol on the products and/or accompanying documents means that used electrical and electronic products should not be mixed with general household waste.

For proper treatment, recovery and recycling, please take these products to designated collection points, where they will be accepted on a free of charge basis. Alternatively, in some countries you may be able to return your products to your local retailer upon the purchase of an equivalent new product.

Disposing of this product correctly will help to save valuable resources and prevent any potential negative effects on human health and the environment which could otherwise arise from inappropriate waste handling. Please contact your local authority for further details of your nearest designated collection point.

Penalties may be applicable for incorrect disposal of this waste, in accordance with national legislation.

For business users in the European Union

If you wish to discard electrical and electronic equipment, please contact your dealer or supplier for further information.

Information on Disposal in other Countries outside the European Union

This symbol is only valid in the European Union.

If you wish to discard this product, please contact your local authorities or dealer and ask for the correct method of disposal.

Panasonic®

Panasonic Broadcast & Television Systems Company Unit Company of Panasonic Corporation of North America

Executive Office:

One Panasonic Way 4E-7, Secaucus, NJ 07094 (201) 348-7000

EASTERN ZONE:

One Panasonic Way 4E-7, Secaucus, NJ 07094 (201) 348-7196

Southeast Region: (201) 348-7162

WESTERN ZONE:

3330 Cahuenga Blvd W., Los Angeles, CA 90068 (323) 436-3500

Government Marketing Department:

One Panasonic Way 2E-10, Secaucus, NJ 07094 (201) 348-7587

Broadcast PARTS INFORMATION & ORDERING:

9:00 a.m. – 5:00 p.m. (EST) (800) 334-4881/24 Hr. Fax (800) 334-4880

Emergency after hour parts orders (800) 334-4881

TECHNICAL SUPPORT:

Emergency 24 Hour Service (800) 222-0741

Panasonic Canada Inc.

5770 Ambler Drive, Mississauga, Ontario L4W 2T3 (905) 624-5010

Panasonic de Mexico S.A. de C.V.

Av angel Urraza Num. 1209 Col. de Valle 03100 Mexico, D.F. (52) 1 951 2127

Panasonic Puerto Rico Inc.

San Gabriel Industrial Park, 65th Infantry Ave., Km. 9.5, Carolina, Puerto Rico 00630 (787) 750-4300

Professional & Broadcast IT Systems Business Unit Europe Panasonic AVC Systems Europe a Division of Panasonic Marketing Europe GmbH

Hagenauer Str. 43, 65203 Wiesbaden-Biebrich Deutschland Tel: 49-611-235-481



Free Manuals Download Website

<http://myh66.com>

<http://usermanuals.us>

<http://www.somanuals.com>

<http://www.4manuals.cc>

<http://www.manual-lib.com>

<http://www.404manual.com>

<http://www.luxmanual.com>

<http://aubethermostatmanual.com>

Golf course search by state

<http://golfingnear.com>

Email search by domain

<http://emailbydomain.com>

Auto manuals search

<http://auto.somanuals.com>

TV manuals search

<http://tv.somanuals.com>