

Operating Instructions

DVD Recorder

Model No. **DMR-ES20**



SHOWVIEW

Web Site: <http://www.panasonic-europe.com>

DIGA

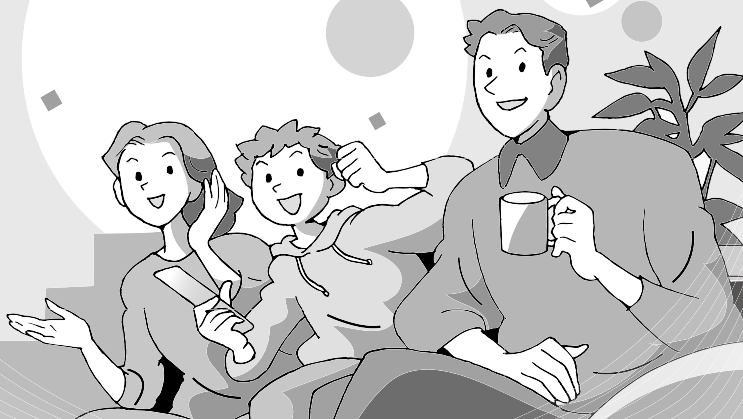

Region number supported by this unit

Region numbers are allocated to DVD players and DVD-Video according to where they are sold.

- The region number of this unit is "2".
- The unit will play DVD-Video marked with labels containing "2" or "ALL".

Example:



Dear customer

Thank you for purchasing this product. For optimum performance and safety, please read these instructions carefully.

Before connecting, operating or adjusting this product, please read the instructions completely. Please keep this manual for future reference.

CAUTION!

THIS PRODUCT UTILIZES A LASER.
USE OF CONTROLS OR ADJUSTMENTS OR
PERFORMANCE OF PROCEDURES OTHER THAN THOSE
SPECIFIED HEREIN MAY RESULT IN HAZARDOUS
RADIATION EXPOSURE.
DO NOT OPEN COVERS AND DO NOT REPAIR YOURSELF.
REFER SERVICING TO QUALIFIED PERSONNEL.

WARNING:

TO REDUCE THE RISK OF FIRE, ELECTRIC SHOCK OR
PRODUCT DAMAGE, DO NOT EXPOSE THIS APPARATUS TO
RAIN, MOISTURE, DRIPPING OR SPLASHING AND THAT NO
OBJECTS FILLED WITH LIQUIDS, SUCH AS VASES, SHALL
BE PLACED ON THE APPARATUS.

CAUTION!

- DO NOT INSTALL OR PLACE THIS UNIT IN A BOOKCASE,
BUILT-IN CABINET OR IN ANOTHER CONFINED SPACE.
ENSURE THE UNIT IS WELL VENTILATED. TO PREVENT
RISK OF ELECTRIC SHOCK OR FIRE HAZARD DUE TO
OVERHEATING, ENSURE THAT CURTAINS AND ANY
OTHER MATERIALS DO NOT OBSTRUCT THE
VENTILATION VENTS.
- DO NOT OBSTRUCT THE UNIT'S VENTILATION OPENINGS
WITH NEWSPAPERS, TABLECLOTHS, CURTAINS, AND
SIMILAR ITEMS.
- DO NOT PLACE SOURCES OF NAKED FLAMES, SUCH AS
LIGHTED CANDLES, ON THE UNIT.
- DISPOSE OF BATTERIES IN AN ENVIRONMENTALLY
FRIENDLY MANNER.

THIS UNIT IS INTENDED FOR USE IN MODERATE CLIMATES.

This product may receive radio interference caused by mobile
telephones during use. If such interference is apparent, please
increase separation between the product and the mobile
telephone.

The socket outlet shall be installed near the equipment and easily
accessible or the mains plug or an appliance coupler shall remain
readily operable.

**CLASS 1
LASER PRODUCT**

LUOKAN 1 LASERLAITE KLASS 1 LASER APPARAT

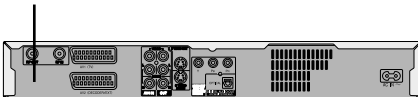

DANGER	- VISIBLE AND INVISIBLE LASER RADIATION WHEN OPEN. AVOID DIRECT EXPOSURE TO BEAM. (FDA 21 CFR)
CAUTION	- VISIBLE AND INVISIBLE LASER RADIATION WHEN OPEN. AVOID EXPOSURE TO BEAM. (IEC60825-1)
ATTENTION	- RAYONNEMENT LASER VISIBLE ET INVISIBLE EN CAS D'OUVERTURE. EXPOSITION DANGEREUSE AU FAISCEAU.
ADVARSEL	- SYNLIG OG USYNLIG LASERSTRÅLING VED ÅBNING. UNNGÅ UDSÆTTELSE FOR STRÅLING.
VARO!	- AVATTAESSA OLET ALTTIIN NÄKYVÄÄ JA NÄKYMÄTÖN LASERSÄTEILYLLE. ÄLÄ KATSO SÄTEESEEN.
VARNING	- SYNLIG OCH OSYNLIG LASERSTRÅLNING NÄR DENNA DEL ÄR ÖPPNAD. BETRÄKTA EJ STRÅLEN.
ADVARSEL	- SYNLIG OG USYNLIG LASERSTRÅLING NÄR DEKSEL ÅPNES. UNNGÅ EKSPONERING FOR STRÅLEN.
VORSICHT	- SICHTBARE UND UNSICHTBARE LASERSTRÄHLUNG, WENN ABDECKUNG GEOFFNET. NICHT DEM STRAHL AUSSETZEN.
注意	- 打开时有可见及不可见激光辐射。避免激光束照射。
注意	- ここを開くと可視及び不可視のレーザー光が出ます。 ビームを直接見たり、触れたりしないでください。 RQLS0233

(Inside of product)
(Tuotteen sisällä)
(Produktets innsida)

SUOMI**VAROITUS!**

LAITTEEN KÄYTTÄMINEN MUULLA KUIN TÄSSÄ
KÄYTTÖOHJEESSA MAINITULLA TAVALLA SAATTAA
ALTISTAA KÄYTTÄJÄN TURVALLISUUSLUOKAN 1
YLITTÄVÄLLE NÄKYMÄTTÖMÄLLE LASERSÄTEILYLLE.

VAROITUS:

TULIPALO-, SÄHKÖISKUVAARAN TAI TUOTETTA
KOHTAAVAN MUUN VAHINGON VÄHENTÄMISEKSI EI
LAITETTA SAA ALTISTAA SATEELLE, KOSTEUDELLE,
VESIPISAROILLE TAI ROISKEELLE, EIKÄ NESTETTÄ
SISÄLTÄVIÄ ESINEITÄ, KUTEN ESIMERKIKSI
MALJAKOITA, SAA ASETTAA LAITTEEN PÄÄLLE.

VAROITUS!

- ÄLÄ ASENNATA TAI LAITA TÄTÄ LAITETTA
KABINETTITYYPPISEEN KIRJAKAAPPIIN TAI MUUHUN
SULJETTUUN TILAAN, JOTTA TUULETUS ONNISTUISI.
VARMASTI, ETTÄ VERHO TAI MIKÄÄN MUU MATERIAALI
EI HUONONNA TUULETUSTA, JOTTA VÄLTETTÄISIIN
YLIKUUMENEMISESTA JOHTUVA SÄHKÖISKU- TAI
TULIPALOVAARA.
- ÄLÄ PEITÄ LAITTEEN TUULETUSAUKKOJA
SANOMALEHDELLÄ, PÖYTÄLINALLA, VERHOLLA TAI
MUULLA VASTAAVALLA ESINEELLÄ.
- ÄLÄ ASETA PALAVAA KYNTTILÄÄ TAI MUUTA
AVOTULEN LÄHDETTÄ LAITTEEN PÄÄLLE.
- HÄVITÄ PARISTOT LUONTOA
VAHINGOITAMATTOMALLA TAVALLA.

TÄMÄ LAITE ON TARKOITETTU KÄYTETTÄVÄKSI LEUDOSSA
ILMASTOSSA.

Laite tulee asettaa lähelle verkkopistorasiaa ja pistokkeen täytyy
olla sellaisessa asennossa, että siihen on helppo tarttua
ongelman sattuessa.

NORSK**ADVARSEL!**

DETTE PRODUKTET ANVENDER EN LASER.
BETJENING AV KONTROLLER, JUSTERINGER ELLER
ANDRE INNGREP ENN DE SOM ER BESKREVET I DENNE
BRUKSANVISNING, KAN FØRE TIL FARLIG BESTRÅLING.
DEKSLER MÅ IKKE ÅPNES, OG FORSØK ALDRI Å
REPARERE APPARATET PÅ EGENHÅND. ALT SERVICE
OG REPARASJONSARBEID MÅ UTFØRES AV
KVALIFISERT PERSONELL.

ADVARSEL:

FOR Å REDUSERE FAREN FOR BRANN, ELEKTRISK STØT
ELLER SKADER PÅ PRODUKTET, MÅ DETTE APPARATET
IKKE UTSETTES FOR REGN, FUKTIGHET, VANNDRÅPER
ELLER VANNSPRUT. DET MÅ HELLER IKKE Plasseres
GJENSTANDER FYLT MED VANN, SLIK SOM
BLOMSTERVASER, OPPÅ APPARATET.

ADVARSEL!

- APPARATET MÅ IKKE Plasseres I EN BOKHYLLE, ET
INNEBYGGET KABINETT ELLER ET ANNET LUKKET
STED HVOR VENTILASJONSFORHOLDENE ER
UTILSTREKKELIGE. SØRG FOR AT GARDINER ELLER
LIGNENDE IKKE FORVERRER
VENTILASJONSFORHOLDENE, SÅ RISIKO FOR
ELEKTRISK SJOKK ELLER BRANN FORÅRSAKET AV
OVERHETING UNNGÅS.
- APPARATETS VENTILASJONSÅPNINGER MÅ IKKE
DEKKES TIL MED AVISER, BORDDUKER, GARDINER OG
LIGNENDE.
- Plasser IKKE ÅPEN ILD, SLIK SOM LEVENDE LYS,
OPPÅ APPARATET.
- BRUKTE BATTERIER MÅ KASSERES UTEN FARE FOR
MILJØET.

DETTE APPARATET ER BEREGNET TIL BRUK UNDER
MODERATE KLIMAFORHOLD.

Utstyret bør plasseres i nærheten av AC-stikkkontakten, og
støpslet må være lett tilgjengelig hvis det skulle oppstå
problemer.

Table of contents

Getting started

Accessories	3
The remote control	3
Disc information	4
Control reference guide	6
STEP 1 Connection	7
STEP 2 TV Tuning	10
STEP 3 Set up to match your television and remote control	12

Recording

Recording television programmes	14
Recording modes and approximate recording times	14
Recording television programmes	14
Direct TV Recording	15
Playing while you are recording	15
Flexible Recording	16
Recording from digital/satellite receiver or decoder	16
Timer recording	17
Using SHOWVIEW system to make timer recordings	17
Manually programming timer recordings	18
Check, change or delete a programme	18
Making timer recordings on the television	19
Linked timer recordings with external equipment (digital/satellite receiver)–EXT LINK	19

Playing back

Playing discs	20
Changing audio during play	20
Operations during play	21
Editing operations during play	21
Using menus to play MP3 and still pictures (JPEG/TIFF)	22
Playing MP3	22
Playing still pictures (JPEG/TIFF)	22
Using on-screen menus	24
Common procedures	24
Disc menu–Setting the disc content	24
Play menu–Change the play sequence	24
Picture menu–Change the picture quality	25
Sound menu–Change the sound effect	25
Other menu–Change the display position	25
FUNCTIONS window and Status messages	25
FUNCTIONS window	25
Status messages	25

Editing

Editing titles/chapters	26
Editing titles/chapters and playing chapters	26
Title operations	27
Chapter operations	27
Creating, editing and playing playlists	28
Creating playlists	28
Editing and playing playlists/chapters	29
Playlist operations	29
Chapter operations	29

Transfer (Dubbing)

Recording from a video cassette recorder	30
Manual recording	30
DV automatic recording (DV AUTO REC)	30

Convenient functions





DISC MANAGEMENT	31
Setting the protection	31
Providing a disc with a name	31
Erasing all titles–Erase all titles	31
Erasing all the contents of a disc–Format Disc	32
Enabling DVD-R, DVD-RW (DVD-Video format) or +R to be played on other equipment–Finalize	32
Entering text	33
Changing the unit's settings	33
Common procedures	33
Summary of settings	34
Tuning	37
TV System	38
Clock settings	39
Child Lock	39

Reference

Specifications	40
Glossary	40
Frequently asked questions	42
Optional Accessories	42
Error messages	43
Maintenance	43
Troubleshooting guide	44
Safety precautions	46
Index	Back cover

Accessories

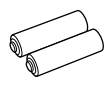
 Please check and identify the supplied accessories.
(Product numbers correct as of April 2005. These may be subject to change.)

- | | | | | | | | | | |
|--------------------------|---|--------------------------|---|--------------------------|---|--------------------------|---|--------------------------|---|
| <input type="checkbox"/> |  | <input type="checkbox"/> |  | <input type="checkbox"/> |  | <input type="checkbox"/> |  | <input type="checkbox"/> |  |
| 1 | Remote control (EUR7720KL0) | 1 | AC mains lead | 1 | RF coaxial cable | 2 | Batteries for remote control | 1 | Audio/video cable |
- For use with this unit only.
Do not use it with other equipment.
Also do not use the cords for other equipment with this unit.

The remote control

Batteries

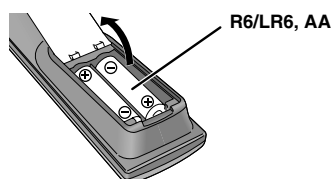

- Insert so the poles (+ and –) match those in the remote control.
- Do not use rechargeable type batteries.
- Do not mix old and new batteries.
- Do not use different types at the same time.
- Do not heat or expose to flame.
- Do not take apart or short circuit.
- Do not attempt to recharge alkaline or manganese batteries.
- Do not use batteries if the covering has been peeled off.

Mishandling of batteries can cause electrolyte leakage which can damage items the fluid contacts and may cause a fire.

Remove if the remote control is not going to be used for a long period of time. Store in a cool, dark place.



Note

If you cannot operate the unit or television using the remote control after changing the batteries, please re-enter the codes (→ page 13).

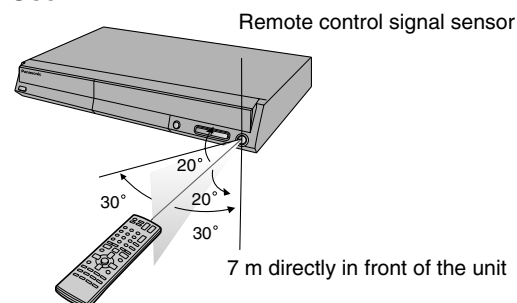
Use







Discs you can use for recording and play (12 cm/8 cm)

Disc type	DVD-RAM • 4.7 GB/9.4 GB, 12 cm • 2.8 GB, 8 cm	DVD-R (DVD-Video format) • 4.7 GB, 12 cm • 1.4 GB, 8 cm
Logo		
Indication in these instructions	RAM	Before finalizing -R After finalizing DVD-V
Main use	Re-writable discs	One time recording discs (recordable until the disc is full)
Maximum recording time (→ page 14, Recording modes and approximate recording times)	8 hours (16 hours in EP (8Hours) mode on double-sided disc ※1)	8 hours
Play on other players	Only on DVD-RAM compatible players. It is not necessary to finalize the disc. (→ page 40)	Only after finalizing the disc. (→ page 32)
What you can do on this unit (✓ : Can do × : Cannot do)		
Chasing playback	✓	×
Recording broadcasts that allow one copy	✓ (CPRM (→ page 40) compatible discs only.)	×
Recording both M 1 and M 2 of bilingual broadcast	✓	×
Recording 16:9 aspect picture	✓	×
Enter programme (title) name	✓	✓
Erase programme (title)	✓ (Available space increases after erasing.)	✓ (Available space does not increase after erasing.)
Creating playlists	✓	×

- We recommend using Panasonic discs. We recommend using DVD-RAM discs with cartridges to protect them from scratches and dirt.
 - You may not be able to record to DVD-R, DVD-RW and +R discs on this unit or play them due to the condition of the recording.
 - You cannot record programmes that allow "One time only recording" to CPRM compatible DVD-R and DVD-RW on this unit.
 - You can use high speed recording compatible discs on this unit.
- ※1 You cannot record or play continuously on two sides.

Play-only discs (12 cm/8 cm)

Disc type	DVD-Video	DVD-Audio	DVD-RW (DVD Video Recording format)	+RW
Logo	 			—
Indication in these instructions	DVD-V	DVD-A	-RW(VR)	DVD-V
Instructions	High quality movie and music discs	High fidelity music discs • Played on this unit in 2 channels.	DVD-RW recorded on another DVD Recorder ※3 • You can play programmes that allow "One time only recording" if they have been recorded to a CPRM compatible disc. • By formatting (→ page 32) the disc, you can record to it in DVD-Video format and play it on this unit. • It may be necessary to finalize the disc on the equipment used for recording.	+RW recorded on another DVD Recorder ※3



- ※3 Play may be impossible on some CD-R, CD-RW, DVD-RW or +RW discs due to the condition of the recording.
- ※4 You can play still pictures (JPEG/TIFF), CD-DA, Video CD, SVCD (conforming to IEC62107) and MP3 format data recorded on CD-R/RW.
- The producer of the disc can control how discs are played. So you may not always be able to control play as described in these operating instructions. Read the disc's instructions carefully.

Regarding DVD-Audio

Some multi-channel DVD-Audio will prevent down-mixing (→ page 40) of all or part of their contents if this is the manufacturer's intention. When playing such discs, or such parts of disc, unless the number of connected speakers is the same as the disc's channel specification, audio will not be output properly (e.g. part of the audio is missing, multi-channel audio cannot be selected and audio is played in two channels). Refer to the disc's jacket for more information.

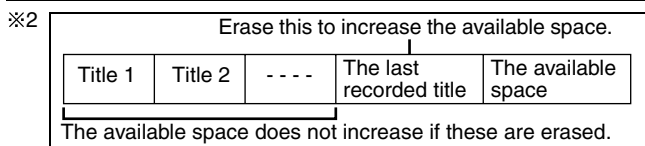
DVD-RW (DVD-Video format) • 4.7 GB, 12 cm • 1.4 GB, 8 cm		+R • 4.7 GB, 12 cm	
		—	
Before finalizing	-RW(V)	Before finalizing	+R
After finalizing	DVD-V	After finalizing	DVD-V
Re-writable discs		One time recording discs (recordable until the disc is full)	
8 hours		8 hours	
Only after finalizing the disc. (→ page 32)		Only after finalizing the disc. (→ page 32)	
×		×	
×		×	
×		×	
Only one is recorded (→ page 35, Bilingual Audio Selection)		Only one is recorded (→ page 35, Bilingual Audio Selection)	
× (The picture is recorded in 4:3 aspect.)		× (The picture is recorded in 4:3 aspect.)	
✓		✓	
✓ (The available space on DVD-RW (DVD-Video format) increases only when the last recorded title is erased.) ※2		✓ (Available space does not increase after erasing.)	
×		×	



Audio CD		Video CD	SVCD
			
—		—	
CD		VCD	
Music and audio recorded (including CD-R/RW ※3 ※4)	CD-R and CD-RW ※3 ※4 with music recorded in MP3 Still pictures (JPEG and TIFF) recorded on CD-R and CD-RW ※3 ※4	Music and video recorded (including CD-R/RW ※3 ※4)	

The manufacturer accepts no responsibility and offers no compensation for loss of recorded or edited material due to a problem with the unit or recordable media, and accepts no responsibility and offers no compensation for any subsequent damage caused by such loss.
Examples of causes of such losses are

- A disc recorded and edited with this unit is played in a DVD recorder or computer disc drive manufactured by another company.
- A disc used as described above and then played again in this unit.
- A disc recorded and edited with a DVD recorder or computer disc drive manufactured by another company is played in this unit.

DVD Video Recording format
 This is a recording method which allows you to freely record and edit television broadcasts and so on.

- Digital broadcasts that allow “One time only recording” can be recorded to a CPRM compatible disc. You can record to CPRM compatible DVD-RAM on this unit.
- Play is only possible on a compatible DVD player.

Use a DVD-RAM to record by the DVD Video Recording format.

DVD-Video format
 This recording method is the same as commercially available DVD-Video.

- Digital broadcasts that allow “One time only recording” cannot be recorded.
- These can be played on a DVD player. However programmes recorded on this unit must be finalized to be played on other DVD players.

Use a DVD-R or DVD-RW to record by the DVD-Video format.

Discs that cannot be played

- 2.6 and 5.2 GB DVD-RAM, 12 cm
- 3.95 and 4.7 GB DVD-R for Authoring
- DVD-R recorded by DVD Video Recording format
- DVD-R (DVD-Video format), DVD-RW (DVD-Video format), +R recorded on another unit and not finalized (→ page 40).
- DVD-Video with a region number other than “2” or “ALL”
- Blu-ray
- DVD-ROM, DVD-R DL, +R DL, +R (8 cm), CD-ROM, CDV, CD-G, Photo CD, SACD, MV-Disc, PD, Divx Video Disc, “Chaoji VCD” available on the market including CVD, DVCD and SVCD that do not conform to IEC62107, etc.

Disc handling

- **How to hold a disc**
Do not touch the recorded surface.
- **Concerning non-cartridge discs**
Be careful about scratches and dirt.
- **If there is dirt or condensation on the disc**
Wipe with a damp cloth and then wipe dry.
- **Handling precautions**
 - Do not attach labels or stickers to discs. (This may cause disc warping and un-balanced rotation, rendering it unusable.)
 - Write on the label side of the disc only with a soft, oil-based felt pen. Do not use ballpoint pens or other hard writing implements.
 - Do not use record cleaning sprays, benzene, thinner, static electricity prevention liquids or any other solvent.
 - Do not use scratch-proof protectors or covers.
 - Do not drop, stack, or impact discs. Do not place objects on them.
 - Do not use the following discs:
 - Discs with exposed adhesive from removed stickers or labels (rented discs etc).
 - Discs that are badly warped or cracked.
 - Irregularly shaped discs, such as heart shapes.
 - Do not place in the following areas:
 - In direct sunlight.
 - In very dusty or humid areas.
 - Near a heater.
 - Locations susceptible to significant differences in temperature (condensation can occur).
 - Where static electricity or electromagnetic waves occur.
 - To protect discs from scratches and dirt, return them to their cases or cartridges when you are not using them.

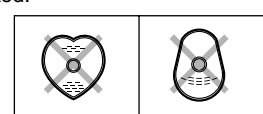
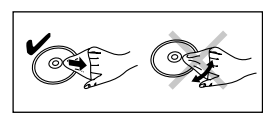
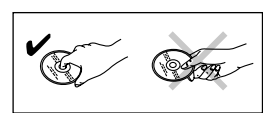

Types of disc for the type of connected TV

When you use the discs recorded either PAL or NTSC, refer to this table. (✓: Possible to view, ×: Impossible to view)

TV type	Disc	Yes/No
Multi-system TV	PAL	✓
	NTSC	✓ ※5
NTSC TV	PAL	×
	NTSC	✓ ※6
PAL TV	PAL	✓
	NTSC	✓ ※7 (PAL60)

※5 If you select “NTSC” in “TV System” (→ page 38), the picture may be clearer.
 ※6 Select “NTSC” in “TV System” (→ page 38).
 ※7 If your television is not equipped to handle PAL 525/60 signals the picture will not be shown correctly.

Remote control

ENGLISH

Getting started

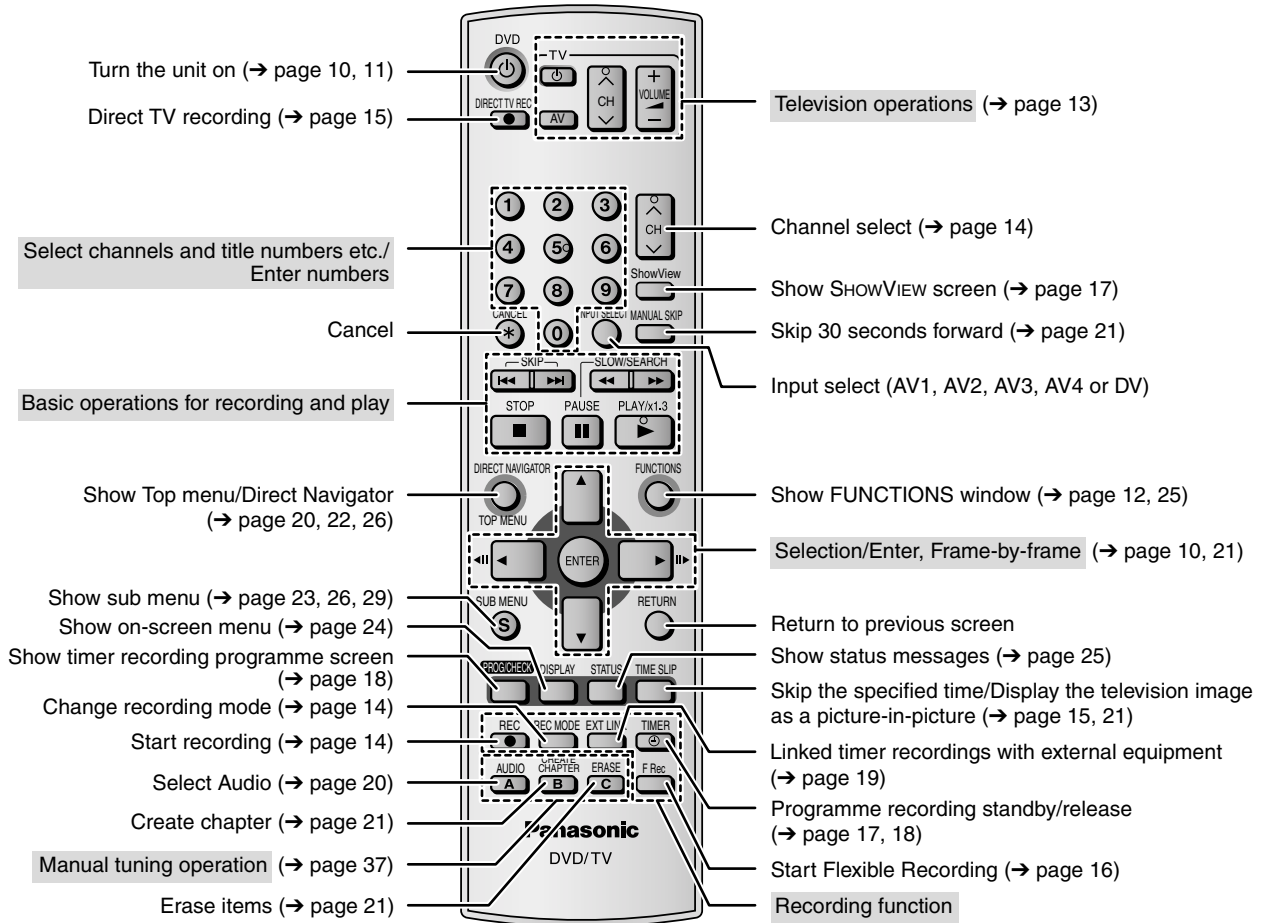

Main unit

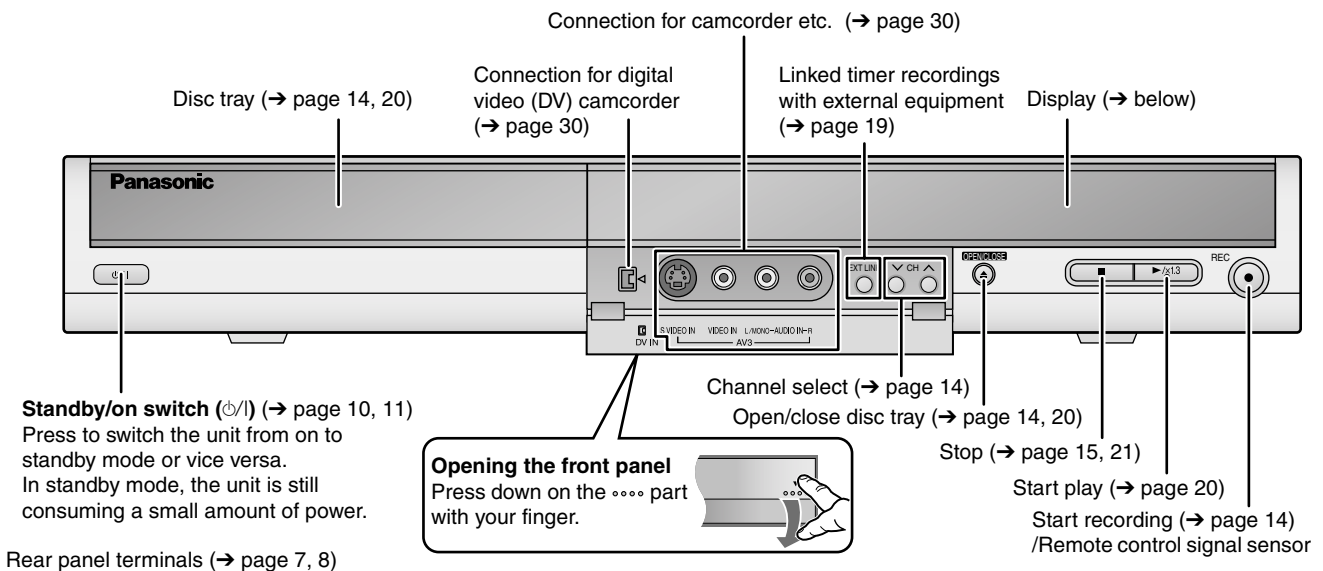

The unit's display

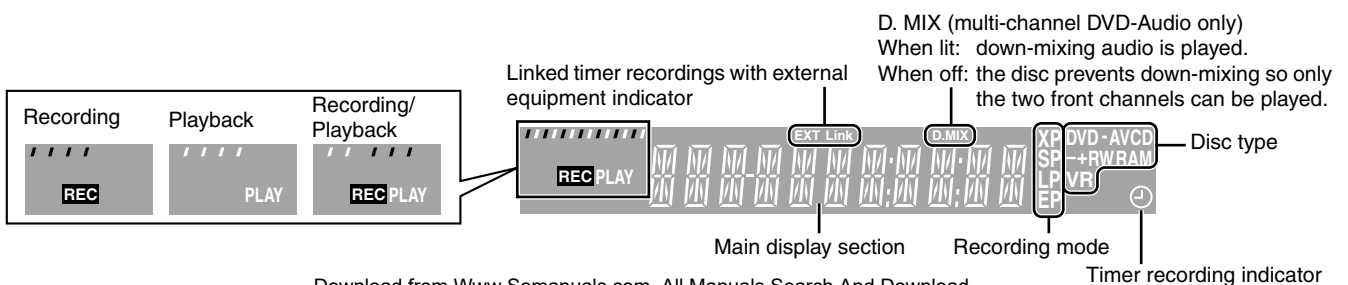

STEP 1 Connection

- The equipment connections described are examples.
- Before connection, turn off all equipment and read the appropriate operating instructions.
- Peripheral equipment and optional cables are sold separately unless otherwise indicated.

Connecting a television with 21-pin Scart terminal and VCR

When there is no 21-pin Scart terminal on the television (→ page 8)

- indicates included accessories.
- - - indicates accessories not included.
- ① - ④ are required connections. Connect in the numbered order.

To the aerial

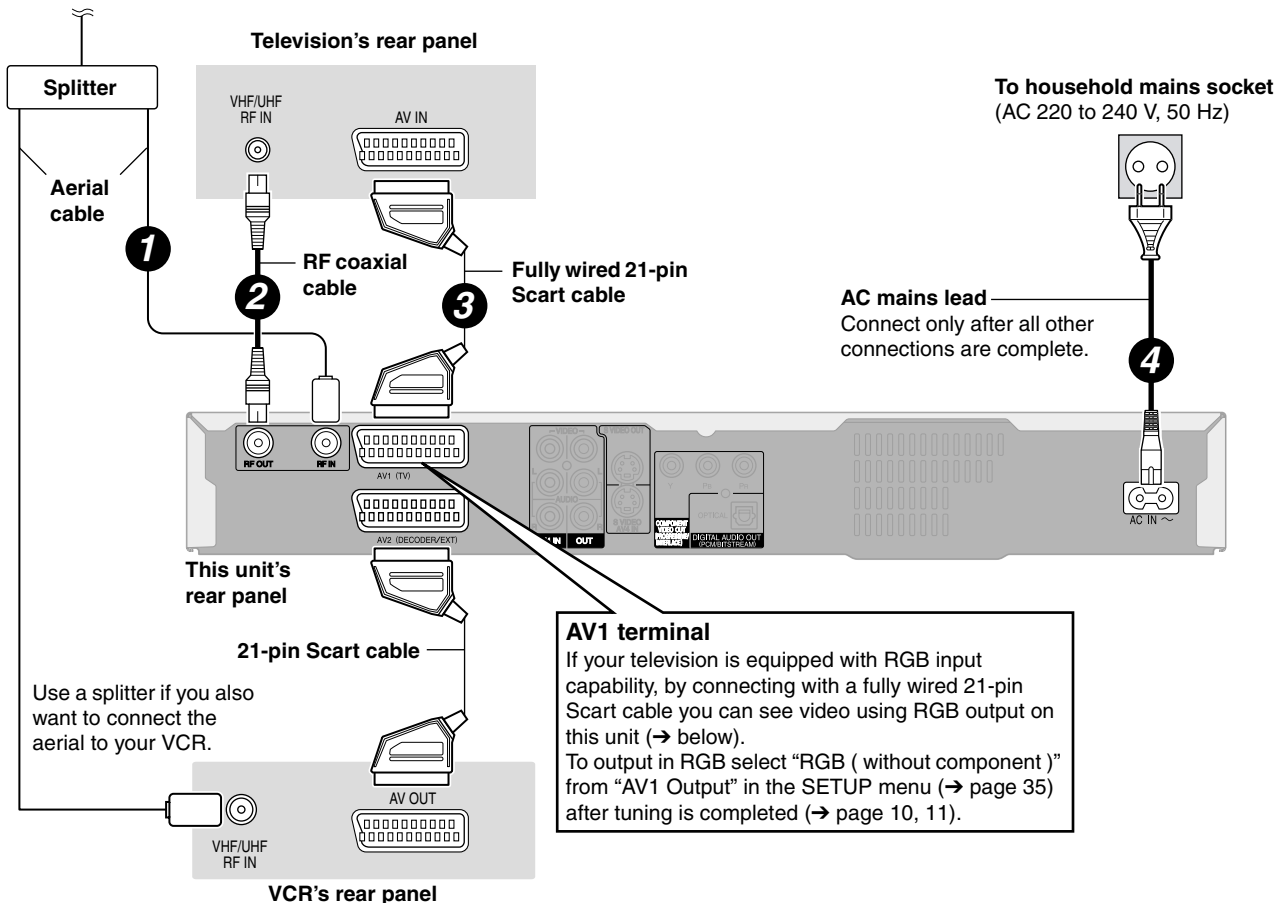

■ RGB

This refers to the three primary colours of light, red (R), green (G), and blue (B) and also the method of producing video that uses them. By dividing the video signal into the three colours for transmission, noise is reduced for even higher quality images.

■ Q Link functions

Q Link offers a range of convenient functions (For further details → page 41). Make sure to connect a fully wired 21-pin Scart cable to the television if using the Q Link function.

The following systems from other manufacturers have similar function to Q Link from Panasonic. For details, refer to your television's operating instructions or consult your dealer.

- Q Link (registered trademark of Panasonic)
- DATA LOGIC (registered trademark of Metz)
- Easy Link (registered trademark of Philips)
- Megalogic (registered trademark of Grundig)
- SMARTLINK (registered trademark of Sony)

■ Do not connect the unit through a video cassette recorder

Video signals fed through video cassette recorders will be affected by copyright protection systems and the picture will not be shown correctly on the television.

- When connecting to a television with a built in VCR, connect to the input terminals on the television side, not the VCR side.

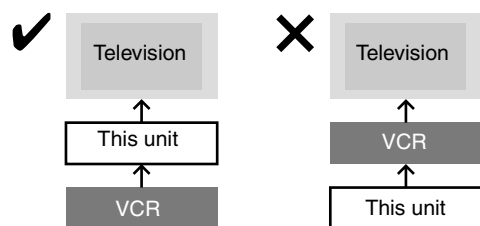

■ When the unit is not to be used for a long time

To save power, unplug it from the household mains socket. This unit consumes a small amount of power, even when it is turned off [approx. 3 W (Power Save mode)].

Before moving the unit, ensure the disc tray is empty.
Failure to do so will risk severely damaging the disc and the unit.

STEP 1 Connection

Connecting a television with AUDIO/VIDEO terminals and VCR

Connecting to the television using the 21-pin Scart cables (→ page 7)

- indicates included accessories.
- indicates accessories not included.
- ① – ④ are required connections. Connect in the numbered order.

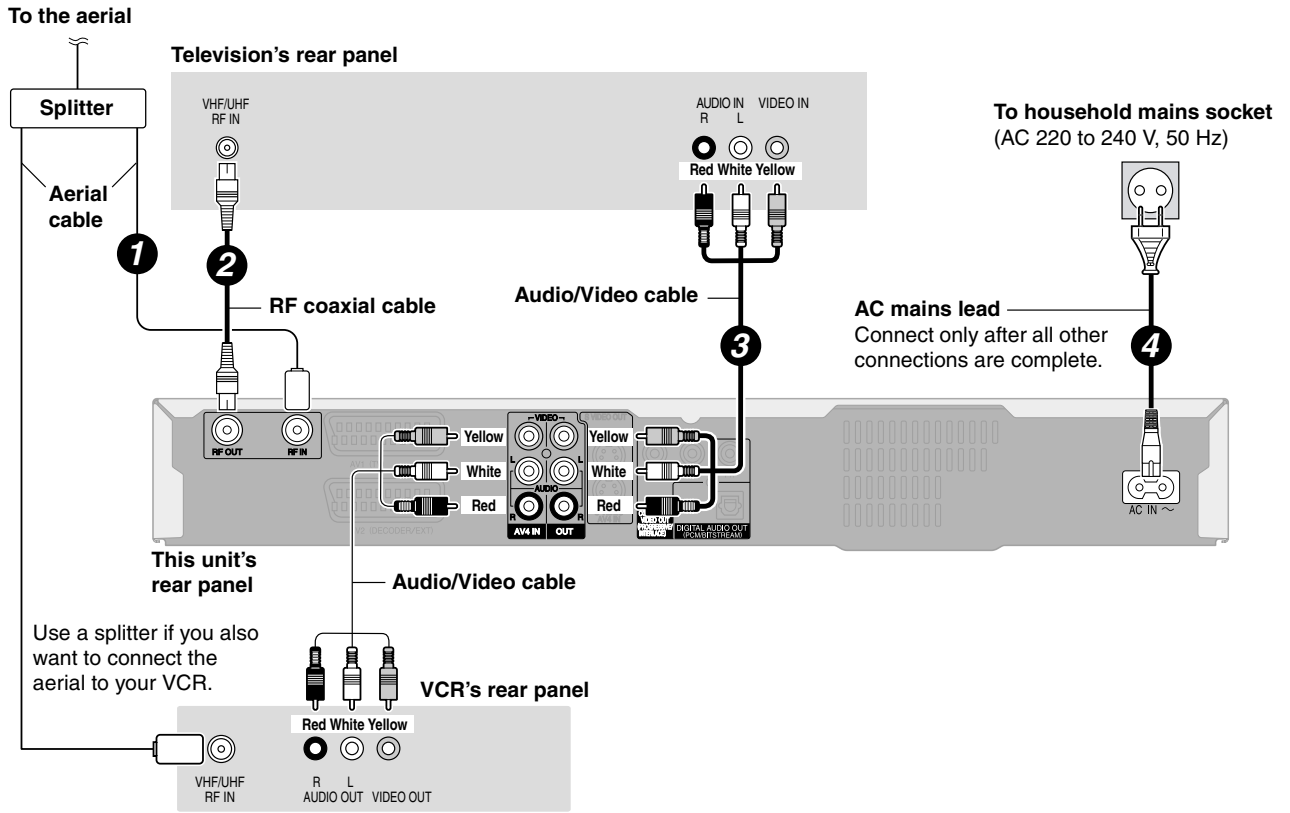

Connecting a television with S VIDEO or COMPONENT VIDEO terminals

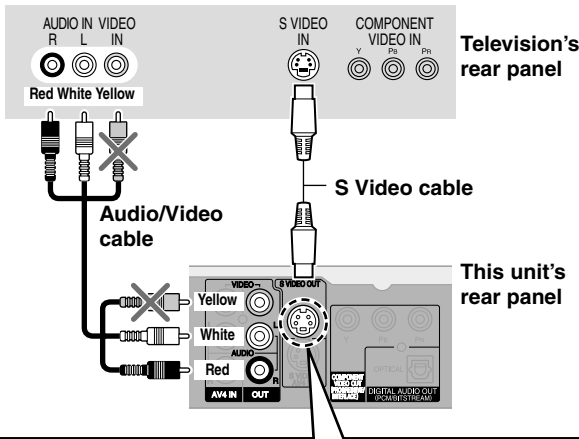

S VIDEO OUT terminal
Connect to S VIDEO IN terminal on the television through a S Video cable.
The S VIDEO OUT terminal achieves a more vivid picture than the VIDEO OUT terminal. (Actual results depend on the television.)

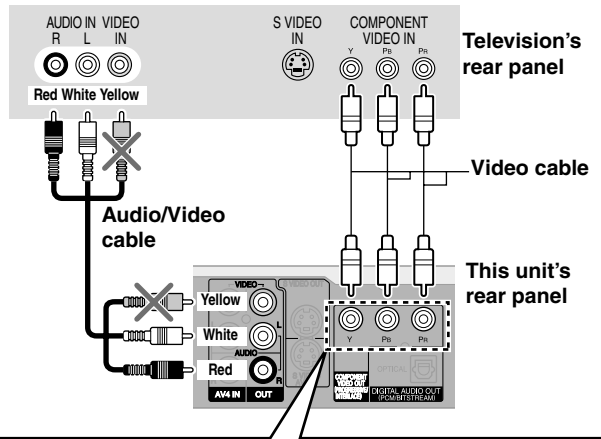

COMPONENT VIDEO OUT terminal
Connect to COMPONENT VIDEO IN terminals on the television through a component video cable. These terminals can be used for either interlace or progressive output (→ page 41) and provide a purer picture than the S VIDEO OUT terminal.
● Connect to terminals of the same colour.

(→ page 9, Note to owners of progressive compatible PAL system televisions)

■ Component video output

Component signal outputs the colour difference signals (PB/PR) and luminance signal (Y) separately in order to achieve high fidelity in reproducing colours. If the television is compatible with progressive output, a high quality picture can be output because this unit's component video output terminal outputs a progressive output signal (→ page 41).

Connecting a digital/satellite receiver or decoder

- Decoder here means the device used to decode scrambled broadcasts (Pay TV).
- Change the "AV2 Input" and "AV2 Connection" settings in the SETUP menu to match the connected equipment (→ page 35).

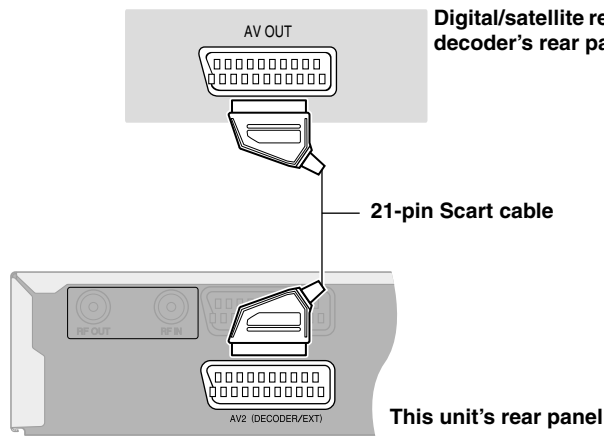

Viewing video from the decoder on the television while the unit is stopped, or while recording

If you connected the television to the AV1 terminal and the decoder to the AV2 terminal on this unit, press [0]+[ENTER]. ("DVD" appears on the unit's display.) Press again to cancel. ("TV" appears on the unit's display.)

- If the television is compatible with RGB input, the RGB output signal from the decoder can also be output from the main unit the same way.

Connecting an amplifier or system component

To enjoy multi-channel surround sound on DVD-Video

Connect an amplifier with Dolby Digital, DTS and MPEG decoders using an optical digital audio cable and change the settings in "Digital Audio Output" (→ page 35).

- You cannot use DTS Digital Surround decoders not suited to DVD.
- Even if using this connection, output will be only 2 channels when playing DVD-Audio.

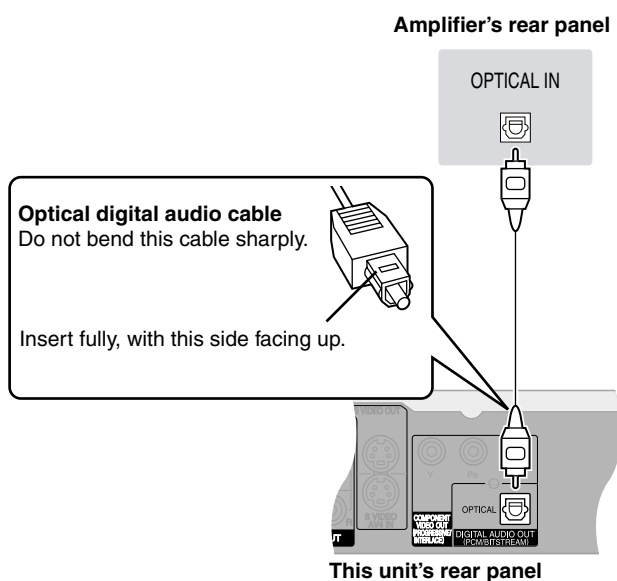

Connection to a stereo amplifier

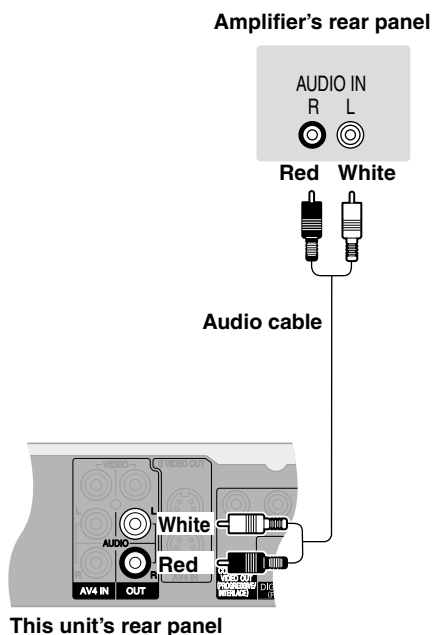

Do not place the unit on amplifiers or equipment that may become hot.

The heat can damage the unit.

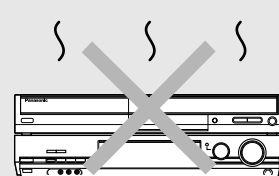

Note to owners of progressive compatible PAL system televisions

• If you have an LCD/plasma television or LCD projector
Using progressive output, you can enjoy high-resolution video recorded on media such as DVD-Video. Connect this unit's component video output terminals to your television and turn on the progressive output setting (→ page 12).

• If you have a CRT (cathode ray tube) television
Use component output with progressive "Off" (Factory setting, → page 35), even if it is progressive compatible, because progressive output can cause some flickering. This is the same for multi system televisions using PAL mode.

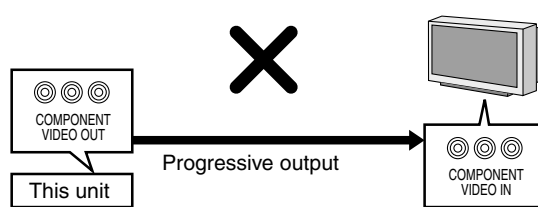
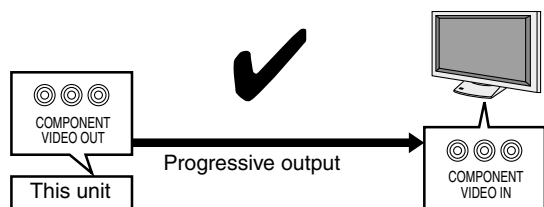

STEP 2 TV Tuning

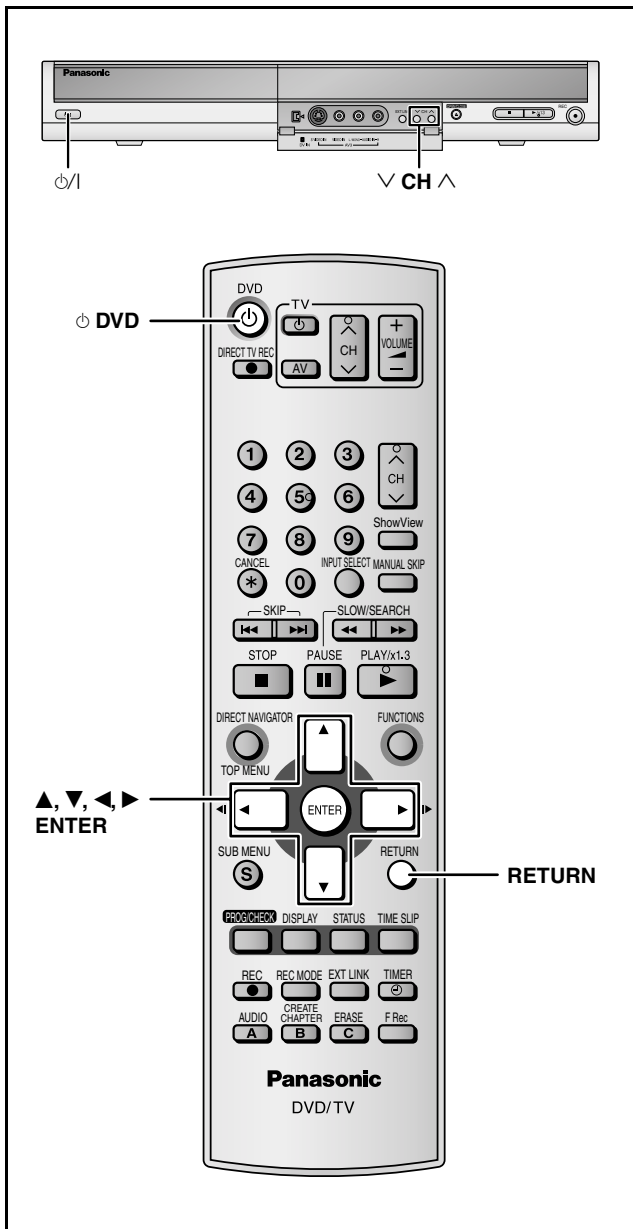

Tuning Preset Download (Setup with Q Link functions)

When connecting to a television that has the Q Link function (→ page 41) with a fully wired 21-pin Scart cable (→ page 7).

(The AV2 and AV4 Scart terminals on Panasonic televisions are compatible with the Q Link function.)

You can download the tuning positions from the television. This unit Auto Clock Setting function synchronizes the time when the TV channel that is broadcasting time and date information is tuned.

- 1 Turn on the television and select the appropriate AV input to suit the connections to this unit.
- 2 Press [**⏻ DVD**] to turn the unit on.

Tuning Preset Downloading starts.



Tuning Preset Downloading is complete when you see the television picture.

- If the Country setting menu appears on the television, press [**▲, ▼, ◀, ▶**] to select the country and press [ENTER].

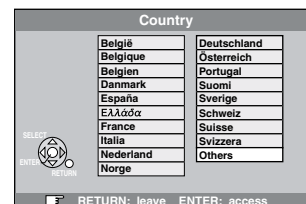

If you select "Schweiz", "Suisse" or "Svizzera" in the Country setting, or when the television tuning setting has been set to Switzerland, the "Power Save" setting menu appears. Select "On" or "Off" (→ page 36).

To stop partway

Press [RETURN].

■ If the clock setting menu appears

Set the clock manually (→ page 39).

■ To confirm that stations have been tuned correctly (→ page 37)

■ To restart Preset Download (→ page 38)

Auto-Setup (Setup without Q Link functions)

- When connecting to a television with the VIDEO OUT, S VIDEO OUT or COMPONENT VIDEO OUT terminal (→ page 8).
- When connecting to a television that does not have the Q Link function (→ page 41).

This unit's Auto-Setup function automatically tunes all available TV stations and synchronizes the time when the TV channel that is broadcasting time and date information is tuned.

- 1 Turn on the television and select the appropriate AV input to suit the connections to this unit.
- 2 Press [⏻ DVD] to turn the unit on.

The Country setting menu appears.

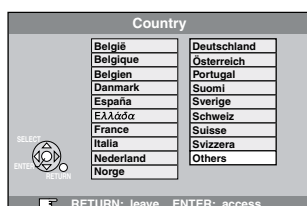

If you select "Schweiz", "Suisse" or "Svizzera", the "Power Save" setting menu appears. Select "On" or "Off" (→ page 36).

- 3 Press [▲, ▼, ◀, ▶] to select the country.
- 4 Press [ENTER].

Auto-Setup starts. This takes about 8 minutes.



Auto-Setup is complete when you see the television picture.

To stop partway

Press [RETURN].

■ If the clock setting menu appears

Set the clock manually (→ page 39).

■ To confirm that stations have been tuned correctly (→ page 37)

■ To restart Auto-Setup (→ page 38)

You can also use the following method to restart Auto-Setup.

When the unit is on and stopped

Press and hold [▼ CH] and [CH ▲] on the main unit until the Country setting screen appears.

- All the settings except for the ratings level, ratings password and time settings return to the factory preset. The timer recording programmes are also cancelled.

STEP 3 Set up to match your television and remote control

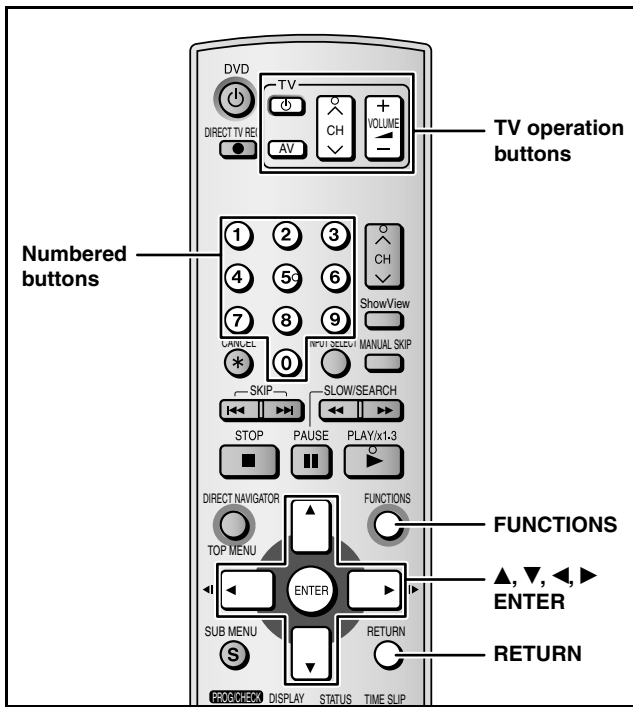

Selecting television type and aspect

Choose the setting to suit your television and preference.

- 1 While stopped
Press [FUNCTIONS].
- 2 Press [▲, ▼] to select "To Others" and press [ENTER].



- 3 Press [▲, ▼] to select "SETUP" and press [ENTER].

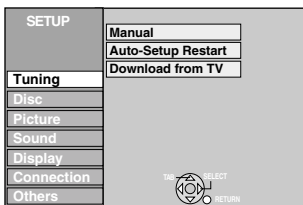

- 4 Press [▲, ▼] to select "Connection" and press [▶].
- 5 Press [▲, ▼] to select "TV Aspect" and press [ENTER].

- 6 Press [▲, ▼] to select the TV aspect and press [ENTER].

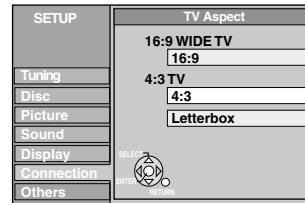

- **16:9:** 16:9 widescreen television
- **4:3:** 4:3 standard aspect television
- **RAM** Even if it records and plays, the aspect does not change.
- **DVD-V** Video recorded for a widescreen is played as Pan & Scan (unless prohibited by the producer of the disc) (→ page 41).
- **Letterbox:** 4:3 standard aspect television
Widescreen picture is shown in the letterbox style (→ page 41).

To enjoy progressive video

You can enjoy progressive video by connecting this unit's COMPONENT VIDEO OUT terminals to an LCD/plasma television or LCD projector compatible with progressive scan (→ page 41).

- 1 While stopped
Press [FUNCTIONS].
- 2 Press [▲, ▼] to select "To Others" and press [ENTER].
- 3 Press [▲, ▼] to select "SETUP" and press [ENTER].
- 4 Press [▲, ▼] to select "Connection" and press [▶].
- 5 Press [▲, ▼] to select "Progressive" and press [ENTER].
- 6 Press [▲, ▼] to select "On" and press [ENTER].
Output becomes progressive.

Note

- When connected to a CRT (Cathode ray tube) television, even if it is progressive compatible, progressive output can cause some flickering. Turn off "Progressive" if this occurs (→ page 25).
- Picture will not be displayed correctly if connected to an incompatible television.
- There is no output from the COMPONENT VIDEO OUT terminals if "AV1 Output" in the SETUP menu is set to "RGB (without component)". Set this item to either "Video (with component)" or "S Video (with component)" (→ page 35).
- If the unit is connected to the television through VIDEO OUT, S VIDEO OUT or AV1 terminal, output will be interlace irrespective of the settings.

To exit the screen

Press [RETURN] several times.

To return to the previous screen

Press [RETURN].

Television operation

You can configure the remote control TV operation buttons to turn the television on/off, change the television input mode, select the television channel and change the television volume.

Point the remote control at the television

While pressing [TV], enter the code with the numbered buttons.

e.g., 01: [0] → [1]

Manufacturer and Code No.

Brand	Code	Brand	Code
Panasonic	01, 02, 03, 04, 45	NOKIA	25, 26, 27
AIWA	35	NORDMENDE	10
AKAI	27, 30	ORION	37
BLAUPUNKT	09	PHILIPS	05, 06
BRANDT	10, 15	PHONOLA	31, 33
BUSH	05, 06	PIONEER	38
CURTIS	31	PYE	05, 06
DESMET	05, 31, 33	RADIOLA	05, 06
DUAL	05, 06	SABA	10
ELEMIS	31	SALORA	26
FERGUSON	10	SAMSUNG	31, 32, 43
GOLDSTAR/LG	31	SANSUI	05, 31, 33
GOODMANS	05, 06, 31	SANYO	21
GRUNDIG	09	SBR	06
HITACHI	22, 23, 31, 40, 41, 42	SCHNEIDER	05, 06, 29, 30, 31
INNO HIT	34	SELECO	06, 25
IRRADIO	30	SHARP	18
ITT	25	SIEMENS	09
JVC	17, 39	SINUDYNE	05, 06, 33
LOEWE	07	SONY	08
METZ	28, 31	TELEFUNKEN	10, 11, 12, 13, 14
MITSUBISHI	06, 19, 20	THOMSON	10, 15, 44
MIVAR	24	TOSHIBA	16
NEC	36	WHITE WESTINGHOUSE	05, 06

Test by turning on the television and changing channels. Repeat the procedure until you find the code that allows correct operation.

- If your television brand is not listed or if the code listed for your television does not allow control of your television, this remote control is not compatible with your television.

When other Panasonic products respond to this remote control

If other Panasonic products are placed close together, change the remote control code on the main unit and the remote control (the two must match).

Under normal circumstances use the factory set code "DVD 1".

- 1 While stopped
Press [FUNCTIONS].
- 2 Press [▲, ▼] to select "To Others" and press [ENTER].
- 3 Press [▲, ▼] to select "SETUP" and press [ENTER].
- 4 Press [▲, ▼] to select "Others" and press [▶].
- 5 Press [▲, ▼] to select "Remote Control" and press [ENTER].
- 6 Press [▲, ▼] to select the code ("DVD 1", "DVD 2" or "DVD 3") and press [ENTER].

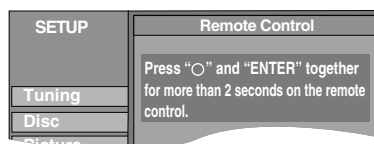

To change the code on the remote control

- 7 While pressing [ENTER], press and hold the numbered button ([1], [2] or [3]) for more than 2 seconds.
- 8 Press [ENTER].

- When the following indicator appears on the unit's display



Press and hold [ENTER] and the indicated number button at the same time for more than 2 seconds.

Note

Executing "Shipping Condition" in the SETUP menu returns the main unit code to "DVD 1". Change the remote control code to 1 (→ step 7).

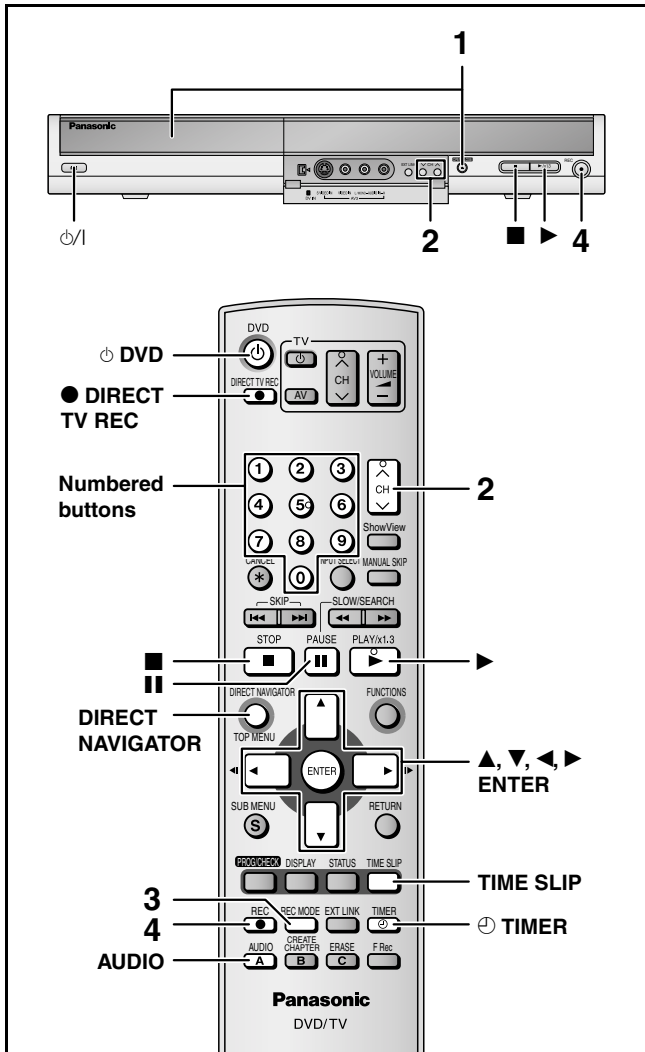

FR (Flexible Recording) Mode

The unit automatically selects a recording rate between XP and EP (8Hours) that will enable the recordings to fit in the remaining disc space with the best possible recording quality.

- You can set when programming timer recordings.
- All the recording modes from "XP" to "EP" appear in the display.



Recording television programmes

RAM -R -RW(V) +R

- It is not possible to record continuously from one side of a double sided disc to the other. You will need to eject the disc and turn it over.
- When using 8 cm DVD-RAM or 8 cm DVD-R, remove the disc from the cartridge.
- You can record up to 99 titles on one disc (+R 49 titles).
- It is not possible to record digital broadcasts that allow "One time only recording" onto DVD-R, DVD-RW, +R or 8 cm DVD-RAM discs. Use a CPRM compatible DVD-RAM.

When recording to DVD-R, DVD-RW (DVD-Video format) or +R

- When recording bilingual TV broadcast onto DVD-R, DVD-RW or +R, only one of either "M 1" or "M 2" audio can be recorded. Select at "Bilingual Audio Selection" (→ page 35).
- The aspect ratio of the recorded images will be 4:3.
- In order to play a DVD-R, DVD-RW (DVD-Video format) or +R recorded using this unit on another playback source, the disc must first be finalized (→ page 32).

Preparation

- Turn on the television and select the appropriate video input to suit the connections to this unit.
- Turn the unit on.

1 Press [▲ OPEN/CLOSE] on the main unit to open the tray and insert a disc.

- Press the button again to close the tray.

Insert label-up.

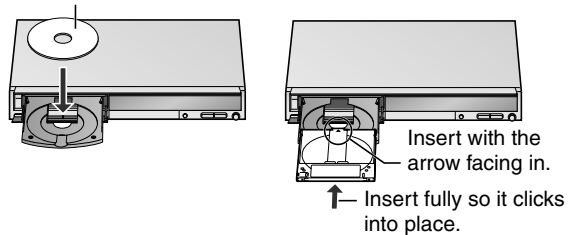

2 Press [^ v CH] to select the channel.



To select with the numbered buttons:

e.g., 5: [0] → [5]

15: [1] → [5]

3 Press [REC MODE] to select the recording mode (XP, SP, LP or EP).



Remaining time on the disc

4 Press [● REC] to start recording.



The elapsed time is shown on the display.

Recording will take place on open space on disc. Data will not be overwritten.

- You cannot change the channel or recording mode during recording. You can change the channel or recording mode while paused; however, the recording will then be as a separate title.
- **RAM** You can change the audio being received by pressing [AUDIO] during recording. (This does not affect the actual recording of the audio.)

Recording modes and approximate recording times

Depending on the content being recorded, the recording times may become shorter than indicated.

(Unit: hour)

Mode	DVD-RAM		DVD-R DVD-RW +R (4.7 GB)
	Single-sided (4.7 GB)	Double-sided (9.4 GB)	
XP (High quality)	1	2	1
SP (Normal)	2	4	2
LP (Long play)	4	8	4
EP (Extra long play)	8 (6*)	16 (12*)	8 (6*)
FR (Automatic mode selection)	8 hours maximum	8 hours maximum for one side	8 hours maximum

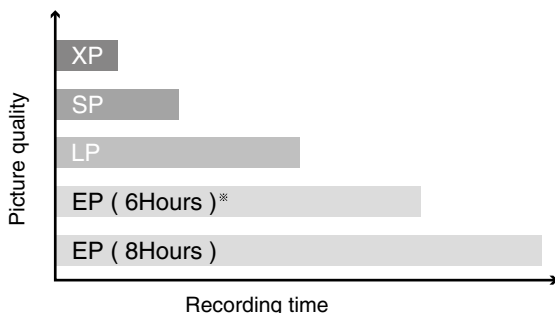

* When "Recording time in EP mode" is set to "EP (6Hours)" in the SETUP menu.

The sound quality is better when using "EP (6Hours)" than when using "EP (8Hours)".

Note

When recording to DVD-RAM using EP (8Hours) mode, play may not be possible on DVD players that are compatible with DVD-RAM. In this case use EP (6Hours) mode.

■ To stop recording

Press [■].

From the start to the end of the recording is called one title.

-R -RW(V) +R

It takes about 30 seconds for the unit to complete recording management information after recording finishes.

■ To pause recording

Press [II].

Press again to restart recording.

You can also press [● REC] to restart.

(Recorded title is not split into separate titles.)

Quick Start

1 Sec. Quick Start for Recording on DVD-RAM

Recording on DVD-RAM starts about 1 second after first pressing [⏪] or [⏩ DVD] to turn on the unit and then sequentially pressing [● REC] (Quick Start Mode).

It is set to "On" at the time of purchase (→ page 36).

Note

Startup takes more time when:

- You play a disc or start recording to discs other than DVD-RAM.
- The clock has not been set.

To specify a time to stop recording—One Touch Recording

During recording

Press [● REC] on the main unit to select the recording time.

Each time you press the button:

30 (min.) → 60 (min.) → 90 (min.) → 120 (min.)
 ↑ Counter (cancel) ← 240 (min.) ← 180 (min.) ←

- This does not work during timer recordings (→ page 17) or while using Flexible Recording (→ page 16).

If a station also broadcasts Teletext information

The unit automatically records the programme's and station's name if the station's Title Page is correctly set (→ page 37).

Note

The unit may take some time in retrieving titles (up to 30 minutes) and may fail in some cases.

When the format confirmation screen is displayed

When you insert a new DVD-RW or a DVD-RAM or DVD-RW (DVD-Video format) recorded on a computer or other equipment, a format confirmation screen is displayed. Format the disc to use it. However all the recorded contents are erased.

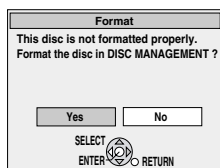

Press [◀] to select "Yes" and press [ENTER].

■ To format a disc

(Several steps are necessary to format a disc.)

"Erasing all the contents of a disc—Format Disc" (→ page 32)

Direct TV Recording

When connected to a television that has the Q Link function using a fully wired 21-pin Scart cable (→ page 7).

This function allows you to immediately start recording the programme that you are viewing on the TV.

1 Insert a disc. (→ page 14)

2 Press and hold [● DIRECT TV REC] for 1 second.

Recording starts.

To stop recording

Press [■].

Playing while you are recording

RAM

Playing from the beginning of the title you are recording—Chasing playback

Press [▶] (PLAY) during recording.

Playing a title previously recorded while recording—Simultaneous rec and play

1 Press [DIRECT NAVIGATOR] during recording.

2 Press [▲, ▼, ◀, ▶] to select a title and press [ENTER].

To exit the Direct Navigator screen

Press [DIRECT NAVIGATOR].

Reviewing the recorded images while recording—Time Slip

1 Press [TIME SLIP] during recording.

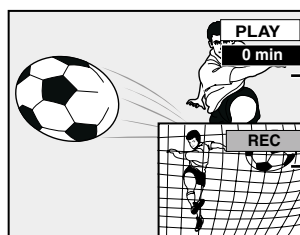

Play starts from 30 seconds previous.

The current recording images

- You will hear the playback audio.

2 Press [▲, ▼] to select the time and press [ENTER].

- Press [TIME SLIP] to show the play images in full. Press again to show the play and recording images.

■ To stop play

Press [■].

■ To stop recording

2 seconds after play stops

Press [■].

■ To stop timer recording

Press [⏸ TIMER].

- You can also press and hold [■] on the main unit for more than 3 seconds to stop recording.

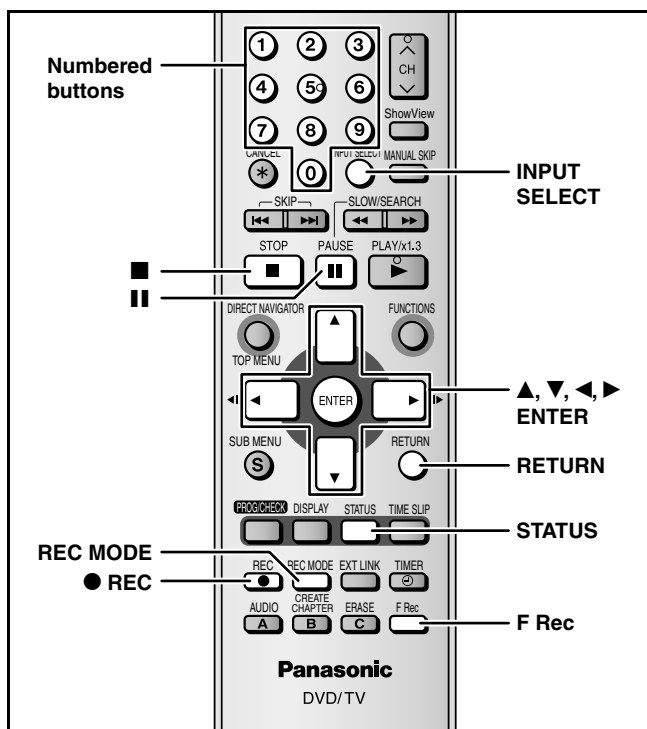

Flexible Recording

RAM -R -RW(V) +R

The unit sets the best possible picture quality that fits the recording within the remaining disc space.

Preparation

- Select the channel to record or the external input.

1 While stopped

Press [F Rec].

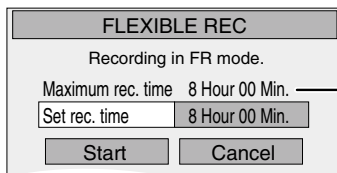

Maximum recording time
This is the maximum recording time in EP mode.

2 Press [◀, ▶] to select "Hour" and "Min." and press [▲, ▼] to set the recording time.

- You can also set the recording time with the numbered buttons.

3 When you want to start recording

Press [▲, ▼, ▶, ◀] to select "Start" and press [ENTER].

Recording starts.

- All the recording modes from XP to EP appear in the display.



To exit the screen without recording

Press [RETURN].

e.g., DVD-RAM

To stop recording partway

Press [■].

To show the remaining time

Press [STATUS].

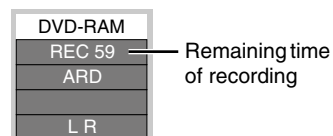

Note

When performing EXT LINK recording (→ page 19), the flexible recording function does not work.

Using "Flexible Recording" is convenient in these kind of situations

- When the amount of free space on the disc makes selecting an appropriate recording mode difficult
- When you want to record a long programme with the best picture quality possible

e.g., Recording a 90 minutes programme to disc

XP mode
<p>If you select XP mode, the programme will not fit one disc.</p>
SP mode
<p>If you select SP mode, the programme will fit one disc.</p>
FLEXIBLE REC
<p>If you select "FLEXIBLE REC", the programme will fit one disc perfectly.</p>

■ : necessary space for recording

Recording from digital/satellite receiver or decoder

Preparation

- Connect a digital/satellite receiver or decoder to this unit's input terminals (→ page 9).
- When recording bilingual programmes

RAM

When both M 1 and M 2 is selected on the connected equipment, you can select the audio type in playback.

-R -RW(V) +R

Select either M 1 and M 2 on the connected equipment. (The selected audio only is recorded.)

- When the output signal from the external equipment is NTSC, change the "TV System" to "NTSC" in the SETUP menu (→ page 38).

1 While stopped

Press [INPUT SELECT] to select the input channel for the equipment you have connected.

e.g., If you have connected to AV2 input terminals, select "AV2".

2 Press [REC MODE] to select the recording mode.

3 Select the channel on the other equipment.

4 Press [● REC].

Recording starts.

To skip unwanted parts

Press [■] to pause recording. (Press again to restart recording.)

To stop recording

Press [■].

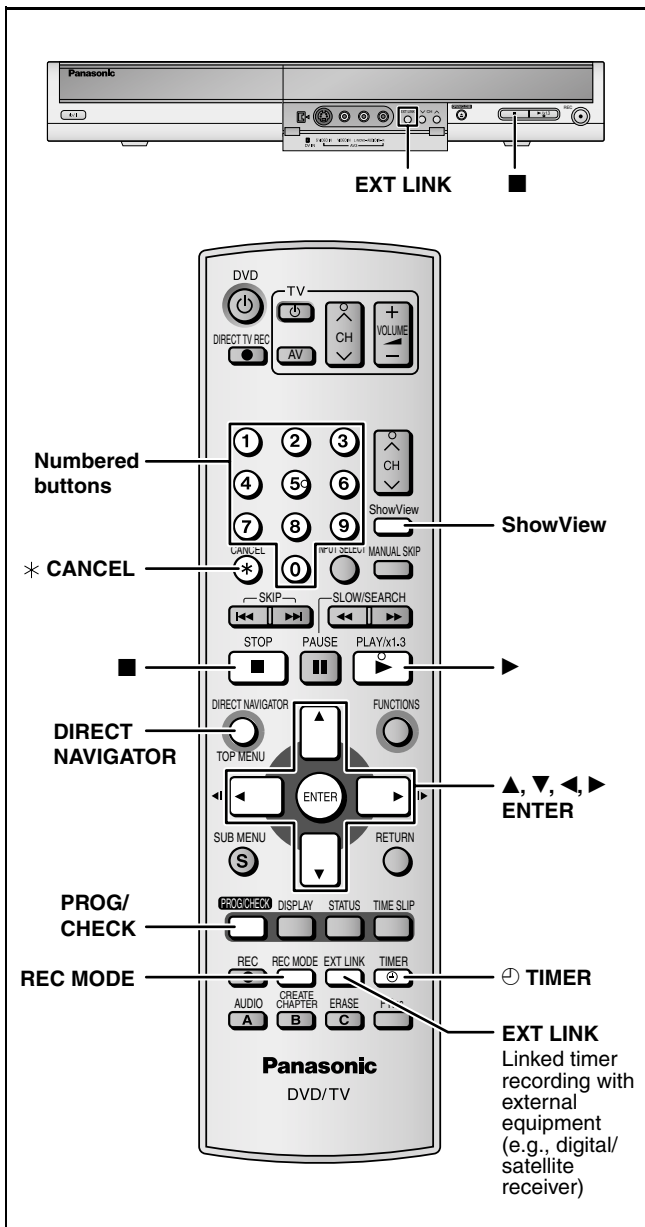

3 Press [ENTER].

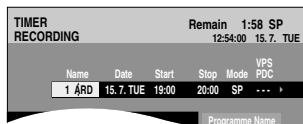

- Confirm the programme and make corrections if necessary using [▲, ▼, ◀, ▶] (→ page 18, Manually programming timer recordings, step 3).
- When “-- ----” appears in the “Name” column, you cannot set timer recording. Press [▲, ▼] to select desired programme position. After you have entered the information of a TV station, it is kept in the unit’s memory.
- You can also press [REC MODE] to change the recording mode.
- **VPS/PDC** (→ below)
ON ← → OFF (---)
- **Programme Name**
Press [◀, ▶] to select “Programme Name” and press [ENTER] (→ page 33).

4 Press [ENTER].

The settings are stored.

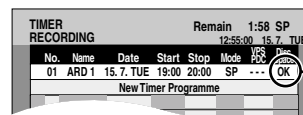

Repeat steps 1–4 to programme other recordings.

5 Press [⏻ TIMER].

The unit turns off and “⏻” lights on the unit’s display to indicate timer recording standby has been activated.

RAM

Even if the unit is in timer recording standby, play starts when you press [▶] (PLAY) or [DIRECT NAVIGATOR]. Timer recording works even during play.

■ To release the unit from recording standby

Press [⏻ TIMER].

The unit turns on and “⏻” goes out.

- Be sure to press [⏻ TIMER] before the programme start time to put the unit on recording standby. Timer recording will work only if “⏻” is displayed.

■ To cancel recording when recording has already begun

Press [⏻ TIMER].

- You can also press and hold [■] on the main unit for more than 3 seconds to stop recording.

Note

- “⏻” flashes for about 5 seconds when the unit cannot go to timer recording standby (e.g., a recordable disc is not in the disc tray).
- If the unit is not put in the timer recording standby mode at the latest 10 minutes before the programmed timer recording starting time, the “⏻” flashes on the unit display. In this case, press [⏻ TIMER] to put the unit in the timer recording standby mode.
- When you programme successive timer recordings to start immediately one after the other, the unit cannot record the part at the beginning of the later programmes (a few seconds when recording with DVD-RAM and approximately 30 seconds when recording with DVD-R, DVD-RW (DVD-Video format) and +R).

■ VPS/PDC function (→ page 41)

As long as a VPS/PDC signal is being broadcast by the TV station, even if the broadcast programme time changes, the recording time automatically changes to match the new broadcast time.

To activate the VPS/PDC function

In step 3 in the VPS/PDC column, press [▲, ▼] to select “ON”.

RAM -R -RW(V) +R

You can enter up to 16 programmes up to a month in advance.

Preparation

- Turn on the television and select the appropriate video input to suit the connections to this unit.
- Check the time on the unit is correct.

Using SHOWVIEW system to make timer recordings

Entering SHOWVIEW numbers is an easy way of timer recording. You can find these numbers in TV listings in newspapers and magazines.

1 Press [ShowView].

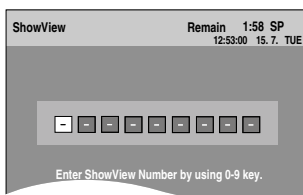

2 Press the numbered buttons to enter the SHOWVIEW number.

- To correct the number

Press [◀] to move back to correct a digit.

Refer to the control reference on page 17.

You can enter up to 16 programmes up to a month in advance. (Each daily or weekly programme is counted as one programme.)

Preparation

- Turn on the television and select the appropriate video input to suit the connections to this unit.
- Check the time on the unit is correct.

Manually programming timer recordings

RAM -R -RW(V) +R

1 Press [PROG/CHECK].

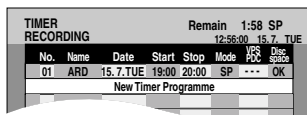

2 Press [▲, ▼] to select “New Timer Programme” and press [ENTER].

3 Press [▶] to move through the items and change the items with [▲, ▼].

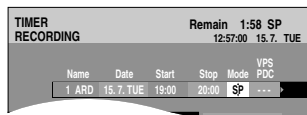

- Press and hold [▲, ▼] to alter Start (Start time) and Stop (Finish time) in 30-minute increments.
- You can also set Name (Programme position/TV Station Name), Date, Start (Start time), and Stop (Finish time) with the numbered buttons.
- You can also press [REC MODE] to change the recording mode.

•Date

- Date: Current date up to one month later minus one day
- ↓↑
- Daily timer: SUN-SAT → MON-SAT → MON-FRI
- ↓↑
- Weekly timer: SUN → ---- → SAT

•VPS/PDC (→ page 17)

ON ← → OFF (---)

•Programme Name

Press [◀, ▶] to select “Programme Name” and press [ENTER] (→ page 33).

4 Press [ENTER].

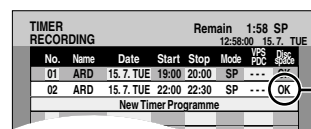

Check to make sure “OK” is displayed.

Repeat steps 2–4 to programme other recordings.

5 Press [⏻] TIMER.

The unit turns off and “⏻” lights on the unit’s display to indicate timer recording standby has been activated.

RAM

Even if the unit is in timer recording standby, play starts when you press [▶] (PLAY) or [DIRECT NAVIGATOR]. Timer recording works even during play.

■ To release the unit from recording standby

Press [⏻] TIMER.

The unit turns on and “⏻” goes out.

- Be sure to press [⏻] TIMER before the programme start time to put the unit on recording standby. Timer recording will work only if “⏻” is displayed.

■ To cancel recording when recording has already begun

Press [⏻] TIMER.

- You can also press and hold [■] on the main unit for more than 3 seconds to stop recording.

Note

- “⏻” flashes for about 5 seconds when the unit cannot go to timer recording standby (e.g., a recordable disc is not in the disc tray).
- If the unit is not put in the timer recording standby mode at the latest 10 minutes before the programmed timer recording starting time, the “⏻” flashes on the unit display. In this case, press [⏻] TIMER to put the unit in the timer recording standby mode.
- When you programme successive timer recordings to start immediately one after the other, the unit cannot record the part at the beginning of the later programmes (a few seconds when recording with DVD-RAM and approximately 30 seconds when recording with DVD-R, DVD-RW (DVD-Video format) and +R).

Check, change or delete a programme

RAM -R -RW(V) +R

Even when the unit is turned off, you can display the timer recording list by pressing [PROG/CHECK].

Press [PROG/CHECK].

Icons

- This programme is currently recording.
- Ⓜ The times overlap those in another programme. Recording of the programme with the later start time starts when the earlier programme finishes recording.
- Ⓢ The disc was full so the programme failed to record.
- Ⓣ The material was copy-protected so it was not recorded.
- Ⓧ The programme did not complete recording because the disc is dirty or some other reason.

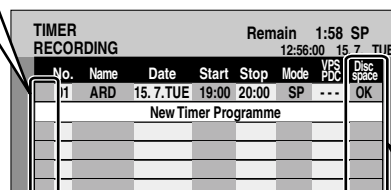

Message displayed in the “Disc space” line

- OK:** Displayed if the recording can fit in the remaining space.
- **(Date):** For recordings made daily or weekly, the display will show until when recordings can be made (up to a maximum of one month from the present time) based on the time remaining on the disc.
- ! :** It may not be possible to record because:
 - the disc is write-protected
 - there is no more space left
 - the number of possible titles has reached its maximum.

■ To change a programme

Press [▲, ▼] to select the programme and press [ENTER].
(→ page 18, Manually programming timer recordings, step 3)

■ To delete a programme

Press [▲, ▼] to select the programme and press [* CANCEL].

■ To exit the timer recording list

Press [PROG/CHECK].

■ To put the unit on timer recording standby

Press [⏸ TIMER].

The unit turns off and “⏸” lights on the unit’s display to indicate timer recording standby has been activated.

- Programmes that failed to record are deleted from the timer recording list at 4 a.m. two days later.

Making timer recordings on the television

(e.g., of digital broadcasts)

RAM **-R** **-RW(V)** **+R**

To make a timer recording with your television, connect to a television with a Q Link function (→ page 41) that you can use for setting timer recordings using a fully wired 21-pin Scart cable (→ page 7).

1 Make timer programming on the TV.

2 Insert a disc.

3 Turn off the unit.

The start and end of recording is controlled by TV.

To stop recording

Press [■].

Note

- When this unit is in timer recording standby or EXT LINK standby (“⏸” or “EXT Link” on the unit’s display), recording from TV does not start.
- Programmes are recorded as one title on this unit when the end time of the earlier timer recording and the start time of the later timer recording are close to each other.

RAM To divide the titles, go to “Divide Title” (→ page 27).

Linked timer recordings with external equipment (digital/satellite receiver)–EXT LINK

RAM **-R** **-RW(V)** **+R**

To record programmes from a digital/satellite receiver using timer programming

Preparation

- Make sure you connect the AV2 input terminal of this unit to “VCR Scart Terminal” of a digital/satellite receiver with a 21-pin scart cable (→ page 9).
- Set the “AV2 Input” to match the connected equipment in the SETUP menu (→ page 35).
- Set the “Ext Link” to match the connected equipment in the SETUP menu (→ page 35).
Ext Link 1: Start and stop timings of recording are controlled by the control signal from a digital/satellite receiver.
Ext Link 2: When an external equipment with a timer function turns on, recording starts.
When it turns off, recording stops.

1 Make timer programming on the external equipment.

2 Insert a disc.

3 Press [EXT LINK].

The unit turns off and “EXT Link” lights on the unit’s display to indicate timer recording standby has been activated.

To cancel the external control

Press [EXT LINK] to stop recording or to cancel linked timer recording standby.

- In order to prevent accidental operation, press [EXT LINK] to cancel the setting after recording is finished.

For your reference

- This function does not work with some equipment. Refer to the equipment’s operating instructions.
- The beginnings of recordings may not be recorded correctly in some cases.
- When “Ext Link” is set to “Ext Link 2”, this function does not work if the input signal is NTSC system.
- When “AV2 Connection” is set to “Decoder”, EXT LINK is not available (→ page 35).
- Programmes are recorded as one title on this unit when the end time of the earlier timer recording and the start time of the later timer recording are close to each other.

RAM To divide the titles, go to “Divide Title” (→ page 27).

- While the unit is in EXT LINK standby mode or recording, video picture is from the AV2 input terminal irrespective of “AV1 Output” setting.

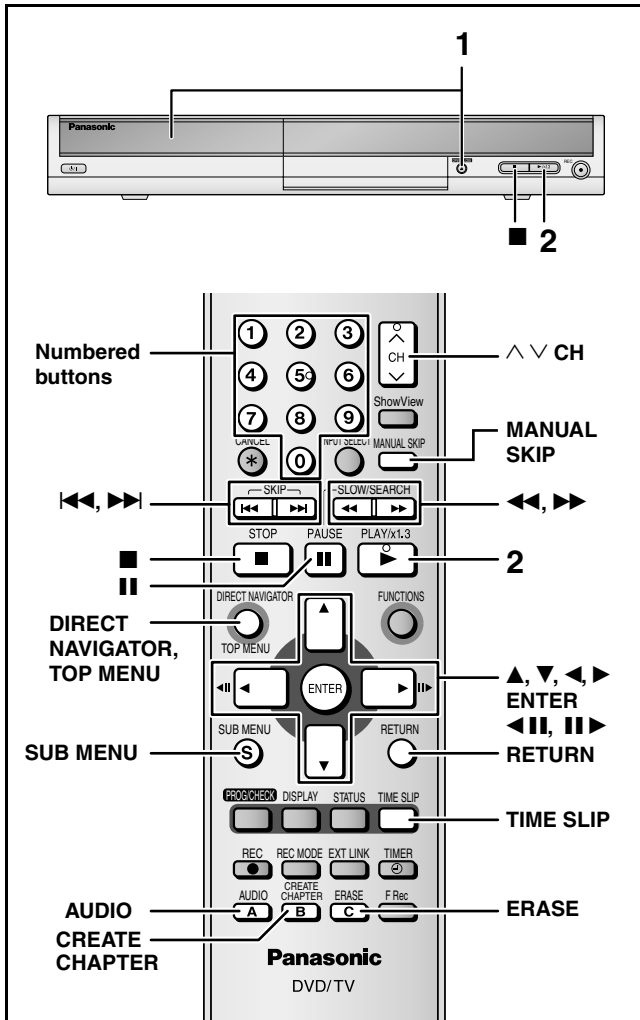

Preparation

- Turn on the television and select the appropriate video input to suit the connections to this unit.
- Turn on this unit.
- It is not possible to play continuously from one side of a double sided disc to the other. You will need to eject the disc and turn it over.
- When using 8 cm DVD-RAM or 8 cm DVD-R, remove the disc from the cartridge.
- For a DVD-RAM with a cartridge
With the write-protect tab in the protect position, play automatically starts when inserted in the unit.
- Depending on the disc, it may take time for the menu screen, pictures, sound etc. to start.

1 Press [▲ OPEN/CLOSE] on the main unit to open the tray and insert a disc.

- Press the button again to close the tray.

Insert label-up.

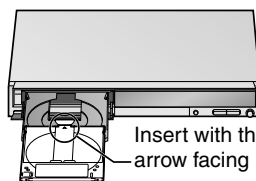
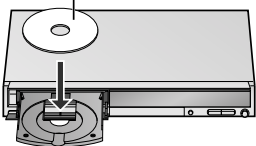

Insert with the arrow facing in.
↑ Insert fully so it clicks into place.

2 Press [▶] (PLAY).

RAM -R -RW(V) +R -RW(VR)

Play starts from the most recently recorded title.

DVD-V DVD-A CD VCD

Play starts from the beginning of the disc.



■ Selecting recorded programmes (titles) to play

RAM -R -RW(V) +R -RW(VR)

1 Press [DIRECT NAVIGATOR].

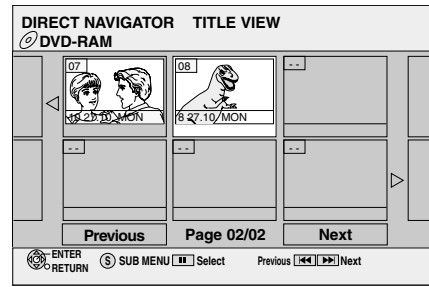

2 Press [▲, ▼, ◀, ▶] to select the title and press [ENTER].

You can also select titles with the numbered buttons.
e.g., 5: [0] → [5] 15: [1] → [5]

To show other pages

Press [▲, ▼, ◀, ▶] to select "Previous" or "Next" and press [ENTER].

- You can also press [◀◀, ▶▶] to show other pages.

To exit the screen

Press [DIRECT NAVIGATOR].

Direct Navigator screen icons

- Currently recording.
- 🔒 Title protected.
- 📄 Title that was not recorded due to recording protection (Digital broadcasts etc.)
- ✗ Title cannot be played because data is damaged.
- 📁 Title with "One time only recording" restriction
- 🇺🇸 (NTSC) Title recorded using a different encoding system from that of the TV system currently selected on the unit.
- 🇵🇸 (PAL)

■ When a menu screen appears on the television

DVD-V DVD-A

Press [▲, ▼, ◀, ▶] to select the item and press [ENTER].

Some items can also be selected using the numbered buttons.

VCD

Press the numbered buttons to select the item.

e.g., 5: [0] → [5] 15: [1] → [5]

- To return to the menu screen

DVD-V Press [TOP MENU] or [SUB MENU].

DVD-A Press [TOP MENU].

VCD Press [RETURN].

Changing audio during play

Press [AUDIO].

RAM -RW(VR) VCD

LR → L → R

e.g., "L R" is selected

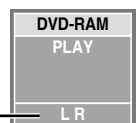



DVD-V DVD-A

You can change the audio channel number each time you press the button. This allows you to change things like the soundtrack language.



e.g., **DVD-V** English is the selected language (→ page 24, Soundtrack).

Operations during play

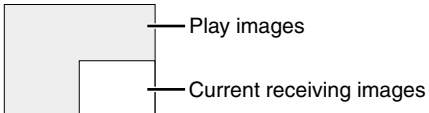
<p>Stop</p>	<p>Press [■]. The stopped position is memorized. When stopped position is memorized (resume), the indicator appears in the unit's display. (Excluding when playing from the Direct Navigator and when playing a playlist.) Resume play function Press [▶] (PLAY) to restart from this position. Stopped position</p> <ul style="list-style-type: none"> • If [■] is pressed several times, the indicator disappears and the position is cleared. • The position is cleared if the unit is turned off or the tray is opened. 	
<p>Pause</p>	<p>Press [⏸]. Press again or press [▶] (PLAY) to restart play.</p>	
<p>Search</p>	<p>Press [◀◀] or [▶▶].</p> <ul style="list-style-type: none"> • The speed increases up to 5 steps. • Press [▶] (PLAY) to restart play. • Audio is heard during first level search forward. Audio is heard during all levels of search. DVD-A (excluding moving picture parts) CD • Depending on the disc, searching may not be possible. 	
<p>Skip</p>	<p>While playing or paused, press [◀◀] or [▶▶].</p> <ul style="list-style-type: none"> • Each press increases the number of skips. 	
<p>Starting from a selected title</p>	<p>Press the numbered buttons.</p> <ul style="list-style-type: none"> • This works only when stopped (screen saver is displayed on the television → right) with some discs. e.g., 5: [0] → [5] CD (MP3, JPEG and TIFF discs only) 5: [0] → [0] → [5] 15: [1] → [5] 15: [0] → [1] → [5] • DVD-A Selecting groups While stopped (screen saver is displayed on the television → right) 5: [5] 	
<p>Quick View RAM The play speed can be increased without distorting the audio.</p>	<p>Press and hold [▶] (PLAY/x1.3). Press again to return to normal speed.</p>	
<p>Slow-motion RAM -R -RW(V) +R DVD-V DVD-A (Motion picture parts only) -RW(VR) VCD</p>	<p>While paused, press [◀◀] or [▶▶].</p> <ul style="list-style-type: none"> • The speed increases up to 5 steps. • Press [▶] (PLAY) to restart play. • Forward direction only. VCD • The unit will pause if slow-motion play is continued for approximately 5 minutes (excluding DVD-V DVD-A VCD). 	
<p>Frame-by-frame RAM -R -RW(V) +R DVD-V DVD-A (Motion picture parts only) -RW(VR) VCD</p>	<p>While paused, press [◀] (◀◀) or [▶] (▶▶).</p> <ul style="list-style-type: none"> • Each press shows the next frame. • Press and hold to change in succession forward or backward. • Press [▶] (PLAY) to restart play. • Forward direction only. VCD 	
<p>Displaying the television image as a picture-in-picture</p>	<p>Press [TIME SLIP]. The unit displays the television image as a picture-in-picture.</p> <ul style="list-style-type: none"> • You will hear the playback audio. • Press [TIME SLIP] again to cancel. • Time Slip does not work when the unit's "TV System" settings are different from the title recorded on the disc. 	 <ul style="list-style-type: none"> • You can change the channel being received by pressing [^ ∨ CH]. • You cannot change the channel being received while recording.
<p>Skipping the specified time (Time Slip) RAM -R -RW(V) +R -RW(VR)</p>	<p>1 Press [TIME SLIP]. 2 Press [▲, ▼] to select the time and press [ENTER]. Play skips the specified time.</p> <ul style="list-style-type: none"> • Press [TIME SLIP] to show the play images in full. 	
<p>Manual Skip RAM -R -RW(V) +R -RW(VR) Play restarts from approximately 30 seconds later.</p>	<p>Press [MANUAL SKIP].</p>	

Editing operations during play

<p>Erase RAM -R -RW(V) +R Erase titles during play.</p>	<p>1 Press [ERASE]. 2 Press [◀, ▶] to select "Erase" and press [ENTER].</p> <ul style="list-style-type: none"> • A title cannot be restored once it is erased. Make certain before proceeding. • You cannot erase when recording at the same time. • The available recording space on DVD-R or +R does not increase when you erase titles. • Available recording space on a DVD-RW (DVD-Video format) increases only when the last recorded title is erased. It does not increase if other titles are erased. 	
<p>Create chapter RAM (→ page 26, Title/Chapter)</p>	<p>Press [CREATE CHAPTER]. Chapters are divided at the point pressed.</p> <ul style="list-style-type: none"> • You cannot create chapters when the unit is in timer recording standby. • You cannot create chapters when the unit is in EXT LINK standby. 	

Using menus to play MP3 and still pictures (JPEG/TIFF)

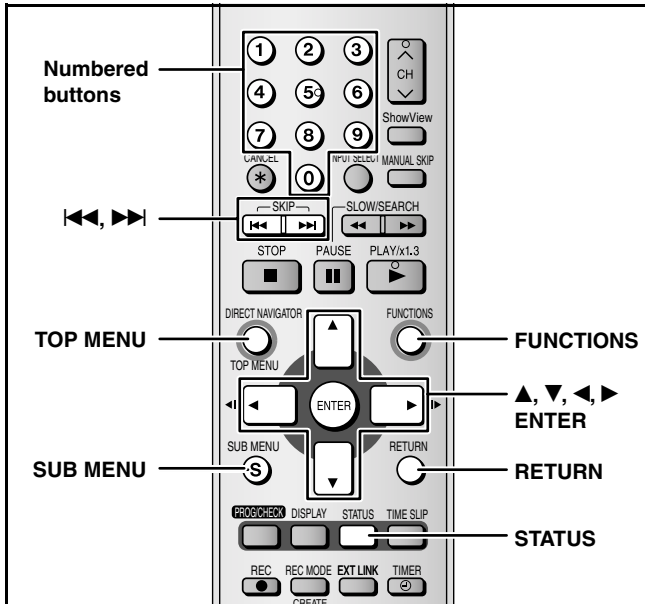

Regarding MP3 and still pictures (JPEG/TIFF)

- Compatible formats: ISO9660 level 1 or 2 (except for extended formats) and Joliet
- Maximum number of files (tracks) and folders (groups) recognizable: 999 files (tracks) and 99 folders (groups)
- This unit is compatible with multi-session but reading or play of the disc may take time if there are a lot of sessions.
- Operation may take time to complete when there are many files (tracks) and/or folders (groups) and some may not display nor be playable.
- The display order on this unit may differ from how the order is displayed on a computer.
- Depending on how you create the disc (writing software), files (tracks) and folders (groups) may not play in the order you numbered them.
- This unit is not compatible with packet-write format.
- Depending on the recording, some items may not be playable.

Regarding MP3

- File format: MP3
- Files must have the extension ".mp3" or ".MP3".
Bit rates: 32 kbps to 320 kbps
- Sampling frequency: 16 kHz/22.05 kHz/24 kHz/32 kHz/44.1 kHz/48 kHz
- This unit is not compatible with ID3 tags.

Regarding still pictures (JPEG/TIFF)

- File format: JPEG, TIFF (non-compressed RGB chunky format)
Files must have the extension ".jpg", ".JPG", ".tif" and ".TIF".
- Number of pixels: 34 x 34 to 6144 x 4096
(Sub sampling is 4:2:2 or 4:2:0)
- Operation may take time to complete when playing TIFF format still pictures.
- MOTION JPEG is not supported.

- You can play MP3 and still pictures (JPEG/TIFF) on this unit by making folders as shown below. However depending on how you create the disc (writing software), play may not be in the order you numbered the folders.
- When the highest level folders are "DCIM" folders, they are displayed first on the tree.

Structure of MP3 folders

Prefix with 3-digit numbers in the order you want to play them.

Structure of still pictures (JPEG/TIFF)

Files inside a folder are displayed in the order they were updated or taken.

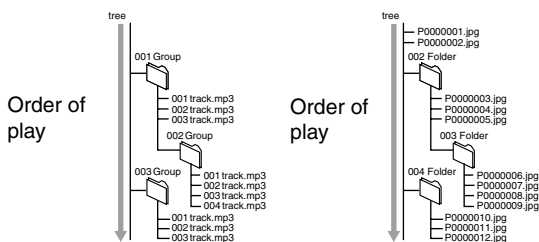

Playing MP3

[CD]

This unit plays MP3 files recorded on CD-R/RW designed for audio recording that are finalized (→ page 40) on a computer.

The screen shown right is displayed when you insert a disc containing MP3 files and still pictures (JPEG/TIFF).

Press [ENTER], and follow the steps below.

Playback mode is set to MP3. Select "JPEG" from MENU in FUNCTIONS if you play pictures (JPEG).



1 Press [TOP MENU].

G: Group no.

T: Track no. in the group

TOTAL: Track no./Total track no. in all groups

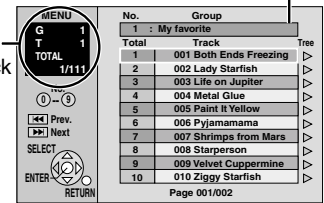

Selected group

- Files are treated as tracks and folders are treated as groups.
- When the JPEG Menu is displayed, select "MP3" in step 4 of "To select JPEG Menu" to change to the MP3 Menu (→ page 23).

2 Press [▲, ▼] to select the track and press [ENTER].

Play starts on the selected track.

- "3" indicates the track currently playing.
- You can also select the track with the numbered buttons.
e.g., 5: [0] → [0] → [5]
15: [0] → [1] → [5]

Using the tree screen to find a group

While the file list is displayed

1 Press [▶] while a track is highlighted to display the tree screen.

G: Selected group no. /Total group no.
If the group has no track, "-" is displayed as group number.

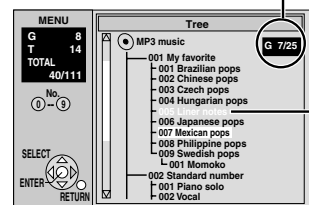

You cannot select groups that contain no compatible files.

2 Press [▲, ▼] to select a group and press [ENTER].

The file list for the group appears.

To show other pages

Press [◀, ▶].

To return to the previous screen

Press [RETURN].

To exit the screen

Press [TOP MENU].

Playing still pictures (JPEG/TIFF)

[CD]

You can play CD-R/CD-RW discs which contain still pictures (JPEG/TIFF) that have been recorded and finalized (→ page 40) on a computer.

The screen shown right is displayed when you insert a disc containing MP3 files and still pictures (JPEG/TIFF).

Select JPEG menu before perform following the steps below. (→ page 23, To select JPEG Menu)

Playback mode is set to MP3. Select "JPEG" from MENU in FUNCTIONS if you play pictures (JPEG).



1 Press [TOP MENU].

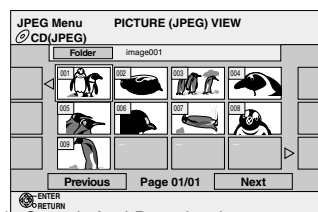

2 Press [▲, ▼, ◀, ▶] to select the still picture and press [ENTER].

- The selected still picture is displayed on the screen.
You can also select still pictures with the numbered buttons.
e.g., 5: [0] → [0] → [5]
15: [0] → [1] → [5]

■ To select another folder

While the JPEG Menu is displayed

1 Press [▲, ▼, ◀, ▶] to select "Folder" and press [ENTER].

F: Selected folder no./Total folder no.

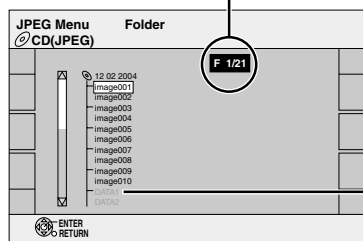

You cannot select folders that contain no compatible files.

2 Press [▲, ▼] to select the folder and press [ENTER].

To display the previous or next still picture during play

Press [◀, ▶].

To show other pages

Press [◀◀, ▶▶].

To return to the previous screen

Press [RETURN].

To exit the screen

Press [TOP MENU].

To select JPEG Menu

1 Press [ENTER].

2 Press [FUNCTIONS].

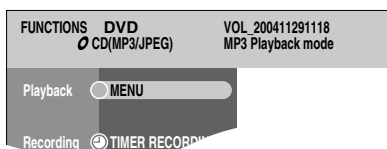

3 Press [▲, ▼] to select "MENU" and press [ENTER].

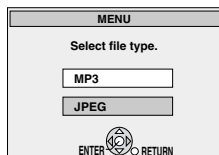

4 Press [▲, ▼] to select "JPEG" and press [ENTER].

To display still pictures one by one

After Step 1 (→ page 22, Playing still pictures (JPEG/TIFF))

2 Press [▲, ▼, ◀, ▶] to select "Folder" and press [SUB MENU].

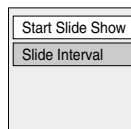

3 Press [▲, ▼] to select "Start Slide Show" and press [ENTER].

To change the slide interval

① In step 2 above, press [▲, ▼] to select "Slide Interval" and press [ENTER].

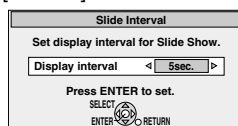

② Press [◀, ▶] to select the slide interval and press [ENTER].

- You can select a slide interval between 0-30 seconds.

To rotate and zoom in / zoom out

1 While playing

Press [SUB MENU].

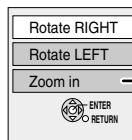

The "Zoom in / Zoom out" function is only available for still pictures smaller than 640 x 480 pixels.

2 Press [▲, ▼] to select the item and press [ENTER].

To return the picture to its original size

- Press [SUB MENU].
- Press [▲, ▼] to select "Zoom out" and press [ENTER].

To return the rotated picture to its original position

- Press [SUB MENU].
- Press [▲, ▼] to select the opposite rotation button and press [ENTER].

Note

- The rotation and enlargement information will not be stored.
- When zooming in, the picture may be cut off.

To view the picture properties

Press [STATUS] twice.

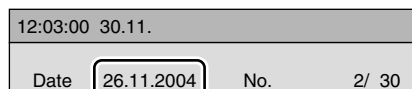

Shooting date

To exit the picture properties screen

Press [STATUS].

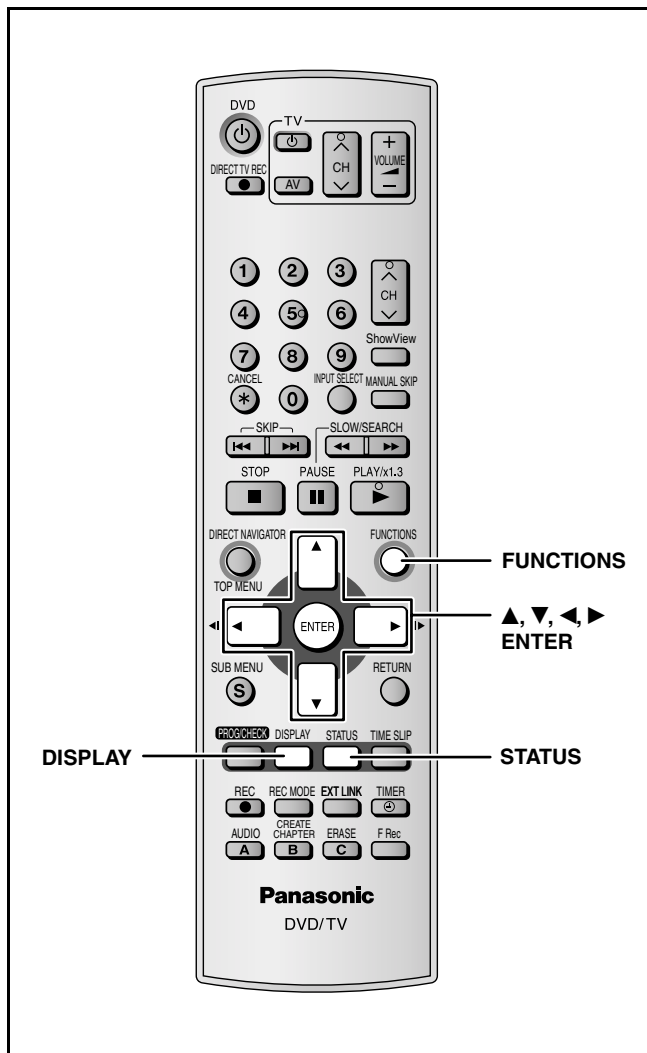

DISPLAY

FUNCTIONS

▲, ▼, ◀, ▶
ENTER

STATUS

Common procedures

1 Press [DISPLAY].

Disc	Soundtrack	1	Digital 2/0 ch
Play	Subtitle	Off	
Picture	Audio channel	L R	
Sound			
Other			

Menu Item Setting

• Depending on the condition of the unit (playing, stopped, etc.) and disc contents, there are some items that you cannot select or change.

2 Press [▲, ▼] to select the menu and press [▶].

3 Press [▲, ▼] to select the item and press [▶].

4 Press [▲, ▼] to select the setting.

• Some items can be changed by pressing [ENTER].

To clear the on-screen menus

Press [DISPLAY].

Disc menu—Setting the disc content

Soundtrack*

RAM -R -RW(V) +R -RW(VR)

The disc's audio attributes appear.

DVD-V DVD-A

Select the audio and language (→ below, Audio attribute, Language).

VCD (SVCD only)

Select the soundtrack number (1-2).

Subtitle*

DVD-V DVD-A

Turn the subtitle on/off and select the language (→ below, Language).

RAM -R -RW(V) +R -RW(VR) (Only discs that contain subtitle on/off information)

• Subtitle on/off information cannot be recorded using this unit.

VCD (SVCD only)

Turn the subtitle on/off and select the subtitle number (1-4).

Audio channel **RAM -RW(VR) VCD**

→ page 20, Changing audio during play

Angle* **DVD-V DVD-A**

Change the number to select an angle.

STILL-P (Still picture) **DVD-A**

Selects the play method for still pictures.

Slide Show: Plays according to the default order on the disc.

Page: Select the still picture number and play.

• **RANDOM:** Plays in random order.

• **Return:** Returns to the default still picture on the disc.

PBC (Playback control → page 41) **VCD**

Indicates whether menu play (playback control) is on or off. (unchangeable)

* With some discs, you may only be able to make changes using the menus (→ page 20) on the disc.

• The display changes according to the disc content. You cannot change when there is no recording.

Audio attribute

LPCM/PPCM/□□ Digital/DTS/MPEG:	Signal type
k (kHz):	Sampling frequency
b (bit):	Number of bits
ch (channel):	Number of channels

Language

ENG: English	SVE: Swedish	CHI: Chinese
FRA: French	NOR: Norwegian	KOR: Korean
DEU: German	DAN: Danish	MAL: Malay
ITA: Italian	POR: Portuguese	VIE: Vietnamese
ESP: Spanish	RUS: Russian	THA: Thai
NLD: Dutch	JPN: Japanese	*: Others

• Enter a code (→ page 36) when you select “*”: Others”.

Play menu—Change the play sequence

This function works only when the elapsed play time is displayed. Select the item for repeat play. Depending on the disc, the items that can be selected will differ.

Repeat play

- All **CD** (excluding MP3 discs) **VCD**
 - Chapter **RAM -R -RW(V) +R DVD-V -RW(VR)**
 - Group **DVD-A CD** (MP3 discs only)
 - PL (Playlist) **RAM**
 - Title **RAM -R -RW(V) +R DVD-V -RW(VR)**
 - Track **DVD-A CD VCD**
- Select “Off” to cancel.

Picture menu—Change the picture quality

Playback NR

Reduces noise and picture degradation.

Progressive* (→ page 41)

Select "On" to enable progressive output.
Select "Off" if the picture is stretched horizontally.

Transfer* (When "Progressive" is set to "On")

Select the method of conversion for progressive output to suit the type of title being played (→ page 40, Film and video).

When the output signal is PAL

- **Auto:** Detects 25 frame-per-second film content and appropriately converts it.
- **Video:** Select when using "Auto", and the video content is distorted.

When the output signal is NTSC

- **Auto 1 (normal):** Detects 24 frame-per-second film content and appropriately converts it.
- **Auto 2:** Compatible with 30 frame-per-second film content in addition to 24 frame-per-second film content.
- **Video:** Select when using "Auto 1" and "Auto 2", and the video content is distorted.

AV-in NR (Only when AV1, AV2, AV3, AV4 or DV is selected)

Reduces video tape noise while dubbing.

- **Automatic:** Noise reduction only works on picture input from a video tape.
- **On:** Noise reduction works for any input video.
- **Off:** Noise reduction is off. You can record the input signal as it is.

* Only when you have set "Progressive" to "On" in the SETUP menu (→ page 35).

Sound menu—Change the sound effect

V.S.S. **RAM** **-R** **-RW(V)** **+R** **DVD-V** **DVD-A** **-RW(VR)**
(Dolby Digital, MPEG, 2-channel or over only)

Enjoy a surround-like effect if you are using two front speakers only.

- Turn V.S.S. off if it causes distortion.
- V.S.S. does not work for bilingual recordings.

Dialog Enhancer **RAM** **-RW(V)** **+R** **DVD-V** **DVD-A** **-RW(VR)**
(Dolby Digital, 3-channel or over only, including a center channel)

The volume of the center channel is raised to make dialog easier to hear.

Other menu—Change the display position

Position

1 - 5: The higher the setting the lower the on-screen menu moves.

FUNCTIONS window

By using the FUNCTIONS window you may access the main functions quickly and easily.

1 While stopped Press [FUNCTIONS].

Functions displayed depend on the type of disc.

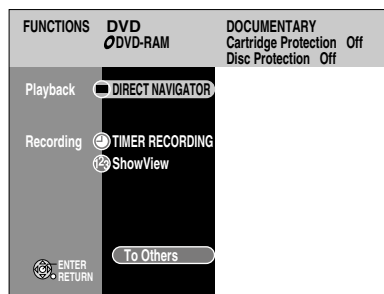

"To Others" ↓ ↑ "Return"

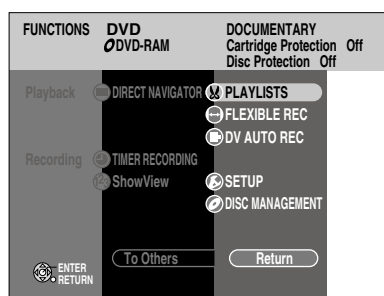

2 Press [▲, ▼] to select an item and press [ENTER].

- If you select "To Others", press [▲, ▼] to select an item (e.g., "SETUP" or "DISC MANAGEMENT") and press [ENTER].
- If you select "Return", press [▲, ▼] to select an item (e.g., "DIRECT NAVIGATOR" or "TIMER RECORDING") and press [ENTER].

To exit the FUNCTIONS window
Press [FUNCTIONS].

Status messages

Status messages appear on the television during operation to show the condition of the unit.

Press [STATUS].

The display changes each time you press the button.

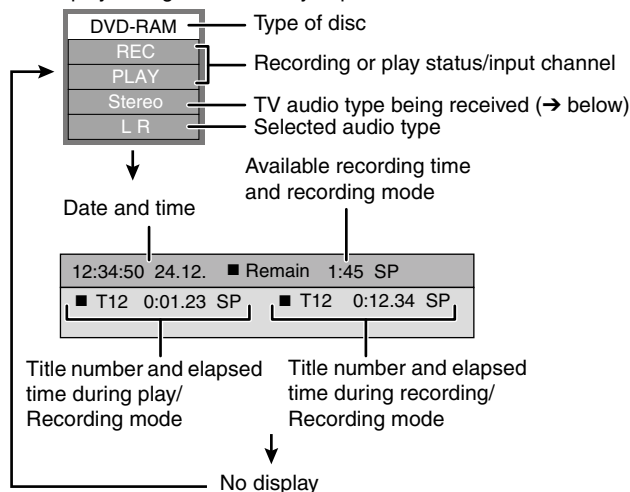

• TV audio type

- Stereo:** STEREO/NICAM stereo broadcast
- M 1/M 2:** Bilingual/NICAM dual-sound broadcast
- M 1:** NICAM monaural broadcast

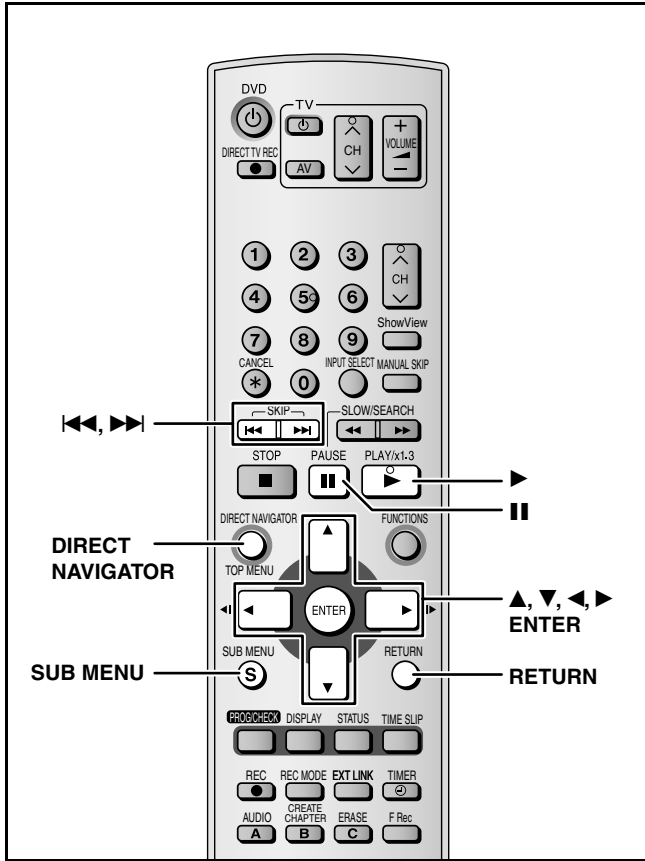

RAM -R -RW(V) +R

Title/Chapter

Programmes are recorded as a single title consisting of one chapter.

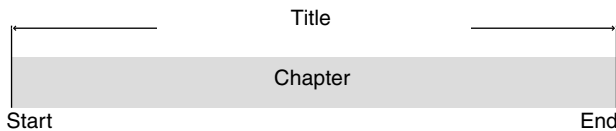

You can divide a title into multiple chapters. **RAM** (→ page 21, 27, "Create Chapter")



You can change the order of chapters and create a playlist (→ page 28). **RAM**

- Titles are divided into about 5-minute chapters after finalizing (→ page 32). **-R -RW(V) +R**

- The maximum number of items on a disc:
 - Titles: 99 (**+R** 49 titles)
 - Chapters: Approximately 1000 (**+R** Approximately 254) (Depends on the state of recording.)

Note

- Once erased or partially erased, title/chapters cannot be restored to their original state. Make certain before proceeding.
- You cannot edit during recording or chasing play.

Preparation

- Turn on the television and select the appropriate video input to suit the connections to this unit.
- Turn the unit on.
- Insert the disc with the title to edit.

Editing titles/chapters and playing chapters

Preparation

Release protection (→ page 31). **RAM**

- 1 During play or while stopped
Press [**DIRECT NAVIGATOR**].
- 2 Press [**▲, ▼, ◀, ▶**] to select the title.

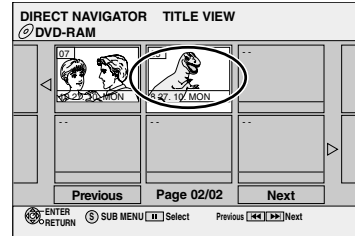

To show other pages

Press [**▲, ▼, ◀, ▶**] to select "Previous" or "Next" and press [**ENTER**].

- You can also press [**◀◀, ▶▶**] to show other pages.

Multiple editing

Select with [**▲, ▼, ◀, ▶**] and press [**||**]. (Repeat.)
A check mark appears. Press [**||**] again to cancel.

- 3 Press [**SUB MENU**], then [**▲, ▼**] to select the operation and press [**ENTER**].

- If you select "Edit", press [**▲, ▼**] to select the operation and press [**ENTER**] (→ page 27).

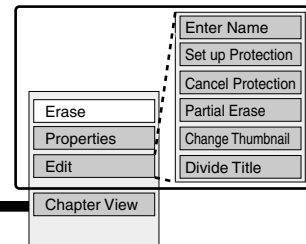

Refer to "Title operations".

If you select "Chapter View"

- 4 Press [**▲, ▼, ◀, ▶**] to select the chapter.

To start play → Press [**ENTER**].

To edit → Step 5.

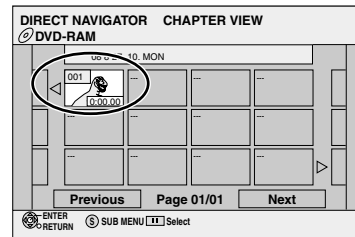

- To show other pages/Multiple editing (→ above)

- 5 Press [**SUB MENU**], then [**▲, ▼**] to select the operation and press [**ENTER**].

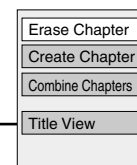

Refer to "Chapter operations".

- You can go back to the Title View.

To exit the screen

Press [**DIRECT NAVIGATOR**].

To return to the previous screen

Press [**RETURN**].

Title operations

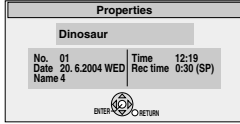
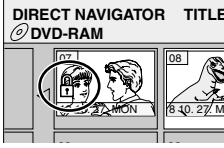
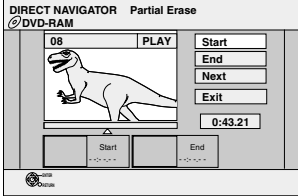
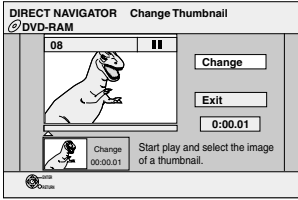
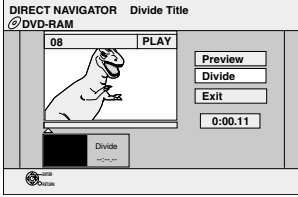
Erase * RAM -R -RW(V) +R	<p>Press [◀, ▶] to select “Erase” and press [ENTER].</p> <ul style="list-style-type: none"> Once erased, the recorded contents are lost and cannot be restored. Make certain before proceeding. The available recording time on DVD-R or +R does not increase when you erase titles. Available recording space on a DVD-RW (DVD-Video format) increases only when the last recorded title is erased. It does not increase if other titles are erased.
Properties RAM -R -RW(V) +R -RW(VR)	<p>Information (e.g., time and date) is shown.</p> <ul style="list-style-type: none"> Press [ENTER] to exit the screen. 
Enter Name RAM -R -RW(V) +R	<p>You can give names to recorded titles. → page 33, Entering text</p>
Set up Protection * Cancel Protection * RAM	<p>If set, this will protect the title from accidental erasure.</p> <p>Press [◀, ▶] to select “Yes” and press [ENTER]. The lock symbol appears when the title is protected.</p> 
Partial Erase RAM (→ below, “For your reference”)	<p>You can remove unnecessary part of the recording.</p> <ol style="list-style-type: none"> Press [ENTER] at the start point and end point of the section you want to erase. Press [▲, ▼] to select “Exit” and press [ENTER]. <ul style="list-style-type: none"> Select “Next” and press [ENTER] to erase other sections. Press [◀, ▶] to select “Erase” and press [ENTER]. 
Change Thumbnail RAM -R -RW(V) +R (→ below, “For your reference”)	<p>You can change the image to be shown as a thumbnail picture in the Title View.</p> <ol style="list-style-type: none"> Press [▶] (PLAY) to start play. Press [ENTER] when the image you want to use as a thumbnail is shown. To change the thumbnail Restart play and press [▲, ▼] to select “Change”, then press [ENTER] at the point you want to use as the thumbnail. Press [▲, ▼] to select “Exit” and press [ENTER]. 
Divide Title RAM (→ below, “For your reference”)	<p>You can divide a title into two.</p> <ol style="list-style-type: none"> Press [ENTER] at the point you want to divide the title. Press [▲, ▼] to select “Exit” and press [ENTER]. Press [◀, ▶] to select “Divide” and press [ENTER]. To confirm the division point Press [▲, ▼] to select “Preview” and press [ENTER]. (The unit plays 10 seconds before and after the division point.) To change the division point Restart play and press [▲, ▼] to select “Divide”, then press [ENTER] at the point you want to change. <p>Note</p> <ul style="list-style-type: none"> The divided titles retain the name and CPRM property (→ page 40) of the original title. Video and audio just before and after the dividing point may momentarily cut out. 

* Multiple editing is possible.

Chapter operations

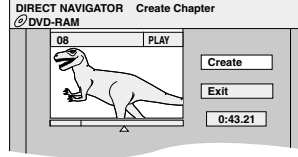
Erase Chapter * RAM	<p>Press [◀, ▶] to select “Erase” and press [ENTER].</p> <ul style="list-style-type: none"> Once erased, the recorded contents are lost and cannot be restored. Make certain before proceeding.
Create Chapter RAM (→ below, “For your reference”)	<ol style="list-style-type: none"> Press [ENTER] at the point you want to divide. <ul style="list-style-type: none"> Repeat this step to divide at other points. Press [▲, ▼] to select “Exit” and press [ENTER]. 
Combine Chapters RAM	<p>Press [◀, ▶] to select “Combine” and press [ENTER].</p> <ul style="list-style-type: none"> The selected chapter and next chapter are combined.

* Multiple editing is possible.

For your reference

- Use search or Time Slip (→ page 21) to find the desired point.
- To find the desired point correctly, use slow-motion or frame-by-frame (→ page 21).
- Press [**◀◀**, **▶▶**] to skip to the end of a title.

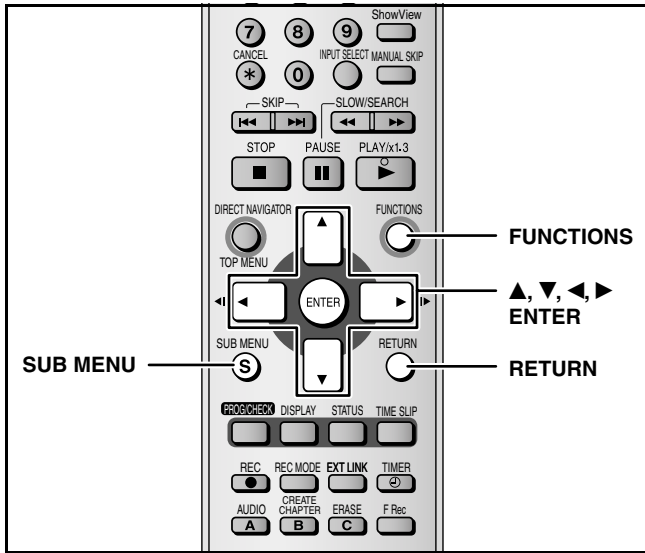

You can arrange the chapters (→ page 26) to create a playlist.

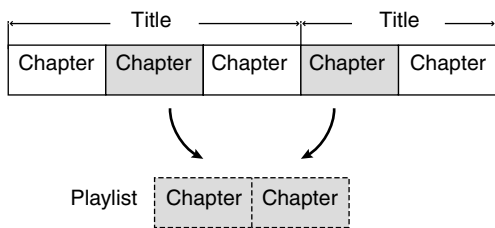

- Editing playlists doesn't modify the recorded data.
- Playlists are not recorded separately so this doesn't use much capacity.

RAM

- The maximum number of items on a disc:
 - Playlists: 99
 - Chapters in playlists: Approximately 1000 (Depends on the state of recording.)
- If you exceed the maximum numbers of items for a disc, all the items entered will not be recorded.
- You cannot create or edit a playlist while recording.

Creating playlists

Preparation

- Turn the unit on.
- Turn on the television and select the appropriate video input to suit the connections to this unit.
- Insert the disc with the title to edit.
- Release protection (→ page 31).

1 While stopped
Press [FUNCTIONS].

2 Press [▲, ▼] to select “To Others” and press [ENTER].

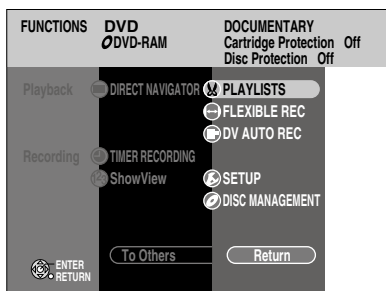

3 Press [▲, ▼] to select “PLAYLISTS” and press [ENTER].

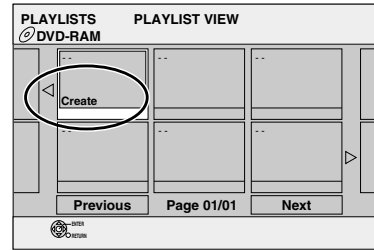

4 Press [▲, ▼, ◀, ▶] to select “Create” and press [ENTER].

5 Press [◀, ▶] to select the source title and press [▼].

- Press [ENTER] to select all the chapters in the title, then skip to step 7.

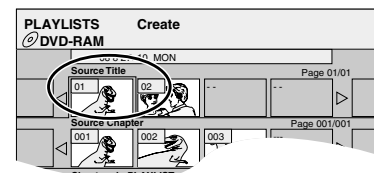

6 Press [◀, ▶] to select the chapter you want to add to a playlist and press [ENTER].

Press [▲] to cancel.

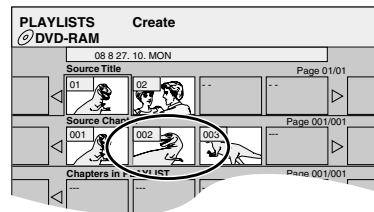

- You can also create a new chapter from the source title. Press [SUB MENU] to select “Create Chapter” and press [ENTER] (→ page 27, Create Chapter).

7 Press [◀, ▶] to select the position to insert the chapter and press [ENTER].

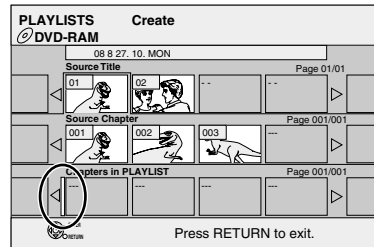

- Press [▲] to select other source titles.
- Repeat steps 6–7 to add other chapters.

8 Press [RETURN].

To exit the screen
Press [RETURN] several times.

To return to the previous screen
Press [RETURN].

Editing and playing playlists/chapters

RAM **-RW(VR)** (play only)

- 1** While stopped
Press **[FUNCTIONS]**.
- 2** Press **[▲, ▼]** to select “To Others” and press **[ENTER]**.
- 3** Press **[▲, ▼]** to select “PLAYLISTS” and press **[ENTER]**.
- 4** Press **[▲, ▼, ◀, ▶]** to select the playlist.
To start play → Press **[ENTER]**.
To edit → Step 5.

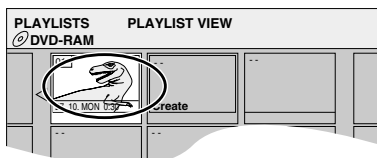

• To show other pages/Multiple editing (→ page 26)

- 5** Press **[SUB MENU]**, then **[▲, ▼]** to select the operation and press **[ENTER]**.

• If you select “Edit”, press **[▲, ▼]** to select the operation and press **[ENTER]**.

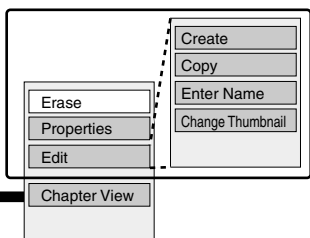

Refer to “Playlist operations”.

If you select “Chapter View”

- 6** Press **[▲, ▼, ◀, ▶]** to select the chapter.
To start play → Press **[ENTER]**.
To edit → Step 7.

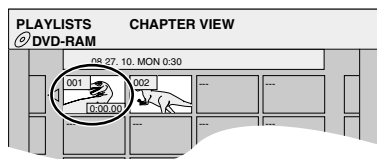

• To show other pages/Multiple editing (→ page 26)

- 7** Press **[SUB MENU]**, then **[▲, ▼]** to select the operation and press **[ENTER]**.

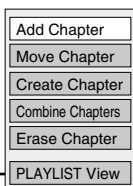

Refer to “Chapter operations”.

• You can go back to the PLAYLIST View.

Playlist operations

Erase * RAM	Press [◀, ▶] to select “Erase” and press [ENTER] .
Properties RAM -RW(VR)	<p>Playlist information (e.g., time and date) is shown.</p> <ul style="list-style-type: none"> Press [ENTER] to exit the screen.
Create RAM	→ page 28, Creating playlists, Step 5-8
Copy * RAM	Press [◀, ▶] to select “Copy” and press [ENTER] .
Enter Name RAM	→ page 33, Entering text
Change Thumbnail RAM	→ page 27, Change Thumbnail

* Multiple editing is possible.

Chapter operations

RAM	• Editing chapters in a playlist does not modify the source titles and source chapters.
Add Chapter	→ page 28, Creating playlists, Step 5-7
Move Chapter	<p>Press [▲, ▼, ◀, ▶] to select the position to insert the chapter and press [ENTER].</p>
Create Chapter	→ page 27, Create Chapter
Combine Chapters	→ page 27, Combine Chapters
Erase Chapter *	→ page 27, Erase Chapter

* Multiple editing is possible.

To exit the screen

Press **[RETURN]** several times.

To return to the previous screen

Press **[RETURN]**.

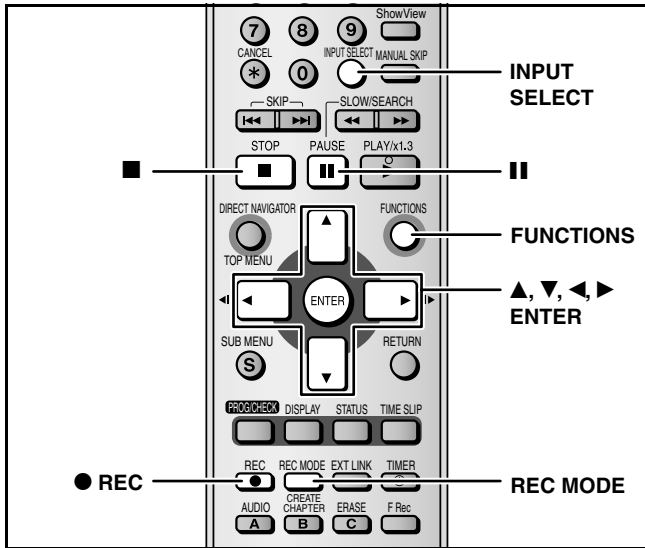

e.g., Connecting other video equipment to the AV3 or DV input terminals

- Turn off the unit and other video equipment before connecting.

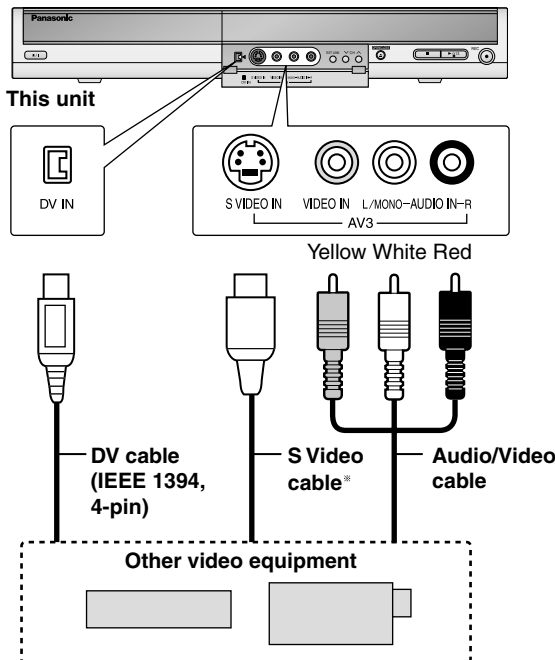

If the audio output of the other equipment is monaural, connect to L/MONO.

* The S VIDEO terminal achieves a more vivid picture than the VIDEO terminal.

When recording from the unit's DV terminal

Select the type of audio recording from "Audio Mode for DV Input" in the SETUP menu (→ page 35).

When recording from DV equipment (e.g., digital video camcorder), you can record audio/video recordings from DV tape only.

Manual recording

RAM **-R** **-RW(V)** **+R**

Preparation

- Connect a video cassette recorder, etc. to this unit's input terminals.
- When recording bilingual programmes

RAM When both M 1 and M 2 is selected on the connected equipment, you can select the audio type in playback.

-R **-RW(V)** **+R** Select either M 1 or M 2 on the connected equipment. (The selected audio only is recorded.)

- When the output signal from the external equipment is NTSC, change the "TV System" to "NTSC" in the SETUP menu (→ page 38).

- To reduce noise in input from external equipment (e.g., video cassette recorder), set "AV-in NR" to "On" (→ page 25).

- Check the time on the unit is correct.

1 While stopped

Press [INPUT SELECT] to select the input channel for the equipment you have connected.

e.g., If you have connected to AV3 input terminals, select "AV3".

2 Press [REC MODE] to select the recording mode.

3 Start play on the other equipment.

4 Press [● REC].

Recording starts.

To skip unwanted parts

Press [II] to pause recording. (Press again to restart recording.)

To stop recording

Press [■].

To record programmes to fill up the remaining space on the disc → page 16, Flexible Recording

Almost all videos and DVD software on sale have been treated to prevent illegal copying. Any software that has been so treated cannot be recorded using this unit.

DV automatic recording (DV AUTO REC)

RAM

When the "DV AUTO REC" function is used, programmes are recorded as a title while at the same time chapters are created at each break in the images and the playlist is created automatically.

Preparation

- 1 Turn off the main unit and DV equipment, then connect the equipment with the unit's DV input terminal (→ left).
 - 2 Turn on the main unit and DV equipment.
 - 3 Pause play of the DV equipment at the point you want recording to start.
- When the output signal from the external equipment is NTSC, change the "TV System" to "NTSC" in the SETUP menu (→ page 38).

1 While stopped

Press [REC MODE] to select the recording mode.

2 Press [FUNCTIONS].

3 Press [▲, ▼] to select "To Others" and press [ENTER].

4 Press [▲, ▼] to select "DV AUTO REC" and press [ENTER].

5 Press [◀, ▶] to select "Rec" and press [ENTER].

Recording starts.

When recording finishes

The confirmation screen appears. Press [ENTER] to finish DV automatic recording.

To stop recording

Press [■].

Note

- Only one piece of DV equipment (e.g., digital video camcorder) can be connected to the unit via the DV input terminal.
- It is not possible to operate the unit from the connected DV equipment.
- The DV input on this unit is for use with DV equipment only. (It cannot be connected to a computer, etc.)
- The DV equipment name may not be shown correctly.
- Depending on the DV equipment, the images or audio may not be input properly.
- The date and time information on the tape of the DV equipment will not be recorded.
- You cannot record and play simultaneously.

If the DV automatic recording function does not work properly, check the connections and DV equipment settings, and turn the unit off and back on.
If that does not work, follow the instructions for manual recording (→ left).

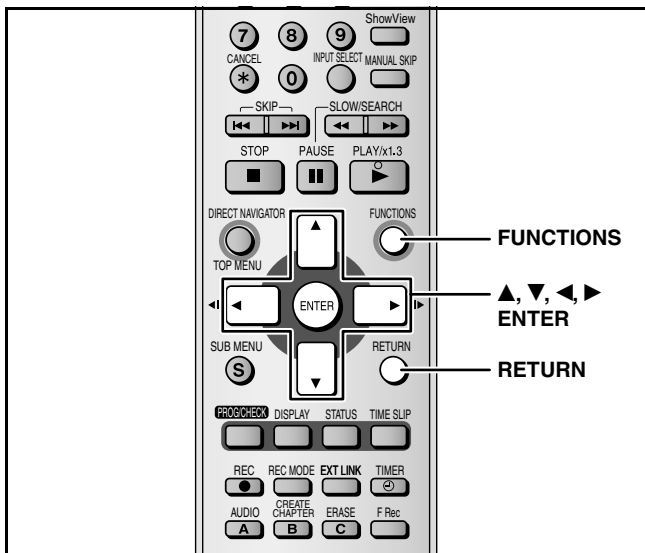

Preparation

- Turn on the television and select the appropriate video input to suit the connections to this unit.
- Turn the unit on.
- Insert the disc to be managed.

Setting the protection

RAM

- 1 While stopped
Press [FUNCTIONS].
- 2 Press [▲, ▼] to select “To Others” and press [ENTER].
- 3 Press [▲, ▼] to select “DISC MANAGEMENT” and press [ENTER].
- 4 Press [▲, ▼] to select “Disc Protection” and press [ENTER].
- 5 Press [◀, ▶] to select “Yes” and press [ENTER].

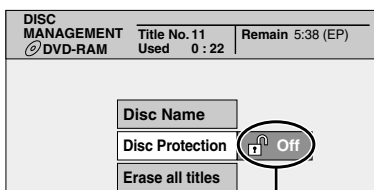

The lock symbol appears closed when the disc is write-protected.

Setting the protection for the whole disc

- For a DVD-RAM with a cartridge

With the write-protect tab in the protect position, play automatically starts when inserted in the unit.

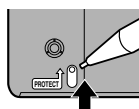

To exit the screen

Press [RETURN] several times.

To return to the previous screen

Press [RETURN].

Providing a disc with a name

RAM -R -RW(V) +R

Preparation

- RAM Release protection (→ left).

- 1 While stopped
Press [FUNCTIONS].
- 2 Press [▲, ▼] to select “To Others” and press [ENTER].
- 3 Press [▲, ▼] to select “DISC MANAGEMENT” and press [ENTER].
- 4 Press [▲, ▼] to select “Disc Name” and press [ENTER].

→ page 33, Entering text

- The disc name is displayed in the FUNCTIONS window.
- With a finalized DVD-R, DVD-RW (DVD-Video format) and +R, the name is displayed on the Top Menu.

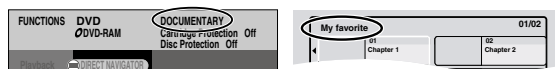

To exit the screen

Press [RETURN] several times.

To return to the previous screen

Press [RETURN].

Erasing all titles—Erase all titles

RAM

Preparation

- Release protection (→ left).

- 1 While stopped
Press [FUNCTIONS].
- 2 Press [▲, ▼] to select “To Others” and press [ENTER].
- 3 Press [▲, ▼] to select “DISC MANAGEMENT” and press [ENTER].
- 4 Press [▲, ▼] to select “Erase all titles” and press [ENTER].
- 5 Press [◀, ▶] to select “Yes” and press [ENTER].
- 6 Press [◀, ▶] to select “Start” and press [ENTER].
A message appears when finished.
- 7 Press [ENTER].

Note

- Once erased, the recorded contents are lost and cannot be restored. Make certain before proceeding.
- Erasing all video titles will result in all playlists also being erased.
- Erase does not work if one or more titles are protected.

To exit the screen

Press [RETURN] several times.

To return to the previous screen

Press [RETURN].

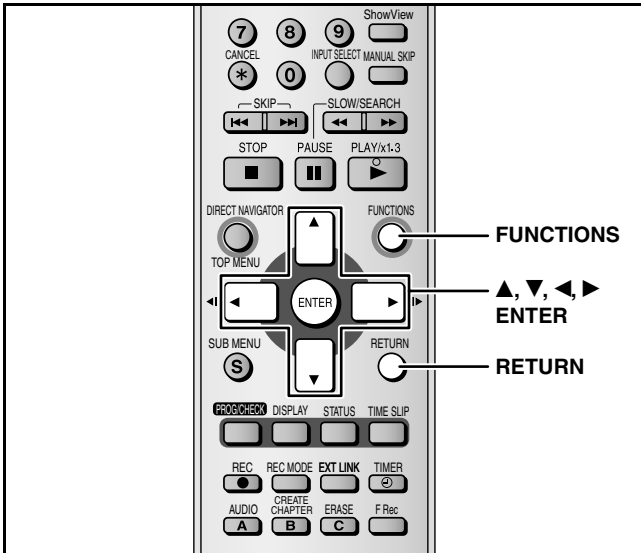

Erasing all the contents of a disc -Format Disc

RAM **-RW(V)** **-RW(VR)**

Note

• **Formatting erases all contents, and it cannot be restored. Check carefully before proceeding.** The contents are erased when you format it even if you have set protection.

Preparation

- **RAM** Release protection (→ page 31).

- 1 While stopped
Press **[FUNCTIONS]**.
- 2 Press **[▲, ▼]** to select “To Others” and press **[ENTER]**.
- 3 Press **[▲, ▼]** to select “DISC MANAGEMENT” and press **[ENTER]**.
- 4 Press **[▲, ▼]** to select “Format Disc” and press **[ENTER]**.
- 5 Press **[◀, ▶]** to select “Yes” and press **[ENTER]**.
- 6 Press **[◀, ▶]** to select “Start” and press **[ENTER]**.
A message appears when formatting is finished.
- 7 Press **[ENTER]**.

Note

• **Do not disconnect the AC mains lead while formatting.** This can render the disc unusable. Formatting normally takes a few minutes, however it may take up to a maximum of 70 minutes.

- **To stop formatting**
Press **[RETURN]**.
(You can cancel formatting if it takes more than 2 minutes. The disc must be reformatted if you do this.)
- Formatting cannot be performed on DVD-R, +R or CD-R/RW.
- You can format DVD-RW only as DVD-Video format on this unit.
- When a disc has been formatted using this unit, it may not be possible to use it on any other equipment.

To exit the screen

Press **[RETURN]** several times.

To return to the previous screen

Press **[RETURN]**.

Enabling DVD-R, DVD-RW (DVD-Video format) or +R to be played on other equipment-Finalize

-R **-RW(V)** **+R**

- 1 While stopped
Press **[FUNCTIONS]**.
- 2 Press **[▲, ▼]** to select “To Others” and press **[ENTER]**.
- 3 Press **[▲, ▼]** to select “DISC MANAGEMENT” and press **[ENTER]**.
- 4 Press **[▲, ▼]** to select “Auto-Play Select” and press **[ENTER]**.
Press **[▲, ▼]** to select “Top Menu” or “Title 1” and press **[ENTER]**.
You can select whether to show the top menu after finalizing.
Top Menu: The top menu appears first.
Title 1: The disc content is played without displaying the top menu.
- 5 Press **[▲, ▼]** to select “Finalize” and press **[ENTER]**.
 - ① Press **[◀, ▶]** to select “Yes” and press **[ENTER]**.
 - ② Press **[◀, ▶]** to select “Start” and press **[ENTER]**.
Finalizing starts.
You cannot cancel finalizing.
A message appears when finalizing is finished.
 - ③ Press **[ENTER]**.

Note

When finalizing a high-speed recording compatible disc, it may take longer than displayed on the confirmation screen (approximately four times).

After finalizing

- **-R** **+R** The disc becomes play-only and you can no longer record or edit.
- **-RW(V)** You can record and edit the disc after formatting (→ left) although it becomes play-only after finalizing.
- Titles are divided into about 5-minute* chapters.
* This time varies greatly depending on the condition and mode of recording.
- There is a pause of several seconds between titles and chapters during play.

Do not disconnect the AC mains lead while finalizing. This will render the disc unusable.

- Finalizing takes up to 15 minutes.

- You cannot finalize DVD-R, DVD-RW (DVD-Video format) or +R recorded on other manufacturer's equipment.
- DVD-R, DVD-RW (DVD-Video format) or +R finalized on this unit may not be playable on other players due to the condition of the recording.

- Visit Panasonic's homepage for more information about DVDs.
<http://www.panasonic-europe.com>

To exit the screen

Press **[RETURN]** several times.

To return to the previous screen

Press **[RETURN]**.

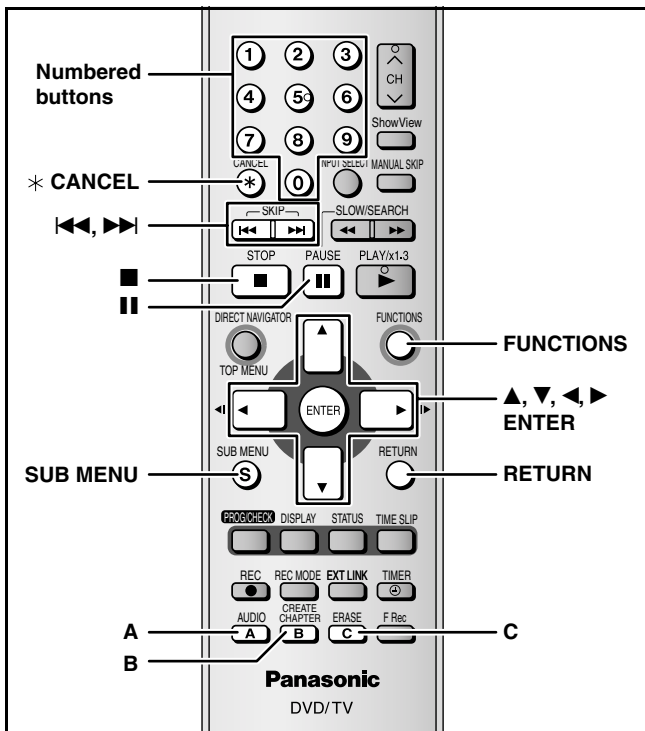

RAM -R -RW(V) +R

You can give names to recorded titles, etc.
The maximum number of characters:

RAM	Characters	-R	Characters
		-RW(V) +R	
Title	64 (44*)	Title	44
Playlist	64	Disc	40
Disc	64		

* timer recording

If a name is long, parts of it may not be shown in some screens.

1 Show Enter Name screen.

- Title (timer recording) (→ page 17, 18, Step 3)
- Title (→ page 26, Step 3)
- Playlist (→ page 29, Step 5)
- Disc (→ page 31, "Providing a disc with a name")

Name field: shows the text you have entered

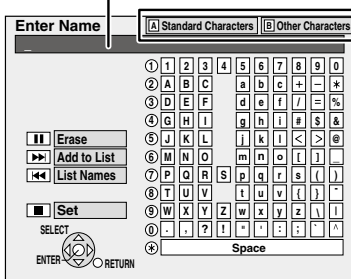

Press [A] or [B] to select character type and press [ENTER].

A Standard Characters (→ left, Alphabet characters etc.)

B Other Characters (→ below, Umlaut characters, accented characters etc.)

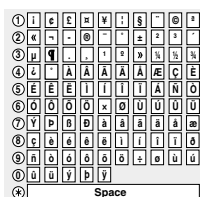

2 Press [▲, ▼, ◀, ▶] to select a character and press [ENTER].

Repeat this step to enter other characters.

•To erase a character

Press [▲, ▼, ◀, ▶] to select the character in the name field and press [■].

•Using the numbered buttons to enter characters e.g., entering the letter "R"

- 1 Press [7] to move to the 7th row.
- 2 Press [7] twice to highlight "R".
- 3 Press [ENTER].

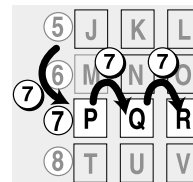

•To enter a space

Press [* CANCEL] and press [ENTER].

•To add frequently used names

Maximum number of registered names: 20

Maximum number of characters per name: 20

- 1 Press [▶▶] while the name to be added is shown in the name field.

- 2 Press [◀] to select "Add" and press [ENTER].

•To cancel adding word

Press [RETURN].

•To recall an added name

- 1 Press [◀◀].

- 2 Press [▲, ▼, ◀, ▶] to select the name to be recalled and press [ENTER].

•To erase an added name

- 1 Press [◀◀].

- 2 Press [▲, ▼, ◀, ▶] to select the name to be erased and press [SUB MENU].

- 3 Press [ENTER].

- 4 Press [◀] to select "Erase" and press [ENTER].

- 5 Press [RETURN].

3 Press [■] (Set).

Returns to the previously displayed screen.

To end partway

Press [RETURN].
Text is not saved.

Changing the unit's settings

Common procedures

- 1 While stopped
Press [FUNCTIONS].
- 2 Press [▲, ▼] to select "To Others" and press [ENTER].
- 3 Press [▲, ▼] to select "SETUP" and press [ENTER].

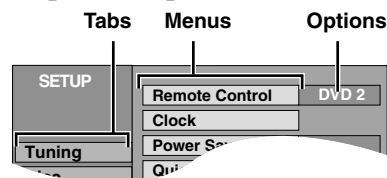

- 4 Press [▲, ▼] to select the tab and press [▶].
- 5 Press [▲, ▼] to select the menu and press [ENTER].
- 6 Press [▲, ▼] to select the option and press [ENTER].

To exit the screen

Press [RETURN] several times.

To return to the previous screen



Press [RETURN].

Refer to the control reference on page 33.

Summary of settings

The settings remain intact even if you switch the unit to standby.

Tabs	Menus	Options (Underlined items are the factory presets.)
Tuning	Manual (→ page 37)	
	Auto-Setup Restart (→ page 38)	
	Download from TV (→ page 38)	
Disc	Settings for playback	
	• Press [ENTER] to show the following settings.	
	Ratings Set a ratings level to limit DVD-Video play.	<ul style="list-style-type: none"> • <u>8 No Limit</u>: All DVD-Video can be played. • 1 to 7: Prohibits play of DVD-Video with corresponding ratings recorded on them.
	Follow the on-screen instructions. Enter a 4-digit password with the numbered buttons when the password screen is shown.	<ul style="list-style-type: none"> • 0 Lock All: Prohibits play of all DVD-Video.
	• Do not forget your password.	<ul style="list-style-type: none"> • <u>Unlock Recorder</u> • <u>Change Password</u> • <u>Change Level</u> • <u>Temporary Unlock</u>
	DVD-Audio Video mode Playback Select "On" to play DVD-Video content on some DVD-Audio.	<ul style="list-style-type: none"> • <u>On</u>: The setting returns to "Off" when you change the disc or turn the unit off. • <u>Off</u>
	Soundtrack DVD-V	<ul style="list-style-type: none"> • Some discs start in a certain language despite any changes you make here. • Enter a code (→ page 36) when you selecting "Other * * * *". • In case of English/French/Dutch languages, when you make download from TV, and Country setting of Auto-Setup in plug-in, the language ("Soundtrack"/"Menus") will be same and "Subtitle" will set to "Automatic".
	Subtitle DVD-V	<ul style="list-style-type: none"> • <u>English</u> • French • German • Italian • Spanish • Dutch • Original: The original language of each disc will be selected. • Other * * * * • <u>Automatic</u>: If the language selected for "Soundtrack" is not available, subtitles of that language will automatically appear if available on that disc. • English • French • German • Italian • Spanish • Dutch • Other * * * *
	Menus DVD-V	<ul style="list-style-type: none"> • <u>English</u> • French • German • Italian • Spanish • Dutch • Other * * * *
	Settings for recording	
• Press [ENTER] to show the following setting.		
Recording time in EP mode Select the maximum number of hours for recording in EP mode (→ page 14, Recording modes and approximate recording times).	<ul style="list-style-type: none"> • <u>EP (6Hours)</u>: You can record for 6 hours on an unused 4.7 GB disc. • <u>EP (8Hours)</u>: You can record for 8 hours on an unused 4.7 GB disc. 	
Picture	Comb Filter Select the picture sharpness when recording. The setting is fixed with "On" if you set "TV System" to "NTSC" (→ page 38).	<ul style="list-style-type: none"> • <u>On</u>: Pictures become clear and vivid. Normally, use this setting. • Off: Select it when recording noisy pictures.
	Still Mode Select the type of picture shown when you pause play (→ page 40, Frames and fields).	<ul style="list-style-type: none"> • <u>Automatic</u>: • Field: Select if jittering occurs when "Automatic" is selected. • Frame: Select if small text or fine patterns cannot be seen clearly when "Automatic" is selected.
	Seamless Play Selects the play mode for playlist chapter segments.	<ul style="list-style-type: none"> • <u>On</u>: The chapters in playlists are played seamlessly. This does not work when there are several audio types included on the playlist and when using Quick View. Additionally, the positioning of chapter segments may change slightly. • Off: The points where chapters in playlists change are played accurately, but the picture may freeze for a moment.

Tabs	Menus	Options (Underlined items are the factory presets.)	
Sound	Dynamic Range Compression <u>DVD-V</u> (Dolby Digital only) Change the dynamic range for late night viewing.	<ul style="list-style-type: none"> • On • <u>Off</u> 	
	Bilingual Audio Selection Select whether to record the main or secondary audio type when recording to DVD-R, DVD-RW (DVD-Video format) or +R. You cannot select this when recording from an external source onto DVD-R, DVD-RW (DVD-Video format) or +R (except from DV equipment connected to this unit's DV input terminal). Select the audio on the other equipment.	<ul style="list-style-type: none"> • <u>M 1</u> • M 2 	
	Digital Audio Output Change the settings when you have connected equipment through this unit's DIGITAL AUDIO OUT terminal (→ page 9). • Press [ENTER] to show the following settings.		
	PCM Down Conversion Select how to output audio with a sampling frequency of 96 kHz or 88.2 kHz. • Signals are converted to 48 kHz or 44.1 kHz despite the above settings if the signals have a sampling frequency of over 96 kHz or 88.2 kHz, or the disc has copy protection.	<ul style="list-style-type: none"> • On: Signals are converted to 48 kHz or 44.1 kHz. (Choose when the connected equipment cannot process signals with a sampling frequency of 96 kHz or 88.2 kHz.) • <u>Off</u>: Signals are output as 96 kHz or 88.2 kHz. (Choose when the connected equipment can process signals with a sampling frequency of 96 kHz or 88.2 kHz.) 	
	Dolby Digital Select how to output the signal. If "Bitstream" is selected, the connected equipment decodes the signal. If "PCM" is selected, this unit decodes the signal and output it as 2 channel. 	<ul style="list-style-type: none"> • <u>Bitstream</u>: When connecting to equipment displaying the Dolby Digital logo. • <u>PCM</u>: When connecting to equipment not displaying the Dolby Digital logo. 	
	DTS Select how to output the signal. If "Bitstream" is selected, the connected equipment decodes the signal. If "PCM" is selected, this unit decodes the signal and output it as 2 channel. 	<ul style="list-style-type: none"> • <u>Bitstream</u>: When connecting to equipment displaying the DTS logo. • <u>PCM</u>: When connecting to equipment not displaying the DTS logo. 	
	MPEG Note Not making the proper settings may result in noise or some trouble for digital recording. To avoid damaging your hearing and speakers, turn down the volume level.	<ul style="list-style-type: none"> • <u>Bitstream</u>: When connected to equipment with a built-in MPEG decoder. • <u>PCM</u>: When connected to equipment without a built-in MPEG decoder. 	
	Audio Mode for DV Input You can select the kind of audio when recording from the unit's DV input terminal (→ page 30).	<ul style="list-style-type: none"> • <u>Stereo 1</u>: Records audio (L1, R1). • Stereo 2: Records added audio such as narration (L2, R2) subsequent to original recording. • Mix: Records both Stereo 1 and Stereo 2. When recording bilingual broadcast to a DVD-R, DVD-RW (DVD-Video format) or +R, select the type of audio in advance from "Bilingual Audio Selection" (→ above). 	
	Display	On-Screen Messages Choose whether to show status messages automatically.	<ul style="list-style-type: none"> • <u>Automatic</u> • Off
		Grey Background Select "Off" if you do not want to have the unit show the grey background when tuner reception is weak.	<ul style="list-style-type: none"> • <u>On</u> • Off
FL Display Changes the brightness of the unit's display. This setting is fixed with "Automatic" if you set "Power Save" to "On".		<ul style="list-style-type: none"> • <u>Bright</u> • Dim • Automatic: The display turns dark during play, and reappears momentarily when you press a button. When the unit is turned off, all displays disappear. While using this mode, the standby power consumption can be reduced. 	
Connection	TV Aspect (→ page 12)	<ul style="list-style-type: none"> • 16:9 • <u>4:3</u> • Letterbox 	
	Progressive (→ page 12) This setting is fixed with "Off" if you set "AV1 Output" to "RGB (without component)".	<ul style="list-style-type: none"> • On • <u>Off</u> 	
	TV System (→ page 38)	<ul style="list-style-type: none"> • <u>PAL</u> • NTSC 	
	AV1 Output Selects the output from the AV1 terminal. Select "RGB (without component)" for RGB output. Select "Video (with component)" or "S Video (with component)" for component output.	<ul style="list-style-type: none"> • <u>Video (with component)</u> • S Video (with component) • RGB (without component) 	
	AV2 Settings Set to match the connected equipment. • Press [ENTER] to show the following settings.		
	AV2 Input Set to "RGB / Video" when receiving or recording RGB output from external equipment.	<ul style="list-style-type: none"> • <u>RGB / Video</u> • RGB • Video • S Video 	
	AV2 Connection This setting is fixed with "Ext" if you set "TV System" to "NTSC" (→ page 38).	<ul style="list-style-type: none"> • Decoder: When a decoder is connected to decode scrambled signal (e.g., C+ decoder). • <u>Ext</u>: When the VCR or a digital/satellite receiver is connected. 	
	Ext Link This setting cannot be made when the "TV System" is set to "NTSC" (→ page 38).	<ul style="list-style-type: none"> • Ext Link 1: When a digital receiver which transmits a special control signal recordings via the 21-pin Scart cable is connected. • <u>Ext Link 2</u>: When an external equipment with a timer function is connected. 	

Refer to the control reference on page 33.

Tabs	Menus	Options (Underlined items are the factory presets.)
Others	Remote Control (→ page 13)	• <u>DVD 1</u> • DVD 2 • DVD 3
	Clock	
	Auto Clock Setting (→ page 39)	
	Manual Clock Setting (→ page 39)	
	Power Save	• On: Power consumption is minimized when the unit is turned to standby (→ page 40).
	• Refer to the following when "Power Save" is set to "On".	• <u>Off</u>
	– "FL Display" is automatically set to "Automatic" (→ page 35).	
	– "Quick Start" function does not work (automatically set to "Off").	
	– This function does not work in the timer recording standby mode.	
	– When the unit is off, Pay TV programmes cannot be watched on the TV because the signal from the connected decoder is not looped through. To watch them, turn on the unit.	
	Quick Start	• <u>On</u>
	The Quick Start feature enables this unit to be ready to start recording as quick as approx. 1 second* after turning it on. You can start recording soon after deciding you want to record something.	• Off
	* Only when recording to the DVD-RAM.	
	Power consumption is also higher when the unit is turned off if this is set to "On".	
	• If this is set to "On", "Power Save" is automatically turned to "Off".	
	Language	• <u>English</u> • Deutsch • Français • Italiano • Español
	Choose the language for these menus and the on-screen messages.	• Nederlands
	Shipping Condition	• Yes
	All the settings except for the ratings level, ratings password and time settings return to the factory preset. The timer recording programmes are also cancelled.	• <u>No</u>
	Default Settings	• Yes
	All the settings except for the programmed channels, time settings, country settings, language settings, disc language settings, ratings level, ratings password and remote control code return to the factory presets.	• <u>No</u>

Language code list

Enter the code with the numbered buttons.

Abkhazian: 6566	Catalan: 6765	Gujarati: 7185	Lingala: 7678	Rhaeto-Romance: 8277	Tamil: 8465
Afar: 6565	Chinese: 9072	Hausa: 7265	Lithuanian: 7684	Tatar: 8484	
Afrikaans: 6570	Corsican: 6779	Hebrew: 7387	Macedonian: 7775	Romanian: 8279	Telugu: 8469
Albanian: 8381	Croatian: 7282	Hindi: 7273	Malagasy: 7771	Russian: 8285	Thai: 8472
Ameharic: 6577	Czech: 6783	Hungarian: 7285	Malay: 7783	Samoan: 8377	Tibetan: 6679
Arabic: 6582	Danish: 6865	Icelandic: 7383	Malayalam: 7776	Sanskrit: 8365	Tigrinya: 8473
Armenian: 7289	Dutch: 7876	Indonesian: 7378	Maltese: 7784	Scots Gaelic: 7168	Tonga: 8479
Assamese: 6583	English: 6978	Interlingua: 7365	Maori: 7773	Serbian: 8382	Turkish: 8482
Aymara: 6589	Esperanto: 6979	Irish: 7165	Marathi: 7782	Serbo-Croatian: 8372	Turkmen: 8475
Azerbaijani: 6590	Estonian: 6984	Italian: 7384	Norwegian: 7779	Shona: 8378	Twi: 8487
Bashkir: 6665	Faroeese: 7079	Japanese: 7465	Mongolian: 7778	Sindhi: 8368	Ukrainian: 8575
Basque: 6985	Fiji: 7074	Javanese: 7487	Nauru: 7865	Singhalese: 8373	Urdu: 8582
Bengali; Bangla: 6678	Finnish: 7073	Kannada: 7578	Nepali: 7869	Slovak: 8375	Uzbek: 8590
Bhutani: 6890	French: 7082	Kashmiri: 7583	Norwegian: 7879	Slovenian: 8376	Vietnamese: 8673
Bihari: 6672	Frisian: 7089	Kazakh: 7575	Oriya: 7982	Somali: 8379	Volapük: 8679
Breton: 6682	Galician: 7176	Kirghiz: 7589	Pashto, Pushto: 8083	Spanish: 6983	Welsh: 6789
Bulgarian: 6671	Georgian: 7565	Korean: 7579	Persian: 7065	Sudanese: 8385	Wolof: 8779
Burmese: 7789	German: 6869	Kurdish: 7585	Polish: 8076	Swahili: 8387	Xhosa: 8872
Byelorussian: 6669	Greek: 6976	Laotian: 7679	Portuguese: 8084	Swedish: 8386	Yiddish: 7473
Cambodian: 7577	Greenlandic: 7576	Latin: 7665	Punjabi: 8065	Tagalog: 8476	Yoruba: 8979
	Guarani: 7178	Latvian, Lettish: 7686	Quechua: 8185	Tajik: 8471	Zulu: 9085

Tuning

- 1 While stopped
Press [FUNCTIONS].
- 2 Press [▲, ▼] to select “To Others” and press [ENTER].
- 3 Press [▲, ▼] to select “SETUP” and press [ENTER].
- 4 Press [▲, ▼] to select “Tuning” and press [▶].

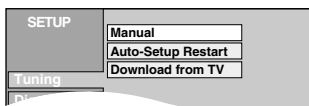

Manual

You can add or delete channels, or change programme positions.

- 5 Press [▲, ▼] to select “Manual” and press [ENTER].

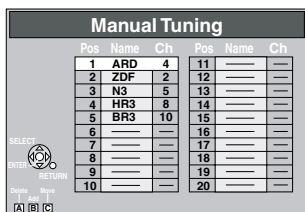

To delete a programme position

Press [▲, ▼, ◀, ▶] to select a programme position and press [A].

To add a blank programme position

Press [▲, ▼, ◀, ▶] to select a programme position and press [B].

To move a TV station to another programme position

- ① Press [▲, ▼, ◀, ▶] to select a programme position and press [C].
- ② Press [▲, ▼, ◀, ▶] to select the new programme position to which you want to assign the TV station and press [ENTER].

Note

If Preset Download (→ page 10) has been performed, only deletion of the programme position can be performed.

■ To change the tuning settings for individual programme position

- 6 Press [▲, ▼, ◀, ▶] to select a programme position and press [ENTER].

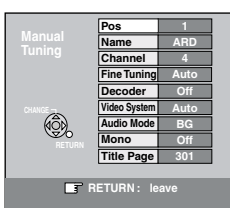

Press [▲, ▼] to select an item and press [▶].

Pos	To change the programme position in which the TV stations are assigned Press [▲, ▼] or numbered buttons to select the number of the desired programme position and press [ENTER].
Name	To enter or change the name of a TV station Press [▲, ▼, ◀, ▶] to enter station name and press [ENTER]. If the station name needs a blank space, select the blank between “Z” and “*”.
Channel	To enter newly available TV stations or change the channel number of an already tuned TV station Press [▲, ▼] or the numbered buttons to enter the channel number of the desired TV station. Wait a few moments until the desired TV station has been tuned. After the desired TV station is tuned, press [ENTER].
Fine Tuning	To obtain the best tuning condition Press [▲, ▼] to adjust the best tuning condition and press [ENTER]. ● Press [▶] to return to “Auto”.
Decoder	To preset pay TV stations Press [▲, ▼] to select “On” and press [ENTER].
Video System	To select the video system type Press [▲, ▼] to select “PAL” or “SECAM” if the picture lacks colour, and press [ENTER]. Auto: This unit automatically distinguishes PAL and SECAM signals. PAL: For receiving PAL signals. SECAM: For receiving SECAM signals.
Audio Mode	To select the audio reception type If sound quality is poor, press [▲, ▼] to select items and press [ENTER]. BG: PAL B.G.H/SECAM B.G L: SECAM L,L'
Mono	To select the type of sound to be recorded Press [▲, ▼] to select “On” if the stereo sound is distorted due to inferior reception conditions, or if you want to record the normal (mono) sound during a stereo, bilingual or NICAM broadcast, and press [ENTER].
Title Page	To enter the Teletext title page for a channel Entering title page number allows the unit to automatically record programme and station names. Press [▲, ▼] or numbered buttons to enter the number and press [ENTER]. ● To find the correct title page for the station, refer to its Teletext TV guide.

You can make the following two settings by selecting the external input channel (AV1, AV2, AV3, AV4) in step 5.

- Video System (Auto/PAL/SECAM)
In order to record properly, make the appropriate settings to match the connected equipment.
- Title Page (Auto/Off)

Refer to the control reference on page 33.

Auto-Setup Restart, Download from TV

You can restart auto channel setting if Preset Download or Auto-Setup (→ page 10, 11) fails for some reason.

After performing steps 1-4 (→ page 37)

■ **Auto-Setup Restart**

5 Press [▲, ▼] to select “Auto-Setup Restart” and press [ENTER].

The confirmation screen appears.

6 Press [◀, ▶] to select “Yes” and press [ENTER].

7 Press [▲, ▼, ▶, ◀] to select a country and press [ENTER].

■ **Download from TV**

5 Press [▲, ▼] to select “Download from TV” and press [ENTER].

The confirmation screen appears.

6 Press [◀, ▶] to select “Yes” and press [ENTER].

Download starts.

To exit the screen

Press [RETURN] several times.

To return to the previous screen

Press [RETURN].

Tuner System/List of TV Reception Channels

RF converter output: Not provided

Tuner System	Channel Coverage	VHF	UHF	CATV
PAL-BGH, SECAM-BG	CCIR	E2-E12, A-H2 (Italy)	21-69	S01-S05 (S1-S3) S1-S20 (M1-U10) S21-S41
SECAM-L,L'	France	2-10	21-69	B-Q (100.5 to 299.5 MHz) S21-S41 (299.5 to 467.25 MHz)

List of TV Reception Channels

Channel Indication	TV Channel		
	Germany/Italy	France	Other Countries
2-4	E2-E10	2-4	E2-E12
5-10		5-10, G-J (172.00 to 220.00 MHz) (INTER BANDE)	
11-12	E11-E12 (Germany) H1-H2 (Italy)	–	–
13-20	A-H (Only Italy)	–	–
21-69	E21-E69	E21-E69	E21-E69
74-78	S01-S05	–	S1-S5
80	S1	–	M1
81-89	S2-S10	B-F (100.00 to 172.00 MHz) (INTER BANDE)	M2-M10
90-99	S11-S0	K-Q (220.00 to 300.00 MHz) (INTER BANDE)	U1-U10
121-141	S21-S41* (Hyperband)	S21-S41 (299.25 to 467.25 MHz) (INTER BANDE)	S21-S41 (Hyperband)

* Only for 8 MHz channel raster

TV System

Change this setting if you connect an NTSC television or to record NTSC video from another source.

- 1** While stopped
Press [FUNCTIONS].
- 2** Press [▲, ▼] to select “To Others” and press [ENTER].
- 3** Press [▲, ▼] to select “SETUP” and press [ENTER].
- 4** Press [▲, ▼] to select “Connection” and press [▶].
- 5** Press [▲, ▼] to select “TV System” and press [ENTER].
- 6** Press [▲, ▼] to select the TV system and press [ENTER].

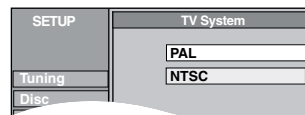

● **PAL (factory preset)**

- Select when connecting to a PAL or Multi-system television. Programmes recorded using NTSC are played as PAL 60.
- Select to record television programmes and PAL input from other equipment.

● **NTSC**

- Select when connecting to a NTSC television. Television programmes cannot be recorded properly.
- Select to record NTSC input from other equipment.

The confirmation screen appears.

7 Press [◀, ▶] to select “Yes” and press [ENTER].

To exit the screen

Press [RETURN] several times.

To return to the previous screen

Press [RETURN].

■ **To change the setting all at once (PAL ↔ NTSC)**

While stopped, press and hold [■] and [▲ OPEN/CLOSE] on the main unit at the same time for about 5 seconds.

Clock settings

- Usually, the unit's Preset Download or Auto-Setup function (→ page 10, 11) automatically adjusts the clock to correct time. Under some reception conditions, however, the unit cannot set the clock automatically.
- In this case, follow the operation steps below to manually set the clock.

• In the case of a power failure, the clock setting remains in memory for approximately 60 minutes.

- 1 While stopped**
Press [FUNCTIONS].
- 2** Press [▲, ▼] to select "To Others" and press [ENTER].
- 3** Press [▲, ▼] to select "SETUP" and press [ENTER].
- 4** Press [▲, ▼] to select "Others" and press [▶].
- 5** Press [▲, ▼] to select "Clock" and press [ENTER].

Auto Clock Setting

If a TV station transmits a time setting signal, and when "Automatic" in the Clock setting menu is set to "On", the automatic time correction function checks the time and if necessary it is adjusted several times every day.

- 6** Press [▲, ▼] to select "On" of "Automatic" and press [ENTER].

Auto clock setting starts.

The following screen appears when setting is complete.

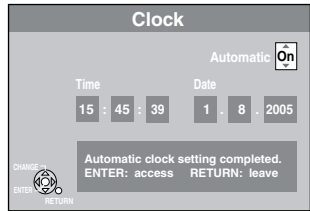

To stop partway
Press [RETURN].

- If the unit cannot set the clock automatically, set the clock manually (→ right, "Manual Clock Setting" Step 6).

Manual Clock Setting

- 6** Press [▲, ▼] to select "Off" of "Automatic" and press [ENTER].

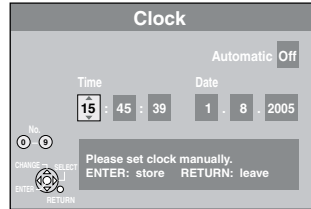

- 7** Press [◀, ▶] to select the item you want to change.

The items change as follows:
Hour ↔ Minute ↔ Second ↔ Day ↔ Month ↔ Year

- 8** Press [▲, ▼] to change the setting.

You can also use the numbered buttons for setting.

- 9** Press [ENTER] when you have finished the settings.

The clock starts.

To exit the screen

Press [RETURN] several times.

To return to the previous screen

Press [RETURN].

Child Lock

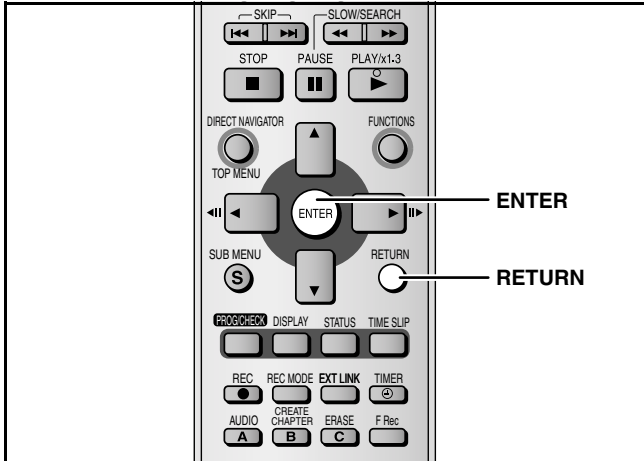

The Child Lock deactivates all buttons on the unit and remote control. Use it to prevent other people from operating the unit.

Press and hold [ENTER] and [RETURN] simultaneously until "X HOLD" appears on the unit's display.



If you press a button while the Child Lock is on, "X HOLD" appears on the unit's display and operation is impossible.

To cancel the Child Lock

Press and hold [ENTER] and [RETURN] simultaneously until "X HOLD" disappears.

Specifications

Recording System DVD Video Recording format (DVD-RAM), DVD-Video format (DVD-R), DVD-Video format (DVD-RW)

Recordable discs

DVD-RAM : Ver. 2.0
Ver. 2.1/3x–SPEED DVD-RAM Revision 1.0
Ver. 2.2/5x–SPEED DVD-RAM Revision 2.0

DVD-R : for General Ver. 2.0
for General Ver. 2.0/4x–SPEED DVD-R Revision 1.0
for General Ver. 2.x/8x–SPEED DVD-R Revision 3.0

DVD-RW : Ver. 1.1
Ver. 1.1/2x–SPEED DVD-RW Revision 1.0
Ver. 1.2/4x–SPEED DVD-RW Revision 2.0

+R : Ver. 1.0
Ver. 1.1
Ver. 1.2

Recording Time

Maximum 8 hours (with 4.7 GB disc)
XP: Approx. 1 hour SP: Approx. 2 hours
LP: Approx. 4 hours EP: Approx. 6 hours/8 hours

Playable discs

DVD-RAM, DVD-R, DVD-RW, +R, +RW, DVD-Video, DVD-Audio, CD-Audio (CD-DA), Video CD, SVCD*, CD-R/RW (MP3, CD-DA, Video CD, SVCD*, JPEG formatted discs)

LASER Specification

Class 1 LASER Product

Wave Length: 780 nm (CDs), 662 nm (DVDs)

Laser Power: No hazardous radiation is emitted with the safety protection

NORSK

Bølgelengde: 780 nm (CD), 662 nm (DVD)

Laserstyrke: Ingen farlig stråling sendes ut

Audio

Recording System: Dolby Digital 2ch

Audio In: AV1/AV2 (21 pin), AV3/AV4 (pin jack)

Input Level: Standard: 0.5 Vrms, Full scale: 2.0 Vrms at 1 kHz

Input Impedance: More than 10 k Ω

Audio Out: AV1/AV2 (21 pin), Audio Out (pin jack)

Output Level: Standard: 0.5 Vrms, Full scale: 2.0 Vrms at 1 kHz

Output Impedance: Less than 1 k Ω

Digital Audio Out: Optical terminal (PCM, Dolby Digital, DTS, MPEG)

Television System (→ page 38)

Video

Video System: SECAM (only input)/PAL colour signal, 625 lines, 50 fields
NTSC colour signal, 525 lines, 60 fields
MPEG2 (Hybrid VBR)

Recording System: MPEG2 (Hybrid VBR)

Video In (SECAM/PAL/NTSC): AV1/AV2 (21 pin), AV3/AV4 (pin jack) 1 Vp-p 75 Ω termination

S-Video In (SECAM/PAL/NTSC): AV2 (21 pin), AV3/AV4 (S terminal) 1 Vp-p 75 Ω termination

RGB In (PAL): AV2 (21 pin) 0.7 Vp-p (PAL) 75 Ω termination

Video Out (PAL/NTSC): AV1/AV2 (21 pin), Video Out (pin jack) 1 Vp-p 75 Ω termination

S-Video Out (PAL/NTSC): AV1 (21 pin), S-Video Out (S terminal) 1 Vp-p 75 Ω termination

RGB Out (PAL/NTSC): AV1 (21 pin) 0.7 Vp-p (PAL) 75 Ω termination

Component video output (NTSC 480p/480i, PAL 576p/576i)
Y: 1.0 Vp-p 75 Ω termination
Pb: 0.7 Vp-p 75 Ω termination
Pr: 0.7 Vp-p 75 Ω termination
IEEE 1394 Standard, 4 pin

DV input (PAL/NTSC)

Others

Region Code: # 2

Operating Temperature: 5 to 40 $^{\circ}$ C

Operating Humidity range: 10 to 80 % RH (no condensation)

Power supply: AC 220 to 240 V, 50 Hz

Power consumption: 25 W

Dimensions (WxDxH): Approx. 430 mm x 337 mm x 63 mm

Mass: Approx. 3.6 kg

Power consumption in standby mode:
approx. 3 W (Power Save mode)

Note

Specifications are subject to change without notice. Mass and dimensions are approximate.

* Conforming to IEC62107.

Glossary

Bitstream

This is the digital form of multi-channel audio data (e.g., 5.1 channel) before it is decoded into its various channels.

CPRM (Content Protection for Recordable Media)

CPRM is technology used to protect broadcasts that are allowed to be recorded only once. Such broadcasts can be recorded only with CPRM compatible recorders and discs.

Dolby Digital

This is a method of coding digital signals developed by Dolby Laboratories. Apart from stereo (2-channel) audio, these signals can also be multi-channel audio. A large amount of audio information can be recorded on one disc using this method.

Down-mixing

This is the process of remixing the multi-channel audio found on some discs into two channels for stereo output. It is useful when you want to listen to the 5.1-channel audio recorded on DVDs through your television's speakers. Some discs prohibit down-mixing and this unit can then only output the front two channels.

DTS (Digital Theater Systems)

This surround system is used in many movie theaters. There is good separation between the channels, so realistic sound effects are possible.

Dynamic range

Dynamic range is the difference between the lowest level of sound that can be heard above the noise of the equipment and the highest level of sound before distortion occurs. Dynamic range compression means reducing the gap between the loudest and softest sounds. This means you can listen at low volumes but still hear dialog clearly.

Film and video

DVD-Video are recorded using either film or video. This unit can determine which type has been used, then uses the most suitable method of progressive output.

For PAL

Film is 25 frames per second.

Video is 50 fields per second (two fields making up one frame).

For NTSC

Film is 24 or 30 frames per second, with motion picture film generally being 24 frames per second.

Video is 60 fields per second (two fields making up one frame).

Finalize

A process that makes play of a recorded CD-R, CD-RW, DVD-R etc. possible on equipment that can play such media. You can finalize DVD-R, DVD-RW (DVD-Video format) or +R on this unit.

After finalizing, the disc becomes play-only and you can no longer record or edit. You can record after formatting although it becomes play-only after finalizing, when you use DVD-RW.

Formatting

Formatting is the process of making media such as DVD-RAM recordable on recording equipment.

You can format DVD-RAM or DVD-RW (only as DVD-Video format) on this unit.

Formatting erases irrevocably all contents.

Frames and fields

Frames refer to the single images that constitute the video you see on your television. Each frame consists of two fields.

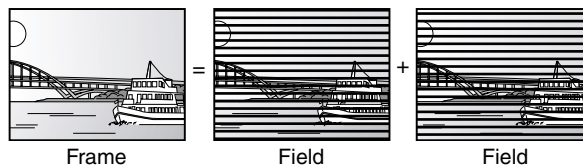

- A frame still shows two fields, so there may be some blurring, but picture quality is generally better.
- A field still shows less picture information so it may be rougher, but there is no blurring.

JPEG (Joint Photographic Experts Group)

This is a system used for compressing/decoding color still pictures. If you select JPEG as the storage system on digital cameras etc., the data will be compressed to 1/10–1/100 of its original size. The feature of JPEG is less deterioration in picture quality considering the degree of compression.

MP3 (MPEG Audio Layer 3)

An audio compression method that compresses audio to approximately one tenth of its size without any considerable loss of audio quality. You can play MP3 you have recorded onto CD-R and CD-RW.

Pan & Scan/Letterbox

In general, DVD-Video are produced with the intention that they be viewed on a widescreen television (16:9 aspect ratio), so images often don't fit regular (4:3 aspect ratio) televisions. Two styles of picture, "Pan & Scan" and "Letterbox", deal with this problem.

Pan & Scan: The sides are cut off so the picture fills the screen.

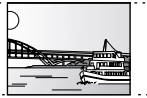

Letterbox: Black bands appear at the top and bottom of the picture so the picture itself appears in an aspect ratio of 16:9.

**Playback control (PBC)**

If a Video CD has playback control, you can select scenes and information with menus.

(This unit is compatible with version 2.0 and 1.1.)

Progressive/Interlace

The PAL video signal standard has 625 (or 576) interlaced (i) scan lines, whereas progressive scanning, called 625p (or 576p), uses twice the number of scan lines. For the NTSC standard, these are called 525i (or 480i) and 525p (or 480p) respectively.

Q Link

This function works only if the unit is connected via a fully wired 21-pin Scart cable to a TV featuring the Q Link or similar function.

Q Link offers the following functions:

- **Download from the TV***

When you connect the unit to a TV, the station list data is automatically copied from the TV to the unit, and the TV stations are assigned to the programme positions on the unit in the same order as on the TV.

- **Direct TV Recording**

By simply pressing [● DIRECT TV REC], you can at once record the same programme that you are watching on the TV.

- **TV/DVD Auto On***

Even if the TV and the unit are off (standby mode), pressing [▶] (PLAY), [DIRECT NAVIGATOR, TOP MENU], [ShowView] or [PROG/CHECK] automatically turns on both the TV and the unit. If the TV is off (standby mode) and the unit is on, when you press [FUNCTIONS] or [▶] (PLAY), or insert the disc [except DVD-RAM, DVD-R, DVD-RW (DVD-Video format) and +R], the TV automatically is turned on.

- **DVD Auto Standby***

When you turn the TV off, the unit is turned off as well. However, this function works in the stop mode.

VPS (Video Programme System)/PDC (Programme Delivery Control)

VPS or PDC is a very convenient system which records exactly from beginning to end of the TV programmes set in timer recording, even if the actual broadcasting time differs from the scheduled time due to delayed start or extension of the programme duration. Also, if a programme is interrupted, for example, some special news is inserted, the recording will be paused automatically and resumed when the programme continues. Depending on the signals sent from the TV stations, the VPS/PDC system may not work properly even when "VPS/PDC" has been set to "ON". Please check with the broadcasters in your area for details.

- In the case of VPS/PDC recording, use the correct time (VPS/PDC time) for recording the TV programmes.

Set "VPS/PDC" to "OFF" when the recording time is not the correct time (VPS/PDC time).

VPS/PDC recording is not performed when the time (VPS/PDC time) is incorrect, even if only by one minute. To find out the correct time (VPS/PDC time), consult Teletext, a newspaper or magazine, or other source.

- If the actual broadcasting times of timer recordings overlap (regardless of whether they are VPS/PDC controlled), the recording that starts first always has priority, and the recording of the later programme will start only after the first timer recording has finished.

- When the VPS/PDC signal drops out because the broadcast signal is weak, or when a TV station does not transmit a regular VPS/PDC signal, the timer recording will be performed in the normal mode (without VPS/PDC) even if it was programmed for VPS/PDC. In this case, even if the timer recording is performed, whatever has been programmed will not be cancelled at that particular time but at 4 a.m. two days later.

- The start times of scheduled programmes listed in the newspaper or magazine may be changed at a later date. Set "VPS/PDC" to "OFF" when programming a programme whose start time has been subsequently changed. Particular care must be taken in this respect with SHOWVIEW programming since "VPS/PDC" is automatically set to "ON" in some countries (→ below).

- If a programme listed in a newspaper or magazine has two SHOWVIEW numbers, use the SHOWVIEW number for VPS/PDC if you wish to proceed with VPS/PDC recording using SHOWVIEW programming.

- The default settings for "VPS/PDC" differ depending on the country concerned. Refer to the following table.

	When SHOWVIEW programming	When the SHOWVIEW programming start time is changed	When programming manually
Belgium, Netherlands, Sweden, Denmark, Finland, Norway, France	ON	OFF	OFF
Germany, Switzerland, Austria	ON	ON	ON
Italy, Spain, Portugal, Greece, Other Countries	OFF	OFF	OFF

- If the broadcasting station is not transmitting VPS/PDC signals, "---" appears in the menu for timer programming under "VPS/PDC".

- The beginnings of recordings may not be recorded correctly in some cases.

Using progressive output, you can enjoy the high-resolution video recorded on media such as DVD-Video.

Your television must be compatible to enjoy progressive video.

Panasonic televisions with 625 (576)/50i · 50p, 525 (480)/60i · 60p input terminals are progressive compatible.

Protection

You can prevent accidental erasure by setting writing protection or erasure protection.

Sampling frequency

Sampling is the process of converting the heights of sound wave (analog signal) samples taken at set periods into digits (digital encoding). Sampling frequency is the number of samples taken per second, so larger numbers mean more faithful reproduction of the original sound.

Thumbnail

This refers to a miniature representation of a picture used to display multiple pictures in the form of a list.

TIFF (Tag Image File Format)

This is a system used for compressing/decoding color still pictures. A common format for storing high quality images on digital cameras and other devices.

This function does not work during the following operations: Preset Download, Auto-Setup, Auto Clock Setting and Manual Tuning.

- **On-Screen Messages***

When you are watching a TV programme, the following messages appear on the TV screen to inform you of the unit's condition:

Message	Message appears when:
This programme has already started	A timer recording has just started.
Set DVD to timer standby mode	The unit is not in the timer standby mode 10 minutes before the programmed recording start time (message appears every minute during these 10 minutes).
DVD is in timer recording mode	[● REC] on the main unit or [ShowView] was pressed while the unit is in the timer recording mode.

Depending on the type of TV used, the above messages may not appear correctly.

* These operations are only available if the unit is connected to a TV featuring the Q Link function.

Frequently asked questions

Set up		Page
What equipment is necessary to play multi channel surround sound?	<ul style="list-style-type: none"> • DVD-Video: You can play DVD-Video multi channel surround by digitally connecting an amplifier equipped with a Dolby Digital, DTS or MPEG decoder. • DVD-Audio: This unit plays DVD-Audio in 2 channels. You cannot play multi channel surround sound. 	9 —
Are the headphones and speakers directly connected to the unit?	<ul style="list-style-type: none"> • You cannot directly connect to the unit. Connect through the amplifier etc. 	9
The television has a Scart terminal and component video input terminal. Which terminal should I connect with?	<ul style="list-style-type: none"> • If you have a regular television (CRT: cathode ray tube) we recommend using the Scart terminal. You can enjoy high-quality RGB video from this unit by connecting to an RGB compatible television. If you have an LCD/plasma television or LCD projector compatible with progressive scan, connect through the component video terminals for high-quality progressive video. If you have a CRT television that is compatible with progressive scan, we cannot recommend progressive output as some flickering can occur. 	7, 8
Is my television progressive output compatible?	<ul style="list-style-type: none"> • All Panasonic televisions that have 625 (576)/50i · 50p, 525 (480)/60i · 60p input terminals are compatible. Consult the manufacturer if you have another brand of television. 	—

Disc		
Can I play DVD-Video, DVD-Audio and Video CDs bought in another country?	<ul style="list-style-type: none"> • You cannot play DVD-Video if their region number are not supported by this player. 	Cover
Can a DVD-Video that does not have a region number be played?	<ul style="list-style-type: none"> • The DVD-Video region number indicates the disc conforms to a standard. You cannot play discs that do not have a region number. 	—
Please tell me about DVD-R, DVD-RW, +R and +RW compatibility with this unit.	<ul style="list-style-type: none"> • This unit records and plays DVD-R, DVD-RW (DVD-Video format) and +R, and plays DVD-RW (DVD Video Recording format) and +RW. • This unit also records and plays high speed recording compatible DVD-R, DVD-RW, +R discs. 	4, 5 —
Please tell me about CD-R and CD-RW compatibility with this unit.	<ul style="list-style-type: none"> • This unit plays CD-R/CD-RW discs (audio recording discs) which have been recorded under one of the following standards: CD-DA, Video CD, SVCD (conforming to IEC62107), MP3 and still pictures (JPEG/TIFF). Close the session or finalize the disc after recording. This unit can recognize up to 99 folders (groups) and 999 files (tracks) on a disc with MP3 or still pictures (JPEG/TIFF). • You cannot write to a CD-R or CD-RW with this unit. 	5, 22 —

Recording		
Can I record from a commercially purchased video cassette or DVD?	<ul style="list-style-type: none"> • Most commercially sold video cassettes and DVD are copy protected; therefore, recording is usually not possible. 	—
Can DVD-R, DVD-RW (DVD-Video Format) and +R recorded on this unit be played on other equipment?	<ul style="list-style-type: none"> • You can play on compatible equipment such as DVD players after finalizing the disc on this unit. However depending on the condition of the recording, the quality of the disc and capabilities of the DVD player, play may not be possible. 	32
Can I record digital audio signals using this unit?	<ul style="list-style-type: none"> • You cannot record digital signals. The digital audio terminals on this unit are for output only. (The audio recorded using the unit's DV input terminal from a digital video camcorder, for example, is recorded digitally.) 	—
Can a digital audio signal from this unit be recorded to other equipment?	<ul style="list-style-type: none"> • You can record if using the PCM signal. When recording DVD, change the "Digital Audio Output" settings to the following from the SETUP menu. <ul style="list-style-type: none"> – PCM Down Conversion: On – Dolby Digital/DTS/MPEG: PCM However, only <ul style="list-style-type: none"> – As long as digital recording from the disc is permitted. – As long as the recording equipment is compatible with a sampling frequency of 48 kHz. • You cannot record MP3 signals. 	35 —
Can I switch to bilingual broadcast during recording?	<ul style="list-style-type: none"> • With DVD-RAM, you can. Just press [AUDIO]. • With DVD-R, DVD-RW (DVD-Video format) or +R, you cannot. Change before recording with the "Bilingual Audio Selection" in the SETUP menu. 	— 35

Optional Accessories

Product numbers correct as of April 2005. These may be subject to change.

DVD-RAM	9.4 GB, double-sided, type 4 cartridge:	LM-AD240ME (compatible with high speed recording 5X)
		LM-AD240LE (compatible with high speed recording 3X)
	4.7 GB, single-sided, type 2 cartridge:	LM-AB120ME (compatible with high speed recording 5X)
		LM-AB120LE (compatible with high speed recording 3X)
	4.7 GB, single-sided, non-cartridge:	LM-AF120ME (compatible with high speed recording 5X)
DVD-R	4.7 GB, single-sided, non-cartridge:	LM-RF120ME (compatible with high speed recording 8X)
		LM-RF120LE (compatible with high speed recording 4X)
		LM-RF120LE (compatible with high speed recording 4X)

Error messages

On the television

		Page
Cannot finish recording completely.	<ul style="list-style-type: none"> The programme was copy-protected. The disc may be full. There are already 99 recorded titles (+R 49 recorded titles). 	—
Cannot playback. TV system is different from the setting. To playback, please change the TV System in SETUP.	<ul style="list-style-type: none"> You tried to play a title recorded using a different encoding system from that of the TV system currently selected on the unit. Alter the "TV System" setting on this unit to suit. 	38
Cannot record on the disc.	<ul style="list-style-type: none"> The disc may be dirty or scratched. 	5
Unable to format.		
Please check the disc.		
Cannot record. Disc is full.	<ul style="list-style-type: none"> Create space by erasing any unnecessary titles. RAM -RW(V) (Even if you erase recorded content from the DVD-R or the +R, there is no increase in disc space.) Use a new disc. 	21, 27, 31
Cannot record. Maximum numbers of titles exceeded.		
Error has occurred. Please press ENTER.	<ul style="list-style-type: none"> Press [ENTER] to start recovery process. You cannot operate the unit while it is recovering ("SELF CHECK" appears on the unit's display). 	—
No disc	<ul style="list-style-type: none"> The disc may be upside down. 	—
Please change the disc.	<ul style="list-style-type: none"> There may be a problem with the disc. Press [▲ OPEN/CLOSE] to remove it and check it for scratches or dirt. (The unit turns off automatically after you open the tray.) 	5
This is a non-recordable disc.	<ul style="list-style-type: none"> The unit cannot record on the disc you inserted. Insert a DVD-RAM or unfinalized DVD-R, DVD-RW (DVD-Video format) or +R. You inserted an unformatted DVD-RAM or DVD-RW. Format the disc with this unit. 	4, 5
This disc is not formatted properly.		32
	<ul style="list-style-type: none"> The operation is prohibited by the unit or disc. 	—

On the unit's display

REMOTE DVD <input type="checkbox"/> (" <input type="checkbox"/> " stands for a number.)	<ul style="list-style-type: none"> The remote control and main unit are using different codes. Change the code on the remote control.  <p>Press and hold [ENTER] and the indicated number button at the same time for more than 2 seconds.</p>	13
HARD ERR	<ul style="list-style-type: none"> If there is no change after turning the unit on and off, consult the dealer where the unit was purchased. 	—
NO READ	<ul style="list-style-type: none"> The disc is dirty or badly scratched. The unit cannot record, play, or edit. The message may appear when the lens cleaner has finished cleaning. Press [▲ OPEN/CLOSE] to eject the disc. 	5
PROG FULL	<ul style="list-style-type: none"> There are already 16 timer programmes. Delete unnecessary timer programmes. 	19
SELF CHECK	<ul style="list-style-type: none"> There was something unusual detected with the disc while recording, playing or transferring(dubbing), there was a power failure or the AC plug was disconnected while the unit was on. The unit is carrying out its recovery process. This process restores the unit to normal operation. The unit is not broken. Wait until the message disappears. 	44
UNSUPPORT	<ul style="list-style-type: none"> You have inserted a disc the unit cannot play or record on. 	4, 5
UNFORMAT	<ul style="list-style-type: none"> You have inserted a DVD-RAM or DVD-RW that is unformatted or recorded on other equipment. 	32
U59	<ul style="list-style-type: none"> The unit is hot. The unit switches to standby for safety reasons. Wait for about 30 minutes until the message disappears. Select a position with good ventilation when installing the unit. Do not block the vent on the rear of the unit. 	—
U99	<ul style="list-style-type: none"> The unit fails to operate properly. Press [⏻] on the main unit to switch the unit to standby. Now press [⏻] on the main unit again to turn the unit on. 	—
X HOLD	<ul style="list-style-type: none"> The Child Lock function is activated. Press and hold [ENTER] and [RETURN] simultaneously until "X HOLD" disappears. 	39

Maintenance

The precision parts in this unit are readily affected by the environment, especially temperature, humidity, and dust. Cigarette smoke also can cause malfunction or breakdown.

To clean this unit, wipe with a soft, dry cloth.

- Never use alcohol, paint thinner or benzene to clean this unit.
- Before using chemically treated cloth, read the instructions that came with the cloth carefully.

Observe the following points to ensure continued listening and viewing pleasure.

Dust and dirt may adhere to the unit's lens over time, making it impossible to record or play discs. Use the **DVD lens cleaner (RP-CL720E)** about once every year, depending on frequency of use and the operating environment. Read the lens cleaner's instructions carefully before use.

Troubleshooting guide

Before requesting service, make the following checks. If you are in doubt about some of the check points, or if the remedies indicated in the chart do not solve the problem, consult your dealer for instructions.

The following do not indicate a problem with this unit:

- Regular disc rotating sounds. The sound of the disc rotating may become louder especially when finalizing a DVD-R, DVD-RW (DVD-Video format) or +R.
- Poor reception due to atmospheric conditions.
- Image disturbance during search.
- Interruptions in reception due to periodic satellite broadcasting breaks.
- Operations do not work due to a poor-quality disc. (Try again using a Panasonic disc.)
- The unit freezes due to one of its safety devices being activated. (Press and hold [⏏/I] on the main unit for 10 seconds.)

Power

Page

No power.	<ul style="list-style-type: none"> • Insert the AC mains lead securely into a known active AC mains socket. • Timer recording is in recording standby. Press [⏏/I] to cancel the recording standby. 	7, 8
Unit does not turn on pressing [⏏/DVD].	<ul style="list-style-type: none"> • Linked timer recordings with external equipment is in recording standby ("EXT Link" on the unit's display blinks when [⏏/DVD] is pressed). Press [EXT LINK] to cancel the recording standby. 	17, 18
The unit switches to the standby mode.	<ul style="list-style-type: none"> • One of the unit's safety devices is activated. Press [⏏/I] on the main unit to turn the unit on. 	—

Displays

The display is dim.	<ul style="list-style-type: none"> • Change "FL Display" in the SETUP menu. 	35
"0:00" is flashing on the unit's display.	<ul style="list-style-type: none"> • Set the clock. 	39
The clock is not correct.	<ul style="list-style-type: none"> • Under adverse reception conditions, etc., the automatic time correction function may not work. In this case, "Automatic" is automatically turned to "Off". If re-setting the Auto Clock Setting does not work, set the time manually. 	39
The time recorded on the disc and the available time shown do not add up.	<ul style="list-style-type: none"> • Times shown may disagree with actual times. 	—
The play time shown for MP3 does not agree with the actual time.	<ul style="list-style-type: none"> • Even if you erase recorded content from the DVD-R or the +R, there is no increase in disc space. • Available recording space on a DVD-RW (DVD-Video format) increases only when the last recorded title is erased. It does not increase if other titles are erased. • More disc space than the actual recording time is used after recording or editing the DVD-R or the +R 200 times or more. • While searching, the elapsed time may not display correctly. 	—
"SELF CHECK" is displayed and the disc cannot be ejected.	<ul style="list-style-type: none"> • The unit is carrying out the recovery process. Do the following to eject the disc. <ol style="list-style-type: none"> 1 Press [⏏/I] on the main unit to switch the unit to standby. If the unit doesn't switch to standby, press and hold [⏏/I] on the main unit for about 10 seconds. The unit is forcibly switched to standby. 2 While the unit is off, press and hold [■] and [CH ^] on the main unit at the same time for about 5 seconds. Remove the disc. 	—

TV screen and video

Television reception worsens after connecting the unit.	<ul style="list-style-type: none"> • This can occur because the signals are being divided between the unit and other equipment. It can be solved by using a signal booster, available from audio-visual suppliers. 	—
Status messages do not appear.	<ul style="list-style-type: none"> • Select "Automatic" in "On-Screen Messages" in the SETUP menu. 	35
The grey background does not appear.	<ul style="list-style-type: none"> • Select "On" in "Grey Background" in the SETUP menu. 	35
The 4:3 aspect ratio picture expands left and right. Screen size is wrong.	<ul style="list-style-type: none"> • Use the television to change the aspect. If your television does not have that function, set "Progressive" in the Picture menu to "Off". • Check the settings for "TV Aspect" in the SETUP menu. 	25
There is a lot of after-image when playing video.	<ul style="list-style-type: none"> • Set "Playback NR" in the Picture menu to "Off". 	12
When playing DVD-Video using progressive output, one part of the picture momentarily appears to be doubled up.	<ul style="list-style-type: none"> • Set "Progressive" in the Picture menu to "Off". This problem is caused by the editing method or material used on DVD-Video, but should be corrected if you use interlace output. 	25
There is no apparent change in picture quality when adjusted with the Picture menu in the on-screen menus.	<ul style="list-style-type: none"> • The effect is less perceivable with some types of video. 	—
The images from this unit do not appear on the television.	<ul style="list-style-type: none"> • Make sure that the television is connected to the AV1 terminal, VIDEO OUT terminal, S VIDEO OUT terminal or COMPONENT VIDEO OUT terminals on this unit. • Make sure that the television's input setting (e.g., AV1) is correct. 	7, 8
Picture is distorted.	<ul style="list-style-type: none"> • The television isn't compatible with progressive signals. Press and hold [■] and [▶/x1.3] on the main unit at the same time for about 5 seconds. The setting will change to interlace. 	—

Sound

No sound.	<ul style="list-style-type: none"> • Check the connections and settings. Check the input mode on the amplifier if you have connected one. 	7-9, 35
Low volume.	<ul style="list-style-type: none"> • Press [AUDIO] to select the audio. 	20
Distorted sound.	<ul style="list-style-type: none"> • Turn off V.S.S. in the following cases. <ul style="list-style-type: none"> –When using discs that do not have surround sound effects such as Karaoke discs. –When playing bilingual broadcast programmes. 	25
Cannot hear the desired audio type.	<ul style="list-style-type: none"> • The disc may have a restriction on the method of audio output. If "D. MIX" does not appear in the display when playing multi-channel DVD-Audio, only audio for the two front channels will be output. Refer to the disc's jacket. 	—
Cannot switch audio.	<ul style="list-style-type: none"> • You cannot change the audio type when a DVD-R, a DVD-RW (DVD-Video format) or a +R is in the disc tray. • You cannot change the audio type when playing a DVD-R, a DVD-RW (DVD-Video format) or a +R. (You can select "M 1" or "M 2" in "Bilingual Audio Selection" in the SETUP menu before recording.) • You have used digital connection. Set "Dolby Digital" to "PCM" or connect using audio cables (analog connection). • There are discs which audio cannot be changed because of how the disc was created. 	—
		35
		9, 35
		—

Operation		Page
Cannot operate the television. The remote control doesn't work.	<ul style="list-style-type: none"> Change manufacturer code. Some televisions cannot be operated even if you change the code. The remote control and main unit are using different codes. Change the code on the remote control. 	13
	 <p>Press and hold [ENTER] and the indicated number button at the same time for more than 2 seconds.</p>	13
	<ul style="list-style-type: none"> The batteries are depleted. Replace them with new ones. Coloured glass may obstruct the signal reception/transmission. Don't place the signal sensor in direct sunlight or in areas that may be subject to sunlight exposure. The child lock function is activated. 	3
		39
The unit is on but cannot be operated.	<ul style="list-style-type: none"> Some operations may be prohibited by the disc. The unit is hot ("U59" appears on the display). Wait for "U59" to disappear. One of the unit's safety devices may have been activated. Reset the unit as follows: Press [⏻] on the main unit to switch the unit to standby. If the unit doesn't switch to standby, press and hold [⏻] on the main unit for about 10 seconds. The unit is forcibly switched to standby. Alternatively, disconnect the AC mains lead, wait one minute, then reconnect it. 	—
Cannot eject disc.	<ul style="list-style-type: none"> Timer recording is in recording standby. Press [⏻ TIMER] to cancel the recording standby. Linked timer recordings with external equipment is in recording standby ("EXT Link" on the unit's display blinks when [⏻ DVD] is pressed). Press [EXT LINK] to cancel the recording standby. The unit may have a problem. While the unit is off, press and hold [■] and [CH ^] on the main unit at the same time for about 5 seconds. Remove the disc and consult the dealer. If the Child Lock function is activated, above operation does not work. Cancel the Child Lock function. 	17, 18
		19
		39
Cannot tune channels. Cannot download channel presets.	<ul style="list-style-type: none"> Check the connections. You must connect to a television equipped with the Q Link function with a fully wired 21-pin Scart cable to download channel presets. 	7, 8
		7
Startup is slow.	<ul style="list-style-type: none"> Make sure that "Quick Start" is set to "On". Even if "Quick Start" is set to "On", startup is slow if the clock is not set, there was a power failure or the AC plug has just been connected. A few dozen seconds after turning on the unit, you can play a disc or start recording to discs other than DVD-RAM. Startup takes time for a few minutes after 5:15 am due to system maintenance of this unit. 	36
		—
		—

Recording, timer recording and transferring (dubbing)

Cannot record.	<ul style="list-style-type: none"> You haven't inserted a disc or the disc you inserted cannot be recorded on. Insert a disc the unit can record onto. The disc is unformatted. Format the disc. RAM -RW(V) The write-protect tab on the cartridge is set to PROTECT, or the disc is protected with DISC MANAGEMENT. Some programmes have limitations on the number of times they can be recorded. (CPRM) The disc is full or nearly full. Erase un-needed titles or use another disc. You cannot record on finalized DVD-R, DVD-RW (DVD-Video format), +R or DVD-RW (DVD Video Recording format) discs. Due to peculiarities of DVD-R, DVD-RW (DVD-Video format) or +R, you may be unable to record onto them if you either insert and remove the disc or switch the unit on and off while a disc is loaded, a total of fifty times. DVD-R, DVD-RW (DVD-Video format) and +R recorded on this unit may not be recordable on other Panasonic DVD recorders. 	4, 5
		32
		31
		40
		21, 27, 31
		—
Timer recording does not work properly.	<ul style="list-style-type: none"> The timer programme is incorrect or different timer programme times overlap. Correct the programme. 	18
SHOWVIEW programming does not work properly.	<ul style="list-style-type: none"> The unit is not on timer recording standby. ("⌚" on the unit's display is not on.) Press [⏻ TIMER]. Set the clock. 	17, 18
		39
Timer recording does not stop even when [■] is pressed.	<ul style="list-style-type: none"> While using timer recording, press [⏻ TIMER]. ("⌚" disappears.) When using the linked timer recording with external equipment, press [EXT LINK]. ("EXT Link" disappears.) 	17, 18
		19
The timer programme remains even after recording finishes.	<ul style="list-style-type: none"> The timer programme remains if set to daily or weekly. 	18
A part or whole of a recorded title has been lost.	<ul style="list-style-type: none"> If there is a power failure or the plug is disconnected from the household AC mains socket while recording or editing, the title may be lost or the disc may become unusable. You will have to format the disc (RAM -RW(V)) or use a new disc. We cannot offer any guarantee regarding lost programmes or discs. 	—
The DV automatic recording function does not work.	<ul style="list-style-type: none"> If images cannot be recorded or if the recording is aborted, check the connections and DV equipment settings. You cannot start recording until the images from the DV equipment appear on the television. Recording may not be performed as desired if the time codes on the tape in the DV equipment are not successive. Depending on the equipment, the DV automatic recording may not operate properly. 	30
		—
		—
		—

Play

Play fails to start even when [▶] (PLAY) is pressed. Play starts but then stops immediately.	<ul style="list-style-type: none"> Insert the disc correctly with the label facing up. You tried to play a blank DVD-RAM, DVD-R, DVD-RW (DVD-Video format), +R or DVD-RW (DVD Video Recording format) unplayable on this unit. When recording to DVD-RAM using EP (8Hours) mode, play may not be possible on DVD players that are compatible with DVD-RAM. In this case use EP (6Hours) mode. You cannot play discs during DV automatic recording. 	20
		4, 5
		34
DVD-Video is not played.	<ul style="list-style-type: none"> Some DVD-Video cannot be played when you change the ratings level. 	34
Alternative soundtrack and subtitles cannot be selected.	<ul style="list-style-type: none"> The languages are not recorded on the disc. You may have to use the disc's menus to select languages. 	—
		20
No subtitles.	<ul style="list-style-type: none"> Subtitles are not recorded on the disc. Turn the subtitles on. 	—
		24

Play (Continued)

Page

Angle cannot be changed.	<ul style="list-style-type: none"> Angles can only be changed during scenes where different angles are recorded. 	—
You have forgotten your ratings password.	<ul style="list-style-type: none"> While the disc tray is open, press and hold [● REC] and [▶/x1.3] on the main unit at the same time for 5 or more seconds. 	—
Quick View does not work.	<ul style="list-style-type: none"> This does not work when audio is other than Dolby Digital. This does not work when recording is in XP or FR mode. 	— —
The resume play function does not work.	<ul style="list-style-type: none"> This function only works when the indicator appears in the unit display. Memorized positions are canceled when the unit is turned off or when the tray is opened. The memorized position on the playlist is also canceled when the playlist and title are edited. 	— —
The Video CD picture does not display properly.	<ul style="list-style-type: none"> When connecting to Multi-system TV, select “NTSC” in “TV System” in the SETUP menu. When connecting to PAL TV, the lower part of the picture cannot be displayed correctly during search. 	38 —
Time Slip does not work.	<ul style="list-style-type: none"> Time Slip does not work when the unit’s “TV System” settings are different from the title recorded on the disc. 	38

Edit

Cannot format.	<ul style="list-style-type: none"> The disc is dirty. Wipe with a damp cloth and then wipe dry. You tried formatting a disc that is not compatible with this unit. 	5 4, 5
Cannot create chapters.	<ul style="list-style-type: none"> The unit writes the chapter information to the disc when you turn it off or remove the disc. The information is not written if there is an interruption to the power before this. 	—
Cannot mark the start point or the end point during “Partial Erase” operation.	<ul style="list-style-type: none"> These operations are not possible with still pictures. You cannot set points if they are too close to each other. You cannot set an end point before a start point. 	— —
Cannot erase chapters.	<ul style="list-style-type: none"> When the chapter is too short to erase, use “Combine Chapters” to make the chapter longer. 	27
The available recording space doesn’t increase even after erasing recordings on the disc.	<ul style="list-style-type: none"> Available recording space on the DVD-R or the +R does not increase even after erasing previously recorded titles. Available recording space on a DVD-RW (DVD-Video format) increases only when the last recorded title is erased. It does not increase if other titles are erased. 	— —
Cannot create a playlist.	<ul style="list-style-type: none"> You cannot select all the chapters at once in a title if the title also includes still pictures. Select them individually. 	—

Safety precautions

Placement

Set the unit up on an even surface away from direct sunlight, high temperatures, high humidity, and excessive vibration. These conditions can damage the cabinet and other components, thereby shortening the unit’s service life.

Do not place heavy items on the unit.

Voltage

Do not use high voltage power sources. This can overload the unit and cause a fire.

Do not use a DC power source. Check the source carefully when setting the unit up on a ship or other place where DC is used.

AC mains lead protection

Ensure the AC mains lead is connected correctly and not damaged. Poor connection and lead damage can cause fire or electric shock. Do not pull, bend, or place heavy items on the lead.

Grasp the plug firmly when unplugging the lead. Pulling the AC mains lead can cause electric shock.

Do not handle the plug with wet hands. This can cause electric shock.

Foreign matter

Do not let metal objects fall inside the unit. This can cause electric shock or malfunction.

Do not let liquids get into the unit. This can cause electric shock or malfunction. If this occurs, immediately disconnect the unit from the power supply and contact your dealer.

Do not spray insecticides onto or into the unit. They contain flammable gases which can ignite if sprayed into the unit.

Service

Do not attempt to repair this unit by yourself. If sound is interrupted, indicators fail to light, smoke appears, or any other problem that is not covered in these instructions occurs, disconnect the AC mains lead and contact your dealer or an authorized service center. Electric shock or damage to the unit can occur if the unit is repaired, disassembled or reconstructed by unqualified persons.

Extend operating life by disconnecting the unit from the power source if it is not to be used for a long time.

Manufactured under license from Dolby Laboratories. “Dolby” and the double-D symbol are trademarks of Dolby Laboratories.

“DTS” and “DTS 2.0 + Digital Out” are trademarks of Digital Theater Systems, Inc.

SHOWVIEW is a trademark of Gemstar Development Corporation. The SHOWVIEW system is manufactured under licence from Gemstar Development Corporation.

MPEG Layer-3 audio decoding technology licensed from Fraunhofer IIS and Thomson multimedia.

This product incorporates copyright protection technology that is protected by method claims of certain U.S. patents and other intellectual property rights owned by Macrovision Corporation and other rights owners. Use of this copyright protection technology must be authorized by Macrovision Corporation, and is intended for home and other limited viewing uses only unless otherwise authorized by Macrovision Corporation. Reverse engineering or disassembly is prohibited.

Index

Angle	24	Erase		Q Link	7, 41
Aspect	12	Chapter	27, 29	Quick Start	15, 36
Audio		Playlist	29	Quick View	21
Attribute	24	Title	21, 27	Ratings level	34
Language	24	Ext Link	19, 35	Recording	14
Playback	20	Finalize	32, 40	Direct TV Recording	15
AV-in NR	25	Flexible Recording	16	DV automatic recording	30
Change Thumbnail	27	Format disc	32	External Link	19
Channel		FR (Flexible Recording) Mode	14, 16	Flexible Recording	16
Audio	24	FUNCTIONS window	25	Mode	14
Auto-Setup	11	JPEG	22, 40	Timer	17-19
Preset Download	10	Language		Remote control code	13
Chapter	21, 26	Code list	36	Repeat play	24
Chasing playback	15	Soundtrack	24, 34	Resume play function	21
Child Lock	39	Subtitle	24, 34	RGB	
Cleaning		Manual Skip	21	Input	35
Disc	5	Menu		Output	7, 35
Lens	43	JPEG	22, 23	SETUP menu	33
Main unit	43	MP3	22	Shipping Condition	36
Clock settings	39	On-screen	24	SHOWVIEW	17
Connection		SETUP	33	Simultaneous rec and play	15
Aerial	7, 8	Mode		Soundtrack	24
Amplifier, system component	9	Recording	14	Status messages	25
AV3 input terminals	30	Still Mode	34	Subtitle	24
Decoder, digital receiver	9	MP3	22, 40	Teletext	15
DV input terminal	30	Noise reduction (NR)		TIFF	22, 41
Satellite receiver	9	AV-in NR	25	Time Slip	15, 21
Television	7, 8	Playback NR	25	Timer recording	17-19
Video cassette recorder	7, 8, 30	On-screen		Transfer	25
Copy (playlist)	29	Menus	24	Transfer (Dubbing)	
Country setting	10, 11	Status messages	25	DV automatic recording	30
CPRM	40	Partial Erase	27	Manual recording	30
Create Chapter	21, 27	PCM Down Conversion	35	Tuning	
Create playlists	28	Picture settings	25, 34	Auto-Setup	11
Default Settings	36	Playback NR	25	Manual	37
Dialog Enhancer	25	Playlist	28	Preset Download	10
Direct Navigator	20	Progressive	12, 25, 35, 41	TV System (PAL/NTSC)	38
Direct TV Recording	15	Properties		TV type	12
DV automatic recording	30	Playlist	29	V.S.S.	25
DVD-RAM, DVD-R, DVD-RW, +R	4, 5	Title	27	VPS/PDC	17, 41
Enter name		Protection			
Disc	31	Cartridge	31		
Entering text	33	Disc	31		
Playlist	29	Title	27		
Title	17, 18, 27				

Free Manuals Download Website

<http://myh66.com>

<http://usermanuals.us>

<http://www.somanuals.com>

<http://www.4manuals.cc>

<http://www.manual-lib.com>

<http://www.404manual.com>

<http://www.luxmanual.com>

<http://aubethermostatmanual.com>

Golf course search by state

<http://golfingnear.com>

Email search by domain

<http://emailbydomain.com>

Auto manuals search

<http://auto.somanuals.com>

TV manuals search

<http://tv.somanuals.com>