

Panasonic®

Operating Instructions DVD Recorder

Model No. **DMR-XW390**

DIGA
High Definition

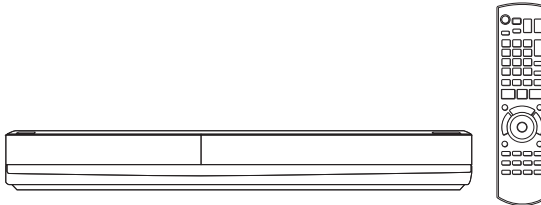

Thank you for purchasing this product.
For optimum performance and safety, please read these instructions carefully.
Please keep this manual for future reference.

- This DVD Recorder is for viewing and recording free to air DVB channels only. It does not receive pay TV or encrypted channels.

Region management information

DVD-Video: This unit can play DVD-Video discs supporting the region number "4" or "ALL".

e.g.,



GZ

VQT4C72

Safety precautions

WARNING

Unit

- To reduce the risk of fire, electric shock or product damage,
 - Do not expose this unit to rain, moisture, dripping or splashing.
 - Do not place objects filled with liquids, such as vases, on this unit.
 - Use only the recommended accessories.
 - Do not remove covers.
 - Do not repair this unit by yourself. Refer servicing to qualified service personnel.
 - Do not let metal objects fall inside this unit.
 - Do not place heavy items on this unit.

AC mains lead

- To reduce the risk of fire, electric shock or product damage,
 - Ensure that the power supply voltage corresponds to the voltage printed on this unit.
 - Insert the mains plug fully into the socket outlet.
 - Do not pull, bend, or place heavy items on the lead.
 - Do not handle the plug with wet hands.
 - Hold onto the mains plug body when disconnecting the plug.
 - Do not use a damaged mains plug or socket outlet.
- Install this unit so that the AC mains lead can be unplugged from the socket outlet immediately if any problem occurs.

SD card

- Keep the Memory Card out of reach of children to prevent swallowing.

CAUTION

Unit

- This unit utilizes a laser. Use of controls or adjustments or performance of procedures other than those specified herein may result in hazardous radiation exposure.
- Do not place sources of naked flames, such as lighted candles, on this unit.
- This unit may receive radio interference caused by mobile telephones during use. If such interference occurs, please increase separation between this unit and the mobile telephone.
- This unit is intended for use in moderate climates.

Placement

- Place this unit on an even surface.
- To reduce the risk of fire, electric shock or product damage,
 - Do not install or place this unit in a bookcase, built-in cabinet or in another confined space. Ensure this unit is well ventilated.
 - Do not obstruct this unit's ventilation openings with newspapers, tablecloths, curtains, and similar items.
 - Do not expose this unit to direct sunlight, high temperatures, high humidity, and excessive vibration.

Batteries

- Danger of explosion if battery is incorrectly replaced. Replace only with the type recommended by the manufacturer.
- Mishandling of batteries can cause electrolyte leakage and may cause a fire.
 - Do not mix old and new batteries or different types at the same time.
 - Do not heat or expose to flame.
 - Do not leave the battery(ies) in a car exposed to direct sunlight for a long period of time with doors and windows closed.
 - Do not take apart or short circuit.
 - Do not recharge alkaline or manganese batteries.
 - Do not use batteries if the covering has been peeled off.
 - Remove batteries if you do not intend to use the remote control for a long period of time. Store in a cool, dark place.
- When disposing the batteries, please contact your local authorities or dealer and ask for the correct method of disposal.

Supplied accessories

Please check and identify the supplied accessories.

(Product numbers correct as of February 2012. These may be subject to change.)

- Remote control (N2QAYB000480):** 1 pc.
 - Batteries for remote control:** 2 pcs.
 - AC mains lead:** 1 pc.
 - RF coaxial cable:** 1 pc.
 - Audio/Video cable:** 1 pc.
- Do not use AC mains lead with other equipment.

Indemnity concerning recorded content

Panasonic does not accept any responsibility for damages directly or indirectly due to any type of problems that result in loss of recording or edited content (data), and does not guarantee any content if recording or editing does not work properly. Likewise, the above also applies in a case where any type of repair is made to the unit (including any other non-HDD related component).

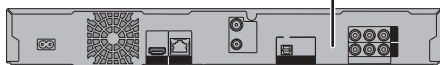

DANGER	— VISIBLE AND INVISIBLE LASER RADIATION WHEN OPEN. AVOID DIRECT EXPOSURE TO BEAM. <small>FDA 21 CFR/Class IIb</small>
CAUTION	— CLASS 3B VISIBLE AND INVISIBLE LASER RADIATION WHEN OPEN. AVOID EXPOSURE TO THE BEAM. <small>IEC60825-1 +A2, Class 3B</small>
ATTENTION	— RAYONNEMENT LASER VISIBLE ET INVISIBLE. CLASSE 3B. EN CAS D'OUVERTURE, EVITER UNE EXPOSITION AU FAISCEAU.
FORSIGTIG	— SYNLIG OG USYNLIG LASERSTRÅLING KLASSE 3B. NÅR LAGET ER ÅBENT, UNDGÅ AT BLIVE UDSÅT FOR STRÅLEN.
VARO	— AVATTAESSA OLET ALTTIINA LUOKAN 3B NÄKYVÄÄ JA NÄKYMÄTÖNTÄ LASERSÄTEILYÄ. VÄRÖ ALTIJUMISTA SÄTEELLE.
WARNING	— CLASS 3B SYNLIG OCH OSYNLIG LASERSTRÅLNING NÄR DENNA DEL ÄR ÖPPNAD. UNDVIK EXPONERING FÖR STRÅLEN.
VORSICHT	— SICHTBARE UND UNSICHTBARE LASERSTRHLUNG KLASSE 3B. WENN ABDECKUNG GEÖFFNET, NICHT DEM STRAHL AUSSETZEN.
注意	— 打开时有可见及不可见激光辐射。避免光束照射。
注意	— ここを開くと可視及び不可視レーザー光が出ます。ビームを見たり、触れたりしないでください。VQL1J70

(Inside of product)

Table of contents

Safety precautions	2	Editing video	
Supplied accessories	3	Deleting recorded titles	35
Getting started		Editing recorded titles	36
HDD and media information	6	Copying video	
- Recordable/playable contents	6	Copying titles	40
- Recording mode	7	- Copying titles from DIRECT NAVIGATOR	42
- Notes	8	- Notes for copying	43
Unit care	10	- Copying a finalised disc	44
Control reference guide	11	- Copying Title Playing	45
Connection	13	- Copying HD Video (AVCHD format) to the DVD-R in High Definition	45
- Basic connections	13	Pictures	
- Other TV connection	14	Playing pictures	46
- Amplifier/receiver connections	14	- Start Slideshow	47
- Network connection	15	- Picture play option	47
Settings	16	Editing pictures	48
- TV operation buttons	16	Copying pictures	50
- Easy setting	17	- Copying automatically	50
- Network Easy Settings	18	- Copying using the copying list	50
FUNCTION MENU screen	19	Music	
Watching broadcasts		Playing music	52
Watching broadcasts	20	- Copying music to HDD	52
- Using Channel List	20	- Playing music recorded on HDD	53
- Using TV Guide system	20	- Operations during music play	54
- Using channel information	21	Editing music/playlist	55
- Operations while watching broadcast	22	With Other Equipment	
- PAUSE LIVE TV	22	Recording from external equipment	56
Recording		- Manual Recording	56
Recording TV programmes	23	- Flexible Recording via AV input	56
- Operation during Recording	24	Copy the HD Video or the SD Video	57
Timer recording	25	- Copying HD Video (AVCHD format)	57
- Manually programming timer recording	26	- Copying SD Video (MPEG2 format)	58
- Timer recording options	26	DLNA functions	59
- Timer recording from channel information	27		
- Notes on timer recording	27		
- To confirm and edit the timer programme	28		
Playing back video			
Playing titles on the HDD	29		
- DIRECT NAVIGATOR (VIDEO) screen	29		
Playing titles on the media	31		
Operation during play	33		

Convenient functions

Disc and card management	60
VIERA Link functions	62
VIERA CAST (Enjoying Internet Service) ...	63
Playback menu	64
Changing the unit's settings	66
- Common procedures	66
- Digital TV Tuning	68
- HDD / Disc	70
- Picture	72
- Sound	72
- Display	74
- Connection	74
- Network	75
- Others	77
- Language code list	79
Software (Firmware) Update	80
Other Operations	81
- Entering text	81
- Switching the aspect ratio of the screen	81
- HOLD function	81

Troubleshooting

Troubleshooting guide	82
- General operation	82
- Displays	83
- TV screen and video	83
- Sound	84
- Recording, timer recording and copying	84
- Play	85
- Edit	86
- Picture	86
- Music	86
- USB	86
- TV Guide	86
- Broadcast	87
- VIERA Link	87
- Network	87
- Reset	87
- Messages on the unit's display	88
- When you experience problems with Network Easy Setting	91

Reference

Specifications	92
Licenses	97
Index	101

About descriptions in these operating instructions

- Pages to be referred to are indicated as "⇒ ○○".

Getting started

Watching broadcasts

Recording

Playing back video

Editing video

Copying video

Pictures

Music

With Other Equipment

Convenient functions









Troubleshooting

Reference

HDD and media information

Recordable/playable contents

(-: Impossible)



Media type	Standard symbol	Recordable contents	Playable contents
Hard disk drive (HDD)* ¹		HDD	<ul style="list-style-type: none"> • Video • AVCHD • JPEG • Music copied from music CD • MP3
DVD-Video* ³		DVD-V	<ul style="list-style-type: none"> • Video
DVD-RAM* ¹		RAM	<ul style="list-style-type: none"> • Video • JPEG
DVD-R DVD-R DL		DVD-R	<ul style="list-style-type: none"> • Video • AVCHD*²
 			<ul style="list-style-type: none"> • DivX® • JPEG • MP3
DVD-RW* ¹		DVD-RW	<ul style="list-style-type: none"> • Video
+R/+R DL		+R	<ul style="list-style-type: none"> • Video
+RW* ¹			+RW
Audio CD (CD-DA)			CD
CD (including CD-R/RW)			<ul style="list-style-type: none"> • DivX® • JPEG • MP3
SD Cards* ¹		SD	<ul style="list-style-type: none"> • JPEG
USB memories		USB	<ul style="list-style-type: none"> • AVCHD*^{2, 4} • MPEG2*^{4, 5} • DivX® • JPEG • MP3

- ※1 Rewritable media
- ※2 Recorded with AVCHD compatible devices (Panasonic video camera, etc.). It may not be able to play back, add, or edit depending on the device.
- ※3 Includes finalised DVD-R, DVD-R DL, DVD-RW, +R and +R DL.
- ※4 It cannot be played back directly from the SD card or USB memory. Playback is possible by copying to the HDD.
- ※5 Recorded with MPEG2 compatible devices (Panasonic video camera, etc.). It may not be able to play back, add, or edit depending on the device. (⇒ 58)



- **+RW** This unit cannot record to 8X Speed +RW disc.
- **USB** Video images of the copyright-protected DivX contents stored on USB device can be output only through the HDMI output terminal.
- The producer of the disc can control how discs are played. So you may not always be able to control play as described in these operating instructions. Read the disc's instructions carefully.
- With certain recording states and folder structures, the play order may differ or playback may not be possible.

Recording mode

Recording Mode	DR	HG/HX/HE/HL/HM	XP/SP/LP/EP/FR
Feature	Programmes can be recorded in a nearly perfect broadcasted state.	Recording can be done with reduced recording volume in HD quality.	Recording can be done with reduced recording volume in SD quality.
Quality	Quality as the broadcast	High definition*1	Standard definition
Recordable media			 
Multiple audio	Record all multiple audio	Record only one audio	
Subtitles	Can be recorded	Can be recorded (only one subtitle)*2	
Surround audio	Surround audio as the broadcast	Surround audio produced by conversion of broadcast audio format	Stereo audio

※1 The SD quality programme can not be converted to HD quality.

※2 You cannot select during play whether it appears or disappears.

Approximate recording times

Refer to "Recording modes and approximate recording times". (⇒ 96)

• FR (Flexible Recording Mode)

The unit automatically selects the best possible recording rate between XP and EP (8 hours).

HDD and media information

Notes

About extension of files

File format	Extension					
JPEG	“.JPG”	“.jpg”				
MP3	“.MP3”	“.mp3”				
DivX	“.DIVX”	“.divx”	“.AVI”	“.avi”		
Subtitle text files*	“.SRT”	“.srt”	“.SUB”	“.sub”	“.TXT”	“.txt”

* The video file and subtitles text file are inside the same folder, and the file names are the same except for the file extensions.

- Some files may not be played back even if they have these extensions.

Notes for the disc

• Cartridge-protection

For a DVD-RAM with a cartridge

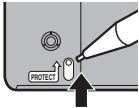

• Disc recorded on another device

- It may be necessary to finalize the disc, create Top Menu or close the session on the equipment used for recording to play on this unit.
- **DVD-RW** Recorded in DVD Video Recording (DVD-VR) format
 - This unit can play back and copy to HDD.
 - This unit does not support editing or recording.
 - It is possible to record and edit with DVD-Video (DVD-V) format by formatting discs with this unit.
- Recording may not be possible to discs which were used for recording on other equipment.

• Play on other players

- **DVD-R** **DVD-RW** **+R** **+RW** Finalisation is needed. (⇒ 61)
- **+RW** If the disc failed to play on other equipment, we recommend you create a Top Menu (⇒ 61).

• Regarding 8 cm Disc

This unit cannot record or edit the 8 cm disc. Only playback or copy to the HDD is possible.

• Discs that cannot be played

- Blu-ray Disc (BD-Video, BD-RE, BD-R) - 2.6 and 5.2 GB DVD-RAM, 12 cm
- DVD-Audio - HD DVD
- Super Video CD, Super Audio CD, Video CD - CD-ROM, Photo CD, PD, etc.
- WMA discs, DivX Plus HD discs



- Operation and sound quality of CDs that do not conform to CD-DA specifications (copy control CDs, etc.) cannot be guaranteed.

Notes for the USB devices

- This unit does not guarantee connection with all USB devices.
- FAT16 and FAT32 file systems are supported.
- This unit supports USB 2.0 High Speed.



- USB memories support DivX files less than 4 GB.

Notes for the SD cards

• Compatible SD card

- SD Memory Card
(from 8 MB to 2 GB, FAT12 and FAT16 formats)
- SDHC Memory Card
(from 4 GB to 32 GB, FAT32 format)
- SDXC Memory Card
(48 GB, 64 GB, exFAT format)

• Using miniSD card or microSD card

Mini-type and micro-type cards can also be used, but must be used with adaptor cards (optional).

To format an SD card

Refer to "Format Disc/Format Card". (⇒ 60)



- Usable memory is slightly less than the card capacity.
- If the SD card is formatted on other equipment, the time necessary for recording may be longer or the card may not be able to be used on this unit. In these cases, format the card on this unit.
- SDHC Memory Cards and SDXC Memory Cards can be used in equipment that is compatible with the appropriate cards. (SDHC Memory Cards can also be used in equipment compatible with SDXC Memory Cards)

Media handling

- Do not touch the recorded surface of the discs or the terminal surface of the SD cards.



- If there is dirt or condensation on the disc, wipe with a damp cloth and then wipe dry.



- Do not attach labels or stickers to discs.
- Do not use disc cleaning sprays, benzene, thinner, static electricity prevention liquids or any other solvent.
- Do not use ballpoint pens or other hard writing implements, when writing on the label side of the disc.
- Do not drop, stack, or impact discs.
- Do not place objects on discs.
- Do not use the following discs:
 - Discs with exposed adhesive from removed stickers or labels (rental discs, etc.).
 - Discs that are badly warped or cracked.
 - Irregularly shaped discs.

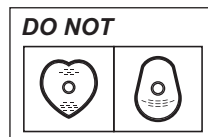

- Do not expose the terminals of the SD card to water, garbage or other strange things.
- Do not place in the following areas:
 - In hot places, such as under the direct sunlight.
 - In very dusty or humid areas.
 - Locations susceptible to significant difference in temperature (condensation can occur).
 - Where static electricity or electromagnetic waves occur.

Unit care

HDD handling care

- **The HDD is a high precision device**

The HDD is a high precision recording instrument and is easily susceptible to damage. Therefore, be careful of the following points while the unit is turned on, especially during operation, otherwise the HDD and the recorded content may be damaged:

- Do not subject the unit to any vibration and shock.
- Do not remove the AC mains lead from the household mains socket.

- **The HDD is a temporary storage device**

- The HDD is not an everlasting storage device. It is recommended to save the recorded content on a disc or to keep the original data or CDs that they were copied from.
- If you notice a problem with the HDD such as repetitive strange sounds, immediately save (backup) all content and request service. If you continue using the HDD with a problem, the unit or the recorded content will be damaged.

- **If the HDD is damaged, the recorded content cannot be recovered.**

Setup precautions

- **Place the unit on a surface that is flat and not subject to vibration or impact.**
- **Do not place on anything that generates heat like a Set Top Box, etc.**
- **Place in an area where condensation does not occur. Conditions where condensation may occur**
 - When there is an extreme change in temperature (e.g., when subjected to an air conditioner or when cooled air directly impacts the unit).
 - When there is high humidity or a lot of steam in the room.

In the above situation, **without turning the unit on**, let the unit adjust to the room temperature and wait 2–3 hours until condensation is gone.

- **Do not block the cooling fan on the rear of the unit.**
- **The unit may breakdown if cigarette smoke or bug spray/vapour, etc. gets inside the unit.**

When moving the unit

Before moving the unit, ensure the disc tray is empty.

- 1 Switch the unit to standby mode. (Wait until “BYE” disappears from the display.)
- 2 Remove the AC mains lead from the household mains socket.
- 3 Move only after the unit has come to a complete stop (approx. 3 minutes) in order to avoid subjecting to vibration and shock. (Even after the unit is switched to standby mode, the HDD continues operating for a short time.)

Cleaning

- **This unit**

- Wipe with a soft, dry cloth.
- Never use alcohol, paint thinner or benzine to clean this unit.
- Before using chemically treated cloth, carefully read the instructions that came with the cloth.

- **This unit's lens**

Use the **Lens cleaner** (optional) to clean the unit's lens.

Lens cleaner: RP-CL720AE

- This lens cleaner may not be for sale depending on the region.

Control reference guide

Instructions for operations are generally described using the remote control.

Remote control

- ① Transmit the remote control signal
 - Point it at remote control signal sensor on this unit. (⇒ 12)
- ② Switch the unit from on to standby mode or vice versa
- ③ Select drive (HDD, DVD, SD or USB)
- ④ Select channels and title numbers, etc./Enter numbers or characters
- ⑤ To delete unwanted recorded titles, timer programmes, pictures or music (⇒ 35)
- ⑥ Basic operations for recording and play, PAUSE LIVE TV (⇒ 22)
- ⑦ Show Information (⇒ 21, 30, 33)
- ⑧ Selection/OK, Frame-by-frame (⇒ 33)
- ⑨ Show DIRECT NAVIGATOR, Top Menu (⇒ 29, 34)
- ⑩ Show OPTION menu (⇒ 36, 48, 55)
- ⑪ Colour buttons (Use in accordance with instruction on the screen.)
- ⑫ Start recording (⇒ 23, 56)
- ⑬ Select a recording mode (⇒ 56)
- ⑭ Show Teletext (⇒ 22)
- ⑮ Show subtitles (⇒ 22, 34)
- ⑯ TV operation buttons (⇒ 16)
- ⑰ Channel select (⇒ 20)/Change pages in the DIRECT NAVIGATOR screen etc.
- ⑱ Show the VIERA CAST screen (⇒ 63)
- ⑲ Input select (⇒ 20, 56)
- ⑳ Show the Timer Recording screen (⇒ 26)
- ㉑ Exit the menu screen
- ㉒ Show the TV Guide screen (⇒ 20)
- ㉓ Show the FUNCTION MENU screen (⇒ 19)
- ㉔ Return to previous screen
- ㉕ Skip the specified time (⇒ 34)
- ㉖ Create chapter (⇒ 34)
- ㉗ Show Playback Menu (⇒ 64)
- ㉘ Select audio (⇒ 22, 34)

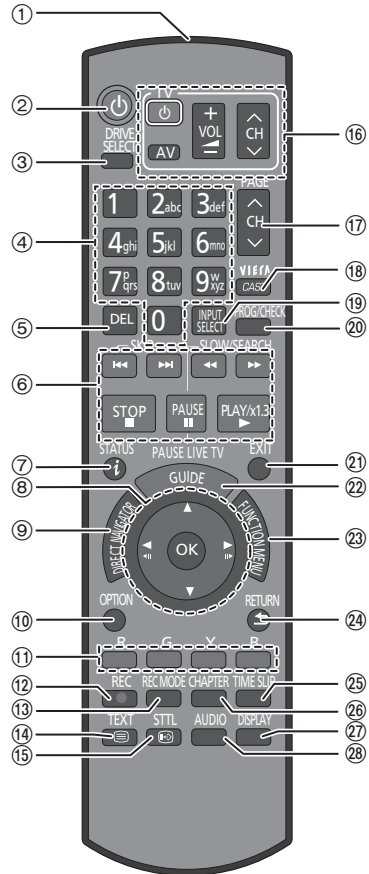

Insert batteries

Insert so the poles (+ and -) match those in the remote control.

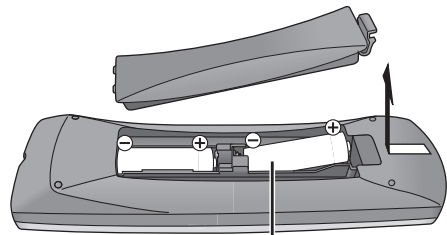

R6/LR6, AA

(Alkaline or manganese batteries)

Control reference guide

Main unit

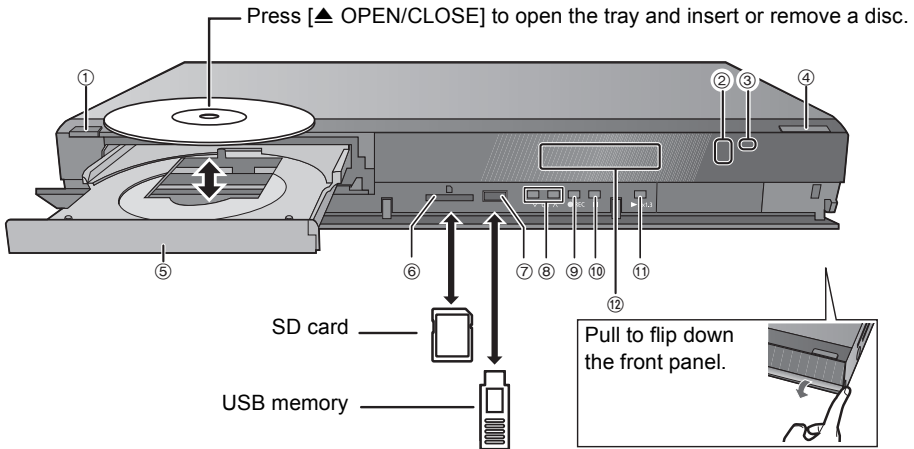

① Standby/on switch (⏻/⏻)

Press to switch the unit from on to standby mode or vice versa. In standby mode, the unit is still consuming a small amount of power.

② Recording indicator

- The indicator will light up while recording.
- The indicator will blink while recording is paused and before recording starts.

③ Remote control signal sensor

- Angle: Approx. 20° up and down, 30° left and right
- Distance: Within approx. 7 m in front of the unit

④ Open/close disc tray

⑤ Disc tray

⑥ SD card slot

- When removing the SD card, press on the centre of the card and pull it straight out.

⑦ USB port

⑧ Channel select

⑨ Start recording (⇒ 23)

⑩ Stop

⑪ Start play

⑫ Display

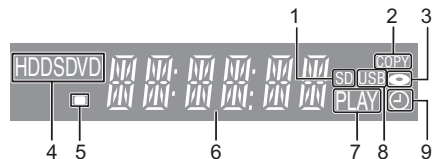

- 1 SD card slot indicator
- 2 Copying indicator
- 3 Disc indicator
- 4 Drive (HDD, DVD or SD) indicator
- 5 Remote control signal indicator
- 6 Main display section indicator
 - Current time
 - Playback counter
 - Various messages (⇒ 88)
- 7 Playback indicator
- 8 USB port indicator
- 9 Timer recording indicator
 - This indicator lights up when the timer recording standby is activated.



- While writing to/reading from the media, do not switch the unit to standby mode or remove the media. Such action may result in loss of the media contents.
- When inserting the media, ensure that it is facing the right way up.

Connection

Basic connections

- Before connection, turn off all equipment and read the appropriate operating instructions.

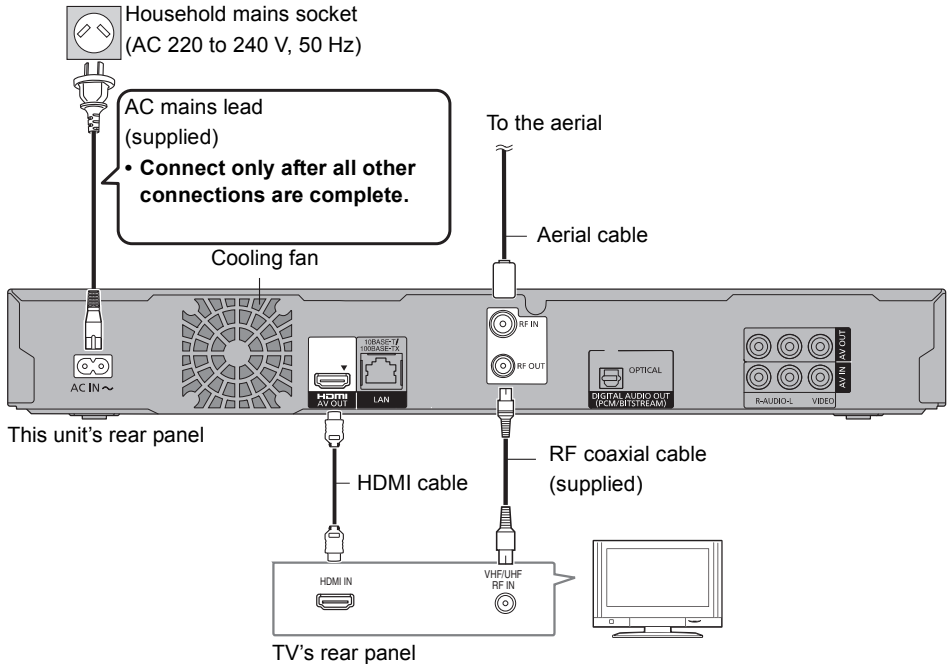

If the TV does not have the HDMI terminal

Connect the TV with the Audio/Video cable. (⇒ 14)

About HDMI cable

- Use the High Speed HDMI cables. Non-HDMI-compliant cables cannot be utilized.
- When outputting 1080p signal, please use HDMI Cables 5.0 meters or less.
- Recommended Panasonic HDMI cable part number:
RP-CDHS15 (1.5 m), RP-CDHS30 (3.0 m), RP-CDHS50 (5.0 m), etc.

When the unit is not to be used for a long time

To save power, unplug it from the household mains socket. This unit consumes a small amount of power, even when the unit is in standby mode.

[approx. 1.1 W ("Power Save in Standby" is activated)]



- The HDMI connection supports VIERA Link "HDAVI Control" (⇒ 62).
- You cannot connect this unit to DVI devices that are incompatible with HDCP.
Depending on the device, images may not display properly or at all when connecting with a DVI/HDMI switching cable. (Audio cannot be output.)
- If you are connecting to a TV that is only compatible with 2 channel audio output, audio with 3 channels or more will be down mixed and output as 2 channels, even if connecting with an HDMI cable. (Some discs cannot be down mixed.)

Connection

Connect the Set Top Box or video equipment

- Connect to terminals of the same colour.

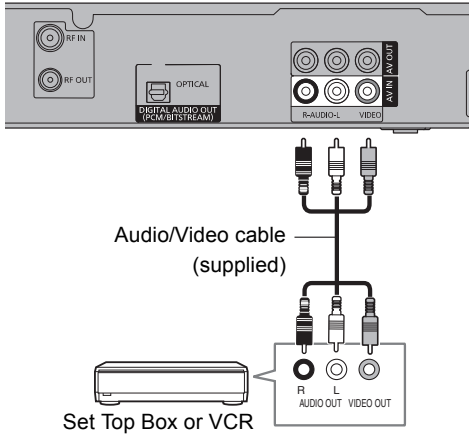

Other TV connection

- Connect to terminals of the same colour.

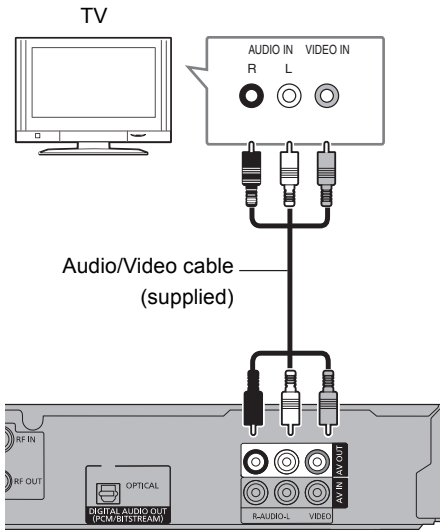

- Do not connect video signals through a video recorder. Due to copy guard protection the picture may not be displayed properly.

Amplifier/receiver connections

HDMI terminal

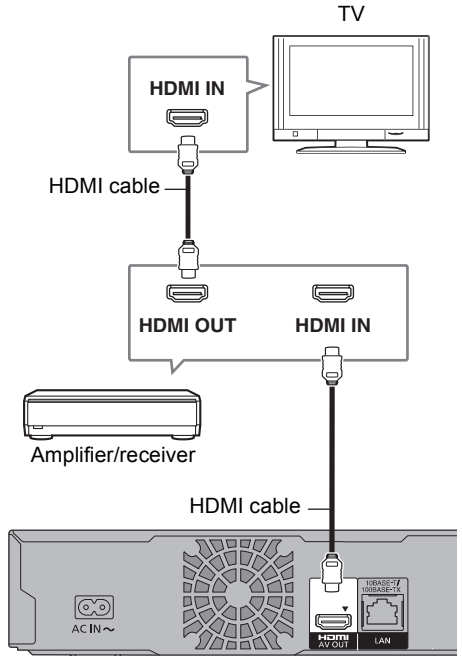

- VIERA Link function is possible by connecting to a TV or amplifier/receiver compatible with VIERA Link.

DIGITAL AUDIO OUT terminal

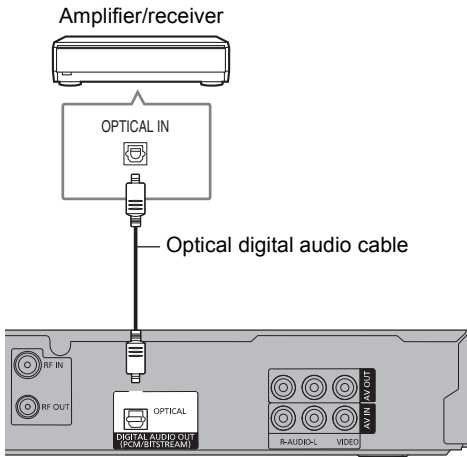

- When you do not want the audio to be output from the TV, set "HDMI Audio Output" to "Off" (⇒ 66, 75).

AUDIO OUT terminal

- Connect to terminals of the same colour.

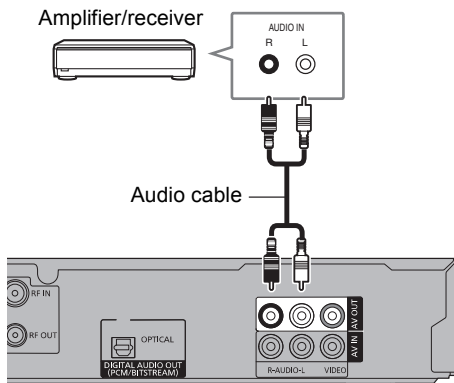

Network connection

Following function will be available when this unit is connected to the network.

- Home network (DLNA) (⇒ 59)
- VIERA CAST (⇒ 63)
- Automatically acquire the information of the CD (⇒ 52)
- Update the software (firmware) of this unit from internet (⇒ 80)

For details about connection method, refer to the instructions supplied with the connected equipment.

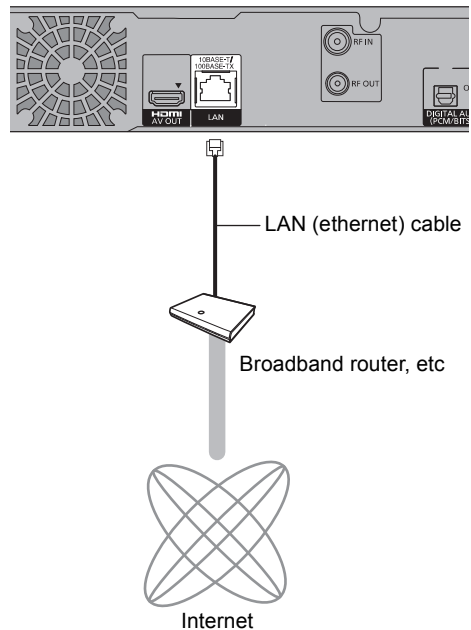

- Use category 5 or above straight LAN cables (STP) when connecting to peripheral devices.
- Inserting any cable other than a LAN cable in the LAN terminal can damage the unit.

Settings

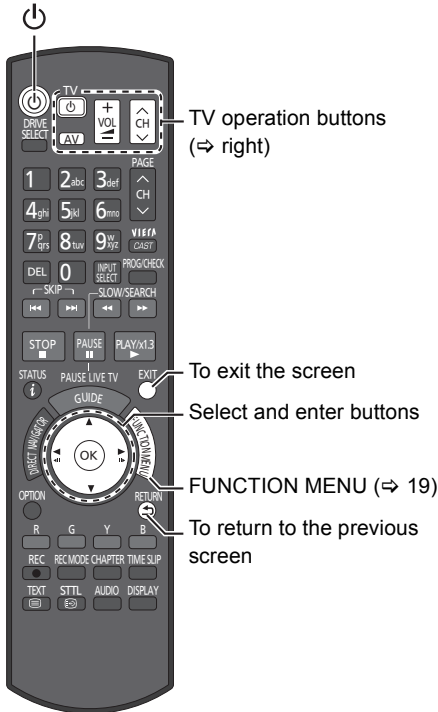

TV operation buttons

The TV can be operated from the TV operation buttons of the remote control.

- Perform the setting if you cannot operate the TV with the TV operation buttons.

While pressing [TV], enter the code with the number buttons.

Manufacturer and Code No.

Brand	Code	Brand	Code
Panasonic	01/02/03/04	NEC	36
AIWA	35	NOBLEX	33
AKAI	27/30	NOKIA	25/26/27/60/61
BEKO	05/71/72/73/74	NORDMENDE	10
BENQ	58/59	OLEVIA	45
BRANDT	10/15	ONWA	30/39/70
BUSH	05	ORION	05
CENTREX	66	PEONY	49/69
CURTIS	05	PHILCO	41/48/64
DAEWOO	64/65	PHILIPS	05/06/46
DESMET	05	PHONOLA	05
DUAL	05	PIONEER	37/38
ELEMIS	05	PROVIEW	52
FERGUSON	10/34	PYE	05
FINLUX	61	RADIOLA	05
FISHER	21	SABA	10
FUJITSU	53	SALORA	26
FUNAI	63/67	SAMSUNG	32/42/43/65/68
GOLDSTAR	05/50/51	SANSUI	05
GOODMANS	05	SANYO	21/54/55/56
GRADIENTE	36	SCHNEIDER	05/29/30
GRUNDIG	09	SEG	05/69/75/76/77/78
HITACHI	05/22/23/40/41	SELECO	05/25
IRRADIO	30	SHARP	18
ITT	25	SIEMENS	09
JVC	17/30/39/70	SINUDYNE	05
KDS	52	SONY	08
KOLIN	45	TCL	31/33/66/67/69
KONKA	62	TELEFUNKEN	10/11/12/13/14
LG	05/50/51	TEVION	52
LOEWE	07/46	THOMSON	10/15/44
MAG	52	TOSHIBA	16/57
METZ	05/28	WHITE	05
MITSUBISHI	05/19/20/47	WESTINGHOUSE	
MIVAR	24	YAMAHA	18/41

- If the brand of your TV is not listed or the code number is invalid for the TV, this remote control is not compatible with your TV.



- If your TV brand has more than one code listed, select the one that allows correct operation.

Easy setting

- 1** Turn on the TV, then select the appropriate AV input to suit the connections to this unit.
- 2** Press [⏻] on the remote control or [⏻/I] on this unit.
 - The Easy Setting will start at the initial power on.
- 3** Follow the on-screen instructions and perform the settings.
 - When the Download from TV screen appears, the setting information on the TV is acquired by this unit. (⇒ 62)
 - When the Auto Setup screen appears, the unit searches for the terrestrial digital channels. It takes about 3 minutes.

RF Ch	Channel Name	Type	Quality
35	○○○○	Digital TV	10
35	○○○○	Digital TV	10
Digital TV: 2	Radio: 0		
Searching			

After tuning has been completed, clock will be set automatically.
If the clock setting screen appears, set the time manually (⇒ 78, Clock).

- 4** Set "Power Save" to "On", "On Timer" or "Off", then press [OK].

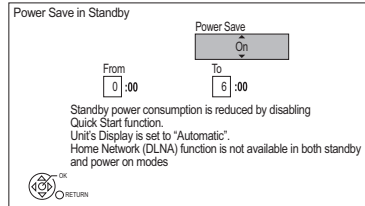

- **On**
It will go into the Power Save in Standby mode.
- **On Timer**
Set the period of power save and then press [OK].
 - Power Save in Standby mode is activated at the set time period.
- **Off**
It is possible to start quickly from the standby mode. (Quick Start mode)

When "Easy Setting has been completed." appears, Easy setting is complete.

To stop partway

Press [RETURN].

To restart set up

- 1 Press [FUNCTION MENU]. (⇒ 16)
- 2 Select "Setup" in "Others", then press [OK].
- 3 Select "Auto Setup" in "Digital TV Tuning", then press [OK].
- 4 Select "Yes", then press [OK].

If the TV aspect setting screen appears

Refer to "TV Aspect". (⇒ 74)

To confirm that channels have been tuned correctly

Refer "Using Channel List". (⇒ 20)



- If tuning is cancelled partway through, it may not be possible to receive the channels. Restart setup again.

Settings

Network Easy Settings

After completing "Easy setting", you can continue with "Network Easy Settings".

- 1** Follow the on-screen instructions and make the following confirmation.
 - Network connection test
 - Internet connection test
- 2** When "Network Easy Setting have been finished." appears.
Press [OK].

When you experience problems

Refer to "When you experience problems with Network Easy Setting". (⇒ 91)

To restart Network Easy Settings

- 1 Press [FUNCTION MENU]. (⇒ 16)
- 2 Select "Setup" in "Others", then press [OK].
- 3 Select "Network Easy Settings" in "Network", then press [OK].

To redo settings individually

If "Network Easy Settings" did not work properly or when you change the settings individually, perform the following steps:

- 1 Press [FUNCTION MENU]. (⇒ 16)
- 2 Select "Setup" in "Others", then press [OK].
- 3 Select "Network Settings" in "Network", then press [OK].
- 4 Refer to "Network Settings". (⇒ 75)



- Refer to the operating instructions of the hub or router.

FUNCTION MENU screen

You can easily access the desired functions, such as playback, timer recording, the unit's settings etc. via the FUNCTION MENU.

1 Press [FUNCTION MENU].

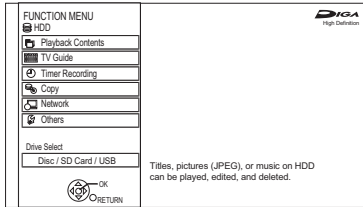

2 Select the item, then press [OK]

FUNCTION MENU list

FUNCTION MENU

- Playback Contents
 - Video (⇒ 29)
 - Picture (⇒ 46)
 - Music (⇒ 52)
- TV Guide (⇒ 20)
- Timer Recording (⇒ 25)
- Copy (⇒ 40)
 - Copy (VIDEO / PICTURE) (⇒ 40, 50)
 - Copy Video (AVCHD) to Disc (⇒ 45)
- Network (⇒ 63)
- Others
 - Playlists (⇒ 31)
 - Flexible Recording via AV input (⇒ 56)
 - Copy Video (AVCHD) (⇒ 57)
 - Copy Video (MPEG2) (⇒ 58)
 - Copy New Pictures (JPEG) (⇒ 50)
 - DVD Management (⇒ 60)
 - Card Management (⇒ 60)
 - Setup (⇒ 66)
 - You can change the unit's settings of Digital TV Tuning, Sound, Display, Connection, Network etc. in the Setup menu.
- Drive Select
 - HDD
 - DVD
 - SD Card
 - USB



- Selectable items will change depending on the type and status of the media.

Watching broadcasts

Instructions for operations are generally described using the remote control. (⇒ 11)

- 1 Press [INPUT SELECT] and select “TV”, then press [OK].

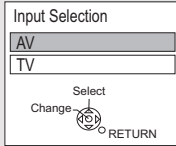

- 2 Press [^ v CH] to select the channel.

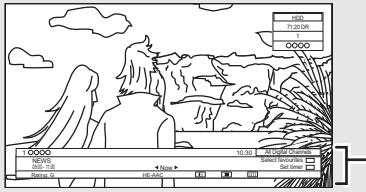

Channel information (⇒ 21)

- You can also select the channel by the following operations
 - Using number buttons.
 - Using Channel List (⇒ right)
 - Using TV Guide system (⇒ right)
 - Using channel information (⇒ 21)

About MyFreeview

MyFreeview via UHF aerial is available to 86% of New Zealand homes. Visit www.freeviewnz.tv to check coverage in your area.



- If you have set a ratings level, you may be asked to enter the PIN to start viewing the broadcast. (⇒ 69, Child Lock (Parental Rating))

Using Channel List

You can select from the list of channel names.

- 1 Press [OK].

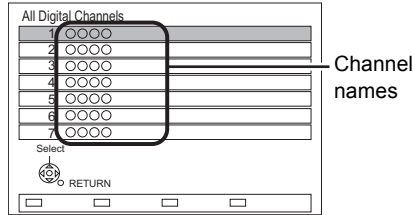

- 2 Select the channel, then press [OK].

To edit the Channel List

Refer to “Channel List”. (⇒ 68)

Using TV Guide system

The TV Guide system enables you to select programme easily, view programme information, etc. It provides the future broadcasts over the next eight days (depending on the broadcasters). (The following operations and on-screen displays of the TV Guide system are current as of February 2012, but are subject to change. If a different screen is displayed, follow the on-screen instructions.)

Press [GUIDE].

- “loading..” appears on the television screen before TV Guide is displayed.
- Press [GUIDE] again to switch between Listings screen and Now/Next screen.
- Press [OK] to watch the current programme.

To return to TV

Press [EXIT].

To set a timer Recording using the TV Guide System

Refer to “Timer recording”. (⇒ 25)



- It may take several tens of seconds to display the TV Guide screen.

Listings screen

e.g.,

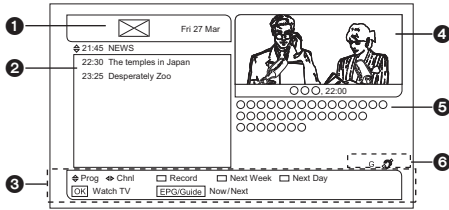

- ❶ Channel logo and date for the listings shown below
- ❷ Programme times and names
- ❸ Display navigation
- ❹ A mini-screen showing the programme you were previously watching with channel name and current time
- ❺ Synopsis for the currently highlighted programme
- ❻ Parental Rating and Captioning information

To show other channels

Press [◀, ▶].

To show other programmes

Press [▲, ▼].

To view a programme list for another day

Press the yellow button or the blue button.

Now/Next screen

e.g.,

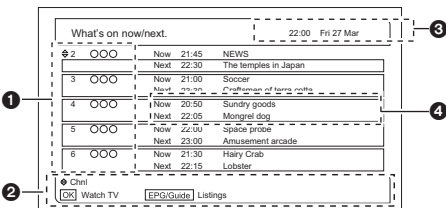

- ❶ Channel numbers and name
- ❷ Display navigation
- ❸ Current time and date
- ❹ Programmes currently showing and up next including start times

To show other channels

Press [▲, ▼].

Using channel information

While watching a programme

Press [STATUS ⓘ].

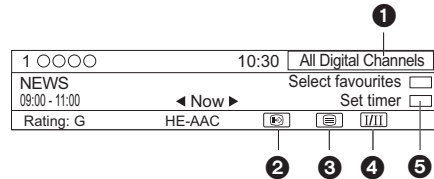

- ❶ Current Favourites
- ❷ Subtitle
- ❸ Teletext
- ❹ Multiple audio
- ❺ Set timer (⇒ 27)

To show detailed information

Press [STATUS ⓘ] again.

To hide the information screen

Press [EXIT].

To change Favourites

Press the blue button.

• Register your favourite channels

Selection of channel is made easy by creating a Favourites of the channels you watch often. (⇒ 68, Favourites Edit)

To switch between the current programme and the next programme

Press [◀, ▶].

To switch information of the other channel and select the programme

Press [▲, ▼], then press [OK].

Watching broadcasts

Operations while watching broadcast

To show subtitle

When “” appears in channel information (⇒ 21)

Press [STTL ].

- Press again to hide subtitle.





Switching audio

Press [AUDIO].

- Audio will switch according to the contents of the programme every time it is pressed.

To show Teletext

When “” appears in channel information (⇒ 21)

- 1 Press [TEXT ].
- 2 Use [, , , ], number buttons or colour buttons, etc. according to on-screen instructions.



- You can change the display mode. (⇒ 66, 74, Teletext)



Aspect

You can switch the screen mode.

Refer to “Switching the aspect ratio of the screen”. (⇒ 81)

PAUSE LIVE TV

When you pause a live TV programme, temporary save starts. Then you can restart watching from the paused position.

- 1 While watching TV:
Press [PAUSE ].
- 2 When you want to resume:
Press [PLAY/× 1.3 ].
• You can perform search or Quick View, etc.

Display information

Press [STATUS ] a few times.



- 1 Current time
- 2 The time when the picture currently displayed on the television was broadcasted
- 3 The amount of time temporarily saved on HDD.

To stop PAUSE LIVE TV

- 1 Press [STOP ].
- 2 Select “Yes”, then press [OK].

To hide the display information

Press [EXIT]



- Temporary save is stopped in following cases.
 - When save time exceeds 8 hours (This may vary depending on the HDD free space.)
 - When save time exceeds 1 hour with no HDD free space
 - When two programmes are recorded simultaneously
 - When a timer recording from external input started. (PAUSE LIVE TV from external equipment)
- The PAUSE LIVE TV function does not work
 - The clock is not set.
 - While two programmes simultaneous recording
 - While watching a programme being recorded
 - When a radio programme is selected
- You can operate this unit with the TV remote control by using VIERA Link (⇒ 62). Refer to the TV operating instructions.

Recording TV programmes



- This operation will only record to HDD.
- Recording mode is DR only.
Performing "DR File Conversion" after recording makes it possible to change the recording mode. (⇒ 38)
- This unit can record two programmes being broadcasted at the same time.

1 Select the channel to record.

2 Press [● REC].

Recording starts.

- "REC1" or "REC2" will light on the unit's display.

3 Select "Automatic Stop", then press [OK].

- **One touch recording (OTR)**

Recording stops automatically when the programme ends.

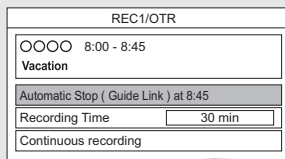

- You can also select "Recording Time" or "Continuous recording". (⇒ right)

To set the recording time

- 1 Select "Recording Time" or "Continuous recording" in step 3 (⇒ left).

Recording Time:

You can set the length of recording time from 30 minutes to 4 hours.

- You can select the recording time with [◀, ▶].

Continuous recording:

The recording is continued until you press [STOP ■].

- 2 Press [OK].

To convert the recording mode after recording

Refer to "DR File Conversion". (⇒ 38)



- One recording will terminate when simultaneous recording is being done and timer recording starts.
- Teletext will not be recorded.
- Following operations cannot be performed while recording.
 - playback of DivX file
 - playback of photo
 - copying of photo to the HDD
 - copying of music to the HDD
 - copying of AVCHD video to the HDD
- When "Automatic Standby after OTR" is set to "On" (⇒ 77), this unit is turned to standby mode if this unit is not operated for approximately 5 minutes after completing "Automatic Stop" or "Recording Time".

Recording TV programmes

Operation during Recording

To check the recording programme

Press [STATUS 

e.g., While recording two programmes simultaneously

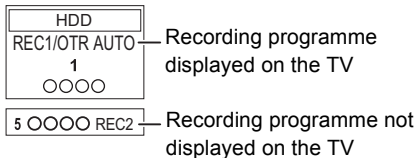

To stop recording

It is necessary to display the programme you want to stop on the TV screen.

Press [STOP 

To pause recording

After displaying the recording programme, press [PAUSE 

- Press again to restart recording.
(A title is not split into separate titles.)



- Timer recording programme cannot be paused.

To record two programmes simultaneously

While recording, perform steps 1–3 on page 23.



- Channel or input can only be switched between the recording programmes.

Simultaneous rec and play

You can play the recording title from the beginning or the titles previously recorded to the HDD.

- 1 Press [DIRECT NAVIGATOR].

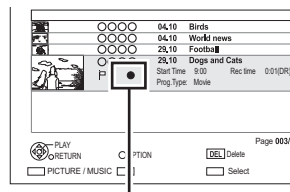

“●” is displayed on the recording programme.

- 2 Select the title, then press [OK].

Timer recording

The following operations and on-screen displays of the TV Guide system are current as of February 2012, but are subject to change. If a different screen is displayed, follow the on-screen instructions.



- This operation will only record to HDD.
- Recording mode is DR only. Performing "DR File Conversion" after recording makes it possible to change the recording mode. (⇒ 38)
- This unit can record two programmes being broadcasted at the same time.

1 Press [GUIDE].

TV Guide screen appears.

e.g.,

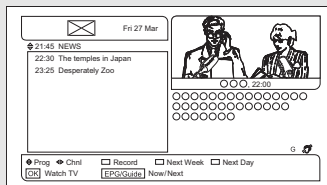

2 Select the programme, then press the red button.

- If on-screen instructions are displayed, follow them.

The timer programme is stored and "[R]" icon (Single timer recording) or "[S]" icon (Series timer recording*) is displayed.

- * Timer programme is set for all the episodes of a series programme.

To use TV Guide system

Refer to "Using TV Guide system". (⇒ 20)

To cancel a timer recording on the TV Guide screen

Select the programme in the TV Guide, then press the red button. If on-screen instructions are displayed, follow them.

("[R]" icon or "[S]" icon in the TV Guide disappears.)

To edit the timer programme

Refer to "To confirm and edit the timer programme". (⇒ 28)

Operation during Recording

Refer to "Operation during Recording". (⇒ 24)



- Some broadcast may not send programme information. When programme information is not displayed correctly, use manual timer recording. (⇒ 26)
- The receipt of the TV Guide data via Set Top Box is not possible.
- If the same episode has already been set for series timer recording at a different time or on another channel (Repeat programmes), "Series Timer Rec." will not be selectable.
- Timer recording using the TV Guide system will start 3 minutes before the set time and will also end 5 minutes after the set time. Those settings can be changed in "Timer Record Start Buffer" and "Timer Record Stop Buffer". (⇒ 71)
- Titles recorded using "Series Timer Rec." are bundled and displayed as a "group" in the DIRECT NAVIGATOR screen (⇒ 29).
- The series recording will be cancelled if there has been no episode of the series for 13 weeks.

Various functions with TV Guide

This unit has several functions that enable timer recordings to be controlled by the signal sent from the broadcaster.

Guide Link

The recording's start and stop times can be controlled by the broadcaster, e.g. delayed start.

- The "Guide Link" function may not work if you manually change the start time or the stop time over 10 minutes.

Series Timer Recording

You can record all the episodes of a series by setting just one timer recording.

Split Programme

You can record a programme separated into 2 or more parts by some other programmes, e.g. news.



- If the signal is not sent correctly, the recording may lack the beginning or the ending part of the programmes.

Timer recording

Manually programming timer recording

- 1 Press [PROG/CHECK].

- 2 Select "New Timer Programme", then press [OK].
- 3 Select the items and change the items. (⇒ right, Timer recording options)
- 4 Press [OK].
The timer programme is stored.

To confirm and edit the timer programme

Refer to "To confirm and edit the timer programme". (⇒ 28)

Operation during Recording

Refer to "Operation during Recording". (⇒ 24)



- When recording from the external equipment, "Mode" (recording mode) is XP, SP, LP, EP or FR.

Timer recording options

Select the items and change the items.

e.g.,

Channel

- You can select Category/AV with the red button.

Day/Date

- You can select "Date" or "Weekly" by pressing the green button.

Start/Stop

- Press and hold [▲, ▼] to alter in 15-minute increments.

Mode

Refer to page 7.

Renew

(Only daily/weekly timer recording)

The unit will record the new programme over the old one.

- 1 Select "Renew".
- 2 Select "ON".

Input Name



- 1 Select "Input Name", then press [OK].
- 2 Refer to "Entering text". (⇒ 81)



Timer recording from channel information

You can make timer programme for current or next programme.

- While watching a programme
Press [STATUS ].

e.g.,

1 ○○○○	10:30	All Digital Channels
NEWS		Select favourites <input type="checkbox"/>
09:00 - 11:00	< Now >	Set timer <input type="checkbox"/>
Rating: G	HE-AAC	  

- Display the channel information of a programme to record.
 - Switch the programme with [, ].
- Press the yellow button.
- Go to step 3 on page 26.

Notes on timer recording

- You can enter up to 32 programmes within a month in advance. (Each daily, weekly or series programme is counted as one programme.)
- Even if you switch the unit to standby mode during the timer recording, the recording is continued.
- When you programme successive timer recordings to start, last 1 minute of those programme will not be recorded.

Conditions when timer recording will not start

(-: Will not start, ○: Will start)

Executing operation	Starting of the timer recording
Recording the title* ¹	○
Playing the title	○
Editing the title	○
Copying a title in high speed mode (without finalising or creating Top Menu)* ²	○
Copying a title in high speed mode (with finalising or creating Top Menu)	-
Copying a title in normal speed mode	-
Converting a title in "DR File Conversion" (Only when "Now" is selected)	-
Copying HD Video (AVCHD format) from USB device or SD card	-
Executing "Flexible Recording via AV input"* ³	○
Executing PAUSE LIVE TV* ¹	○
Editing pictures	○
Copying pictures	-
Editing music	○
Copying music	-
Formatting	-
Finalising/Creating Top Menu	-

*¹ The operation will terminate when simultaneous recording is being done and timer recording starts.

*² Only one programme can be recorded.

*³ Executing operation will be terminated.

Timer recording

To confirm and edit the timer programme

1 Press [PROG/CHECK].

e.g.,

Icons (⇒ right)

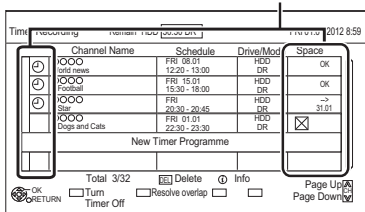

2 Select the programme, then perform the operations.

To deactivate a timer programme

Press the red button.

- The timer icon “⊖” will change from red to grey.
- Press the red button again to activate timer recording standby. (The timer icon “⊖” will change to red.)

To delete a timer programme

Press [DEL].

To edit a timer programme

- 1 Press [OK].
- 2 Change the timer recording options.
 - Refer to “Timer recording options”. (⇒ 26)
- 3 Press [OK].

To show programme information

Press [STATUS ⊕].

To exit the timer recording list

Press [EXIT].

Screen icons

Red: Timer recording standby is activated.



Grey: Timer recording standby is deactivated.



Currently recording programme.

A part or all of the programme will not be recorded since the programme is overlapping.

- Programme overlapping can be resolved with repeat programme if available.

- 1 Select the programme, then press the green button.



- 2 Follow the on-screen instructions.

Red: Delete programme

Green: Record Repeat programme

Yellow: Exit (Overlapping is not resolved)



- This function is not available for the timer programmes that were set manually.



The HDD is full.



Copy-protected programme, it was not recorded.



The recording of the programme was not completed because of some reason.



Auto Renewal Recording is set (⇒ 26).



Guide Link (⇒ 25)



Split Programme (⇒ 25)



Series Timer Recording (⇒ 25)



Displayed if the recording can fit in the remaining space.



Daily or weekly timer programme is set.



It may not be possible to record because:

- there is not enough space left.
- the number of possible titles has reached its maximum. (⇒ 94)
- programmes are deactivated, etc.

Playing titles on the HDD

 HDD

1 Press [DRIVE SELECT] to select “HDD”, then press [DIRECT NAVIGATOR].
e.g.,

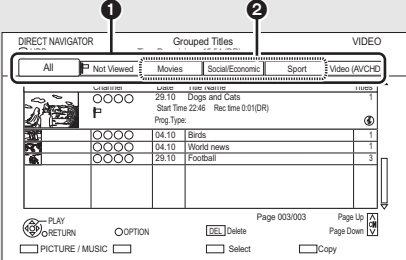

1 Tab (⇒ right)
2 Programme type

2 Select the title, then press [OK].
Playback starts.

Resume play function

If the following screen appears, select the point to start playback.

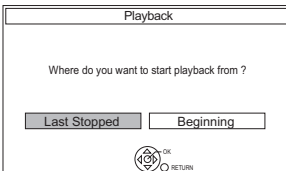



DIRECT NAVIGATOR (VIDEO) screen

Screen icons

-  Currently recording programme

-  Protected title

-  Title was not recorded due to recording protection

-  Title cannot be played (When data is damaged etc.)

-  Group titles

-  Title has not yet been played

-  Title is recorded using a different encoding system from that of the unit. Change the “TV System” (⇒ 66, 74).

-  Radio programme

-  Programmes which are copy-restricted by the broadcaster
 - Some restrictions will be imposed on “DR File Conversion” and DLNA function. (⇒ 38, 59)

-  Title is restricted by Child Lock (Parental Rating) (⇒ 69).

-  Recording did not complete as the timer recording has started.

Tab

Titles will be categorised automatically. You can quickly find the recorded titles by selecting the tab.

To select the tab

Press [◀, ▶].

To change the displayed programme type tab

- 1 Select the programme type, then press the green button.
- 2 Select the item, then press [OK].

To change the programme type of title

Refer to “Changing programme type of title”. (⇒ 37)

Playing titles on the HDD

Switching to the PICTURE or MUSIC screen

- 1 Press the red button.
- 2 Select "PICTURE" or "MUSIC", then press [OK].

Showing Information

Select the title, then press [STATUS ⓘ].

Switching the appearance

- 1 Press [OPTION].
- 2 Select "Grouped Titles" or "All Titles", then press [OK].

Grouped Titles:

Two or more titles recorded in the daily/weekly/series timer recording mode are bundled and displayed as one item.

All Titles:

Displays all titles.

Playing back grouped titles

- 1 On the Grouped Titles screen: Select the item marked with .
- 2 **All titles:** Press [PLAY/× 1.3 ▶].

Individual title:

Press [OK] and select the title, then press [OK].

Editing the grouped titles

- 1 Select the title or the group, then press the yellow button.
 - A check mark is displayed. Repeat this step.
 - Press the yellow button again to cancel.
 - If you perform "Remove", select the title in the group.
- 2 Press [OPTION].

- 3 Select the item, then press [OK].

Create Group:

Selected titles are bundled to form a group. Select "Create", then press [OK].

Release Grouping:

All the titles in the group are released. Select "Release", then press [OK].

Remove:

Selected titles are removed from the group. Select "Remove", then press [OK].

Changing the group name

- 1 Select the group, then press [OPTION].
- 2 Select "Edit", then press [OK].
- 3 Select "Enter Title Name", then press [OK].
- 4 Refer to "Entering text". (⇒ 81)

Playback from Chapter View

Regarding chapters

You can divide a title into multiple chapters. Each section between the division points (Chapter Marks) becomes a chapter.

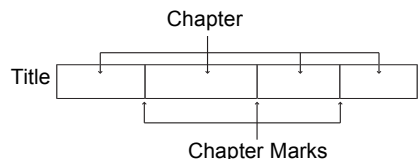

- 1 Select the title, then press [OPTION].
- 2 Select the "Chapter View", then press [OK].
e.g., **HDD**

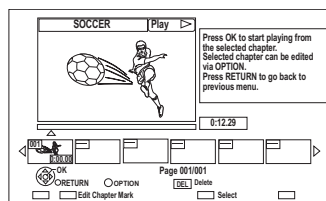

- 3 Select the chapter, then press [OK].

To edit the chapter in Chapter View

Refer to "Editing chapters". (⇒ 39)

Playing titles on the media



1 Insert the media.

Depending on the type of the media, play starts from the specified position, or the screen appears.

- AVCHD: If the menu screen is not displayed

Press [PLAY/×1.3 ▶].

2 When the DIRECT NAVIGATOR screen or menu screen etc., appears:

Select the item or title, then press [OK].

- Repeat this step if necessary.

Playback starts.

To play back the playlist created on other equipment

- 1 Press [FUNCTION MENU].
- 2 Select "Playlists" in "Others", then press [OK].
- 3 Select the playlist, then press [OK].



- Some DivX files may not be played back, depending on the video resolution and frame rate condition.

Menu screen

Selecting screen for each operation is displayed when the media is inserted, and you can access the operation screen easily.

e.g., **USB**

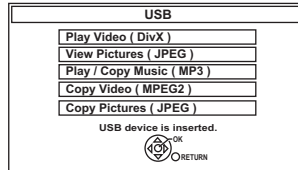

- Display items differ depending on what is recorded in each media.

If the menu screen is not displayed, display it by performing the following operation.

- 1 While Stopped
Press [OPTION].
- 2 Select "Drive Select", then press [OK].
- 3 Select the media, then press [OK].

Playing titles on the media

DIRECT NAVIGATOR screen

e.g.,

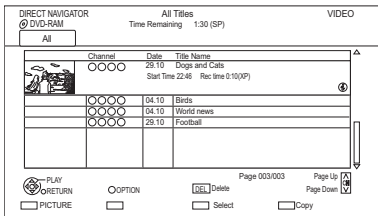

Switching to the PICTURE screen

Press the red button.

The screen switches from "VIDEO" to "PICTURE".

Showing Information

Select the title, then press [STATUS].

Playback from Chapter View

- 1 Select the title, then press [OPTION].
- 2 Select "Chapter View", then press [OK].
- 3 Select the chapter, then press [OK].

• Regarding chapters

Refer to "Playback from Chapter View". (⇒ 30)

DIRECT NAVIGATOR (AVCHD) screen

SD

e.g.,

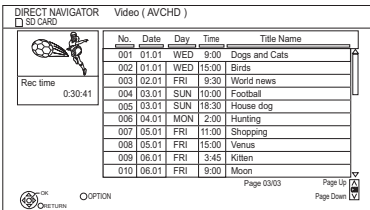

Showing Information

- 1 Select the title, then press [OPTION].
- 2 Select "Information", then press [OK].

Using the tree screen to find a folder

DivX

- 1 While the file list is displayed:
Press [OPTION].
- 2 Select "Select Folder", then press [OK].

e.g.,

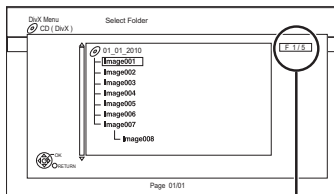

F: Selected folder no./Total folder no. including DivX title.

- 3 Select the folder, then press [OK].
The file list for the folder appears.

Operation during play



- Depending on the media and the type of file, some operations may not be possible.
- Depending on the media, it may take time for the menu screen, pictures, sound, etc. to start.
- Discs continue to rotate while menus are displayed. Press [STOP ■] when you have finished playback to protect the unit's motor, your TV screen and so on.

Status messages

Press [STATUS ⓘ] twice.

e.g.,

18:53:50 01.01.2012			
□Remain HDD 45:53 DR			
□T1	0:05.14	XP	□T2 0:10.10 DR
			▣T3 0:00.10 DR
			□0:30.00

Stop

Press [STOP ■].

Resume play function

Press [PLAY/× 1.3 ▶] to restart from the stopped position.

- The resume play function does not work depending on the disc.
- Stopped position

HDD:

Stopped position for each title is memorized.

Discs:

Only previous stopped position is memorized. The position is cleared if the tray is opened or the unit is switched to standby mode.

Quick View

Press and hold [PLAY/× 1.3 ▶].

- Play speed is quicker than normal.



- **DivX:** This function is not effective.
- **[DVD-RW]:** This function is not effective even if it is finalised.
- This function may not work when recording in XP or FR mode.

Search

Press [SLOW/SEARCH ◀◀] or [SLOW/SEARCH ▶▶].

- Press [PLAY/× 1.3 ▶] to restart play.



- The speed increases up to 5 steps.
([+R] [+RW] Up to 3 steps)
- **DivX:** Audio is not heard during all levels search.

Pause

Press [PAUSE ■■].

- Press [PLAY/× 1.3 ▶] to restart play.

Slow-motion

While paused, press [SLOW/SEARCH ◀◀] or [SLOW/SEARCH ▶▶].

- Press [PLAY/× 1.3 ▶] to restart play.



- The speed increases up to 5 steps.
- **DivX:** This function is not effective.
- **AVCHD (DVD-R SD):** Forward direction [SLOW/SEARCH ▶▶] only.

Frame-by-frame

While paused, press [◀] (◀■■) or [▶] (■■▶).

- Each press shows the next frame.
- Press and hold to change in succession forward or backward.
- Press [PLAY/× 1.3 ▶] to restart play.



- **DivX:** This function is not effective.
- **AVCHD (DVD-R SD):** Forward direction [▶] (■■▶) only.

Operation during play

Skipping the specified time

- 1 Press [TIME SLIP].
- 2 Select the time with [**▲**, **▼**].
 - Press and hold [**▲**, **▼**] to change the time by 10-minute.)
- 3 Press [OK].
 - Play skips the specified time.



- The minimum skipping interval is ± 10 minutes.
- **DVD-V**, **DivX** and **AVCHD**: This function is not effective.

To display Top Menu

DVD-V

- 1 Press [OPTION].
 - 2 Select "Top Menu", then press [OK].
- If the Top Menu is not displayed Press [DIRECT NAVIGATOR].

Skipping the title or chapter

During play or while paused, press [SKIP **◀◀**] or [SKIP **▶▶**].



- **HDD**: It will not skip the title. But the title in the grouped titles during the "All titles:" (\Rightarrow 30) will be skipped.

To create Chapter Marks

HDD **RAM**

During the playback or pause Press [CHAPTER].

To delete the Chapter Mark

HDD **RAM**

- 1 While paused Press [SKIP **◀◀**] or [SKIP **▶▶**] and skip to the location you want to delete.
- 2 Press [CHAPTER].
- 3 Select "Yes", then press [OK].

Changing audio

Press [AUDIO].

- It will switch depending on the contents recorded every time it is pressed.

Switching subtitles

HDD:

Press [STTL **⊕⊖**].

- If you want to switch the subtitle language, select it in the Disc menu (\Rightarrow 64).

DVD-V, **DivX**:

Display with "Subtitles" in the Disc menu (\Rightarrow 64).

Aspect

You can switch the screen mode.



Refer to "Switching the aspect ratio of the screen". (\Rightarrow 81)

Deleting recorded titles

Once deleted, recorded content cannot be restored to its original state. Make certain before proceeding.



- If the disc is protected, release the protection. (⇒ 60, Disc Protection)

- 1** On the DIRECT NAVIGATOR screen:
Select the title.

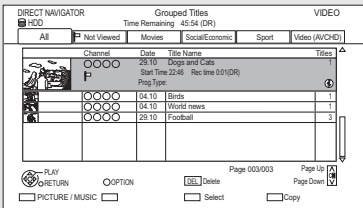

Channel	Date	Title Name	Titles
	29.10	Dogs and Cats	1
	04.10	Birds	1
	04.10	World news	1
	29.10	Football	3

- 2** Press [DEL].
- 3** Select “Delete”, then press [OK].

Multiple deleting

Select the title, then press the yellow button in step 1.

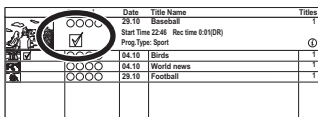

A check mark is displayed. Repeat this step.

- Press the yellow button again to cancel.

Deleting during play

- 1 Press [DEL] while playing.
- 2 Select “Delete”, then press [OK].

Available disc space after deleting

- **HDD** **RAM**
The space deleted becomes available for recording.
- **DVD-R** **+R**
Available space does not increase even after the contents are deleted.
- **DVD-RW** **+RW**
Available recording space increases only when the last recorded title is deleted.

Editing recorded titles

Once deleted, divided or partially deleted, recorded content cannot be restored to its original state. Make certain before proceeding.



- Depending on the media and the type of file, some operations may not be possible.
- PIN is required to edit the titles with **G** in some functions. (⇒ 29)

- On the DIRECT NAVIGATOR screen: Select the title.

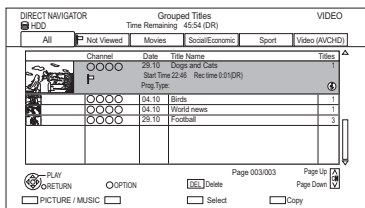

- Press [OPTION].

- Select the item, then press [OK].

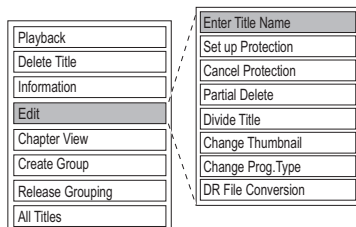

- “Edit” has several functions.

Multiple editing

Select the title, then press the yellow button in step 1.

A check mark is displayed. Repeat this step.

- Press the yellow button again to cancel.

Deleting

- Select “Delete Title”, then press [OK].
- Select “Delete”, then press [OK].

Entering title name

- Select “Enter Title Name” in “Edit”, then press [OK].
- Refer to “Entering text”. (⇒ 81)

Setting protection



Protection setting prevents the title from accidental deletion.

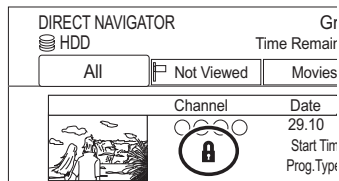

- Select “Set up Protection” or “Cancel Protection” in “Edit”, then press [OK].
- Select “Yes”, then press [OK].

appears when setting the protection.

Partial deleting

HDD **RAM**

- 1 Select "Partial Delete" in "Edit", then press [OK].
- 2 Press [OK] at the start point and end point to delete.
 - You can find the desired point by using play, search, etc. (⇒ 33)
- 3 Select "Continue", then press [OK].
 - Select "Next", then press [OK] to delete other sections. Up to 20 sections can be set. (⇒ go to step 2)
- 4 Select "Delete", then press [OK].
 - Chapter Mark is generated in the scene that was partially deleted.
- 5 Press [RETURN ☺].

Dividing title

HDD **RAM**

- 1 Select "Divide Title" in "Edit", then press [OK].
- 2 Press [OK] at the point to divide the title.
 - You can find the desired point by using play, search, etc. (⇒ 33)
- 3 Select "Continue", then press [OK].
- 4 Select "Divide", then press [OK].

To confirm the division point

After performing step 2.

Select "Preview", then press [OK].

- The unit plays 10 seconds before and after the division point.

To change the division point

After performing step 2.

Restart play and select "Divide", then press [OK] at the division point.



- **HDD** Divided titles become a group of titles.

Changing thumbnail

- 1 Select "Change Thumbnail" in "Edit", then press [OK].
- 2 Press [OK] at the point to use as a thumbnail.
 - You can find the desired point by using play, search, etc. (⇒ 33)
- 3 Select "Finish", then press [OK].

To change the point

After performing step 2.

Restart play and select "Change", then press [OK] at the point to change.



- It is possible to change the image displayed on the Top Menu after finalising or creating Top Menu.

Changing programme type of title

HDD

Programme type information in the title can be edited.

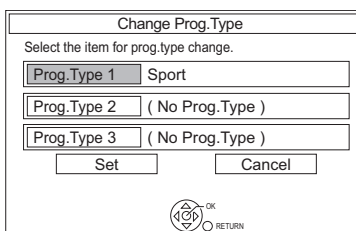

- 1 Select "Change Prog.Type" in "Edit", then press [OK].
- 2 Select the item to change a programme type, then press [OK].
- 3 Select the programme type, then press [OK].
- 4 Select "Set", then press [OK].

Editing recorded titles

DR File Conversion

HDD

DR File Conversion is a function to convert the recording mode of the title in DR mode. The size of the converted title will be small regularly. It will take about the same time as the recorded duration.

- 1 Select "DR File Conversion" in "Edit", then press [OK].
e.g.,

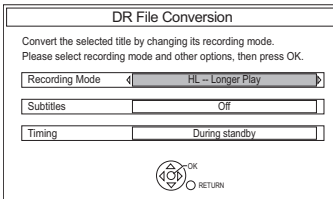

- 2 Set the conversion options, then press [OK].

Recording Mode:

(⇒ 7, Recording mode)

Subtitles:

- **Automatic**
Subtitles will be recorded if they are included in the title, and will not be recorded if they are not included.
- **Off**
Subtitle will not be recorded.

Timing:

- **Now**
Conversion begins immediately after step 4.
 - Timer recording will not be performed during conversion.
- **During standby**
Conversion will be performed after the unit is switched to standby mode.

- 3 Select the item, then press [OK].

Convert & Delete:

The original title will be deleted to save HDD capacity after conversion.

Convert Only:

The original title remains after conversion.

- When converting to HG, HX, HE, HL or HM mode, if the selected title is indicated with or , you cannot select "Convert Only". (⇒ 29)

- 4 "Now" conversion:

Select "Start", then press [OK].

"During standby" conversion:

Press [OK].

- Conversion will be performed after the unit is switched to standby mode.

"COP" on the unit's display remains lighted during conversion.

To cancel a "Now" conversion

Press and hold [RETURN] for more than 3 seconds.

To confirm whether the conversion is completed

Press [DIRECT NAVIGATOR].

e.g.,

Channel	Date	Title Name	Titles
DR → ○○	28.10	Days and C...	1
DR → ○○		Start Time 22:30 Rec 1 1:00 (DR→HL)	
DR → ○○		Prog Type Movies	
DR → ○○	04.10	Girls	1
DR → ○○	04.10	World news	1
DR → ○○	29.10	Football	1

When "DR → ○○ (Recording mode for conversion)" is displayed, the conversion has not finished.

To cancel a "During standby" conversion

After performing steps 1–3 (⇒ 36)

- 1 Select "DR File Conversion" in "Edit", then press [OK].
- 2 Select "Yes", then press [OK].



- To use "DR File Conversion", the HDD needs enough storage capacity.
- The size of converted title might increase depending on the title.
- DR File Conversion is stopped when this unit is turned on during performing "During standby" conversion. Conversion will start from the beginning again once the unit is switched to standby mode.
- When converted, the audio content and subtitle language will be selected according to the following settings:
 - "Multi Audio" of "Preferred Language" (⇒ 66, 69)
 - "Subtitles" of "Preferred Language" (⇒ 66, 69)
 - "Audio Type for XP Recording" (⇒ 66, 73)
 - "Audio Type for Digital Broadcast" (⇒ 66, 73)
 - "Audio for HG / HX / HE / HL / HM Recording" (⇒ 66, 73)
- In titles with the Auto Renewal Recording function (⇒ 26) set, a programme may be unintentionally converted while in "During standby".

Editing chapters

HDD **RAM**

- 1 Select "Chapter View", then press [OK].
- 2 Perform the editing operations.

Edit Chapter Mark:

Select the point where you want to start a new chapter while viewing the title.

- 1 Press the green button.
- 2 Press [OK] at the point you want to divide.
 - Repeat this step.
- 3 Press [RETURN ⊕] to go to Chapter View screen.

To delete the chapter:

- 1 Select the chapter, then press [DEL].

Multiple editing

Select the chapter, then press the yellow button.

A check mark is displayed. Repeat this step.

- Press the yellow button again to cancel.

- 2 Select "Delete", then press [OK].

To combine chapters (Delete chapter mark):

- 1 Select the chapter, then press [OPTION].
- 2 Select "Combine Chapters", then press [OK].
- 3 Select "Combine", then press [OK].
The selected chapter is combined to the next chapter.

Playback from Chapter View

Refer to "Playback from Chapter View". (⇒ 30)



- The maximum number of chapters:
(Depends on the state of recording.)
 - HDD**: Approx. 1000 per title
 - RAM**: Approx. 1000 per disc
- **HDD**: When the title has the maximum number of chapters, you cannot perform the Resume play function (⇒ 29) or the "Changing thumbnail" (⇒ 37) with the title.

Copying titles

If you want to copy recorded programmes at high speed, it is necessary that XP, SP, LP or EP mode should be selected for the programmes beforehand. (⇒ 38)

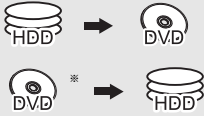

* **RAM +RW** only

1 Insert a disc.
The menu screen appears. (⇒ 31)

2 Select “Copy”, then press [OK].

3 Set the copy direction.

- 1 Select “Copy Direction”, then press [▶] (right).
- 2 Set “Source” and “Destination”.
- 3 Press [◀] to confirm.

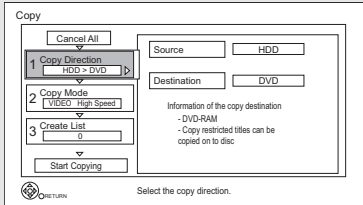

4 Set the recording mode.

- 1 Select “Copy Mode”, then press [▶] (right).
- 2 Set “Format” to “Video”.
- 3 Set “Recording Mode”.
- 4 Press [◀] to confirm.

5 Register titles for copy.

- 1 Select “Create List”, then press [▶] (right).
- 2 Select “New item”, then press [OK].
- 3 Select the title, then press the yellow button.

Repeat this step to select titles.

e.g., **HDD**

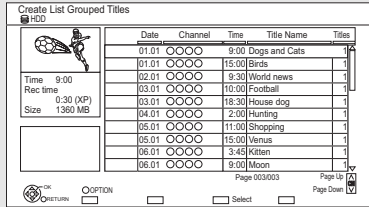

• To change the appearance of the list or show information of the title

- 1 Press [OPTION].
- 2 Select the item, then press [OK].

• The titles will be copied in the order of the copying list. If you want to specify the order, edit the copying list after the titles are selected. (⇒ 41, Editing the copying list)

4 Press [OK].

5 Press [◀].

Data size of each registered title

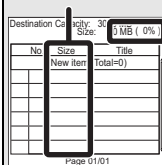

Size:
Data size recorded to the copy destination

6 Make other settings.

(⇒ 42, Setting the copying options)

7 Select “Start Copying”, then press [OK].

8 Select “Yes”, then press [OK] to start copying.

To cancel all registered copying setting and lists

After performing step 2

- 1 Select "Cancel All", then press [OK].
- 2 Select "Yes", then press [OK].

To copy HD Video (AVCHD format) to the DVD-R in High Definition

Refer to "Copying HD Video (AVCHD format) to the DVD-R in High Definition". (⇒ 45)



- If you wish to choose the audio language, select the language from "Multi Audio" of "Preferred Language" before copying (⇒ 66, 69).
- Titles in the grouped titles and other titles cannot be registered simultaneously.
- Following operations cannot be performed while copying in high speed mode without finalising or creating Top Menu.
 - playback of disc
 - playback of SD card
 - playback of USB memory
 - playback of picture recorded on HDD
 - playback of music recorded on HDD
- Simultaneous operation is not possible while copying in normal speed or copying in high speed mode with finalising or creating Top Menu.

Screen icons



Titles that cannot be copied in high speed mode to the inserted disc



Title contains picture(s)
• Picture(s) cannot be copied.



Title recorded using a different encoding system from that of the TV system currently selected on the unit.
• Titles displaying these marks cannot be selected.



Title is restricted by Child Lock (Parental Rating) (⇒ 69).

Editing the copying list

Select the item after step 5–4 (⇒ 40).

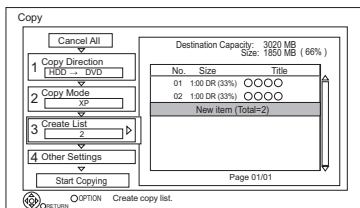

- 1 Press [OPTION].
- 2 Select the item, then press [OK].

Delete All:

All titles that you registered to copy are deleted.

Select "Yes", then press [OK].

Add:

Add new items to the copying list.

- 1 Select the titles with the yellow button.
- 2 Press [OK].

Delete:

- When deleting multiple titles on the copying list:

Select the title, then press the yellow button before step 1.

Repeat this step to select titles.

Select "Yes", then press [OK].

Move:

Move selected items or change the order of items on the copying list.

Select the destination, then press [OK].



- When copying at normal speed, the total data size will change according to the recording mode.
- The total data size shown may be larger than the sum of the data sizes for each registered item.

Copying titles

Setting the copying options

- 1 Select "Other Settings" in step 6 (⇒ 40), then press [▶] (right).
- 2 Select the copying option, then press [OK].

- **Subtitles**

- **Automatic:**

- Subtitles will be recorded if they are included in the title.



- If you wish to choose the subtitle, select the language from "Subtitles" of "Preferred Language" before copying (⇒ 66, 69).

- **Finalise**

- **On:**

- **DVD-R** **DVD-RW** **+R** The discs become play-only and you can also play them on other DVD equipment.

- **Create Top Menu**

- **On:**

- **+RW** You can play the disc on other DVD equipment.

- 3 Press [◀] to confirm.



- You can perform "Finalise" or "Create Top Menu" later. (⇒ 61)

Copying titles from DIRECT NAVIGATOR

HDD → **RAM** **DVD-R** **DVD-RW** **+R** **+RW**

RAM **+RW** → **HDD**



- 1 On the DIRECT NAVIGATOR screen: Select the title, then press the yellow button. A check mark is displayed. Repeat this step.
 - Press the yellow button again to cancel.
- 2 Press the blue button.
- 3 Select "Start Copying", then press [OK].
- 4 Select "Yes", then press [OK].

Notes for copying

Notes for high speed copy

High Speed Copying is the process of copying a title to disc in high speed while maintaining the original record mode and recording length. If any conversion is required during the copy process, the copying will be done at normal speed.

- The following recording mode and media combinations support high speed copying.

Original title's recording mode	Media
XP	
SP	
LP	
EP	
FR	

* DVD-RAM only

- Converting the recording mode will result in a normal speed copy.
- High speed copy is possible only when there is enough recording capacity on the destination media.



- It is impossible to copy at high speed in the following cases:

- HDD** → **DVD-R** **DVD-RW** **+R** **+RW** :
 - Copy including a title that was recorded to HDD with "Rec for High Speed Copy" set to "Off" (⇒ 71)
 - Titles that contain many deleted segments
 - Titles (SD Video) that have been copied to the HDD from an SD card or a Panasonic video camera, etc. (⇒ 58)
- HDD** → **+R** **+RW** :
 - Titles recorded in "EP" mode and "FR (recordings 5 hours or longer)" mode
 - Titles recorded in 16:9 aspect
- HDD** → **DVD-R** **DVD-RW** :
 - Titles recorded via AV input in 16:9 aspect using "EP" mode or "FR (recordings 5 hours or longer)" mode

Notes for normal speed copy

DVD-R **DVD-RW** **+R** **+RW**

- You cannot copy to the disc in the following cases.
 - When there is not enough free space on the HDD.
 - When the number of titles recorded to the HDD and the number of titles to be copied to the disc is greater than 999 in total.
- If copy is cancelled during the step while temporarily copying to the HDD, then nothing will be copied.
- Even if the title was not copied to the disc, the amount of remaining writable disc space becomes less.

Notes for copying to the DVD-RAM

When copying to DVD-RAM using "8 hours" mode, play may not be possible on DVD players that are compatible with DVD-RAM. Use "6 hours" mode if playback may be on other equipment. (⇒ 70, Recording time in EP mode)

About maintaining the chapter mark

- The position of the chapter might shift slightly.
- Maximum number of chapters on the disc is limited.
 - RAM** **DVD-R** **DVD-RW** : Approx. 1000
 - +R** **+RW** : Approx. 254
(Depends on the state of recording.)

Copying titles

Copying a finalised disc

DVD-V → HDD

While playing a disc, the content being played is copied to the HDD according to the set time.

- 1 Press [FUNCTION MENU].
- 2 Select "Copy (VIDEO / PICTURE)" in "Copy" then press [OK].
- 3 Set "Copy Mode".
 - 1 Select "Copy Mode", then press [▶] (right).
 - 2 Press [OK], then select the recording mode (XP/SP/LP/EP).
 - 3 Press [◀].
- 4 Set "Copy Time".
 - 1 Select "Copy Time", then press [▶] (right).
 - 2 Select "Time Setting", then press [OK].
 - 3 Select "On" or "Off".

On:
Set the copying time.

 - Set a few minutes longer than the source title, in order to include the operation time before play begins.

Off:
Copying all the content on the disc.
 - 4 Press [◀].
- 5 Select "Start Copying", then press [OK].

- 6 Select "Yes", then press [OK] to start copying.
 - When the top menu is displayed Select the title you want to start copying, then press [OK].

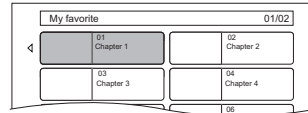

After the last title on the disc has finished playing the Top Menu is recorded until the set time is reached.

To stop copying

Press [STOP ■].

- You can also press and hold [RETURN ⊕] for 3 seconds.
- If stopped partway, copying will be up to that point.



- Operations and on-screen displays during copy are also recorded.
- Almost all DVD-Video on sale have been treated to prevent illegal copying, and cannot be copied.
- If play does not begin automatically press [PLAY/×1.3 ▶] to start.

Copying Title Playing

HDD → **RAM** **DVD-R** **DVD-RW** **+R** **+RW**

- 1** Play back the title to copy.
 - Multiple audio and subtitle displayed during playback will be copied.
 - Select the multiple audio with “Audio Selection” in the Disc menu (⇒ 64)
 - Select the subtitles with “Subtitles” in the Disc menu. (⇒ 64)
- 2** Press [OPTION].
- 3** Select “Copy Title Playing”, then press [OK].
- 4** Select “Start”, then press [OK].
Copying will start from the beginning of the title regardless of the playing position.

To stop copying

Press and hold [RETURN ☺] for 3 seconds.



- You can record to or play HDD while high speed copying. Press [OK] to disappear the screen display.
- Press [STATUS ⓘ] to confirm the current progress.

• Speed and recording mode when copying

The high speed copy is performed if available. Refer to “Notes for copying”. (⇒ 43)



- When copying the titles in DR, HG, HX, HE, HL or HM modes and the copy destination does not have enough space, one from HG, HX, HE, HL or HM modes will be selected to match the available space.
- **RAM** **DVD-R** **DVD-RW** **+R** **+RW** When copying the titles in DR, HG, HX, HE, HL or HM modes, copy will be performed at normal speed in FR mode.
- When copying the titles in XP, SP, LP, EP or FR modes and the copy destination does not have enough space, copy will be performed at normal speed in FR mode.

Copying HD Video (AVCHD format) to the DVD-R in High Definition

You can copy HD Video (AVCHD format) recorded on HDD to a DVD-R in High Definition quality.

HDD → **DVD-R**

- 1** Insert an unformatted DVD-R or DVD-R DL. The menu screen appears. (⇒ 31)
- 2** Select “Copy Video (AVCHD) to Disc”, then press [OK].
- 3** Go to step 5 on page 40.

To copy HD Video (AVCHD format) from other equipment

Refer to “Copying HD Video (AVCHD format)”. (⇒ 57)



- This function can only be used for unformatted disc.
- When a disc is named, formatting will be automatically performed. Therefore, do not name a disc before this operation. (⇒ 60, Disc Name)
- Discs will be automatically finalised after copy.
- You can choose the thumbnail image of the Top Menu before using this function. (⇒ 37, Changing thumbnail)
- The following HD Video (AVCHD format) cannot be copied to the disc in high definition.
 - Exceeding 18 Mbps
 - Without the AVCHD information (video recorded with certain non-Panasonic equipment, etc.)

Playing pictures



* **RAM** **DVD-R** only

1

HDD

- 1 Press **[FUNCTION MENU]**.
- 2 Select **"Picture"** in **"Playback Contents"**, then press **[OK]**.

RAM **DVD-R** **CD** **SD** **USB**

- 1 Insert the media.
The menu screen appears. (⇒ 31)
- 2 Select **"View Pictures (JPEG)"**, then press **[OK]**.

2

- 2 Select the date of **"Pictures by Date"** or album of **"Album View"**, then press **[OK]**.

e.g., **HDD**

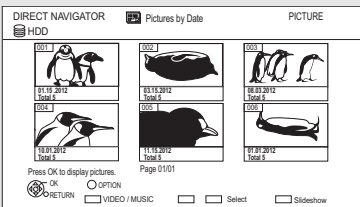

"Pictures by Date" screen

3

- 3 Select the picture, then press **[OK]**.
 - Press **[◀, ▶]** to display the previous or next picture.



- When there are many files and/or folders, some files may not be displayed or be playable. (⇒ 95)

Screen icons



Picture and Album protected.



Picture that has not yet been viewed (Pictures by Date screen)

Switching the DIRECT NAVIGATOR (PICTURE) appearance

HDD **RAM**

Pictures copied from SD cards and USB memories are grouped by the shooting date on Pictures by Date screen.

- 1 Press **[OPTION]**.
- 2 Select **"View Album"** or **"Pictures by Date"**, then press **[OK]**.
 - How to create an Album (⇒ 48, Copy the selected item to new Album)

Switching to the VIDEO or MUSIC screens

HDD

- 1 On the DIRECT NAVIGATOR screen: Press the red button.
- 2 Select **"VIDEO"** or **"MUSIC"**, then press **[OK]**.

RAM

On the DIRECT NAVIGATOR screen: Press the red button.

Show information

Information (shooting date etc.) is shown.

- 1 While displaying DIRECT NAVIGATOR (PICTURE): Press **[OPTION]**.
- 2 Select **"Information"**, then press **[OK]**.

Start Slideshow

You can display pictures one by one at a constant interval.

- 1** On the DIRECT NAVIGATOR screen:
Select a date or album.
- 2** Press the blue button.

Slideshow Settings

- 1** While displaying DIRECT NAVIGATOR (PICTURE):
Press [OPTION].
- 2** Select "Slideshow Settings", then press [OK].
- 3** After completing the settings, select "Set", then press [OK].

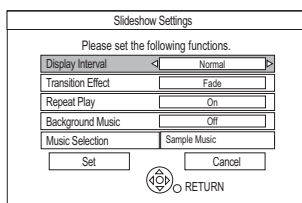

• Music Selection

You can select Background Music from HDD (Sample Music, My Favourites or Playlists) or USB memory.

To stop the slideshow

Press [RETURN ⊕].

Picture play option

- 1** While displaying a picture:
Press [OPTION].
- 2** Select the item, then press [OK].

Aspect

- You can switch the screen mode. (⇒ 81)

Rotate RIGHT, Rotate LEFT

e.g.,

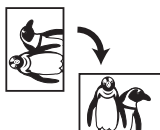

- The information of the rotated photos will not be stored depending on the media.

Zoom in, Zoom out

- This function is only available for small-sized pictures.

Editing pictures



* **RAM** only

1 On the DIRECT NAVIGATOR screen:

Editing an album or date:

Select the album or date.

e.g., **HDD**

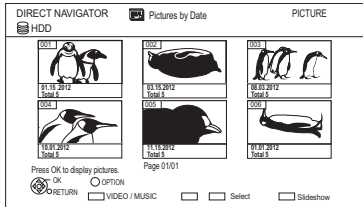

Editing a picture:

- 1 Select the item, then press [OK].
- 2 Select the pictures to edit.

• Multiple editing

Select the item, then press the yellow button. (Repeat this step.)

A check mark appears.

- Press the yellow button again to cancel.

2 Press [OPTION].

- Selectable items will change depending on the media and the type of file.

3 Select the item, then press [OK].

Copy to Album

HDD **RAM**

- 1 Select "Copy to Album" in "Copy", "Copy Album" or "Copy Pictures", then press [OK].
 - 2 Select "Start", then press [OK].
 - 3 Select the destination album, then press [OK].
- The destination album with protect setting cannot be copied to.

Copy the selected item to new Album

HDD **RAM**

Copy the selected item to new album.

- 1 Select "Copy to New Album" in "Copy", "Copy Album" or "Copy Pictures", then press [OK].
- 2 Select "Start", then press [OK].
- 3 Press [OK].
- 4 Select "Yes" or "No", then press [OK].

"Yes":

You can give names to albums.
(⇒ 81, Entering text)

"No":

Date of the first recorded picture becomes the album name automatically.

(For the pictures without shooting date, the renewed date will become the file name.)

- After copying, the screen shows the Album View screen automatically.

Copy to disc or HDD

HDD **RAM**

- 1 Select "Copy to DVD-RAM" or "Copy to HDD" in "Copy" or "Copy Album", then press [OK].
- 2 Select "Start", then press [OK].

Change the date of a folder

HDD **RAM**

(Pictures by Date only)

- 1 Select "Change Date", then press [OK].
 - 2 Select the item and change the date.
 - 3 Press [OK].
- A new folder will be created.
 - The original folder is not deleted. Delete it if unrequired.
 - If there is a same date folder, pictures move into the folder.
 - You can also change the date of a picture.

Enter Album Name

(Album View only)

- 1 Select "Enter Album Name" in "Edit Album", then press [OK].
- 2 Refer to "Entering text". (⇒ 81)

Album names input using this unit may not be displayed on other equipment.

Changing Protection

(Album View and Picture (JPEG) View only)

- 1 Select "Set up Protection" or "Cancel Protection" in "Edit Album" or "Edit Pictures", then press [OK].
- 2 Select "Yes", then press [OK].

 appears when the protection is set.

- Even if the protection is set, the album may be deleted by another unit.

Deleting

- 1 Select "Delete", "Delete Album" or "Delete Pictures", then press [OK].
- 2 Select "Delete", then press [OK].

Copying pictures

Copying automatically

SD → **HDD**

This unit saves information about imported pictures. Therefore, if pictures are imported from the same SD card, then only new pictures will be copied.

USB → **HDD**

All pictures in USB will be copied.

- 1 While stopped
Insert the SD card or the USB memory.
The menu screen appears. (⇒ 31)
- 2 Select "Copy Pictures (JPEG)", then press [OK].

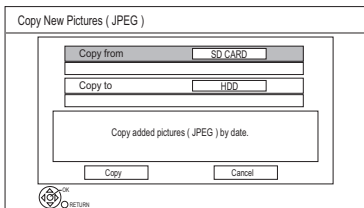

- 3 Select "Copy", then press [OK].
 - **SD** Even if protection of the card is set, copy will start.
 - **USB** Copy will start.
- 4 **SD**:
Select "Copy & Delete" or "Copy Only", then press [OK].
If "Copy & Delete" is selected, copied pictures in the SD card will be deleted after copying.

To stop copying

Press and hold [RETURN ⊕] for 3 seconds.



- Pictures without shooting date will be categorised using the creation date.
- If the space on the destination drive runs out or the number of files/folders to be copied exceeds the maximum (⇒ 95), copying will stop partway through.
- This unit saves the information on up to 12,000 pictures and 30 SD cards. If additional pictures are imported, the older information will be deleted.

Copying using the copying list

HDD ↔ **RAM** **SD**

SD ↔ **RAM**

USB → **HDD** **RAM**

- 1 While stopped
Press [FUNCTION MENU].
- 2 Select "Copy (VIDEO / PICTURE)" in "Copy", then press [OK].

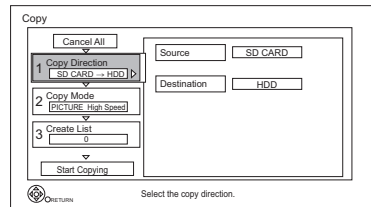

- 3 Set the copy direction.
 - 1 Select "Copy Direction", then press [▶] (right).
 - 2 Set "Source".
 - 3 Set "Destination".
 - 4 Press [◀] to confirm.
- 4 Set the copy mode.
 - 1 Select "Copy Mode", then press [▶] (right).
 - 2 Set "Format" to "PICTURE".
 - 3 Press [◀] to confirm.

- 5** Register pictures for copy.
- Pictures from different dates or albums will not be registered to same list.

- 1 Select "Create List", then press [▶] (right).
- 2 Select "New Item", then press [OK].

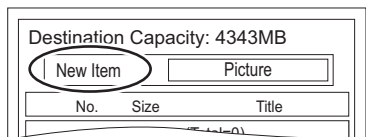

- 3 Select the item, then press [OK].
- 4 Select "New item", then press [OK].
- 5 Select the folder or picture.
 - To select another "Album" or "Date", press [OPTION] and select "Select Album" or "Select Date", then press [OK].
- 6 Press the yellow button.
 - A check mark is displayed. Repeat step 5 and 6 until you select all necessary items.
- 7 Press [OK].
- 8 Press [◀] to confirm.

- 6** Select "Start Copying", then press [OK].

- **HDD** → **RAM** **SD**
RAM → **HDD** **SD**

You can select another album as the copying destination when copied with "By Picture (Album)".



- 7** Select "Yes", then press [OK] to start copying.

To cancel all registered copying settings and lists

After performing steps 1–2 (⇒ 50)

- 1 Select "Cancel All", then press [OK].
- 2 Select "Yes", then press [OK].

To stop copying

Press and hold [RETURN ⊕] for 3 seconds.



- If the number of files/folders to be copied exceeds the maximum (⇒ 95), copying will stop partway through.

Editing the copying list

Select the item after step 5–7 (⇒ left)

- 1 Press [OPTION].
- 2 Select the operation, then press [OK].

Delete All

Select "Yes", then press [OK].

Add

- 1 Select the item, then press the yellow button.
 - A check mark is displayed. Repeat this step until you select all necessary items.
 - Press the yellow button again to cancel.
- 2 Press [OK].

Delete

Select "Yes", then press [OK].

• Multiple editing

Press the yellow button before step 1 (⇒ above).

A check mark is displayed. Repeat this step.

- Press the yellow button again to cancel.

Playing music



* **DVD-R** only

Music CD:

Insert the disc.

If connected to the network, the unit starts accessing the Gracenote® Database and searches for the information. (⇒ 15, 18)

- If search results indicate that multiple informations were found:
Select the appropriate information of the CD, then press [OK].

Playback will automatically start.

MP3:

1 Insert the media.

The menu screen appears. (⇒ 31)

- **DVD-R** **CD** Playback will automatically start if only MP3 is recorded.

2 Select “Play / Copy Music (MP3)”, then press [OK].

Playback will start.

- Using the tree screen to find a folder
 - 1 Press [OPTION].
 - 2 Select “Select Folder”, then press [OK].
 - 3 Select the folder, then press [OK].

To play other music (track)

Select the item, then press [OK].

e.g., **CD** (MP3)

DIRECT NAVIGATOR		Track List	
Ⓢ CD (MP3)		○○○○	
No.	Track Name		
0001		○○○○	
0002		○○○○	
0003		○○○○	
0004		○○○○	
0005		○○○○	



- The track/artist name will be displayed if the information is contained in ID3 tag of the MP3 file.
- If there is a large amount of picture data etc. within a MP3 file, play may not be possible.
- If there are music CDs with very similar information, then the incorrect information may be obtained. If no suggestions are found, enter the music CD information manually after recording to the HDD has completed.

Copying music to HDD

Music CD → **HDD**

DVD-R **CD** **USB** → **HDD** (MP3)

- 1 On the DIRECT NAVIGATOR screen of the disc or USB memory:
Press the blue button.
- 2 Select “Copy”, then press [OK].

To stop copying

Press and hold [RETURN ☺] for 3 seconds.



- While copying, no other operations can be performed.
Timer recordings will not proceed.
- Music CD: All tracks in the CD will be recorded.
- MP3: All tracks in the folder will be recorded.
- Tracks recorded to HDD in one operation will be regarded as one album.

Playing music recorded on HDD

HDD

- 1 Press [FUNCTION MENU].
- 2 Select "Music" in "Playback Contents", then press [OK].

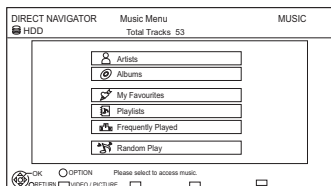

- 3 Select the item, then press [OK].

Artists

- 1 Select the initial of the artist.
- 2 Select the name of the artist, then press [OK].
- 3 Select the album, then press [OK].

Albums

- 1 Select the initial of the album.
- 2 Select the album, then press [OK].

My Favourites

Tracks registered in "My Favourites".

- Registering a track to the "My Favourites". (Up to 99 tracks)
- While the Track List screen is displayed:
Select the track, then press the green button.

Playlists

Select the playlist, then press [OK].

Frequently Played

- Tracks most often played recently (up to 30 tracks).

Random Play

Random playback of all tracks.

- 4 Select the track, then press [OK].

Switching to the VIDEO or PICTURE screens

- 1 On the DIRECT NAVIGATOR (Music Menu) screen:
Press the red button.
- 2 Select "VIDEO" or "PICTURE", then press [OK].

Showing Information

On the Track List screen:

- 1 Select the track, then press [OPTION].
- 2 Select "Information", then press [OK].

Playing music

Operations during music play

HDD **DVD-R** **CD** **USB**

Stop

Press [STOP ■].

Pause

Press [PAUSE ■■].

- Press [PLAY/× 1.3 ▶] to restart play.

Search

Press [SLOW/SEARCH ◀◀] or [SLOW/SEARCH ▶▶].

- Press [PLAY/× 1.3 ▶] to restart play.

Skip

During play or while paused, press [SKIP ◀◀] or [SKIP ▶▶].

Repeat Play/Random

Refer to “Repeat Play” or “Random” in Play menu (⇒ 64).

Sound Effects

Refer to “Sound Effects” in Sound menu (⇒ 65).

Displaying pictures (Slideshow)

Pictures stored on the “Album” of the HDD can be played back as slideshow during playback of the music.

While playing the music

Press the red button.

- To change the pictures to display
 - 1 While slideshow playing
Press [OPTION].
 - 2 Select “Select Picture Album”, then press [OK].
 - 3 Select the album, then press [OK].
e.g.,

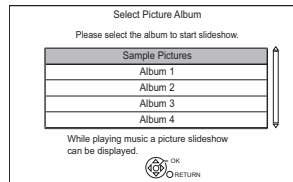

To end the slideshow

Press [RETURN ⊕].

How to create the picture album

Refer to “Copy the selected item to new Album”. (⇒ 48)

To play music continuously even if the Power off link works

Refer to “Playing music continuously even after turning off power to the TV”. (⇒ 62)

Editing music/playlist



- 1 On the DIRECT NAVIGATOR screen:
Press [OPTION].
e.g.,

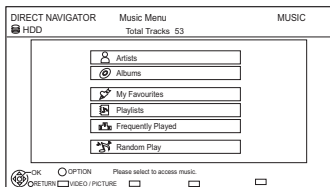

- Selectable items will change depending on the screen.

- 2 Select the item, then press [OK].
e.g., while selecting "Albums"

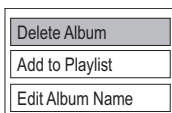

Delete All Tracks

- 1 If the confirmation screen appears:
Select "Yes", then press [OK].
- 2 Select "Delete", then press [OK].

Delete Album

Select "Delete", then press [OK].

Delete

Select "Delete", then press [OK].

Edit Album Name/Edit Track Name/Edit Artist Name/Edit Playlist Name

Refer to "Entering text". (⇒ 81)

Remove All Tracks

Select "Remove", then press [OK].

- Tracks themselves are not deleted from the HDD.

Clear My Favourites/Clear Frequently Played

Select "Clear", then press [OK].

- Tracks themselves are not deleted from the HDD.

Remove

Select "Remove", then press [OK].

- Tracks themselves are not deleted from the HDD.

Add to Playlist

You can register your favourite albums and tracks into 10 preset playlists.

Select the playlist, then press [OK].

- New playlist cannot be added.
- Up to 999 tracks can be registered to each playlist.

Recording from external equipment



Preparation

Connect the Set Top Box or video equipment (⇒ 14)

Manual Recording

HDD

Recording mode: XP, SP, LP, EP

- 1 Press [INPUT SELECT] and select "AV", then press [OK].
- 2 Press [REC MODE] to select the recording mode.
- 3 Select the channel on the Set Top Box or start play on the video equipment.
- 4 Press [● REC].
Recording starts.
- 5 Set the time to record. (⇒ 23)

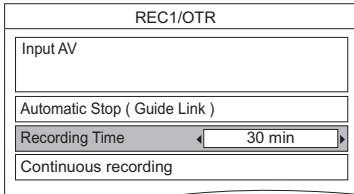

To stop recording

Press [STOP ■].



- Following operations cannot be performed while recording from external equipment.
 - playback of DivX and AVCHD file on the disc
 - playback of photo
 - playback of USB memory
 - playback of SD card

Flexible Recording via AV input

HDD **RAM** **DVD-R*** **DVD-RW** **+R*** **+RW**

* This function is not available with DVD-R DL and +R DL.

Recording mode: FR

- 1 Press [INPUT SELECT] and select "AV", then press [OK].
- 2 Press [FUNCTION MENU].
- 3 Select "Flexible Recording via AV input" in "Others", then press [OK].

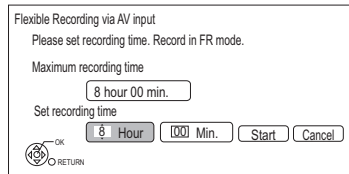

- 4 Set the recording time.
- 5 Start play on the other equipment.
- 6 Select "Start", then press [OK].

To stop recording partway

Press [STOP ■].

To show the remaining time

Press [STATUS ⓘ].



- Simultaneous operation is not possible while Flexible Recording via AV input to the disc is working.

Copy the HD Video or the SD Video



e.g., Connecting to the Panasonic video camera

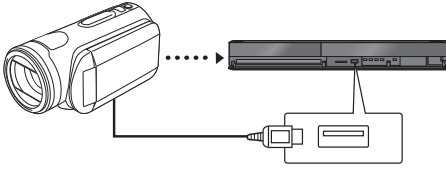

USB connection cable
(optional)



- If you connect a Panasonic product with a USB connection cable, setup screen may be displayed on the connected equipment. For details, refer to the instructions for the connected equipment.

Copying HD Video (AVCHD format)

RAM **DVD-R** **DVD-RW**

+R **+RW** **SD** **USB**, video camera, etc. → **HDD**

- Connect the video camera or insert the media.
 - Make the video camera ready for data transfer.

The menu screen appears. (⇒ 31)
- Select "Copy Video (AVCHD)", then press [OK].

- Select the title, then press the yellow button. A check mark is displayed. Repeat this step.

e.g., **SD**

Copy Video (AVCHD)		Destination Capacity	
<input type="checkbox"/> SD	⇒ <input checked="" type="checkbox"/> HDD		Size
		No.	Channel
Time	9:00	<input checked="" type="checkbox"/> 00	○○○○
Rec time	0:30	003	○○○○
Size	200 MB	004	○○○○
		—	—

- Press the yellow button again to cancel. (All the recordings on the same date become a title.)

- Press [OK].

- Select "Start", then press [OK].
 - It may take time for the copying to start.

To stop copying

Press and hold [RETURN ↵] for 3 seconds.

To copy the DVD-R in High Definition

Refer to "Copying HD Video (AVCHD format) to the DVD-R in High Definition". (⇒ 45)



- An AVCHD title with 100 or more scenes will be divided into titles every 99th scene and copied.

Screen icons

- N (NTSC)** Title recorded using a different encoding system from that of the unit.
- P (PAL)**
 - Titles displaying these marks cannot be selected.

Copy the HD Video or the SD Video

Copying SD Video (MPEG2 format)

SD **USB**, video camera, etc. → **HDD** **RAM**

- 1** Connect the video camera or insert the media.
 - Make the video camera ready for data transfer.The menu screen appears. (⇒ 31)
- 2** Select "Copy Video (MPEG2)", then press [OK].
 - To change the copy destination and the titles to copy (⇒ 40, Copying titles)
- 3** Select "Start Copying", then press [OK].
- 4** Select "Yes", then press [OK] to start copying.

To stop copying

Press and hold [RETURN 

DLNA functions

You can enjoy the video and pictures saved on the HDD of this unit on DLNA (Client) compatible equipment connected via a network.

- The titles with access restriction (e.g., copy restriction) signals sent from broadcasters are not available for this function.
- You cannot play back music from the playback equipment (Client).

e.g.,

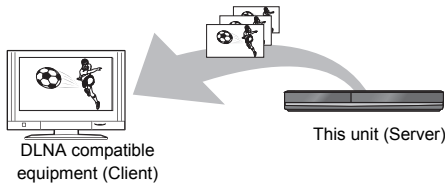

For details regarding the connection and operation of equipment connected via a network, refer to their respective operating instructions.

Preparation

- Network connection (⇒ 15)
- Perform Home Network settings of the DLNA compatible equipment.
- To activate the DLNA Server Function and to register the devices, make the following settings:
 - Named devices (⇒ 76)
 - Unnamed devices (⇒ 76)

Playing back from the equipment

- 1 Operate the playback equipment (Client) to display the list of titles on this unit.
 - Refer to their respective operating instructions.
- 2 Select the item, then press [OK]



- You cannot play back the titles on other DLNA compatible equipment from this unit.
- Some video cannot be played back depending on the equipment, the condition of this unit, or the file type.
- Ensure that the router for your home network has adequate security system to prevent unauthorized access.
- The DLNA compatible device that is to be connected to the unit should be connected to the same hub or broadband router as the unit.
- Files not on the HDD cannot be played back.
- Editing is not possible.

Disc and card management



- 1 Press [FUNCTION MENU].
- 2 Select "Others", then press [OK].
- 3 Select "DVD Management" or "Card Management", then press [OK].
 - Selectable items will change depending on the selected drive.

Disc Name

RAM **DVD-R** **DVD-RW** **+R** **+RW**

This function is to name a disc.
Refer to "Entering text". (⇒ 81)

- The disc name is displayed in the DVD Management window.
- **DVD-R** **DVD-RW** **+R** With a finalised disc, the name is displayed on the Top Menu.
- **+RW** The disc name is displayed only if you play the disc on other equipment after creating Top Menu.



- Do not perform this operation before copying HD Video (AVCHD format) to DVD-R or DVD-R DL. (⇒ 45)

Disc Protection

RAM

Select "Yes", then press [OK].

e.g.,



- To release the protection Repeat the same steps.
 - The screen icon will be switched to "Off".

Delete all titles

RAM

- 1 Select "Yes", then press [OK].
- 2 Select "Start", then press [OK].
A message appears when finished.
- 3 Press [OK].



- Picture data (JPEG) or computer data cannot be deleted.

Format Disc/Format Card

RAM **DVD-RW** **+RW** **SD**

+R (New disc only)

Formatting deletes all contents (including computer data), and they cannot be restored. Check carefully before proceeding.

- 1 Select "Yes", then press [OK].
- 2 Select "Start", then press [OK].
- 3 Press [OK].

RAM To stop formatting

Press [RETURN ⊞].

- You can cancel formatting if it takes more than 2 minutes. The disc must be reformatted if you do this.



- The contents are deleted when you format a disc or card even if you have set protection.
- **RAM** Formatting normally takes a few minutes; however, it may take up to a maximum of 70 minutes.
- **Do not disconnect the AC mains lead while formatting.** This can render the disc or the card unusable.
- When a disc or card has been formatted using this unit, it may not be possible to use it on any other equipment.
- It will become DVD Video format when a DVD-RW recorded in DVD Video Recording format is formatted with this unit.

Top Menu

DVD-R **DVD-RW** **+R** **+RW**

You can select the background for DVD-Video Top Menu.

Select the background, then press [OK].



- You can change thumbnails displayed in the Top Menu. (⇒ 37, Changing thumbnail)

Auto-Play Select

DVD-R **DVD-RW** **+R** **+RW**

You can select whether to show the Top Menu after finalising or creating Top Menu.

Select "Top Menu" or "Title 1", then press [OK].

Top Menu:

The Top Menu appears first.

Title 1:

The disc content is played without displaying the Top Menu.

Finalise

DVD-R **DVD-RW** **+R** (You can play the disc on compatible DVD players by finalising it on the unit.)

- 1 Select "Yes", then press [OK].
- 2 Select "Start", then press [OK].
- 3 Press [OK].

After finalising

- DVD-R** **+R** The disc becomes play-only and you can no longer record or edit.
- DVD-RW** You can record and edit the disc after formatting.



- You cannot cancel finalising.
- Finalising takes up to 15 minutes (Up to 60 minutes in case of DVD-R DL and +R DL).
- Do not disconnect the AC mains lead while finalising.** This can render the disc unusable.
- Depending on the disc, it may take longer than displayed on the confirmation screen (approximately four times longer).
- You cannot finalise discs recorded on other manufacturer's equipment.
- DVD-R** **DVD-RW** **+R** If you finalise discs recorded on Panasonic equipment other than this unit, the background selected as "Top Menu" may not be displayed.
- Discs finalised on this unit may not be playable on other players due to the condition of the recording.

Create Top Menu

+RW

You can create Top Menu for displaying on other equipment.

Make selections from "Top Menu" and "Auto-Play Select" before creating Top Menu.

- 1 Select "Yes", then press [OK].
- 2 Select "Start", then press [OK].
- 3 Press [OK].



- You cannot use the Top Menu for playing on this unit.
- The created menu is deleted when you record or edit the disc.

VIERA Link functions

What is VIERA Link "HDAVI Control"?

VIERA Link "HDAVI Control" is a convenient function which will link the operations of this unit and a Panasonic TV (VIERA) or an amplifier/receiver. You can use this function by connecting the equipment with the HDMI cable. See the operating instructions for connected equipment.

Download from TV

When you connect the unit to a TV for the first time, the setting information on the TV is acquired by this unit. (⇒ 17).

- This function is available with the TV that supports "HDAVI Control 3" or later.

- **Automatic input switching**
- **Power on link**

When the following operations are performed, the input channel of the TV will be automatically switched and the screen of this unit will be displayed. Additionally when the TV is off, the TV will automatically turn on.

- When play starts on this unit
- When an action that uses DIRECT NAVIGATOR or FUNCTION MENU etc, is performed

Power off link

When you set the TV to standby mode, the unit is also automatically set to standby mode.

- Power off link function does not work when recording, copying, finalising etc.

Playing music continuously even after turning off power to the TV

The following operations make it possible to keep the power of the unit on and to play music continuously.

When the unit is directly connected to an amplifier/receiver.

- 1 While playing music
Press [OPTION].
- 2 Select "TV Power Off", then press [OK].

- Sound may be discontinued for several seconds when the power to the TV is turned off.
- This function is available with the TV that supports "HDAVI Control 2" or later.

PAUSE LIVE TV

You can operate this unit with the TV remote control.

Refer to "PAUSE LIVE TV". (⇒ 22)

- This function is available with the TV that supports "HDAVI Control 3" or later.

Direct TV Recording

This function allows you to immediately start recording the programme that you are viewing on the TV.

Refer to the TV operating instructions for operation.

- This function is available with the TV that supports "HDAVI Control 3" or later.

Easy control only with VIERA remote control

You can operate this unit using the TV remote control.

Refer to the operating instructions of the TV about the buttons that you can use.

- This function is available with the TV that supports "HDAVI Control 2" or later.



- This unit supports "HDAVI Control 5" function. "HDAVI Control 5" is the newest standard (current as of November, 2011) for Panasonic HDAVI Control compatible equipment. This standard is compatible with Panasonic's conventional HDAVI equipment. Please refer to individual manuals for other manufacturers' equipment supporting VIERA Link function.
- VIERA Link "HDAVI Control", based on the control functions provided by HDMI which is an industry standard known as HDMI CEC (Consumer Electronics Control), is a unique function that we have developed and added. As such, its operation with other manufacturers' equipment that supports HDMI CEC cannot be guaranteed.
- These functions may not work normally depending on the equipment condition.
- Use the remote control supplied with this unit if you cannot operate this unit using buttons on the TV remote control.
- The operation of this unit may be interrupted when you press incompatible buttons on the TV remote control.

VIERA CAST (Enjoying Internet Service)

VIERA CAST allows you to access some specific websites supported by Panasonic, and enjoy Internet contents such as pictures, videos, etc. from VIERA CAST home screen. This unit has no full browser function and all features of websites may not be available.

e.g.,

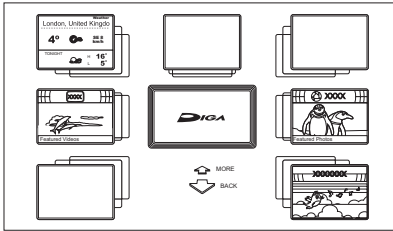

Images are for illustration purpose, contents may change without notice.

Preparation

- Network connection (⇒ 15)

- 1 Press [VIERA CAST].
 - The message is displayed. Please read these instructions carefully and then press [OK].
- 2 Select the item, then press [OK].
 - Operable buttons:
[▲, ▼, ◀, ▶], [OK], [RETURN ⊕], coloured buttons and number buttons.

To exit from VIERA CAST

Press [EXIT].



- When playing content from a disc, SD card or USB device VIERA CAST cannot be accessed.
- In the following cases, settings are possible using "Internet Content Settings" (⇒ 75)
 - When restricting the use of VIERA CAST.
 - When the audio is distorted.
- If using slow Internet connection, the video may not be displayed correctly. A high-speed Internet service with a speed of at least 6 Mbps is recommended.
- Be sure to update the software (firmware) when a software (firmware) update notice is displayed on the screen. If the software (firmware) is not updated, you will not be able to use the VIERA CAST function.
- The services through VIERA CAST are operated by their respective service providers, and service may be discontinued either temporarily or permanently without notice. Therefore, Panasonic will make no warranty for the content or the continuity of the services.
- All features of websites or content of the service may not be available.
- Some content may be inappropriate for some viewers.
- Some contents of VIERA CAST may only be available for specific countries and may be presented in specific languages.
- If timer recording starts, VIERA CAST will stop.

Playback menu

- 1** Press [DISPLAY].
e.g.,

Disc	Soundtrack	1 ENG	<input checked="" type="checkbox"/> Digital 2/0 ch
Play	Subtitles	Off	1 ENG
Picture	Angle		1
Sound			
Other			
Menu	Item	Setting	

- 2** Select the menu, then press [▶] (right).
3 Select the item, then press [▶] (right).
4 Select the setting.
 - Some items can be changed by pressing [OK].

Depending on the condition of the unit (playing, stopped, etc.) and media contents, there may be some items which cannot be selected or for which the effects do not work properly.

To clear the Playback menu

Press [DISPLAY].

Disc

Video

The original video recording method (MPEG-4 AVC etc.) appears.

Soundtrack*

Show or change the soundtrack.

Subtitles*

Turn the subtitle on/off, and change the language depending on the media.

Audio Selection

Switch in the case of multiple audio.

Subtitle Language

Select the subtitle language in the case of multiple languages.

Angle*

Change the number to select an angle.

Audio Channel

Change audio (LR/L/R) during playback.

* With some discs, you may only be able to make changes using the menus on the disc.

Play

Repeat Play

Select the item which you want to repeat.

Random

Select whether to play random or not.

Picture

Mode

Select the picture quality mode during play.

- **Normal**
Default setting
- **Soft**
Soft picture with fewer video artifacts
- **Fine**
Details are sharper
- **Cinema**
Mellows movies, enhances detail in dark scenes.

HD optimizer

This will compensate the mosaic noise in the video and haze around the characters precisely.

Detail Clarity

The picture becomes sharp and detailed.

Progressive

Select the method of conversion for progressive output to suit the type of title being played.

- **Auto**
Automatically detects the film and video content, and appropriately converts it.
- **Video**
Select this setting when the content is distorted if "Auto" is selected.

Film

Select this if the edges of the film content appear jagged or rough when "Auto" is selected.

However, if the video content is distorted as shown in the illustration to the right, then select "Auto".

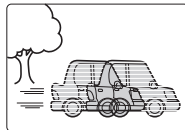

Sound

Sound Effects

- This function is effective when "Digital Audio Output" is set to "PCM". (⇒ 73)
- **Re-master 1/Re-master 2**
Sound becomes more natural by adding higher frequency signals not recorded on the track.

Dialogue Enhancer

The volume of the centre channel is raised to make dialogue easier to hear.

Other

Position

Change the position where this menu screen appears on your TV.

Audio attribute

LPCM/ Digital/

Digital+/
DTS/MPEG:

Signal type

k (kHz): Sampling frequency

b (bit): Number of bits

ch (channel): Number of channels

Language

ENG: English CHI: Chinese

FRA: French KOR: Korean

DEU: German MAL: Malay

ITA: Italian VIE: Vietnamese

ESP: Spanish THA: Thai

NLD: Dutch POL: Polish

SVE: Swedish CES: Czech

NOR: Norwegian SLK: Slovak

DAN: Danish HUN: Hungarian

POR: Portuguese FIN: Finnish

RUS: Russian *: Others

JPN: Japanese



- The menu is not displayed when playing pictures.

Changing the unit's settings

You can change the unit's settings of Digital TV Tuning, Sound, Display, Connection, Network etc. in the menu.

Common procedures

- 1** Press [FUNCTION MENU]. (⇒ 16)
- 2** Select "Setup" in "Others", then press [OK].

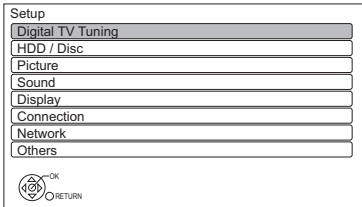

- 3** Select the menu, then press [OK].
- 4** Select the item, then press [OK].
- 5** Select the option, then press [OK].
 - Follow the instructions on the screen if further operations are necessary.
 - Depending on the connection or the status of this unit some items cannot be selected or changed.

Menu list

The locations of the setting items are as follows. For details on each setting item, please refer to the following pages.

Digital TV Tuning

- Favourites Edit (⇒ 68)
- Channel List (⇒ 68)
- Auto Setup (⇒ 68)
- Download from TV (⇒ 68)
- Manual Tuning (⇒ 69)
- Update Channel List (⇒ 69)
- Child Lock (Parental Rating) (⇒ 69)
- Signal Condition (⇒ 69)
- Preferred Language (⇒ 69)

HDD / Disc

- Settings for Playback (⇒ 70)
 - Soundtrack (⇒ 70)
 - Subtitles (⇒ 70)
 - Menu (⇒ 70)
 - DVD-Video Parental Control (⇒ 70)
- Settings for Recording (⇒ 70)
 - Recording time in EP mode (⇒ 70)
 - Aspect for Recording (⇒ 70)
 - Rec for High Speed Copy (⇒ 71)
 - DVD Speed for High Speed Copy (⇒ 71)
 - Timer Record Start Buffer (⇒ 71)
 - Timer Record Stop Buffer (⇒ 71)
- HDD Management (⇒ 71)
 - Delete all titles (⇒ 71)
 - Format HDD (⇒ 71)

Picture

- Still Mode (⇒ 72)
- Seamless Play (⇒ 72)
- NTSC Video Output (⇒ 72)

Sound

- Dynamic Range Compression (⇒ 72)
- Downmix (⇒ 72)
- Bilingual Audio Selection (⇒ 72)
- Digital Audio Output (⇒ 73)
 - PCM Down Conversion (⇒ 73)
 - Dolby Digital/Dolby Digital Plus (⇒ 73)
 - DTS (⇒ 73)
 - MPEG (⇒ 73)
- Audio Delay (⇒ 73)
- Audio Type for XP Recording (⇒ 73)
- Audio Type for Digital Broadcast (⇒ 73)
- Audio for HG / HX / HE / HL / HM Recording (⇒ 73)

Display

- On-Screen Information (⇒ 74)
- Unit's Display (⇒ 74)
- Screen Saver (⇒ 74)
- Teletext (⇒ 74)

Connection

- TV Aspect (⇒ 74)
- Aspect for 4:3 Video (⇒ 74)
- TV System (⇒ 74)
- HDMI Connection (⇒ 74)
 - HDMI Video Format (⇒ 74)
 - Deep Colour Output (⇒ 75)
 - HDMI Audio Output (⇒ 75)
 - Contents Type Flag (⇒ 75)
 - VIERA Link (⇒ 75)

Network

- Network Easy Settings (⇒ 75)
- Network Settings (⇒ 75)
 - IP Address / DNS Settings (⇒ 75)
 - Proxy Server Settings (⇒ 75)
 - Internet Content Settings (⇒ 75)
 - Lock (⇒ 75)
 - Automatic Volume Control (⇒ 75)
 - Named devices (⇒ 76)
 - Unnamed devices (⇒ 76)

Others

- Standby Settings (⇒ 77)
 - Power Save in Standby (⇒ 77)
 - Automatic Standby (⇒ 77)
 - Automatic Standby after OTR (⇒ 77)
 - Automatic Standby after Copy (⇒ 77)
- Remote Control (⇒ 77)
- Clock (⇒ 78)
- PIN Entry (⇒ 78)
- System Update (⇒ 78)
 - Software Update in Standby (⇒ 78)
 - Software Licence (⇒ 78)
- System Information (⇒ 78)
- DivX Registration (⇒ 78)
- Initialize (⇒ 78)
 - Shipping Condition (⇒ 78)
 - Default Settings (⇒ 78)

About the PIN

PIN is required to change the following settings. Enter the 4-digit PIN following the on-screen instructions.

- The PIN is common for the following items.
 - Child Lock (Parental Rating)
 - DVD-Video Parental Control
 - Lock (Internet Content Settings)

PIN can be changed via the “PIN Entry” in “Others”. (⇒ 78)

- 1 Select the number, then press [▶] (right).
 - You can also use the number buttons.
- 2 Repeat step 1 to enter 4-digit PIN.
- 3 Press [OK].
e.g., PIN Entry

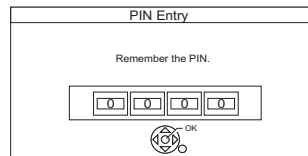

- Make a note of PIN in case you forget it.

Changing the unit's settings

Digital TV Tuning

Favourites Edit

You can create four Favourites of channels for making viewing and recording easier.

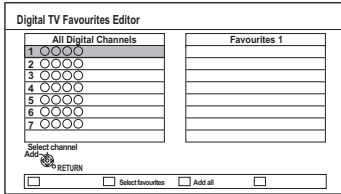

- To select the other Favourites list:
Press the green button.
- To add channels to the Favourites list:
Select the channel in the "All Digital Channels" column, then press [OK]. Repeat this step.
 - Yellow: Add all the available channels to the Favourites. (This function is available only when there are no channels in the "Favourites".)
- To change the order of the channels list:
 - 1 Select the channel in the "Favourites" column to move, then press the green button.
 - 2 Select the new position, then press the green button.
- To delete channels:
Select the channel in the "Favourites" column, then press [OK].
 - Yellow: Delete all channels.
- To change the name of the Favourites list:
 - 1 Press the red button in the "Favourites" column.
 - 2 Press [**▲**, **▼**, **◀**, **▶**] to select a character, then press [OK].
Repeat this step to enter other characters.
 - Red: Delete a character.
 - Blue: Delete all characters.
 - 3 Press [RETURN **⊙**].

Channel List

You can edit the Channel List.

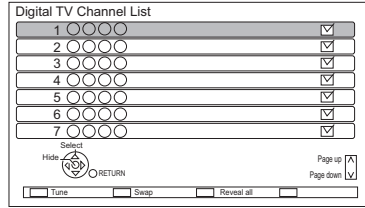

- To hide unwanted channels
 - 1 Select the channel.
 - 2 Press [OK].
The check mark is removed.
 - Yellow: Reveal all channels.
- To change the channel number assignment
 - 1 Select the channel, then press the green button.
 - 2 Enter the channel number to reassign with the number buttons.
 - 3 Press [OK].
 - If another channel is already assigned to the channel number, the two channels will be switched.
- To set the channel manually
 - 1 Press the red button.
 - 2 Refer to "Manual Tuning". (⇒ 69)

Auto Setup

You can restart the Auto Setup. (⇒ 17)
Select "Yes", then press [OK].

Download from TV

Select "Download from TV" when you connect the unit to a VIERA Link (HDAVI Control 3 or later) compatible TV with an HDMI cable.
Select "Yes", then press [OK].

Changing the unit's settings

HDD / Disc

Settings for Playback

Soundtrack

Select the audio language.

- If "Original" is selected, the original language of each disc will be selected.
- Enter a code with the number buttons when you select "Other ****".
(⇒ 79, Language code list)

Subtitles

Select the language for subtitle.

- If "Automatic" is selected and the language selected for "Soundtrack" is not available, subtitles of that language will automatically appear if available on that disc.
- Enter a code with the number buttons when you select "Other ****".
(⇒ 79, Language code list)

Menu

Select the language for disc menus.

- Enter a code with the number buttons when you select "Other ****".
(⇒ 79, Language code list)

DVD-Video Parental Control

Set a rating level to limit DVD-Video play.

- PIN is required to change. (⇒ 67)

Settings for Recording

Recording time in EP mode

Select the maximum number of hours for recording in EP mode (⇒ 96, Recording modes and approximate recording times).

Aspect for Recording

Sets the aspect ratio when recording or copying except in DR mode.

- If "Automatic" is selected, the title will be recorded with the original aspect ratio at the time when recording started (including when recording started at a commercial, etc.).
- In the following cases, the programme will be recorded with the original aspect ratio.
 - **HDD** **RAM** When the recording mode is set to "XP", "SP", "LP", "EP" or "FR" with the "Rec for High Speed Copy" set to "Off"
- In the following cases, aspect is fixed to 4:3.
 - **DVD-R** **DVD-RW** When the recording mode is set to "EP" or "FR (recordings 5 hours or longer)" mode.
 - When recording to a +R, +R DL and +RW.

Rec for High Speed Copy

You can copy titles to DVD in high speed mode, if you set to "On" before recording a programme.

- This setting is valid for the following cases:
 - DR File Conversion (⇒ 38)
 - Recording from external equipment
 - Copying from a finalised DVD-Video disc
- If "On" is selected, the following restrictions are applied to recorded titles.
 - The settings in "Aspect for Recording" (⇒ 70) and in "Bilingual Audio Selection" (⇒ 72) are applied to titles.
 - You cannot switch the audio when watching a programme via AV input.

DVD Speed for High Speed Copy

Select the speed of high-speed copying. If "Normal (Silent)" is selected, the time required for copying will be longer.

Timer Record Start Buffer

This function sets the timer recording to start earlier than the TV Guide time.

Timer Record Stop Buffer

This function sets the timer recording to stop later than the TV Guide time.

HDD Management

Press and hold [OK] for 3 seconds to show the following settings.

Delete all titles

Delete all titles (video) on the HDD.

- Delete does not work if one or more titles are protected.

Format HDD

Formatting deletes all contents, and they cannot be restored. Check carefully before proceeding.

Changing the unit's settings

Picture

Still Mode

Select the type of picture shown when you pause play.

- **Field:**
Select if jittering occurs when "Automatic" is selected. (The picture is coarser.)
- **Frame:**
Select if small text or fine patterns cannot be seen clearly when "Automatic" is selected. (The picture is clearer and finer.)

Seamless Play

The segments can be played back seamlessly.

- When "Off" is selected, frame-dropping between the segments can be avoided, but the video may freeze for a moment between the segments.
- Seamless Play function does not work depending on the condition or the kind of programme.

NTSC Video Output

(This works only for video output from the VIDEO OUT terminal.)

Select how to output the NTSC image.

Sound

Dynamic Range Compression

To lower the dynamic range for playback (e.g., at night).

- This does not work depending on broadcasts and recorded titles.

Downmix

Select the downmix system of multi-channel to 2-channels sound.

- Select "Surround encoded", when the connected equipment supports the virtual surround function.
- There is no effect on "Bitstream" via HDMI AV OUT and DIGITAL AUDIO OUT terminal.
- The audio will be output in "Stereo" in the following cases.
 - AVCHD playback

Bilingual Audio Selection

Select whether to record the audio type ("M1" or "M2") when:

- DR File Conversion (⇒ 38)
- Copying to a DVD-R, DVD-RW, +R and +RW.
- "Rec for High Speed Copy" is enabled. (⇒ 71)
- Recording sound in LPCM (⇒ 73, Audio Type for XP Recording).

Digital Audio Output

PCM Down Conversion

Select how to output audio with a sampling frequency of 96 kHz.

- On:
 - Signals are converted to 48 kHz.
(Choose when the connected equipment cannot process signals with a sampling frequency of 96 kHz.)
- Off:
 - Signals are output as 96 kHz
 - The signals will be converted to 48 kHz regardless of the setting in the following cases.
 - The signals have a sampling frequency of over 96 kHz.
 - The disc has copy protection.

Dolby Digital/Dolby Digital Plus

DTS

MPEG

Select the audio signal to output.

- Select "PCM" when the connected equipment cannot decode the respective audio format.
- Not making the proper settings may result in noise.

Audio Delay

Mis-sync between the video and audio is corrected by delaying the audio output.

Audio Type for XP Recording

Choose the audio type when recording or copying with XP mode.

- The picture quality of LPCM recordings may be lower than that of normal XP mode recordings.
- The audio recording becomes Dolby® Digital even if you selected LPCM when using a recording mode other than XP.

Audio Type for Digital Broadcast

If the programme has more than one track (Dolby® Digital, HE-AAC, etc.), you can set priorities.

- This setting will give effect in the following conditions.
 - The default setting when watching broadcasts.
 - The default setting when playing back the title recorded in DR mode.
 - DR File Conversion (⇒ 38)
 - Normal speed copy from the title recorded in DR mode. (⇒ 40)

Audio for HG / HX / HE / HL / HM Recording

If the programme has multi channel audio, priority is given to what you select.

- This setting will give effect in DR File Conversion (⇒ 38)

Changing the unit's settings

Display

On-Screen Information

Select the time until the channel information screen (⇒ 21) disappears automatically.

Unit's Display

Changes the brightness of the unit's display.

Screen Saver

This is to prevent burn-in on the screen.

Teletext

Select the Teletext (⇒ 22) display mode.

Connection

TV Aspect

Set to match the type of TV connected.

- Pan & Scan:

Side picture is trimmed for 16:9 picture.



The pictures may be shown in the letterbox style depending on the content.

- Letterbox:

Black bands appear for 16:9 picture.



Aspect for 4:3 Video

To play a 4:3 title, set how to show pictures on a 16:9 TV.

TV System

Set in accordance with the TV System for the connected TV.

HDMI Connection

HDMI Video Format

You can only select items compatible with the connected equipment.

- If "Automatic" is selected, the output resolution best suited to the connected TV (1080p, 1080i, 720p or 576p/480p) is automatically selected.
- To enjoy High Quality Video up-converted to 1080p, you need to connect the unit to 1080p compatible HDTV. If this unit is connected to an HDTV through other equipment, it must also be 1080p compatible.

Deep Colour Output

This setting is for selecting whether to use Deep Colour output when a TV that supports Deep Colour is connected.

HDMI Audio Output

Select "Off" when connected to a TV with an HDMI cable, and connected to an amplifier/receiver not compatible with HDMI with a DIGITAL AUDIO OUT terminal.

Contents Type Flag

If "Automatic" is selected, the optimal method of playback depending on the TV (e.g. cinema) will automatically be selected (only when the TV supports Contents Type Flag).

VIERA Link

Select "Off" when you do not want to use "HDAVI Control".

Network

Network Easy Settings

Press [OK] to start Network Easy Settings.
(⇒ 18)

Network Settings

IP Address / DNS Settings

Check the connection of the network or set the IP address and DNS.

- Press [OK] to show the respective setting.
- If you set "IP Address", "Subnet Mask" and "Gateway Address" individually, make their settings after setting "IP Address Auto-assignment" to "Off".

When the router's DHCP server function is not activated, check the numbers of other connected devices such as personal computers, then assign a number different from those of other devices for the "IP Address" and assign the same number for "Subnet Mask" and "Gateway Address".

Proxy Server Settings

Check and set the connection to the Proxy server.

- Press [OK] to show the respective setting.

Internet Content Settings

Lock

You can restrict using VIERA CAST.

- PIN is required to change. (⇒ 67)

Automatic Volume Control

Volume is adjusted automatically to the standard volume while using VIERA CAST.

- Depending on contents, this function will not work.
- Select "Off" when the audio is warped.

Changing the unit's settings

Named devices

You will be able to access this unit from Panasonic DLNA compatible equipment on the network by registering them to this unit. (⇒ 59)

It is also possible to change the name of this unit on the network.

- To register the equipment

- 1 Select "Home Network (DLNA)", then press [OK].
 - 2 Select "On", then press [OK].
 - 3 Select "Yes", then press [OK].
 - 4 Access this unit from the connected DLNA compatible equipment within 10 minutes.
 - Up to 4 devices can be registered.
- If you cannot register Panasonic equipment, use "Unnamed devices". (⇒ right)

Unnamed devices

By allowing access from non-Panasonic DLNA compatible equipment on the network, it allows them to access this unit. (⇒ 59)

- To register non-Panasonic equipment

- 1 Select "Server (DLNA) function", then press [OK].
- 2 Select "On", then press [OK].
- 3 Select the MAC Address for the connected equipment, then press [OK].
 - Up to 12 devices can display the MAC Address.
 - Up to 4 devices can be registered.
- 4 Select "Yes", then press [OK].

Others

Standby Settings

Power Save in Standby

- On:

It will go into the "Power Save in Standby" mode.
- On Timer:

"Power Save in Standby" is activated when the set time comes.

 - If the clock has not been set, "Power Save in Standby" is activated at all hours.
- Off:

It is possible to start quickly from the standby mode. (Quick Start mode)



- This function cannot be enabled when the DLNA function is enabled in "Named devices" or "Unnamed devices". (⇒ 76)

Automatic Standby

Set the time to turn the unit to standby mode automatically.

When the unit is not operating, the unit will be turned to standby mode once the set time has passed.

Automatic Standby after OTR

- On:

This unit is turned to standby mode when it is not operated for approximately 5 minutes after completing "Automatic Stop" or "Recording Time" (⇒ 23).

Automatic Standby after Copy

- On:

This unit is turned to standby mode when it is not operated for approximately 5 minutes after completing copy (⇒ 40, Copying titles).

Remote Control

Change the remote control code on the main unit and the remote control if you place other Panasonic products close together.

- Use "DVD 1", the factory set code, under normal circumstances.
 - 1 Select the code, then press [OK].
 - 2 While pressing [OK], press and hold the number button ([1] to [6]) for more than 5 seconds.
 - 3 Press and hold [OK] for more than 5 seconds.
 - 4 Press [OK].
- Operation is possible only with Panasonic remote controls with "IR6" printed at the bottom when the remote control code of this unit is set to "DVD 4", "DVD 5" or "DVD 6".

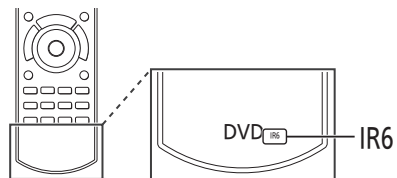

Changing the unit's settings

Clock

If the time is not set correctly, use the settings listed in the method below.

- Automatic
This unit usually obtains time and date information from digital broadcasts.
- Daylight Saving Time
Select time offset from the standard time for Summer Time.
 - If there is a gap between displayed time and actual time, set this function.
- Manual Setting
 - 1 Select "Off" of "Automatic", then press [OK].
 - 2 Select the item you want to change.
 - 3 Change the setting.
 - 4 Press [OK] when you have finished the settings.

PIN Entry

You can set/change the PIN. (⇒ 67)

System Update

Software Update in Standby

When you set this unit to standby mode, software (firmware) updates (⇒ 80) are downloaded automatically at the time you have specified.

Software Licence

Information about the software licence is displayed.

System Information

Display software (firmware) version of this unit.

DivX Registration

You need this registration code to purchase and play DivX Video-on-Demand (VOD) content.

- After playing DivX VOD content for the first time, the registration code is not displayed.
- If you purchase DivX VOD content using a registration code different from this unit's code, you will not be able to play this content.
- To cancel the unit's registration
Select "Yes".

Use the deregistration code to cancel the registration in www.divx.com.

Initialize

Shipping Condition

All the settings except for basic settings return to the factory preset. The timer recording programmes are also cancelled.

Default Settings

All the settings other than the tuning settings, clock settings, disc language settings, rating PIN, remote control code, etc. return to the factory presets.

Language code list

Abkhazian:	6566	Lingala:	7678
Afar:	6565	Lithuanian:	7684
Afrikaans:	6570	Macedonian:	7775
Albanian:	8381	Malagasy:	7771
Amharic:	6577	Malay:	7783
Arabic:	6582	Malayalam:	7776
Armenian:	7289	Maltese:	7784
Assamese:	6583	Maori:	7773
Aymara:	6589	Marathi:	7782
Azerbaijani:	6590	Moldavian:	7779
Bashkir:	6665	Mongolian:	7778
Basque:	6985	Nauru:	7865
Bengali; Bangla:	6678	Nepali:	7869
Bhutani:	6890	Norwegian:	7879
Bihari:	6672	Oriya:	7982
Breton:	6682	Pashto, Pushto:	8083
Bulgarian:	6671	Persian:	7065
Burmese:	7789	Polish:	8076
Byelorussian:	6669	Portuguese:	8084
Cambodian:	7577	Punjabi:	8065
Catalan:	6765	Quechua:	8185
Chinese:	9072	Rhaeto-Romance:	8277
Corsican:	6779	Romanian:	8279
Croatian:	7282	Russian:	8285
Czech:	6783	Samoan:	8377
Danish:	6865	Sanskrit:	8365
Dutch:	7876	Scots Gaelic:	7168
English:	6978	Serbian:	8382
Esperanto:	6979	Serbo-Croatian:	8372
Estonian:	6984	Shona:	8378
Faroese:	7079	Sindhi:	8368
Fiji:	7074	Singhalese:	8373
Finnish:	7073	Slovak:	8375
French:	7082	Slovenian:	8376
Frisian:	7089	Somali:	8379
Galician:	7176	Spanish:	6983
Georgian:	7565	Sundanese:	8385
German:	6869	Swahili:	8387
Greek:	6976	Swedish:	8386
Greenlandic:	7576	Tagalog:	8476
Guarani:	7178	Tajik:	8471
Gujarati:	7185	Tamil:	8465
Hausa:	7265	Tatar:	8484
Hebrew:	7387	Telugu:	8469
Hindi:	7273	Thai:	8472
Hungarian:	7285	Tibetan:	6679
Icelandic:	7383	Tigrinya:	8473
Indonesian:	7378	Tonga:	8479
Interlingua:	7365	Turkish:	8482
Irish:	7165	Turkmen:	8475
Italian:	7384	Twi:	8487
Japanese:	7465	Ukrainian:	8575
Javanese:	7487	Urdu:	8582
Kannada:	7578	Uzbek:	8590
Kashmiri:	7583	Vietnamese:	8673
Kazakh:	7575	Volapük:	8679
Kirghiz:	7589	Welsh:	6789
Korean:	7579	Wolof:	8779
Kurdish:	7585	Xhosa:	8872
Laotian:	7679	Yiddish:	7473
Latin:	7665	Yoruba:	8979
Latvian, Lettish:	7686	Zulu:	9085

Software (Firmware) Update

You cannot operate the unit until the update is complete. Don't remove the AC mains lead during the update. Removing the AC mains lead while the update is in progress may damage the unit.

Software of this unit can be updated automatically by following method in standby mode at the specified time.
(Default setting is 3 a.m. ⇒ 78, Software Update in Standby)

- From broadcasts
- From Internet*
- * Network connection and setting are required. (⇒ 15, 18)

If a software (firmware) update is available, a notification is displayed.

New software version has been found.
The software will be updated automatically after this unit is switched to standby.
Do not disconnect the AC mains lead.

- It is displayed on the channel information (⇒ 21) when the software (Firmware) can be updated immediately.

e.g.,

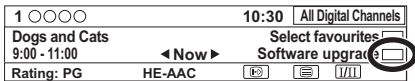

To execute, push the red button while the channel information is displayed, and follow the instructions on the screen.

Update of the software (firmware) will start when the unit is turned to standby mode.

The unit's display during the update

e.g.,

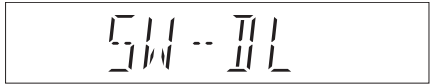

- When "FINISH" is displayed, update of the software (firmware) has completed.



- It may take up to a few hours until the update is completed depending on the network or broadcast environment.
- The timer recording always takes preference over the software (Firmware) download; if the timer recording is scheduled to start, the downloading will be performed at the next opportunity.
- You can also download the latest software (firmware) from the following website.
<http://panasonic.jp/support/global/cs/>

Other Operations

Entering text

Preparation

- Show the "Enter Title Name" screen, etc.

- 1 Select a character, then press [OK].
Repeat this step to enter other characters.

e.g.,

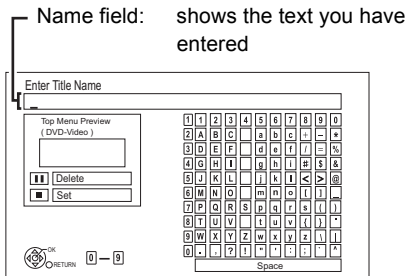

- To delete a character:
Select the character in the name field, then press [PAUSE ■■].
- To enter characters with number buttons:
e.g., entering the letter "R"

- 1 Press [7] to move to the seventh row.
- 2 Press [7] twice to highlight "R".
- 3 Press [OK].

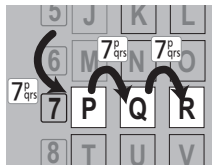

- 2 Press [STOP ■] (Set).
"Writing..." appears then the screen returns to the previous screen and so on.

To end partway

Press [RETURN ☺]. (Text is not added.)



- The maximum number of characters depends on the media.
- If a name is long, parts of it may not be shown in some screens.

Switching the aspect ratio of the screen

When the image does not match the screen size of the TV, you can enlarge the image to fill the screen.

- 1 Press [OPTION].
- 2 Select "Aspect", then press [OK].
- 3 Select the item, then press [OK].

Normal:

Normal output

Side cut:

The black bars on the right and left sides of the 16:9 image disappear and the image is enlarged.

Zoom:

The black bars on the top and bottom sides of the 4:3 image disappear and the image is enlarged.



- It may also be adjusted using the screen mode of the TV etc.
- The screen mode is switched to "Normal" in the following situations:
 - when you change the channel
 - when you start or end the playback of a title
 - when you switch the unit on or to standby mode.
- [DVD-V] "Side cut" does not have any effect.
- When "TV Aspect" (⇒ 74) is set to "Pan & Scan" or "Letterbox", the "Zoom" effect is disabled.

HOLD function

The HOLD function deactivates all buttons on the unit and remote control.

Press and hold [OK] and [RETURN ☺] simultaneously until "X HOLD" appears on the unit's display.

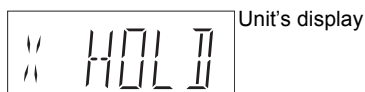

To cancel the HOLD function

Press and hold [OK] and [RETURN ☺] simultaneously until "X HOLD" disappears.

Troubleshooting guide

Before requesting service, make the following checks. If the problem still persists, consult your dealer for instructions.

Updating to the latest software (firmware) may solve the problem. (⇒ 80)

The following do not indicate a problem with this unit:

- Regular disc rotating sounds or HDD rotating sounds.
- Poor reception due to atmospheric conditions.
- Image disturbance during search.
- Interruptions in reception due to periodic broadcasting breaks.
- When you switch the unit on or to standby mode, there may be an unexpected sound.

General operation

The unit doesn't work.

- Check the connections. (⇒ 13)
- One of the unit's safety devices may have been activated.

Reset the unit as follows:

- 1 Press [⏻/⏪] on the main unit to switch the unit to standby.
 - If the unit doesn't switch to standby, press [⏻/⏪] on the main unit for about 3 seconds. The unit is forcibly switched to standby. Alternatively, disconnect the AC mains lead, wait one minute, then reconnect it.
- 2 Press [⏻/⏪] on the main unit to switch it on. If the unit still cannot be operated, consult the dealer.

Cannot eject disc.

The unit may have a problem. While the unit is in standby mode, press and hold [STOP ■] and [CH ^] on the main unit at the same time for about 5 seconds.

The unit is switched to standby mode automatically.

- VIERA Link has worked. (⇒ 62, Power off link)

The remote control doesn't work.

- The remote control and main unit are using different codes. Change the code on the remote control.



Unit's display

Press and hold [OK] and the indicated number button at the same time for more than 5 seconds. (⇒ 77)

- Software (firmware) is updating when "UPD □/□" is displaying on the unit's display. Wait until the update is completed. (⇒ 80)
- The HOLD function is activated. (⇒ 81)

Startup is slow.

- Startup takes time in the following situations:
 - A disc is inserted.
 - The clock is not set.
 - Immediately after a power failure or the AC mains lead is connected.
 - When the "Power Save in Standby" is activated. (⇒ 77)

Displays

"0:00" is flashing on the unit's display.

- Set the clock. (⇒ 78)

The clock does not display on the unit when switched to standby.

- The clock does not display when "Power Save in Standby" is activated. (⇒ 77)

TV screen and video

Screen size is wrong.

- Check the "TV Aspect" or "Aspect for 4:3 Video". (⇒ 74)
- Adjust the aspect ratio setting on TV.
- If you connect to 4:3 TV, set "HDMI Video Format" to "576p/480p". (⇒ 66, 74)
- Check "Aspect for Recording" before recording or file conversion. (⇒ 66, 70)

The black screen appears on the TV.

- This phenomenon may occur, depending on the TV setting, when "Power Save in Standby" is set to "Off". Depending on the TV, this phenomenon may be prevented by reconnecting to a different HDMI input terminal.

Picture does not appear with the HD quality although HD setting was made.

- The pictures are output with 576p/480p depending on the title.

Troubleshooting guide

The screen changes automatically.

- If "Screen Saver" set to "On", the screen saver function will be activated when there is no operation for 5 minutes or more. (⇒ 74)

There is a lot of image lag when playing video.

- Set "HD optimizer" in the Picture menu to "Off". (⇒ 65)
- Set "Audio Delay". (⇒ 66, 73)

The images do not appear on the TV.

The picture is distorted during play, or video will not play correctly.

- Check the connections. (⇒ 13)
- Check the settings of the connected TV, etc.
- The unit's TV System is different from that of the disc. While stopped, keep pressing [STOP ■] and [▲ OPEN/CLOSE] on the main unit for 5 or more seconds. The system switches from PAL to NTSC or vice versa.
- Picture may not be seen when more than 4 devices are connected with HDMI cables. Reduce the number of connected devices.
- The picture may be distorted or a black screen may appear between scenes recorded with different aspect ratios.
- Set "Deep Colour Output" (⇒ 66, 75) or "Contents Type Flag" (⇒ 66, 75) to "Off".

Sound

No sound.

Distorted sound.

- Check the connections. (⇒ 13)
- Check the settings of the connected TV, etc.
- Press [AUDIO] to select the audio. (⇒ 34)
- To output audio from a device connected with an HDMI cable, set "HDMI Audio Output" to "On". (⇒ 66, 75)

Cannot change audio channel.

- You cannot switch the audio channel if "Digital Audio Output" is set to "Bitstream". (⇒ 73)

Recording, timer recording and copying

Cannot record.

Cannot copy.

- Some broadcasts are copyright protected.
- You cannot record to the disc by pressing the [● REC] or timer recording.
- The disc is protected. (⇒ 8, 60)
- **DVD-R** **DVD-RW** **+R** **+RW** Since it will copy to HDD temporarily, copying is not possible if there is insufficient available capacity on the HDD.
- **DVD-R** **DVD-RW** **+R** **+RW** Copying or editing may not be possible on these discs after ejecting and loading the disc or switching the unit on or to standby mode for approximately 30 times after being recorded to.
- This unit cannot record/copy NTSC signals to discs that already have PAL signal recordings.

Auto Renewal Recording does not work properly.

- The programme will not be overwritten in the following cases:
 - the programme is protected
 - any programme is being played back or copied
 - a screen such as DIRECT NAVIGATOR is displayed

Instead, the programme will be saved as a separate programme and that will be overwritten.

A part or whole of a recorded title has been lost.

- If there is a power failure or the AC mains lead is disconnected from the household mains socket while recording or editing, the title may be lost or the HDD may become unusable. We cannot offer any guarantee regarding lost programmes.

An unusually loud sound is coming from the rotating disc.

- If you want copy to perform more quietly, select "Normal (Silent)" in "DVD Speed for High Speed Copy". (⇒ 66, 71)

The time recorded on the disc and the available time shown do not add up.

- **DVD-R** **+R** If you record or edit many times, the remaining capacity is reduced and then recording or editing may be disabled.
- Available disc space display may be different from actual.

Play

Cannot playback.

- The disc is dirty. (⇒ 9)
- The disc is scratched or marked.
- The disc may not be able to play back if it was not finalized or a Top Menu was not created on the equipment used for recording.

Audio and video momentarily pause.

- DVD-R DL and +R DL discs have two writable layers on one side. Video and audio may momentarily cut out when the unit is switching layers.

DVD-Video is not played.

- Ensure the disc is for the correct DVD-Video region number, and is not defective.

You have forgotten your rating PIN.

- The rating level returns to the factory preset. While the disc tray is open, press [DRIVE SELECT] to select the DVD drive, then press and hold [● REC] and [▶/× 1.3] on the main unit at the same time for 5 or more seconds ("INIT" will appear on the unit's display).

Image for the Quick View is not smooth.

- Image may not be played back smoothly in case of DR, HG, HX, HE, HL, HM mode titles or AVCHD format titles.

Cannot play the disc on other players.

- **DVD-R** **DVD-RW** **+R** **+RW** The disc must be finalized or have a Top Menu created. (⇒ 61)
- **DVD-R** The disc created in AVCHD format can only be played back on AVCHD compatible equipment.

Troubleshooting guide

Edit

The available recording time doesn't increase even after deleting titles on the disc.

- **[DVD-R] [R]** Available space on the disc does not increase even after deleting titles.
- **[DVD-RW] [RW]** Available space on the disc increases when you delete the last title.

Cannot edit.

- You may not be able to edit on the HDD if there is no available space. Delete any unwanted titles to create empty space. (⇒ 35)

Cannot create a playlist.

- Creation or editing of playlists cannot be done on this unit.

Picture

The contents of the SD card cannot be read.

- Remove the card from the slot and then insert again. If this does not solve the problem, switch the unit to standby mode and turn it on again.

Copying, deleting and setting protection takes a long time.

- When there are a lot of folders and files, it may sometimes take a long time.

Pictures do not play back normally.

- The images that were edited on the PC, such as PROGRESSIVE JPEG, etc., may not play back. (⇒ 95)

Music

Tracks could not be copied to the HDD.

- Copyright protected tracks such as SCMS restrictions will not be copied.
- Recording from CDs that do not conform to CD-DA specifications (copy control CDs, etc.) cannot be guaranteed.

USB

This unit does not recognize the USB device correctly.

- If inserted during playback the USB device may not be recognized by this unit. Disconnect and reconnect the USB device. If it still does not recognize the connection, switch the unit to standby mode and turn it on again.
- USB devices connected using a USB extension cable other than a dedicated one or a USB hub may not be recognized by this unit.

TV Guide

The TV Guide system does not receive any data. (e.g., The TV Guide screen is not displayed.)

- Set the clock correctly. (⇒ 66, 78, Clock)
- Some broadcast may not send programme information.
- There was a programme change, or TV Guide information from a broadcast station was possibly not correctly transmitted.
- If signal quality is bad, the TV Guide system may not be able to receive any data.
- Even if you press [GUIDE], the TV Guide screen will not be displayed while selecting a programme restricted by the set ratings level of Child Lock (Parental Rating). (⇒ 69)

Broadcast

Picture regularly breaks up on some channels.

- Adjust the aerial reception with “Manual Tuning”. (⇒ 66, 69)

Picture very infrequently breaks up on some or all channels.

- Electrical atmospheric interference caused by bad weather may cause pictures to break up and audio to mute or distort momentarily.

VIERA Link

VIERA Link doesn't work.

- Some functions may not work depending on the version of “HDAVI Control” of the connected TV, etc. This unit supports “HDAVI Control 5” functions.
- Check the settings of the connected TV, etc.
- If the connection for the equipment connected with HDMI was changed, or if there was a power failure or the plug was removed from the household mains socket, “HDAVI Control” may not work.

In this case, change TV (VIERA) setting for “HDAVI Control” again.

Network

You cannot access this unit from DLNA compatible equipment on the network.

- Check the network connection and the network settings. (⇒ 15, 18)
- It may not be possible to connect depending on the types of the equipment or the status of the equipment.

You cannot play contents properly from DLNA compatible equipment on the network.

- There may be some video that cannot be played back on DLNA compatible equipment depending on the equipment.
- Following titles cannot be played back:
 - A title with access restriction
 - A title currently being recorded on this unit
 - A title with audio only format
 - A title with incompatible format
- Playback via DLNA compatible equipment may not be performed when this unit is in the following conditions:
 - While simultaneously recording two programmes
 - While simultaneously performing High speed copy and recording
 - While displaying the Setup menu
 - While executing functions using a network, such as “VIERA CAST”
- You cannot play back simultaneously from two or more items of DLNA compatible equipment.

Reset

To return all the settings to the factory preset

Perform “Shipping Condition” or “Default Settings”. (⇒ 66, 78)

Troubleshooting guide

Messages on the unit's display

The following messages or service numbers appear on the unit's display when something unusual is detected.

DVD □

("□" stands for a number.)

The remote control and main unit are using different codes. Change the code on the remote control. (⇒ 83)

GUIDE

TV Guide data is being downloaded.

HARD ERR

If there is no change after switching the unit to standby mode and turning it on, consult the dealer.

NoERAS

You cannot delete items on this disc.
The disc may be damaged.

NoREAD

- The disc is dirty. (⇒ 9) The unit cannot record, play, or edit.
- The lens cleaner has finished cleaning. Press [▲ OPEN/CLOSE] on the main unit to eject the disc.

NoWRIT

You cannot write to this disc.
The disc may be damaged. Use a new disc.

PLEASE WAIT

- Displayed when the unit is started and is switched to standby mode.
- There was a power failure or the AC plug was disconnected while the unit was on. The unit is carrying out its recovery process. Wait until the message disappears.

PROG FULL

There are already 32 timer programmes. Delete unnecessary timer programmes. (⇒ 28)

REMOVE

The USB device is drawing too much power.
Remove the USB device.

START

Update of the software (firmware) is started.
You cannot operate the unit until the update is complete. (⇒ 80)

SW-DL

Software (firmware) is downloading.
Download will stop when the unit is turned on, or the timer recording starts. (⇒ 80)

UNSUPPORT

The media is not supported.

UPD □/□

("□" stands for a number.)

The software (firmware) is being updated.
You cannot operate the unit until the update is complete. (⇒ 80)

U59

The unit is hot.
The unit switches to standby for safety reasons.
Wait for about 30 minutes until the message disappears.
Do not block the cooling fan on the rear of the unit.

U61

(When a disc is not inserted) A malfunction has occurred. The unit is trying to restore to the normal operation. Once the message disappears you can use the unit again.
If it remains displayed, consult the dealer.

U72, U73

The HDMI connection acts unusually.

- The connected equipment is not HDMI compatible.
- Please use HDMI cables that have the HDMI logo.
- The HDMI cable is damaged.

Troubleshooting guide

U76

HDMI cannot be output because it is connected to a model that does not support copyright protection.

U77

Due to the current disc not having authorised copyright information, video output is not performed.

U88

(When a disc is inserted) There was something unusual detected with the disc. The unit is trying to restore to the normal operation. Once the message disappears you can use the unit again. If it remains displayed, consult the dealer.

U99

The unit fails to operate properly. Press [⏻/I] on the main unit to switch the unit to standby mode. Now press [⏻/I] on the main unit again to turn the unit on.

X HOLD

The HOLD function is activated. (⇒ 81)

H□□ or F□□

("□" stands for a number.)

There is something unusual. (The service number displayed after H and F depends on the unit's condition.)

Reset the unit as follows:

- 1 Disconnect the plug from the household mains socket, wait a few seconds, then reconnect it.
- 2 Press [⏻/I] to turn the power on. (The unit may be fixed.)

Request service from the dealer. Inform the dealer of the service number when requesting service.

When you experience problems with Network Easy Setting

If there is any problem, the following message is displayed on the screen.

Network Easy Settings (Connection Test)

Display	Check the following
1. LAN cable connection: "Fail" 2. IP address setting: "Fail" 3. Connection to gateway: "Fail"	<ul style="list-style-type: none"> • Connection of the LAN cables (⇒ 15) • Settings of the hub and router
1. LAN cable connection: "Pass" 2. IP address setting: "Fail" 3. Connection to gateway: "Fail"	
1. LAN cable connection: "Pass" 2. IP address setting: "Pass" 3. Connection to gateway: "Fail"	<ul style="list-style-type: none"> • Connection and settings of the hub and router • Settings of "IP Address / DNS Settings" (⇒ 66, 75)
1. LAN cable connection: "Pass" 2. IP address setting: "Home network available" 3. Connection to gateway: "Fail"	
1. LAN cable connection: "Pass" 2. IP address setting: "Home network available" 3. Connection to gateway: "Fail"	

Network Easy Settings (Internet Connection Test)

Display	Check the following
Cannot find the server. (B019)	<ul style="list-style-type: none"> • "Primary DNS" and "Secondary DNS" settings of "IP Address / DNS Settings" (⇒ 66, 75)
No connection could be made to the server. (B020)	<ul style="list-style-type: none"> • The server may be busy or the service may have been suspended. Please wait a few moments, and then try again. • Settings of "Proxy Server Settings" (⇒ 66, 75) and the router.

Specifications

Specifications are subject to change without notice.

■ General

Dimensions:

	430 mm (W)
	59 mm (H)
(excluding the projecting parts)	238 mm (D)
(including the projecting parts)	249 mm (D)

Mass:

	Approx. 3.3 kg
--	----------------

Power supply: AC 220 to 240 V, 50 Hz

Power consumption: Approx. 30 W

“Power Save in Standby” is activated:

	Approx. 1.1 W
--	---------------

“Power Save in Standby” is not activated:

	Approx. 7 W
--	-------------

Operating temperature: 5 °C to 40 °C

Operating humidity range: 10 % to 80 % RH (no condensation)

■ TV system

Tuner System: DVB-T

Country: New Zealand

Channel Coverage: UHF 21~69

■ Recording system

Video: MPEG-2 (Hybrid VBR),
MPEG-4 AVC/H.264

Audio:

Dolby Digital (XP, SP, LP, EP mode: 2ch)
LPCM (XP mode)

Dolby Digital
(DR mode, HG, HX, HE, HL, HM mode:
Max 5.1ch (DVB-T))

HE-AAC (DR mode: 2ch (DVB-T))

MPEG (DR mode: 2ch)

■ Video

Video system: PAL/NTSC

Analog video in (pin jack): 1 pc.

Input level: 1 Vp-p (75 Ω)

Analog video out (pin jack): 1 pc.

Output level: 1 Vp-p (75 Ω)

■ Audio

Analog audio L/R in (pin jack): 1 pc.

Input level:
Full scale 2.0 Vrms at 1 kHz (> 10 kΩ)

Analog audio L/R out (pin jack): 1 pc.

Output level:
Full scale 2.0 Vrms at 1 kHz (< 1 kΩ)

Digital audio out (optical): 1 pc.

Output format:
PCM, Dolby Digital, DTS, MPEG

■ HDMI terminal

HDMI out (19 pin type A): 1 pc.

Output format:
PCM, Dolby Digital, DTS, MPEG

- This unit supports “HDAVI Control 5” function.

■ Internal HDD capacity

500 GB

■ Other terminals

USB Port (Type A): 1 pc.

SD Card Slot: 1 pc.

LAN (Ethernet) Port: 1 pc.
10BASE-T/100BASE-TX

■ Recordable discs

DVD-RAM:	2X SPEED (Ver. 2.0), 2-3X SPEED (Ver. 2.1), 2-5X SPEED (Ver. 2.2)
DVD-R (SL):	1X SPEED (Ver. 2.0), 1-4X SPEED (Ver. 2.0), 1-8X SPEED (Ver. 2.0), 1-16X SPEED (Ver. 2.1)
DVD-R (DL):	2-4X SPEED (Ver. 3.0), 2-8X SPEED (Ver. 3.0)
DVD-RW:	1X SPEED (Ver. 1.1), 1-2X SPEED (Ver. 1.1), 2-4X SPEED (Ver. 1.2), 2-6X SPEED (Ver. 1.2)
+R (SL):	2.4X SPEED (Ver. 1.0), 2.4-4X SPEED (Ver. 1.1), 2.4-8X SPEED (Ver. 1.2), 2.4-16X SPEED (Ver. 1.3)
+R (DL):	2.4X SPEED (Ver. 1.0), 2.4-8X SPEED (Ver. 1.1)
+RW:	2.4X SPEED (Ver. 1.1), 2.4-4X SPEED (Ver. 1.2)

■ Playable discs

DVD-RAM:	DVD Video Recording format, AVCHD format, JPEG
DVD-R:	DVD-Video format* ¹ , AVCHD format* ¹ , MP3* ^{1, 2} , JPEG* ^{1, 2} , DivX* ^{1, 2}
DVD-R DL (Dual Layer):	DVD-Video format* ¹ , AVCHD format* ¹ , MP3* ^{1, 2} , JPEG* ^{1, 2} , DivX* ^{1, 2}
DVD-RW:	DVD-Video format* ¹ , DVD Video Recording format, AVCHD format* ¹
+R* ¹ , +R DL (Double Layer)* ¹ , +RW	
DVD-Video	
CD-Audio (CD-DA)	
CD-R/CD-RW:	CD-DA* ¹ , MP3* ^{1, 2} , JPEG* ^{1, 2} , DivX* ^{1, 2}

*¹ Finalising is necessary for compatible playback.

*² ISO9660 level 1 or 2 (except for extended formats) and Joliet

This unit is compatible with multi-session/border (except for DVD-R DL).
This unit is not compatible with packet-writing.

■ Optical pick-up

System with 1 lens, 2 integration units
(662 nm wavelength for DVDs,
780 nm wavelength for CDs)

■ LASER specification

Class 1 LASER Product

Wave length:

780 nm (CDs)
662 nm (DVDs)

Laser power:

No hazardous radiation is emitted with
the safety protection

■ Recording system

DVD-RAM:	DVD Video Recording format
DVD-R (SL/DL):	DVD-Video format
DVD-RW:	DVD-Video format
+R (SL/DL), +RW	

■ Region code:

DVD: #4

■ SD Card

Slot:	SD Memory Card slot: 1 pc
Compatible media:	SD Memory Card
Format:	FAT12, FAT16 (In case of SD Memory Card) FAT32 (In case of SDHC Memory Card) exFAT (In case of SDXC Memory Card)

Data that can be played: JPEG,
SD (Standard Definition)-Video*,
HD (High Definition)-Video

* Video Recording conversion and transfer is possible from SD card to HDD or DVD-RAM disc.

After Video Recording conversion and transfer to HDD or DVD-RAM disc is completed, the playback becomes possible.

Specifications

■ USB device

USB standard: USB2.0 High Speed
 Format: FAT16, FAT32
 Data that can be played: MP3, JPEG, DivX, SD (Standard Definition)-Video*1, HD (High Definition)-Video*2

*1 Video Recording conversion and transfer is possible from USB device to HDD or DVD-RAM disc.

After Video Recording conversion and transfer to HDD or DVD-RAM disc is completed, the playback becomes possible.

*2 Video Recording conversion and transfer is possible from USB device to HDD. After Video Recording conversion and transfer to HDD is completed, the playback becomes possible.

Maximum numbers of titles that can be recorded

HDD	999 titles (When continuously recording for long durations, titles are automatically divided every 8 hours.)
DVD-RAM, DVD-R, DVD-RW	99 titles on one disc.
+R, +RW	49 titles on one disc.

Information for the files other than recorded programmes

■ DivX

Playable media DVD-R, DVD-R DL, CD-R, CD-RW, USB device*

Maximum number of folders recognizable: 300 folders (including the root folder)

Maximum number of files recognizable: 200 files

- Support version

Picture resolution

Up to 1920×1080 pixels

Reference

DivX certified to play DivX video up to HD 1080p, including premium content.

Video

- Number of stream: Up to 1
- Codec: DIV3, DIV4, DIVX, DV50, DIV6
- FPS (Frame Per Second): Up to 60 fps

Audio

- Number of stream: Up to 8
- Format: MP3, MPEG, Dolby Digital
- Multi channel: Dolby Digital is possible. MPEG multi is 2 ch conversion.

- GMC (Global Motion Compensation) is not supported.
- DVD-R and DVD-R DL must conform to UDF 1.02 without ISO9660 and UDF 1.5 with ISO9660.
- * DivX VOD contents cannot be played back.

■ SD (Standard Definition)-Video

Playable media SD Card*¹, USB device*²
 Codec MPEG2

(SD-Video Entertainment Video Profile)

File Format SD-Video format conforming

*¹ Video Recording conversion and transfer is possible from SD card to HDD or DVD-RAM disc.

After Video Recording conversion and transfer to HDD or DVD-RAM disc is completed, the playback becomes possible.

*² Video Recording conversion and transfer is possible from USB device to HDD or DVD-RAM disc.

After Video Recording conversion and transfer to HDD or DVD-RAM disc is completed, the playback becomes possible.

• Support version

Extension

- Files must have the extension ".MPG", ".mpg", ".MPEG", ".mpeg", ".M2TS", ".m2ts", ".MTS", ".mts", ".TS" or ".ts".

■ HD (High Definition)-Video

Playable media SD Card, USB device*
 Codec MPEG-4 AVC/H.264

File Format AVCHD format conforming

* Video Recording conversion and transfer is possible from USB device to HDD.

After Video Recording conversion and transfer to HDD is completed, the playback becomes possible.

■ JPEG

Playable media HDD, DVD-RAM,
 DVD-R, DVD-R DL, CD-R, CD-RW,
 SD Card, USB device

Format JPEG conforming DCF
 (Design rule for Camera File system)*

Compatible pixels Between 34×34 and
 8192×8192 pixels
 (Sub sampling is 4:2:2 or 4:2:0)

Thawing Time Approx. 2 sec. in case of SD card
 (8.1 M pixels, JPEG)

Maximum number of folders recognizable:

CD 99 folders (including the root folder)
HDD **RAM** **DVD-R** **SD** **USB** 300 folders
 (including the root folder)

Maximum number of files recognizable:

CD 999 files
RAM **DVD-R** **SD** **USB** 3000 files
HDD 9999 files

• JPEG files must have the extension ".jpg" or ".JPG".

• MOTION JPEG and PROGRESSIVE JPEG are not supported.

* Design rule for Camera File system: unified standard established by Japan Electronics and Information Technology Industries Association (JEITA).

■ MP3

Playable media HDD, DVD-R, DVD-R DL,
 CD-R, CD-RW, USB device

Compression rate 32 kbps to 320 kbps

Sampling frequency 16 kHz/22.05 kHz/
 24 kHz/32 kHz/
 44.1 kHz/48 kHz

This unit is compatible with ID3 tags.

Maximum number of folders recognizable
 (except for HDD):

300 folders (including the root folder)

Maximum number of files recognizable
 (except for HDD):

3000 files

• MP3 files must have the extension ".mp3" or ".MP3".

Specifications

Recording modes and approximate recording times

Depending on the content being recorded, the recording times may become shorter than indicated.

■ DR, HG, HX, HE, HL, HM mode

Recording Mode	DR (HD quality)	DR (SD quality)	HG	HX	HE	HL	HM
HDD (500 GB)	75 hours	211 hours	78 hours	117 hours	176 hours	235 hours	341 hours

• Recording time of DR mode may vary depending on the bit rate of broadcasting:

- High Definition (HD) quality: estimated bit rate is 14 Mbps
- Standard Definition (SD) quality: estimated bit rate is 5 Mbps

• Regarding recording time remaining:

Remaining time in the DR mode is calculated with a bit rate of 14 Mbps. But the bit rate differs depending on the broadcast, so the displayed remaining time might be different from the actual remaining time.

■ XP, SP, LP, EP modes

Recording Mode	HDD (500 GB)	DVD-RAM		DVD-R, DVD-RW, +R, +RW (4.7 GB)	DVD-R DL, +R DL (8.5 GB)
		Single-sided (4.7 GB)	Double-sided (9.4 GB)		
XP	107 hours	1 hour	2 hours	1 hour	1 hour 45 min.
SP	215 hours	2 hours	4 hours	2 hours	3 hours 35 min.
LP	430 hours	4 hours	8 hours	4 hours	7 hours 10 min.
EP (6 hours)*	645 hours	6 hours	12 hours	6 hours	10 hours 45 min.
EP (8 hours)	860 hours	8 hours	16 hours	8 hours	14 hours 20 min.

* When "Recording time in EP mode" is set to "6 hours" (⇒ 70)

• Regarding recording time remaining:

This unit records using a VBR (Variable bit rate) data compression system to vary recorded data segments to match video data segments which may cause differences in the displayed amount of time and space remaining for recording.

Licenses

"AVCHD" is a trademark of Panasonic Corporation and Sony Corporation.
DivX®, DivX Certified® and associated logos are trademarks of Rovi Corporation or its subsidiaries and are used under license.
DLNA, the DLNA Logo and DLNA CERTIFIED are trademarks, service marks, or certification marks of the Digital Living Network Alliance.
DVB and the DVB logos are trademarks of the DVB Project.
Manufactured under license from Dolby Laboratories. Dolby and the double-D symbol are trademarks of Dolby Laboratories.
Manufactured under license under U.S. Patent Nos: 5,956,674; 5,974,380; 6,487,535 & other U.S. and worldwide patents issued & pending. DTS, the Symbol, & DTS and the Symbol together are registered trademarks & DTS Digital Surround and the DTS logos are trademarks of DTS, Inc. Product includes software. © DTS, Inc. All Rights Reserved.
"DVD Logo" is a trademark of DVD Format/Logo Licensing Corporation.
MPEG Layer-3 audio coding technology licensed from Fraunhofer IIS and Thomson.
This product is licensed under the AVC patent portfolio license for the personal and non-commercial use of a consumer to (i) encode video in compliance with the AVC Standard ("AVC Video") and/or (ii) decode AVC Video that was encoded by a consumer engaged in a personal and non-commercial activity and/or was obtained from a video provider licensed to provide AVC Video. No license is granted or shall be implied for any other use. Additional information may be obtained from MPEG LA, LLC. See http://www.mpegla.com .
This item incorporates copy protection technology that is protected by U.S. patents and other intellectual property rights of Rovi Corporation. Reverse engineering and disassembly are prohibited.
SDXC Logo is a trademark of SD-3C, LLC.
VIERA CAST is a trademark of Panasonic Corporation.
HDAVI Control™ is a trademark of Panasonic Corporation.
HDMI, the HDMI Logo, and High-Definition Multimedia Interface are trademarks or registered trademarks of HDMI Licensing LLC in the United States and other countries.

Licenses



Gracenote® Corporate Description

Music and video recognition technology and related data are provided by Gracenote®. Gracenote is the industry standard in music recognition technology and related content delivery. For more information, please visit www.gracenote.com.

Gracenote® Proprietary Legends

CD, DVD, Blu-ray Disc, and music and video-related data from Gracenote, Inc., copyright © 2000 to present Gracenote. Gracenote Software, copyright © 2000 to present Gracenote. One or more patents owned by Gracenote apply to this product and service. See the Gracenote website for a non-exhaustive list of applicable Gracenote patents. Gracenote, CDDB, MusicID, MediaVOCS, the Gracenote logo and logotype, and the "Powered by Gracenote" logo are either registered trademarks or trademarks of Gracenote in the United States and/or other countries.

Gracenote® End User License Agreement

This application or device contains software from Gracenote, Inc. of Emeryville, California ("Gracenote"). The software from Gracenote (the "Gracenote Software") enables this application to perform disc and/or file identification and obtain music-related information, including name, artist, track, and title information ("Gracenote Data") from online servers or embedded databases (collectively, "Gracenote Servers") and to perform other functions. You may use Gracenote Data only by means of the intended End-User functions of this application or device.

You agree that you will use Gracenote Data, the Gracenote Software, and Gracenote Servers for your own personal non-commercial use only. You agree not to assign, copy, transfer or transmit the Gracenote Software or any Gracenote Data to any third party. YOU AGREE NOT TO USE OR EXPLOIT GRACENOTE DATA, THE GRACENOTE SOFTWARE, OR GRACENOTE SERVERS, EXCEPT AS EXPRESSLY PERMITTED HEREIN.

You agree that your non-exclusive license to use the Gracenote Data, the Gracenote Software, and Gracenote Servers will terminate if you violate these restrictions. If your license terminates, you agree to cease any and all use of the Gracenote Data, the Gracenote Software, and Gracenote Servers. Gracenote reserves all rights in Gracenote Data, the Gracenote Software, and the Gracenote Servers, including all ownership rights. Under no circumstances will Gracenote become liable for any payment to you for any information that you provide. You agree that Gracenote, Inc. may enforce its rights under this Agreement against you directly in its own name.

The Gracenote service uses a unique identifier to track queries for statistical purposes. The purpose of a randomly assigned numeric identifier is to allow the Gracenote service to count queries without knowing anything about who you are. For more information, see the web page for the Gracenote Privacy Policy for the Gracenote service.

The Gracenote Software and each item of Gracenote Data are licensed to you "AS IS." Gracenote makes no representations or warranties, express or implied, regarding the accuracy of any Gracenote Data from in the Gracenote Servers. Gracenote reserves the right to delete data from the Gracenote Servers or to change data categories for any cause that Gracenote deems sufficient. No warranty is made that the Gracenote Software or Gracenote Servers are error-free or that functioning of Gracenote Software or Gracenote Servers will be uninterrupted. Gracenote is not obligated to provide you with new enhanced or additional data types or categories that Gracenote may provide in the future and is free to discontinue its services at any time.

GRACENOTE DISCLAIMS ALL WARRANTIES EXPRESS OR IMPLIED, INCLUDING, BUT NOT LIMITED TO, IMPLIED WARRANTIES OF MERCHANTABILITY, FITNESS FOR A PARTICULAR PURPOSE, TITLE, AND NON-INFRINGEMENT. GRACENOTE DOES NOT WARRANT THE RESULTS THAT WILL BE OBTAINED BY YOUR USE OF THE GRACENOTE SOFTWARE OR ANY GRACENOTE SERVER. IN NO CASE WILL GRACENOTE BE LIABLE FOR ANY CONSEQUENTIAL OR INCIDENTAL DAMAGES OR FOR ANY LOST PROFITS OR LOST REVENUES.

This product incorporates the following software:

- (1) the software developed independently by or for Panasonic Corporation,
- (2) the software owned by third party and licensed to Panasonic Corporation,
- (3) the software licensed under the GNU General Public License, Version 2 (GPL v2),
- (4) the software licensed under the GNU LESSER General Public License, Version 2.1 (LGPL v2.1) and/or,
- (5) open sourced software other than the software licensed under the GPL v2 and/or LGPL v2.1

For the software categorized as (3) and (4), please refer to the terms and conditions of GPL v2 and LGPL v2.1, as the case may be at

<http://www.gnu.org/licenses/old-licenses/gpl-2.0.html> and

<http://www.gnu.org/licenses/old-licenses/lgpl-2.1.html>.

In addition, the software categorized as (3) and (4) are copyrighted by several individuals. Please refer to the copyright notice of those individuals at

<http://www.am-linux.jp/dl/JPRCBW98>

The GPL/LGPL software is distributed in the hope that it will be useful, but WITHOUT ANY WARRANTY, without even the implied warranty of MERCHANTABILITY or FITNESS FOR A PARTICULAR PURPOSE.

At least three (3) years from delivery of products, Panasonic will give to any third party who contacts us at the contact information provided below, for a charge no more than our cost of physically performing source code distribution, a complete machine-readable copy of the corresponding source code covered under GPL v2/LGPL v2.1.

Contact Information

cdrequest@am-linux.jp

Source code is also freely available to you and any other member of the public via our website below.

<http://www.am-linux.jp/dl/JPRCBW98>

Licenses

ABOUT DIVX VIDEO:

DivX® is a digital video format created by DivX, LLC, a subsidiary of Rovi Corporation. This is an official DivX Certified® device that plays DivX video. Visit divx.com for more information and software tools to convert your files into DivX videos.

ABOUT DIVX VIDEO-ON-DEMAND:

This DivX Certified® device must be registered in order to play purchased DivX Video-on-Demand (VOD) movies. To obtain your registration code, locate the DivX VOD section in your device setup menu. Go to vod.divx.com for more information on how to complete your registration.

Index

- A**
- Aspect** 74, 81
 - Audio**
 - Broadcasts 22
 - Playback 34
 - Auto Setup** 68
 - AVCHD** 45, 57, 95
 - Copy 45, 57
 - Playback 29, 31
- C**
- Channel information** 21
 - Channel List** 20
 - Edit 68
 - Chapter** 30, 34, 39
 - Child Lock (Parental Rating)** 69
 - Clock** 78
 - Connection**
 - Amplifier/receiver 14
 - AUDIO OUT terminal 15
 - Audio/Video terminal 14
 - Basic connection 13
 - DIGITAL AUDIO OUT terminal 15
 - HDMI cable 13, 14
 - Network 15
 - Set Top Box 14
 - Video equipment 14
 - Copy (Music)** 52
 - Copy (Picture)** 50
 - Copy (Video)** 40
 - Copy title playing 45
 - Finalised disc 44
 - HD Video (AVCHD) 45, 57
 - SD Video (MPEG2) 58
- D**
- Delete**
 - Music 55
 - Picture 49
 - Video 35
 - Delete all titles**
 - Disc 60
 - HDD 71
 - DIRECT NAVIGATOR**
 - Music 53
 - Picture 46
 - Video 29
 - Disc**
 - Delete all titles 60
 - Finalise 61
 - Format 60
 - Media information 6
 - Protection 60
 - DivX** 94
 - Playback 31
 - DLNA** 59, 76
 - DR File Conversion** 38
 - DVD-Video**
 - Playback 31
 - DVD-Video Parental Control** 70
- E**
- Easy setting** 17
 - Edit (Music)** 55
 - Edit (Picture)** 48
 - Edit (Video)** 36
 - Chapter 34, 39
 - Delete 36
 - DR File Conversion 38
 - Protection 36
 - Entering text** 81
- F**
- Favourites** 68
 - Finalise** 61
 - Format**
 - Disc 60
 - HDD 71
 - SD Card 60
 - FUNCTION MENU** 19

Index

H

HD Video (AVCHD)	95
Copy	45, 57
Play	29, 31
HDAVI Control	62, 75
HDD	
Delete all titles	71
Format	71
Media information	6
HDMI cable	13
HOLD function	81
Home Network (DLNA)	59, 76

J

JPEG	46, 95
-------------------	--------

L

Language code list	79
---------------------------------	----

M

Manual Tuning	69
----------------------------	----

Media

Disc	6
HDD	6
SD Card	6, 9
USB memories	6, 9

Menu screen	31
--------------------------	----

MPEG2	58, 95
--------------------	--------

MP3	52, 95
------------------	--------

Music

Copy	52
Delete	55
Edit	55
Playback	52

N**Network**

Connection	15
DLNA	59, 76
Setting	75
Software (Firmware) Update	80
VIERA CAST	63
Network Easy Settings	18, 75

P

PAUSE LIVE TV	22
----------------------------	----

Picture

Copy	50
Delete	49
Edit	48
Playback	46
Protection	49
Slideshow	47, 54

PIN

Playback menu	67
Playback (Music)	

Audio CD	52
MP3	52
Recorded on HDD	53
Playback (Picture)	46
Slideshow	47, 54

Playback (Video)

AVCHD	29, 31
Changing audio	34
Chapter	30
DivX	31
DVD-Video	31
DVD-Video Parental Control	70
Playlist created on other equipment	31
Recorded video contents	29, 31
Status message	33
Subtitles	34

Power Save in Standby	17, 77
------------------------------------	--------

Protection

Cartridge	8
Disc	60
HOLD function	81
Picture	49
Video	36

R	
Recording	23
Aspect	70
From external equipment	56
High speed copy	71
Recording mode	7, 96
Recording time	96
Timer recording	25
Recording mode	7, 96
Remote control	
HOLD function	81
Manufacturer and Code No.	16
Remote control code	77
TV operation	16
Reset	78
S	
SD Card	
Format	60
Media information	6, 9
miniSD / microSD	9
SD Video (MPEG2)	95
Copy	58
Setting	
Auto Setup	68
Easy setting	17
Network Easy Settings	18, 75
Setup menu	66
Connection	74
Digital TV Tuning	68
Display	74
HDD / Disc	70
Network	75
Others	77
Picture	72
Sound	72
Slideshow	47, 54
Software (Firmware) Update	80
Subtitles	
Broadcasts	22
Playback	34
T	
Teletext	22, 74
Timer recording	25
Guide Link	25
Manually programming timer recording	26
Series Timer Recording	25
Split Programme	25
Top Menu	
Create Top Menu	61
Tuning	
Channel List	68
Manual Tuning	69
Parental Rating	69
Signal condition	69
TV Guide	
Operation	20
Timer recording	25
TV System	74
U	
Unit's display	
Messages	88
USB memories	
Media information	6, 9
V	
Video	
Copy	40
Delete	35
DIRECT NAVIGATOR	29
Edit	36
Playback	29, 31
Protection	36
Recording	23
VIERA CAST	63
VIERA Link	62, 75

Information on Disposal in other Countries outside the European Union



This symbol is only valid in the European Union.
If you wish to discard this product, please contact your local authorities or dealer and ask for the correct method of disposal.

The recording and playback of content on this or any other device may require permission from the owner of the copyright or other such rights in that content. Panasonic has no authority to and does not grant you that permission and explicitly disclaims any right, ability or intention to obtain such permission on your behalf. It is your responsibility to ensure that your use of this or any other device complies with applicable copyright legislation in your country. Please refer to that legislation for more information on the relevant laws and regulations involved or contact the owner of the rights in the content you wish to record or playback.

Panasonic Corporation
Web Site: <http://panasonic.net>

En

VQT4C72
F0212MD0

© Panasonic Corporation 2012

Free Manuals Download Website

<http://myh66.com>

<http://usermanuals.us>

<http://www.somanuals.com>

<http://www.4manuals.cc>

<http://www.manual-lib.com>

<http://www.404manual.com>

<http://www.luxmanual.com>

<http://aubethermostatmanual.com>

Golf course search by state

<http://golfingnear.com>

Email search by domain

<http://emailbydomain.com>

Auto manuals search

<http://auto.somanuals.com>

TV manuals search

<http://tv.somanuals.com>