

## Installation Guide

### Network Camera Indoor Use Only

Model No. **BB-HCM381** (AC Adaptor Type)  
**BB-HCE481** (PoE Type)

- Please read the Important Information before using.
- "Network Camera" is called "Camera" in this manual.
- "Setup CD-ROM" is called "CD-ROM" in this manual.
- The illustrations used in this manual are of BB-HCM381.

This manual is for both BB-HCM381 (AC Adaptor Type) and BB-HCE481 (PoE Type). Available features and operations are different in part depending on the model. Read the Operating Instructions on the CD-ROM carefully and use the Network Camera properly.

Mount the camera after the camera is connected and finished setting up following Getting Started.

### Installation Procedures

<b>1</b>	<b>Temporarily place the camera.</b>	Temporarily place the camera where you like to view images.
<b>2</b>	<b>Adjust the position and direction of the camera.</b>	Adjust the position and direction of the camera while you confirm that images are displayed on the monitor as you imaged.
<b>3</b>	<b>Attach the camera.</b>	The camera can be mounted on the ceiling. Attach the camera firmly when mounting on the ceiling.

- The camera can be viewed in the least light requirement at 3 lx (default). Use supplemental lighting for the dimly lit places. (The camera can be viewed in the least of 0.09 lx in the color night view mode (see page 86 of the Operating Instructions on the CD-ROM), which may increase the refresh interval.)
- After preparing the Ethernet cable that has enough length, mount the camera.
- Mounting and cabling instructions described in this Installation Guide follow generally accepted guidelines suitable for residential installations. In some areas, commercial and industrial installations are regulated by local or state ordinances. For such installations, contact your local building department or building inspector for more details.

### Mounting on the Ceiling

- Make sure the camera is firmly mounted on the ceiling.
- The camera is available between  $\pm 15^\circ$  based on level line for mounting.
- The camera should be uninstalled from the ceiling when removing the SD memory card (see page 146 of the Operating Instructions on the CD-ROM).
- The camera is intended for indoor use only. Prolonged exposure to direct sunlight or halogen light may damage CCD.
- The camera's MAC address and serial number are printed on the bottom of the camera. They are needed in order for camera configuration and maintenance. Record both of them for before mounting the camera.
- Set the Mounting type setting to [On the ceiling] on the Camera Setup page (see page 86 of the Operating Instructions on the CD-ROM).
- Two ways of wiring can be considered; wiring through a hole made in the ceiling or wiring without making a hole for a cable in the ceiling. Select either one of the two.
- The audio cable or audio/video cable cannot be connected or removed after mounting on the ceiling.

### ■ Wiring through a hole made in the ceiling

- 1 Attach the Ceiling Plate B on the ceiling with Screws B.

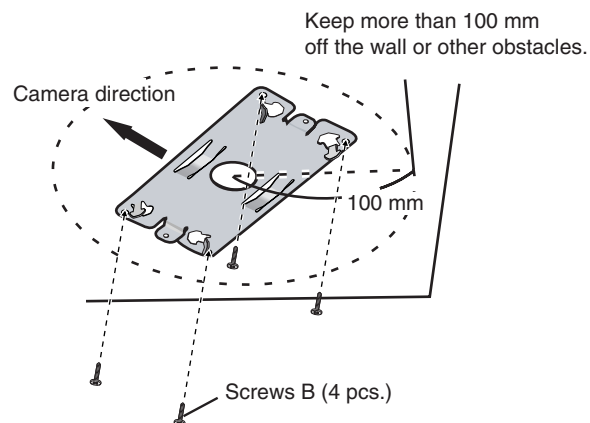

- Attach the Ceiling Plate B more than 100 mm off the wall or other obstacles from its center.
- Make sure the camera is firmly mounted on a beam of wood etc. When there is no beam, apply a board on the other side of the ceiling to make sure the camera does not drop.

## 2 Make a hole for a cable.

Hole for a cable  
φ 25 mm

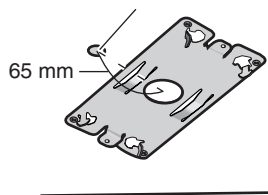

- Make a φ 25 mm hole where is 65 mm away from the center in the plate.

## 3 Attach the rubbers and dents on the camera to the Ceiling Plate A and attach them firmly.

Fit the four rubbers in place.

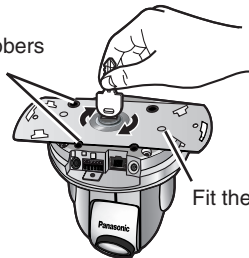

Fit the two dents in place.

## 4 Attach the Ceiling Plate A to the Ceiling Plate B and attach them firmly with Screws A.

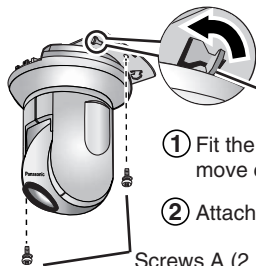

Four tabs

- ① Fit the tabs to the holes and move counterclockwise.
- ② Attach firmly with Screws A.

Screws A (2 pcs.)

- Install the camera so that the connecting part comes to the front.

## 5 Connect all necessary cables (AC adaptor cord, Ethernet cable, Audio Cable or Audio/Video Cable, etc.) seeing Getting Started and attach the Ceiling Mounting Cover.

- ① Adjust the " / " of the main unit to the " / " of the Ceiling Mounting Cover.
- ② Move the Ceiling Mounting Cover in the clockwise direction until the " o " of it fits to the " / " of the main unit.

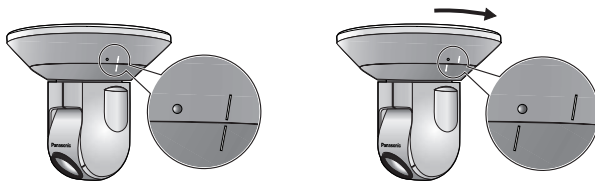

- Be careful not to nip the cable etc.
- When removing the Ceiling Mounting Cover, move it in the counterclockwise direction. Adjust both " / " and let down the main unit.

## Wiring without making a hole for a cable in the ceiling

Follow the steps 1), 3), 4) and 5). Making a hole is not necessary.

- Remove the tab of Ceiling Mounting Cover and wire through the notch.

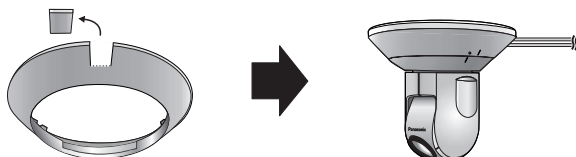

## Ceiling Mounting when the material of the ceiling is mortar or concrete

- 1 Fit the Ceiling Plate B to the mounting position and put marks.
- 2 Make holes at the marks and put plastic plugs (customer-provided) into them.

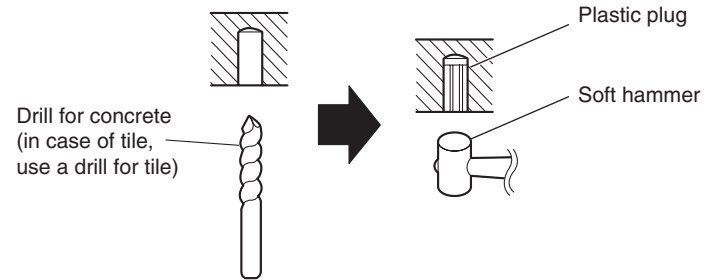

### Note

- When drilling into mortar, be careful of pieces of mortar which may become loose and fall.

## 3 Mount the camera.

### Mounting on the Table

Mount the camera at an even place on the table where vibrations etc. are few.

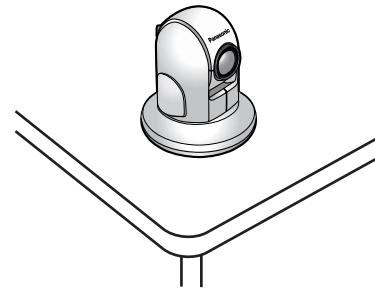

- Set the Mounting type setting to [On the table] on the Camera Setup page (see page 86 of the Operating Instructions on the CD-ROM).

## Free Manuals Download Website

<http://myh66.com>

<http://usermanuals.us>

<http://www.somanuals.com>

<http://www.4manuals.cc>

<http://www.manual-lib.com>

<http://www.404manual.com>

<http://www.luxmanual.com>

<http://aubethermostatmanual.com>

Golf course search by state

<http://golfingnear.com>

Email search by domain

<http://emailbydomain.com>

Auto manuals search

<http://auto.somanuals.com>

TV manuals search

<http://tv.somanuals.com>