

# Panasonic<sup>®</sup>

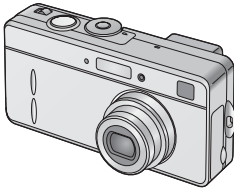

## LUMIX

## Digital Camera Operating Instructions

Model No. **DMC-F1PP**



**LEICA**  
**DC VARIO-ELMARIT**

Before use, please read these  
instructions completely.

For USA assistance, please call: 1-800-272-7033 or send e-mail to : [consumerproducts@panasonic.com](mailto:consumerproducts@panasonic.com)

For Canadian assistance, please call: 1-800-561-5505 or visit us at [www.panasonic.ca](http://www.panasonic.ca)

VQT0B81

**Dear Customer,**

We would like to take this opportunity to thank you for purchasing this Panasonic Digital Camera. Please read these Operating Instructions carefully and keep them handy for future reference.

## *Information for Your Safety*

**WARNING**

**TO REDUCE THE RISK OF FIRE OR SHOCK HAZARD AND ANNOYING INTERFERENCE, USE ONLY THE RECOMMENDED ACCESSORIES AND DO NOT EXPOSE THIS EQUIPMENT TO RAIN OR MOISTURE. DO NOT REMOVE THE COVER (OR BACK); THERE ARE NO USER SERVICEABLE PARTS INSIDE. REFER SERVICING TO QUALIFIED SERVICE PERSONNEL.**

**Notice:**

This product has parts that contain a small amount of mercury. It also contains lead in some components. Disposal of these materials may be regulated in your community due to environmental considerations. For disposal or recycling information please contact your local authorities, or the Electronics Industries Alliance: <<http://www.eiae.org>>

**Carefully observe copyright laws.**

**Recording of pre-recorded tapes or discs or other published or broadcast material for purposes other than your own private use may infringe copyright laws. Even for the purpose of private use, recording of certain material may be restricted.**

- Please note that the actual controls and components, menu items, etc. of your Digital Camera may look somewhat different from those shown in the illustrations in these Operating Instructions.
- SD Logo is a trademark.
- Other names, company names, and product names printed in these instructions are trademarks or registered trademarks of the companies concerned.



A lithium ion/polymer battery that is recyclable powers the product you have purchased. Please call 1-800-8-BATTERY for information on how to recycle this battery.

**FCC Note: (U.S. only)**

This equipment has been tested and found to comply with the limits for a Class B digital device, pursuant to Part 15 of the FCC Rules. These limits are designed to provide reasonable protection against harmful interference in a residential installation. This equipment generates, uses, and can radiate radio frequency energy and, if not installed and used in accordance with the instructions, may cause harmful interference to radio communications. However, there is no guarantee that interference will not occur in a particular installation. If this equipment does cause harmful interference to radio or television reception, which can be determined by turning the equipment off and on, the user is encouraged to try to correct the interference by one or more of the following measures:

- Reorient or relocate the receiving antenna.
- Increase the separation between the equipment and receiver.
- Connect the equipment into an outlet on a circuit different from that to which the receiver is connected.
- Consult the dealer or an experienced radio/TV technician for help.

**FCC Caution:** To assure continued compliance, follow the attached installation instructions and use only shielded interface cables with ferrite core when connecting to computer or peripheral devices.

Any changes or modifications not expressly approved by the party responsible for compliance could void the user's authority to operate this equipment.

Trade Name: Panasonic  
 Model No.: DMC-F1  
 Responsible party: Matsushita Electric Corporation of America One Panasonic Way, Secaucus, NJ 07094  
 Support Contact: Panasonic Consumer Electronics Company  
 1-800-272-7033

This device complies with Part 15 of the FCC Rules. Operation is subject to the following two conditions: (1) This device may not cause harmful interference, and (2) this device must accept any interference received, including interference that may cause undesired operation.

This Class B digital apparatus complies with Canadian ICES-003

**Panasonic** DMC-F1



Tested To Comply  
 With FCC Standards

FOR HOME OR OFFICE USE

# Contents

## Safety

Information for Your Safety .....	2
-----------------------------------	---

## Preparation

Standard Accessories .....	5
Names of the Components .....	6
LCD Monitor Display .....	8
Quick Guide .....	10
Charging the Battery .....	11
Inserting the Battery .....	12
Connecting to an Electrical Outlet.....	14
Inserting the Card.....	15
Turning Power on/off.....	17
Attaching the Strap.....	18
Using the LCD Monitor.....	19
Using the Optical Viewfinder .....	20
The Shutter Button (Pressing halfway/Pressing fully).....	21
The Mode Dial.....	22
Operating the Menu .....	23
Setting the Date/Time (Clock Set).....	24

## Recording images (basic)

Taking Pictures .....	25
Taking Pictures in Simple Mode.....	27
Checking the Captured Picture (Review) .....	28
Recording Motion Images .....	29
Using the Optical Zoom.....	30
Using the Digital Zoom.....	31
Taking Pictures using the Built-in Flash.....	32
Using the Continuous AF .....	34
Taking Pictures with the Self-timer.....	35

## Recording images (advanced)

Taking Pictures with Audio.....	36
Changing the Picture Size.....	37
Changing the Quality (Data Compression Ratio).....	38
Taking Pictures using Macro Mode.....	39
Taking Pictures using Portrait Mode .....	40
Taking Pictures using Landscape Mode.....	41
Taking Pictures using Night Portrait Mode.....	42
Taking Pictures using Color Effect Mode.....	43

Taking Pictures using Spot Mode.....	44
Compensating the Exposure .....	45
Taking Pictures using Auto Exposure (AE) Bracket.....	46
Using the AF/AE Lock.....	47
Picture Adjustment (Natural/Standard/Vivid).....	48
Setting the White Balance .....	49
Setting ISO Sensitivity .....	51
Taking Pictures using Burst Mode .....	52

## Playback

Playing Back Still Pictures .....	53
Playing Back Still Pictures with Audio.....	54
9 Images Multi Playback.....	55
Using the Playback Zoom.....	56
Playing Back Motion Images .....	57

## Editing

Deleting Images.....	58
Writing the Print Information to the Card (DPOF Setting).....	60
Protecting Images on the Card.....	63

## Technical use

Playing Back with Slide Show (Automatic Playback).....	64
Adding Audio to Recorded Pictures (Audio Dubbing).....	66
Resizing Recorded Pictures .....	67
Trimming Recorded Pictures .....	68
Formatting the Card.....	69
Adjusting the LCD Monitor Brightness .....	70
Using the Auto Review .....	71
Setting up the Operational Sound/ Shutter Sound.....	72
Setting up the Power Save Mode .....	73
Resetting the File Number.....	74
Initializing the settings.....	75
Playing Back Images with a TV Monitor .....	76
Connecting to a PC.....	77
USB DIRECT-PRINT .....	78
USB DIRECT-PRINT (Single Picture) .....	79
USB DIRECT-PRINT (DPOF).....	80
After Use.....	81

**Others**

The Menu Items .....	82
Cautions for Use .....	84
Warning Indications.....	88
Troubleshooting .....	89
Specifications .....	90
Digital Camera Accessory System.....	92

Digital Camera Accessory Order Form (For USA Customers) .....	93
Request for Service Notice .....	94
Limited Warranty (For USA Only) .....	95
Customer Services Directory (For USA Only) .....	97
Index .....	98
Spanish Quick Use Guide/ Guía española para el uso rápido.....	99

## Standard Accessories

Before using your camera, check the contents.

- 1 SD Memory Card (16MB)  
RP-SD016B  
(In the text, it is indicated as "Card")

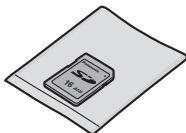

- 2 Battery Pack  
CGA-S001A  
(In the text, it is indicated as "Battery")



- 3 Battery Charger/AC Adaptor  
DE-929A  
(In the text, it is indicated as  
"AC Adaptor")

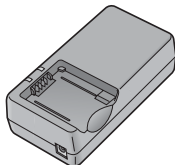

- 4 AC Cable  
K2CA2EA00002



- 5 DC Cable  
K2GJ2DC00005



- 6 A/V Cable  
K1V204C10001



- 7 USB Connection Cable  
K1HA05CD0002



- 8 CD-ROM  
VFF0183



- 9 Strap  
VFC3952



# Names of the Components

## [Front View]

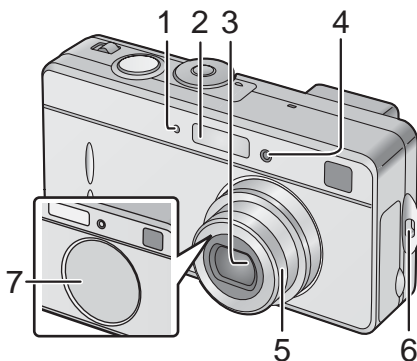

- 1 Flash Sensor (P33)
- 2 Flash
- 3 Lens
- 4 Self-timer Indicator (P35)
- 5 Lens Barrel
- 6 Strap Eyelet (P18)
- 7 Lens Cover

## [Top View]

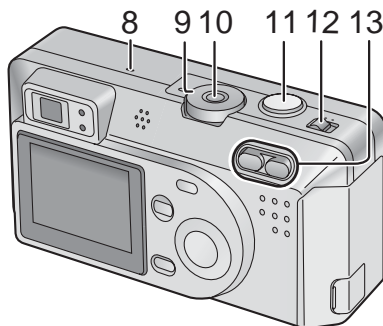

- 8 Microphone (P29, P36, P66)
- 9 Mode Dial (P22)
- 10 Single/Burst Mode Button (P52)
- 11 Shutter Button (P21)
- 12 Power Switch (P17)
- 13 Zoom Button (P30, P31)

## [Back View]

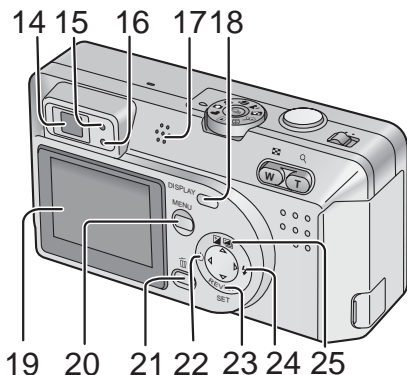

- 14 Optical finder (P20, P25)
- 15 Status Indicator (P17)
- 16 Flash/Access Indicator (P16, P17, P33)
- 17 Speaker (P54)
- 18 DISPLAY Button (P19)
- 19 LCD Monitor (P8, P19)
- 20 MENU Button (P23)
- 21 Delete Button (P28, P58)
- 22 ◀/Self-timer Button (P35)
- 23 ▼/REVIEW/SET Button (P28)
- 24 ▶/Flash Mode Button (P32)
- 25 ▲/Exposure Compensation (P45)
- / Auto Bracket Button (P46)

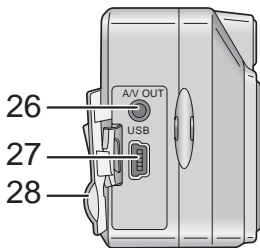

**[Left View]**

- 26 A/V OUT Socket (P76)
- 27 USB Socket (5pin) (P77)
- 28 Terminal Door

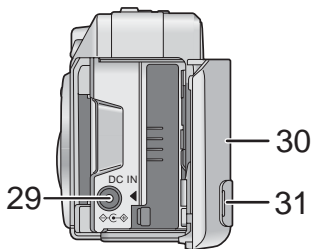

**[Right View]**

- 29 DC IN Socket (P14)
- 30 Memory Card/Battery Door (P12, P15)
- 31 DC IN Terminal Door (P14)

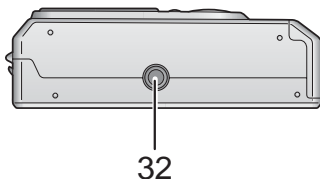

**[Bottom View]**

- 32 Tripod Receptacle

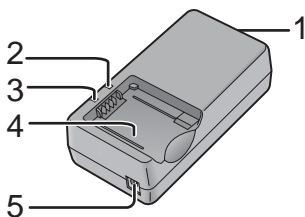

**[Battery Charger/AC Adaptor]**

- 1 AC Input Terminal
- 2 [POWER] Indicator
- 3 [CHARGE] Indicator
- 4 Battery Attachment Section
- 5 DC Output Terminal

# LCD Monitor Display

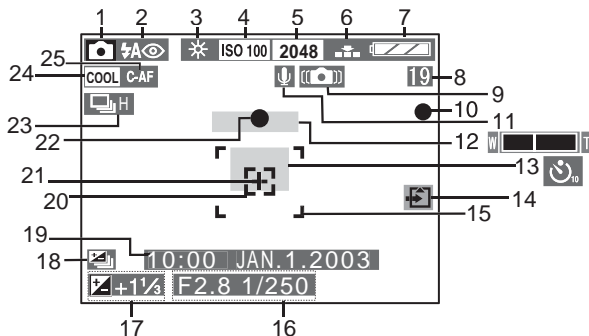

## [In recording]

- |    |  |    |  |
|----|--|----|--|
| 1  | REC mode (P22)   | 19 | Current date and time (P24)  |
| 2  | Flash mode (P32)   |    | • It is displayed for about 5 seconds after turning on the power or setting the clock. |
| 3  | White balance (P49)  | 20 | : Spot AF area (P44)   |
| 4  | ISO sensitivity (P51)  | 21 | : Spot metering target (P44)   |
| 5  | Picture size (P37)   | 22 | Focus indication (P25)   |
| 6  | Quality (data compression ratio) (P38)                                   | 23 | Burst mode (P52)   |
| 7  | Battery indicator (P13)<br>(When using AC adaptor this is not displayed) | 24 | Color Effect mode (P43)  |
| 8  | Frame/Time remain<br>In motion image mode: XXXs                          | 25 | Continuous AF (P34)  |
| 9  | Shutter Jiggle alert (P26)   |    |  |
| 10 | Recording indication   |    |  |
| 11 | Audio REC (P36)  |    |  |
| 12 | Zoom (P30, P31)<br>(digital zoom ON: )                                   |    |  |
| 13 | Self-timer mode (P35)  |    |  |
| 14 | Card access indication (P16)   |    |  |
| 15 | AF area (P25)  |    |  |
| 16 | Aperture indication/Shutter speed indication (P25)                       |    |  |
| 17 | Exposure compensation (P45)  |    |  |
| 18 | Auto bracket (P46)   |    |  |



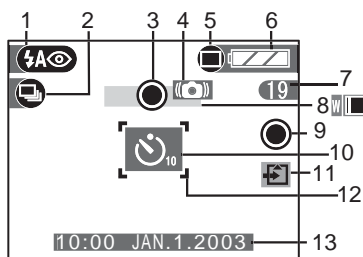

### [In recording in Simple mode]

- 1 Flash mode (P32)
- 2 Burst mode (P52)
- 3 Focus indication (P27)
- 4 Shutter Jiggle alert (P26)
- 5 Picture mode (P27)
- 6 Battery indicator (P13)
- 7 Frame remain
- 8 Zoom (P30)
- 9 Recording indication
- 10 Self-timer mode (P35)
- 11 Card access indication (P16)
- 12 AF area (P25)
- 13 Current date and time (P24)
  - It is displayed for about 5 seconds after turning on the power or setting the clock.

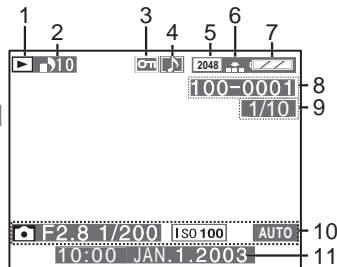

### [In playback]

- 1 Playback mode
- 2 DPOF (P60)
  - (White): DPOF setting for printing
  - (Green): DPOF setting for Slide Show
  - (Green with DPOF number): DPOF setting for printing and Slide Show
- 3 Protected image (P63)
- 4 Image with audio (P54)
- 5 Picture size (P37)
- 6 Quality (data compression ratio) (P38)
  - : In motion image mode
- In simple mode:
  - : ENLARGE
  - : 4" x 6" / 10 x 15cm
  - : INTERNET
- 7 Battery indicator (P13)
- 8 Folder/File number
- 9 Page/Total images
- 10 REC data
  - It will be displayed when the [DISPLAY] button is pressed.
- 11 Recorded date and time

# Quick Guide

## Preparation

Prepare following items

- Camera
- Battery
- Card
- AC adaptor
- AC cable

- Check that the power switch is set to [OFF] and the lens is stored.

## [Preparation]

- 1 **Charge the battery.** (① → ②) (P11)
  - Charging is finished in about 90 minutes.
- 2 **Slide the door in the direction of the arrow to open the Memory Card/battery door.**
- 3 **Insert the battery into the camera.** (P12)
- 4 **Insert the Card into the camera.** (P15)
- 5 **Close the Memory Card/battery door.**

## [Recording]

- 6 **Set the power switch to [ON].** (P17)
- 7 **Set date/time.** (P24)
- 8 **Set the mode dial to Normal picture mode [ ].** (P22)
- 9 **Take a picture.** (P25)

## [Playback]

- 10 **Set the mode dial to playback [ ].** (P53)
- 11 **Press ◀▶ to select the picture you want to view.**

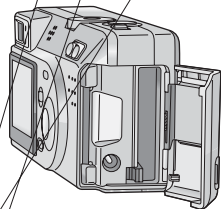
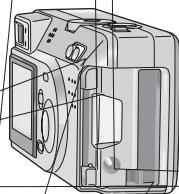
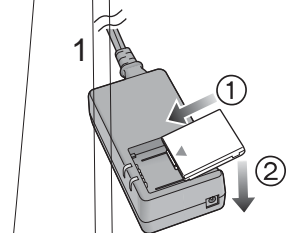

# Charging the Battery

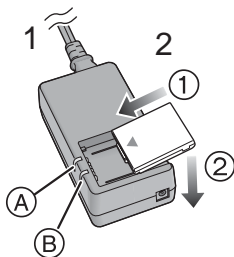

## 1 Connect the AC cable.

- The [POWER] indicator (A) lights.

THE SOCKET OUTLET SHALL BE INSTALLED NEAR THE EQUIPMENT AND SHALL BE EASILY ACCESSIBLE.

## 2 Attach the battery to the AC adaptor. (1 → 2)

- The [CHARGE] indicator (B) lights and charging starts.

## 3 When the [CHARGE] indicator (B) turns off, charging is finished.

- Charging is finished in 90 minutes.

## 4 Remove the battery from the AC adaptor.

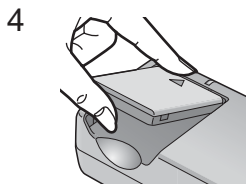
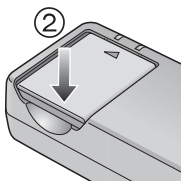
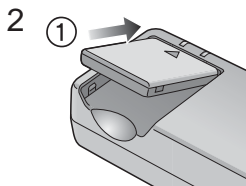

- **The battery cannot be charged when the DC cable is connected to the AC adaptor.**
- After use, be sure to disconnect the AC cable.
- The battery becomes warm after use/charge or during the charge. The camera also becomes warm during use. However, it is not malfunction.
- The battery/AC adaptor supplied with this camera is exclusively designed for this camera. Do not use with any other equipment.



### attery indicator

Remaining battery power is displayed on the LCD Monitor. (This is not displayed when using AC adaptor)



: The battery power is sufficient



: The remaining power is a little low



: The remaining power is low

: Recharge or replace the battery

### ■ Charging time and available recording time

Measured under the following conditions:

- Shooting once every 30 seconds, flash every other shot.
- Measured using supplied 16MB SD Memory Card.
- Temperature: 77 F (25°C)/Humidity: 60%

The times shown in the table are approximate times. The times may vary depending on the condition.

### ■ Charging environment and charging error

- Charge the battery in a place with a temperature of 50 F - 95 F (10°C - 35°C). (The battery should also be the same temperature)
- When charging starts, the [CHARGE] indicator lights. If, after charging starts, the [CHARGE] indicator blinks at about 1 second cycles, this indicates a charging error. In this case, remove the AC adaptor from the electrical outlet, remove the battery and check if both room and battery temperature is too low or high and then charge it again. If the problem persists, consult the dealer or your nearest servicerenter.

# Connecting to an Electrical Outlet

If you use an AC adaptor as indicated in 3, you can use the camera without worrying about battery discharge.

[Preparation]

- Check that the power switch is set to [OFF] and the lens is stored.

**1 Connect the AC cable.**

**2 Open the DC IN terminal door ①.**

- It is also possible to connect the DC cable to the camera with the Memory Card/battery door opened.

**3 Connect the DC cable (supplied) to the camera.**

- The camera becomes warm during use. However, this is not a malfunction.
- Disconnect the AC adaptor and DC cable when camera is not in use.
- The battery cannot be charged in the camera with the AC adaptor connected.
- Use the supplied DC cable.

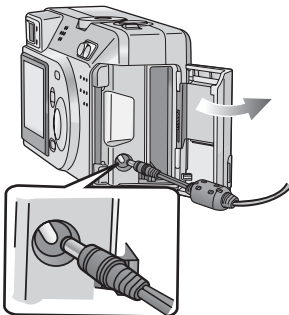
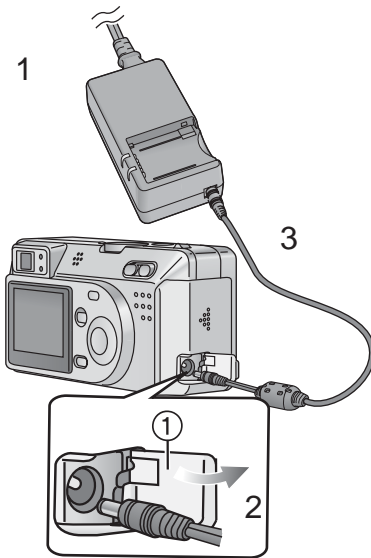



## ■ Access to the card

When the card is being accessed, the flash/access indicator ① and card access indication ② lights.

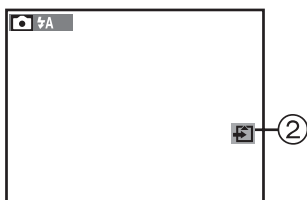
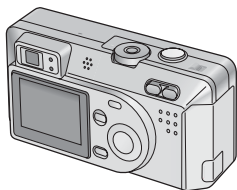

When the flash/access indicator ① and the card access indication ② lights;

- Do not turn off the camera.
- Do not remove the battery or pull out the card.
- Do not disconnect the DC cable when using the AC adaptor.

The card and the card contents may be destroyed and the camera may not operate normally.

As there is a risk that the data on the card may be damaged or erased due to the electrical noise, static electricity or the defects of camera/card, please back up your data on your PC using USB connection. (P77)

## ■ SD Memory Card (supplied) and MultiMediaCard (optional)

The SD Memory Card and MultiMediaCard are small, lightweight, removable external cards. The SD Memory Card is equipped with a write protection switch that can inhibit writing and formatting. (When the switch is moved towards the [LOCK] side, it is not possible to write or delete data on the card and format it. When the switch is unlocked, these functions become available.)

### SD Memory Card

- RP-SDH512 (512MB)
- RP-SDH256 (256MB)
- RP-SD128BJ (128MB)
- RP-SD064B (64MB)
- RP-SD032B (32MB)
- RP-SD016B (16MB)
- RP-SD008B (8MB)

### MultiMediaCard

- The reading/writing speed of MultiMediaCards is slower than SD cards. When MultiMediaCards are used, the performance of certain features may be slightly slower than advertised.
- After recording motion images using the MultiMediaCard, the flash/access indicator and the card access indication may appear for a while, but this is not a malfunction.<sup>19</sup>



# Turn

①



- When the power switch is turned on, the lens cover opens, [SYSTEM] indicator lights.
- When turning the lens cover close, the power switch is turned off.
- When turning on the power switch, do not put the lens cover on.

Set the power switch to

the Status indicator ① light

Set the power switch to



Indicator

turning the power sw

## Blinking

- When the camera is in the standby mode.
- When the camera is in the low power mode.
- When the camera is in the low power mode (blink slowly).

## Flash/Access

### Lighting:

- When accessing the camera.
- When the flash is on when the shutter is pressed.
- When sending data.

### Blinking:

- When charging the battery.
- When setting the flash to forced off and recording in dark places (blink slowly.)

# Attaching the Strap

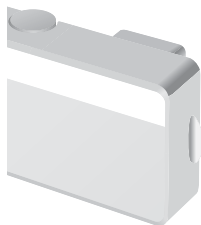

- 1 **Pass the top of the strap through the strap eyelet ①.**
- 2 **Pass the opposite side of the strap through its ring shaped part.**
- 3 **Pull the strap.**

# Using the LCD Monitor

Every time you press the [DISPLAY] button, the display of the LCD Monitor changes as shown below.

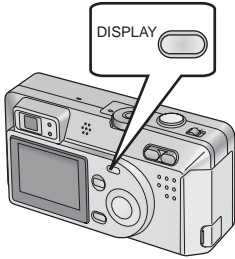

## [In recording]

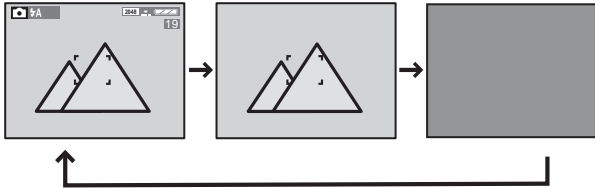

## [In playback]

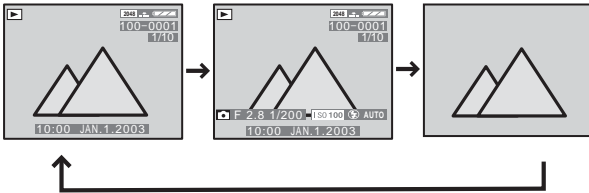

# Using the Optical Viewfinder

## Parallax compensation mark

- If you take a picture of the subject at a distance between 2.3 feet (70 cm) - 3.94 feet (120 cm) with the zoom in tele position, match the top and left of the subject with the parallax compensation mark ①, in order not to cut it. When an accurate framing is necessary, use the LCD monitor.

# The Shutter Button

## (Pressing halfway/Pressing fully)

The shutter button is activated in 2 steps: "pressing halfway" and "pressing fully".

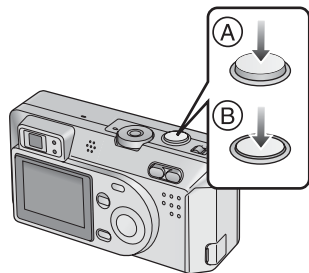

Pressing halfway (A)

- Focus and exposure are locked.

Pressing fully (B)

- The picture is captured. In motion image mode, the recording starts.

- You can adjust volume of the operational sound in the menu. (P72)
- If you press the shutter button fully in a single stroke, the captured picture may appear shaken or unfocused. (The camera may be moved during capturing)

# The Mode Dial

You can choose a desired mode by the mode dial.

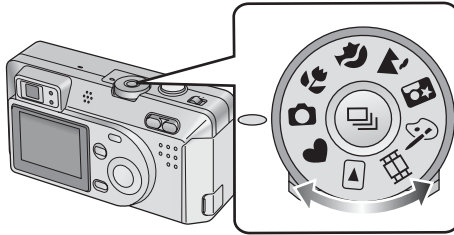

 : Playback (P53)

Playback recorded images.

 : Simple mode (P27)

Menu options are minimized and many settings are preset. This is a fast and easy way for beginners to start using the camera and become familiar with its many features.

 : Normal Picture (P25)

The shutter speed and the aperture value are automatically adjusted.

 : Macro mode (P39)

When you take pictures from a distance closer than 1.64 feet (50 cm), set the camera in macro mode. This allows you to get closer to the subject up to 0.98 feet (30 cm) (Tele), 0.33 feet (10 cm)(Wide).

 : Portrait mode (P40)

This mode allows you to easily achieve the depth of focus effect. The subject stands out in front of an unfocused background.

 : Landscape mode (P41)

You can capture sharp and crisp landscape photos easily. Please note that this mode is suitable for landscape farther than 32.8 feet (10 m) away and in daylight.

 : Night portrait mode (P42)

When you take pictures of, for example, your friends in front of beautiful night illumination scenery, this mode allows you to get the appropriate exposure for your subject as well as the background, using flash and slow shutter.

 : Color Effect mode (P43)

This function enables you to use color effects such as bluish, reddish, and black and white.

 : Motion images mode (P29)

Use this mode when recording motion images.

# Operating the Menu

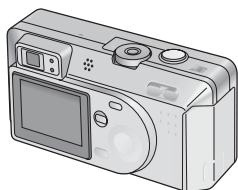

The camera menu allows you to configure the Record and Playback modes, date and time, and various other operational sounds the camera produces. Follow these instructions.

[Preparation]

- Set the mode dial to the recording mode (except for [ ] or the playback mode).

## 1 Press the [MENU] button.

- If you set the mode dial ① to the recording mode, the REC menu is displayed; if you set it to the playback mode, the playback menu is displayed.

## 2 Press ►.

## 3 Press ▲/▼ to choose the item.

## 4 Press ◀/▶ to set the item.

## 5 Press the [MENU] button.

- The menu will disappear.

# Setting the Date/Time (Clock Set)

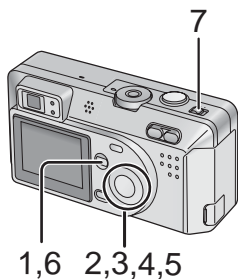

If the message [PLEASE SET THE CLOCK] appears, set the date and time.

You can go to the setup menu by pressing the [MENU] button while the message is displayed.

You can set the year from 2002 to 2099. The 24-hour system is used.

- 1 Press the [MENU] button.
- 2 Press ► to make the setup menu appear.
  - In simple mode, skip this step.
- 3 Press ▲/▼ to select [CLOCK SET], and then press ►.
- 4 Press ▲/▼/◀/▶ to set date and time, and then press ►.
- 5 Press ▲/▼ to select [M/D/Y], [D/M/Y] or [Y/M/D].
- 6 Press the [MENU] button twice.
  - The menu will disappear.
- 7 Check if the date/time setting is displayed correctly, after turning the camera [OFF] and [ON].

3

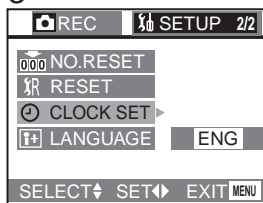

4,5

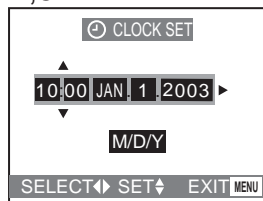

- After a fully charged battery is installed in the camera for at least one hour, the time and date will be held for approximately 24 hours if the battery is removed. If the battery was not fully charged the time may not be retained properly. If the time/date setting is lost please reset it.



# Taking Pictures

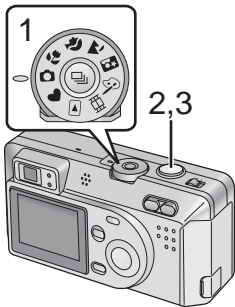

By only pressing the shutter button, the exposure (shutter speed and aperture value) will be automatically adjusted and the picture will be taken.

[Preparation]

- Insert the card. (P15)
- Set the power switch to [ON]. (P17)

**1 Set the mode dial to normal picture mode [📷].**

**2 [A Optical finder]**

**Centre the subject in the AF target ① inside the optical finder and press the shutter button halfway.**

**[B LCD monitor]**

**After centering the subject in the AF area ② on the LCD Monitor, press the shutter button halfway.**

- When the focus is adjusted, the focus indication [●] ③ appears.
- When the focus indication flashes, the focus is not adjusted. Press the shutter button halfway to adjust the focus again.
- The shutter speed and the aperture value ④ are automatically adjusted and displayed on the LCD Monitor.
- When the subject is out of the AF area, use the AF/AE lock. (P47)

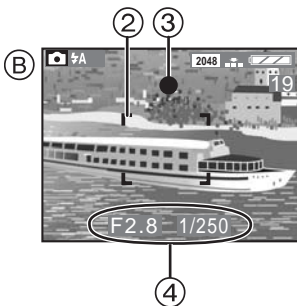
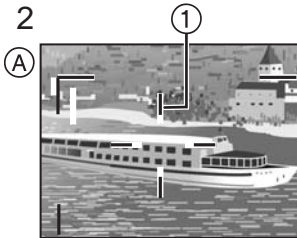

**3 Press the shutter button fully to take the picture.**

- After taking a picture, when the auto review (P71) is set to [1 SEC.]/[3 SEC.], the picture is displayed on the LCD Monitor for 1 or 3 seconds.

- If you do not press the shutter button halfway, shutter jiggle may occur or the focus may not be adjusted properly.
- Even when the focus indication is displayed and the focus is properly adjusted, it will be cancelled if you release the shutter button.  
Press the button halfway again.
- When power saving time is set, if you do not operate the camera for a while, it is automatically turned off at the set time. To operate the camera again, press the shutter button or turn the power switch first to [OFF] and then to [ON]. (P73)
- The brightness of the LCD Monitor may differ from that of the recorded pictures. In particular, when taking pictures in dark places with a long time exposure, darkness appears on the LCD Monitor, but the recorded pictures are bright.
- If the exposure is not properly set, the color of the aperture value and the shutter speed on the LCD monitor becomes red.
- In the following cases, the focus may not be adjusted properly.
  - 1 Recording a scene including subjects both near and far
  - 2 Recording a scene through dirty glass
  - 3 Recording an illuminated subject
  - 4 Recording in a dark place
  - 5 Recording moving subject
  - 6 Recording a subject with a little contrast
  - 7 Recording with shutter jiggle
- We recommend that you set the clock setting again before taking pictures.
- When the brightness of the LCD monitor changes such as while zooming or panning, you may hear a click sound from the lens or the image on the LCD monitor may change suddenly; this is not a malfunction. The sound is caused by the camera automatically adjusting the aperture value.
- When pressing the shutter button in low light/dark conditions, the LCD monitor display may become bright or whitish. However, the recorded picture will not be influenced. This function make it easy to adjust the focus.

## About shutter jiggle

- Be careful to prevent shutter jiggle when you press the shutter button.
- When the shutter jiggle can easily occur, the shutter jiggle alert ① appears.
- We recommend you use a tripod when the shutter jiggle alert appears.

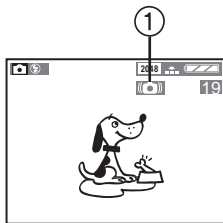



# Checking the Captured Picture (Review)

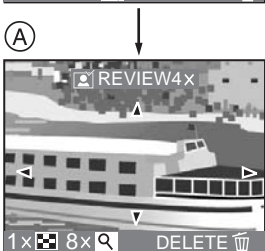
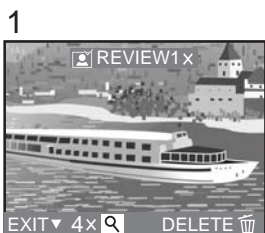
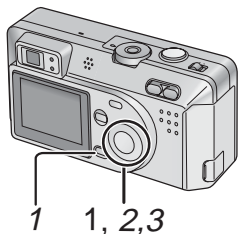

After taking a picture, the Auto review (P71) feature will cause the captured picture to be displayed on the LCD monitor for the designated time - 1 or 3 seconds. You may also check the picture using the method described below.

## 1 After taking a picture, press the ▼/[REVIEW/SET] button.

- The last captured picture is displayed for about 5 seconds. Press the zoom button [Q], the captured picture is zoomed 4 times (A) and 8 times if you press it once again. You can also change the position with ▲/▼/◀/▶.
- You can check the previous or following picture with ◀/▶.

## Erasing the captured picture during the review

### 1 Press [DELETE].

### 2 When the message [DELETE THIS PICTURE?] is displayed, press ◀/▶ to select [YES].

### 3 Press the ▼/[REVIEW/SET] button.



- The picture is erased.
- Once erased, pictures cannot be recovered.

- In motion image mode [MOV], Review cannot be used.

# Recording Motion Images

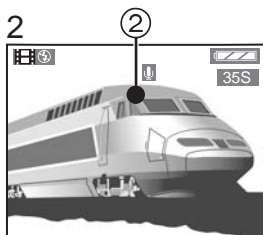
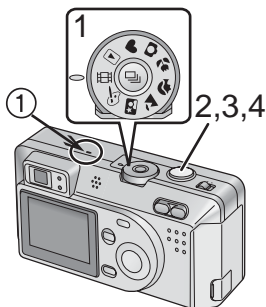
With this camera you can also record motion images. (If using the supplied 16MB SD Memory Card, it is possible to record for up to about 80 seconds)



- 1 **Set the mode dial to motion image mode [  ].**
- 2 **Center the subject on the LCD Monitor and press the shutter button halfway.**
  - When the focus is adjusted, the focus indication ② [  ] appears.
- 3 **By pressing the shutter button fully, the recording starts.**
  - The audio REC starts simultaneously. (① Microphone)
- 4 **By pressing the shutter button fully again, recording stops.**
  - If during the recording the memory of the card becomes full, the recording is stopped automatically.

- The picture size is fixed to 320 × 240 pixels.
- The remaining time displayed on the LCD Monitor is an approximation.
- You cannot record motion images without audio.
- If using the MultiMediaCard, after recording motion images, the card access indication and the flash/access indicator may appear for a while, but this is not a malfunction.
- After recording starts, the auto focus/zoom/white balance/aperture values are locked (with the first frame).
- Recording could suddenly stop when recording motion images with cards other than a Panasonic SD Memory Card.
- When the motion image recorded with this camera is played back on other equipment, the quality of pictures and sounds may be deteriorated or pictures may not be able to be played back.
- In motion image mode [  ], review cannot be used.

# Using the Optical Zoom

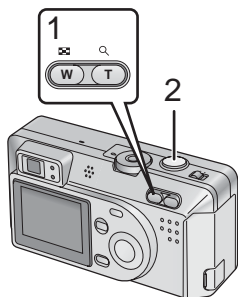

The Optical Zoom allows you to bring your subject up to 3 times closer. It also allows you to zoom back so that landscape scenes can be photographed at a wide angle.

[Preparation]

- Set the mode dial except for [📹]. (P22)

**1 Aim the camera at the subject and adjust the size with the zoom button.**

**To make subjects closer (Tele):**

**Press the zoom button (T).**

**To make subjects wider (Wide angle):**

**Press the zoom button (W).**

**2 Take a picture.**

- The recording method is the same as in "Taking Pictures". (P25)

- The focus is adjusted at a distance of more than 1.64 feet (50 cm). For details on simple mode/macro mode/color effect mode, read P27/P39/P43.

- The picture may be slightly distorted according to the lens. The distortion will increase as you make subjects wider and closer.

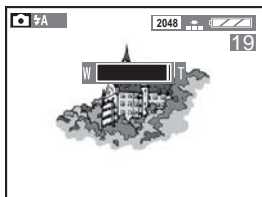
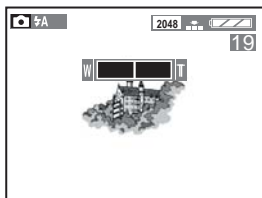
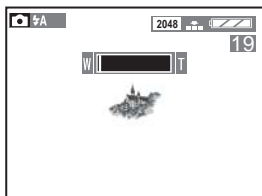

# Using the Digital Zoom

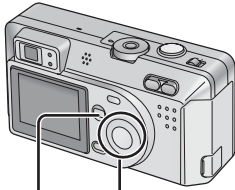

1,4 2,3

2,3

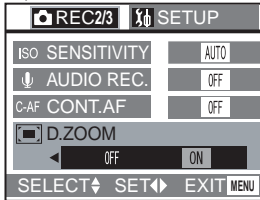

The Digital Zoom feature allows you to bring the subject an additional 3 times closer, thereby achieving an overall effective 9× zoom. In some cases the use of Digital Zoom can cause a slight deterioration of picture quality.

[Preparation]

- Set the mode dial except for [ ]/[ ]. (P22)

- 1 Press the [MENU] button.
- 2 Press ▲/▼ to select [D.ZOOM].
- 3 Press ◀/▶ to set to [ON].
- 4 Press the [MENU] button.

- The menu will disappear.

- The zoom adjustment and recording method are the same as in "Using the Optical Zoom". (P30)
- When the digital zoom is set to [ON], the digital zoom indication ① appears.
- When entering the digital zoom range, the zoom bar will pause.

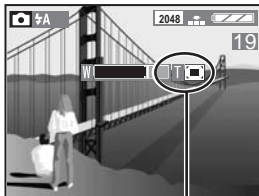

①

- When using the digital zoom the picture quality becomes deteriorated.
- We recommend that you use a tripod in the digital zoom range.

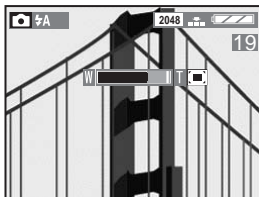

# Taking Pictures using the Built-in Flash

[Preparation]

- Set the mode dial except for [📹] [📺] [📷] [📷]. (P22)

## 1 Press [⚡].

- Every time you press [⚡], the available settings will appear as shown below. (There are settings that cannot be set according to the REC mode. Those that cannot be set are not displayed when pressing [⚡]. Refer to the table on the left.)

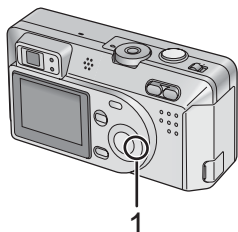

	⚡A	⚡A👁️	⚡	⚡S👁️	🌐
📷	○	○	○	○	○
♥	—	○	○	—	○
🌿	○	○	○	○	○
👉	○	○	○	—	○
📺	—	—	—	—	○
📷	—	—	—	○	○
👁️	○	○	○	○	○
📷	—	—	—	—	○

**⚡A** : AUTO

The flash fires automatically according to the lighting condition.

**⚡A👁️** : AUTO/Red-eye reduction

The flash fires automatically according to the recording situation.

It reduces the red-eye phenomenon (When a subject's eyes appear red in flash light).

Use it when you take pictures of people or animals in low lighting conditions.

**⚡** : Forced ON

The flash fires every time a picture is captured.

Use this setting when your subject is back-lit or under fluorescent light.

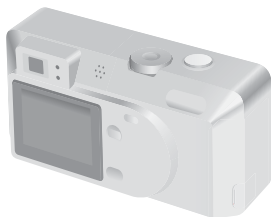

 : Slow sync./Red-eye reduction

When you take a picture with a dark background landscape, it makes the flash fire and the shutter speed slow, so that the dark background landscape will become bright. Simultaneously it reduces the red-eye phenomenon. We recommend that you use a tripod.

 : Forced OFF

Even in dark places, the flash does not fire. Set it when you take pictures in places where using flash is not allowed.

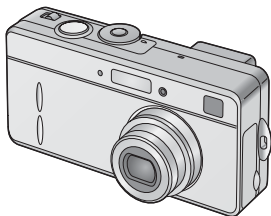

## 2 Take a picture.

- The recording method is the same as in "Taking Pictures". (P25)

- Do not stare at the flash light from close proximity when using the flash.
- The available flash range is about 0.98 feet (30 cm) - 4.59 feet (140 cm)(Tele), 0.98 feet (30 cm) - 7.87 feet (2.4 m)(Wide). (When setting to ISO100)
- When the shutter jiggle alert is displayed within the available flash range, we recommend using the flash.
- Do not cover the flash sensor ① with your fingers or other items. Otherwise, brightness cannot be perceived.
- In landscape mode [ ]/motion image mode [ ], the flash setting is fixed to the Forced OFF [ ].
- When you set to burst mode or auto bracket, only 1 picture is taken for every flash firing.
- The flash indication becomes red when pressing the shutter button halfway.
- When the flash/access indication ② and the flash indication blink red, you cannot take a picture even when you press the shutter button fully.
- When using the flash, do not let subjects get too close to the flash. The shape or color of subjects may be changed because of the heat and light of the flash.
- When taking a picture with the flash, the white balance will be automatically adjusted (except for manual white balance setting), but the white balance may not be properly adjusted when the Photo Flash is insufficient.
- When taking a picture with the flash after setting the white balance manually, the white balance may not be properly adjusted. We recommend setting the white balance to [AUTO] when using the flash. (P49)

# Using the Continuous AF

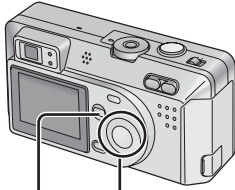

1,4 2,3

2,3

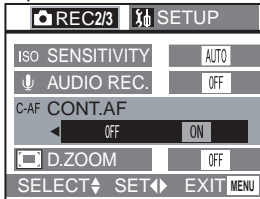

4

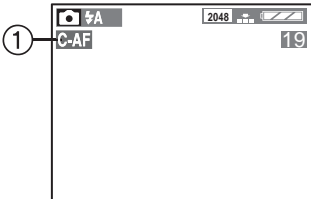

This function allows you to reduce the time required for focusing, as AF is continuously working without the need to press the shutter button every time.

[Preparation]

- Set the mode dial to [🌸]. (P22)

- 1 Press the [MENU] button.
- 2 Press ▲/▼ to select [CONT.AF].
- 3 Press ◀/▶ to select [ON].
- 4 Press the [MENU] button.

- The menu will disappear.
- The indication [C-AF] ① will appear.

- In all modes except for [🌸], [CONT.AF] is fixed to [OFF].
- The battery is depleted more quickly using continuous AF.
- It may take time to adjust the focus after zooming out (Wide → Tele) or suddenly changing the subject of shooting from distant subjects to nearby subjects.
- Press the shutter button halfway again to adjust the focus when it is difficult to adjust the focus.

# Taking Pictures with the Self-timer

Using the Self Timer feature, you can be part of the picture. The camera will automatically take a photo either 2 or 10 seconds after the shutter button is pressed.

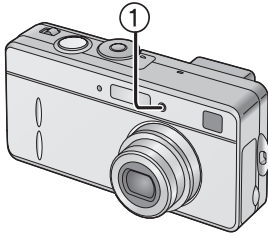

[Preparation]

- Set the mode dial except for [📹]/[📷]. (P22)

## 1 Press the [🕒] button.

- Every time you press it, what is displayed changes as shown below.



 : Self-timer set to 10 seconds

 : Self-timer set to 2 seconds

When these indicators are not displayed, self-timer setting is cancelled.

## 2 Press the shutter button fully.

- The self-timer indicator ① blinks and the shutter is activated after 10 seconds (or 2 seconds).
- When setting the self-timer, the focus and exposure are not adjusted by pressing the shutter button halfway. When pressing the button fully, they are automatically adjusted just before recording.
- If you press the [MENU] button when the self-timer is set, the self-timer setting is cancelled.

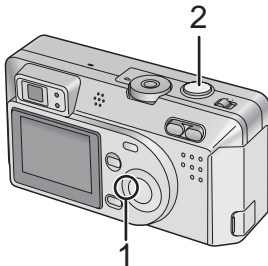

- In simple mode [♥], you can only set to 10 seconds [].
- In burst mode, the self-timer setting applies to the first picture only.
- We recommend using a tripod when setting the self-timer.



## Picture Size

You can choose among 4 picture size settings.

[Preparation]

- Set the mode dial except for [ ] [ ] [ ] [ ] (P22)

- 1 **Press the [MENU] button.**
- 2 **Press ▲/▼ to select [PICT.SIZE].**
- 3 **Press ◀/▶ to select the picture size.**
  - : 2048 × 1536 pixels
  - : 1600 × 1200 pixels
  - : 1280 × 960 pixels
  - : 640 × 480 pixels
- 4 **Press the [MENU] button.**
  - The menu will disappear.

picture size is fixed to 320 × 240 pixels.

select, the more pictures you can store on the Memory  
volume allows you to attach the picture to an e-mail or post it

the printed picture will be clearer, especially with larger

# Changing the Quality (Data Compression Ratio)

You can choose among 2 quality levels (Data Compression Ratio).

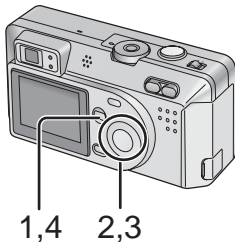

2,3

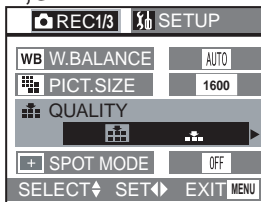

[Preparation]

- Set the mode dial except for [RECORDING] / [LOCK] / [P22].

- 1 Press the [MENU] button.
- 2 Press ▲/▼ to select [QUALITY].
- 3 Press ◀/▶ to select the quality (Data Compression Ratio).

- [FINE] : Fine (Low compression)  
It gives priority to picture quality to record high quality pictures.
- [STANDARD] : Standard (Standard compression)  
It gives priority to the number of recordable pictures and records standard quality pictures.

- 4 Press the [MENU] button.

- The menu will disappear.

- Picture size/Quality and number of recordable pictures (16MB/64MB SD Memory Card)

Picture size	16MB (supplied)		64MB (optional)	
	[FINE]	[STANDARD]	[FINE]	[STANDARD]
2048 × 1536	10	20	45	88
1600 × 1200	17	34	74	149
1280 × 960	22	43	96	184
640 × 480	69	129	298	553
In motion image mode	80 seconds		350 seconds	

- The numbers shown in the table are approximate numbers. If you mix fine quality and standard quality, the number of recordable pictures changes.
- It may happen that pictures appear like a mosaic depending on the scene characteristics.
- Remaining frame which is displayed on the LCD Monitor may not correspond with recorded frames, however, this is not a malfunction.

# Taking Pictures using Macro Mode

When you take pictures from a distance closer than 1.64 feet (50 cm)(Tele), set the camera in macro mode [🌸]. This allows you to get closer to the subject up to 0.33 feet (10 cm)(Wide).

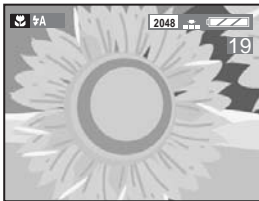
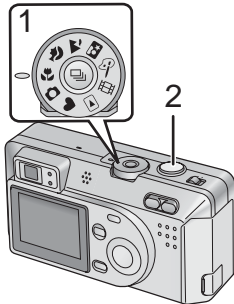

## • Macro Mode [🌸]

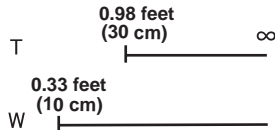

## • Normal recording

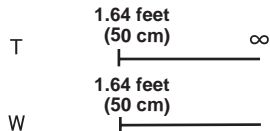

### 1 Set the mode dial to Macro mode [🌸].

### 2 Take a picture.

- The recording method is the same as in "Taking Pictures". (P25)

- Select the flash setting depending on the situation. (P32)
- The available flash range is about 0.98 feet (30 cm) - 4.59 feet (140 cm)(Tele), 0.98 feet (30 cm) - 7.87 feet (2.4 m)(Wide). (When setting to ISO100)
- When the shutter jiggle alert is displayed within the available flash range, we recommend using the flash.
- When the camera lens is at a distance over the available range from the subject, focus may not be adjusted even if the focus indication appears.
- When selecting the macro mode, optical finder functionality is limited. Use the LCD monitor.

# Taking Pictures using Portrait Mode

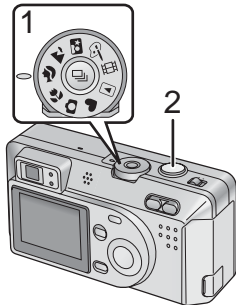

This mode allows you to easily achieve the depth of focus effect. The subject stands out in front of an unfocused background.

We recommend placing the subject much closer and allowing for proper distance between subject and background.

Please note that this mode is suitable for outdoor situations under sunlight.

1 **Set the mode dial to Portrait mode [P].**

2 **Take a picture.**

- The recording method is the same as in "Taking Pictures". (P25)



- White balance is set to [AUTO] in the default position. You can change the setting. (P49)





# Taking Pictures using Night Portrait Mode

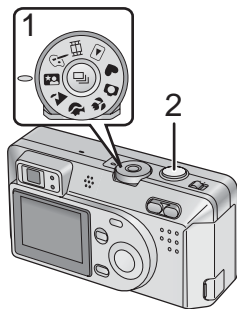

The Night Portrait mode combines the electronic flash with a “slow shutter” mode. This unique feature allows you to photograph close subjects against the natural night background. Since the shutter speed is slow, we highly recommend using a tripod to steady the camera.

The subject should be positioned within the available flash range. When setting to ISO100, (Tele: 0.98 feet (30 cm) - 4.59 feet (140 cm), Wide: 0.98 feet (30 cm) - 7.87 feet (2.4 m)) .

We recommend pressing the zoom button (W) before taking a picture.

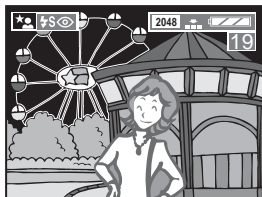

- 1 **Set the mode dial to Night portrait mode [🌙].**
- 2 **Take a picture.**

- The recording method is the same as in “Taking Pictures”. (P25)

- White balance is set to [AUTO] in the default position. You can change the setting. (P49)
- When flash is set to Forced OFF [🚫], you can capture the night illumination scenery itself with slower shutter speed. (Max: about 8 seconds)
- When taking a picture in a dark place, noise may appear. To avoid noise, we recommend setting the picture adjustment to [NATURAL]. (P48)

# Taking Pictures using Color Effect Mode

This function enables the use of color effects such as bluish, reddish, and black and white.

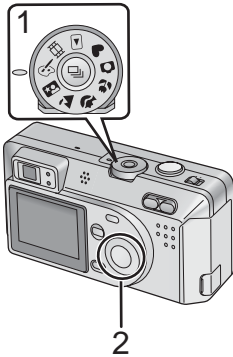

1 **Set the mode dial to Color effect mode**  
[👁️].

2 **Press ▼/◀/▶ to select, [COOL], [WARM] or [B/W].**

- **COOL:**  
The picture becomes bluish.
- **WARM:**  
The picture becomes reddish.
- **B/W:**  
The picture becomes black and white.

- The indication [COOL / WARM / B/W] ① will appear.
- Press the [MENU] button to set again.

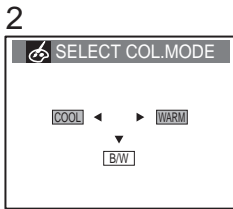

- The focus is adjusted at a distance of 0.98 feet (30 cm) - ∞(Tele), 0.33 feet (10 cm) - ∞ (Wide).
- Press the [MENU] button twice to display the normal menu.

# Taking Pictures using Spot Mode

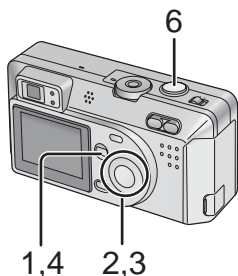

2,3

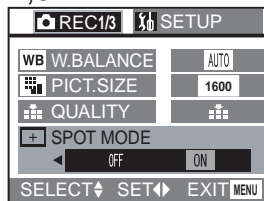

4

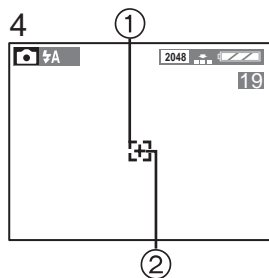

When this mode is selected, both the focus and the exposure will be adjusted to spot on a limited area. This is suitable when you take pictures in delicate light conditions and intend to take a picture of a specific area.

[Preparation]

- Set the mode dial except for [RECORDING] [HEART] [GRID]. (P22)

- Press the [MENU] button.
- Press ▲/▼ to select [SPOT MODE].
- Press ◀/▶ to select [ON].
- Press the [MENU] button.

- The menu will disappear.
- The spot AF area [ ] ① and spot metering target + ② appears.

- Center the subject in the spot AF area.
  - Take a picture.
- The recording method is the same as in "Taking Pictures". (P25)

- When the subject is dark, the focus may not be adjusted properly.
- Background may become dark or whitish depending on the subject which is being set to the appropriate exposure in the spot AF area.
- If the subject is out of the spot AF area, use the AF/AE lock. (P47)



# Taking Pictures using Auto Exposure (AE) Bracket

Pressing the shutter button once, the camera will automatically take 3 pictures changing exposure according to the set exposure compensation value.

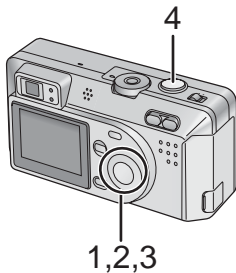

[Preparation]

- Set the mode dial except for [📹]/[❤️]/[📷]. (P22)

- 1 Press the [📷] button twice to select [📷] AUTO BRACKET.
- 2 Press ▶, then press ◀/▶ to set the exposure compensation range.

- OFF
- -1 EV - +1 EV (1/3 EV step)

- 3 Press the ▼/[REVIEW/SET] button.

- The compensation window will close.
- The auto bracket indication ① appears.

- 4 Take a picture.

- The recording method is the same as in "Taking Pictures". (P25)

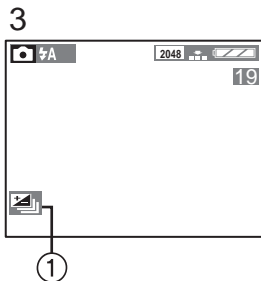
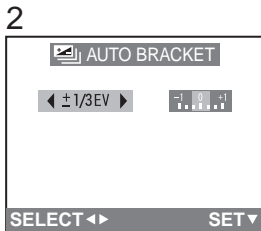

- Once you take a picture, auto bracket will be cancelled automatically.
- When flash fires, you can take only 1 picture.
- When setting auto bracket, you cannot take a still picture with audio.
- When setting auto bracket and the burst mode simultaneously, auto bracket will be performed.

# Using the AF/AE Lock

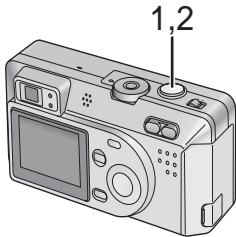

Normally, the camera focuses in the center area of the picture. Depending on how you compose the photo, your subject may not be in the center. Using AF/AE Lock you can focus on your subject, reposition the camera, and the camera will maintain proper focus.

AF: Auto focus

AE: Auto exposure

[Preparation]

- Set the mode dial except for [📹]. (P22)

**1 Aim the camera at the subject on which you want to adjust the focus to enter the AF area ② on the LCD Monitor and then keep pressing the shutter button halfway (AF/AE lock).**

- When the focus is adjusted, the focus indication ① [●] appears.

**2 Move the camera keeping the chosen composition and press the shutter button all the way.**

- Before pressing the shutter button, you can set the AF/AE lock again and again.

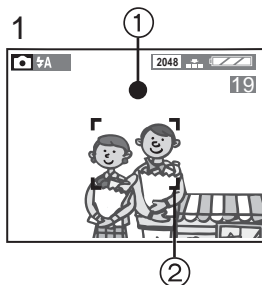

# Picture Adjustment (Natural/Standard/Vivid)

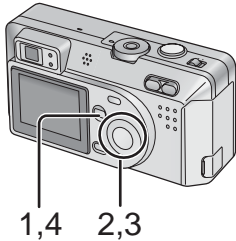

REC 3/3 | SETUP

[Preparation]

- Set the mode dial except for [📺]/[❤️]/[📷]. (P22)

- 1 Press the [MENU] button.
- 2 Press ▲/▼ to select [PICT.ADJ.].
- 3 Press ◀/▶ to select [NATURAL], [STANDARD] or [VIVID].

- [NATURAL]: The picture becomes softer.
- [VIVID]: The picture becomes sharper.

- 4 Press the [MENU] button.

- The menu will disappear.

- When using Vivid mode in low light situations it is possible that a slight increase in color noise will be seen. Proper lighting is recommended.



# Setting the White Balance

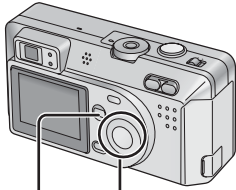

1,4 2,3

2,3

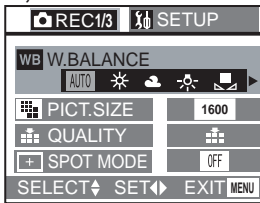

Auto White Balance is designed to automatically adjust the camera to produce natural flesh tones. In most situations it works fine. In some situations where several different types of lighting are present, enhanced performance can be achieved by setting the white balance manually.

## [Preparation]

- Set the mode dial except for [▶][♥][📷]. (P22)

- 1 Press the [MENU] button.
- 2 Press ▲/▼ to select [W.BALANCE].
- 3 Press ◀/▶ to select the mode.

- AUTO:  
if the auto white balance is set
  - ☀ (Daylight):  
for recording outdoors on a bright day
  - ☁ (Cloudy):  
for recording under a cloudy and shady sky
  - 📷 (Halogen):  
for recording under halogen lighting
  - 📷 (White set):  
for manual setting (Read the following page where the manual setting is explained in detail)
- 4 Press the [MENU] button.
    - The menu will disappear.

- The setting of the white balance is applied to the other recording modes.
- In simple mode [♥] or motion image mode [📷], the white balance is fixed to [AUTO].
- When taking a picture with the flash, the white balance will be automatically adjusted (except for manual white balance setting), but the white balance may not be properly adjusted when the flash light is insufficient.

Here the white set mode of white balance is explained.

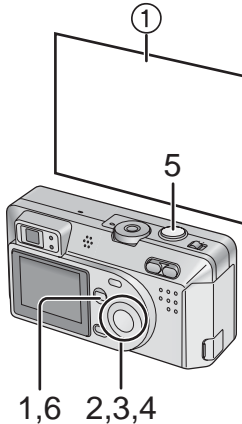

2,3

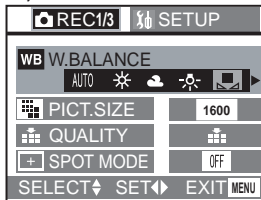

4

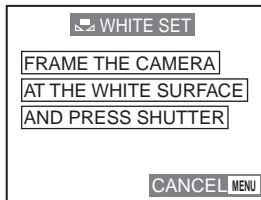

[Preparation]

- Set the mode dial except for [ ]/[ ]/[ ]/[ ]. (P22)

- 1 Press the [MENU] button.
- 2 Press ▲/▼ to select [W.BALANCE].
- 3 Press ◀/▶ to set to white set [ ].

Only when setting the white balance again

- 4 Press ▶.

- The message "FRAME THE CAMERA AT THE WHITE SURFACE AND PRESS SHUTTER" is displayed.

- 5 Aim the camera at a sheet of white paper ① or similar object so that it completely fills the frame to white on the screen and press the shutter button all the way.

- White balance is set.

- 6 Press the [MENU] button.

- The menu will disappear.

- When taking a picture with the flash after setting the white balance manually, the white balance may not be properly adjusted. We recommend setting the white balance to [AUTO] when using the flash.

# Setting ISO Sensitivity

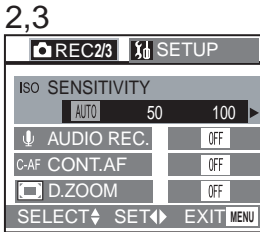
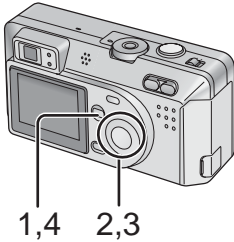

The ISO setting adjusts the camera's sensitivity to light. Generally, the lower the ISO setting, the better the picture quality will be. Increasing the ISO value will make the camera more sensitive in low light.

[Preparation]

- Set the mode dial except for [RECORDING MODE] [P22].

- 1 Press the [MENU] button.
- 2 Press ▲/▼ to select [SENSITIVITY].
- 3 Press ◀/▶ to select the sensitivity.

- AUTO: The ISO sensitivity is automatically adjusted. If your picture is still too dark, please use the flash.

- **50** ISO50
- **100** ISO100
- **200** ISO200
- **400** ISO400





- 4 Press the [MENU] button.

- The menu will disappear.

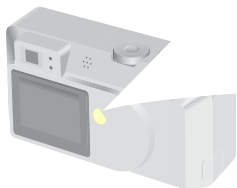
- In motion image mode [RECORDING MODE] or simple mode [SIMPLE MODE], ISO sensitivity is fixed to [AUTO].
- When you take a picture in high ISO sensitivity, picture noise appears and the picture quality deteriorates.

# Taking Pictures using Burst Mode



			
 H	4 frames/ second	5 frames	8 frames
 L	2 frames/ second	5 frames	8 frames

[Preparation]

- Set the mode dial except for [ ]/[ ]. (P22)

## 1 Press [ ].

- Every time you press it, what is displayed changes as shown below.

 : High speed

 : Low speed

When these indicators are not displayed, burst mode is cancelled.

## 2 Press the shutter button halfway to lock the focus, then press it fully to take pictures in sequence.

- It is possible to record 4 frames in 1 second in burst mode, at a shutter speed higher than 1/60, but the flash does not fire simultaneously.
- If the flash fires, it is possible to record only 1 frame.
- In simple mode [ ], the shutter speed is fixed to the low speed. (P27)
- You cannot take still pictures with audio in the burst mode.
- When setting auto bracket and the burst mode simultaneously, auto bracket will be performed.
- Burst mode will not perform as described if a MultiMediaCard is used in place of SD Memory Card. The reading/writing speed of MultiMediaCard is slower than SD Memory Card.

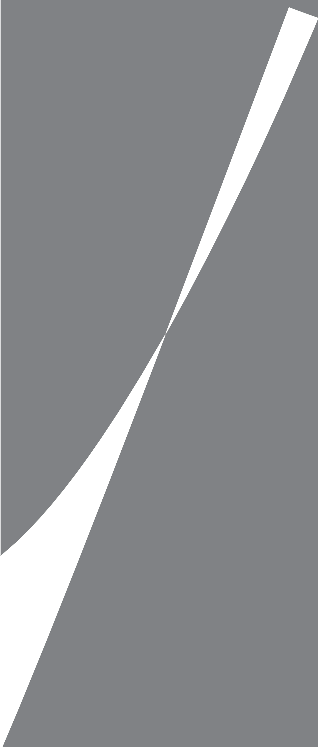

# Playing Back Still Pictures with Audio

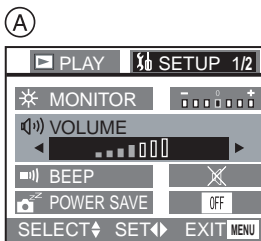
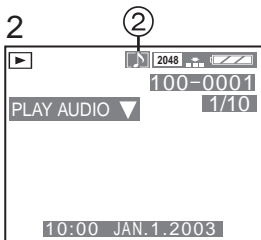
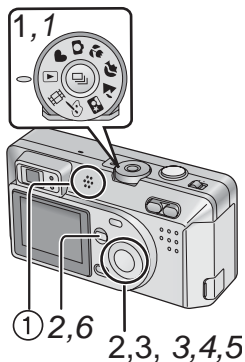

- 1 Set the mode dial to playback [▶].
- 2 Press ◀▶ to select the file with audio icon [▶] ②.
- 3 Press the ▼/[REVIEW/SET] button to play back the audio.
  - You can hear audio from the speaker ①.

## ■ To adjust the sound volume ①

- 1 Set the mode dial to playback [▶].
- 2 Press the [MENU] button.
- 3 Press ▶ to select the setup menu.
- 4 Press ▲/▼ to select [VOLUME].
- 5 Press ◀▶ to adjust the sound volume.
- 6 Press the [MENU] button.
  - The menu will disappear.

# 9 Images Multi Playback

It is possible to display 9 images at once.

[Preparation]

- Set the mode dial to playback [  ]. (P22)

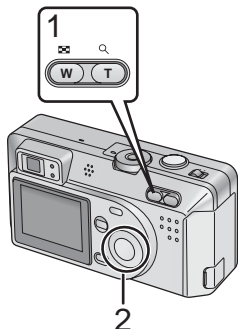

- 1 **During playback, press the zoom (W) button [  ].**

- Multi playback (9 frames) starts.

- 2 **Press  /  /  /  to select images.**

- To return to the normal indication, press the zoom button [  ]. The image with the file number colored in yellow is displayed.

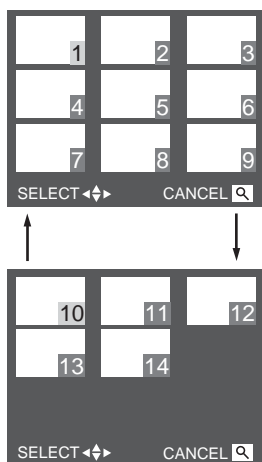

# Using the Playback Zoom

During playback it is possible to enlarge pictures. (2 times/ 4 times/ 8 times/ 16 times)

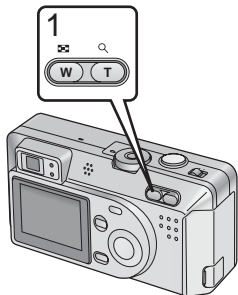

[Preparation]

- Set the mode dial to playback [▶]. (P22)

## 1 During playback, press the zoom (T) button [Q].

- To enlarge further, press the zoom (T) button [Q] again.
- To reduce the picture, press the zoom (W) button [⏪].
- Use ▲/▼/◀/▶ to change the area to be enlarged.

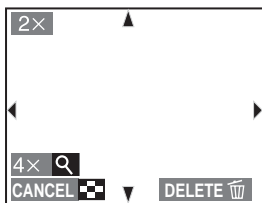

## ■ To delete a picture during the playback zoom

Press [🗑].

When this message is displayed “DELETE THIS PICTURE?”, press ◀/▶ to select [YES], and press the ▼/[REVIEW/SET] button. (P58)

- The more the zoom magnification increases, the more the picture quality deteriorates.
- The playback zoom may not operate if pictures have been recorded with other equipment.



# Playing Back Motion Images

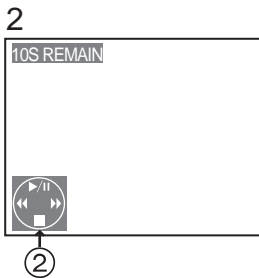
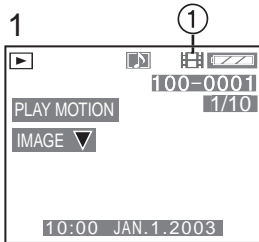
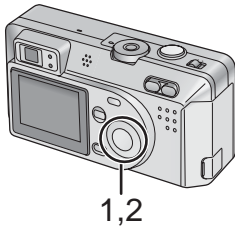

## [Preparation]

- Set the mode dial to playback [▶]. (P22)

- 1 Press ◀▶ to select the file with the motion image icon [📷] ①.
- 2 Press the ▼/[REVIEW/SET] button to play back the motion image.

- By pressing ▼, motion image playback will stop.
- The icon ② is corresponding to the ▲/▼/◀▶ button.

## [Fast forwarding/Fast rewinding]

During motion image playback, continue pressing ◀▶.

- ▶: Fast forward
- ◀: Fast rewind

- When releasing the button, it turns to normal motion image playback.

## [To pause]

Press ▲ during motion image playback.

- Press ▲ again to cancel pause.

■ To adjust the sound volume (P54)

- The play back zoom cannot be used while playing back motion images.
- The file format that can be played back with this camera is QuickTime Motion JPEG.
- It could happen that the Motion JPEG file recorded by a PC or other equipment cannot be played back with this camera.
- When playing back motion images that have been recorded with other equipment, the quality of images may be deteriorated or images may not be able to be played back.
- When using a high capacity Memory Card, it is possible that fast rewinding may be slower.

# Deleting Images

Images recorded on the card can be deleted. Once deleted, images cannot be recovered.

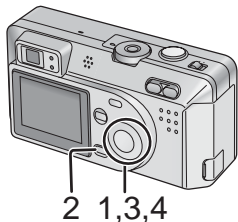

2



## [Preparation]

- Set the mode dial to playback [▶]. (P22)
- When an image is protected, it cannot be deleted. Cancel the protect setting. (P63)

## [Delete single image]

- 1 Press ◀/▶ to select the image to be deleted.
- 2 Press [🗑️].
- 3 Press ◀/▶ to select [YES].
- 4 Press the ▼/[REVIEW/SET] button.
  - The selected image is deleted.

**[Delete multi images]**

It is possible to delete up to 50 images all at once.

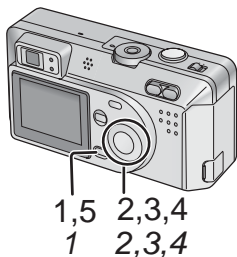

2,2

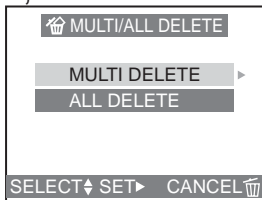

3,4

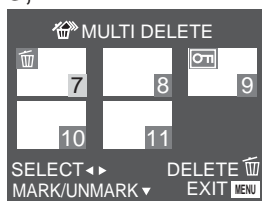

6



3



- 1 Press [ ] twice.
- 2 Press ▲/▼ to select [MULTI DELETE] and then press ►.
- 3 Press ◀/▶ to select the images to be deleted.
- 4 Press the ▼/[REVIEW/SET] button.

- The selected images are displayed with [ ]. Pressing the ▼/[REVIEW/SET] button again, the setting is cancelled.
- The indication [On] blinks red if the selected image is protected. Cancel the protect setting. (P63)

- 5 Press [ ].
- 6 When this message is displayed "DELETE THE PICTURES YOU MARKED?", press ◀/▶ to select [YES].
- 7 Press the ▼/[REVIEW/SET] button.

- The selected multi images are deleted all at once.

**[Delete all images]**

Once deleted, images cannot be recovered.

- 1 Press [ ] twice.
- 2 Press ▲/▼ to select [ALL DELETE] and then press ►.
- 3 When this message is displayed "DELETE ALL PICTURES?", press ◀/▶ to select [YES].
- 4 Press the ▼/[REVIEW/SET] button.

- Images that are protected (P63) or out of DCF standards (P53) are not deleted.

# Writing the Print Information to the Card (DPOF Setting)

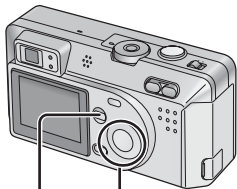

1,6 2,3,4,5

2,3

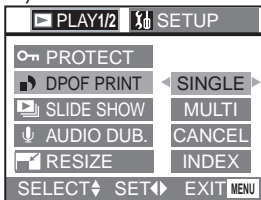

4

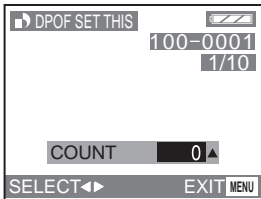

5

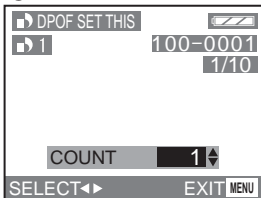

DPOF is the abbreviation for Digital Print Order Format. This feature allows you to designate which images will be printed. Some photo printers as well as many commercial photo-processing companies support DPOF.

[Preparation]

- Set the mode dial to playback [▶]. (P22)

## [Single copy setting]

- 1 Press the [MENU] button.
- 2 Press ▲/▼ to select [DPOF PRINT] and then press ▶.
- 3 Select [SINGLE] and then press ▶.
- 4 Press ◀/▶ to select 1 image.
- 5 Press ▲/▼ to select the number of sheets.

- The number of sheets can be set from 1 to 999.

- 6 Press the [MENU] button twice.

- The menu will disappear.

## [To cancel]

Set the number of sheets to 0 in step 5 of the [Single copy setting].

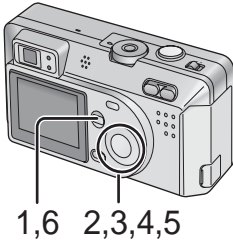
**[Multi copy setting]**

2,3

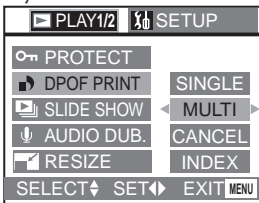

4

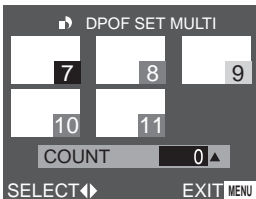

5

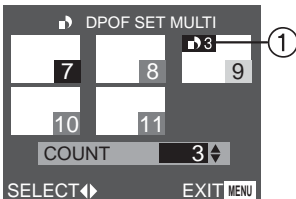

- 1 Press the [MENU] button.
- 2 Press ▲/▼ to select [DPOF PRINT] and then press ►.
- 3 Press ▲/▼ to select [MULTI] and then press ►.
- 4 Press ◀/▶ to select the image.
- 5 Press ▲/▼ to select the number of sheets to be printed.

- The number of sheets can be set from 1 to 999.
- Copy setting ① is displayed (white).

- 6 Repeat steps 4 and 5, and at the end press the [MENU] button twice.

- The DPOF setting of multi images is set at once.
- The menu will disappear.

**[To cancel]**

Set the number of sheets to 0 in step 5 of the [Multi copy setting].

- If the file is not based on the DCF standard, the DPOF setting cannot be set.  
DCF is abbreviation of [Design rule for Camera File system], stipulated by JEITA [Japan Electronics and Information Technology Industries Association].
- When using the DPOF feature, this camera will overwrite any previous DPOF settings made by other products.
- When this message is displayed "MEMORY CARD FULL", cancel all settings and set DPOF.

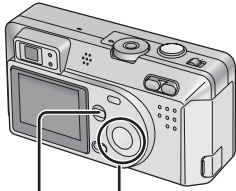

1,6 2,3,4,5  
1,6 2,3,4,5

2,3  
2,3

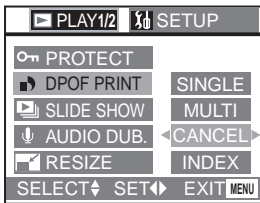

4

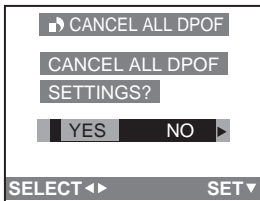

4

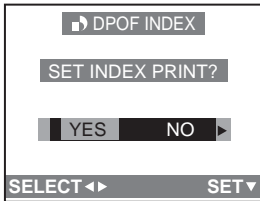

(A)

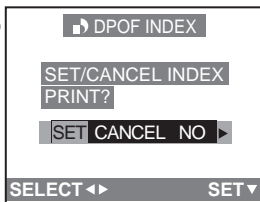

### [To cancel all settings]

- 1 Press the [MENU] button.
- 2 Press ▲/▼ to select [DPOF PRINT] and then press ►.
- 3 Press ▲/▼ to select [CANCEL] and then press ►.
- 4 When this message is displayed "CANCEL ALL DPOF SETTINGS?", press ◀/▶ to select [YES].
- 5 Press the ▼/[REVIEW/SET] button.
  - All DPOF settings are cancelled.
- 6 Press the [MENU] button.
  - The menu will disappear.

### [Index setting/to cancel]

- 1 Press the [MENU] button.
- 2 Press ▲/▼ to select [DPOF PRINT] and then press ►.
- 3 Press ▲/▼ to select [INDEX] and then press ►.
- 4 When this message is displayed "SET INDEX PRINT?", press ◀/▶ to select [YES].
  - When the index is already set, the message (A) "SET/CANCEL INDEX PRINT?" is displayed. Press ◀/▶ to select [SET], [CANCEL] or [NO].
- 5 Press the ▼/[REVIEW/SET] button.
  - All images are set/cancelled.
- 6 Press the [MENU] button.
  - The menu will disappear.

# Protecting Images on the Card

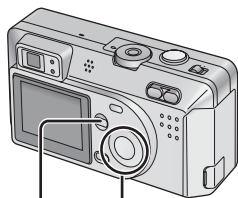

1,6 2,3,4,5

2,3

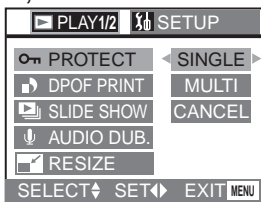

4,5

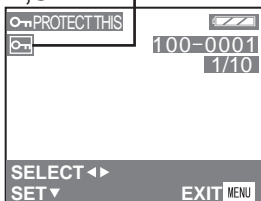

Using this feature, important photos can be protected from accidentally being deleted. This feature cannot protect photos or any data on the Card if the entire card is formatted.

[Preparation]

- Set the mode dial to playback [▶]. (P22)

## [Single setting/to cancel]

- 1 Press the [MENU] button.
- 2 Press ▲/▼ to select [PROTECT] and then press ▶.
- 3 Press ▲/▼ to select [SINGLE] and then press ▶.
- 4 Press ◀/▶ to select 1 image.
- 5 Press the ▼/[REVIEW/SET] button.

- The protect icon ① appears.
- By pressing ▼/[REVIEW/SET] again, the protection is cancelled and the icon will disappear.

- 6 Press the [MENU] button twice.

- The menu will disappear.

## [Multi setting/to cancel, To cancel all settings]

- 1 The method is the same as in “Writing the Print Information to the Card (DPOF Setting)”. (P60~P62)

- Formatting the card will erase all the data on the card, even if you protect the images in this procedure.
- When trying to delete a protected file, these messages are displayed “THIS PICTURE IS PROTECTED” or “PROTECTED PICTURES REMAIN UNDELETED”. If you want to delete this file, cancel the protect setting first.
- The protect setting is effective only in this camera.
- Sliding the SD Memory Card Write-Protect switch to [LOCK] prevents the picture from deletion even if the protection is not set.
- The audio dubbing cannot be used with protected images. (P66)

# Playing Back with Slide Show (Automatic Playback)

All pictures selected in the card can be played back one-by-one automatically.

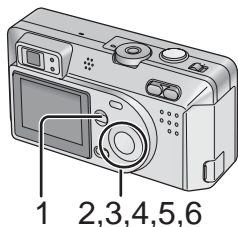

[Preparation]

- Set the mode dial to playback [▶]. (P22)

- 1 Press the [MENU] button.
- 2 Press ▲/▼ to select [SLIDE SHOW] and then press ▶.
- 3 Press ▲/▼ to select [ALL]/[DPOF] and then press ▶.

- [ALL]:  
for playing back all pictures
- [DPOF]:  
for playing back the DPOF set pictures

- 4 Press ▲/▼/◀/▶ for setting below.

- [DURATION]:  
It can be set among 1, 2, 3 and 5 seconds.
- [AUDIO]:  
It can be set to [ON] or [OFF]. By setting it to [ON], it is possible to play back the still pictures with audio in slide show.
- [DPOF SET] (Only when setting to [DPOF]):  
You can select the pictures you want to set to the Slide Show.
- [CANCEL ALL] (Only when setting to [DPOF]):  
You can cancel the Slide Show setting.

- 5 Press ▲/▼ to select [SLIDE SHOW].

- 6 Press ▶.

- The slide show starts.
- By pressing the [MENU] button, it stops.

2,3



4

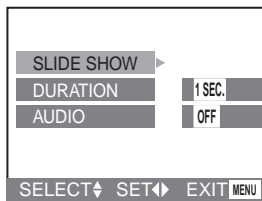

6





- In motion image playback, slide show is not available.
- The DPOF setting of slide show will not be applied to the DPOF printing.
- When setting [AUDIO] to [ON], the still picture with audio is played back for 5 seconds (audio recording)/Max 10 seconds (audio dubbing).
- When editing with the supplied software [SD Viewer for DSC] recorded on the CD-ROM, you can play back in SD slide show with this camera. (P87)
- Images that are set DPOF with the supplied software [SD Viewer for DSC] recorded on the CD-ROM cannot be played back in DPOF slide show with this camera. Set DPOF slide show on this camera.
- When using the DPOF feature, this camera will overwrite any previous DPOF settings made by other products.

# Adding Audio to Recorded Pictures (Audio Dubbing)

It is possible to add a 10-second narration to a recorded picture.

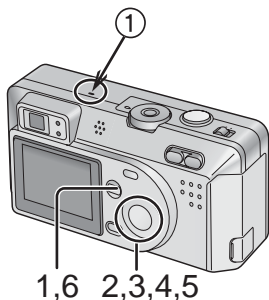

[Preparation]

- Set the mode dial to playback [▶]. (P22)

- 1 Press the [MENU] button.
- 2 Press ▲/▼ to select [AUDIO DUB.] and then press ▶.
- 3 Press ◀/▶ to select the picture.
- 4 Press the ▼/[REVIEW/SET] button, to start audio recording.  
(① Microphone)

- When audio has already been recorded, after the audio dubbing the original audio is overwritten.
- When audio has already been recorded, this message is displayed "OVERWRITE AUDIO DATA?". Then press ◀/▶ to select [YES] and press the ▼/[REVIEW/SET] button, to start audio recording.

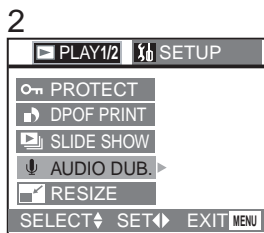

- 5 Press the ▼/[REVIEW/SET] button, to stop audio recording.

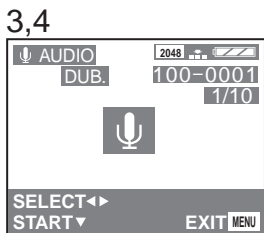

- Even if you do not press the ▼/[REVIEW/SET] button, after about 10 seconds the audio recording stops automatically.

- 6 Press the [MENU] button.

- The menu will disappear.

- Adding audio will use additional memory. Using this feature will result in fewer images being able to be saved.
- The audio dubbing cannot be used with motion images.
- The audio dubbing cannot be used with protected images. (P63)





# Formatting the Card

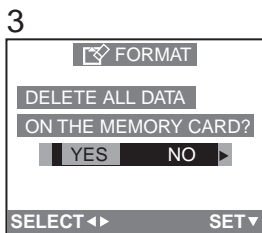
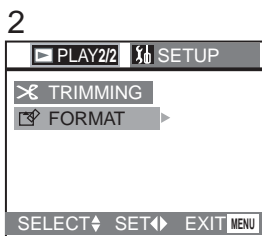
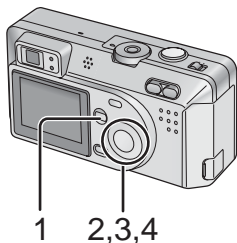

Usually, it is not necessary to format the card (initializing). Format the card when this message is displayed “MEMORY CARD ERROR”.

- If the card has been formatted by a PC or other equipment, format the card on the camera again.

[Preparation]

- Set the mode dial to playback [▶]. (P22)

- 1 Press the [MENU] button.
- 2 Press ▲/▼ to select [FORMAT] and then press ▶.
- 3 When this message is displayed “DELETE ALL DATA ON THE MEMORY CARD?”, press ◀/▶ to select [YES].
- 4 Press the ▼/[REVIEW/SET] button.

- The card is formatted.
- After formatting, recorded images and any other data cannot be recovered.

- During formatting, do not turn the power off.
- If the card cannot be formatted, consult your dealer.

For USA assistance, please call: 1-800-272-7033 or send e-mail to : [consumerproducts@panasonic.com](mailto:consumerproducts@panasonic.com)

For Canadian assistance, please call: 1-800-561-5505 or visit us at [www.panasonic.ca](http://www.panasonic.ca)

# Adjusting the LCD Monitor Brightness

You can adjust the brightness of the LCD monitor.

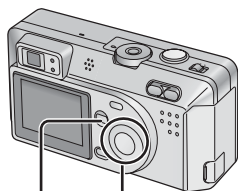

1,5 2,3,4

3,4

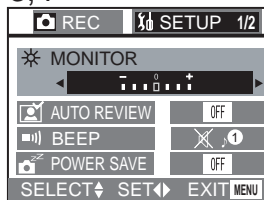

[Preparation]

- Press the [DISPLAY] button to select the display of LCD monitor. (P19)

- Set the mode dial except for [♥]. (P22)

1 Press the [MENU] button.

2 Press ► to open the setup menu.

3 Press ▲/▼ to select [MONITOR].

4 Press ◀/▶ to adjust the brightness.

5 Press the [MENU] button.

- The menu will disappear.

- In simple mode [♥], LCD monitor brightness is fixed to [0].

- Adjusting the LCD Monitor will not lighten or darken the actual photograph.
- Adjusting the LCD Monitor to brighten the image may incorrectly display the scene to be brighter than the actual photo will be. In most cases the default setting will produce the best performance and closest reproduction of the actual scene.

# Using the Auto Review

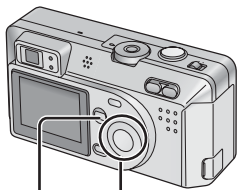

1,5 2,3,4

3,4

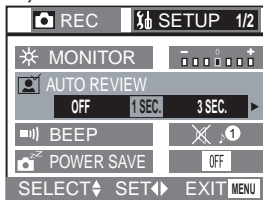

Recording with the auto review set to [1 SEC.]/[3 SEC.] the recorded picture is automatically displayed on the LCD Monitor for 1 or 3 seconds.

[Preparation]

- Set the mode dial except for [RECORDING]/[HEART]. (P22)

- 1 Press the [MENU] button.
- 2 Press ► to open the setup menu.
- 3 Press ▲/▼ to select [AUTO REVIEW].
- 4 Press ◀/▶ to select [1 SEC.] or [3 SEC.].

- 5 Press the [MENU] button.

- The menu will disappear.

- Even when setting the auto review to [1 SEC.]/[3 SEC.], it is not available in motion image mode [MOTION].
- When recording in burst mode, auto bracket, still picture with audio modes, the recorded picture is automatically displayed.
- In simple mode [HEART], the auto review setting becomes [ON] (1 second) or [OFF].

# Setting up the Operational Sound/Shutter Sound



It is possible to set the electronic shutter sound when the shutter button is pressed all the way and to set the sound volume when the shutter button is pressed halfway and when the menu operations are done.

■ When the operational mode dial is set to REC mode

- 1 Press the [MENU] button.
- 2 Press ► to open the setup menu.
  - In simple mode, skip this step.
- 3 Press ▲/▼ to select [BEEP] and then press ►.
- 4 Pressing ▲/▼/◀/▶ to adjust the operational sound volume and set the shutter sound.
- 5 Press the [MENU] button twice.
  - The menu will disappear.

■ When the operational mode dial is set to playback [ ]

- 1 Press the [MENU] button.
- 2 Press ► to open the setup menu.
- 3 Press ▲/▼ to select [BEEP].
- 4 Press ◀/▶ to adjust the operational sound volume.
- 5 Press the [MENU] button.
  - The menu will disappear.

- In simple mode [ ], the setting becomes [ON] or [OFF].



# Setting up the Power Save Mode

In this mode, if the camera is not operated for a certain amount of time, it is automatically turned off.

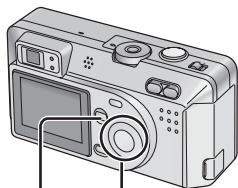

1,5    2,3,4

3,4

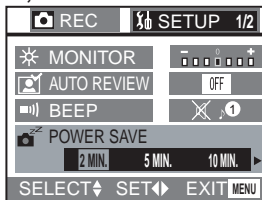

- 1 Press the [MENU] button.
- 2 Press ► to open the setup menu.
- 3 Press ▲/▼ to select [POWER SAVE].
- 4 Press ◀/▶ to choose the setting time.
  - [2 MIN.]
  - [5 MIN.]
  - [10 MIN.]
  - [OFF]: The power is not turned off automatically.
- 5 Press the [MENU] button.
  - The menu will disappear.

- If you want to cancel the power save mode, turn the power switch to [ON] again after turning it to [OFF], or press the shutter button.
- When using the AC adaptor/connecting to a PC/recording the motion image/playing back the motion image/during slide show, the power save mode is not available.
- In simple mode [♥], the power save is fixed to [2 MIN.].
- In recording mode, when keeping the [DISPLAY] button pressed for 2 seconds, power save mode starts.

# Resetting the File Number

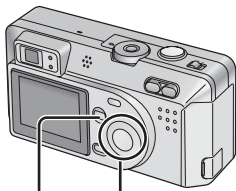

1,6 2,3,4,5

3

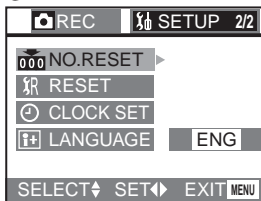

4

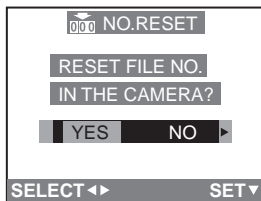

As the file numbers are recorded sequentially by the camera, when you use two or more cards, it may happen that the file numbers on your cards do not start from 0001.

Use this function when you insert a new card or perform the new recording on the recorded card and you want to start recording from the file number 0001.

[Preparation]

- Set the mode dial except for [ ]/[ ]. (P22)

- 1 Press the [MENU] button.
- 2 Press ► to open the setup menu.
- 3 Press ▲/▼ to select [NO.RESET] and then press ►.
- 4 When this message is displayed "RESET FILE NO. IN THE CAMERA?", press ◀/▶ to select [YES].
- 5 Press the ▼/[REVIEW/SET] button.
- 6 Press the [MENU] button.

- The menu will disappear.

# Initializing the settings

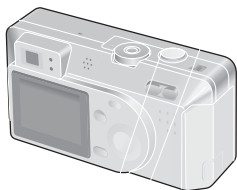

This feature allows you to easily reset the camera to the factory default settings.

[Preparation]

- Set the mode dial except for [▶]/[♥]. (P22)

- 1 **Press the [MENU] button.**
- 2 **Press ▶ to open the setup menu.**
- 3 **Press ▲/▼ to select [RESET] and then press ▶.**
- 4 **When this message is displayed "RESET REC SETTINGS?", press ◀/▶ to select [YES].**
- 5 **Press the ▼/[REVIEW/SET] button.**
  - The message "REC SETTING RESET COMPLETED" is displayed for about 2 seconds.
- 6 **When this message is displayed "RESET SETUP PARAMETERS?", press ◀/▶ to select [YES].**
- 7 **Press the ▼/[REVIEW/SET] button to set.**
  - The clock setting is not reset.
- 8 **Press the [MENU] button.**
  - The menu will disappear. 1,8,2,3,4,5,6,7SETUP 2/2REC

# Playing Back Images with a TV Monitor

By connecting the camera to a television via the supplied A/V cable ①, it is possible to view and play back the recorded images.

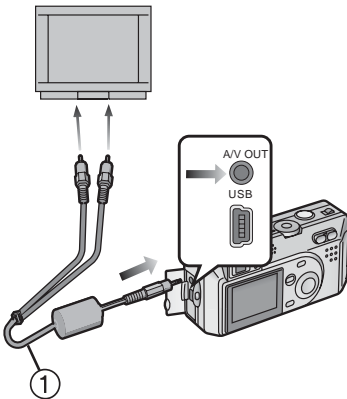

## [Preparation]

- Turn the camera and the television off.

- 1 **Connect the A/V cable to the A/V OUT socket of the camera.**
- 2 **Connect the A/V cable to the video in and the audio in sockets of the TV.**

- Yellow: to the video in socket
- White: to the audio in socket

- 3 **Turn the television on and select external input.**
- 4 **Turn the camera on and then set the mode dial to playback [▶].**

- The image is displayed on the television.

## ■ Viewing images in other countries

When setting [VIDEO OUT] on the menu, you can view images on the TV in other countries (regions) which use the NTSC or PAL system.

- Even if you set menu selection for [VIDEO OUT] to [PAL], the output signal is still NTSC.
- When connecting to a TV, we recommend using the AC adaptor as the power source. (P14)
- Do not use any other cables except the supplied one.
- The A/V cable cannot be connected to the "antenna" connection of your television. Your TV must provide separate audio and video connections for this feature to operate correctly.
- Read the TV operating instructions too.

# Connecting to a PC

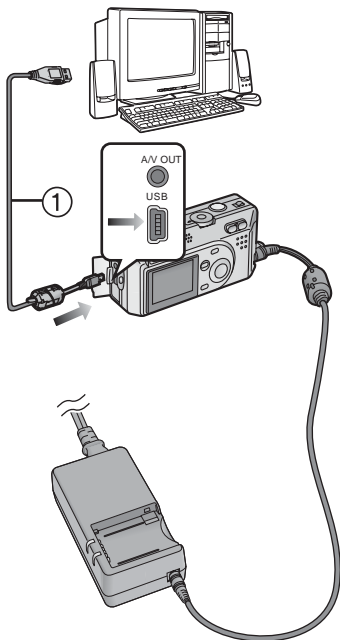

## [Preparation]

- If your PC uses Microsoft Windows<sup>®</sup> 98 or Windows<sup>®</sup> 98 Second Edition, a USB driver must be installed from the CD that is included. If you are using a newer Microsoft operating system such as Windows<sup>®</sup> ME, Windows<sup>®</sup> 2000, or Windows<sup>®</sup> XP (Home Edition/Professional), no USB driver needs to be installed. Your PC should recognize the camera automatically.

- 1 **Insert the Memory Card into the camera, and turn the power switch to [ON].**
- 2 **Connect the camera to a PC via the supplied USB connection cable ①.**



## [Windows]

The drive is shown on the [My computer] folder.

- If it is the first time you are connecting the camera to a PC, the required driver is installed automatically so that the camera can be recognized by the Windows Plug and Play, then it is shown on the [My computer] folder.

## [Macintosh]

The drive is shown on the screen.

- The flash/access indicator lights during access.
- When connecting to a PC, we recommend using the AC adaptor as the power source. (P14)
- When connecting to a PC, pictures and sounds are not output from the A/V OUT socket.
- For further information (software installation), read the supplied operating instructions for PC connection.



# USB DIRECT-PRINT (Single Picture)

[Preparation]

- Connect the camera to a printer. (P78)

1

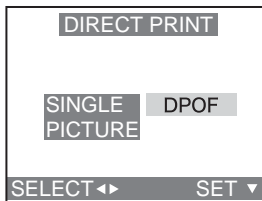

2

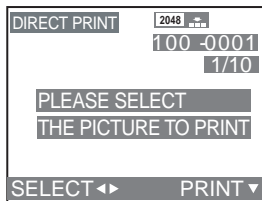

3,4

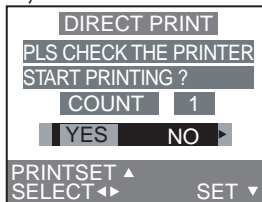

5

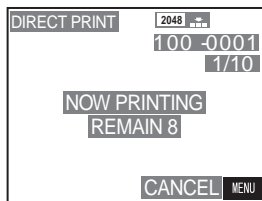

1 Only when DPOF is already set, press ◀/▶ to select [SINGLE PICTURE], and then press the ▾/[REVIEW/SET] button.

- When DPOF is not set, this screen is skipped.

2 Press ◀/▶ to select the picture to be printed, and then press the ▾/[REVIEW/SET] button.

- The message "PLEASE SELECT THE PICTURE TO PRINT" is displayed for 2 seconds.

3 Press ▲, and press ◀/▶ to set the number of sheets, and then press the ▾/[REVIEW/SET] button.

4 Press ◀/▶ to select [YES].

- The message "PLS CHECK THE PRINTER START PRINTING ?" is displayed.

5 Press the ▾/[REVIEW/SET] button.

- Printing starts.

- Press the [MENU] button, and you can stop printing.

# USB DIRECT-PRINT (DPOF)

1

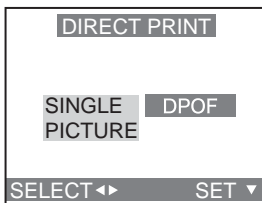

2

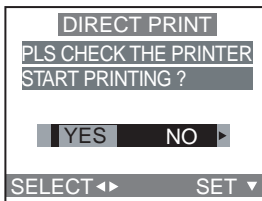

3

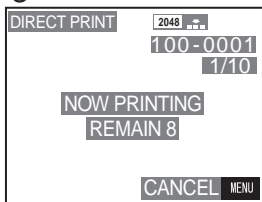

[Preparation]

- Connect the camera to a printer. (P78)
- Write the print information to the card (DPOF setting). (P60)

1 Press ◀/▶ to select [DPOF].

- Press the [MENU] button, and you can change the DPOF setting. (P60)

2 Press the ▼/[REVIEW/SET] button.

- The message "PLS CHECK THE PRINTER START PRINTING ?" is displayed.

3 Press ◀/▶ to select [YES], and then press the ▼/[REVIEW/SET] button.

- Printing starts.

- Press the [MENU] button, and you can stop printing.

- When the number of total images is more than 255, the number of remaining images will be displayed as "----".





# The Menu Items

## REC mode menu

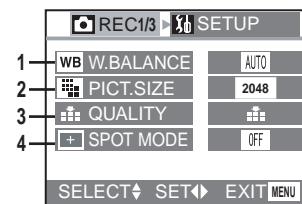

- 1 W.BALANCE (P49)
- 2 PICT.SIZE (P37)
- 3 QUALITY (P38)
- 4 SPOT MODE (P44)

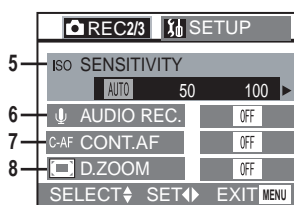

- 5 SENSITIVITY (P51)
- 6 AUDIO REC. (P36)
- 7 CONT.AF (P34)
- 8 D.ZOOM (P31)

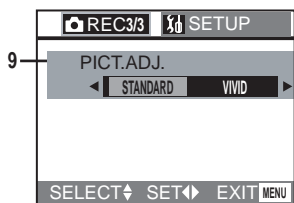

- 9 PICT.ADJ. (P48)

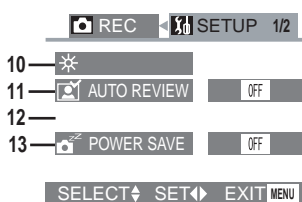

- 10 MONITOR (P70)
- 11 AUTO REVIEW (P71)
- 12 BEEP/SHUTTER (P72)
- 13 POWER SAVE (P73)

- 14—
- 15—
- 16—
- 17—

- 14 NO.RESET (P74)
- 15 RESET (P75)
- 16 CLOCK SET (P24)
- 17 LANGUAGE

### Simple mode menu

- For items without number, refer to those with the same name.

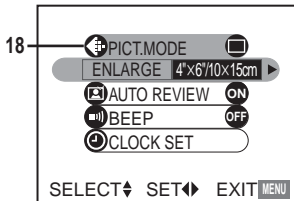

18 PICT.MODE (P27)

### Playback mode menu

- For items without number, refer to those with the same name.

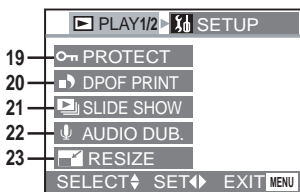

- 19 PROTECT (P63)
- 20 DPOF PRINT (P60)
- 21 SLIDE SHOW (P64)
- 22 AUDIO DUB. (P66)
- 23 RESIZE (P67)

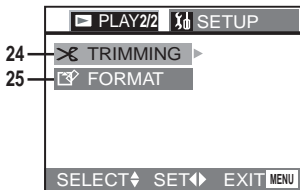

- 24 TRIMMING (P68)
- 25 FORMAT (P69)

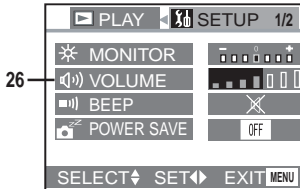

26 VOLUME (P54)

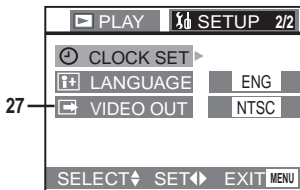

27 VIDEO OUT (P76)

# Cautions for Use

## ■ Cautions for Use

**Keep the digital camera away from magnetized equipment (such as a microwave oven, TV, video game equipment, etc.).**

- If you use the digital camera on or near a TV, images and sounds may be disturbed due to electromagnetic wave radiation.
- Do not use the digital camera near a cell phone because doing so may cause noise to adversely affect the images and sounds.
- Recorded data may be damaged, or images may be distorted by strong magnetic fields created by speakers or large motors.
- Electromagnetic wave radiation generated by a microprocessor may adversely affect the digital camera, causing the disturbance of images and sounds.
- If the digital camera is affected by magnetically charged equipment and does not function properly, turn the camera off and detach the battery or AC adaptor and then connect the battery or AC adaptor again. Thereafter, turn the camera on.

**Do not use the digital camera near radio transmitters or high-voltage lines.**

- If you record near radio transmitters or high-voltage lines, recorded images or sounds may be adversely affected.

**Do not spray insecticides or volatile chemicals onto the digital camera.**

- If the digital camera is sprayed with such chemicals, the camera body may be damaged and the surface finish may peel off.
- Do not keep rubber or plastic products in contact with the digital camera for a long period of time.

**When you use the digital camera on a beach or similar place, do not let sand or fine dust get into the camera.**

- Sand or dust may damage the digital camera or card. (Care should be taken when inserting and removing the card)

**When you use your digital camera on a rainy or snowy day or on a beach, make sure that no water enters the digital camera.**

- Water may cause the digital camera or card to malfunction. (Irreparable damage may occur)
- If sea water splashes onto the digital camera, wet a soft cloth with tap water, wring it well, and use it to wipe the camera body carefully. Then, wipe it again thoroughly with a soft dry cloth.

**Do not use the digital camera for surveillance purpose or other business use.**

- If you use the digital camera for a long period of time, the internal temperature increases and, consequently, this may cause malfunction.
- The digital camera is not intended for business use.

## Do not use benzine, thinner or alcohol for cleaning the digital camera.

- The camera body may be deformed and the surface finish may peel off.
- Before cleaning the camera, detach the battery or pull out the AC adaptor from the electrical outlet.
- Wipe the digital camera with a soft, dry cloth. To remove stubborn stains, wipe with a cloth that is soaked in a detergent diluted with water and afterward finish wiping with a dry cloth.
- For storing or transporting the digital camera, place it in a bag or case lined with soft pads to prevent the coating on the camera body from being worn.

## After use, be sure to take the card out, and detach the battery or pull out the AC adaptor from the electrical outlet.

- If the battery is left on the digital camera for a long time, the voltage drops excessively, and the battery will not function even after it is recharged.

## ■ Optimal Use of the Battery

The battery is a rechargeable lithium ion battery. Its ability to generate power is based upon the chemical reaction that takes place inside it. This reaction is susceptible to the surrounding temperature and humidity, and, if the temperature is too high or too low, the operating time of the battery will be shorter.

## Be sure to detach the battery after use.

Be sure to detach the battery from the digital camera. (If it is left attached to the digital camera, a minute amount of current is consumed even when the digital camera power is off) If the battery is left attached to the digital camera for a long time, discharge takes place. The battery may become unusable even after it is charged.

## Dispose of an unusable battery.

- The battery has a limited life.
- Do not throw the battery into fire because it may cause an explosion.
- Batteries that are no longer usable should be discarded in accordance with battery recycling laws. For information you can call the RBRC hotline at 1-800-822-8837.

## Always keep the terminals of the battery clean.

Prevent the terminals from getting clogged with dirt, dust, or other substances.

If you drop the battery accidentally, check to see if the battery body and terminals are deformed. Attaching a deformed battery to the digital camera may damage the camera.



A lithium ion/polymer battery that is recyclable powers the product you have purchased. Please call 1-800-8-BATTERY for information on how to recycle this battery.

## ■ Condensation

**When condensation has taken place:**

**Set the power switch to [OFF] and leave the digital camera in this condition for about 1 hour. When the camera becomes close to the ambient temperature, the fog disappears naturally.**

## ■ Cautions for Storage

Before storing the digital camera, take the card out and detach the battery. Store all the components in a dry place with a relatively stable temperature. (Recommended temperature: 59 F to 77 F (15°C to 25°C), Recommended humidity: 40% to 60%)

## Digital camera

- Wrap it with a soft cloth to prevent dust from getting into the camera.
- Do not leave the camera in places that expose it to high temperature.

## Battery

- Do not leave the camera and the battery at the place where the temperature is too high, such as inside the car during the midsummer.
- Extremely high or low temperatures will shorten the life of the battery.
- If the battery is kept in smoky or dusty places, the terminals may rust and cause malfunctions.
- Do not allow the battery terminals to come in contact with metal objects (such as necklaces, hairpins, etc.). This can result in a short circuit or heat generation and, if you touch the battery in this condition, you may be badly burned.
- Store the battery in a completely discharged state. To store the battery for a long period of time, we recommend charging it once every year and storing it again after you completely use up the charged capacity.

## Card

- When the card is being read, do not remove the card, turn off the power, or subject it to vibration or impact.
- Do not leave the card in places where there is high temperature or direct sunlight, or where electromagnetic waves or static electricity are easily generated.
- Do not bend or drop the card. The card or the recorded content may be damaged.
- After use, be sure to remove the card from the digital camera.
- Do not touch the terminals on the back of the card with your fingers. Do not allow dirt, dust or water to enter it.

## AC adaptor

- If the battery is warm, charging takes a longer time than normal.
- If you use the AC adaptor near a radio, radio reception may be disturbed. Keep the AC adaptor 100 cm or more away from radio.
- When the AC adaptor is in use, it may generate whirring sounds. However, this is normal.
- After use, be sure to disconnect the AC cable. (If it is left connected, a minute amount of current is consumed)
- Keep the electrodes of the AC adaptor and battery clean at all times.

## ■ LCD Monitor

### LCD Monitor

- In a place with drastic temperature changes, condensation may form on the LCD Monitor. Wipe it with soft dry cloth.
- If the digital camera is extremely cold when you turn the power on, the image on the LCD Monitor is slightly darker than usual at first. However, as the internal temperature increases, it goes back to the normal brightness.

Extremely high precision technology is employed to produce the LCD Monitor screen featuring a total of approximately 114,000 pixels. The result is more than 99.99% effective pixels with a mere 0.01% of the pixels inactive or always lit. However, this is not a malfunction and does not affect the recorded picture.

## ■ SD Slide Show

If setting the SD slide show with the [SD Viewer for DSC] which is in the supplied CD-ROM, when playing back, the message "START SD SLIDE SHOW?" is displayed, select [YES] and press the ▼/[REVIEW/SET] button to start the SD slide show. Select [NO] and press the ▼/[REVIEW/SET] button to start normal playback.

## ■ Folder Composition

When a Memory Card with data recorded on it is inserted into a PC, the folders shown below will be displayed.

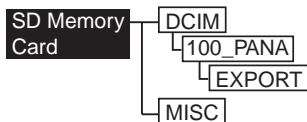

- In the 100\_PANA folder it is possible to record up to 999 images.
- In the MISC folder it is possible to record the files that have been set with DPOF settings.

# Warning Indications

## **[NO MEMORY CARD]**

Insert the Memory Card.

## **[THIS MEMORY CARD IS PROTECTED]**

Cancel the Memory Card lock.

## **[NO VALID IMAGE TO PLAY]**

Carry out playback after recording or after inserting the Memory Card with a recorded image.

## **[MEMORY CARD FULL] / [NO ENOUGH MEMORY IN THE CARD]**

Insert a new Memory Card or delete unnecessary data.

## **[MEMORY CARD ERROR]**

Failed access to Memory Card.  
Insert the card again.

## **[READ ERROR]**

Data reading error.  
Play it back again.

## **[WRITE ERROR]**

Data writing error.  
Turn the camera [OFF] and remove the card. Then insert the card and turn the camera back [ON]. Be sure camera is [OFF] before removing or inserting the card to avoid damaging the card.

## **[PLEASE SET THE CLOCK]**

This message is displayed when you use the camera for the first time or you do not use the camera for a long time. Set the clock again.

## **[THIS PICTURE IS PROTECTED]**

After cancelling the protect setting, you can delete or overwrite the image.

## **[THIS PICTURE CAN'T BE DELETED] / [SOME PICTURES CAN'T BE DELETED]**

If the image is not based on the DCF standard, it is not possible to delete selected pictures.

## **[NUMBER OF PRINT IS OVER]**

You have exceeded the number of images that can be set at once with multi-deleting setting.

## **[CAN'T BE SET ON THIS PICTURE] / [CAN'T BE SET ON SOME PICTURES]**

If the image is not based on the DCF standard, it is not possible to set the DPOF.

## **[MEMORY CARD ERROR FORMAT THIS CARD?]**

The format of this card cannot be recognized by the camera. Format the card again with the camera.

## **[REC MODE DIAL IS NOT IN THE PROPER POSITION]**

This message is displayed when you turn on the camera with the mode dial in the wrong position.  
Rotate the mode dial to the proper position.



# Troubleshooting

## 1: The power does not turn on.

- 1-1: Are the battery and the AC adaptor correctly connected? Check the connection.
- 1-2: Is the battery sufficiently charged? Use a battery that has been sufficiently charged.

## 2: As the power is turned on, it turns off immediately.

- 2-1: Is the battery charge insufficient to operate the camera? Charge the battery or replace it with charged one.
- 2-2: Has condensation occurred? Carrying the digital camera from a cold place to a warm place could cause condensation to form inside the camera. Wait until condensation disappears.

## 3: The image cannot be recorded.

- 3-1: Is the Memory Card inside?
- 3-2: Is the mode dial correctly set ? Check it.
- 3-3: There is no memory capacity left on the card. Before recording, delete some images.

## 4: The image is not displayed on the LCD monitor.

- 4: Is the LCD monitor set to OFF?

## 5: The LCD monitor is too bright or dark.

- 5: Adjust the brightness of the LCD monitor.

## 6: Flash does not light.

- 6: The flash mode is set to forced OFF. Change the flash mode.

## 7: The display or images on the LCD monitor are not focused.

- 7: Set the mode dial to the mode corresponding to the distance to the subject.

## 8: The image will not play back.

- 8-1: Is the Memory Card inside?
- 8-2: There is no image in the Memory Card.
- 8-3: The mode dial is not set to playback [▶].

## 9: The image is not displayed on the television.

- 9-1: Is the camera correctly connected with the TV? Check it.
- 9-2: Set the TV to video input mode.

## 10: When connecting to a PC, images cannot be transferred.

- 10-1: Check that the camera is correctly connected to the PC.
- 10-2: Is the camera correctly recognized by the PC?

## 11: The clock setting is reset.

- 11-1: If you do not use the camera for a long time, the clock setting may be reset. When the message [PLEASE SET THE CLOCK] appears, set the clock again.
- 11-2: When you take a picture before setting the clock, [0:00 0.0. 0] is recorded.

# Specifications

## Digital Camera

Information for your safety

Power Source:	DC 4.7 V
Power Consumption:	2.1 W (When recording with LCD Monitor to on) 1.6 W (When recording with LCD Monitor to off) 1.8 W (When playing back with LCD monitor)
Effective number of pixels	3.2 Million Pixels
Image sensor	1/2.5" CCD, total pixel number 3,340,000 Primary color filter
Lens	Optical 3× zoom, f=5.8 - 17.4 mm (35 mm film camera equivalent: 35 - 105 mm)/F2.8 - 4.9
Digital zoom	Max 3×
Focus	Auto/Macro Spot AF (Spot mode)
Focus range	Auto: 1.64 feet (50 cm)(Wide)/ 1.64 feet (50 cm)(Tele) - ∞, Macro/Simple/Color effect: 0.33 feet (10 cm) (Wide)/0.98 feet (30 cm) (Tele) - ∞
Shutter system	Electronic shutter + Mechanical shutter
Burst recording	4 frames/second, Max 8 frames (standard)/ 5 frames (fine) (Performance is only with SD Memory Card. MultiMediaCard performance will be less.)
Motion image recording	320 × 240 (10 frames/second with audio)
ISO sensitivity	AUTO/50/100/200/400
Shutter speed	8 - 1/2,000 Motion image mode: 1/30 - 1/2,000
White balance	AUTO/Daylight/Cloudy/Halogen/White set
Exposure (AE)	Program AE Exposure compensation (1/3 EV Step, -2 - +2 EV)
Metering mode	Multi/Spot (Spot mode)
LCD monitor	1.5" low-temperature polycrystalline TFT LCD (114,000 pixels) (field of view ratio 100%)
Optical finder	Real-image zoom finder
Flash	Flash range: (ISO100) Approx. 0.98 feet (30 cm) - 7.87 feet (2.4 m)(Wide)/ Approx. 0.98 feet (30 cm) - 4.59 feet (140 cm)(Tele) AUTO, AUTO/Red-eye reduction, Forced ON, Slow sync./Red-eye reduction, Forced OFF
Microphone	Monaural
Speaker	Monaural
Recording media	SD Memory Card/MultiMediaCard
Recording size	2048 × 1536, 1600 × 1200, 1280 × 960, 640 × 480 (Still picture) 320 × 240 (Motion image)
Quality	Fine/Standard

Recording file format	
Still Picture	JPEG (Design rule for Camera File system, based on Exif 2.2 standard), DPOF corresponding
Still picture with audio	JPEG (Design rule for Camera File system, based on Exif 2.2 standard) + 640 × 480 QuickTime Motion JPEG (still picture with audio)
Motion image	QuickTime Motion JPEG (motion image with audio)
Interface	
Digital	USB
Analog video/audio	NTSC/PAL Composite/Audio line output (monaural)
Terminal	
USB	5 pin Mini USB
Analog video/audio	Φ 2.5 mm jack
DC IN	EIAJ type 2 jack
Dimensions (W × H × D)	4 1/8" × 2" × 1 1/4" / 104 × 50.9 × 32.1 mm (excluding the projection part)
Weight	Approx. 5.64 oz/160 g (excluding Memory Card and battery) Approx. 6.35 oz/180 g (with Memory Card and battery)
Operating Temperature	32 F - 104 F (0°C - 40°C)
Operating Humidity	10% - 80%

**AC adaptor (Panasonic DE-929A)**

Information for your safety

Input	110 - 240 V ~ 50/60 Hz, 0.22 A
Output	DIGITAL CAMERA 4.7 V --- 1.5 A CHARGE 4.2 V --- 0.65 A

**Battery pack (lithium-ion)  
(Panasonic CGA-S001A)**

Information for your safety

Voltage/capacity	3.6 V, 680 mAh
------------------	----------------

## Digital Camera Accessory System

Accessory#	Figure	Description
BN-SDABPU/1B		SD PC Card Adaptor (compatible with MultiMediaCard)

\*Please refer to page 13, for details on battery charging time and available recording time.

\*NOTE: Accessories and/or model numbers may vary by country. Please consult your local dealer.

# Digital Camera Accessory Order Form

(For USA Customers)

Please photocopy this form when placing an order.

1. Digital Camera Model # \_\_\_\_\_

2. Items Ordered

Accessory #	Description	Price Each	Quantity	Total Price
Subtotal				
Your State & Local Sales Tax				
Shipping & Handling				6.95
Total Enclosed				

3. Method of payment (check one)

- Check of Money Order enclosed (NO C.O.D.SHIPMENTS)
- VISA                      Credit Card # \_\_\_\_\_
- MasterCard              Expiration Date \_\_\_\_\_
- Discover                    Customer Signature \_\_\_\_\_

Make Check or Money Order to: PANASONIC ACCESSORIES

(Please do not send cash)

4. Shipping information (UPS delivery requires complete street address)

Ship To:

Mr.

Mrs.

Ms.

First \_\_\_\_\_ Last \_\_\_\_\_

Phone#:

Day ( ) \_\_\_\_\_

Street Address \_\_\_\_\_

Night ( ) \_\_\_\_\_

City \_\_\_\_\_ State \_\_\_\_\_ Zip \_\_\_\_\_

TO OBTAIN ANY OF OUR DIGITAL CAMERA ACCESSORIES YOU CAN DO ANY OF THE FOLLOWING:

VISIT YOUR LOCAL PANASONIC DEALER

OR

CALL PANASONIC'S ACCESSORY ORDER LINE AT 1-800-332-5368

[6 AM-5 PM M-F, 6 AM-10:30 AM SAT, PACIFIC TIME]

OR

MAIL THIS ORDER TO: PANASONIC SERVICES COMPANY ACCESSORY ORDER OFFICE

20421 84th Avenue South Kent, WA. 98032

In CANADA, please contact your local Dealer for more information on Accessories.

# Request for Service Notice

Please photocopy this form when making a request for service notice.

In the unlikely event this product needs service.

## Request for Service Notice:

(USA Only)

- Please include your **proof of purchase**.  
(Failure to do so will delay your repair.)
- To further speed your repair, please provide an explanation of what wrong with the unit and any symptom it is exhibiting.

---

---

---

---

Mail this completed form and your Proof of Purchase along with your unit to:

Panasonic Services Company  
1705 N. Randall Road  
Elgin, IL. 60123-7847  
Attn: Digital Camera Repair

Please write the displayed above Self Diagnostic number here.



## Carry-In or Mail-In Service

For Carry-In or Mail-In Service in the United States call

1-800-272-7033.

For assistance in Puerto Rico call Panasonic Sales Company  
(787)-750-4300 or fax (787)-768-2910.

This warranty ONLY COVERS failures due to defects in materials or workmanship, and DOES NOT COVER normal wear and tear or cosmetic damage. The warranty ALSO DOES NOT COVER damages which occurred in shipment, or failures which are caused by products not supplied by the warrantor, or failures which result from accidents, misuse, abuse, neglect, mishandling, misapplication, alteration, faulty installation, set-up adjustments, misadjustment of consumer controls, improper maintenance, power line surge, lightning damage, modification, or commercial use (such as in a hotel, office, restaurant, or other business), rental use of the product, service by anyone other than a Factory Servicenter or other Authorized Servicer, or damage that is attributable to acts of God.

**THERE ARE NO EXPRESS WARRANTIES EXCEPT AS LISTED UNDER "LIMITED WARRANTY COVERAGE". THE WARRANTOR IS NOT LIABLE FOR INCIDENTAL OR CONSEQUENTIAL DAMAGES RESULTING FROM THE USE OF THIS PRODUCT, OR ARISING OUT OF ANY BREACH OF THIS WARRANTY.** (As examples, this excludes damages for lost time, travel to and from the servicer, loss of media or images, data or other memory content. The items listed are not exclusive, but are for illustration only.) **ALL EXPRESS AND IMPLIED WARRANTIES, INCLUDING THE WARRANTY OF MERCHANTABILITY, ARE LIMITED TO THE PERIOD OF THE LIMITED WARRANTY.**

Some states do not allow the exclusion or limitation of incidental or consequential damages, or limitations on how long an implied warranty lasts, so the exclusions may not apply to you.

This warranty gives you specific legal rights and you may also have other rights which vary from state to state. If a problem with this product develops during or after the warranty period, you may contact your dealer or Servicenter. If the problem is not handled to your satisfaction, then write to the warrantor's Consumer Affairs Department at the addresses listed for the warrantor.

**PARTS AND SERVICE WHICH ARE NOT COVERED BY THIS LIMITED WARRANTY ARE YOUR RESPONSIBILITY.**



Others

# Customer Services Directory (For USA Only)

For Product Information, Operating Assistance, Literature Request, Dealer Locations, and all Customer Service inquiries please contact:

**1-800-272-7033**, Monday-Friday 8:30am-8pm EST.

**Web Site:** <http://www.panasonic.com>

You can purchase parts, accessories or locate your nearest servicer by visiting our Web Site.

### Accessory Purchases:

**1-800-332-5368 (Customer Orders Only)**

**Panasonic Services Company 20421 84th Avenue South, Kent, WA 98032**

**(6 am to 5 pm Monday - Friday; 6 am to 10:30 am Saturday; PST)**

**(Visa, MasterCard, Discover Card, American Express, Check)**

### Product Repairs

#### Centralized Factory Servicer

MAIL TO :

Panasonic Services Company

1705 N. Randall Road,

Elgin, IL 60123-7847

Attention: Digital Camera Repair

Please carefully pack and ship, prepaid and insured, to the Elgin Centralized Factory Servicer.

Customer's in Puerto Rico, please ship or carry in to location below ("Service in Puerto Rico").

### Service in Puerto Rico

Matsushita Electric of Puerto Rico, Inc. Panasonic Sales Company/ Factory Servicer:

Ave. 65 de Infantería, Km. 9.5, San Gabriel Industrial Park, Carolina, Puerto Rico 00985

Phone (787) 750-4300 Fax (787) 768-2910

As of January 2002

# Index

## A

AF/AE Lock .....	47
Audio Dubbing .....	66
Auto Exposure (AE)	
Bracket .....	46
Auto Review .....	71

## B

Built-in Flash .....	32
Burst Mode .....	52

## C

Card Access Indication .....	16
Clock Set .....	24
Color Effect Mode .....	43
Compensating the Exposure .....	45
Condensation .....	86
Continuous AF .....	34

## D

Digital Zoom .....	31
DPOF .....	60

## F

File Number .....	74
Flash/ Access Indicator .....	16, 17
Formatting .....	69

## I

ISO Sensitivity .....	51
-----------------------	----

## L

Landscape Mode .....	41
LCD Monitor Brightness .....	70

## M

Macro Mode .....	39
Motion Image .....	29
Multi Playback .....	55
MultiMediaCard .....	16

## N

Night Portrait Mode .....	42
---------------------------	----

## O

Operational Sound .....	72
Optical Zoom .....	30

## P

Picture Size .....	37
Play Back .....	53, 76
Playback Zoom .....	56
Portrait Mode .....	40
Power Save Mode .....	73

## Q

Quality .....	38
---------------	----

## R

Recording .....	25
Resize .....	67
Review .....	28

## S

SD Memory Card .....	16
SD Slide Show .....	87
Self-timer .....	35
Shutter Jiggle .....	26
Simple Mode .....	27
Slide Show .....	64
Spot Mode .....	44
Status Indicator .....	17

## T

Trimming .....	68
----------------	----

## U

USB DIRECT-PRINT .....	78
------------------------	----

## W

White Balance .....	49
---------------------	----



**Panasonic Consumer Electronics Company,  
Division of Matsushita Electric Corporation of America**  
One Panasonic Way, Secaucus, NJ 07094

**Panasonic Sales Company ("PSC")  
Division of Matsushita Electric of Puerto Rico, Inc.**  
Ave. 65 de Infanteria, Km. 9.5, San Gabriel Industrial Park, Carolina, Puerto Rico 00985

**Panasonic Canada Inc.**  
5770 Ambler Drive, Mississauga, Ontario, L4W 2T3



VQT0B81

F1202Ma0( 1000<sup>Ⓐ</sup>)

Download from [Www.Somanuals.com](http://www.Somanuals.com). All Manuals Search And Download.

## Free Manuals Download Website

<http://myh66.com>

<http://usermanuals.us>

<http://www.somanuals.com>

<http://www.4manuals.cc>

<http://www.manual-lib.com>

<http://www.404manual.com>

<http://www.luxmanual.com>

<http://aubethermostatmanual.com>

Golf course search by state

<http://golfingnear.com>

Email search by domain

<http://emailbydomain.com>

Auto manuals search

<http://auto.somanuals.com>

TV manuals search

<http://tv.somanuals.com>