

Panasonic[®]

Operating Instructions for advanced features

Digital Camera

Model No. **DMC-FH6**
DMC-FH4
DMC-S5
DMC-S2

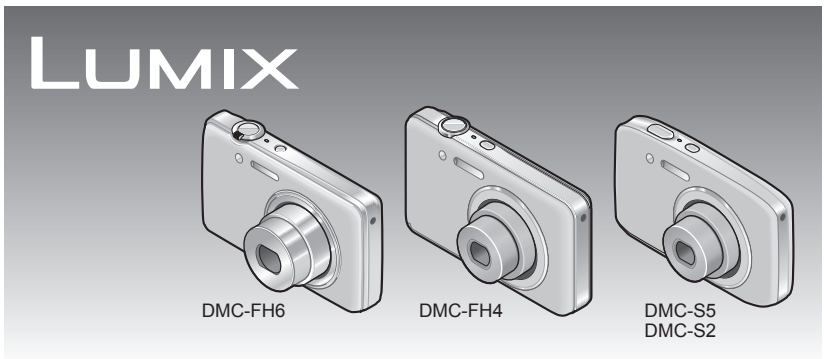

Before use, please read these instructions completely.



Contents

Before use

Before use	4
Standard Accessories	6
Names and Functions of Main Parts....	7
Cursor button	9

Preparations

Charging battery	10
Guidelines for number of recordable pictures and operating time.....	11
Inserting and removing the card (optional)/the battery.....	12
Picture save destination (cards and built-in memory)	14
Remaining battery and memory capacity....	15
Recording capacity guidelines (pictures/recording time)	15
Setting the clock.....	16
To change time setting	17

Basics

Sequence of operations.....	18
Taking pictures with automatic settings [Intelligent Auto] Mode.....	22
Automatic Scene Detection.....	23
About flash	23
About the Happy colour setting.....	23
Notes on setting items.....	24
Taking motion pictures [Motion Picture] Mode.....	25
Viewing your pictures [Normal Play]	26
Viewing motion pictures	27
Zooming in and viewing "Playback Zoom"	28
Viewing a list of pictures "Multi Playback"	29
Viewing pictures by their recording date "Calendar Playback".....	30
Deleting pictures	31
To delete multiple (up to 50)/ To delete all pictures	32
Setting the menu	33
Menu type	34
Using the [Setup] menu	35
[Clock Set].....	35
[World Time]	35
[Beep] DMC-FH6	36
[Beep] DMC-FH4 DMC-S5 DMC-S2	36
[Volume].....	36
[LCD Display]	36
[Focus Icon].....	37
[Auto Power Off].....	37
[Auto Review].....	37
[Reset].....	37
[Output]	38
[Rotate Disp.]	38
[Version Disp.].....	38
[Format].....	39
[Language]	39
[Demo Mode].....	39

Application (Record)

Taking pictures with your own settings	
[Normal Picture] Mode	40
How to adjust focus	41
Using zoom	43
Zoom types and use.....	44
Taking pictures with flash	45
Taking pictures with self-timer	47
Taking pictures with Exposure Compensation	48
Taking pictures according to the scene	
[Scene Mode]	49
[Portrait].....	50
[Soft Skin].....	50
[Scenery].....	50
[Panorama Shot].....	51
[Sports].....	53
[Night Portrait].....	53
[Night Scenery].....	53
[Food].....	53
[Baby].....	54
[Pet].....	54
[Sunset].....	54
[High Sens.].....	54
[Glass Through].....	54
[Photo Frame].....	54
Using the [Rec] menu	55
[Picture Size].....	55
[Rec Quality].....	56
[Sensitivity].....	56
[White Balance].....	57
[AF Mode].....	58
[i.Exposure].....	59
[i.Resolution].....	59
[Digital Zoom].....	59
[Burst] DMC-FH6	60
[Burst]	
DMC-FH4 DMC-S5 DMC-S2	61
[Color Mode].....	62
[AF Assist Lamp].....	62
[Red-Eye Removal].....	62
[Stabilizer].....	63
[Date Stamp].....	63
[Clock Set].....	63

Application (View)

Different playback methods	
[Playback Mode]	64
[Slide Show].....	65
[Filtering Play].....	66
[Calendar].....	67
Retouching pictures	68
[Auto Retouch].....	68
[Beauty Retouch] DMC-FH6	69
Using the [Playback] menu	71
[Upload Set].....	71
[Resize].....	72
[Cropping] DMC-FH6	73
[Favorite].....	74
[Print Set] DMC-FH6	75
[Protect].....	76
[Copy].....	77

Connecting with other devices

Viewing on TV screen	78
Using with your PC	80
Using the supplied software.....	80
Installing supplied software	
(PHOTOfunSTUDIO).....	81
Copying still pictures and motion pictures..	82
Uploading pictures to image-sharing	
websites.....	84
Printing	85
Printing multiple pictures.....	86
Making print settings on the camera.....	87
Print with date and text.....	87

Others

List of LCD monitor displays	88
Message displays	90
Q&A Troubleshooting	92
Usage cautions and notes	98

Before use

■ Camera handling

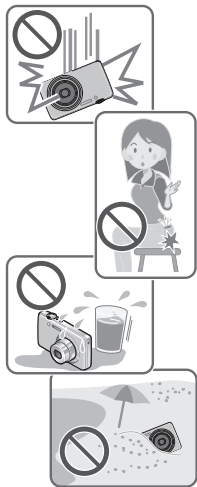

Keep the camera away from excessive vibration, force, or pressure.

- Avoid using the camera under the following conditions, which may damage the lens, LCD monitor, or camera body. This may also cause the camera to malfunction or prevent recording.
 - Dropping or hitting the camera against a hard surface
 - Sitting down with the camera in your pants pocket or forcing it into a full bag
 - Adding accessories to the camera strap
 - Pushing with excessive force on the lens or LCD monitor

The camera is not dust resistant, splash resistant, or waterproof.

Avoid using the camera in places with excessive dust or sand, or where water can come into contact with the camera.

- Avoid using the camera under the following conditions, which present a risk that sand, water, or foreign material may enter the camera through the lens or openings around buttons. Be especially careful, because these conditions may damage the camera and such damage may not be repairable.
 - In extremely dusty or sandy places
 - In the rain or by the shore, where the camera may be exposed to water

■ Condensation (When the lens or the LCD monitor is fogged up)

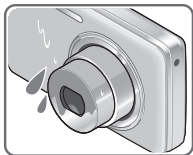

- Condensation may occur when the camera is exposed to sudden changes of temperature or humidity. Avoid these conditions, which may make the lens or LCD monitor dirty, cause mould, or damage the camera.
- If condensation does occur, turn off the camera and wait about two hours before using it. Once the camera adjusts to the surrounding temperature, fogginess will clear naturally.

■ Always take a test shot first

Before important events when you will use the camera (at weddings, for example), always take a test shot to make sure that pictures and sound record correctly.

■ No compensation for missed shots

We cannot compensate for missed shots if technical problems with the camera or card prevent recording.

■ Carefully observe copyright laws

Unauthorised use of recordings which contain works with copyright for purposes other than personal use is prohibited under copyright law. Recording of certain material may be restricted even for the purpose of personal use.

■ Also refer to “Usage cautions and notes” (→98)

- Please note that the actual controls and components, menu items, and other information for your digital camera may differ from those in the illustrations and screens provided in this manual. When operation or other information is more or less the same between models, DMC-FH6 is used as examples for the instructions provided in this manual.
- The operations, procedures, or functions that differ among models are indicated separately, together with the relevant model number.

(Example) **DMC-FH6**

DMC-S2

- Recording mode icons

Recording mode: 

Available recording modes

Unavailable recording modes

Standard Accessories

Check that all the accessories are supplied before using the camera.

- The accessories and their shape will differ depending on the country or area where the camera was purchased.

For details on the accessories, refer to Basic Operating Instructions.

- Battery Pack is indicated as battery pack or battery in the text.
- Battery Charger is indicated as battery charger or charger in the text.
- SD Memory Card, SDHC Memory Card and SDXC Memory Card are indicated as card in the text.
- Please dispose of all packaging appropriately.
- Keep small parts in a safe place out of the reach of children.

■ Optional accessories

- **Cards are optional.** You can record or play back pictures on the built-in memory when you are not using a card. (→14)
- Consult the dealer or your nearest Service Centre if you lose the supplied accessories.
(You can purchase the accessories separately.)

Names and Functions of Main Parts

DMC-FH6

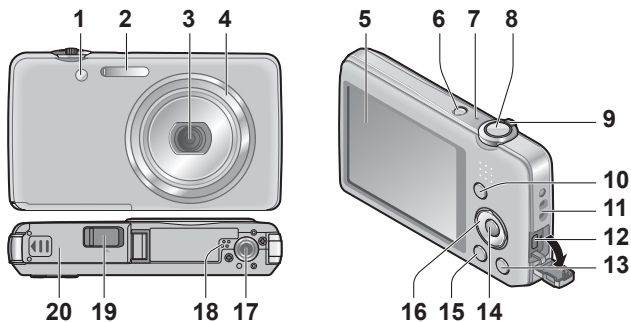

DMC-FH4

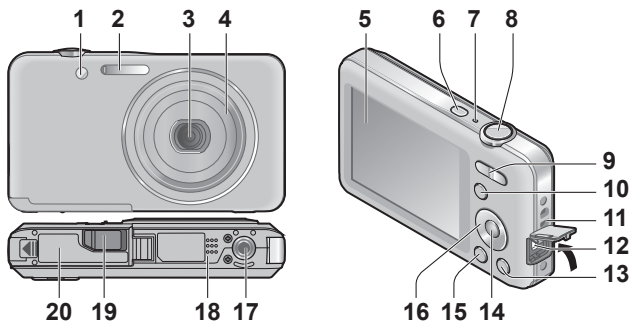

DMC-S5

DMC-S2

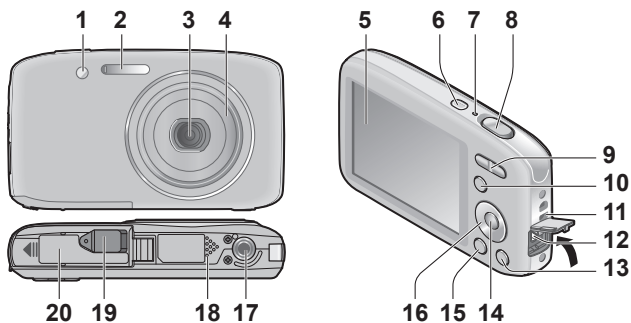

- 1 Self-timer indicator (→47)/AF Assist Lamp (→62)
- 2 Flash (→45)
- 3 Lens
- 4 Lens barrel
- 5 LCD monitor (→88)
- 6 Power button (→16)
- 7 Microphone (→25)
- 8 Shutter button (→20)
- 9 **DMC-FH6**
Zoom lever (→43)
- 10 **DMC-FH4** **DMC-S5** **DMC-S2**
Zoom button (→43)
- 10 [MODE] button (→18)
- 11 Hand strap eyelet
- 12 [AV OUT/DIGITAL] socket (→78, 82, 85)
- 13 [↵ / ↶] (Delete/Return) button (→31)
- 14 [MENU/SET] button
- 15 Playback button (→20)
- 16 Cursor button
- 17 Tripod receptacle
- 18 Speaker
- 19 DC coupler cover

We recommend using the supplied hand strap to avoid dropping the camera.

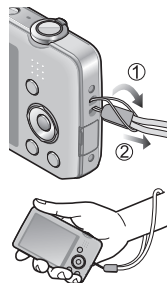

For shop display purpose only

- When using an AC adaptor, ensure that the Panasonic DC coupler (for shop display purpose only) and AC adaptor (for shop display purpose only) are used.

- 20 Card/Battery door (→12)

Cursor button

[MENU/SET]

(menu display/set) (→33)

Left cursor button (◀)

• Self-timer (→47)

Down cursor button (▼)

• Changing information display

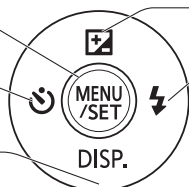
**Up cursor button (▲)**

• Exposure Compensation (→48)

Right cursor button (▶)

• Flash (→45)

● In this manual, the button that is used is shaded or indicated by ▲ ▼ ◀ ▶.

- The illustrations and screens in this manual may differ from the actual product.
- Do not block the microphone when recording motion pictures.
- Some tripods or unipods, and some methods of holding the camera may block the speaker, making it difficult to hear the beep, etc.

Charging battery

Always charge before first use! (battery shipped uncharged)

■ About batteries that you can use with this unit

It has been found that counterfeit battery packs which look very similar to the genuine products are made available to purchase in some markets. Some of these battery packs are not adequately protected with internal protection to meet the requirements of appropriate safety standards. There is a possibility that these battery packs may lead to fire or explosion. Please be advised that we are not liable for any accident or failure occurring as a result of use of a counterfeit battery pack. To ensure that safe products are used we recommend that a genuine Panasonic battery pack is used.

- Use the dedicated charger and battery.

1 Insert the battery terminals and attach the battery to the charger



2 Connect the charger to the electrical outlet

- Plug-in type
- Inlet type

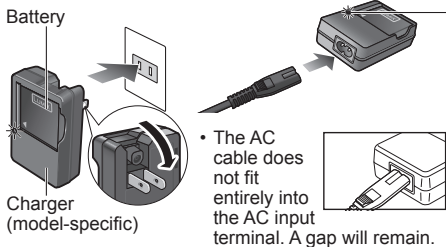

- Charge the battery with the charger indoors (10 °C to 30 °C (50 °F to 86 °F)).

3 Detach the battery after charging is completed

- The battery charger is in the standby condition when the AC power is supplied. The primary circuit is always "live" as long as the battery charger is connected to an electrical outlet.

Charging light ([CHARGE])

On: Charging in progress (approx. 120 min. if fully depleted)

Off: Charging complete

If light is flashing:

- Charging may take longer than normal if battery temperature is too high or too low (charging may not be completed).
- Battery/charger connector is dirty. Clean with a dry cloth.

Guidelines for number of recordable pictures and operating time

The number of recordable pictures or available operating time may vary according to surrounding environment and usage conditions. Figures may be reduced if flash, zoom, or other functions are used frequently, or in colder climates.

	DMC-FH6 DMC-S2	DMC-FH4 DMC-S5
Number of recordable pictures (Approx.)	280 pictures	260 pictures
Recording time (Approx.)	140 min.	130 min.

● Recording conditions by CIPA standard

- CIPA is an abbreviation of [Camera & Imaging Products Association].
- [Normal Picture] Mode.
- Temperature: 23 °C (73.4 °F) / Humidity: 50%RH when LCD monitor is on.
- Using a Panasonic SD Memory Card (32 MB).
- Using the supplied battery.
- Starting recording 30 seconds after the camera is turned on. (When the Optical Image Stabiliser function is set to [ON].)
- Recording once every 30 seconds with full flash every second recording.
- Perform a zoom operation every recording (W end → T end, or T end → W end)
- Turning the camera off every 10 recordings and leaving it until the temperature of the battery decreases.

Number reduced if intervals are longer – e.g. to approx. one quarter for 2-minute intervals under the above conditions.

Playback time (Approx.)	240 min.
-------------------------	----------

- The time required for charging varies depending on conditions of battery usage. Charging takes longer at high or low temperatures and when the battery has not been used for some time.
- Battery will be warm during charging and for some time thereafter.
- Battery will run out if not used for long periods of time, even after being charged.
- We do not recommend frequently charging the battery. (Frequently charging battery reduces maximum usage time and can cause battery to expand.)
- If available battery power is significantly reduced, battery is reaching end of lifespan. Please purchase a new battery.

Inserting and removing the card (optional)/ the battery

- 1 Turn off the power and slide the card/battery door out (①) before opening the door (②) as illustrated

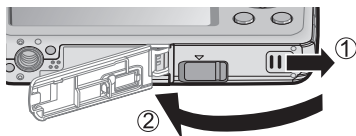

- 2 Insert the battery and card, making sure that their orientation is correct

- Battery: Insert all the way firmly until a locking sound is heard, and check that the lever is hooked over the battery.
- Card: Insert all the way firmly until it clicks.

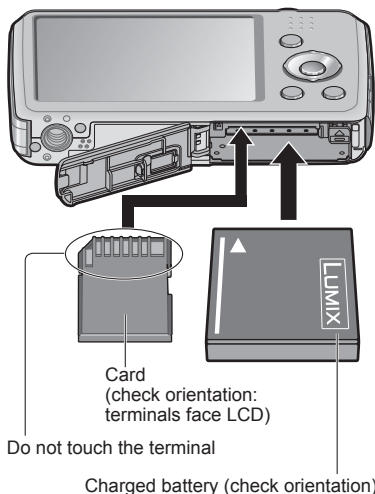

- 3 Close the card/battery door and slide the door in until you hear a locking sound

■ To remove

- **To remove battery:** Move lever in direction of arrow.

DMC-FH6

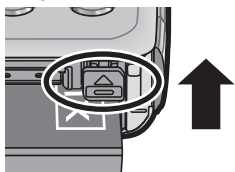

DMC-FH4

DMC-S5

DMC-S2

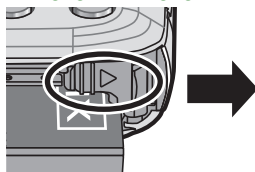

- **To remove card:** Press down in centre.

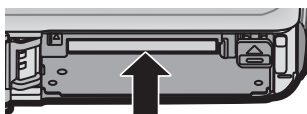

- Always use genuine Panasonic batteries.
- If you use other batteries, we cannot guarantee the quality of this product.
- Remove battery from camera after use.
 - Keep the battery in a plastic bag, making sure that it is kept away from metallic objects (such as clips) when carrying or storing the battery.
- To remove the card or battery, turn the camera off and wait until the LCD monitor display is completely blank. (Failure to wait may cause the camera to malfunction and may damage the card or recorded data.)
- Keep the Memory Card out of reach of children to prevent swallowing.

Picture save destination (cards and built-in memory)

■ Built-in memory (Approx. 70 MB)

- Pictures may be copied between cards and the built-in memory. (→77)
- The access time for the built-in memory may be longer than the access time for a card.

■ Compatible memory cards (optional)

The following SD standard-based cards (Panasonic brand recommended)

Type of Card	Capacity	Notes
SD Memory Cards	8 MB – 2 GB	<ul style="list-style-type: none"> • Using a card of SD speed “Class 6”* or above is recommended for recording motion pictures. • Can be used with devices compatible with the respective formats. • Before using SDXC Memory Cards, check that your computer and other devices support this type of card. http://panasonic.net/avc/sdcard/information/SDXC.html • Only the cards listed on the left with the given capacities are supported.
SDHC Memory Cards	4 GB – 32 GB	
SDXC Memory Cards	48 GB, 64 GB	

* SD speed class refers to a specification for sustained write speeds. Confirm the SD speed by checking the card label or other card related materials.

(Example)

CLASS 



- Please reformat the card with this camera if it has already been formatted with a computer or another device. (→39)
- If the write-protect switch is set to “LOCK”, the card cannot be used to record or delete pictures, and it cannot be formatted.
- It is recommended that you copy important pictures to your computer (as electromagnetic waves, static electricity, or faults may cause data to be damaged).
- Latest information:
<http://panasonic.jp/support/global/cs/dsc/> (This Site is English only.)



Switch

Remaining battery and memory capacity

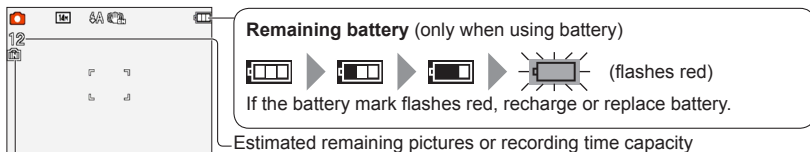

Displayed when no card is inserted (pictures will be saved to built-in memory)

When in operation

(Card) or (Built-in memory) are illuminated red.

While the light remains lit, an operation is taking place, such as picture writing or reading. While the light is lit, do not turn off the power or remove battery, card, AC adaptor (for shop display purpose only) or DC coupler (for shop display purpose only), as this can cause data loss or damage. Do not subject the camera to vibrations, impact, or static electricity. Should any of these cause camera operation to be terminated, attempt to perform the operation again.

Recording capacity guidelines (pictures/recording time)

The number of pictures you can take and the recording time vary in proportion to card capacity (and depending on recording conditions and type of card).

● If you make Web upload settings, the recording picture capacity and the recording time capacity of the card may be reduced.

■ Recording picture capacity (still pictures)

[Picture Size]	Built-in memory	2 GB	32 GB	64 GB
4:3 16M*1	11	300	4910	9880
4:3 14M*2	12	330	5490	10980
4:3 5M	25	650	10620	21490
4:3 0.3M	390	10050	162960	247160

• When the number of recordable pictures exceeds 99,999, "+99999" is displayed.

■ Recording time capacity (motion pictures)

[Rec Quality]	Built-in memory	2 GB	32 GB	64 GB
HD*1	–	10m10s	2h47m00s	5h39m00s
HD*2	–	8m10s	2h14m00s	4h32m00s
VGA	–	21m40s	5h54m00s	11h56m00s
QVGA	2m25s	1h02m00s	16h59m00s	34h21m00s

([h], [m] and [s] indicate "hour", "minute" and "second".)

• Motion pictures can be recorded continuously up to 2 GB.

The maximum available recording time for up to 2 GB only is displayed on the screen.

*1 DMC-S5 *2 DMC-FH6, DMC-FH4, DMC-S2

Setting the clock

The clock is not set when the camera is shipped.

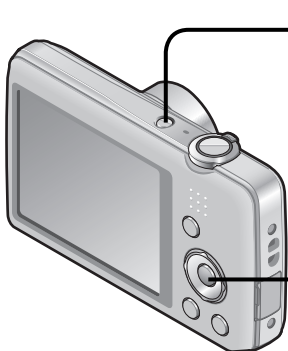

1 Press the Power button
The power is turned on.
If the language select screen is not displayed, proceed to step **4**.

2 Press [MENU/SET] while the message is displayed

3 Press ▲ ▼ to select the language, and press [MENU/SET]

- The [Please set the clock] message appears.

4 Press [MENU/SET]

5 Press ◀ ▶ to select the items (year, month, day, hour, minute, display order or time display format), and press ▲ ▼ to set

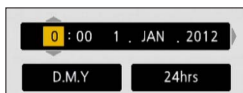

- To cancel → Press [⏪ / ⏩] button.

6 Press [MENU/SET]

7 Press [MENU/SET]

- To return to the previous screen, press [⏪ / ⏩] button.

- If the clock is not set, the correct date cannot be printed when you order a photo studio to print the picture, or when you stamp the date on the pictures with [Date Stamp].
- If the clock is set, the correct date can be printed even if the date is not displayed on the screen of the camera.

To change time setting

When resetting date and time, select [Clock Set] from the [Setup] menu.

- Clock settings will be saved for approx. 3 months even after battery is removed, provided a fully-charged battery was installed in the camera for 24 hours beforehand.

1 Select [Clock Set] from the [Setup] menu or [Rec] menu (→35)

2 Set the date and time



- Press ◀▶ to select the items (year, month, day, hour, minute, display order or time display format), and press ▲▼ to set.

To cancel → Press [⏏ / ↵] button.

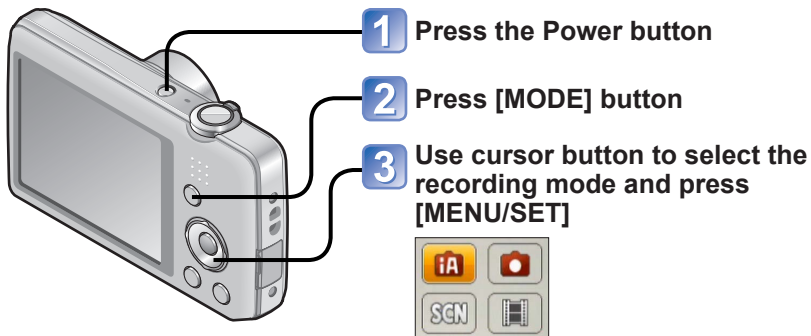
Sequence of operations



■ Recording mode

	[Intelligent Auto] Mode (→22) Take pictures with automatic settings.
	[Normal Picture] Mode (→40) Take pictures with your own settings.
SCN	[Scene Mode] (→49) Take pictures according to scene.
	[Motion Picture] Mode (→25) Take motion pictures.

■ Set [Rec] menu (→55) or [Setup] menu (→35) as required



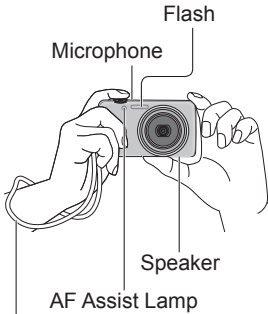

We recommend using the supplied hand strap to avoid dropping the camera.

4 Holding the camera

- To avoid camera shake, hold it with both hands keeping your arms close to your body and standing with your feet slightly apart.
- Do not touch the lens.
- Do not block the flash or the AF Assist Lamp. Do not look at it from close range.
- Try to hold the camera steady when you press the shutter button.
- Be careful not to block the microphone or the speaker.

Zoom In/Out

DMC-FH6

Capture a wider area (wide-angle)



Enlarge the subject (telephoto)

DMC-FH4

DMC-S5

DMC-S2

Capture a wider area (wide-angle)



Enlarge the subject (telephoto)

Flash, self-timer, and other functions

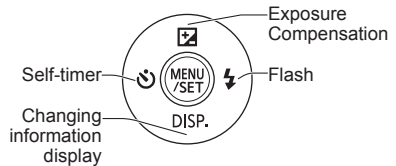

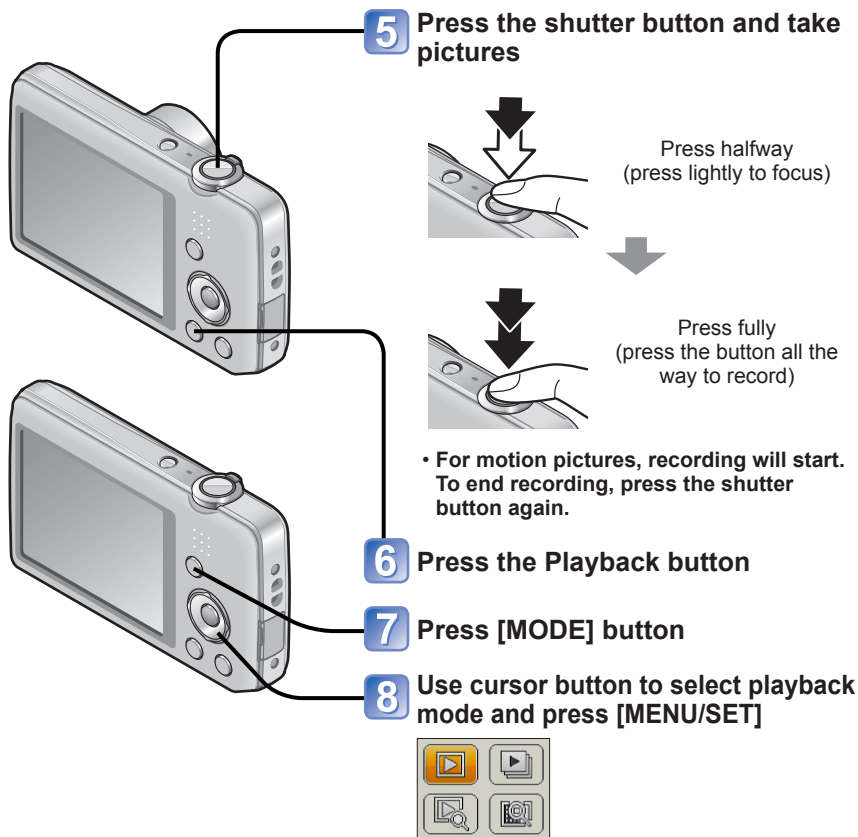

■ Playback mode

	[Normal Play] Mode (→26) Displays all pictures that can be played back.
	[Slide Show] Mode (→65) Automatically plays back the still pictures in order, in parallel with music.
	[Filtering Play] Mode (→66) Only pictures in selected categories and pictures set as favourite are displayed.
	[Calendar] Mode (→30, 67) Pictures recorded on the date selected on the calendar screen can be displayed.



9 Use cursor button to select a picture to be played back

- Play back motion pictures or panorama pictures
- [Auto Retouch]
- [Beauty Retouch] **DMC-FH6**

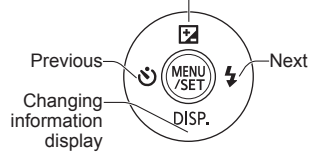

- Editing or performing settings for pictures using the Playback menu (→71)

10 Press the Power button

Taking pictures with automatic settings

[Intelligent Auto] Mode

Recording mode:   

Optimum settings are made automatically from information such as “face”, “movement”, “brightness”, and “distance” just by pointing the camera at the subject, meaning that clear pictures can be taken without the need to make settings manually.

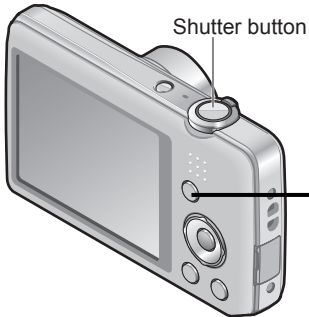

1 Display the screen for recording mode selection



2 Select [Intelligent Auto] Mode



3 Take pictures

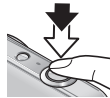

Press halfway
(press lightly to focus)

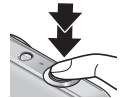

Press fully
(press the button all the way to record)

Focus display

(When focus is aligned: illuminated
When focus is not aligned: flashing)



Automatic Scene Detection

Camera reads scene when pointed at subject, and makes optimum settings automatically.



The icon of scene detected

	Recognises people
	Recognises landscapes
	Recognises night scenes and people in them (Only when is selected)*
	Recognises night scenes*
	Recognises close-ups
	Recognises sunsets
	Reads subject movement to avoid blurring when scene does not correspond to any of the above.

* We recommend using a tripod and the self-timer.

- Depending on recording conditions, different scene types may be determined for the same subject.
- If desired scene type is not selected, we recommend manually selecting the appropriate recording mode.
- When or is detected, Face Detection is activated, and the focus and exposure are adjusted for the recognised faces.
- About Backlight Compensation
Backlight is a condition where a light shines from behind a subject. When there is a backlight, a subject appears darker and the camera automatically corrects the exposure by increasing the brightness of an entire image. When the camera detects backlight, is displayed on the LCD monitor.

About flash

Press to select or .

- When is selected, the optimum flash is selected automatically depending on conditions. (→45)
- When or is selected, the red-eye reduction function is activated.
- When or is selected, the shutter speed is reduced.

About the Happy colour setting

When [Color Mode] (→62) is set to [Happy], pictures are recorded with vivid colouring.

■ Settings:

- ① Press [MENU/SET]
- ② Press or to select [Rec] menu and press [MENU/SET]
- ③ Press or to select [Color Mode] and press [MENU/SET]
- ④ Press or to select [Happy] and press [MENU/SET]

Notes on setting items

Only menu items which are displayed in the [Intelligent Auto] Mode can be set. The settings selected in the [Normal Picture] Mode or other modes are reflected for not displayed menu items on the [Setup] menu.

- The settings for the following items are different from other recording modes: [Picture Size], [Color Mode] and [Burst] **DMC-FH6** on the [Rec] menu
- The settings for the following functions are fixed:
 - [Auto Review] : [2 SEC.] **DMC-FH6**
 - [ON] **DMC-FH4** **DMC-S5** **DMC-S2**
 - [Stabilizer]: [ON]
 - [AF Assist Lamp]: [ON]
 - [i.Resolution]: [i.ZOOM]
 - [Auto Power Off]: [5 MIN.]
 - [White Balance]: [AWB]
 - [Sensitivity]: ISO
 - [AF Mode]: (Face Detection)*
 - [i.Exposure]: [ON]
 - [Red-Eye Removal]: [ON]
- * (23-area-focusing) when face cannot be recognised
- The following functions cannot be used: [Exposure], [Digital Zoom]

Taking motion pictures [Motion Picture] Mode

Recording mode:   SCN 

Microphone
(Do not block the microphone
with your fingers)



1 Display the screen for recording mode selection



2 Select [Motion Picture] Mode

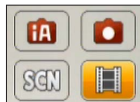
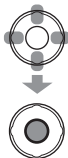

3 Start recording

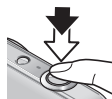

Press halfway
(adjust the focus)



Press fully
(start recording)

- Immediately release the shutter button after pressing it all the way.
- The focus and zoom will remain as they were at the beginning of recording.

4 End recording



Press fully

Remaining recording time (approx.)



Elapsed recording time

- Depending on the type of card used, a card-access display may appear for a while after motion picture recording. This is not a fault.
- In [AF Mode],  (23-area-focusing) is fixed.
- In [Stabilizer], [ON] is fixed.
- When there is no space left to store the motion picture, recording automatically ends. Additionally, recording in progress may be stopped, depending on the card used.

Viewing your pictures [Normal Play]

When a card is in the camera, pictures are played back from the card, and without a card, pictures are played back from the built-in memory.



1 Press the Playback button



- Press again to enter the recording mode.

2 Scroll through pictures



Previous Next



File number

Picture number/Total pictures

- Hold down to quickly scroll forwards/backwards.
- Press the shutter button to switch to recording mode.

■ Changing recording information display

Press ▼.

- It may not be possible to view pictures which were edited in a computer on this camera.
- After pressing the Playback button and switching it into the playback mode, the lens barrel will be retracted after approx. 15 seconds.
- This camera is compliant with the unified DCF (Design rule for Camera File system) standard formulated by the Japan Electronics and Information Technology Industries Association (JEITA), and with Exif (Exchangeable image file format). Files that are not DCF-compliant cannot be played back.

Viewing motion pictures

- 1** Select a picture with the motion picture icon, and press **▲**
Playback now starts.



Motion picture icon

Motion picture recording time
When playback starts, the elapsed playback time is displayed in the top right of the screen.
Example: After 3 minutes and 30 seconds: [3m30s]

■ Operations during motion picture playback

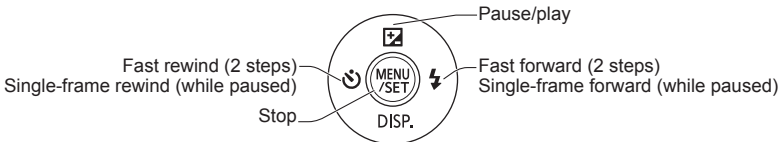

- Volume can be adjusted with the zoom lever or the zoom button.

- It may not be possible to properly play back motion pictures recorded using other cameras.
- Motion pictures can be viewed on your computer using "PHOTOfunSTUDIO" on the supplied CD-ROM.
- Be careful not to block the speaker.

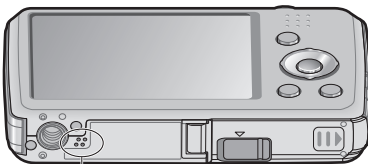

Speaker

Zooming in and viewing "Playback Zoom"

DMC-FH6

Turn the zoom lever to T side

DMC-FH4**DMC-S5****DMC-S2**

Press the T side of the zoom button

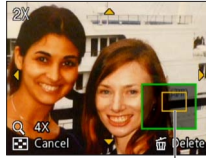

Current zoom position (displayed for 1 sec.)

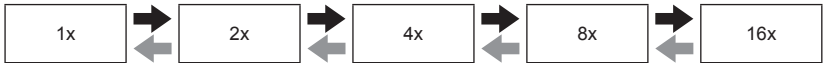

➔ **DMC-FH6** Turn the zoom lever to T side/

DMC-FH4 **DMC-S5** **DMC-S2** Press the T side of the zoom button

➜ **DMC-FH6** Turn the zoom lever to W side/

DMC-FH4 **DMC-S5** **DMC-S2** Press the W side of the zoom button

- Move zoom position → Use cursor button to move the zoom position

- Playback zoom cannot be used during motion picture playback.

Viewing a list of pictures “Multi Playback”

DMC-FH6

Turn the zoom lever to W side

DMC-FH4**DMC-S5****DMC-S2**

Press the W side of the zoom button

Picture no./Total no.



Motion pictures

Panorama pictures



➔ **DMC-FH6** Turn the zoom lever to W side/
DMC-FH4 **DMC-S5** **DMC-S2** Press the W side of the zoom button

⬅ **DMC-FH6** Turn the zoom lever to T side/
DMC-FH4 **DMC-S5** **DMC-S2** Press the T side of the zoom button

- When you select a picture using the cursor button and press [MENU/SET] on the 12-picture or 30-picture screen, the selected picture is displayed on the 1-picture screen (full-screen).
- Pictures displayed with [!] cannot be played back.

Viewing pictures by their recording date “Calendar Playback”

DMC-FH6

Turn the zoom lever to W several times

DMC-FH4**DMC-S5****DMC-S2**

Press the W side of the zoom button several times

Selected date (First picture from the date)

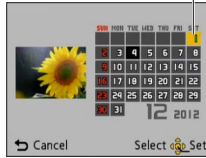

➔ **DMC-FH6** Turn the zoom lever to W side/
DMC-FH4 **DMC-S5** **DMC-S2** Press the W side of the zoom button

⬅ **DMC-FH6** Turn the zoom lever to T side/
DMC-FH4 **DMC-S5** **DMC-S2** Press the T side of the zoom button

- When you select a recording date using the cursor button and press [MENU/SET], the display method changes to the 12-picture screen.
- Only months when pictures were taken are shown on the calendar screen. Pictures taken without clock settings are displayed with the date 1st January, 2012.
- Pictures taken with destination settings made in [World Time] are displayed in the calendar screen using the appropriate date for the destination's time zone.

Deleting pictures

Pictures will be deleted from the card if the card is inserted, or from the built-in memory if the card is not inserted. (Deleted pictures cannot be recovered.)



1 Press to delete displayed picture



- A confirmation screen is displayed. Select [Yes] with cursor button and then press [MENU/SET].

- Do not turn off the power during deletion.
- Use a sufficiently charged battery.
- Pictures cannot be deleted in the following cases:
 - Protected pictures
 - Card switch is in "LOCK" position.
 - Pictures not of DCF standard (→26)

To delete multiple (up to 50)/To delete all pictures

1 Press to delete displayed picture

2 Select [Delete Multi]/[Delete All]

[Delete Multi]

- ① Use cursor button to select picture and press [MENU/SET].
 - To cancel → Press [MENU/SET] again.
- ② Use cursor button to select [OK] and press [MENU/SET].



 Picture selected

- You can select [All Delete Except Favorite] in [Delete All] if there are pictures that have been set as [Favorite] (→74).
- A confirmation screen is displayed. Select [Yes] with cursor button and then press [MENU/SET].
- May take time depending on number of pictures deleted.

Setting the menu

Refer to the procedure below for example on how to operate the menus.

Example: Changing [AF Mode] in the [Rec] menu in [Normal Picture] Mode

1 Press [MENU/SET]

The menu selection screen is displayed.

2 Select [Rec] menu and press [MENU/SET]



3 Press ▲ ▼ to select [AF Mode] and press [MENU/SET]

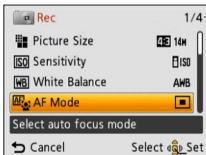

Pages

The pages can also be selected with the zoom lever or the zoom button.

4 Press ▲ ▼ to select a setting, and then press [MENU/SET]

The selected setting is set.

- To cancel → Press [⏪ / ⏩] button.

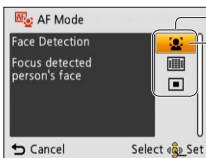

Settings

Selected setting

5 Press [⏪ / ⏩] button several times

The menu closes and the monitor returns to the previous screen.

- The operation screen examples in this manual may differ from the actual screen display or some parts of the screen display are omitted.
- The menu types and items that are displayed vary according to the mode.
- The setting methods vary depending on the menu item.
- In recording mode, the menu screen can also be exited by pressing the shutter button halfway.

Menu type

[Rec] menu (In recording mode only)

Changing picture preferences (→55)

- Enables you to set the colouring, picture size, and other items.

[Setup] menu

Making the camera more convenient to use (→35)

- Enables you to specify clock settings, sound volume, and so on to make the camera easier to use.

[Playback] menu (In playback mode only)





Using your pictures (→71)

- Enables you to specify picture protection, resizing, and other settings for pictures you have taken.

Using the [Setup] menu

[Clock Set], [Auto Power Off] and [Auto Review] are important for clock setting and battery life. Please check these before use.

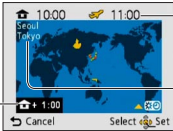



- For details about the setting procedure in the [Setup] menu (→33)

Item	Settings, notes
 [Clock Set] (→16)	Set time, date, and display format.
 [World Time] Set the local time at travel destination.	<p>Message will be displayed when setting for the first time. In this case, press [MENU/SET] and skip to step ②.</p> <ol style="list-style-type: none"> ① Use cursor button to select [Home] or [Destination] and press [MENU/SET] ② Use cursor button to select area and press [MENU/SET] <div style="text-align: center;">  </div> <p>Current time at selected destination</p> <p>City/area name</p> <p>Difference with home time</p> <p>When [Destination] has been selected</p> <p>■ To set summer time Press ▲ in step ②. (Press again to release the setting)</p> <ul style="list-style-type: none"> • If you cannot find your destination in the area displayed on the screen, set based on difference with home time. •  is displayed on the screen for pictures recorded at the destination when they are played back. • When summer time is set, the current time is advanced by 1 hour. If the setting is cancelled, the time automatically returns to the current time.









- For details about the setting procedure in the [Setup] menu (→33)

Item	Settings, notes
<p>DMC-FH6 ■))) [Beep] Change or mute the beep/shutter sounds.</p>	<p>[Beep Level] / / : Low / High / Mute</p> <p>[Beep Tone] / / : Change beep tone.</p> <p>[Shutter Vol.] / / : Low / High / Mute</p> <p>[Shutter Tone] / / : Change shutter tone.</p>
<p>DMC-FH4 DMC-S5 DMC-S2 ■))) [Beep] Adjust volume of beep sounds.</p>	<p> / / : Low / High / Mute</p>
<p> [Volume] Adjust volume of sound from speakers (7 levels).</p>	<p>[0] / [1] / [2] / [3] / [4] / [5] / [6]</p> <ul style="list-style-type: none"> • Cannot be used to adjust TV speaker volume when connected to TV.
<p> [LCD Display] Adjust brightness and colour of the LCD monitor.</p>	<p>① Press ▲▼ to select the setting item and press ◀▶ to make adjustments ② Press [MENU/SET]</p> <ul style="list-style-type: none"> • Some subjects may look different from their actual appearance, but the recorded picture will not be affected.



- For details about the setting procedure in the [Setup] menu (→33)

Item	Settings, notes
 [Focus Icon] Change the focus icon.	
 [Auto Power Off] Turn off the power when you are not using the camera to minimise battery consumption.	[2 MIN.] / [5 MIN.] / [10 MIN.] / [OFF] <ul style="list-style-type: none"> • To restore → Press the Power button • Cannot be used in the following cases: When connected to computer/printer, during motion picture recording/playback, during Slide Shows, during automatic demo playback • Settings fixed to [5 MIN.] in [Intelligent Auto] Mode.
 [Auto Review] Automatically display still pictures immediately after taking them.	DMC-FH6 [1 SEC.] / [2 SEC.] [HOLD]: Auto review screen remains until a button (other than ▼) is pressed [OFF]
 [Reset] Reset to the default settings.	[Reset Rec. settings?] [Reset setup parameters?] <ul style="list-style-type: none"> • When the setup parameters settings are reset, [Age] for [Baby] and [Pet] Scene Modes are also reset. • Folder numbers and clock settings will not be reset. • Camera movement may be audible as the lens function is reset. This is not a fault.

- For details about the setting procedure in the [Setup] menu (→33)

Item	Settings, notes
 [Output] Adjust the settings used when the camera is connected to a TV, etc. via the AV cable. (Playback mode only.)	 [Video Out] [NTSC] / [PAL]  [TV Aspect] 16:9 / 4:3
 [Rotate Disp.] Automatically rotate portrait still pictures.	  : Rotate and display pictures displayed on a TV screen as well as those displayed on the LCD monitor of the camera in portrait orientation.  : Rotate and display only pictures displayed on a TV screen in portrait orientation. [OFF] <ul style="list-style-type: none"> • [Rotate Disp.] cannot be used with motion pictures. • Still pictures taken with the lens surface facing up or down, or still pictures taken on other cameras may not rotate. • Pictures cannot be rotated during Multi Playback. • Will only be displayed rotated on computer if in Exif-compatible (→26) environment (OS, software).
 [Version Disp.] Check the version of the camera firmware.	Current version is displayed.

- For details about the setting procedure in the [Setup] menu (→33)

Item	Settings, notes
 [Format] Use when [Built-In Memory Error] or [Memory Card Error] appears, or when formatting the built-in memory or card. When a card/built-in memory is formatted, the data cannot be restored. Check the content of the card/built-in memory carefully before formatting.	<ul style="list-style-type: none"> • This requires a sufficiently charged battery. When formatting the built-in memory, remove the cards. (Only inserted card will be formatted if present; built-in memory will be formatted if no card is inserted.) • Always format cards with this camera. • All protected pictures and other picture data will be deleted. • Do not turn off power or perform other operations during formatting. • Formatting the built-in memory may take several minutes. • Consult the dealer or your nearest Service Centre if format cannot be successfully completed.
 [Language] Change display language.	Set the language displayed on the screen.
DEMO [Demo Mode] View demonstration of functions.	<p>[Stabilizer Demo.] Extent of jitter is shown on graph (estimate)</p>  <p>• During demo screen display, the Optical Image Stabiliser switches ON and OFF every time [MENU/SET] is pressed.</p> <p>[Auto Demo]: View introductory Slide Show [ON] / [OFF]</p> <ul style="list-style-type: none"> • [Auto Demo] cannot be displayed on external devices such as TVs.

Taking pictures with your own settings

[Normal Picture] Mode

Recording mode:   SCN  HEH

Using the [Rec] menu to change settings and set up your own recording environment.

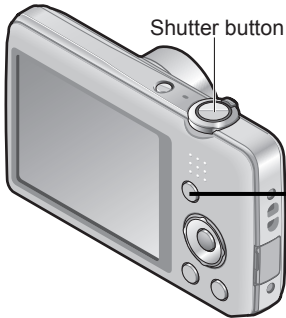

1 Display the screen for recording mode selection



2 Select  [Normal Picture] Mode



3 Take a picture

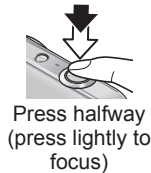

■ Changing recording information display

Press .

- If a warning is displayed about jitter, use [Stabilizer], a tripod, or [Selftimer].
- If aperture and shutter speed are shown in red, you do not have appropriate exposure. Either use the flash or change the "ISO Sensitivity" settings.

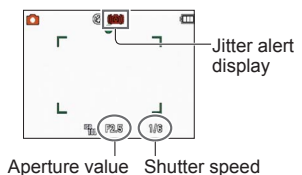

How to adjust focus

Useful when subject is not in centre of picture.

1 First adjust focus according to subject

Align the AF area with the subject

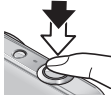

Hold down halfway



Focus display

(When focus is aligned: illuminated
When focus is not aligned: flashing)

AF area

(When focus is aligned: green
When focus is not aligned: red)

2 Return to desired composition



Press fully



AF area

- Subjects/environments which may make focusing difficult:
 - Fast-moving or extremely bright objects, or objects with no colour contrast.
 - Taking pictures through glass or near objects emitting light. In dark, or with significant jitter.
 - When too close to object or when taking pictures of both distant and close objects together in the same picture.

■ Focus range

Zoom position	The shortest focusing distance from the surface of the lens
W end	5 cm (0.16 feet)
T end	1 m (3.3 feet)

* When the zoom is operated from the W (wide-angle) end to the T (telephoto) end, the shortest focusing distance changes in stages.

- The focus display flashes and beep sounds when focus is not aligned.
Use the focus range displayed in red as a reference.
Even if the focus display is lit, the camera may be unable to bring the subject into focus if it is out of range.
- The AF area display size may increase when adjusting the focus when it is dark and depending on the zoom ratio used.



Using zoom

Recording mode:    

You can adjust the area of a picture to be taken using zoom.

DMC-FH6

Capture a wider area
(wide-angle)



Enlarge the subject
(telephoto)

DMC-FH4

DMC-S5

DMC-S2

Capture a wider area
(wide-angle)



Enlarge the subject
(telephoto)

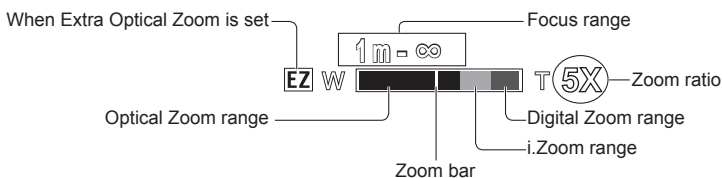

- Adjust the focus after adjusting the zoom.
- Do not touch the lens barrel during zooming.
- The zoom ratio and the zoom bar displayed on the screen are estimates.
- The camera may make a rattling noise and vibrate when the zoom lever or the zoom button is operated - this is not a fault.

Zoom types and use

The zoom ratio changes when the number of recording pixels is changed. (→55)



■ Optical Zoom

Zooming in up to 5 times **DMC-FH6** /4 times **DMC-FH4** **DMC-S5** **DMC-S2** is possible if pictures without **EZ** have been selected by [Picture Size] on the [Rec] menu.

- Optical Zoom cannot be used in [Panorama Shot] Scene Mode.

■ Extra Optical Zoom



When you select a picture size with **EZ** for [Picture Size] on the [Rec] menu, you can zoom pictures to a higher zoom ratio with no deterioration in picture quality. The zoom ratio changes in accordance with the picture size setting. EZ is short for “Extra Optical Zoom.”

- Extra Optical Zoom cannot be used in the following cases:
 - [Motion Picture] Mode
 - Scene Modes ([Panorama Shot] [High Sens.] and [Photo Frame])
 - When the [Burst] setting is set to  or  **DMC-FH6**

To increase the zoom ratio further, the following zoom can be used in combination.



■ i.Zoom

You can use the camera's super resolution technology to increase the zoom ratio up to 2 times higher than the original zoom ratio while preventing deterioration of picture quality. Select [i.ZOOM] on [i.Resolution] in the [Rec] menu. (→59)

- When [i.Resolution] is set to [i.ZOOM], super resolution technology is applied to the picture.
- [i.ZOOM] cannot be used in the following cases:
 - [Motion Picture] Mode
 - Scene Modes ([Panorama Shot] and [High Sens.]
 - When the [Burst] setting is set to  or  **DMC-FH6**

■ Digital Zoom

Zoom 4 times further than Optical/Extra Optical Zoom. Note that, with Digital Zoom, enlarging will decrease picture quality. Set the [Digital Zoom] in the [Rec] menu to [ON]. (→59)

- Digital Zoom cannot be used in the following modes:
 - [Intelligent Auto] Mode
 - Scene Modes ([Panorama Shot] [High Sens.] and [Photo Frame])
 - When the [Burst] setting is set to  or  **DMC-FH6**
 - When Digital Zoom is used simultaneously with i.Zoom, you can only increase the zoom ratio up to 2 times.

Taking pictures with flash

Recording mode:

- 1 Press **▶** to display [Flash]
- 2 Use cursor button to select the desired type and press **[MENU/SET]**

Type, operations	Uses
[Auto] <ul style="list-style-type: none">Automatically judges whether or not to flash	Normal use
[Auto/Red-Eye]* <ul style="list-style-type: none">Automatically judges whether or not to flash (reduce red-eye)	Taking pictures of subjects in dark places
[Forced Flash On] <ul style="list-style-type: none">Always flash	Taking pictures with backlight or under bright lighting (e.g. fluorescent)
[Slow Sync./Red-Eye]* <ul style="list-style-type: none">Automatically judges whether or not to flash (reduce red-eye; slow shutter speed to take brighter pictures)	Taking pictures of subjects against a nightscape (tripod recommended)
[Forced Flash Off] <ul style="list-style-type: none">Never flash	Places where flash use is prohibited

* Two flashes will be emitted. Do not move until after the second flash. Interval between flashes varies according to brightness of subject.

If [Red-Eye Removal] on the [Rec] menu is [ON], the appears with the flash icon, red-eye is automatically detected and still picture data is corrected. (Only when [AF Mode] is (Face Detection))

- The effect of red-eye reduction varies depending on the subject and is affected by factors such as distance to the subject, whether the subject is looking at the camera during preliminary flash, and so on. In some cases, the effect of red-eye reduction may be negligible.
- **Do not put your hands over the light-emitting area of the flash or look at it from close range (a few centimetres away). Do not use the flash at close distances to other subjects (heat/light may damage subject).**
- Flash settings may be changed when changing recording mode.
- Scene Mode flash settings are restored to default when Scene Mode is changed.
- No pictures may be taken if these marks (e.g.) are flashing (flash is charging).
- If light from the flash on a subject is insufficient, neither the proper exposure nor White Balance is not achieved.
- The flash effect may not be sufficient in the following cases:
 - Slow shutter speed
 - [Flash Burst] is set **DMC-FH6**
- Flash charging may take time if battery is low, or if using flash repeatedly.

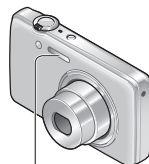

Flash

Available types in each mode (○: Available, –: Not available, □: Default setting)

			[Scene Mode]									
	○	○*1	○	○	○	–	○	○	○	○	○	
	○	–	○	○	–	–	–	○	–	–	○	
	○	–	○	○	○	–	○	○	○	○	○	
	–	–	–	–	–	○	–	–	–	–	–	
	○	○	○	○	○	○	○	○	○	○	○	

*1 Set to , , or depending on the subject and brightness.

- The flash cannot be used when recording motion pictures or Scene Modes , , or .

The available flash range when [Sensitivity] setting is [ISO]

DMC-FH6

Max. W	Approx. 40 cm-4.1 m (1.3 feet-13 feet)
Max. T	Approx. 1.0 m-1.6 m (3.3 feet-5.2 feet)

DMC-FH4

DMC-S5

DMC-S2

Max. W	Approx. 40 cm-3.3 m (1.3 feet-11 feet)
Max. T	Approx. 1.0 m-1.6 m (3.3 feet-5.2 feet)

Shutter speeds for each flash mode

	1/60 - 1/1600th
	1/8*2 - 1/1600th

*2 Max. 1/4 sec. when [ISO] in [Sensitivity] is set; max. 1 sec. when [Stabilizer] is set to [OFF] or when blur is insignificant. Also varies according to [Intelligent Auto] Mode and Scene Modes, etc.

Taking pictures with self-timer

Recording mode:    

We recommend using a tripod. This is also effective for correcting jitter when pressing the shutter button, by setting the self-timer to 2 seconds.

1 Press  to display [Selftimer]

2 Use cursor button to select time duration and press [MENU/SET]

3 Take a picture

Press the shutter button fully to start recording after the preset time.

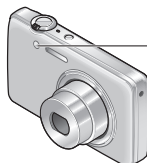

Self-timer indicator
(Flashes for set duration)

- To cancel while in operation → Press [MENU/SET]

- Focus will be automatically adjusted immediately before recording if shutter button is pressed fully here.
- After Self-timer indicator stops flashing, it may then be lit for AF Assist Lamp.

Taking pictures with Exposure Compensation

Recording mode:    

Corrects exposure when adequate exposure cannot be obtained (if difference between brightness of object and background, etc.).

1 Press to display [Exposure]

2 Use cursor button to select a value and press [MENU/SET]

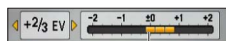

No compensation: ± 0

- If the picture is too dark, adjust the exposure to the “+” direction.
- If the picture is too bright, adjust the exposure to the “-” direction.
- After exposure adjustment, the adjustment value ( +1/3 for example) is displayed in the bottom-left corner of the screen.
- The Exposure Compensation value you set is retained even after the camera is turned off.

- Depending on the brightness, this may not be possible in some cases.

Taking pictures according to the scene

[Scene Mode]

Recording mode:   **SCN** 

Using [Scene Mode] enables you to take pictures with optimum settings (exposure, colouring, etc.) for given scenes.



1 Display the screen for recording mode selection



2 Select SCN [Scene Mode]

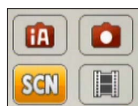



3 Select and set the scene

● Scene menu



- Selecting a Scene Mode inappropriate for the actual scene may affect the colouring of your picture.
- Following [Rec] menu settings will be automatically adjusted and cannot be selected manually.
[Sensitivity], [i.Exposure], [i.Resolution], [Color Mode]
- Using flash in Scene Modes (→46)

- How to select a scene (→49)
- Using flash in Scene Modes (→45)

 [Portrait]	<p>Improves the skin tone of subjects for a healthier appearance in bright daylight conditions.</p> <p>Tips</p> <ul style="list-style-type: none"> • The closer the zoom is positioned to the T (telephoto) edge and the closer the camera is brought to the subject, the greater the effect will be.
 [Soft Skin]	<p>Smooths skin colours in bright, outdoor daylight conditions (portraits from chest upwards).</p> <p>Tips</p> <ul style="list-style-type: none"> • The closer the zoom is positioned to the T (telephoto) edge and the closer the camera is brought to the subject, the greater the effect will be.
 [Scenery]	<p>Takes clear pictures of wide, distant subjects.</p>

- How to select a scene (→49)
- Using flash in Scene Modes (→45)



[Panorama Shot]

Creates a single panorama picture by stitching multiple still pictures taken in rapid succession.

- ① Use cursor button to select the recording direction, and press [MENU/SET] to set
- ② Check the recording direction and press [MENU/SET]
Special panorama guidelines will be displayed during recording.
- ③ Press the shutter button halfway to focus
- ④ Press the shutter button fully and pan the camera in a small circular motion in the selected direction to start recording
 - Taking pictures from left to right

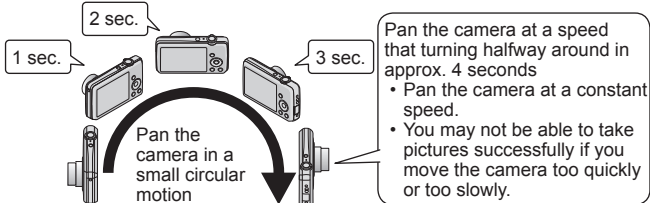

- ⑤ Press the shutter button fully again to end recording
 - You can also end the recording when you stop panning the camera while taking pictures.

Tips

- Pan the camera in the recording direction as steadily as possible.

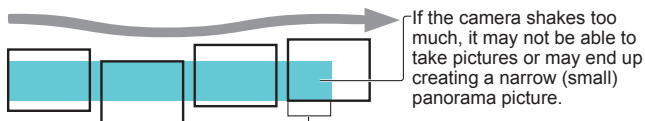

The subjects that are displayed in this range are recorded. (guideline)

- How to select a scene (→49)
- Using flash in Scene Modes (→45)



[Panorama Shot] (Continued)

Notes





- The zoom position is fixed to the W end.
- Since the focus, White Balance, and Exposure Compensation are all fixed when settings are made for the first picture, recording settings such as brightness and colour may not be optimal for subsequent pictures.
- The following functions are fixed to the settings indicated below.
[Stabilizer]: [OFF] [Date Stamp]: [OFF]
- For some subjects, the recorded pictures may be distorted or the joined sections of multiple successively taken pictures that are stitched may be also noticeable.
- Picture size varies depending on the recording direction and number of stitched pictures.
The maximum number of recording pixels is as follows:
 - Taking pictures in landscape orientation: Approx. 2M (3200×720)
 - Taking pictures in portrait orientation: Approx. 3M (960×3200)
- Panorama pictures may not be created or pictures may not be recorded properly when taking pictures of the following subjects or when taking pictures in the following recording conditions:
 - Subjects that have a continuous monotone or pattern (sky, beach, etc.)
 - Moving subjects (person, pet, vehicle, waves, or flowers swaying in the wind, etc.)
 - Subjects whose colours or patterns change quickly (large displays, etc.)
 - Dark locations
 - Locations with a flickering light source (fluorescent lamp, candle light, etc.)

About panorama playback







You can operate the zoom lever/zoom button to enlarge pictures taken in [Panorama Shot] mode in the same way as with other still pictures. You can also press ▲ to automatically scroll pictures in the same way as when playing back a motion picture.

- Unlike motion picture playback, you cannot perform fast forward or rewind by pressing ◀ or ▶ while the pictures are scrolling automatically. (You can perform single-frame forward or rewind while the automatic scrolling operation is paused.)

- How to select a scene (→49)
- Using flash in Scene Modes (→45)

 [Sports]	<p>Takes pictures of scenes with fast movement, e.g. sports.</p> <p>Tips</p> <ul style="list-style-type: none"> • Stand at least 5 m (16 feet) away. <p>Notes</p> <ul style="list-style-type: none"> • Shutter speed may slow down up to 1 second.
 [Night Portrait]	<p>Takes pictures of people and nightscapes with close to actual brightness.</p> <p>Tips</p> <ul style="list-style-type: none"> • Use flash. • Subject should not move. • Tripod, self-timer recommended. <p>Notes</p> <ul style="list-style-type: none"> • Shutter speed may slow down up to 8 seconds. • After recording, the shutter may stay closed (up to 8 seconds) to process the signal. This is not a malfunction.
 [Night Scenery]	<p>Takes clear pictures of night scenes.</p> <p>Tips</p> <ul style="list-style-type: none"> • Tripod, self-timer recommended. <p>Notes</p> <ul style="list-style-type: none"> • Shutter speed may slow down up to 8 seconds. • After recording, the shutter may stay closed (up to 8 seconds) to process the signal. This is not a malfunction.
 [Food]	<p>Takes natural-looking pictures of food.</p>

- How to select a scene (→49)
- Using flash in Scene Modes (→45)

  <p>[Baby]</p>	<p>Uses weak flash to bring out skin colours. ([Baby1] and [Baby2] can be set separately.)</p> <ol style="list-style-type: none"> ① Use cursor button to select [Age] and press [MENU/SET]. ② Use cursor button to select [SET] and press [MENU/SET]. ③ Set birthday with cursor button, and press [MENU/SET]. ④ Use cursor button to select [Exit] and press [MENU/SET]. <p>Tips</p> <ul style="list-style-type: none"> • Make sure [Age] is [ON] before taking a picture. <p>Notes</p> <ul style="list-style-type: none"> • Age display format depends on [Language] setting. • Shutter speed may slow down up to 1 second. • [Age] print setting can be made on your computer using the supplied CD-ROM "PHOTOfunSTUDIO".
 <p>[Pet]</p>	<p>Records pet's age when taking pictures.</p> <ul style="list-style-type: none"> • Refer to [Baby] for other tips and notes.
 <p>[Sunset]</p>	<p>Takes clear pictures of scenes such as sunsets.</p>
 <p>[High Sens.]</p>	<p>Prevents blurring of subject in dark, indoor conditions.</p> <p>Select the aspect ratio and the picture size with cursor button and press [MENU/SET].</p>
 <p>[Glass Through]</p>	<p>Most suitable for taking pictures such as a landscapes through the transparent glass of a train/vehicle or building.</p> <p>Notes</p> <ul style="list-style-type: none"> • If there are stains such as dust or a reflection on the glass, the camera may focus on the glass instead of a subject. • The colour of pictures may appear unnatural due to the colour of the glass. (You may be able to reproduce the appropriate colour by adjusting the White Balance.)
 <p>[Photo Frame]</p>	<p>A frame is superimposed over the image.</p> <p>Use cursor button to select the frame, and then press [MENU/SET].</p> <p>Notes</p> <ul style="list-style-type: none"> • The recording pixel level is 5 M (4:3). • Guide lines cannot be displayed.

Using the [Rec] menu

[Picture Size]

- For [Rec] menu setting procedures (→33)

Set the size (number of pixels) of still pictures. Number of pictures which can be recorded depends on this setting.

■ Recording mode:

■ Settings:

DMC-FH6 **DMC-FH4** **DMC-S2**

Recording pixel level type		
	14 M	4320×3240
	10 M	3648×2736
	5 M	2560×1920
	3 M	2048×1536
	0.3 M	640×480
	12.5 M	4320×2880
	10.5 M	4320×2432
	10.5 M	3232×3232

DMC-S5

Recording pixel level type		
	16 M	4608×3456
	10 M	3648×2736
	5 M	2560×1920
	3 M	2048×1536
	0.3 M	640×480
	14 M	4608×3027
	12 M	4608×2592
	12 M	3456×3456

* This setting is not available in ([Intelligent Auto] Mode).

- represent the aspect ratios of the still pictures.
- Mosaic effect may appear depending on subject and recording conditions.

Setting guide

Larger picture size	←→	Smaller picture size
Crisper picture		Coarser picture
Lower recording capacity		Higher recording capacity

[Rec Quality]

- For [Rec] menu setting procedures (→33)

Set the picture size of motion pictures.

■ **Recording mode:**   

■ **Settings:**

Picture Quality	Picture Size	No. of Frames	Picture Aspect Ratio
[HD]	1280 × 720 pixels	24 fps*1 / 30 fps*2	16:9
[VGA]	640 × 480 pixels	30 fps	4:3
[QVGA]*3	320 × 240 pixels		

*1 DMC-S5

*2 DMC-FH6, DMC-FH4, DMC-S2

*3 [QVGA] is fixed when recording to the built-in memory.

- Depending on the motion picture recording environment, static electricity or electromagnetic waves may cause the screen to go black momentarily or noise to be recorded.
- If you attempt to play motion pictures recorded with the camera on other devices, playback may not be possible, or the picture or sound quality may be poor. Additionally, incorrect recording information may be indicated.

[Sensitivity]

- For [Rec] menu setting procedures (→33)

Set ISO Sensitivity (sensitivity to lighting) manually.

We recommend higher settings to take clear pictures in darker locations.

■ **Recording mode:**   

■ **Settings:**  ISO [Intelligent ISO] / [100] / [200] / [400] / [800] / [1600]

Setting guide

[Sensitivity]	[100] ←	↔	→ [1600]
Location (recommended)	Bright (outdoors)		Dark
Shutter speed	Slow		Fast
Interference	Low		High
Jitter of the subject	Increased		Less

- [ ISO] is automatically set in a range up to 1600 based on subject movement and brightness.

[White Balance]

- For [Rec] menu setting procedures (→33)

Adjust colouring to suit light source if colours otherwise appear unnatural.

■ **Recording mode:**

■ **Settings:** [AWB] (automatic) / (outdoor, clear sky) / (outdoor, cloudy sky) / (outdoor, shade) / (incandescent lighting) / (uses value set in _SET) / _SET (set manually)

[AWB] operational range:

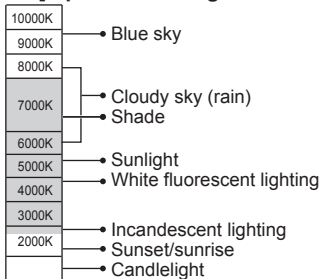

K=Kelvin colours Temperature

■ **Setting White Balance manually** (_SET)

- ① Select _SET and press [MENU/SET].
- ② Point the camera towards a white object (e.g. paper) and press [MENU/SET].
 - White Balance is set to .
 - The White Balance you set is retained even after the power is turned off.
 - White Balance setting may not be possible if the subject is too bright or too dark. In such cases, adjust the subject to an appropriate brightness, and then set the White Balance again.

Only takes picture of white objects within frame (step ②)



- A picture may appear reddish or bluish when the White Balance is outside the [AWB] operational range. Even if the White Balance is within the [AWB] operational range, this function may not work correctly if there are multiple light sources.
- Under fluorescent lighting, LED lighting fixture etc., the appropriate White Balance will vary depending on the lighting type, so use [AWB] or _SET.
- White Balance setting is fixed to [AWB] in the following Scene Modes: [Scenery], [Night Portrait], [Night Scenery], [Food], and [Sunset]
- If the Scene Mode is changed, the white balance setting returns automatically to [AWB].



[AF Mode]

- For [Rec] menu setting procedures (→33)

Method of aligning focus can be changed according to position and number of subjects.

■ **Recording mode:**    

■ **Settings:**  /  / 

<p>Taking front-on pictures of people</p> <p> (Face Detection)</p>	<p>Recognises faces (up to 15 people) and adjusts exposure and focus accordingly.</p> <p>AF area Yellow : When the shutter button is pressed halfway, the frame turns green when the camera is focused. White : Displayed when more than one face is detected. Other faces that are the same distance away as faces within the yellow AF area are also focused.</p>
<p>Subject not centred in picture</p> <p> (23-area-focusing)</p>	<p>Focuses on up to 23 points in each AF area. (AF area not displayed until focused)</p>
<p>Determined position for focus</p> <p> (1-area-focusing)</p>	<p>Focuses on AF area in centre of picture. (Recommended when focus is difficult to align)</p>

- Cannot set to “Face Detection” in the following cases:
[Panorama Shot], [Night Scenery], [Food] Scene Modes
- If the camera misinterprets a non-human subject as a face in the “Face Detection” setting, switch to another setting.
- If conditions prevent the face from being recognised, such as when the movement of the subject is too rapid, the [AF Mode] setting switches to  (23-area-focusing).

[i.Exposure]

- For [Rec] menu setting procedures (→33)

Automatically adjusts contrast and exposure to give more lifelike colours when there is significant contrast between background and subject.

■ **Recording mode:**    

■ **Settings:** [ON] / [OFF]

- When [i.Exposure] works, the colour of **i**  changes.
- Even if [Sensitivity] is set to [100], when [i.Exposure] is activated, pictures may be taken at a higher ISO Sensitivity than the setting.

[i.Resolution]

- For [Rec] menu setting procedures (→33)

You can use the camera's super resolution technology to record still pictures with sharper outlines and clearer resolution. Also, when [i.ZOOM] is set, the zoom ratio can be increased two times higher than the original zoom ratio while preventing deterioration of picture quality.

■ **Recording mode:**    

■ **Settings:** [ON] / [i.ZOOM] / [OFF]

- About i.ZOOM (→44)
- The setting is fixed to [i.ZOOM] in [Intelligent Auto] Mode.
- The setting is fixed to [ON] in [High Sens.] Scene Mode, [OFF] in [Panorama Shot] Scene Mode, and to [i.ZOOM] in other Scene Modes.

[Digital Zoom]

- For [Rec] menu setting procedures (→33)

Zoom 4 times further than Optical/Extra Optical Zoom. (Note that enlarging will decrease picture quality with Digital Zoom.)

■ **Recording mode:**    

■ **Settings:** [ON] / [OFF]

- When Digital Zoom is used simultaneously with i.Zoom, you can only increase the zoom ratio up to 2 times.



[Burst] DMC-FH6

- For [Rec] menu setting procedures (→33)

Enables still pictures to be taken in succession while the shutter button is pressed fully.

■ **Recording mode:**    

■ **Settings:**

Item	Settings				
 [Burst]	<p>Maximum burst speed: Approx. 1.5 fps</p> <ul style="list-style-type: none"> • You can record a series of still pictures successively until the card or built-in memory is full, but at some point the burst speed drops. (The timing at which the burst speed drops varies depending on the type of card and the number of recording pixels.) • The camera fixes its focus with the first picture to be taken. Both exposure and White Balance are adjusted for each of a picture. • The camera automatically fixes a succession of still pictures into three when the self-timer is used. • When burst is selected, the flash is unavailable. 				
 [Hi-Speed Burst]	<p>Maximum burst speed: Approx. 10 fps</p> <ul style="list-style-type: none"> • Number of pictures taken using burst* <table border="1" data-bbox="295 652 955 701"> <tr> <td>Built-in memory</td> <td>Approx. 15 pictures or more</td> </tr> <tr> <td>Card</td> <td>Approx. from 15 pictures to maximum of 100 pictures</td> </tr> </table> * The number of pictures that can be taken using burst varies depending on the recording conditions and the type of card. • The camera fixes its focus along with both exposure and White Balance, with the first picture to be taken. • [Sensitivity] is automatically adjusted. • The camera automatically fixes a succession of still pictures into three when the self-timer is used. • When burst is selected, the flash is unavailable. 	Built-in memory	Approx. 15 pictures or more	Card	Approx. from 15 pictures to maximum of 100 pictures
Built-in memory	Approx. 15 pictures or more				
Card	Approx. from 15 pictures to maximum of 100 pictures				
 [Flash Burst]	<ul style="list-style-type: none"> • Number of pictures taken using burst*: maximum of 5 pictures * The number of pictures that can be taken using burst varies depending on the recording conditions and the type of card. • The camera fixes its focus along with both exposure and the amount of light to be emitted from a flash, based on the first picture taken. • [Sensitivity] is automatically adjusted. • The camera automatically fixes a succession of still pictures into five when the self-timer is used. 				
[OFF]	Cancels burst mode.				

- About [Hi-Speed Burst] and [Flash Burst]
 - The settings can be made in [Normal Picture] Mode only.
 - The picture size is changed in accordance with the aspect ratios of the pictures (→55) prior to the setting.

Picture Aspect Ratio	Picture Size
4:3	3 M
3:2	2.5 M
16:9	2 M
1:1	2.5 M

- When ISO Sensitivity is set to high, or when the shutter speed becomes slow in dark locations, the burst speed may become slow.
- When you track subjects in motion and take successive pictures in where there is a significant difference between light and dark areas, it may not be possible to achieve the optimal exposure.
- The setting is fixed to [OFF] in [Panorama Shot] and [Photo Frame] Scene Modes.

[Burst] DMC-FH4 DMC-S5 DMC-S2

- For [Rec] menu setting procedures (→33)

Enables a rapid succession of still pictures to be taken. Succession of still pictures taken while shutter button is held down.

■ **Recording mode:**    

■ **Settings:**  / [OFF]

- Maximum burst speed: Approx. 1.5 fps DMC-FH4 DMC-S2
- Maximum burst speed: Approx. 1.4 fps DMC-S5
 - You can record a series of still pictures successively until the card or built-in memory is full, but at some point the burst speed drops. (The timing at which the burst speed drops varies depending on the type of card and the number of recording pixels.)
- Focus is fixed from first picture. Exposure and White Balance is adjusted for each picture.
- The camera automatically fixes a succession of still pictures into three when the self-timer is used.
- Burst speed may be reduced if ISO Sensitivity is set to high, or if shutter speed is reduced in darker locations.
- When burst is selected, the flash is disabled.
- When you record subjects in motion where there is a significant difference between light and dark areas, it may not be possible to achieve the optimal exposure.
- The setting is fixed to [OFF] in [Panorama Shot] and [Photo Frame] Scene Modes.

[Color Mode]

- For [Rec] menu setting procedures (→33)

Set colour effects.

■ **Recording mode:**

■ **Settings:** [STANDARD] / [VIVID]*1 (sharper) / [B&W] / [SEPIA] / [Happy]*2

*1 [Normal Picture] Mode and [Motion Picture] Mode only

*2 [Intelligent Auto] Mode only

[AF Assist Lamp]

- For [Rec] menu setting procedures (→33)

Illuminates lamp when dark to facilitate focus alignment.

■ **Recording mode:**

■ **Settings:** [ON] : Lamp illuminated with halfway press of shutter button (AF* and larger AF area displayed)

[OFF] : Lamp off (taking pictures of animals in dark, etc.)

- The AF Assist Lamp has an effective distance of approx. 1 m (3.3 feet)
 - Do not block the lamp with your fingers or look at it from close range.
 - The AF Assist Lamp's effective distance becomes shorter when using the zoom and depending on subject conditions.
- The setting is fixed to [OFF] in the following Scene Modes: [Scenery], [Night Scenery], [Sunset] and [Glass Through] Scene Modes

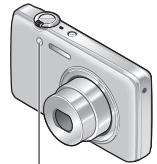

AF Assist Lamp

[Red-Eye Removal]

- For [Rec] menu setting procedures (→33)

Automatically detects red-eye and corrects still picture data when recording with flash red-eye reduction ().

■ **Recording mode:**

■ **Settings:** [ON] / [OFF]

- This setting will work only when [AF Mode] is (Face Detection).
- Depending on the circumstance, it may not be possible to correct red-eye.
- When the function setting is [ON], a appears with the flash icon.

[Stabilizer]

- For [Rec] menu setting procedures (→33)

Automatically detects and prevents jitter.

■ **Recording mode:**    

■ **Settings:** [ON] / [OFF]

- Cases where Optical Image Stabiliser may be ineffective:
Heavy jitter, high zoom ratio (also in the Digital Zoom range), fast-moving objects, indoors or in dark locations (due to low shutter speed)

[Date Stamp]

- For [Rec] menu setting procedures (→33)

Still pictures can be taken with the recording date and time stamped on the still picture.

■ **Recording mode:**    

■ **Settings:** [W/O TIME] / [WITH TIME] / [OFF]

- Date stamps on still pictures cannot be erased.
- The date cannot be stamped when [Burst] is set.
- The setting is fixed to [OFF] in [Panorama Shot] Scene Mode.
- Do not request date printing in store or make date printing on printer for still pictures with date stamps. (Date printing may be overlapping.)
- Cannot change the setting in [Intelligent Auto] Mode. The setting in other Recording Mode is applied.

[Clock Set]

- For [Rec] menu setting procedures (→33)

Set the clock. Same function as that in [Setup] menu.

Different playback methods [Playback Mode]

Recorded pictures can be played back in a variety of ways.

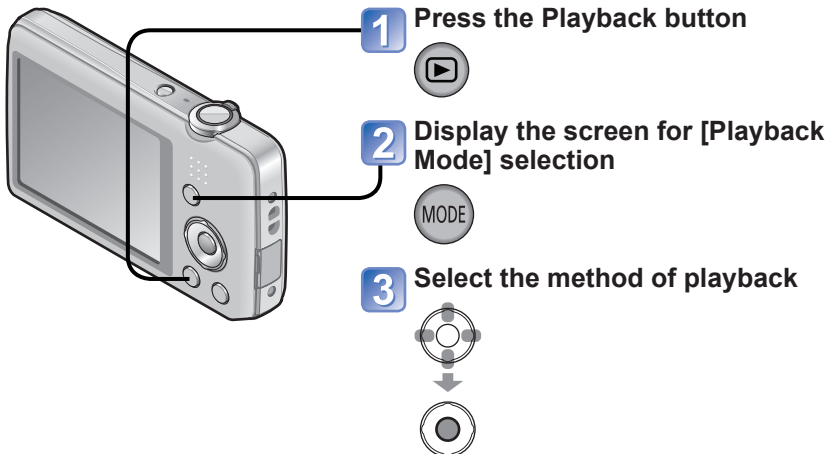

- When no card is inserted, pictures are played back from the built-in memory.
- The [Playback Mode] automatically becomes [Normal Play] when switching from recording mode to playback mode.

[Slide Show]

- For switching [Playback Mode] (→64)

Automatically play pictures in order and to music. Recommended when viewing on TV screen.

1 Use cursor button to select the playback method and press [MENU/SET]

[All]	Play all.
[Category Selection]	Select category and playback. (Select category with cursor button and press [MENU/SET].) (→66)
[Favorite]	Play back pictures set as [Favorite].

2 Use cursor button to set playback effects and press [MENU/SET]

[Effect] (Select music and effects according to picture atmosphere)	
[AUTO] (only available with [Category Selection] setting) / [NATURAL] / [SLOW] / [SWING] / [URBAN] / [OFF]	
[Setup]	
[Duration]	[1 SEC.] / [2 SEC.] / [3 SEC.] / [5 SEC.] (Only available when [Effect] is [OFF])
[Repeat]	[ON] / [OFF]
[Music]	[ON] / [OFF]

3 Select [Start] with cursor button and press [MENU/SET]

■ Operations during Slide Show

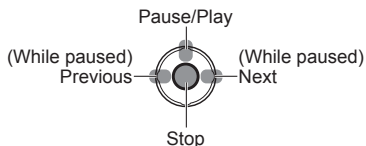

- Volume can be adjusted with the zoom lever or the zoom button.

- When [URBAN] has been selected, the picture may appear in black and white as a screen effect.
- When panorama pictures are played back, the [Duration] setting is disabled.
- Part of [Effect] cannot be used when displaying pictures recorded in portrait position.
- Music effects cannot be added.
- Motion pictures cannot be played back in a Slide Show. The initial screens of motion pictures are played back as still pictures in the Slide Show.

[Filtering Play]

- For switching [Playback Mode] (→64)

You can refine the selection of pictures to be viewed by narrowing them down to pictures in selected categories or to favourite pictures, and then view those pictures.

1 Select the method to narrow down the displayed pictures

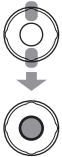

[Category Selection]	Display only pictures in the selected category.
[Favorite]	Display pictures set as [Favorite].

2 When [Category Selection] has been selected in step 1, select a category

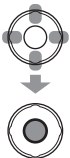

[Category]	Recording information such as Scene Modes
	[Portrait] / / [Soft Skin] / [Night Portrait] / / [Baby]
	[Scenery] / / [Panorama Shot] / [Sunset] / / [Glass Through]
	[Night Portrait] / / [Night Scenery] /
	[Sports]
	[Baby]
	[Pet]
	[Food]
	[Motion Picture]

[Calendar]

- For switching [Playback Mode] (→64)

Select the date from the calendar screen to view only the pictures taken on that day. (→30)

Retouching pictures

[Auto Retouch]

You can adjust the colour and brightness of a still picture to bring them into balance.

- New pictures are created after editing pictures with [Auto Retouch]. Before starting to edit, make sure that there is enough free space in the built-in memory or memory card.

DMC-FH6

1 Select a still picture to retouch during playback and press **▲**

2 Use cursor button to select [Auto Retouch] and press [MENU/SET]

A still picture retouched with colours and brightness is displayed.

3 Use cursor button to select [ON] and press [MENU/SET]

- A confirmation screen is displayed. If you select [Yes], the new retouched still picture is saved.
- When [OFF] is selected, you can restore a picture to its original condition (before retouching).

DMC-FH4 DMC-S5 DMC-S2

1 Select a still picture to retouch during playback and press **▲**

A still picture retouched with colours and brightness is displayed.

2 Press [MENU/SET]

- A confirmation screen is displayed. If you select [Yes], the new retouched still picture is saved.

- The retouch effect may be less apparent in some still pictures.
- Some still pictures may have higher noise levels after retouching.
- It may not be possible to use [Auto Retouch] with still pictures that have already been retouched.
- It may not be possible to retouch still pictures recorded with other cameras.
- [Auto Retouch] is unable to be performed in the following cases:
 - Motion pictures
 - Still pictures recorded in [Panorama Shot] Scene Mode
 - Still pictures recorded in [Photo Frame] Scene Mode

[Beauty Retouch] DMC-FH6

Still pictures taken by the camera that recognise the subject as a face can be retouched using the makeup effect etc., to enhance the portrait.

- New pictures are created after editing pictures with [Beauty Retouch]. Before starting to edit, make sure that there is enough free space in the built-in memory or memory card.

1 Select a still picture that has a face in it and press ▲



2 Use cursor button to select [Beauty Retouch] and press [MENU/SET]

3 Use cursor button to select a face and press [MENU/SET]

- Press ◀ or ▶ to move the cursor to select a face. If the cursor does not move to a face, it means that the camera cannot detect this face and thus it cannot be selected.

4 Set the effects

- ① Use ▲ or ▼ to select the effect that you want to apply and press ▶
 - ② Use ▲ or ▼ to select the setting and press ◀
- Repeat steps ① and ② to set another effect.

Menu item	Settings
 [Aesthetic Retouch]	Creates smooth, clear skin or enhances the whiteness of eyes and teeth.
 [Foundation]	Adjusts the skin colour.
 [Make Up Retouch]	Enhances the colour of lips, renders faces with a three-dimensional look, or creates a sharper outline of the eyes.

- ③ Press [MENU/SET] to end the retouching operation

5 Use cursor button to select [Yes] and press [MENU/SET]

- A screen comparing the original picture to the picture with effects applied is displayed.

6 Press [MENU/SET]

- A confirmation screen is displayed. If you select [Yes], the new retouched still picture is saved.

- You cannot retouch an already-retouched subject or two or more subjects at once. To perform such an operation, save the picture once and then select a subject that you want to retouch again.
- The brightness or colour between a picture viewed before saving and the saved picture may be different.
- It may not be possible to retouch still pictures taken with other cameras.
- You cannot retouch motion pictures and still pictures recorded in [Panorama Shot] Scene Mode.
- If the face is not detected properly, it may not be possible to retouch the face as desired.
- To take a still picture suitable for [Beauty Retouch]:
 - Take a picture of the face from the front
 - Avoid taking a picture under very low lighting conditions
 - Take a clear picture of the area that you want to retouch
- Reallusion is a trademark of Reallusion Inc.



Using the [Playback] menu

You can set the recorded picture to upload to the image-sharing websites, edit the picture (for example, trimming), and set a protection setting in the picture.

- For Playback menu display and operation methods (→33).
- Depending on the [Playback Mode], some [Playback] menu items are not displayed.
- It may not be possible to set or edit pictures taken with other cameras.
- New pictures are created after editing pictures with tools such as [Resize] and [Cropping] **DMC-FH6**. Before starting to edit, make sure that there is enough free space in the built-in memory or memory card.

[Upload Set]

You can select pictures on the camera for uploading to image-sharing websites (Facebook or YouTube).

- Only still pictures can be uploaded to Facebook and only motion pictures can be uploaded to YouTube.
- Pictures on the built-in memory cannot be set. Copy pictures to a card (→77) before making [Upload Set] settings.

1 Use cursor button to select [SINGLE] or [MULTI], and then press [MENU/SET]

2 Select picture and make setting

● [SINGLE]

Use cursor button to select picture and press [MENU/SET]

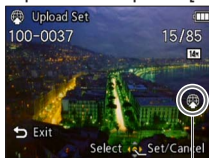

Web upload setting

- To cancel
→ Press [MENU/SET] again.

● [MULTI]

Use cursor button to select picture and press [MENU/SET]

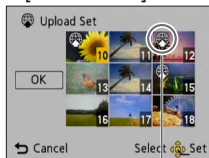

Web upload setting

- To cancel
→ Press [MENU/SET] again.
- To execute
→ Use cursor button to select [OK] and press [MENU/SET].
 - Confirmation screen is displayed. If you select [Yes], the operation is executed.

■ Uploading to image-sharing websites

When setting [Upload Set], the built-in uploading tool automatically makes copies on the card inside the camera. Connect the camera to your computer (→80) before performing uploading operations. For more details, refer to (→84).

■ To clear all

Select [CANCEL] in step 1 and select [Yes].

- Not available on cards with less than 512 MB.

[Resize]

- For Playback menu display and operation methods (→33).

Picture size can be reduced to facilitate e-mail attachment and use in web pages, etc. (Still pictures recorded at the smallest recording pixel level cannot be further reduced.)

■ [SINGLE]

1 Use cursor button to select [SINGLE] and press [MENU/SET]

2 Use cursor button to select a still picture and press [MENU/SET]

3 Use cursor button to select size and press [MENU/SET]

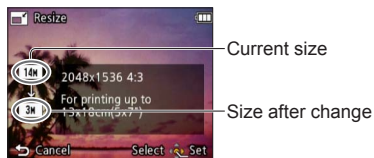

- Confirmation screen is displayed. If you select [Yes], the operation is executed.

■ [MULTI]

- 1 Use cursor button to select [MULTI] and press [MENU/SET]
- 2 Use cursor button to select size and press [MENU/SET]
- 3 Use cursor button to select a still picture and press [MENU/SET] (up to 50 pictures)

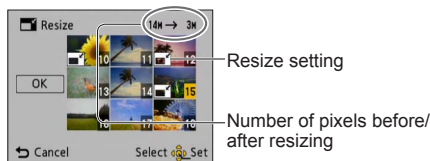

- To cancel
→ Press [MENU/SET] again.
- To execute
→ Use cursor button to select [OK] and press [MENU/SET].

• Confirmation screen is displayed. If you select [Yes], the operation is executed.

- Picture quality is reduced after resizing.
- Cannot resize the following pictures.
 - Motion pictures
 - Still pictures already stamped with the date and time
 - Panorama pictures

[Cropping] **DMC-FH6**

- For Playback menu display and operation methods (→33).

Enlarge your still pictures and crop unwanted areas.

- 1 Use cursor button to select a still picture, and then press [MENU/SET]
- 2 Select area to crop and press [MENU/SET]



• Confirmation screen is displayed. If you select [Yes], the operation is executed.

- Picture quality is reduced after cropping.
- Cannot crop the following pictures.
 - Motion pictures
 - Still pictures already stamped with the date and time
 - Panorama pictures

[Favorite]

- For Playback menu display and operation methods (→33).

By labelling your favourite pictures with a star (★), you can play back your favourite pictures only, or you can delete all pictures except your favourites.

1 Use cursor button to select [SINGLE] or [MULTI] and press [MENU/SET]

2 Use cursor button to select picture and press [MENU/SET]

● [SINGLE]



Favourite picture setting

● [MULTI]

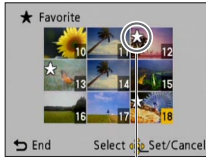

Favourite picture setting

- To cancel → Press [MENU/SET] again.

■ To clear all

Select [CANCEL] in step 1 and select [Yes].

[Print Set] DMC-FH6

- For Playback menu display and operation methods (→33).

Picture/picture no./date printing settings can be made for when printing with DPOF print-compatible shops or printers. (Ask at shop to check compatibility)

1 Use cursor button to select [SINGLE] or [MULTI] and press [MENU/SET]

2 Use cursor button to select picture and press [MENU/SET]

3 Use cursor button to set number of pictures and press [MENU/SET]

(repeat steps **2** and **3** when using [MULTI] (up to 999 pictures))

● [SINGLE]

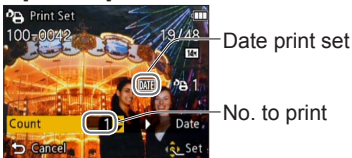

● [MULTI]

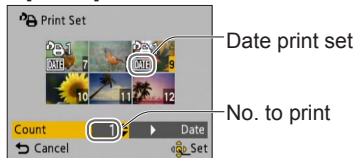

- Date print setting/release → Press ►

■ To clear all

Select [CANCEL] in step **1** and select [Yes].

- Depending on the type of printer, the printer settings may take priority over camera settings.
- Cannot be set for files that are not compliant with the DCF standard.
- Some DPOF information set by other equipment cannot be used. In such cases, delete all of the DPOF information and then set it again with this camera.
- Date print setting cannot be made for still pictures that have been taken with [Date Stamp].
- Print setting cannot be made for motion pictures.

[Protect]

- For Playback menu display and operation methods (→33).

Set protection to disable picture deletion. Prevents deletion of important pictures.

1 Use cursor button to select [SINGLE] or [MULTI] and press [MENU/SET]

2 Use cursor button to select picture and press [MENU/SET]

● [SINGLE]



Picture protected

● [MULTI]

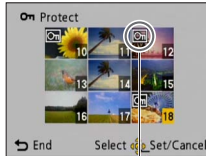

Picture protected

- To cancel → Press [MENU/SET] again.

■ To clear all

Select [CANCEL] in step **1** and select [Yes].

■ To cancel while releasing all

Press [MENU/SET].

- May not be effective when using other devices.

[Copy]

- For Playback menu display and operation methods (→33).

You can copy pictures between built-in memory and memory card.

1 Use cursor button to select the copy method (direction) and press [MENU/SET]



: Copy all pictures from built-in memory to card (go to step 3).

: Copy 1 picture at a time from card to built-in memory.

2 Select picture with cursor button and press [MENU/SET]

3 Use cursor button to select [Yes] and press [MENU/SET]

- To cancel → Press [MENU/SET].
- After all the pictures are copied from the built-in memory to the memory card, the display returns automatically to the playback screen.

- Copying pictures may take several minutes. Do not turn off power or perform other operations during copying.
- If identical names (folder/file numbers) are present in the copy destination, a new folder for copying will be created when copying from built-in memory to card (). Identically-named files will not be copied from card to built-in memory (.
- The following settings are not copied. Set them again after copying.
 - [Protect] - [Favorite] - [Print Set] **DMC-FH6**
- Only pictures from Panasonic digital cameras (LUMIX) may be copied.

Viewing on TV screen

You can view pictures on a TV screen by connecting your camera to your TV with the AV cable.

Getting Ready:

- Set [TV Aspect]. (→38)
- Turn off both camera and TV.

- 1 Connect camera to TV**
- 2 Turn on TV**
 - Set to auxiliary input.
- 3 Turn on camera**
- 4 Press the Playback button**

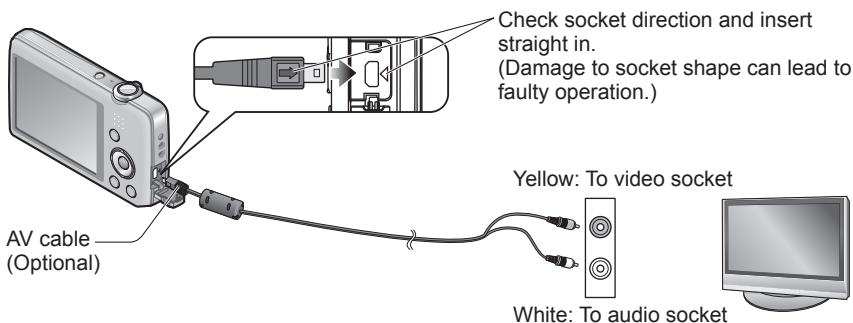

■When TVs or DVD recorders have an SD card slot

Insert the SD Memory Card into the SD card slot

- You can play back only still pictures.
 - You cannot play back motion pictures.
 - You may not be able to play back panorama pictures. Also you cannot perform automatic scrolling playback of panorama pictures.
- When using both SDHC and SDXC Memory Cards, be sure to play each type of card in equipment compatible with the particular format.

- Also consult TV operating manual.
- Always use a genuine Panasonic AV cable (optional).
- You can play back pictures on TVs in other countries (regions) which use the NTSC or PAL system when you set [Video Out] in [Setup] menu.
- Pictures rotated to portrait may be blurred slightly.
- Change picture mode settings on TV if aspect ratios are not displayed correctly on widescreen or high-definition televisions.

Using with your PC

Still/motion pictures can be copied from the camera to your computer by connecting the two together.

- Some computers can read directly from the camera's memory card.
For details, see the manual for your computer.
- If your computer does not support SDXC Memory Cards a message will be displayed requesting you to format the card. (Do not format the card. This will erase recorded pictures.) If the card is not recognised, refer to the following support website.
<http://panasonic.net/avc/sdcard/information/SDXC.html>
- You can use pictures copied to your computer for printing, attaching them to e-mail, or other operation. The "PHOTOfunSTUDIO" software on the CD-ROM (supplied) enables you to perform these functions easily.

Using the supplied software

The supplied CD-ROM contains the following software.
Install the software on your computer before using.

■ PHOTOfunSTUDIO 8.0 LE (Windows XP/Vista/7)

This software allows you to copy still pictures or motion pictures to a computer and sort the copied pictures by their recording date and time, model name of the digital camera used, or other attributes. You can write pictures to a DVD, create a Slide Show using your preferred music or effects and so on before saving it to a DVD.

■ LoiLoScope 30 day full trial version (Windows XP/Vista/7)

LoiLoScope is a video editing software where that draws out the full power of your PC. Creating videos is as easy as organising cards on top of a desk. Use your music, picture and video files to create videos to share with your friends and family by burning it to a DVD, uploading it to websites, or simply share your videos with your friends via e-mail.

- This will only install a shortcut to the trial version download site.

For more information on how to use LoiLoScope, read the LoiLoScope manual available for download at the link below.

Manual URL: <http://loilo.tv/product/20>

Installing supplied software (PHOTOfunSTUDIO)

This software allows you to acquire pictures to the PC, and also categorise these acquired pictures by their recording date or the model name of the camera used.

- Before inserting the CD-ROM, close all running applications.

1 Check the environment of your PC

Operating environment of PHOTOfunSTUDIO 8.0 LE

OS	Windows XP (32 bit) SP3 Windows Vista (32 bit) SP2 Windows 7 (32 bit/64 bit) and SP1	
CPU	Windows XP	Pentium III 500 MHz or higher
	Windows Vista	800 MHz or higher
	Windows 7	1 GHz or higher
Display	1024 × 768 pixels or more (1920 × 1080 pixels or more recommended)	
RAM	Windows XP	512 MB or more
	Windows Vista	
	Windows 7	1 GB or more (32 bit) 2 GB or more (64 bit)
Free hard disk space	450 MB or more for installing software	

- Refer to the Operating Instructions of “PHOTOfunSTUDIO” (PDF) for further information about the operating environment.

2 Insert the CD-ROM with the supplied software

When you insert the supplied CD-ROM, the install menu will start.

3 Click on the [Applications] on the install menu

4 Click on the [Recommended Installation]

- Proceed with installation according to messages appearing on the screen.

- The software compatible with your PC will be installed.
- PHOTOfunSTUDIO is not compatible with Mac.

Copying still pictures and motion pictures

Getting Ready:

- Charge the battery sufficiently.
- When importing pictures from the built-in memory, remove any memory cards.
- Turn on the camera and computer.

Check socket direction and insert straight in.
(Damage to socket shape can lead to faulty operation.)

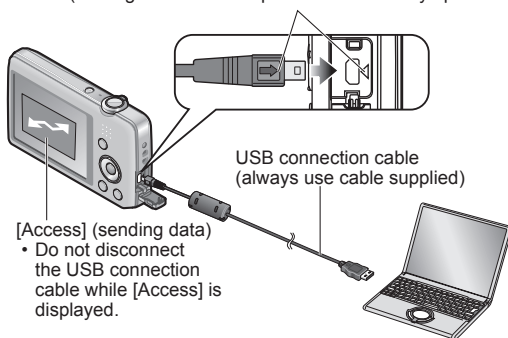

1 Connect camera to computer

- Please make sure you use the supplied USB connection cable. Use of cables other than the supplied USB connection cable may cause malfunction.

2 Use cursor button on the camera to select [PC], and press [MENU/SET]

3 Use "PHOTOfunSTUDIO" to copy pictures to your computer

- For details on how to use "PHOTOfunSTUDIO", see the "PHOTOfunSTUDIO" manual (PDF).

- You can save pictures to your computer by dragging and dropping folders and files containing the pictures that you want to copy into other folders in the computer.

■ Folder and file names on computer

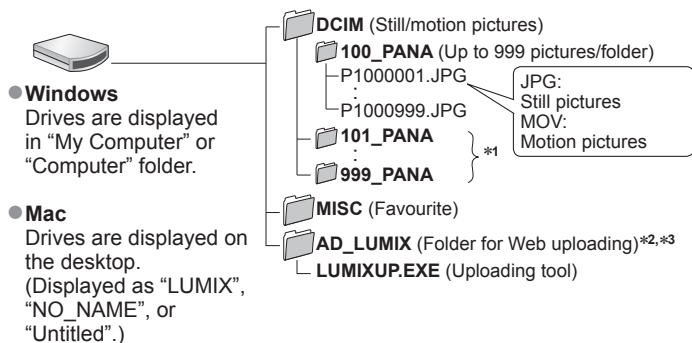

*1 New folders are created in the following cases:

- When pictures are taken to folders containing files numbered 999.
- When using cards already containing the same folder number (for example, pictures taken with other cameras, etc.).

*2 Note that pictures cannot be uploaded to image-sharing websites if the files in the AD_LUMIX folder are deleted.

*3 This folder is not created in the built-in memory.

■ To cancel connection

Click “**Safely Remove Hardware**” in the Windows System Tray

■ When using Windows XP, Windows Vista, Windows 7, or Mac OS X

The camera can be connected to your computer even if you select [PictBridge (PTP)] in the step 2 on the previous page.

- Only picture output can be performed.
- It may not be possible to import if there are 1000 or more pictures on the card.

- Do not use any other USB connection cables except the supplied one.
- Turn off power before inserting or removing memory cards.
- When the battery begins to run out during communication, a warning beep sounds. Cancel communication via your computer immediately. Use a sufficiently charged battery.
- For more details, consult your computer operating manual.

Uploading pictures to image-sharing websites

Using the uploading tool ([LUMIX Image Uploader]), you can upload still pictures and motion pictures to image-sharing websites (Facebook or YouTube).

There is no need to copy pictures to your computer or install specialised software.

Uploading pictures from the camera is easy with a computer connected to a network, even when you are away from your regular computing environment.

- This tool supports only computers that run on Windows XP, Windows Vista, and Windows 7.
- For more information, read the operating instructions (PDF) for the [LUMIX Image Uploader].

Getting ready:

- Use [Upload Set] to select the pictures for uploading (→71)
- Connect your computer to the Internet
- Create an account for the applicable image-sharing website and prepare your login information

1 Double-click “LUMIXUP.EXE” to start it

- If you have installed “PHOTOfunSTUDIO” from the CD-ROM (supplied), “Uploading tool ([LUMIX Image Uploader])” may start automatically.

2 Select the upload destination

- Do the further steps in accordance with the instructions displayed on the computer screen.
- Because YouTube and Facebook services and specifications are subject to change, operation of online services cannot be guaranteed in the future. Available services and screens are subject to change without notice.
(This service is available as of 1st November, 2011)
- Do not upload pictures protected by copyright except when you are the copyright holder or permission has been obtained from the corresponding copyright holder.
- The pictures may contain information that identifies an individual, such as the title of a picture, recording date and time, information of the location where a picture was taken using a camera with GPS function, and so on. Before uploading the pictures to image-sharing websites, check the pictures carefully for information that should not be disclosed.

Printing

You can connect directly to a PictBridge-compatible printer for printing.

- Some computers can read directly from the camera's memory card.
For details, see the manual for your computer.

Getting Ready:

- Charge the battery sufficiently.
- When copying pictures from the built-in memory, remove any memory cards.
- Adjust the print quality or other settings on your printer, as needed.
- Turn on the camera and printer.

- Do not disconnect the USB connection cable when the cable disconnection icon  is displayed (may not be displayed with some printers).

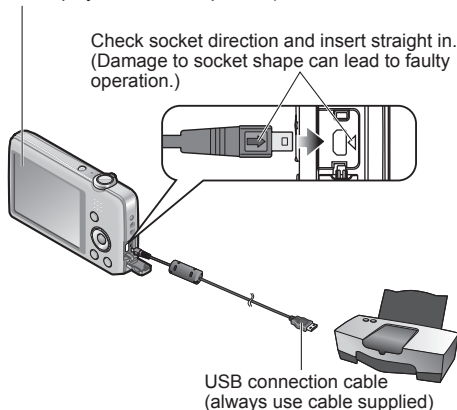

1 Connect camera to printer

- Please make sure you use the supplied USB connection cable. Use of cables other than the supplied USB connection cable may cause malfunction.

2 Use cursor button on the camera to select [PictBridge (PTP)], and press [MENU/SET]

3 Use cursor button to select a picture to print and press [MENU/SET]

4 Use cursor button to select [Print start] and press [MENU/SET] (Print settings (→87))

■ To cancel print Press [MENU/SET]

- Do not use any other USB connection cables except the supplied one.
- Disconnect USB connection cable after printing.
- Turn off power before inserting or removing memory cards.
- When the battery begins to run out during communication, a warning beep sounds. Cancel printing and disconnect USB connection cable. Use a sufficiently charged battery.







Printing multiple pictures

- 1 Connect camera to printer**
 - Please make sure you use the supplied USB connection cable. Use of cables other than the supplied USB connection cable may cause malfunction.
- 2 Use cursor button on the camera to select [PictBridge (PTP)], and press [MENU/SET]**
- 3 Press ▲**
- 4 Use cursor button to select item and press [MENU/SET]**
 - **[Multi Select]:**
 - ① Scroll between pictures with cursor button select pictures to print with [MENU/SET]. (Press [MENU/SET] again to release selection.)
 - ② Use cursor button to select [OK] and press [MENU/SET].
 - **[Select All]:** Print all pictures.
 - **[Print Set (DPOF)]** **DMC-FH6**: Print pictures selected in [Print Set].
 - **[Favorite]:** Print pictures selected as [Favorite].
- 5 Use cursor button to select [Print start] and press [MENU/SET]**
(Print settings (→87))
 - Select [Yes] if print confirmation screen is displayed.
 - An orange “●” displayed during printing indicates an error message.
 - Print may be divided into several times if printing a large amount of pictures. (Remaining sheets display may differ from set number.)



Making print settings on the camera

(Make settings before selecting [Print start])

1 Use cursor button to select the item and press [MENU/SET]

Item	Settings
[Print with Date]	[ON] / [OFF]
[Num.of prints]	Set number of pictures (up to 999 pictures)
[Paper Size]	When  is selected, the printer settings take priority.
[Page Layout]	 (printer takes priority) /  (1 picture, no border) /  (1 picture, with border) /  (2 pictures) /  (4 pictures)

2 Use cursor button to select setting and press [MENU/SET]

- Items may not be displayed if incompatible with printer.
- To arrange  "2 pictures" or  "4 pictures" in the same still picture, set the number of prints for the still picture to 2 or 4.
- To print paper sizes/layouts not supported by this camera, set to  and make settings on the printer. (Consult your printer's operating manual.)
- [Print with Date] and [Num.of prints] are not shown when you have selected [Print Set] settings. **DMC-FH6**
- Even with completed [Print Set] settings, dates may not be printed, depending on the shop or printer used. **DMC-FH6**
- When setting [Print with Date] to [ON], check the date printing settings on the printer (printer settings may be prioritised).

Print with date and text

■ Printing in store

Only recording date can be printed. Request date printing in store.

- When printing still pictures of 16:9 Aspect Ratio, check in advance that the store can accept this size.

■ Using computer

Print settings for recording date and text information can be made using the supplied CD-ROM "PHOTOfunSTUDIO".

■ Using printer

Recording date can be printed by setting [Print with Date] to [ON] when connecting to a printer compatible with date printing.

List of LCD monitor displays

■ In recording

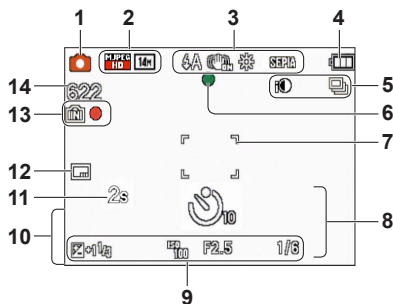

- | | | | |
|---|--------------------------------|----|-------------------------------------|
| 1 | Recording Mode (→18) | 9 | ISO Sensitivity (→56) |
| 2 | Picture Size (→55) | | Aperture value/Shutter speed (→40) |
| | Recording quality (→56) | | Exposure Compensation (→48) |
| | Backlight Compensation (→23) | | AF Assist Lamp (→62) |
| 3 | Flash Mode (→45) | 10 | Current date/time |
| | Optical Image Stabiliser (→63) | | Age in years/months (→54) |
| | Jitter alert (→40) | 11 | Elapsed recording time (→25) |
| | White Balance (→57) | 12 | Date Stamp (→63) |
| | Colour Mode (→62) | 13 | Save destination (→14) |
| 4 | Battery capacity (→15) | | Recording state |
| 5 | Burst Mode (→60) | 14 | Number of recordable pictures (→15) |
| | Intelligent exposure (→59) | | Remaining recording time (→15, 25) |
| 6 | Focus (→22) | | RXXhXXmXXs* |
| 7 | AF area (→41) | | |
| 8 | Self-timer Mode (→47) | | |
| | Focus range | | |
| | Zoom (→43) | | |



* [h], [m] and [s] indicate "hour", "minute" and "second".

Screens shown here are only examples. The actual display may vary.

■ In playback

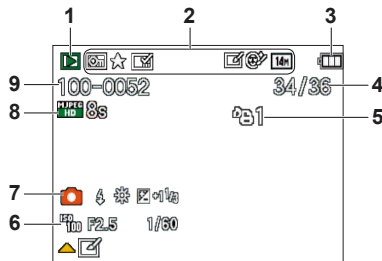

- | | |
|---|--|
| <p>1 Playback Mode (→64)</p> <p>2 Protected picture (→76)
Favourites (→74)
Date Stamp (→63)
Colour Mode (→62)
Picture Size (→55)
Auto Retouch (→68)
Beauty Retouch (→69) DMC-FH6</p> <p>3 Battery capacity (→15)</p> <p>4 Picture number/Total pictures (→26)
Elapsed playback time (→27)</p> <p>5 Print settings (→75) DMC-FH6</p> | <p>6 Recorded date and time
World time setting (→35)
Age in years/months (→54)
Aperture value/Shutter speed (→40)
ISO Sensitivity (→56)</p> <p>7 Recording Mode (→18)
Flash Mode (→45)
White Balance (→57)
Exposure Compensation (→48)</p> <p>8 Recording quality (→56)
Motion picture recording time (→27)
XXhXXmXXs*</p> <p>9 Folder/File number (→26, 83)
Save destination (→14)
Cable disconnection warning icon (→85)</p> |
|---|--|

* [h], [m] and [s] indicate "hour", "minute" and "second".

Screens shown here are only examples. The actual display may vary.

Message displays

Meanings of and required responses to major messages displayed on LCD monitor.

[This memory card cannot be used]

- A MultiMediaCard was inserted.
→ Not compatible with the camera. Use a compatible card.

[Some pictures cannot be deleted] [This picture cannot be deleted]

- Non-DCF pictures (→26) cannot be deleted.
→ Save needed data on a computer or other device, and then use [Format] on the camera. (→39)

[No additional selections can be made]

- The number of pictures that can be deleted at once has been exceeded.
- More than 999 pictures have been set as [Favorite].
- The number of pictures allowing [Resize] (multiple settings) at once has been exceeded.

[Please turn camera off and then on again] [System Error]

- The lens is not working correctly.
→ Turn on power again.
(Consult the dealer or your nearest Service Centre if display still remains)

[Some pictures cannot be copied] [Copy could not be completed]

- Pictures cannot be copied in following cases.
→ Picture of same name already exists in built-in memory when copying from card.
→ File is not of DCF standard (→26).
→ Picture taken or edited on a different device.

[Not enough space on built-in memory] [Not enough memory on the card]

- There is no space left on the built-in memory or the card. When you copy pictures from the built-in memory to the card (batch copy), the pictures are copied until the capacity of the card becomes full.

[Built-In Memory Error] [Format built-in memory?]

- Displayed when formatting built-in memory via computer, etc.
→ Reformat directly using camera. Data will be deleted.

[Memory Card Error] [Format this card?]

- The card format cannot be used with this camera.
→ Save needed data on a computer or other device, and then use [Format] on the camera. (→39)

[Insert SD card again] [Try another card]

- Access to card has failed.
→ Insert card again.
- Try with a different card.

[Memory Card Error] [Memory card parameter error]

- Card is not of SD standard.
- When cards in capacities of 4 GB or more are used, only SDHC or SDXC Memory Cards are supported.

[Read Error]/[Write Error] [Please check the card]

- Data read has failed.
→ Check whether card has been inserted correctly (→12).
- Data write has failed.
→ Turn off power and remove card, before re-inserting and turning on power again.
- Card may possibly be damaged.
- Try with a different card.

[Motion recording was cancelled due to the limitation of the writing speed of the card]

- If recording stops even when using a card of the recommended speed class (→14), the data writing speed has dropped. If this happens, we recommend backing up the data on the memory card and formatting it (→39).
- Motion picture recording may be automatically terminated with certain cards.

[A folder cannot be created]

- Folder numbers in use have reached 999.
→ Save needed data on a computer or other device, and then use [Format] on the camera. (→39)

[Picture is displayed for 16:9 TV] [Picture is displayed for 4:3 TV]

- AV cable is connected to camera.
→ To remove message immediately → Press [MENU/SET].
→ To change aspect ratio → Change [TV Aspect] (→38).
- USB connection cable (supplied) is only connected to camera.
→ Message disappears when cable is also connected to another device.

Q&A Troubleshooting

Try checking these items (→92 - 97) first.

If the problem persists, performing [Reset] in the [Setup] menu may resolve the issue. (Note that except for some items such as [Clock Set], all settings are returned to their values from the time of purchase.)

Battery, power

Camera does not work even if power is turned on.

- Battery is not inserted correctly (→12), or needs recharging.

The power cuts off during use.

- Battery needs recharging.
- Camera is set to [Auto Power Off]. (→37)
→ Turn on the power again.

Recording

Cannot record pictures.

- The camera is in Playback Mode.
→ Press the Playback button to switch to recording mode.
- Built-in memory/card is full. → Free space by deleting unwanted pictures (→31).

Recorded pictures look white.

- Lens is dirty (fingerprints, etc.).
→ Clean lens surface with a soft, dry cloth.
- Lens is foggy (→4).

Recorded pictures are too bright/too dark.

- Adjust the exposure (→48).

2-3 pictures are taken when I press the shutter button just once.

- Camera is set to use [Burst] (→60).

Focus not aligned correctly.

- Not set to mode appropriate for distance to subject. (Focus range varies according to recording mode.)
- Subject outside of focus range.
- Caused by jitter or subject movement (→40).

Recorded pictures are blurred. Optical Image Stabiliser ineffective.

- Shutter speed is slower in dark locations and Optical Image Stabiliser is less effective.
→ Hold camera firmly with both hands, keeping arms close to body.
→ Set [Digital Zoom] to [OFF] and [Sensitivity] to [ ISO]. (→56, 59)

Recorded pictures appear coarse, or there is interference.

- ISO Sensitivity is high, or shutter speed is low.
(Default [Sensitivity] setting is [ ISO] – interference may appear with indoor pictures.)
→ Lower [Sensitivity] (→56).
→ Take pictures in brighter locations.
- Camera is set to [High Sens.].
(Picture becomes slightly coarser in response to high sensitivity.)

Recording (Continued)

Brightness or colouring of recorded picture different from real life.

- When recording under fluorescent or LED lighting fixture etc., increasing the shutter speed may introduce slight changes to brightness and colour. These are a result of the characteristics of the light source and do not indicate a malfunction.

Red banding may appear on the LCD monitor or part or the entire screen may have a reddish tint, when recording or pressing the shutter button halfway.

- This is a characteristic of CCD and may appear if subject contains brighter areas. Some blurring may occur around these areas, but this is not a fault. This will be recorded in motion pictures, but not in still pictures.
- We recommend keeping the screen away from strong light sources such as sunlight when taking pictures.



Motion picture recording stops midway.

- With some cards, access display may appear briefly after recording, and recording may end midway.
- When recording motion picture, use a card rated with an SD speed class* of "Class 6" or higher.
 - * SD speed class refers to a specification for sustained write speeds.
- If recording stops even when using a card with speed of "Class 6" or faster, the data writing speed is low. We recommend backing up the data on the memory card and reformatting it. (→39)

Panorama picture recording stops before finishing.

- If the pan motion of the camera is too slow, the camera assumes that the operation has been aborted and stops recording.
- If the pan motion of the camera is too shaky when it is moved toward the recording direction, the camera stops recording.
 - To record panorama pictures, pan the camera in a small circular motion, as in parallel with the recording direction, at a speed that turning halfway around in approx. 4 seconds (guideline).

The beep volume is low.

- The speaker is blocked.

LCD monitor

Monitor sometimes shuts off even though power is on.

- After recording, monitor shuts off until next picture can be recorded. (Approx. 6 seconds (max.) when recording to the built-in memory)

Brightness is unstable.

- Aperture value is set while shutter button is pressed halfway. (Does not affect recorded picture.)

Monitor flickers indoors.

- The LCD monitor may flicker for a few seconds after turning on. This is an operation to correct flicker caused by lighting such as fluorescent lights, LED lights etc. and is not a malfunction.

The LCD monitor is too bright or too dark.

- Use [LCD Display] to adjust the brightness of the LCD monitor. (→36)

Black/blue/red/green dots or interference appears. Monitor looks distorted when touched.

- This is not a fault, and will not be recorded on the actual pictures, so there is no need to worry.

Flash

No flash emitted.

- Flash set to [Forced Flash Off]  (→45).
- The flash is unavailable when using [Burst] (other than [Flash Burst] **DMC-FH6**) or when using [Scenery], [Panorama Shot], [Night Scenery], [Sunset], or [Glass Through] Scene Modes.

Multiple flashes are emitted.

- Red-Eye Reduction is active (→45). (Flashes twice to prevent eyes from appearing red.)
- [Burst] is set to [Flash Burst] **DMC-FH6** (→60).

Playback

Pictures have been rotated.

- [Rotate Disp.] is set to .
- For full-screen display without picture rotation, set [OFF].

Cannot view pictures.

- Press the Playback button.
- No pictures in built-in memory or card (pictures are played from card if inserted, from built-in memory if card is not inserted).
- Camera set to [Filtering Play].
→ Set [Playback Mode] to [Normal Play] (→64).

Folder/file number displayed as [-]. Picture is black.

- Picture edited on computer or taken with a different device.
- Battery removed immediately after picture taken, or picture taken with low battery.
→ Use [Format] to delete (→39).

The Playback volume and beep volume are low.

- The speaker is blocked.

Incorrect date displayed in Calendar Playback.

- Picture edited on computer or taken with a different device.
- [Clock Set] is incorrect (→16).
(Incorrect date may be displayed in Calendar Playback on pictures copied to computer and then back to camera, if computer and camera dates differ.)

White round spots like soap bubbles appear on the recorded picture.

- If you take a picture with the flash in a dark place or indoors, white round spots may appear on the picture caused by the flash reflecting particles of dust in the air. This is not a fault. A characteristic of this is that the number of round spots and their position differ in every picture.







[Thumbnail is displayed] is shown on the screen.

- The still pictures may have been recorded with another device. If so, they may be displayed with poor picture quality.

Playback (Continued)

Blackened red areas in recorded pictures.

- When digital red-eye correction ( ) is operating, if a subject is recorded that has skin-coloured areas with red areas inside, the digital red-eye correction function may blacken the red areas.
→ We recommend setting the Flash Mode to ,  or , or [Red-Eye Removal] to [OFF] before recording.

The sound of recorded motion pictures is not audible.

- Be sure not to block the microphone with your fingers when recording motion pictures.

The sound of the recorded motion pictures sometimes breaks up.

- This unit automatically adjusts the aperture during motion picture recording. At such times, the sound may break up. This is not a malfunction.

Motion pictures recorded on this camera cannot be played on other devices.

- Motion pictures (Motion JPEG) recorded with this camera may not be played on digital cameras of other manufacturers. Additionally, motion pictures recorded with this camera cannot be played on Panasonic LUMIX digital cameras sold before July 2008. (However, motion pictures recorded with LUMIX digital cameras sold before this date can be played on this camera.)

TV, computer, printer

No image appear on TV. Image blurred or not coloured.

- Not connected correctly. (→78)
- The television has not been switched to auxiliary input.
- Check the [Video Out] setting (NTSC/PAL) on the camera. (→38)

TV screen display different to LCD monitor.

- Aspect ratio may be incorrect or edges may be cut off with certain televisions.

Cannot play motion pictures on TV.

- Card is inserted into TV.
→ Connect the camera to the TV with the AV cable, and then access playback TV mode on the camera. (→78)

Picture is not displayed on full TV screen.

- Check [TV Aspect] settings (→38).

Cannot send pictures to computer.

- Not connected correctly (→80).
- Check whether computer has recognised camera.
- Select [PC] when connecting the camera to your computer. (→80)

Computer does not recognise card (only reads built-in memory).

- Disconnect USB connection cable and reconnect with card in place.

TV, computer, printer (Continued)**The card is not recognised by the computer.
(You are using an SDXC Memory Card.)**

- Make sure your computer supports SDXC memory cards.
<http://panasonic.net/avc/sdcard/information/SDXC.html>
- When you insert a card, a message will be displayed requesting you to format the card, but do not format it.
- If [Access] remains displayed on the LCD monitor, turn off the camera and then disconnect the USB cable.

Uploading to YouTube or Facebook cannot be performed properly.

- Confirm that the login information (login ID, user name, e-mail address and password) is correct.
- Confirm that the PC is connected to the Internet.
- Confirm that the resident software (such as anti-virus software and the firewall, etc.) is not blocking access to YouTube or Facebook.
- Check the YouTube or Facebook site.

Cannot print when connecting to printer.

- Printer is not compatible with PictBridge.
- Select [PictBridge(PTP)] when connecting the camera to your computer. (→85)

Cannot print the date.

- Make date printing settings before printing.
→ With supplied software: Select "with dates" within print settings.
- Use [Date Stamp] function when taking a picture. (→63)

Edges cut off pictures when printing.

- Release any trimming or edgeless printing settings on printer before printing.
(Consult printer operating manual.)
- The pictures were recorded in 16:9 aspect ratio.
→ If printing in shop, check if 16:9 sizes can be printed.

Others**Menu not displayed in desired language.**

- Change [Language] setting (→39).

Camera rattles if shaken.

- This sound is made by the lens movement and is not a fault.

Red lamp illuminated when pressing shutter button halfway in dark locations.

- [AF Assist Lamp] is set to [ON] (→62).

AF Assist Lamp is not illuminated.

- [AF Assist Lamp] is set to [OFF].
- Not illuminated in bright locations.

Camera is hot.

- Camera may become a little warm during use, but this does not affect performance or quality.

Lens makes a clicking noise.

- When brightness changes, the lens may make a clicking noise and the monitor brightness may also change, but this is due to aperture settings being made.
(Does not affect recording.)

Clock is incorrect.

- Camera has been left for a long period.
→ Reset the clock (→16).

When using zoom, picture becomes slightly warped and the edges of the subject become coloured.

- Pictures may be slightly warped or coloured around the edges, depending on the zoom ratio, but this is not a fault.

File numbers are not recorded in sequence.

- File numbers are reset when new folders are created (→83).

File numbers have jumped backwards.

- Battery was removed/inserted with power on.
(Numbers may jump backwards if folder/file numbers are not correctly recorded.)

When the camera is left alone, the slide show is suddenly displayed.

- This is the [Auto Demo] to introduce the features of the camera.

Usage cautions and notes

When in use

- Camera may become warm if used for long periods of time, but this is not a fault.
- **Keep this unit as far away as possible from electromagnetic equipment (such as microwave ovens, TVs, video games etc.).**
 - If you use this unit on top of or near a TV, the pictures and/or sound on this unit may be disrupted by electromagnetic wave radiation.
 - Do not use this unit near cell phones because doing so may result in noise adversely affecting the pictures and/or sound.
 - Recorded data may be damaged, or pictures may be distorted, by strong magnetic fields created by speakers or large motors.
 - Electromagnetic wave radiation generated by microprocessors may adversely affect this unit, disturbing the pictures and/or sound.
 - If this unit is adversely affected by electromagnetic equipment and stops functioning properly, turn this unit off and remove the battery or disconnect AC adaptor (for shop display purpose only). Then reinsert the battery or reconnect AC adaptor and turn this unit on.

Do not use this unit near radio transmitters or high-voltage lines.

- If you record near radio transmitters or high-voltage lines, the recorded pictures and/or sound may be adversely affected.
- Do not keep objects that may be influenced magnetically close to the speaker.
 - Magnetised objects such as bank cards, commuter passes, watches, may be adversely affected by the magnetic influence of the speaker.
- Do not extend the supplied cord or cable.
- Do not allow camera to come into contact with pesticides or volatile substances (can cause surface damage or coating to peel).
- Never leave the camera and the battery in a car or on a car hood in the summer. It may cause leakage of the battery electrolyte, a generation of heat, and may cause a fire and the battery to burst due to the high temperature.

Caring for your camera

To clean your camera, remove the battery, and wipe with a soft, dry cloth.

- Use a damp cloth to remove stubborn stains, before wiping with a dry cloth.
- Do not use benzene, thinners, alcohol, or kitchen detergent, as these may damage the outer casing and finish of the camera.
- If using a chemically-treated cloth, read the supplied instructions carefully.

When not using for a while

- Turn off camera power before removing battery and card (ensure that battery is removed to prevent damage through over-discharge).
- Do not leave in contact with rubber or plastic bags.
- Store together with a drying agent (silica gel) if leaving in drawer, etc. Store batteries in cool (15 °C - 25 °C (59 °F - 77 °F)) places with low humidity (40%RH - 60%RH) and no major temperature changes.
- Charge battery once per year and use completely before storing again.

Memory cards

- To prevent damage to cards and data
 - Avoid high temperatures, direct sunlight, electromagnetic waves, and static electricity.
 - Do not bend, drop, or expose to strong impacts.
 - Do not touch connectors on reverse of card or allow them to become dirty or wet.
- When disposing of/transferring memory cards
 - If using the "format" or "delete" functions on your camera or computer, this only changes the file management information, and does not completely delete the data from within the memory card. When disposing of or transferring your memory cards, we recommend physically destroying the memory card itself, or using commercially available computer data erasing software to completely delete the data from the card. Data within memory cards should be managed responsibly.

LCD Monitor

- Do not press hard on the LCD monitor. This may cause uneven display and damage the monitor.
- In cold climates or other situations when the camera becomes cold, the LCD monitor may be slightly less responsive than normal immediately after startup. Normal brightness will return once the internal components have warmed up.

Extremely high precision technology is employed to produce the LCD monitor screen. However there may be some dark or bright spots (red, blue or green) on the screen. This is not a malfunction. The LCD monitor screen has more than 99.99% effective pixels with a mere 0.01% of the pixels inactive or always lit. The spots will not be recorded on pictures on the built-in memory or a card.

About charging the battery

- The time required for charging varies depending on conditions of battery usage. Charging takes longer at high or low temperatures and when the battery has not been used in some time.
- Battery will be warm during charging and for some time thereafter.
- Battery will run out if not used for long periods of time, even after being charged.
- Do not leave any metal items (such as clips) near the contact areas of the power plug. Otherwise, a fire and/or electric shocks may be caused by short-circuiting or the resulting heat generated.
- Frequently charging up battery is not recommended. (Frequently charging battery reduces maximum usage time and can cause battery to expand.)
- Do not disassemble or modify the charger.
- If available battery power is significantly reduced, battery is reaching end of lifespan. Please purchase a new battery.
- When charging:
 - Remove any dirt on connectors of charger and battery with dry cloth.
 - Keep at least 1 m (3.3 feet) away from AM radio (may cause radio interference).
 - Noises may be emitted from inside of charger, but this is not a fault.
 - After charging, remove the charger from the wall socket, and then remove the battery from the charger (up to 0.1 W consumed if left in place).
- Do not use a damaged or dented battery (especially connectors), e.g. by dropping (can cause faults).

Lens

- If lens is dirty:
Images may appear slightly white if lens is dirty (fingerprints, etc.). Turn the power on, hold the extracted lens barrel with your fingers, and gently wipe the lens surface with a soft, dry cloth.
- Do not touch the lens exposed to direct sunlight.
- Do not touch the lens barrier, as this may damage lens. Be careful when removing camera from bag, etc.

When using a tripod or unipod

- Do not apply excessive force or tighten screws when they are crooked. (This may damage the camera, screw hole, or label.)
- Ensure that the tripod is stable. (Refer to the tripod instructions.)
- You may not be able to remove the card or the battery when using a tripod or unipod.

Personal Information

If birthdays are set in [Baby] Mode, keep in mind that the camera and recorded pictures will contain personal information.

- Disclaimer
 - Data containing personal information can be altered or lost due to malfunction, static electricity, accidents, breakdowns, repairs, or other operations.
Panasonic will not be liable for any damage that occurs, direct or indirect, as a result of the alteration or loss of data containing personal information.
- When ordering repairs or transferring/disposing of the camera
 - To protect your personal information, please reset the settings. (→37)
 - If any pictures are contained in the built-in memory, copy (→77) them to a memory card if necessary, and then format (→39) the built-in memory.
 - Remove the memory card from the camera.
 - When ordering repairs, the built-in memory and other settings may be returned to the initial purchase state.
 - If the above operations cannot be performed because of a camera malfunction, consult with the dealer or nearest Service Centre.

When transferring or disposing of your memory card, see “When disposing of/transferring memory cards” in the previous section.



- SDXC Logo is a trademark of SD-3C, LLC.
- QuickTime and the QuickTime logo are trademarks or registered trademarks of Apple Inc., used under license therefrom.
- Mac and Mac OS are trademarks of Apple Inc., registered in the U.S. and other countries.
- Windows and Windows Vista are either registered trademarks or trademarks of Microsoft Corporation in the United States and/or other countries.
- YouTube is a trademark of Google Inc.
- This product uses “DynaFont” from DynaComware Corporation. DynaFont is a registered trademark of DynaComware Taiwan Inc.
- Other names, company names, and product names printed in these instructions are trademarks or registered trademarks of the companies concerned.

Free Manuals Download Website

<http://myh66.com>

<http://usermanuals.us>

<http://www.somanuals.com>

<http://www.4manuals.cc>

<http://www.manual-lib.com>

<http://www.404manual.com>

<http://www.luxmanual.com>

<http://aubethermostatmanual.com>

Golf course search by state

<http://golfingnear.com>

Email search by domain

<http://emailbydomain.com>

Auto manuals search

<http://auto.somanuals.com>

TV manuals search

<http://tv.somanuals.com>